

Tanzu Application Platform v1.6 (LTS)

VMware Tanzu Application Platform 1.6

You can find the most up-to-date technical documentation on the VMware by Broadcom website at:

<https://docs.vmware.com/>

VMware by Broadcom
3401 Hillview Ave.
Palo Alto, CA 94304
www.vmware.com

Copyright © 2024 Broadcom. All Rights Reserved. The term “Broadcom” refers to Broadcom Inc. and/or its subsidiaries. For more information, go to <https://www.broadcom.com>. All trademarks, trade names, service marks, and logos referenced herein belong to their respective companies.

Contents

Tanzu Application Platform v1.6	150
Tanzu Application Platform overview	150
Simplified workflows	150
Notice of telemetry collection for Tanzu Application Platform	152
Tanzu Application Platform release notes	153
v1.6.13	153
v1.6.13 Breaking changes	153
v1.6.13 Breaking changes: Tanzu Application Platform	153
v1.6.13 Security fixes	153
v1.6.13 Known issues	164
v1.6.13 Known issues: Tanzu Application Platform	164
v1.6.13 Known issues: Artifact Metadata Repository Observer and CloudEvent Handler	164
v1.6.13 Known issues: Bitnami Services	164
v1.6.13 Known issues: Cloud Native Runtimes	164
v1.6.13 Known issues: Crossplane	164
v1.6.13 Known issues: Eventing	164
v1.6.13 Known issues: Learning Center	164
v1.6.13 Known issues: Services Toolkit	165
v1.6.13 Known issues: Supply Chain Choreographer	165
v1.6.13 Known issues: Supply Chain Security Tools - Scan	165
v1.6.13 Supply Chain Security Tools - Store	165
v1.6.13 Known issues: Tanzu Developer Portal (formerly named Tanzu Application Platform GUI)	165
v1.6.13 Known issues: Tanzu Developer Portal - Supply Chain GUI plug-in	166
v1.6.13 Known issues: Tanzu Developer Tools for IntelliJ	166
v1.6.13 Known issues: Tanzu Developer Tools for Visual Studio	166
v1.6.13 Known issues: Tanzu Developer Tools for VS Code	166
v1.6.13 Component versions	166
v1.6.12	168
v1.6.12 Security fixes	168
v1.6.12 Known issues	177
v1.6.12 Known issues: Tanzu Application Platform	177
v1.6.12 Known issues: Artifact Metadata Repository Observer and CloudEvent Handler	177
v1.6.12 Known issues: Bitnami Services	177
v1.6.12 Known issues: Cloud Native Runtimes	177
v1.6.12 Known issues: Crossplane	178

v1.6.12 Known issues: Eventing	178
v1.6.12 Known issues: Learning Center	178
v1.6.12 Known issues: Services Toolkit	178
v1.6.12 Known issues: Supply Chain Choreographer	178
v1.6.12 Known issues: Supply Chain Security Tools - Scan	178
v1.6.12 Supply Chain Security Tools - Store	178
v1.6.12 Known issues: Tanzu Developer Portal (formerly named Tanzu Application Platform GUI)	179
v1.6.12 Known issues: Tanzu Developer Portal - Supply Chain GUI plug-in	179
v1.6.12 Known issues: Tanzu Developer Tools for IntelliJ	179
v1.6.12 Known issues: Tanzu Developer Tools for Visual Studio	179
v1.6.12 Known issues: Tanzu Developer Tools for VS Code	180
v1.6.12 Component versions	180
v1.6.11	181
v1.6.11 Security fixes	181
v1.6.11 Known issues	183
v1.6.11 Known issues: Tanzu Application Platform	184
v1.6.11 Known issues: Artifact Metadata Repository Observer and CloudEvent Handler	184
v1.6.11 Known issues: Bitnami Services	184
v1.6.11 Known issues: Cloud Native Runtimes	184
v1.6.11 Known issues: Crossplane	184
v1.6.11 Known issues: Eventing	184
v1.6.11 Known issues: Learning Center	184
v1.6.11 Known issues: Services Toolkit	184
v1.6.11 Known issues: Supply Chain Choreographer	185
v1.6.11 Known issues: Supply Chain Security Tools - Scan	185
v1.6.11 Supply Chain Security Tools - Store	185
v1.6.11 Known issues: Tanzu Developer Portal (formerly named Tanzu Application Platform GUI)	185
v1.6.11 Known issues: Tanzu Developer Portal - Supply Chain GUI plug-in	185
v1.6.11 Known issues: Tanzu Developer Tools for IntelliJ	186
v1.6.11 Known issues: Tanzu Developer Tools for Visual Studio	186
v1.6.11 Known issues: Tanzu Developer Tools for VS Code	186
v1.6.11 Component versions	186
v1.6.10	188
v1.6.10 Security fixes	188
v1.6.10 Known issues	191
v1.6.10 Known issues: Tanzu Application Platform	191
v1.6.10 Known issues: Artifact Metadata Repository Observer and CloudEvent Handler	191
v1.6.10 Known issues: Bitnami Services	191
v1.6.10 Known issues: Cloud Native Runtimes	191
v1.6.10 Known issues: Crossplane	191

v1.6.10 Known issues: Eventing	191
v1.6.10 Known issues: Learning Center	191
v1.6.10 Known issues: Services Toolkit	191
v1.6.10 Known issues: Supply Chain Choreographer	192
v1.6.10 Known issues: Supply Chain Security Tools - Scan	192
v1.6.10 Supply Chain Security Tools - Store	192
v1.6.10 Known issues: Tanzu Developer Portal (formerly named Tanzu Application Platform GUI)	192
v1.6.10 Known issues: Tanzu Developer Portal - Supply Chain GUI plug-in	193
v1.6.10 Known issues: Tanzu Developer Tools for IntelliJ	193
v1.6.10 Known issues: Tanzu Developer Tools for Visual Studio	193
v1.6.10 Known issues: Tanzu Developer Tools for VS Code	193
v1.6.10 Component versions	193
v1.6.9	195
v1.6.9 Security fixes	195
v1.6.9 Resolved issues	206
v1.6.9 Resolved issues: Cloud Native Runtimes	206
v1.6.9 Known issues	206
v1.6.9 Known issues: Tanzu Application Platform	206
v1.6.9 Known issues: Artifact Metadata Repository Observer and CloudEvent Handler	206
v1.6.9 Known issues: Bitnami Services	206
v1.6.9 Known issues: Cloud Native Runtimes	206
v1.6.9 Known issues: Crossplane	206
v1.6.9 Known issues: Eventing	207
v1.6.9 Known issues: Learning Center	207
v1.6.9 Known issues: Services Toolkit	207
v1.6.9 Known issues: Supply Chain Choreographer	207
v1.6.9 Known issues: Supply Chain Security Tools - Scan	207
v1.6.9 Supply Chain Security Tools - Store	207
v1.6.9 Known issues: Tanzu Developer Portal (formerly named Tanzu Application Platform GUI)	207
v1.6.9 Known issues: Tanzu Developer Portal - Supply Chain GUI plug-in	208
v1.6.9 Known issues: Tanzu Developer Tools for IntelliJ	208
v1.6.9 Known issues: Tanzu Developer Tools for Visual Studio	208
v1.6.9 Known issues: Tanzu Developer Tools for VS Code	208
v1.6.9 Component versions	208
v1.6.8	210
v1.6.8 Security fixes	210
v1.6.8 Resolved issues	211
v1.6.8 Resolved issues: Application Single Sign-On	212
v1.6.8 Resolved issues: Contour	212
v1.6.8 Known issues	212

v1.6.8 Known issues: Tanzu Application Platform	212
v1.6.8 Known issues: Artifact Metadata Repository Observer and CloudEvent Handler	212
v1.6.8 Known issues: Bitnami Services	212
v1.6.8 Known issues: Cloud Native Runtimes	212
v1.6.8 Known issues: Crossplane	213
v1.6.8 Known issues: Eventing	213
v1.6.8 Known issues: Learning Center	213
v1.6.8 Known issues: Services Toolkit	213
v1.6.8 Known issues: Supply Chain Choreographer	213
v1.6.8 Known issues: Supply Chain Security Tools - Scan	213
v1.6.8 Supply Chain Security Tools - Store	213
v1.6.8 Known issues: Tanzu Developer Portal (formerly named Tanzu Application Platform GUI)	214
v1.6.8 Known issues: Tanzu Developer Portal - Supply Chain GUI plug-in	214
v1.6.8 Known issues: Tanzu Developer Tools for IntelliJ	214
v1.6.8 Known issues: Tanzu Developer Tools for Visual Studio	214
v1.6.8 Known issues: Tanzu Developer Tools for VS Code	215
v1.6.8 Component versions	215
v1.6.7	216
v1.6.7 Security fixes	216
v1.6.7 Known issues	219
v1.6.7 Known issues: Tanzu Application Platform	219
v1.6.7 Known issues: Artifact Metadata Repository Observer and CloudEvent Handler	219
v1.6.7 Known issues: Bitnami Services	219
v1.6.7 Known issues: Cloud Native Runtimes	219
v1.6.7 Known issues: Crossplane	220
v1.6.7 Known issues: Eventing	220
v1.6.7 Known issues: Learning Center	220
v1.6.7 Known issues: Services Toolkit	220
v1.6.7 Known issues: Supply Chain Choreographer	220
v1.6.7 Known issues: Supply Chain Security Tools - Scan	220
v1.6.7 Supply Chain Security Tools - Store	220
v1.6.7 Known issues: Tanzu Developer Portal (formerly named Tanzu Application Platform GUI)	220
v1.6.7 Known issues: Tanzu Developer Portal - Supply Chain GUI plug-in	221
v1.6.7 Known issues: Tanzu Developer Tools for IntelliJ	221
v1.6.7 Known issues: Tanzu Developer Tools for Visual Studio	221
v1.6.7 Known issues: Tanzu Developer Tools for VS Code	221
v1.6.7 Component versions	222
v1.6.6	223
v1.6.6 Security fixes	223
v1.6.6 Resolved issues	228

v1.6.6 Resolved issues: cert-manager	228
v1.6.6 Known issues	228
v1.6.6 Known issues: Tanzu Application Platform	228
v1.6.6 Known issues: Artifact Metadata Repository Observer and CloudEvent Handler	229
v1.6.6 Known issues: Bitnami Services	229
v1.6.6 Known issues: Cloud Native Runtimes	229
v1.6.6 Known issues: Crossplane	229
v1.6.6 Known issues: Eventing	229
v1.6.6 Known issues: Learning Center	229
v1.6.6 Known issues: Services Toolkit	229
v1.6.6 Known issues: Supply Chain Choreographer	230
v1.6.6 Supply Chain Security Tools - Store	230
v1.6.6 Known issues: Tanzu Developer Portal (formerly named Tanzu Application Platform GUI)	230
v1.6.6 Known issues: Tanzu Developer Portal - Supply Chain GUI plug-in	230
v1.6.6 Known issues: Tanzu Developer Tools for IntelliJ	231
v1.6.6 Known issues: Tanzu Developer Tools for Visual Studio	231
v1.6.6 Known issues: Tanzu Developer Tools for VS Code	231
v1.6.6 Component versions	231
v1.6.5	233
v1.6.5 Security fixes	233
v1.6.5 Resolved issues	235
v1.6.5 Resolved issues: Local Source Proxy	235
v1.6.5 Known issues	235
v1.6.5 Known issues: Tanzu Application Platform	235
v1.6.5 Known issues: Artifact Metadata Repository Observer and CloudEvent Handler	235
v1.6.5 Known issues: Bitnami Services	235
v1.6.5 Known issues: cert-manager	235
v1.6.5 Known issues: Cloud Native Runtimes	235
v1.6.5 Known issues: Crossplane	236
v1.6.5 Known issues: Eventing	236
v1.6.5 Known issues: Learning Center	236
v1.6.5 Known issues: Services Toolkit	236
v1.6.5 Known issues: Supply Chain Choreographer	236
v1.6.5 Supply Chain Security Tools - Store	236
v1.6.5 Known issues: Tanzu Developer Portal (formerly named Tanzu Application Platform GUI)	236
v1.6.5 Known issues: Tanzu Developer Portal - Supply Chain GUI plug-in	237
v1.6.5 Known issues: Tanzu Developer Tools for IntelliJ	237
v1.6.5 Known issues: Tanzu Developer Tools for Visual Studio	237
v1.6.5 Known issues: Tanzu Developer Tools for VS Code	237
v1.6.5 Component versions	238

v1.6.4	239
v1.6.4 Breaking changes	239
v1.6.4 Breaking changes: Services Toolkit	239
v1.6.4 Security fixes	239
v1.6.4 Resolved issues	242
v1.6.4 Resolved issues: Application Configuration Service	243
v1.6.4 Known issues	243
v1.6.4 Known issues: Tanzu Application Platform	243
v1.6.4 Known issues: Artifact Metadata Repository Observer and CloudEvent Handler	243
v1.6.4 Known issues: Bitnami Services	243
v1.6.4 Known issues: Cloud Native Runtimes	243
v1.6.4 Known issues: Crossplane	243
v1.6.4 Known issues: Eventing	244
v1.6.4 Known issues: Learning Center	244
v1.6.4 Known issues: Services Toolkit	244
v1.6.4 Known issues: Supply Chain Choreographer	244
v1.6.4 Supply Chain Security Tools - Store	244
v1.6.4 Known issues: Tanzu Developer Portal (formerly named Tanzu Application Platform GUI)	244
v1.6.4 Known issues: Tanzu Developer Portal - Supply Chain GUI plug-in	245
v1.6.4 Known issues: Tanzu Developer Tools for IntelliJ	245
v1.6.4 Known issues: Tanzu Developer Tools for Visual Studio	245
v1.6.4 Known issues: Tanzu Developer Tools for VS Code	245
v1.6.4 Component versions	245
v1.6.3	247
v1.6.3 Security fixes	247
v1.6.3 Resolved issues	251
v1.6.3 Resolved issues: Application Configuration Service	252
v1.6.3 Resolved issues: Tanzu CLI and plugins	252
v1.6.3 Known issues	252
v1.6.3 Known issues: Tanzu Application Platform	252
v1.6.3 Known issues: Application Configuration Service	252
v1.6.3 Known issues: Artifact Metadata Repository Observer and CloudEvent Handler	252
v1.6.3 Known issues: Bitnami Services	252
v1.6.3 Known issues: Cloud Native Runtimes	252
v1.6.3 Known issues: Crossplane	253
v1.6.3 Known issues: Eventing	253
v1.6.3 Known issues: Learning Center	253
v1.6.3 Known issues: Services Toolkit	253
v1.6.3 Known issues: Supply Chain Choreographer	253
v1.6.3 Supply Chain Security Tools - Store	253

v1.6.3 Known issues: Tanzu Developer Portal (formerly named Tanzu Application Platform GUI)	253
v1.6.3 Known issues: Tanzu Developer Portal - Supply Chain GUI plug-in	254
v1.6.3 Known issues: Tanzu Developer Tools for IntelliJ	254
v1.6.3 Known issues: Tanzu Developer Tools for Visual Studio	254
v1.6.3 Known issues: Tanzu Developer Tools for VS Code	254
v1.6.3 Component versions	254
v1.6.2	256
v1.6.2 Security fixes	256
v1.6.2 Resolved issues	258
v1.6.2 Resolved issues: Supply Chain Choreographer	258
v1.6.2 Resolved issues: Tanzu Developer Portal - Supply Chain GUI plug-in	258
v1.6.2 Resolved issues: Tanzu Developer Tools for VS Code	258
v1.6.2 Known issues	259
v1.6.2 Known issues: Application Configuration Service	259
v1.6.2 Known issues: Artifact Metadata Repository Observer and CloudEvent Handler	259
v1.6.2 Known issues: Bitnami Services	259
v1.6.2 Known issues: Cloud Native Runtimes	259
v1.6.2 Known issues: Crossplane	259
v1.6.2 Known issues: Eventing	259
v1.6.2 Known issues: Learning Center	259
v1.6.2 Known issues: Services Toolkit	260
v1.6.2 Known issues: Supply Chain Choreographer	260
v1.6.2 Supply Chain Security Tools - Store	260
v1.6.2 Known issues: Tanzu Developer Portal (formerly named Tanzu Application Platform GUI)	260
v1.6.2 Known issues: Tanzu Developer Portal - Supply Chain GUI plug-in	260
v1.6.2 Known issues: Tanzu Developer Tools for IntelliJ	261
v1.6.2 Known issues: Tanzu Developer Tools for Visual Studio	261
v1.6.2 Known issues: Tanzu Developer Tools for VS Code	261
v1.6.2 Component versions	261
v1.6.1	263
What's new in Tanzu Application Platform v1.6	263
New platform-wide features	263
New components	263
v1.6.1 New features by component and area	263
v1.6.1 Features: Application Accelerator	263
v1.6.1 Features: Application Live View	263
v1.6.1 Features: Application Single Sign-On (AppSSO)	264
v1.6.1 Features: Bitnami Services	264
v1.6.1 Features: Cloud Native Runtimes	264
v1.6.1 Features: Contour	264

v1.6.1 Features: Crossplane	264
v1.6.1 Features: Flux CD Source Controller	265
v1.6.1 Features: Namespace Provisioner	266
v1.6.1 Features: Services Toolkit	266
v1.6.1 Features: Supply Chain Choreographer	267
v1.6.1 Features: Supply Chain Security Tools (SCST) - Scan	267
v1.6.1 Features: Supply Chain Security Tools (SCST) - Store	267
v1.6.1 Features: Tanzu CLI	269
v1.6.1 Features: Tanzu CLI plug-in distribution change	269
v1.6.1 Features: Tanzu CLI Apps plug-in	269
v1.6.1 Features: Tanzu CLI Build Service plug-in	270
v1.6.1 Features: Tanzu CLI Insight plug-in	270
v1.6.1 Features: Tanzu Developer Portal (formerly named Tanzu Application Platform GUI)	270
v1.6.1 Features: Tanzu Developer Tools for IntelliJ	270
v1.6.1 Features: Tanzu Developer Tools for VS Code	270
v1.6.1 Features: Tanzu Developer Tools for Visual Studio	271
v1.6.1 Breaking changes	271
v1.6.1 Breaking changes: Application Single Sign-On (AppSSO)	271
v1.6.1 Breaking changes: Cloud Native Runtimes	271
v1.6.1 Breaking changes: Contour	271
v1.6.1 Breaking changes: Flux CD Source Controller	271
v1.6.1 Breaking changes: Tanzu Build Service	272
v1.6.1 Breaking changes: Tanzu CLI Apps plug-in	272
v1.6.1 Breaking changes: Tanzu Developer Portal (formerly named Tanzu Application Platform GUI)	272
v1.6.1 Security fixes	272
v1.6.1 Resolved issues	293
v1.6.1 Resolved issues: Cloud Native Runtimes	293
v1.6.1 Resolved issues: Crossplane	293
v1.6.1 Resolved issues: Namespace Provisioner	294
v1.6.1 Resolved issues: Services Toolkit	294
v1.6.1 Resolved issues: Supply Chain Security Tools (SCST) - Store	294
v1.6.1 Resolved issues: Tanzu CLI Apps plug-in	294
v1.6.1 Resolved issues: Tanzu Developer Tools for IntelliJ	294
v1.6.1 Resolved issues: Tanzu Developer Tools for VS Code	295
v1.6.1 Known issues	295
v1.6.1 Known issues: Application Configuration Service	295
v1.6.1 Known issues: Artifact Metadata Repository Observer and CloudEvent Handler	295
v1.6.1 Known issues: Bitnami Services	295
v1.6.1 Known issues: Cloud Native Runtimes	295
v1.6.1 Known issues: Crossplane	295

v1.6.1 Known issues: Eventing	296
v1.6.1 Known issues: Learning Center	296
v1.6.1 Known issues: Services Toolkit	296
v1.6.1 Known issues: Supply Chain Choreographer	296
v1.6.1 Supply Chain Security Tools - Store	296
v1.6.1 Known issues: Tanzu Developer Portal (formerly named Tanzu Application Platform GUI)	296
v1.6.1 Known issues: Tanzu Developer Portal - Supply Chain GUI plug-in	297
v1.6.1 Known issues: Tanzu Developer Tools for IntelliJ	297
v1.6.1 Known issues: Tanzu Developer Tools for Visual Studio	297
v1.6.1 Known issues: Tanzu Developer Tools for VS Code	297
v1.6.1 Component versions	298
Deprecations	299
Tanzu Application Platform deprecations	299
Application Live View deprecations	299
Application Single Sign-On (AppSSO) deprecations	300
Eventing deprecations	300
Flux CD Source Controller deprecations	300
Learning Center deprecations	300
Services Toolkit deprecations	300
Source Controller deprecations	300
Supply Chain Choreographer deprecations	300
Supply Chain Security Tools (SCST) - Scan deprecations	301
Tanzu Build Service deprecations	301
Tanzu CLI Apps plug-in deprecations	301
Tekton Pipelines deprecations	301
Linux Kernel CVEs	301
Components and installation profiles for Tanzu Application Platform	303
Tanzu Application Platform components	303
Installation profiles in Tanzu Application Platform v1.6	308
Packages: A to C	308
Packages: D to R	309
Packages: S to Z	309
Language and framework support in Tanzu Application Platform	310
Installing Tanzu Application Platform	311
Install Tanzu Application Platform	312
Install Tanzu Application Platform	312
Prerequisites for installing Tanzu Application Platform	312
Broadcom Support Portal and container image registry requirements	313

DNS Records	313
Tanzu Developer Portal	314
Kubernetes cluster requirements	314
Resource requirements	315
Tools and CLI requirements	316
Next steps	316
Kubernetes version support for Tanzu Application Platform	316
Install the Tanzu CLI	317
Set the Kubernetes cluster context	317
Install or update the Tanzu CLI and plug-ins	318
Install the Tanzu CLI	318
Install Tanzu CLI Plug-ins	320
List the versions of each plug-in group available across Tanzu	320
List the versions of the Tanzu Application Platform specific plug-in group	321
Install the version of the Tanzu Application Platform specific plug-in group matching your target environment	321
Verify the plug-in group list against the plug-ins that were installed	321
Next steps	321
Install Tanzu Application Platform (online)	322
Install Tanzu Application Platform (online)	322
Install Tanzu Application Platform package and profiles	323
Relocate images to a registry	323
Add the Tanzu Application Platform package repository	324
Install your Tanzu Application Platform profile	328
Full profile	328
CEIP policy disclosure	332
(Optional) Configure your profile with full dependencies	332
(Optional) Override the default retention behavior for Crossplane CRDs	332
Install your Tanzu Application Platform package	333
Install the full dependencies package	333
Access Tanzu Developer Portal	334
Exclude packages from a Tanzu Application Platform profile	334
Next steps	335
View possible configuration settings for your package	335
Install individual packages	337
Install pages for individual Tanzu Application Platform packages	337
Verify the installed packages	338

Next steps	339
Set up developer namespaces to use your installed packages	339
Additional configuration for testing and scanning	339
Legacy namespace setup	339
Next steps	339
Provision namespaces manually	339
Enable single user access	340
Enable additional users with Kubernetes RBAC	341
Additional configuration for testing and scanning	343
Install Tanzu Developer Tools for your VS Code	343
Prerequisites	344
Install	344
Configure	345
Uninstall	345
Next steps	345
Install Tanzu Application Platform (offline)	345
Install Tanzu Application Platform (offline)	346
Install Tanzu Application Platform in your air-gapped environment	347
Relocate images to a registry	347
Add the Tanzu Application Platform package repository	348
Prepare Sigstore Stack for air-gapped policy controller	351
Install your Tanzu Application Platform profile	351
Full Profile	352
Install your Tanzu Application Platform package	356
Next steps	357
Install the Tanzu Build Service dependencies	357
Next steps	358
Configure custom certificate authorities for Tanzu Developer Portal	358
Next steps	359
Configure Application Accelerator	359
Using a Git-Ops style configuration for deploying a set of managed accelerators	359
Functional and Organizational Considerations	360
Examples for creating accelerators	360
A minimal example for creating an accelerator	360
An example for creating an accelerator with customized properties	361
Creating a manifest with multiple accelerators and fragments	362

Configure tap-values.yaml with Git credentials secret	362
Using non-public repositories	363
Examples for a private Git repository	364
Example using http credentials	364
Example using http credentials with self-signed certificate	365
Example using SSH credentials	366
Examples for a private source-image repository	367
Example using image-pull credentials	367
Configure ingress timeouts when some accelerators take longer to generate	368
Configure an ingress timeout overlay secret for each HTTPProxy	368
Apply the timeout overlay secrets in tap-values.yaml	369
Configuring skipping TLS verification for access to Source Controller	369
Enabling TLS for Accelerator Server	369
Configuring skipping TLS verification of Engine calls for Accelerator Server	370
Enabling TLS for Accelerator Engine	370
Next steps	370
Use Grype in offline and air-gapped environments	371
Host the Grype vulnerability database	371
To enable Grype in offline air-gapped environments	372
Configure Grype environmental variables	372
Troubleshooting	373
ERROR failed to fetch latest cli version	373
Solution	373
Database is too old	374
Solution	374
Vulnerability database is invalid	375
Solution	375
Debug Grype database in a cluster	376
Grype package overlays are not applied to scantemplates created by Namespace Provisioner	378
Set up developer namespaces to use your installed packages	378
Additional configuration for testing and scanning	378
Legacy namespace setup	378
Next steps	378
Install IDE extensions in your air-gapped environment	378
Install VS Code in your air-gapped environment	378
Install IntelliJ in your air-gapped environment	379
Install Tanzu Application Platform (AWS)	379
Install Tanzu Application Platform (AWS)	380

Create AWS Resources for Tanzu Application Platform	380
Prerequisites	381
Export environment variables	381
Create an EKS cluster	382
Install the EBS CSI driver	382
Create the platform container repositories	382
Create the workload container repositories	382
Create IAM roles	383
Next steps	388
Install Tanzu Application Platform package and profiles on AWS	388
Relocate images to a registry	389
Add the Tanzu Application Platform package repository	390
Install your Tanzu Application Platform profile	392
Full profile (AWS)	392
(Optional) Additional Build Service configurations	395
(Optional) Configure your profile with full dependencies	395
Install your Tanzu Application Platform package	395
Install the full dependencies package	396
Access Tanzu Developer Portal	397
Exclude packages from a Tanzu Application Platform profile	397
Next steps	398
View possible configuration settings for your package	398
Install individual packages	400
Install pages for individual Tanzu Application Platform packages	400
Verify the installed packages	401
Next steps	402
Set up developer namespaces to use your installed packages	402
Enable single user access	402
Enable additional users access with Kubernetes RBAC	403
Next steps	405
Install Tanzu Developer Tools for your VS Code	405
Prerequisites	405
Install	406
Configure	406
Uninstall	407
Next steps	407
Install Tanzu Application Platform (Azure)	407

Install Tanzu Application Platform (Azure)	407
Create Azure Resources for Tanzu Application Platform	408
Prerequisites	408
Create Azure Resource Group	408
Create an AKS cluster	409
Connect to the AKS cluster	409
Create the container repositories	409
Enable registry admin account	410
Next steps	410
Install Tanzu Application Platform package and profiles on Azure	410
Relocate images to a registry	411
Add the Tanzu Application Platform package repository	412
Install your Tanzu Application Platform profile	415
Full profile (Azure)	416
(Optional) Configure your profile with full dependencies	417
Install your Tanzu Application Platform package	418
Install the full dependencies package	418
Access Tanzu Developer Portal	419
Next steps	419
View possible configuration settings for your package	419
Install individual packages	421
Install pages for individual Tanzu Application Platform packages	422
Verify the installed packages	422
Next steps	423
Set up developer namespaces to use your installed packages	423
Additional configuration for testing and scanning	424
Legacy namespace setup	424
Enable single user access	424
Enable additional users access with Kubernetes RBAC	425
Next steps	427
Install Tanzu Developer Tools for your VS Code	427
Prerequisites	427
Install	428
Configure	428
Uninstall	429
Next steps	429
Install Tanzu Application Platform (OpenShift)	429

Install Tanzu Application Platform (OpenShift)	429
Install Tanzu Application Platform on your OpenShift clusters	430
Relocate images to a registry	430
Add the Tanzu Application Platform package repository	431
Install your Tanzu Application Platform profile	435
Full profile	435
(Optional) Additional Build Service configurations	438
(Optional) Configure your profile with full dependencies	438
(Optional) Configure your profile with the Jammy stack only	439
Security Context Constraints	439
(Optional) Exclude components that require RedHat OpenShift privileged SCC	439
Install your Tanzu Application Platform package	439
Install the full dependencies package	440
Access Tanzu Developer Portal	441
Exclude packages from a Tanzu Application Platform profile	441
View possible configuration settings for your package	441
Install individual packages	443
Install pages for individual Tanzu Application Platform packages	444
Verify the installed packages	444
Next steps	445
Set up developer namespaces to use your installed packages	445
Additional configuration for testing and scanning	446
Legacy namespace setup	446
Next steps	446
Install Tanzu Developer Tools for your VS Code	446
Prerequisites	446
Install	446
Configure	447
Uninstall	447
Next steps	447
Custom Security Context Constraint details for Tanzu Application Platform	448
Application Accelerator on OpenShift	448
Application Live View on OpenShift	449
Application Single Sign-On for OpenShift cluster	449
Contour for OpenShift cluster	450
Developer Conventions for OpenShift cluster	452
Tanzu Build Service for OpenShift cluster	452

Install Tanzu Application Platform (GitOps)	454
How Tanzu RI supports GitOps	455
GitOps benefits	455
GitOps install paths	455
GitOps with Secrets OPerationS (SOPS)	455
GitOps with External Secrets Operator (ESO)	456
Install Tanzu Application Platform (GitOps)	457
How Tanzu RI supports GitOps	457
GitOps benefits	457
GitOps install paths	458
GitOps with Secrets OPerationS (SOPS)	458
GitOps with External Secrets Operator (ESO)	458
Install Tanzu Application Platform through GitOps with External Secrets Operator (ESO)	459
Install Tanzu Application Platform through GitOps with AWS Secrets Manager	460
Prerequisites	460
Relocate images to a registry	460
(Optional) Install Tanzu Application Platform in an air-gapped environment	462
Create a new Git repository	462
Download and unpack Tanzu GitOps Reference Implementation (RI)	463
Create your cluster configuration	463
Customize your cluster configuration	463
Grant read access to secret data	464
Generate the default configuration	465
Review and store Tanzu Sync config	465
Review and store the Tanzu Application Platform installation config	468
Configure and push the Tanzu Application Platform values	470
Deploy Tanzu Sync	471
Install Tanzu Application Platform through GitOps with HashiCorp Vault	472
Prerequisites	473
Relocate images to a registry	473
(Optional) Install Tanzu Application Platform in an air-gapped environment	474
Create a new Git repository	475
Download and unpack Tanzu GitOps Reference Implementation (RI)	475
Create cluster configuration	476
Customize cluster configuration	476
Connect Vault to a Kubernetes cluster	477
Grant read access to secret data	477
Generate default configuration	478

Review and store Tanzu Sync config	478
Review and store the Tanzu Application Platform installation config	482
Configure and push the Tanzu Application Platform values	483
Deploy Tanzu Sync	484
Install Tanzu Application Platform through Gitops with Secrets OPERationS (SOPS)	486
Prerequisites	486
Relocate images to a registry	486
(Optional) Install Tanzu Application Platform in an air-gapped environment	488
Create a new Git repository	488
Download and unpack Tanzu GitOps Reference Implementation (RI)	489
Create cluster configuration	489
Configure Tanzu Application Platform	489
Prepare the sensitive Tanzu Application Platform values	490
Prepare the non-sensitive Tanzu Application Platform values	491
Update the sensitive Tanzu Application Platform values	491
Prepare the sensitive Tanzu Sync values	492
Update the sensitive Tanzu Sync values	493
Generate Tanzu Application Platform installation and Tanzu Sync configuration	494
Deploy Tanzu Sync	495
Install individual packages	496
Install packages for individual Tanzu Application Platform packages	496
Verify the installed packages	497
Next steps	498
Set up developer namespaces to use your installed packages	498
Additional configuration for testing and scanning	498
Legacy namespace setup	498
Next steps	498
Install Tanzu Developer Tools for your VS Code	498
Prerequisites	498
Install	498
Configure	499
Uninstall	500
Next steps	500
Tanzu GitOps RI Reference Documentation	500
Tanzu Sync Carvel Application	501
Choosing Secrets OPERationS (SOPS) or External Secrets Operator (ESO)	501
Git Repository structure	501
Configuration of Tanzu Sync without helper scripts	502

Tanzu Sync Scripts	504
Customize your package installation	504
Customize a package that was manually installed	504
Customize a package that was installed by using a profile	505
Opt out of telemetry collection	505
Turn off standard CEIP telemetry collection	506
Turn off Pendo telemetry collection	507
Opt in or opt out of Pendo telemetry for Tanzu Developer Portal	507
Opt in or opt out of Pendo telemetry from Tanzu Developer Portal	508
Request to delete your anonymized data	508
Upgrade compatibility and recommendations for Tanzu Application Platform	509
Supported upgrade paths	509
Compatibility	509
Kubernetes compatibility	509
Tanzu CLI compatibility	509
Recommendations	509
Recommendations for apps	510
Upgrade preparation checklist	510
View cluster checklists	512
Pre-upgrade cluster health check - View cluster	512
Upgrade considerations for Kubernetes - View Cluster	512
Upgrade considerations for Tanzu Application Platform - View Cluster	515
Post upgrade checks - View cluster	515
Build cluster checklists	516
Pre-upgrade cluster health check - Build cluster	516
Upgrade considerations for Kubernetes - Build Cluster	517
Upgrade considerations for Tanzu Application Platform - Build Cluster	517
Post upgrade checks - Build cluster	521
Run cluster checklists	521
Pre-upgrade cluster health check - Run cluster	521
Upgrade considerations for Kubernetes - Run Cluster	522
Upgrade considerations for Tanzu Application Platform - Run Cluster	525
Post upgrade checks - Run cluster	527
Upgrade compatibility and recommendations for Tanzu Application Platform	528
Supported upgrade paths	528
Compatibility	528
Kubernetes compatibility	528

Tanzu CLI compatibility	528
Recommendations	529
Recommendations for apps	529
Upgrade preparation checklist	530
View cluster checklists	531
Pre-upgrade cluster health check - View cluster	531
Upgrade considerations for Kubernetes - View Cluster	532
Upgrade considerations for Tanzu Application Platform - View Cluster	534
Post upgrade checks - View cluster	534
Build cluster checklists	535
Pre-upgrade cluster health check - Build cluster	535
Upgrade considerations for Kubernetes - Build Cluster	536
Upgrade considerations for Tanzu Application Platform - Build Cluster	536
Post upgrade checks - Build cluster	540
Run cluster checklists	540
Pre-upgrade cluster health check - Run cluster	540
Upgrade considerations for Kubernetes - Run Cluster	541
Upgrade considerations for Tanzu Application Platform - Run Cluster	544
Post upgrade checks - Run cluster	546
Upgrade Tanzu Application Platform	547
Prerequisites	547
Update the package repository	547
Perform the upgrade of Tanzu Application Platform	548
Upgrade instructions for Profile-based installation	548
Upgrade the full dependencies package	549
Multicluster upgrade order	549
Upgrade instructions for component-specific installation	550
Verify the upgrade	550
Upgrade Tanzu Application Platform by using GitOps	551
Prerequisites	551
Relocate Tanzu Application Platform images to a registry	552
Upgrade to a patch version	553
Upgrade the existing SOPs based installation	553
Upgrade the existing ESO based installation	554
Verify the upgrade	554
Migrate Tanzu Application Platform images from VMware Tanzu Network	556
Who must follow these steps	556
Migrate Tanzu Application Platform images	556
Update the package repository	556

Restart the kapp controller	557
Scale workloads	558
Sample application reference	558
Small	558
Medium	558
Large	558
Application Configuration	558
Scale configuration for workload deployments	559
Best Practices	559
Example resource limit changes	560
Cartographer	560
Cartographer Conventions	561
Scan-link-controller	561
kpack-controller in build service	562
Namespace Provisioner	562
Cloud Native Runtimes Knative Serving	563
net-contour controller	563
Autoscaler	564
Activator	565
Triggermesh	565
Tanzu Application Platform Telemetry	566
kube-dns resource limit changes for GKE clusters	566
Overview of security and compliance in Tanzu Application Platform	567
Overview of TLS and certificates in Tanzu Application Platform	567
Secure Ingress certificates in Tanzu Application Platform	567
A shared ingress issuer	567
Component-level configuration	568
Shared Ingress issuer in Tanzu Application Platform	568
Prerequisites	568
Default	569
Limitations of the default, self-signed issuer	569
Trusting the default, self-signed issuer	569
Replacing the default ingress issuer	569
Deactivating TLS for ingress	573
Overriding TLS for components	573
Use wildcard certificates in Tanzu Application Platform	573
Plan Ingress certificates inventory in Tanzu Application Platform	573

Use custom CA certificates in Tanzu Application Platform	574
Use External Secrets Operator in Tanzu Application Platform (beta)	575
Where to start	575
Install External Secrets Operator in Tanzu Application Platform	576
Prerequisites	576
Install	576
Integrate External Secrets Operator with HashiCorp Vault in Tanzu Application Platform	577
Prerequisites	577
Set up the integration	578
Assess Tanzu Application Platform against the NIST 800-53 Moderate Assessment	580
Harden Tanzu Application Platform	586
Objective	586
Scope	587
Identity and Access Management	587
Tanzu Developer Portal	587
Tanzu Developer Portal to Remote Kubernetes Cluster Authentication	588
Kubernetes Cluster Authentication and Authorization	588
Cryptographic Protections	588
Encryption of Data in Transit	588
Internal Communication of Data in Transit Configuration	588
External Communication of Data in Transit Configuration	589
Configuring TLS for Contour	589
Ingress Certificates	589
Encryption of Data At Rest	590
Ports and Protocols	590
Networking	590
Key Management	590
Logging	590
Deployment Architecture	591
Overview of multicluster Tanzu Application Platform	592
Next steps	592
Overview of multicluster Tanzu Application Platform	593
Next steps	593
Install multicluster Tanzu Application Platform profiles	593
Prerequisites	593

Multicluster Installation Order of Operations	594
Install View cluster	594
Install Build clusters	594
Install Run clusters	594
Install Iterate clusters	595
Add Build, Run and Iterate clusters to Tanzu Developer Portal	595
Next steps	595
Get started with multicluster Tanzu Application Platform	595
Prerequisites	595
Start the workload on the Build profile cluster	596
Install Tanzu Application Platform Build profile	598
Prerequisites	598
Example values.yaml	598
Install Tanzu Application Platform Run profile	600
Install Tanzu Application Platform View profile	601
Install Tanzu Application Platform Iterate profile	602
Get started with Tanzu Application Platform	605
Prerequisites	605
Next steps	605
Get started with Tanzu Application Platform	606
Prerequisites	606
Next steps	606
Add testing and scanning to your application	607
What you will do	607
Overview	607
Install OOTB Supply Chain with Testing	607
Tekton pipeline config example	608
Workload update	609
Install OOTB Supply Chain with Testing and Scanning	609
Workload update	611
Query for vulnerabilities	613
Next steps	613
Add testing and scanning to your application	613
What you will do	613
Overview	614
Install OOTB Supply Chain with Testing	614

Tekton pipeline config example	614
Workload update	615
Install OOTB Supply Chain with Testing and Scanning	616
Workload update	618
Query for vulnerabilities	619
Next steps	620
Configure image signing and verification in your supply chain	620
What you will do	620
Configure your supply chain to sign and verify your image builds	620
Next steps	622
Integrate a plug-in into your Tanzu Developer Portal	622
What you will do	622
Prerequisites	622
Customize your Tanzu Developer Portal by adding the hello-world plug-in	622
Next steps	626
Generate an application with Application Accelerator	626
Prerequisites	627
Generate a project using an Application Accelerator	627
Learn more about Application Accelerator	633
Next Steps	633
Generate an application with Application Accelerator	633
Prerequisites	633
Generate a project using an Application Accelerator	633
Learn more about Application Accelerator	639
Next Steps	640
Deploy an app on Tanzu Application Platform	640
What you will do	640
Prerequisites	640
Deploy your application using the Tanzu CLI	640
Prerequisites	640
Procedure	641
Add your application to Tanzu Developer Portal software catalog	643
Next steps	644
Iterate on your new app using Tanzu Developer Tools for IntelliJ	645
What you will do	645
Prepare to iterate on your application	645
Prepare your project to support Live Update	645
Maven Spring Boot project requirements	645

Gradle Spring Boot project requirements	646
Set up the IDE	646
Apply your application to the cluster	647
Enable Live Update for your application	648
Debug your application	649
Delete your application from the cluster	651
Next steps	652
Iterate on your new app using Tanzu Developer Tools for Visual Studio	652
What you will do	652
Prepare to iterate on your application	652
Prepare your project to support Live Update	652
Set up the IDE	653
Apply your application to the cluster	653
Enable Live Update for your application	654
Debug your application	655
Delete your application from the cluster	655
Next steps	655
Iterate on your new app using Tanzu Developer Tools for VS Code	655
What you will do	655
Prepare to iterate on your application	655
Prepare your project to support Live Update	656
Maven Spring Boot project requirements	656
Gradle Spring Boot project requirements	657
Set up the IDE	657
Apply your application to the cluster	658
Enable Live Update for your application	658
Debug your application	659
Monitor your running application	660
Delete your application from the cluster	661
Next steps	661
Claim services on Tanzu Application Platform	661
What you will do	661
Overview	661
Prerequisites	662
Discover available services	662
Create a claim for a service instance	663
Learn more	664
Next steps	664
Consume services on Tanzu Application Platform	664

What you will do	665
Overview	665
Prerequisites	665
Discovering existing claims	666
Binding application workloads to the service instance	666
Learn more	667
Next steps	667
Deploy an air-gapped workload on Tanzu Application Platform	667
What you will do	667
Prerequisites	667
Create a workload from Git	668
Create a basic supply chain workload	669
Create a testing supply chain workload	669
Create a testing scanning supply chain workload	670
Deploy Spring Cloud applications to Tanzu Application Platform	670
Deploy Spring Cloud applications to Tanzu Application Platform	670
Deploy Spring Cloud Config applications to Tanzu Application Platform	670
Identify Spring Cloud Config applications	670
Prerequisites	671
Configure workloads	671
Deploy Spring Cloud DiscoveryClient applications to Tanzu Application Platform	671
Identify Spring Cloud DiscoveryClient applications	671
Prerequisites	672
Example: The Greeting application	672
Create a properties file in your configuration repository	672
Create Application Configuration Service resources	673
Create application workload resources	673
Using Spring Cloud Gateway for Kubernetes with Tanzu Application Platform	675
Create a new application accelerator	675
What you will do	675
Set up Visual Studio Code	675
Create a simple project	676
Set up the project directory	676
Prepare the README.md and accelerator.yaml	676
Test the accelerator	678
Upload the project to a Git repository	678

Register the accelerator to the Tanzu Application Platform and verify project generation output	679
Verify project generation output by using Tanzu Developer Portal	679
Learn more about Application Accelerator	681
Learn about Tanzu Application Platform	682
Application accelerators on Tanzu Application Platform	682
What are application accelerators	682
Working with accelerators	682
Next steps	683
Supply chains on Tanzu Application Platform	683
What are supply chains	683
A path to production	683
Available supply chains	683
1: OOTB Basic (default)	683
2: OOTB Testing	684
3: OOTB Testing+Scanning	684
Next steps	685
Vulnerability scanning, storing, and viewing for your supply chain	685
Features	685
Components	686
Next steps	686
Troubleshooting	686
About consuming services on Tanzu Application Platform	686
Key concepts	686
Service instances	687
Service bindings	687
Resource claims	687
Services you can use with Tanzu Application Platform	687
User roles and responsibilities	687
Next steps	688
Set up Tanzu Service Mesh	689
Prerequisites	689
Activate your Tanzu Service Mesh subscription	689
Set up Tanzu Application Platform	690
End-to-end workload build and deployment scenario	690
Apply a workload resource to a build cluster	690
Configure egress for Tanzu Build Service	691
Create a global namespace	691

Run cluster deployment	691
Deployment use case: Where For Dinner	692
Create an initial set of configuration files from the accelerator	692
Apply the workload resources to your build cluster	693
Install service claim resources on the cluster	693
Run cluster deployment	694
Create a global namespace	695
Deployment use case: ACME Fitness Store	696
Deploy AppSSO	696
Apply the workload resources to your build cluster	697
Create the Istio ingress resources	697
Deploy Redis	698
Run cluster deployment	698
Deploy Spring Cloud Gateway	699
Install the Spring Cloud Gateway package	699
Configure the Spring Cloud Gateway instance and route	699
Create a global namespace	700
Set up Tanzu Service Mesh	700
Prerequisites	701
Activate your Tanzu Service Mesh subscription	701
Set up Tanzu Application Platform	701
End-to-end workload build and deployment scenario	701
Apply a workload resource to a build cluster	702
Configure egress for Tanzu Build Service	703
Create a global namespace	703
Run cluster deployment	703
Deployment use case: Where For Dinner	704
Create an initial set of configuration files from the accelerator	704
Apply the workload resources to your build cluster	704
Install service claim resources on the cluster	705
Run cluster deployment	705
Create a global namespace	707
Deployment use case: ACME Fitness Store	707
Deploy AppSSO	707
Apply the workload resources to your build cluster	708
Create the Istio ingress resources	709
Deploy Redis	709
Run cluster deployment	710
Deploy Spring Cloud Gateway	710
Install the Spring Cloud Gateway package	710
Configure the Spring Cloud Gateway instance and route	711

Create a global namespace	711
Overview of workloads	713
Workload features	713
Available workload types	713
Overview of workloads	714
Workload features	714
Available workload types	714
Use web workloads	715
Overview	715
Use the web workload type	716
Use server workloads	716
Overview	716
Use the server workload type	717
server-specific workload parameters	717
Expose server workloads outside the cluster	718
Use server workloads	718
Overview	718
Use the server workload type	719
server-specific workload parameters	719
Expose server workloads outside the cluster	720
Expose server workloads outside the cluster automatically	720
Expose HTTP server workloads outside the cluster manually	720
Define a workload type that exposes server workloads outside the cluster	721
Expose workloads outside the cluster using AVI L4/L7	725
Use worker workloads	725
Overview	725
Use the worker workload type	726
Service-to-Service communication	726
Calling web workloads within a cluster	726
Example of service-to-service communication for web and server workloads	727
Parameter reference	727
Workload Parameter Reference	727
List of Supply Chain Resources for Workload Object	727

source-provider	728
GitRepository	728
ImageRepository	729
MavenArtifact	729
source-tester	729
source-scanner	730
image-provider	731
Kpack Image	731
Runnable (TaskRuns for Dockerfile-based builds)	732
Pre-built image (ImageRepository)	732
image-scanner	733
config-provider	733
app-config	734
service-bindings	735
api-descriptors	735
config-writer (git or registry)	736
deliverable	736
Deliverable Parameters Reference	736
List of Cluster Delivery Resources for Deliverable Object	737
source-provider	737
GitRepository	737
ImageRepository	738
app deployer	738
App	738
Use functions (Beta)	739
Overview	739
Supported languages and frameworks	740
Prerequisites	740
Create a function project from an accelerator	740
Create a function project using the Tanzu CLI	741
Deploy your function	742
Use functions (Beta)	743
Overview	743
Supported languages and frameworks	744
Prerequisites	744
Create a function project from an accelerator	744
Create a function project using the Tanzu CLI	745
Deploy your function	746
Troubleshoot Tanzu Application Platform	748

Troubleshoot Tanzu Application Platform	748
Troubleshoot installing Tanzu Application Platform	748
Developer cannot be verified when installing Tanzu CLI on macOS	748
Access <code>.status.usefulErrorMessage</code> details	749
“Unauthorized to access” error	749
“Serviceaccounts already exists” error	750
After package installation, one or more packages fails to reconcile	750
Ingress is broken on Kind cluster	754
Troubleshoot using Tanzu Application Platform	754
Installed packages are failing	754
Use events to find possible causes	754
Missing build logs after creating a workload	755
Explanation	755
Solution	755
Workload creation stops responding with “Builder default is not ready” message	755
Explanation	755
Solution	755
“Workload already exists” error after updating the workload	756
Explanation	756
Solution	756
Workload creation fails due to authentication failure in Docker Registry	756
Explanation	756
Solution	756
Telemetry component logs show errors fetching the “reg-creds” secret	757
Explanation	757
Solution	757
Debug convention might not apply	757
Explanation	757
Solution	757
Execute bit not set for App Accelerator build scripts	757
Explanation	758
Solution	758
“No live information for pod with ID” error	758
Explanation	758
Solution	758
“image-policy-webhook-service not found” error	758
Explanation	758
Solution	758
“Increase your cluster resources” error	758
Explanation	759

Solution	759
MutatingWebhookConfiguration prevents pod admission	759
Explanation	759
Solution	759
Priority class of webhook's pods preempts less privileged pods	760
Explanation	760
Solution	760
CrashLoopBackOff from password authentication fails	761
Explanation	761
Solution	761
Password authentication fails	761
Explanation	761
Solution	761
metadata-store-db pod fails to start	762
Explanation	762
Solution	762
Missing persistent volume	762
Explanation	762
Solution	763
Failure to connect Tanzu CLI to AWS EKS clusters	763
Explanation	763
Solution	763
Invalid repository paths are propagated	763
Explanation	763
Solution	764
x509: certificate signed by unknown authority	764
Explanation	764
Solution	764
Option 1: Configure the Shared Ingress Issuer's Certificate Authority as a trusted Certificate Authority	764
Option 2: Deactivate the shared ingress issuer	764
Troubleshoot Tanzu Application Platform components	765
Troubleshoot Tanzu GitOps Reference Implementation (RI)	765
Tanzu Sync application error	765
Tanzu Application Platform install error	766
Common errors	766
Given data value is not declared in schema	766
ExternalSecret not found	766
Error occurs when deleting Kubernetes authentication	767
Uninstall your Tanzu Application Platform by using Tanzu CLI	768

Delete the packages	768
Delete the Tanzu Application Platform package repository	769
Remove Tanzu CLI, plug-ins, and associated files	769
Remove Cluster Essentials	770
Remove Crossplane resources	770
Uninstall your Tanzu Application Platform by using Tanzu CLI	770
Delete the packages	770
Delete the Tanzu Application Platform package repository	771
Remove Tanzu CLI, plug-ins, and associated files	771
Remove Cluster Essentials	772
Remove Crossplane resources	772
Uninstall Tanzu Application Platform by using GitOps	772
Delete Tanzu Sync Application	772
Delete external resources from AWS Secrets Manager	772
Delete external resources from Hashicorp Vault	773
Remove the Tanzu CLI, plug-ins, and associated files	773
Remove Cluster Essentials	773
Component documentation for Tanzu Application Platform	774
Component documentation for Tanzu Application Platform	774
Overview of Tanzu CLI	774
Tanzu CLI	774
Tanzu CLI architecture	774
Tanzu CLI installation	775
Tanzu CLI command groups	775
Install new plug-ins	775
Overview of Tanzu CLI	776
Tanzu CLI	776
Tanzu CLI architecture	776
Tanzu CLI installation	776
Tanzu CLI command groups	776
Install new plug-ins	777
Overview of Tanzu CLI plug-ins	777
Overview of Tanzu CLI plug-ins	778
Tanzu Apps CLI overview	778
About workloads	778

Tanzu Apps CLI overview	778
About workloads	778
Get started with Apps CLI plug-in	778
Install Tanzu Apps CLI	779
Prerequisites	779
Install Tanzu Apps CLI plug-in	779
Uninstall Tanzu Apps CLI	779
Configure the Tanzu Apps CLI	779
Changing clusters with <code>--context</code>	779
Overriding the default kubeconfig	780
Suppressing color with <code>--no-color</code> flag	780
tanzuignore file	781
Example of a <code>.tanzuignore</code> file	781
Registry flags and environment variables	781
Autocompletion	782
Bash	782
Zsh	782
Tanzu Apps CLI tutorials	782
Create or update a workload	782
Create a workload from a workload.yaml file or from a URL	782
Create a workload from a YAML file	783
Create a workload from stdin	783
Create a workload from URL	784
Create workload from Git source	784
Unset Git fields	785
Subpath	786
Create a workload from Local Source	787
<code>--live-update</code>	788
Spring Boot application example	788
Subpath	790
Create a workload from a pre-built image	790
Create a workload from a Maven repository artifact	791
Create a workload from a Dockerfile	791
Get workload status	791
tanzu apps workload list	791
<code>--all-namespaces, -A</code> flag	791
<code>--app</code> flag	792
<code>--namespace, -n</code> flag	792

-output, -o flag	792
tanzu apps workload get	794
tanzu apps workload tail	795
tail a workload while creating or applying a workload	796
-export flag	797
-output flag with tanzu apps workload get command	798
-output flag with tanzu apps workload apply command	800
Delete a workload	802
Delete all workloads in a namespace	802
Apps CLI how-to-guides	802
Integrate with Local Source Proxy	802
Check Local Source Proxy health	803
Update the local source code for workloads	804
Use the --source-image flag	804
Switch from Local Source Proxy to --source-image flag	805
Manage workload merge behavior	806
merge	806
replace	806
Troubleshoot Apps CLI plug-in	808
Troubleshoot workloads	808
Check build logs	808
Get the workload status and details	808
Common workload errors	808
Local Path Development Error Cases	809
WorkloadLabelsMissing/SupplyChainNotFound	809
MissingValueAtPath	809
TemplateRejectedByAPIServer	810
Review supply chain steps	810
Additional Troubleshooting References	811
Troubleshooting Local Source Proxy integration	811
Tanzu Apps CLI reference	811
Tanzu Apps CLI plug-in dependency matrix	811
Check Cartographer version	812
tanzu apps cluster-supply-chain	812
tanzu apps clustersupplychain list	812

Default view	812
tanzu apps cluster-supply-chain get	812
Default view	812
tanzu apps workload apply	813
Default view	813
Workload Apply flags	814
--annotation	814
--app / -a	815
--build-env	815
--debug	816
--dry-run	817
--env / -e	817
--file, -f	818
--git-repo	819
--git-branch	819
--git-tag	819
--git-commit	819
--image / -i	820
--label / -l	820
--limit-cpu	821
--limit-memory	821
--live-update	822
--local-path	823
--maven-artifact	824
--maven-group	824
--maven-type	824
--maven-version	824
--source-image, -s	824
--namespace, -n	825
--output, -o	825
--param / -p	826
--param-yaml	827
--registry-ca-cert	828
--registry-password	828
--registry-token	828
--registry-username	828
--request-cpu	829
--request-memory	829
--service-account	829
--service-ref	830
--sub-path	831

--tail	832
--tail-timestamp	833
--type / -t	834
--update-strategy	834
--wait	835
--wait-timeout	835
--yes, -y	836
tanzu apps workload delete	836
Default view	837
Workload Delete flags	837
--all	837
--file, -f	837
--namespace, -n	837
--wait	837
--wait-timeout	837
--yes, -f	838
tanzu apps workload get	838
Default view	838
--export	840
--output/-o	840
--namespace/-n	842
tanzu apps workload list	843
Default view	843
--all-namespaces, -A	843
--app	844
--namespace, -n	844
--output, -o	844
tanzu apps workload tail	846
Default view	846
--component	847
--namespace, -n	847
--since	848
--timestamp, -t	849
Overview of Tanzu Accelerator CLI	850
Server API connections for operators and developers	850
Using TAP-GUI URL	850
Using Application Accelerator Server URL	850
Using “ACC_SERVER_URL” environment variable	851

Installation	851
Command reference	851
Overview of Tanzu Accelerator CLI	851
Server API connections for operators and developers	851
Using TAP-GUI URL	851
Using Application Accelerator Server URL	852
Using “ACC_SERVER_URL” environment variable	852
Installation	852
Command reference	852
Install Tanzu Accelerator CLI	852
Prerequisites	853
Install	853
Command reference	853
tanzu accelerator	854
Options	854
SEE ALSO	854
tanzu accelerator	854
Options	854
SEE ALSO	854
tanzu accelerator apply	855
Synopsis	855
Examples	855
Options	855
Options inherited from parent commands	855
SEE ALSO	855
tanzu accelerator create	855
Synopsis	855
Examples	856
Options	856
Options inherited from parent commands	856
SEE ALSO	856
tanzu accelerator delete	856
Synopsis	856
Examples	857
Options	857
Options inherited from parent commands	857
SEE ALSO	857

tanzu accelerator fragment	857
Synopsis	857
Examples	857
Options	857
Options inherited from parent commands	857
SEE ALSO	857
tanzu accelerator fragment create	858
Synopsis	858
Example	858
Options	858
Options inherited from parent commands	858
SEE ALSO	859
tanzu accelerator fragment delete	859
Synopsis	859
Examples	859
Options	859
Options inherited from parent commands	859
SEE ALSO	859
tanzu accelerator fragment get	859
Synopsis	859
Examples	859
Options	860
Options inherited from parent commands	860
SEE ALSO	860
tanzu accelerator fragment list	860
Synopsis	860
Examples	860
Options	860
Options inherited from parent commands	860
SEE ALSO	860
tanzu accelerator fragment update	860
Synopsis	861
Examples	861
Options	861
Options inherited from parent commands	861
SEE ALSO	861
tanzu accelerator generate	861
tanzu accelerator generate	861

Synopsis	861
Examples	862
Options	862
Options inherited from parent commands	862
SEE ALSO	862
tanzu accelerator generate-from-local	862
Synopsis	862
Examples	863
Options	863
Options inherited from parent commands	863
SEE ALSO	863
tanzu accelerator get	863
Synopsis	864
Examples	864
Options	864
Options inherited from parent commands	864
SEE ALSO	864
tanzu accelerator list	864
Synopsis	864
Examples	864
Options	865
Options inherited from parent commands	865
SEE ALSO	865
tanzu accelerator push	865
Synopsis	865
Examples	865
Options	865
Configure Local Source Proxy	866
Options inherited from parent commands	866
SEE ALSO	866
tanzu accelerator update	866
Synopsis	866
Examples	866
Options	866
Options inherited from parent commands	867
SEE ALSO	867
Overview of Build Service CLI plug-in	867
Command reference	867

Image Command	867
Image List	867
Image Status	867
Build Command	867
Build List	867
Build Status	867
Build Logs	868
ClusterBuilder Command	868
ClusterBuilder List	868
ClusterBuildpack Command	868
ClusterBuildpack List	868
tanzu build-service	868
Options	868
SEE ALSO	869
tanzu build-service build	869
Options	869
SEE ALSO	869
tanzu build-service builder	869
Options	869
SEE ALSO	869
tanzu build-service builder list	869
Synopsis	870
Examples	870
Options	870
SEE ALSO	870
tanzu build-service builder status	870
Synopsis	870
Examples	870
Options	870
SEE ALSO	870
tanzu build-service buildpack	870
Options	871
SEE ALSO	871
tanzu build-service buildpack list	871
Synopsis	871
Examples	871
Options	871

SEE ALSO	871
tanzu build-service buildpack status	871
Synopsis	871
Examples	872
Options	872
SEE ALSO	872
tanzu build-service build list	872
Synopsis	872
Examples	872
Options	872
SEE ALSO	872
tanzu build-service build logs	872
Synopsis	872
Examples	873
Options	873
SEE ALSO	873
tanzu build-service build status	873
Synopsis	873
Examples	873
Options	873
SEE ALSO	873
tanzu build-service clusterbuilder	874
Options	874
SEE ALSO	874
tanzu build-service clusterbuilder list	874
Synopsis	874
Examples	874
Options	874
SEE ALSO	874
tanzu build-service clusterbuilder status	874
Synopsis	874
Examples	875
Options	875
SEE ALSO	875
tanzu build-service clusterbuildpack	875
Options	875
SEE ALSO	875

tanzu build-service clusterbuildpack list	875
Synopsis	875
Examples	875
Options	875
SEE ALSO	875
tanzu build-service clusterbuildpack status	876
Synopsis	876
Examples	876
Options	876
SEE ALSO	876
tanzu build-service clusterstack	876
Options	876
SEE ALSO	876
tanzu build-service clusterstack list	876
Synopsis	876
Examples	877
Options	877
SEE ALSO	877
tanzu build-service clusterstack status	877
Synopsis	877
Examples	877
Options	877
SEE ALSO	877
tanzu build-service clusterstore	877
Options	877
SEE ALSO	878
tanzu build-service clusterstore list	878
Synopsis	878
Examples	878
Options	878
SEE ALSO	878
tanzu build-service clusterstore status	878
Synopsis	878
Examples	878
Options	878
SEE ALSO	879
tanzu build-service image	879

Options	879
SEE ALSO	879
tanzu build-service image list	879
Synopsis	879
Examples	879
Options	879
SEE ALSO	880
tanzu build-service image status	880
Synopsis	880
Examples	880
Options	880
SEE ALSO	880
tanzu build-service image trigger	880
Synopsis	880
Examples	880
Options	880
SEE ALSO	881
Overview of Tanzu Insight plug-in	881
Overview of Tanzu Insight plug-in	881
Install your Tanzu Insight CLI plug-in	881
Configure your Tanzu Insight CLI plug-in	882
Set the target and certificate authority (CA) certificate	882
Single-cluster setup	882
Set the target	883
Set the access token	883
Verify the connection	883
Query vulnerabilities, images, and packages	883
Supported use cases	884
Query using the Tanzu Insight CLI plug-in	884
Example #1: What packages and CVEs does a specific image contain?	884
Find an image's digest	884
Find an image's digest using Supply Chain Tools - Scan 2.0	884
Find an image's digest using Supply Chain Tools - Scan Pre-2.0	885
Query an image with image digest	885
Example #2: What packages and CVEs does my source code contain?	886
Determining source code org, repo, and commit SHA	886
Source code query with repo and org	886

Source code query with commit SHA	887
Example #3: What dependencies are affected by a specific CVE?	887
Add data	887
Add data to your Supply Chain Security Tools - Store	888
Supported formats and file types	888
Generate a CycloneDX file	888
Add data with the Tanzu Insight plug-in	888
Example #1: Add an image report	888
Example #2: Add a source report	889
Triage vulnerabilities (alpha)	889
Triage	889
Prerequisites	890
Create vulnerability analyses	890
View existing analysis	891
Copy an analysis	891
Tanzu insight CLI plug-in command reference	891
Synopsis	892
Options	892
See also	892
tanzu insight config	892
Options	892
See also	892
tanzu insight config set-target	892
Synopsis	892
Examples	893
Options	893
See also	893
tanzu insight health	893
Synopsis	893
Examples	893
Options	893
See also	893
tanzu insight image	893
Options	893
See also	894
tanzu insight image add	894
Synopsis	894

Examples	894
Options	894
See also	894
tanzu insight image get	895
Synopsis	895
Examples	895
Options	895
See also	895
tanzu insight image packages	895
Synopsis	895
Examples	895
Options	895
See also	896
tanzu insight image vulnerabilities	896
Synopsis	896
Examples	896
Options	896
See also	896
tanzu insight package	896
Options	896
See also	896
tanzu insight package get	897
Synopsis	897
Examples	897
Options	897
See also	897
tanzu insight package images	897
Synopsis	897
Examples	897
Options	897
See also	898
tanzu insight package sources	898
Synopsis	898
Examples	898
Options	898
See also	898
tanzu insight package vulnerabilities	898

Synopsis	898
Examples	898
Options	899
See also	899
tanzu insight source	899
Options	899
See also	899
tanzu insight source add	899
Synopsis	899
Examples	899
Options	900
See also	900
tanzu insight source get	900
Synopsis	900
Examples	900
Options	900
See also	900
tanzu insight source packages	901
Synopsis	901
Examples	901
Options	901
See also	901
tanzu insight source vulnerabilities	901
Synopsis	901
Examples	901
Options	901
See also	902
tanzu insight triage	902
Options	902
See also	902
tanzu insight triage copy	902
Synopsis	902
Examples	902
Options	903
Options inherited from parent commands	903
See also	903
tanzu insight triage list	903

Examples	903
Options	903
Options inherited from parent commands	903
See also	904
tanzu insight triage update	904
Synopsis	904
Impact Analysis States --state	904
Impact Analysis Justifications --justification	904
Impact Analysis Responses --response	905
Free form comments --comment	905
Examples	905
Options	905
Options inherited from parent commands	906
See also	906
tanzu insight vulnerabilities	906
Options	906
See also	906
tanzu insight vulnerabilities get	906
Synopsis	906
Examples	906
Options	907
See also	907
tanzu insight vulnerabilities images	907
Synopsis	907
Examples	907
Options	907
See also	907
tanzu insight vulnerabilities packages	907
Synopsis	907
Examples	908
Options	908
See also	908
tanzu insight vulnerabilities sources	908
Synopsis	908
Examples	908
Options	908
See also	908

Overview of API Auto Registration	908
Overview	908
Getting started	909
Overview of API Auto Registration	909
Overview	909
Getting started	910
Key Concepts for API Auto Registration	910
API Auto Registration Architecture	910
APIDescriptor Custom Resource Explained	910
With an Absolute URL	911
With an Object Ref	911
With an HTTPProxy Object Ref	911
With a Knative Service Object Ref	912
With an Ingress Object Ref	912
APIDescriptor Status Fields	912
Install API Auto Registration	912
Tanzu Application Platform prerequisites	913
Using with TLS	913
Install	913
Use API Auto Registration	915
Generate OpenAPI Spec	916
Using a Spring Boot app with a REST service	916
Using App Accelerator Template	916
Using an existing Spring Boot project using springdoc	917
Create APIDescriptor Custom Resource	917
Use Out-Of-The-Box (OOTB) supply chains	917
Using Custom Supply Chains	918
Using other GitOps processes or Manually	918
Additional configuration	918
Setting up CORS for OpenAPI specifications	918
Troubleshoot API Auto Registration	919
Debug API Auto Registration	919
APIDescriptor CRD shows message of connection refused but service is up and running	920
Configure CA Cert Data	920
APIDescriptor CRD shows message of x509: certificate signed by unknown authority but service is running	920
Overview of API portal for VMware Tanzu	921
Getting started	921

Overview of API portal for VMware Tanzu	921
Getting started	921
Install API portal for VMware Tanzu	922
Prerequisites	922
Install	922
Update the installation values for the api-portal package	923
Overview of API Validation and Scoring	924
Overview of API Validation and Scoring	924
Install API Validation and Scoring	924
Prerequisites	924
Resource requirements	925
Relocate images to a registry	925
Add the API Validation and Scoring package repository	926
Install	927
Uninstall	928
Use API Validation and Scoring to score your auto-registered API	928
Use API Validation and Scoring to score your auto-registered API	928
Overview of Application Accelerator	929
Overview	929
Architecture	929
How does Application Accelerator work?	930
Next steps	930
Overview of Application Accelerator	930
Overview	930
Architecture	931
How does Application Accelerator work?	931
Next steps	932
Install Application Accelerator	932
Prerequisites	932
Install	932
Configure properties and resource use	934
Configure Application Accelerator	935
Using a Git-Ops style configuration for deploying a set of managed accelerators	935
Functional and Organizational Considerations	936
Examples for creating accelerators	936
A minimal example for creating an accelerator	936

An example for creating an accelerator with customized properties	937
Creating a manifest with multiple accelerators and fragments	938
Configure tap-values.yaml with Git credentials secret	938
Using non-public repositories	939
Examples for a private Git repository	940
Example using http credentials	940
Example using http credentials with self-signed certificate	941
Example using SSH credentials	942
Examples for a private source-image repository	943
Example using image-pull credentials	943
Configure ingress timeouts when some accelerators take longer to generate	944
Configure an ingress timeout overlay secret for each HTTPProxy	944
Apply the timeout overlay secrets in tap-values.yaml	945
Configuring skipping TLS verification for access to Source Controller	945
Enabling TLS for Accelerator Server	945
Configuring skipping TLS verification of Engine calls for Accelerator Server	946
Enabling TLS for Accelerator Engine	946
Next steps	946
Create accelerators	946
Prerequisites	947
Getting started	947
Publishing the new accelerator	947
Using accelerator fragments	948
Deploying accelerator fragments	949
Next steps	951
Create accelerators	951
Prerequisites	951
Getting started	951
Publishing the new accelerator	952
Using accelerator fragments	953
Deploying accelerator fragments	954
Next steps	955
Create an accelerator.yaml file in Application Accelerator	955
Accelerator	955
Accelerator metadata	956
Accelerator options	956
DependsOn and multi-value dataType	957
Examples	958
Engine	960
Engine example	960

Engine notation descriptions	961
Advanced accelerator use	961
Application Accelerator sample accelerator.yaml file	961
Use transforms in Application Accelerator	964
Why transforms?	965
Combining transforms	965
Chain	966
Merge	966
Shortened notation	967
A Combo of one?	968
A common pattern with merge transforms	969
Conditional transforms	969
Conditional 'Merge' transform	970
Conditional 'Chain' transform	970
A small gotcha with using conditionals in merge transforms	971
Merge conflict	972
Resolving merge conflicts	972
File ordering	973
Next steps	973
Use custom types in Application Accelerator	973
Limitations	975
Interaction with SpEL	976
Interaction with Composition	976
Use fragments in Application Accelerator	976
Introduction	976
Introducing fragments	976
The imports section explained	977
Using the InvokeFragment Transform	978
Back to the imports section	978
Using dependsOn in the imports section	979
Discovering fragments using Tanzu CLI accelerator plug-in	980
Transforms reference	983
Available transforms	983
See also	984
Transforms reference	984
Available transforms	984
See also	984

Combo transform	984
Syntax reference	985
Behavior	985
Examples	987
Example 1	987
Example 2	987
Include transform	988
Syntax reference	988
Examples	988
See also	988
Exclude transform	988
Syntax reference	989
Examples	989
See also	989
Merge transform	989
Syntax reference	990
See also	990
Chain transform	990
Syntax reference	990
Behavior	991
Let transform	991
Syntax reference	991
Execution	991
See also	992
Loop transform	992
Syntax reference	992
Behavior	992
Examples	992
Example 1	993
Example 2	993
Example 3	994
InvokeFragment transform	994
Syntax reference	994
Behavior	994
Variables	995
Files	995
Examples	995

See also	997
ReplaceText transform	997
Syntax reference	997
Examples	998
Example 1	998
Example 2	998
Example 3	998
Example 4	998
Example 5	999
See also	999
RewritePath transform	999
Syntax reference	999
Examples	1000
Example 1	1000
Example 2	1000
Example 3	1000
Interaction with Chain and Include	1000
See also	1000
OpenRewriteRecipe transform	1001
Syntax reference	1001
Example	1001
YTT transform	1002
Syntax reference	1002
Execution	1002
Examples	1002
Basic invocation	1002
Using extraArgs	1003
UseEncoding transform	1003
Syntax reference	1003
Example use	1004
See also	1004
UniquePath transform	1004
Syntax reference	1004
Examples	1004
See also	1004
Conflict resolution	1004
Syntax reference	1005

Combo	1005
Chain	1005
Available strategies	1006
See also	1006
Provenance transform	1006
Syntax reference	1006
Behavior	1006
Use SpEL with Application Accelerator	1007
Variables	1007
Implicit variables	1008
Conditionals	1008
Rewrite path concatenation	1008
Regular expressions	1009
Dealing with string arrays	1009
Accelerator custom resource definition	1009
Overview	1009
API definitions	1010
Accelerator CRD Spec	1010
Fragment CRD Spec	1011
Excluding files	1012
Test accelerators in Application Accelerator	1012
Generate a project from local sources	1012
CI/CD Pipeline	1013
Add the Tanzu CLI to a CI/CD pipeline	1013
Use the Provenance transform in Application Accelerator	1014
Use the Application Accelerator Visual Studio Code extension	1014
Dependencies	1014
Install the extension	1014
Configure the extension	1015
Using the extension	1015
Retrieving the URL for the Tanzu Developer Portal	1016
Download and Install Self-Signed Certificates from the Tanzu Developer Portal	1016
Prerequisites	1016
Procedure	1016
Use the Application Accelerator IntelliJ plug-in	1017
Dependencies	1017
Install the plug-in	1018

Configure the plug-in	1018
Use the plug-in	1019
Retrieving the URL for the Tanzu Developer Portal	1021
Download and Install Self-Signed Certificates	1022
Prerequisites	1022
Procedure	1022
Application Accelerator best practices	1023
Best practices for using accelerators	1023
Benefits of using an accelerator	1023
Design considerations	1023
Housekeeping rules	1024
Tests	1024
Application skeleton	1024
Best practices for using fragments	1024
Benefits of using Fragment	1024
Design considerations	1025
Housekeeping rules	1025
Versioning	1026
Troubleshoot Application Accelerator	1026
Installation issues	1026
Verify installed packages	1026
Look at resource events	1026
Development issues	1027
Failure to generate a new project	1027
URI is not absolute error	1027
Accelerator authorship issues	1028
General tips	1028
Speed up the reconciliation of the accelerator	1028
Use a source image with local accelerator source directory	1028
Expression evaluation errors	1028
Operations issues	1029
Accelerator persists in Tanzu Developer Portal after deletion	1029
Check status of accelerator resources	1029
When Accelerator ready column is blank	1029
When Accelerator ready column is false	1030
REASON: GitRepositoryResolutionFailed	1030
REASON: GitRepositoryResolutionPending	1031
REASON: ImageRepositoryResolutionPending	1032

Overview of Application Configuration Service for VMware Tanzu	1033
Overview of Application Configuration Service for VMware Tanzu	1033
Install Application Configuration Service for VMware Tanzu	1034
Prerequisites	1034
Install	1034
Overview of Application Live View	1035
Value proposition	1035
Intended audience	1035
Supported application platforms	1036
Multicloud compatibility	1036
Deployment	1036
Overview of Application Live View	1036
Value proposition	1036
Intended audience	1036
Supported application platforms	1036
Multicloud compatibility	1036
Deployment	1036
Install Application Live View	1037
Overview	1037
Prerequisites	1037
Install Application Live View	1037
Install Application Live View back end	1038
Install Application Live View connector	1041
Install Application Live View conventions	1045
Install Application Live View API Server	1047
Deprecation notice for the sslDisabled key	1049
Configure security and access control in Application Live View	1049
Security and access control overview	1049
Prerequisites	1050
Configure improved security	1050
Application Live View connector	1050
Application Live View UI plug-in	1052
Authorize a user to execute sensitive operations	1054
Enabling Spring Boot apps for Application Live View	1055
Enable Spring Boot apps	1055
Enable Spring Boot 3 apps	1056
Enable Spring Cloud Gateway apps	1057

Workload image NOT built with Tanzu Build Service	1057
Enabling Spring Boot apps for Application Live View	1058
Enable Spring Boot apps	1058
Enable Spring Boot 3 apps	1058
Enable Spring Cloud Gateway apps	1059
Workload image NOT built with Tanzu Build Service	1060
Enable Spring Native apps for Application Live View	1060
Procedure	1060
Enable Steeltoe apps for Application Live View	1062
Extend .NET Core Apps to Steeltoe Apps	1062
Enable Application Live View on Steeltoe Tanzu Application Platform workload	1063
Application Live View convention server	1064
Role of Application Live View convention	1064
Description of metadata labels	1064
Verify the applied labels and annotations	1065
Custom configuration for the connector	1066
Configure the developer workload in Tanzu Application Platform	1067
Deploy the workload	1067
Verify the label has propagated through the Supply Chain	1068
Custom configuration for application actuator endpoints	1069
Scaling Knative apps in Tanzu Application Platform	1072
Configure the developer workload in Tanzu Application Platform	1072
Deploy the workload	1073
Verify the annotation has propagated through the Supply Chain	1073
Application Live View on OpenShift	1074
Support for polyglot apps with Application Live View	1075
Application Live View internal architecture	1075
Component overview	1076
Design flow	1077
Troubleshoot Application Live View	1077
App is not visible in Application Live View UI	1077
App is not visible in Application Live View UI with actuator endpoints enabled	1078
The UI does not show any information for an app with actuator endpoints exposed at root	1078
No information shown on the Health page	1078
Stale information in Application Live View	1079

Unable to find CertificateRequests in Application Live View convention	1079
No live information for pod with ID	1079
Cannot override the actuator path in the labels	1080
Cannot configure SSL in appliveview-connector	1080
Verify the labels in your workload YAML file	1080
Override labels set by the Application Live View convention service	1081
Configure labels when management.endpoints.web.base-path and management.server.port are set	1081
Uninstall Application Live View	1081
Overview of Application Single Sign-On for VMware Tanzu® 4.0	1082
Document organization	1082
Overview of Application Single Sign-On for VMware Tanzu® 4.0	1083
Document organization	1083
Application Single Sign-On concepts	1083
Levels of consumption for Application Single Sign-On	1084
Level 1: ClientRegistration	1084
Level 2: WorkloadRegistration	1086
Level 3: ClassClaim (recommended)	1087
Summary	1088
Configure grant types	1088
Topics	1089
Client Credentials Grant Type	1089
Authorization Code Grant Type	1090
About token signatures	1091
Token signature 101	1091
Token signature of an AuthServer	1092
Get started with Application Single Sign-On	1093
Overview of Application Single Sign-On	1093
Prerequisites	1093
Key concepts	1093
Next steps	1095
Provision an AuthServer	1095
Prerequisites	1095
Provision an AuthServer	1095
The AuthServer spec in detail	1097
Metadata	1097

TLS & issuer URI	1097
Token Signature	1098
Identity providers	1098
Configuring storage	1099
Provision a client registration	1099
Prerequisites	1099
Creating the ClientRegistration	1099
Validating that the credentials are working	1100
Deploy an application with Application Single Sign-On	1101
Prerequisites	1101
Deploy a minimal application	1101
Deployment manifest	1103
OAuth2-Proxy	1104
Application Single Sign-On how-to guides	1104
Application Single Sign-On for Platform Operators	1104
Application Single Sign-On for Platform Operators	1104
Install Application Single Sign-On	1104
What's inside	1105
Prerequisites	1105
Install Application Single Sign-On for VMware Tanzu	1105
See also	1105
Upgrade Application Single Sign-On	1106
Migration guides	1106
v3.0.0 to v3.1.0	1106
v2.0.0 to v3.0.0	1106
v1.0.0 to v2.0.0	1107
Uninstall Application Single Sign-On	1107
Application Single Sign-On for Service Operators	1108
Application Single Sign-On for Service Operators	1108
Configure an unsafe test login	1109
Configure a ClusterUnsafeTestLogin	1110
Use the unsafe test login	1110
Annotations and labels for AppSSO	1110
Labels	1110

Allowing client namespaces	1111
Unsafe configuration	1111
Unsafe identity provider	1111
Unsafe issuer URI	1111
Issuer URI and TLS for AppSSO	1112
Overview	1112
Configure TLS by using a (Cluster)Issuer	1113
Configure TLS by using a Certificate	1114
Configure TLS by using a Secret	1114
Deactivate TLS (unsafe)	1115
Allow Workloads to trust a custom CA AuthServer	1115
TLS scenario guides for AppSSO	1116
Overview	1116
Prerequisites	1116
Using a default issuer	1117
Using a ClusterIssuer	1118
Using an Issuer	1119
Using an existing Certificate	1120
Using an existing TLS certificate	1122
Using an existing wildcard TLS certificate	1125
CA certificates for AppSSO	1128
Configure workloads to trust a custom CA	1129
Overview	1129
Exporting custom CA certificate Secret	1130
Importing custom CA certificate Secret	1130
Appending custom CA certificate Secret reference to Workload	1131
Identity providers for AppSSO	1131
OpenID Connect providers	1132
OpenID external groups mapping	1134
Note for registering a client with the identity provider	1134
Supported token signing algorithms	1135
LDAP	1135
LDAP external groups mapping	1137
ActiveDirectory group search	1137
“Classic” group search	1138
Direct group search only	1139
Groups in sub-trees	1140
Nested group search	1141

SAML (experimental)	1142
SAML external groups mapping	1142
Note for registering a client with the identity provider	1143
InternalUnsafe	1143
Generating a bcrypt hash from a plain-text password	1144
Identity token claims mapping	1144
Constraints	1145
Roles claim filtering	1146
Roles claim filters	1146
Roles claim filter examples	1147
Roles claim mapping and filtering explained	1148
Restrictions	1148
Configure authorization for AppSSO	1149
Overview	1149
Retrieving external groups or roles	1149
Mapping individual roles into authorization scopes	1150
Default authorization scopes	1150
Public clients and CORS for AppSSO	1152
Overview	1152
CORS configuration	1152
Client authentication	1153
References	1153
Token settings for Application Single Sign-On	1153
Token expiry	1154
Constraints	1154
Verify token settings	1154
Manage token signature keys for Application Single Sign-On	1158
Overview	1158
Creating keys	1159
Using secretgen-controller	1159
Using OpenSSL	1160
Rotating keys	1161
Revoking keys	1162
References and further reading	1162
Storage for AppSSO	1162
Overview	1163
Securing Data at rest	1163
Configuring Redis	1163

Configuring Redis Server CA certificate	1163
Configuring a Redis Secret	1164
Attaching storage to an AuthServer	1164
Inspecting storage of an AuthServer	1164
Storage provided by default	1165
Data types	1165
Known limitations of storage providers	1166
Redis Cluster	1166
AuthServer readiness for AppSSO	1166
Client registration check	1166
Prerequisites	1167
Define and apply a test client	1167
Get an access token	1167
Scale AuthServer for AppSSO	1168
Curate a service offering	1168
Prerequisites	1168
Create a ClusterWorkloadRegistrationClass	1168
Customize the ClusterWorkloadRegistrationClass	1169
Names and descriptions	1170
Application Single Sign-On for App Operators	1170
Discover Application Single Sign-On service offerings	1170
Claim credentials for an Application Single Sign-On service offering	1170
Discover available parameters	1171
Claim credentials	1171
Inspect the progress of your claim	1172
Next steps	1173
Secure a workload with Application Single Sign-On	1173
OAuth2 client parameters	1173
redirectPaths	1174
workloadRef	1174
authorizationGrantTypes	1175
Client authentication method	1175
scopes	1176
requireUserConsent	1176
Behind the scenes	1176
Loading client credentials into a Workload	1177
Trusting an authorization server	1178

Summary	1178
Secure a Spring Boot workload	1178
Get the sample application	1178
Create a namespace for workloads	1179
Claim client credentials	1179
Ensure Workload trusts AuthServer	1180
Deploy the Workload	1180
Cleaning up	1181
Secure a single-page app workload	1181
Get the sample application	1181
Create a namespace for workloads	1182
Claim the client credentials	1182
Verify application authentication settings	1183
Start a sample back end	1183
Deploy the Workload	1184
Clean up	1184
Troubleshoot Application Single Sign-on	1185
Why is my AuthServer not working?	1185
Find all AuthServer related Kubernetes resources	1185
See logs of all AuthServers	1185
Wait for change propagation	1185
Set up debug logs	1185
Misconfigured clientSecret	1186
Problem:	1186
Solution:	1186
Misconfigured redirect URI	1186
Problem:	1186
Solution:	1186
Unsupported id_token_signed_response_alg with openid identityProviders	1186
Problem:	1186
Solution:	1186
Misconfigured identity provider clientSecret	1187
Problem:	1187
Solution:	1187
Missing scopes	1187
Problem:	1187
Solution:	1187
Misconfigured sub claim	1187
Problem:	1187
Solution:	1187

Troubleshoot a ClassClaim for an AppSSO service	1187
Problem:	1187
Solution:	1187
Application Single Sign-On Reference	1188
AppSSO APIs	1188
AuthServer API for AppSSO	1188
Spec	1189
Status & conditions	1192
RBAC	1194
Example	1194
ClientRegistration API for AppSSO	1196
Spec	1196
Scopes	1197
Client authentication methods	1197
Status & conditions	1198
Example	1199
ClusterUnsafeTestLogin API for Application Single Sign-On	1200
Specification	1200
Example	1201
ClusterWorkloadRegistrationClass API for Application Single Sign-On	1201
Specification	1202
Examples	1203
Claims	1203
Claims specification	1203
Claims examples	1204
Claims updates	1205
WorkloadRegistration API for AppSSO	1205
Specification	1206
Examples	1207
Redirect URI templating	1208
XWorkloadRegistration API for AppSSO	1209
Specification	1209
Examples	1210
Known issues for Application Single Sign-On	1210
Unregistration by deletion	1210
Limited number of ClientRegistrations per AuthServer	1211

LetsEncrypt: domain name for Issuer URI limited to 64 characters maximum	1211
Spring Boot 3 based Workloads and ClientRegistration resources	1211
ClassClaim credential propagation time	1211
Application Single Sign-On for OpenShift clusters	1211
Package configuration for Application Single Sign-On	1213
Configuration values	1213
ca_cert_data	1213
cluster_resource_namespace	1213
default_authserver_clusterissuer	1214
default_workload_domain_template	1214
domain_name	1214
domain_template	1214
kubernetes_distribution	1215
kubernetes_version	1215
workload_domain_name	1215
replicas	1215
resources	1215
resync_period	1215
Configuration schema	1215
RBAC for AppSSO	1216
User aggregated rules	1216
app-operator	1216
app-editor	1217
app-viewer	1217
service-operator	1217
Controller	1217
AuthServer audit logs for AppSSO	1219
Overview	1219
Authentication	1219
Token flows	1220
Overview of Default roles for Tanzu Application Platform	1220
Default roles	1221
Working with roles using the RBAC CLI plug-in	1221
Disclaimer	1221
Overview of Default roles for Tanzu Application Platform	1221
Default roles	1221
Working with roles using the RBAC CLI plug-in	1222
Disclaimer	1222

Set up authentication for your Tanzu Application Platform deployment	1222
Tanzu Kubernetes Grid	1222
Set up authentication for your Tanzu Application Platform deployment	1222
Tanzu Kubernetes Grid	1223
Install Pinniped on Tanzu Application Platform	1223
Prerequisites	1223
Environment planning	1223
Install Pinniped Supervisor by using Let's Encrypt	1224
Create Certificates (letsencrypt or cert-manager)	1224
Create Ingress resources	1225
Create the pinniped-supervisor configuration	1226
Apply the resources	1227
Switch to production issuer (letsencrypt or cert-manager)	1227
Install Pinniped Supervisor Private CA	1228
Create Certificate Secret	1229
Create Ingress resources	1229
Create the pinniped-supervisor configuration	1230
Apply the resources	1231
Install Pinniped Concierge	1231
Log in to the cluster	1232
Integrate your Azure Active Directory	1232
Integrate Azure AD with a new or existing AKS without Pinniped	1232
Prerequisites	1232
Set up a platform operator	1233
Set up a Tanzu Application Platform default role group	1233
Set up kubeconfig	1234
Integrate Azure AD with Pinniped	1234
Prerequisites	1234
Set up the Azure AD app	1234
Set up the Tanzu Application Platform default role group	1236
Set up kubeconfig	1236
Role descriptions for Tanzu Application Platform	1236
app-editor	1237
app-viewer	1237
app-operator	1237
service-operator	1237
workload	1237
deliverable	1238

Role descriptions for Tanzu Application Platform	1238
app-editor	1238
app-viewer	1238
app-operator	1238
service-operator	1238
workload	1239
deliverable	1239
Detailed role permissions for Tanzu Application Platform	1239
Native Kubernetes Resources	1239
apps.tanzu.vmware.com/aggregate-to-app-viewer: "true"	1239
apps.tanzu.vmware.com/aggregate-to-app-operator: "true"	1239
App Accelerator	1239
apps.tanzu.vmware.com/aggregate-to-app-viewer: "true"	1239
apps.tanzu.vmware.com/aggregate-to-app-operator: "true"	1240
Cartographer	1240
apps.tanzu.vmware.com/aggregate-to-app-editor: "true"	1240
apps.tanzu.vmware.com/aggregate-to-app-viewer: "true"	1240
apps.tanzu.vmware.com/aggregate-to-app-viewer-cluster-access: "true"	1240
apps.tanzu.vmware.com/aggregate-to-app-operator-cluster-access	1240
Cloud Native Runtimes	1240
apps.tanzu.vmware.com/aggregate-to-app-viewer: "true"	1240
apps.tanzu.vmware.com/aggregate-to-app-operator: "true"	1241
Convention Service	1241
apps.tanzu.vmware.com/aggregate-to-app-viewer: "true"	1241
apps.tanzu.vmware.com/aggregate-to-app-viewer-cluster-access: "true"	1241
apps.tanzu.vmware.com/aggregate-to-app-operator-cluster-access	1241
Developer Conventions	1241
apps.tanzu.vmware.com/aggregate-to-app-editor: "true"	1241
OOTB Templates	1242
apps.tanzu.vmware.com/aggregate-to-app-viewer: "true"	1242
apps.tanzu.vmware.com/aggregate-to-workload: "true"	1242
apps.tanzu.vmware.com/aggregate-to-deliverable: "true"	1243
Service Bindings	1243
apps.tanzu.vmware.com/aggregate-to-app-viewer: "true"	1243
Services Toolkit	1243
apps.tanzu.vmware.com/aggregate-to-app-viewer: "true"	1243
apps.tanzu.vmware.com/aggregate-to-app-viewer-cluster-access: "true"	1243
apps.tanzu.vmware.com/aggregate-to-app-operator: "true"	1243
apps.tanzu.vmware.com/aggregate-to-app-operator-cluster-access	1244
Source Controller	1244
apps.tanzu.vmware.com/aggregate-to-app-viewer: "true"	1244

Supply Chain Security Tools — Scan	1244
apps.tanzu.vmware.com/aggregate-to-app-viewer: "true"	1244
apps.tanzu.vmware.com/aggregate-to-app-operator: "true"	1244
Tanzu Build Service	1244
apps.tanzu.vmware.com/aggregate-to-app-editor: "true"	1244
apps.tanzu.vmware.com/aggregate-to-app-viewer: "true"	1244
apps.tanzu.vmware.com/aggregate-to-app-viewer-cluster-access: "true"	1244
apps.tanzu.vmware.com/aggregate-to-app-operator: "true"	1245
apps.tanzu.vmware.com/aggregate-to-app-operator-cluster-access	1245
Tekton	1245
apps.tanzu.vmware.com/aggregate-to-app-viewer: "true"	1245
apps.tanzu.vmware.com/aggregate-to-app-viewer-cluster-access: "true"	1245
apps.tanzu.vmware.com/aggregate-to-app-operator: "true"	1245
apps.tanzu.vmware.com/aggregate-to-app-operator-cluster-access	1245
Bind a user or group to a default role	1245
Prerequisites	1245
Install the Tanzu Application Platform RBAC CLI plug-in	1246
(Optional) Use a different kubeconfig location	1246
Add the specified user or group to a role	1247
Get a list of users and groups from a role	1247
Remove the specified user or group from a role	1247
Error logs	1247
Troubleshooting	1249
Log in to Tanzu Application Platform by using Pinniped	1249
Download the Pinniped CLI	1249
Generate and distribute kubeconfig to users	1249
Login with the provided kubeconfig	1250
Additional resources about Tanzu Application Platform authentication and authorization	1250
Install	1250
Additional resources about Tanzu Application Platform authentication and authorization	1250
Install	1250
Install default roles independently for your Tanzu Application Platform	1251
Prerequisites	1251
Install	1251
Overview of Bitnami Services	1252
Getting started	1252

Overview of Bitnami Services	1252
Getting started	1252
Install Bitnami Services	1253
Prerequisites	1253
Install Bitnami Services	1253
Bitnami Services tutorials	1254
Work with Bitnami Services	1254
About this tutorial	1254
Prerequisites	1254
Concepts	1254
Procedure	1255
Step 1: Discover the services	1255
Step 2: Claim a service	1256
Step 3: Bind the claim to a workload	1257
Bitnami Services how-to guides	1257
Configure private registry and VMware Tanzu Application Catalog integration for Bitnami Services	1257
Prerequisites	1258
Procedure	1258
Known issue	1259
Workaround	1259
Obtain credentials for VMware Tanzu Application Catalog integration with Bitnami Services	1259
Prerequisites	1259
Obtain the Helm chart repository for VMware Tanzu Application Catalog	1259
Obtain pull credentials for VMware Tanzu Application Catalog	1260
Troubleshoot Bitnami Services	1261
Private registry or VMware Tanzu Application Catalog configuration does not take effect	1261
Bitnami Services reference	1261
Dependencies for Bitnami Services	1261
Package values for Bitnami Services	1262
Globals	1262
MySQL	1263
PostgreSQL	1264
RabbitMQ	1264
Redis	1265

MongoDB	1266
Kafka	1266
Version matrix for Bitnami Services	1267
Overview of Cartographer Conventions	1267
Overview	1268
About applying conventions	1268
Applying conventions by using image metadata	1268
Applying conventions without using image metadata	1268
Overview of Cartographer Conventions	1269
Overview	1269
About applying conventions	1269
Applying conventions by using image metadata	1269
Applying conventions without using image metadata	1270
Install Cartographer Conventions	1270
Create conventions with Cartographer Conventions	1270
Introduction	1270
Convention server	1271
How the convention server works	1271
The convention controller	1272
How the convention services's controller works	1272
Getting started	1272
Prerequisites	1273
Define convention criteria	1273
Define the convention behavior	1276
Matching criteria by labels or annotations	1276
Matching criteria by environment variables	1277
Matching criteria by image metadata	1277
Configure and install the convention server	1277
Deploy a convention server	1280
Next Steps	1282
Troubleshoot Cartographer Conventions	1282
No server in the cluster	1283
Symptoms	1283
Cause	1283
Solution	1283
Server with wrong certificates configured	1283
Symptoms	1283
Cause	1283

Solution	1283
Server fails when processing a request	1284
Symptoms	1284
Cause	1284
Solution	1284
Connection refused because of an unsecured connection	1285
Symptoms	1285
Cause	1286
Solution	1286
A self-signed certificate authority (CA) is not propagated to Convention Service	1286
Symptoms	1286
Cause	1286
Solution	1286
No imagePullSecrets configured	1287
Symptoms	1287
Cause	1287
Solution	1287
Convention Service Resources for Cartographer Conventions	1287
Overview	1287
Collecting Logs from the Controller	1289
Convention Service Resources for Cartographer Conventions	1290
Overview	1290
Collecting Logs from the Controller	1292
ImageConfig for Cartographer Conventions	1294
Overview	1294
PodConventionContextSpec for Cartographer Conventions	1295
PodConventionContextStatus for Cartographer Conventions	1295
Overview	1295
PodConventionContext for Cartographer Conventions	1296
Overview	1296
PodConventionContext Objects	1297
PodConventionContext Structure	1297
ClusterPodConvention for Cartographer Conventions	1298
Overview	1298
Define conventions	1298
PodIntent for Cartographer Conventions	1298

BOM for Cartographer Conventions	1299
Overview	1299
Structure	1299
Overview of cert-manager	1299
Overview of cert-manager	1300
Install cert-manager	1300
ACME challenges	1303
HTTP01 challenges can fail	1303
Overview of Cloud Native Runtimes	1304
Overview of Cloud Native Runtimes	1304
Install Cloud Native Runtimes	1304
Prerequisites	1305
Install	1305
Overview of Contour	1308
Overview of Contour	1308
Install Contour	1308
Configure Cipher Suites and TLS version in Contour	1314
Configure Contour to suit your cluster size	1315
Smaller Clusters	1315
Larger Clusters	1315
Configuring Envoy as a Deployment	1315
Configure Contour to propagate header with Domain Mapping	1316
Overview of Crossplane	1316
Crossplane with Tanzu Application Platform	1316
Getting started	1316
Overview of Crossplane	1317
Crossplane with Tanzu Application Platform	1317
Getting started	1317
Install Crossplane	1318
Prerequisites	1318
Install Crossplane	1318

Crossplane how-to guides	1319
Use your existing Crossplane installation	1319
About installing the Crossplane package	1319
Exclude the Crossplane package from the installation	1319
Delete Crossplane resources when you uninstall Tanzu Application Platform	1319
About deleting Crossplane resources	1320
Override the default retention behavior	1320
Troubleshoot Crossplane	1320
Resource already exists error when installing Crossplane	1320
Crossplane Providers cannot communicate with systems using a custom CA	1321
The validatingwebhookconfiguration is not removed when you uninstall the Crossplane Package	1322
Crossplane component fails to reconcile during upgrade	1322
Crossplane reference	1323
Package values for Crossplane	1323
Tanzu Application Platform configuration	1323
Standard Crossplane configuration	1324
Version matrix for Crossplane	1328
Crossplane limitations	1329
Cluster performance degradation due to a large number of CRDs	1329
Overview of Developer Conventions	1329
Prerequisites	1329
Features	1329
Enabling Live Updates	1329
Enabling debugging	1330
Next steps	1330
Overview of Developer Conventions	1330
Prerequisites	1330
Features	1331
Enabling Live Updates	1331
Enabling debugging	1331
Next steps	1332
Install Developer Conventions	1332
Prerequisites	1332
Install	1332

Resource limits	1333
Uninstall	1333
Run Developer Conventions on an OpenShift cluster	1333
Overview of Eventing	1334
Overview of Eventing	1334
Install Eventing	1334
Prerequisites	1334
Install	1334
Overview of Flux CD Source Controller	1336
Overview of Flux CD Source Controller	1336
Install Flux CD Source Controller	1336
Prerequisites	1337
Configuration	1337
Installation	1337
Try fluxcd-source-controller	1338
Documentation	1339
Use Flux CD Source Controller	1339
Overview of Learning Center for Tanzu Application Platform	1340
Use cases	1340
Use case requirements	1341
Platform architectural overview	1341
Next steps	1342
Overview of Learning Center for Tanzu Application Platform	1343
Use cases	1343
Use case requirements	1344
Platform architectural overview	1344
Next steps	1346
Install Learning Center	1346
Prerequisites	1346
Install Learning Center	1346
Install the Self-Guided Tour Training Portal and Workshop	1348
Supported Learning Center Values Configuration	1349
About Learning Center workshops	1350

Get started with Learning Center	1353
Installing Learning Center	1353
Get started	1353
Get started with Learning Center	1353
Installing Learning Center	1353
Get started	1354
Install and configure the Learning Center operator	1354
Installing and setting up Learning Center operator	1354
Cluster pod security policies	1355
Specifying the ingress domain	1355
Set the environment variable manually	1356
Enforcing secure connections	1356
Configuration YAML	1356
Create the TLS secret manually	1357
Specifying the ingress class	1357
Configuration YAML	1357
Set the environment variable manually	1357
Trusting unsecured registries	1358
Get started with Learning Center workshops	1358
Creating the workshop environment	1358
Requesting a workshop instance	1359
Deleting the workshop instance	1360
Deleting the workshop environment	1360
Get started with Learning Center training portals	1360
Working with multiple workshops	1361
Loading the workshop definition	1361
Creating the workshop training portal	1362
Accessing workshops via the web portal	1363
Deleting the workshop training portal	1365
Delete Learning Center	1365
Local install guides	1366
Local install guides	1366
Install Learning Center on Kind	1366
Prerequisites	1366
Kind cluster creation	1367
Ingress controller with DNS	1367
Install carvel tools	1367

Install Tanzu package repository	1368
Create a configuration YAML file for Learning Center package	1369
Using a nip.io DNS address	1369
Install Learning Center package onto a Kubernetes cluster	1370
Install workshop tutorial package onto a Kubernetes cluster	1370
Run the workshop	1370
Trusting insecure registries	1370
Install Learning Center on Minikube	1371
Trusting insecure registries	1372
Prerequisites	1372
Ingress controller with DNS	1372
Install carvel tools	1373
Install Tanzu package repository	1373
Create a configuration YAML file for the Learning Center package	1374
Using a nip.io DNS address	1374
Install Learning Center package onto a minikube cluster	1375
Install workshop tutorial package onto a minikube cluster	1375
Run the workshop	1375
Working with large images	1375
Limited resource availability	1375
Storage provisioner issue	1376
Create workshops for Learning Center	1376
Create workshops for Learning Center	1376
Configure your Learning Center workshop	1377
Specifying structure of the content	1377
Specifying the runtime configuration	1378
Next steps	1379
Create the image for your Learning Center workshop	1379
Templates for creating a workshop	1379
Workshop content directory layout	1380
Directory for workshop exercises	1381
Working on your Learning Center workshop content	1381
Deactivating reserved sessions	1381
Live updates to the content	1382
Custom workshop image changes	1383
Custom workshop image overlay	1383
Changes to workshop definition	1384
Local build of workshop image	1384

Build an image for your Learning Center workshop	1385
Structure of the Dockerfile	1385
Custom workshop base images	1385
Installing extra system packages	1386
Installing third-party packages	1386
Writing instructions for your Learning Center workshop	1387
Annotation of executable commands	1387
Annotation of text to be copied	1388
Extensible clickable actions	1389
Supported workshop editor	1391
Clickable actions for the dashboard	1391
Clickable actions for the editor	1392
Clickable actions for file download	1394
Clickable actions for the examiner	1395
Clickable actions for sections	1397
Overriding title and description	1398
Escaping of code block content	1398
Interpolation of data variables	1398
Adding custom data variables	1399
Passing environment variables	1400
Handling embedded URL links	1400
Conditional rendering of content	1401
Embedding custom HTML content	1401
Automate your Learning Center workshop runtime	1402
Predefined environment variables	1402
Running steps on container start	1403
Running background applications	1403
Terminal user shell environment	1404
Overriding terminal shell command	1404
Add presenter slides to your Learning Center workshop	1405
Use reveal.js presentation tool	1405
Use a PDF file for presenter slides	1405
Requirements for Learning Center in an air-gapped environment	1405
Workshop yaml changes	1405
Self-signed certificates	1405
Internet dependencies	1406
Define custom resources for Learning Center	1406
Workshop definition resource	1406

Workshop environment resource	1407
Workshop request resource	1407
Workshop session resource	1408
Training portal resource	1408
System profile resource	1408
Loading the workshop CRDs	1409
Define custom resources for Learning Center	1409
Workshop definition resource	1409
Workshop environment resource	1410
Workshop request resource	1410
Workshop session resource	1411
Training portal resource	1411
System profile resource	1412
Loading the workshop CRDs	1412
Configure the Workshop resource	1412
Workshop title and description	1412
Downloading workshop content	1414
Container image for the workshop	1416
Setting environment variables	1417
Overriding the memory available	1418
Mounting a persistent volume	1418
Resource budget for namespaces	1419
Patching workshop deployment	1421
Creation of session resources	1422
Overriding default role-based access control (RBAC) rules	1423
Running user containers as root	1425
Creating additional namespaces	1425
Shared workshop resources	1428
Workshop pod security policy	1429
Custom security policies for user containers	1431
Defining additional ingress points	1432
External workshop instructions	1434
Deactivating workshop instructions	1435
Enabling the Kubernetes console	1435
Enabling the integrated editor	1436
Enabling workshop downloads	1437
Enabling the test examiner	1437
Enabling session image registry	1438
Enabling ability to use Docker	1439
Enabling WebDAV access to files	1441

Customizing the terminal layout	1442
Adding custom dashboard tabs	1442
Configure the WorkshopEnvironment resource	1443
Specifying the workshop definition	1443
Overriding environment variables	1444
Overriding the ingress domain	1445
Controlling access to the workshop	1446
Overriding the login credentials	1447
Additional workshop resources	1447
Creation of workshop instances	1448
Configure the WorkshopRequest resource	1449
Specifying workshop environment	1449
Specifying required access token	1450
Configure the TrainingPortal resource	1450
Specifying the workshop definitions	1450
Limit the number of sessions	1451
Capacity of individual workshops	1451
Set reserved workshop instances	1452
Override initial number of sessions	1452
Setting defaults for all workshops	1453
Set caps on individual users	1453
Expiration of workshop sessions	1454
Updates to workshop environments	1455
Override the ingress domain	1456
Override the portal host name	1457
Set extra environment variables	1458
Override portal credentials	1458
Control registration type	1459
Specify an event access code	1460
Make a list of workshops public	1460
Use an external list of workshops	1461
Override portal title and logo	1461
Allow the portal in an iframe	1462
Collect analytics on workshops	1462
Track using Google Analytics	1464
Configure the SystemProfile resource	1465
Operator default system profile	1465
Defining configuration for ingress	1465
Defining container image registry pull secrets	1466

Defining storage class for volumes	1466
Defining storage group for volumes	1467
Restricting network access	1468
Running Docker daemon rootless	1468
Overriding network packet size	1469
Image registry pull through cache	1470
Setting default access credentials	1471
Overriding the workshop images	1471
Tracking using Google Analytics	1472
Overriding styling of the workshop	1473
Additional custom system profiles	1474
Configure the WorkshopSession resource	1474
Specifying the session identity	1474
Specifying the login credentials	1475
Specifying the ingress domain	1475
Setting the environment variables	1476
Enable anonymous access to a Learning Center training portal	1477
Enabling anonymous access	1477
Triggering workshop creation	1478
Enable anonymous access to a Learning Center training portal	1478
Enabling anonymous access	1479
Triggering workshop creation	1479
Use the Learning Center workshop catalog	1480
Listing available workshops	1480
Use session management for your Learning Center workshops	1481
Deactivating portal user registration	1482
Requesting a workshop session	1482
Associating sessions with a user	1483
Listing all workshop sessions	1484
Use client authentication for Learning Center	1485
Querying the credentials	1485
Requesting an access token	1486
Refreshing the access token	1486
Troubleshoot Learning Center	1487
Training portal stays in pending state	1487
image-policy-webhook-service not found	1487

Updates to Tanzu Application Platform values file not reflected in Learning Center Training Portal	1487
Increase your cluster's resources	1488
Kubernetes Api Timeout error	1488
No URL returned to your trainingportal	1489
Known issues for Learning Center	1489
Mitigation for CVE-2023-26114	1489
Overview of Local Source Proxy	1490
Overview of Local Source Proxy	1490
Design of Local Source Proxy	1491
Prerequisites for Local Source Proxy	1493
Install Local Source Proxy	1496
Prerequisites	1496
Install	1496
Create the SecretExport resource	1497
Customize the installation	1498
Override default RBAC permissions to access the proxy service	1498
Override default CPU and memory limits for controller pods	1498
Use AWS Identity and Access Management (IAM) roles for ECR	1499
Increase or decrease the number of replicas	1499
Specify CA certificate data for registries that use self-signed certificates	1499
Troubleshoot Local Source Proxy	1500
View Local Source Proxy server logs	1500
Symptom	1500
Solution	1500
View Apps CLI health messages	1500
Symptom	1500
Solution	1500
User does not have RBAC permission to list services	1500
Symptom	1500
Cause	1501
Solution	1501
Missing repository in Tanzu Application Platform values	1501
Symptom	1501
Cause	1501
Solution	1501
Missing or misconfigured registry secret	1501

Symptom	1501
Cause	1502
Solution	1502
Invalid credentials	1502
Symptom	1502
Cause	1503
Solution	1503
Local Source Proxy doesn't automatically detect changes to podspec	1503
Symptom	1503
Cause	1503
Solution	1503
Error: unknown command "lsp" for "apps"	1503
Symptom	1503
Cause	1503
Solution	1504
Error: i/o timeout	1504
Symptom	1504
Cause	1504
Solution	1504
Reference for Local Source Proxy	1504
Default resources	1504
Overview of Namespace Provisioner	1505
Description	1505
Modes	1505
Provisioner Carvel application	1506
Desired namespaces	1507
Namespace Provisioner controller	1507
Overview of Namespace Provisioner	1507
Description	1508
Modes	1508
Provisioner Carvel application	1509
Desired namespaces	1509
Namespace Provisioner controller	1510
Get started with Namespace Provisioner	1510
Provision developer namespaces in Namespace Provisioner	1511
Prerequisite	1511
Manage a list of developer namespaces	1511
Enable additional users with Kubernetes RBAC	1513

Customize Namespace Provisioner installation	1513
Add additional resources to your namespaces from your GitOps repository	1514
Adjust sync period of Namespace Provisioner	1515
Import user defined secrets in YAML format as ytt data.values	1516
Use AWS IAM roles	1517
Apply default parameters to all namespaces	1517
Import overlay secrets	1518
Set up Out of the Box Supply Chains in Namespace Provisioner	1521
Out of the Box Supply Chain Basic	1521
Out of the Box Supply Chain with Testing	1522
Add Java Tekton Pipelines to your developer namespace	1523
Out of the Box Supply Chain with Testing and Scanning	1524
Add Java Tekton Pipelines Grype Scan Policy to your developer namespace	1525
Namespace Provisioner use cases and examples	1527
Use multiple Tekton pipelines and scan policies in the same namespace in Namespace Provisioner	1527
Add Tekton pipelines and scan policies using namespace parameters in Namespace Provisioner	1529
Work with private Git repositories in Namespace Provisioner	1533
Git Authentication for using a private Git repository	1533
Create the Git Authentication secret in tap-namespace-provisioning namespace	1533
Import from another namespace	1534
Git Authentication for Private Repository for Workloads and Supply chain	1535
Customize default resources in Namespace Provisioner	1539
Deactivate Grype install	1539
DeDeactivate Grype for all namespaces	1539
DeDeactivate Grype for a specific namespace	1539
Customize service accounts	1539
Update ServiceAccount for all namespaces	1541
Update ServiceAccount for a specific namespace	1541
Customize Limit Range defaults	1543
Set or Update LimitRange defaults for all namespaces	1543
Set or Update LimitRange defaults for a specific namespace	1543
Deactivate LimitRange Setup	1545
Deactivate for all namespaces	1545
Deactivate for a specific namespace	1545
Install multiple scanners in the developer namespace in Namespace Provisioner	1546

Apply ScanTemplate overlays in air-gapped environments in Namespace Provisioner	1548
Work with Git repositories in air-gapped environments with Namespace Provisioner	1549
Git authentication	1549
Create the Git authentication secret in tap-namespace-provisioning namespace	1549
Import from another namespace	1551
Git authentication for workloads and supply chain	1552
Troubleshoot Namespace Provisioner	1557
Air-gapped installation	1557
View controller logs	1557
Provisioner application error	1557
Common errors	1557
Namespace selector malformed	1557
Debugging ytt templating errors in additional sources	1558
Unable to delete namespace	1558
Namespace Provisioner reference	1559
Known limitations and issues in Namespace Provisioner	1559
Default resources	1559
Customize namespaces in Namespace Provisioner	1560
Parameter key	1560
Reserved Namespace Parameters	1561
Overview of Service Bindings	1562
Supported service binding specifications	1562
Overview of Service Bindings	1562
Supported service binding specifications	1562
Install Service Bindings	1563
Prerequisites	1563
Install Service Bindings	1563
Troubleshoot Service Bindings	1564
Collect logs	1564
Service Bindings resource specification	1566
Overview of Services Toolkit	1566
Capabilities	1567

Getting started	1567
How this documentation is organized	1567
Overview of Services Toolkit	1568
Capabilities	1568
Getting started	1568
How this documentation is organized	1568
Install Services Toolkit	1569
Prerequisites	1569
Install Services Toolkit	1569
Services Toolkit concepts	1570
The four levels of service consumption in Tanzu Application Platform	1570
Level 1 - direct bindings	1570
Level 2 - resource claims	1571
Level 3 - class claims and pool-based classes	1572
Level 4 - class claims and provisioner-based classes (aka "Dynamic Provisioning")	1572
Summary	1573
Class claims compared to resource claims	1574
Similarities	1574
Using a ResourceClaim	1574
Using a ClassClaim	1575
Tutorials	1575
Set up dynamic provisioning of service instances	1575
About this tutorial	1575
Prerequisites	1576
Scenario	1576
Concepts	1576
Procedure	1577
Step 1: Install an operator	1577
Step 2: Create a CompositeResourceDefinition	1578
About the CompositeResourceDefinition	1579
Step 3: Create a Crossplane Composition	1580
About the Composition	1583
About .spec.compositeTypeRef	1583
About .spec.resources	1583
The Object managed resource	1583
The patches section	1584
The readinessChecks section	1585

The namespace	1586
Step 4: Creating a provisioner-based class	1586
Step 5: Configure supporting RBAC	1587
Step 6: Verify your configuration	1588
Working with Bitnami Services	1589
Integrate cloud services into Tanzu Application Platform	1589
About this tutorial	1589
Concepts	1589
Procedure	1590
Step 1: Install a Provider	1590
Step 2: Create a CompositeResourceDefinition	1591
Step 3: Create a Composition	1591
Step 4: Create a provisioner-based ClusterInstanceClass	1591
Step 5: Configure RBAC	1591
Step 6: Verify your integration	1592
Abstracting service implementations behind a class across clusters	1592
About this tutorial	1592
Prerequisites	1592
Scenario	1593
Concepts	1593
Procedure	1594
Step 1: Set up the run-test cluster	1594
Step 2: Set up the run-production cluster	1594
Step 3: Create the class	1595
Step 4: Create and promote the workload and class claim	1596
Use direct secret references	1597
About this tutorial	1598
Prerequisites	1598
Create a binding-compatible secret	1598
Services Toolkit how-to guides	1600
Authorize users and groups to claim from provisioner-based classes	1600
Authorize all users with the app-operator user role to claim from any namespace	1601
Authorize a user to claim from a specific namespace	1601
Revoke default authorization for claiming from the Bitnami Services classes	1602
Configure dynamic provisioning of AWS RDS service instances	1603
Prerequisites	1603
Configure dynamic provisioning	1603

Install the AWS Provider for Crossplane	1603
Create a CompositeResourceDefinition	1605
Create a Composition	1606
Make the service discoverable	1607
Configure RBAC	1608
Verify your configuration	1608
Configure dynamic provisioning of VMware SQL with Postgres for Kubernetes service instances	1608
Prerequisites	1609
Configure dynamic provisioning	1609
Install the VMware Postgres Operator	1609
Set up the namespace	1609
Create a CompositeResourceDefinition	1610
Create a Composition	1610
Make the service discoverable	1613
Configure RBAC	1614
Verify your configuration	1614
Troubleshoot Services Toolkit	1615
Debug ClassClaim and provisioner-based ClusterInstanceClass	1615
Prerequisites	1615
Step 1: Inspect the ClassClaim, ClusterInstanceClass, and CompositeResourceDefinition	1615
Step 2: Inspect the Composite Resource, the Managed Resources and the underlying resources	1616
Step 3: Inspect the events log	1616
Step 4: Inspect the secret	1616
Step 5: Contact support	1617
Unexpected error if additionalProperties is true in a CompositeResourceDefinition	1617
Cannot claim from clusterinstanceclass when creating a ClassClaim	1617
Services Toolkit reference	1618
Services Toolkit API documentation	1618
ClusterInstanceClass and ClassClaim	1618
ClusterInstanceClass	1618
ClassClaim	1620
ResourceClaim and ResourceClaimPolicy	1622
ResourceClaim	1622
ResourceClaimPolicy	1623
InstanceQuery	1624
InstanceQuery	1624

RBAC	1624
Aggregation labels	1624
servicebinding.io/controller: "true"	1624
services.tanzu.vmware.com/aggregate-to-provider-kubernetes: "true"	1625
services.tanzu.vmware.com/aggregate-to-provider-helm: "true"	1625
The claim verb for ClusterInstanceClass	1626
Tanzu Service CLI plug-in reference	1626
tanzu service class	1627
tanzu service class list	1627
tanzu service class get	1627
tanzu service class-claim	1628
tanzu service class-claim create	1628
tanzu service class-claim get	1628
tanzu service class-claim delete	1629
tanzu service class-claim list	1629
tanzu service resource-claim	1630
tanzu service resource-claim create	1630
tanzu service resource-claim get	1631
tanzu service resource-claim delete	1631
tanzu service resource-claim list	1631
tanzu service claimable	1632
tanzu service claimable list	1632
Services Toolkit terminology and user roles	1632
Terminology	1632
Service	1633
Service resource	1633
Provisioned service	1633
Service binding	1633
Service instance	1633
Service instance class	1634
Claim	1634
Claimable service instance	1635
Dynamic provisioning	1635
Service resource life cycle API	1635
Service cluster	1635
Workload cluster	1635
User roles	1635
Application developer (AD)	1636
Application operator (AO)	1636
Service operator (SO)	1636

Example Compositions	1636
AWS RDS example Composition	1636
Azure Flexible Server example Composition	1637
GCP Cloud SQL example Composition	1639
Services Toolkit limitations	1640
Cannot claim and bind to the same service instance from across multiple namespaces	1640
Overview of Source Controller	1640
Overview of Source Controller	1641
Install Source Controller	1641
Prerequisites	1642
Install	1642
Troubleshoot Source Controller	1644
Collecting Logs from Source Controller Manager	1644
Source Controller reference	1645
ImageRepository [Deprecated]	1645
MavenArtifact	1645
Overview of Spring Boot conventions	1646
Overview of Spring Boot conventions	1647
Install Spring Boot conventions	1648
Prerequisites	1648
Install Spring Boot conventions	1648
Configure and access Spring Boot actuators in Tanzu Application Platform	1649
Workload-level configuration	1649
Platform-level configuration	1650
Enable Application Live View for Spring Boot applications	1651
Verify the applied labels and annotations	1652
List of Spring Boot conventions	1656
Set a JAVA_TOOL_OPTIONS property for a workload	1656
Spring Boot convention	1657
Spring boot graceful shut down convention	1658
Spring Boot web convention	1658
Spring Boot Actuator convention	1659
Spring Boot Actuator Probes convention	1661

Service intent conventions	1662
Example	1663
Troubleshoot Spring Boot conventions	1664
Collect logs	1664
Overview of Spring Cloud Gateway for Kubernetes	1665
Overview of Spring Cloud Gateway for Kubernetes	1665
Install Spring Cloud Gateway for Kubernetes	1665
Prerequisites	1665
Install	1665
Overview of Supply Chain Choreographer for Tanzu	1667
Overview	1667
Out of the Box Supply Chains	1667
Overview of Supply Chain Choreographer for Tanzu	1667
Overview	1667
Out of the Box Supply Chains	1668
Install Supply Chain Choreographer	1668
Prerequisites	1669
Install	1669
Out of the Box Supply Chain Basic for Supply Chain Choreographer	1669
Prerequisites	1670
Developer Namespace	1670
Registries Secrets	1670
ServiceAccount	1671
RoleBinding	1672
Developer workload	1673
Out of the Box Supply Chain Basic for Supply Chain Choreographer	1673
Prerequisites	1674
Developer Namespace	1674
Registries Secrets	1674
ServiceAccount	1675
RoleBinding	1675
Developer workload	1676
Install Out of the Box Supply Chain Basic for Supply Chain Choreographer	1677
Prerequisites	1677
Install	1677

Out of the Box Supply Chain with Testing for Supply Chain Choreographer	1680
Prerequisites	1680
Developer Namespace	1681
Updates to the developer Namespace	1681
Tekton/Pipeline	1681
Allow multiple Tekton pipelines in a namespace	1682
Developer Workload	1683
Out of the Box Supply Chain with Testing for Supply Chain Choreographer	1684
Prerequisites	1684
Developer Namespace	1685
Updates to the developer Namespace	1685
Tekton/Pipeline	1686
Allow multiple Tekton pipelines in a namespace	1686
Developer Workload	1688
Install Out of the Box Supply Chain with Testing for Supply Chain Choreographer	1688
Prerequisites	1689
Install	1689
Out of the Box Supply Chain with Testing and Scanning for Supply Chain Choreographer	1692
Prerequisites	1692
Developer namespace	1693
Updates to the developer namespace	1693
ScanPolicy	1694
ScanTemplate	1695
Enable storing scan results	1696
Allow multiple Tekton pipelines in a namespace	1696
Developer workload	1697
CVE triage workflow	1698
Scan Images using a different scanner	1698
Out of the Box Supply Chain with Testing and Scanning for Supply Chain Choreographer	1698
Prerequisites	1699
Developer namespace	1699
Updates to the developer namespace	1700
ScanPolicy	1700
ScanTemplate	1701
Enable storing scan results	1702

Allow multiple Tekton pipelines in a namespace	1702
Developer workload	1703
CVE triage workflow	1704
Scan Images using a different scanner	1704
Install Out of the Box Supply Chain with Testing and Scanning for Supply Chain Choreographer	1704
Install	1705
Out of the Box Templates for Supply Chain Choreographer	1708
Out of the Box Templates for Supply Chain Choreographer	1708
Install Out of the Box Templates for Supply Chain Choreographer	1709
Prerequisites	1709
Install	1709
Out of the Box Delivery Basic for Supply Chain Choreographer	1710
Prerequisites	1710
Using Out of the Box Delivery Basic	1710
More information	1711
Out of the Box Delivery Basic for Supply Chain Choreographer	1711
Prerequisites	1711
Using Out of the Box Delivery Basic	1712
More information	1712
Install Out of the Box Delivery Basic for Supply Chain Choreographer	1712
Prerequisites	1713
Install	1713
How-to guides for Supply Chain Choreographer for Tanzu	1714
How-to guides	1714
Out of the Box Supply Chain with testing on Jenkins for Supply Chain Choreographer	1714
Prerequisites	1714
Using the Out of the Box Jenkins Task	1715
Configuring a Jenkins job in an existing Jenkins Pipeline	1715
Example Jenkins Job	1715
Create a secret with authentication credentials	1716
Create a Tekton pipeline	1717
Patching the default Service Account	1718
Create a Developer Workload	1719
Building container images with Supply Chain Choreographer	1720

Methods for building container images	1720
Building from source with Supply Chain Choreographer	1721
Git source	1721
Private GitRepository	1722
HTTP(S) Basic-authentication and Token-based authentication	1723
HTTPS with a Custom CA Certificate	1724
SSH authentication	1724
How it works	1725
Workload parameters	1725
Local source	1725
Authentication	1726
Developer	1726
Supply chain components	1727
How it works	1727
Maven Artifact	1728
Maven Repository Secret	1728
Use Dockerfile-based builds with Supply Chain Choreographer	1729
Use Dockerfile-based builds with Supply Chain Choreographer	1729
OpenShift	1730
Tanzu Build Service integration for Supply Chain Choreographer	1731
Configure and deploy to multiple environments with custom parameters	1732
Overview	1733
Feature limits	1733
Using Carvel packages	1733
Using GitOps delivery with Flux CD	1733
Using GitOps delivery with Carvel App	1733
Using GitOps delivery with Argo CD	1733
Configuring blue-green deployment	1733
Configuring canary deployment	1733
Carvel Package Supply Chains (beta)	1734
Overview of the Carvel Package Supply Chains	1734
What do the Carvel Package Supply Chains Do?	1734
Installing the Carvel Package Supply Chains as an Operator	1736
Prerequisites	1736
Installation	1736
Verifying the Carvel Package Supply Chains are Installed	1738
Using the Carvel Package Supply Chains as a Developer	1738
Prerequisites	1738

Create a Workload	1738
Verify the Carvel Package was Created	1739
Git commit SHA in Package version	1739
Next Steps	1739
Use Gitops delivery with a Carvel app (beta)	1739
Prerequisites	1740
Set up run cluster namespaces	1740
Create Carvel PackageInstalls and secrets	1741
Create an app	1742
Verify applications	1743
Use Gitops delivery with Flux CD (beta)	1744
Prerequisites	1744
Set up run cluster namespaces	1744
Create Carvel PackageInstalls and secrets	1745
Create Flux CD GitRepository and Flux CD Kustomizations on the build cluster	1746
Verify installation	1748
Use Gitops delivery with Argo CD (beta)	1748
Prerequisites	1748
Set up run cluster namespaces	1749
Create Carvel PackageInstalls and secrets	1749
Create an Argo CD application on the Build cluster	1750
Verify installation	1752
Use blue-green deployment with Contour and PackageInstall for Supply Chain Choreographer (beta)	1752
Prerequisites	1752
Add HTTPProxy to the blue deployment	1752
Create the green deployment	1753
Divide traffic between the blue and green deployments	1754
Verify application	1757
Use canary deployment with Contour and Carvel packages for Supply Chain Choreographer (beta)	1757
Prerequisites	1757
How to use Contour ingress controller and Flagger to create a canary release	1758
References and further reading	1761
Use an existing image with Supply Chain Choreographer	1761
Requirements for prebuilt images	1761
Configure your workload to use a prebuilt image	1761
Examples	1762

Using a Dockerfile	1762
Using Spring Boot's build-image Maven target	1764
About Out of the Box Supply Chains	1764
Understanding the supply chain for a prebuilt image	1765
Use Git authentication with Supply Chain Choreographer	1767
HTTP	1767
HTTPS with a Custom CA Certificate	1768
SSH	1768
More information about Git	1770
Using Azure DevOps as a Git provider with your supply chains	1770
Overview	1771
Azure authentication	1771
Using Azure DevOps as a repository for committed code	1771
Azure DevOps example	1771
Using Azure DevOps as a GitOps repository	1772
GitOps write path example	1772
Gitops write path templates	1772
Using GitLab as a Git provider with your supply chains	1773
Overview	1773
Using GitLab as a repository for committed code	1773
GitLab example	1773
Using GitLab as a GitOps repository	1774
GitOps write path example	1774
GitLab read example	1775
GitLab over HTTPS with a custom CA certificate	1775
Author your supply chains	1776
Providing your own supply chain	1776
Providing your own templates	1777
Modifying an Out of the Box Supply Chain	1778
Example	1779
Modifying an Out of the Box Supply template	1780
Example	1780
Live modification of supply chains and templates	1781
Adding custom behavior to Supply Chains	1783
Reference guides for Supply Chain Choreographer for Tanzu	1783
Reference guides	1783
Events reference for Supply Chain Choreographer	1783
Events	1784

StampedObjectApplied	1784
StampedObjectRemoved	1784
ResourceOutputChanged	1784
ResourceHealthyStatusChanged	1784
Workload Reference for Supply Chain Choreographer	1784
Standard Fields	1785
Labels	1785
Parameters	1785
Service Account	1786
Supply chains for Supply Chain Choreographer	1787
Source-to-URL	1787
Purpose	1787
Resources	1787
source-provider	1787
image-provider	1787
Common resources	1787
Parameters provided to all resources	1788
Package	1788
More information	1788
Source-Test-to-URL	1788
Resources	1788
source-provider	1788
source-tester	1788
image-provider	1788
Common resources	1789
Parameters provided to all resources	1789
Package	1789
More information	1789
Source-Test-Scan-to-URL	1789
Resources	1789
source-provider	1789
source-tester	1790
source-scanner	1790
image-provider	1790
image-scanner	1790
Common resources	1790
Parameters provided to all resources	1790
Package	1791
More information	1791
Basic-Image-to-URL	1791

Resources	1791
image-provider	1791
Common resources	1791
Parameters provided to all resources	1791
Package	1791
More information	1791
Testing-Image-to-URL	1791
Resources	1792
image-provider	1792
Common resources	1792
Parameters provided to all resources	1792
Package	1792
More information	1792
Scanning-image-scan-to-URL	1792
Resources	1792
image-provider	1792
image-scanner	1793
Common resources	1793
Parameters provided to all resources	1793
Package	1793
More information	1793
Source-to-URL-Package (experimental)	1793
Purpose	1793
Resources	1793
source-provider	1793
image-provider	1794
carvel-package	1794
package-config-writer	1794
Common resources	1794
Parameters provided to all resources	1794
Package	1795
More information	1795
Basic-Image-to-URL-Package (experimental)	1795
Resources	1795
image-provider	1795
carvel-package	1795
package-config-writer	1795
Common resources	1795
Parameters provided to all resources	1796
Package	1796
More information	1796
Resources common to all OOTB supply chains	1796

config-provider	1796
app-config	1796
service-bindings	1796
api-descriptors	1796
config-writer	1796
deliverable	1797
Parameters provided by all supply chains to all resources	1797
Template reference for Supply Chain Choreographer	1797
source-template	1798
Purpose	1798
Used by	1798
Creates	1798
GitRepository	1798
Parameters	1798
Template reference for Supply Chain Choreographer	1798
More information	1798
ImageRepository	1799
Parameters	1799
More information	1799
MavenArtifact	1799
Parameters	1799
More information	1800
testing-pipeline	1800
Purpose	1800
Used by	1800
Creates	1801
Parameters	1801
More information	1801
source-scanner-template	1801
Purpose	1801
Used by	1801
Creates	1801
Parameters	1802
More information	1802
image-provider-template	1802
Purpose	1802
Used by	1802
Creates	1802
Parameters	1802
More information	1803

kpack-template	1803
Purpose	1803
Used by	1803
Creates	1803
Parameters	1803
More information	1804
kaniko-template	1804
Purpose	1804
Used by	1804
Creates	1805
Parameters	1805
More information	1805
image-scanner-template	1805
Purpose	1806
Used by	1806
Creates	1806
Parameters	1806
More information	1806
convention-template	1806
Purpose	1806
Used by	1806
Creates	1807
Parameters	1807
More information	1808
config-template	1808
Purpose	1808
Used by	1808
Creates	1808
Parameters	1808
More information	1808
worker-template	1808
Purpose	1808
Used by	1808
Creates	1809
Parameters	1809
More information	1809
server-template	1809
Purpose	1809
Used by	1809
Creates	1809
Parameters	1809
More information	1810

service-bindings	1810
Purpose	1810
Used by	1810
Creates	1810
Parameters	1810
More information	1811
api-descriptors	1811
Purpose	1811
Used by	1811
Creates	1811
Parameters	1811
More information	1811
config-writer-template	1812
Purpose	1812
Used by	1812
Creates	1812
Parameters	1812
More information	1814
config-writer-and-pull-requester-template	1814
Purpose	1814
Used by	1814
Creates	1814
Parameters	1814
More information	1816
deliverable-template	1816
Purpose	1816
Used by	1816
Creates	1816
Parameters	1816
More information	1818
external-deliverable-template	1818
Purpose	1818
Used by	1818
Creates	1818
Parameters	1819
More information	1820
delivery-source-template	1820
Purpose	1820
Used by	1820
Creates	1820
GitRepository	1820
Parameters	1821

More information	1821
ImageRepository	1821
Parameters	1821
More information	1821
app-deploy	1821
Purpose	1821
Used by	1822
Creates	1822
Parameters	1822
More information	1822
carvel-package (experimental)	1822
Purpose	1822
Used by	1822
Creates	1822
Parameters	1823
More information	1827
package-config-writer-template (experimental)	1827
Purpose	1827
Used by	1827
Creates	1827
Parameters	1827
More information	1829
package-config-writer-and-pull-requester-template (experimental)	1829
Purpose	1830
Used by	1830
Creates	1830
Parameters	1830
More information	1832
ClusterRunTemplate reference for Supply Chain Choreographer	1832
tekton-source-pipelinerun	1832
Purpose	1832
Used by	1832
Creates	1832
Inputs	1832
ClusterRunTemplate reference for Supply Chain Choreographer	1832
More information	1833
tekton-taskrun	1833
Purpose	1833
Used by	1833
Creates	1833

Inputs	1833
commit-and-pr-pipeline	1833
Purpose	1834
Used by	1834
Creates	1834
Inputs	1834
More information	1835
Delivery reference for Supply Chain Choreographer	1835
delivery-basic	1835
Purpose	1835
Resources	1835
source-provider	1835
Deployer	1835
Package	1835
More information	1835
Use Git with Supply Chain Choreographer	1835
Overview	1836
Supported Git Repositories	1836
Related Articles	1836
Use GitOps or RegistryOps with Supply Chain Choreographer	1836
GitOps	1837
Examples	1837
Deprecated parameters	1838
Examples	1839
Pull requests	1840
Authentication	1841
Authentication	1842
HTTP(S) Basic authentication or Token-based authentication	1842
SSH	1842
GitOps workload parameters	1843
Read more on Git	1844
RegistryOps	1844
Overview of Supply Chain Security Tools for VMware Tanzu - Policy Controller	1845
Overview of Supply Chain Security Tools for VMware Tanzu - Policy Controller	1846
Install Supply Chain Security Tools - Policy Controller	1847
Prerequisites	1847

Install	1848
Migration From Supply Chain Security Tools - Sign	1852
Enable Policy Controller on Namespaces	1852
Policy Controller ClusterImagePolicy	1853
Excluding Namespaces	1853
Specifying Public Keys	1853
Specifying Image Matching	1854
Specifying policy mode	1855
Configuring Supply Chain Security Tools - Policy	1855
Admission of Images	1855
Including Namespaces	1856
Create a ClusterImagePolicy resource	1856
images	1856
mode	1856
match	1857
authorities	1857
key	1857
keyless	1858
static.action	1859
Provide credentials for the package	1859
Provide secrets for authentication in your policy	1860
Verify your configuration	1860
Overview of Supply Chain Security Tools - Scan	1862
Overview	1862
Language support	1862
Use cases	1862
Supply Chain Security Tools - Scan features	1862
A Note on Vulnerability Scanners	1862
Missed CVEs	1863
False positives	1863
Overview of Supply Chain Security Tools - Scan	1864
Overview	1864
Language support	1864
Use cases	1864
Supply Chain Security Tools - Scan features	1865
A Note on Vulnerability Scanners	1865
Missed CVEs	1865
False positives	1865

Scan Types for Supply Chain Security Tools - Scan	1866
Source scan	1866
Adding Source Scan to the Test and Scan Supply Chain	1867
Container image scan	1868
Install Supply Chain Security Tools - Scan	1868
Prerequisites	1868
Configure properties	1869
Install	1871
Option 1: Install to multiple namespaces with the Namespace Provisioner	1871
Option 2: Install manually to each individual namespace	1871
Upgrade Supply Chain Security Tools - Scan	1874
Prerequisites	1875
General Upgrades for SCST - Scan	1875
Upgrading a scanner in all namespaces	1875
Installation by using Namespace Provisioner	1875
Manual installation	1875
Upgrade to Version v1.2.0	1876
Install another scanner for Supply Chain Security Tools - Scan	1879
Prerequisites	1879
Install	1879
Verify Installation	1881
Install scanner to multiple namespaces	1884
Configure Tanzu Application Platform Supply Chain to use new scanner	1884
Uninstall Scanner	1885
Other Available Scanner Integrations	1885
Prerequisites for Snyk Scanner for Supply Chain Security Tools - Scan (Beta)	1885
Prepare the Snyk Scanner configuration	1885
SCST - Store integration	1886
Sample ScanPolicy for Snyk in SPDX JSON format	1887
Prerequisites for Carbon Black Scanner for Supply Chain Security Tools - Scan (Beta)	1888
Prepare the Carbon Black Scanner configuration	1889
SCST - Store integration	1890
Using SCST - Store Integration	1890
Without SCST - Store Integration	1891
Sample ScanPolicy in CycloneDX format	1891

Prerequisites for Prisma Scanner for Supply Chain Security Tools - Scan (Alpha)	1892
Verify the latest alpha package version	1892
Relocate images to a registry	1892
Add the Prisma Scanner package repository	1893
Prepare the Prisma Scanner configuration	1894
Obtain Console URL and Access Keys and Token	1894
Access key and secret authentication	1895
Access Token Authentication	1896
SCST - Store integration	1897
Multiple Scanners installed	1897
Prisma Only Scanner Installed	1897
No Store Integration	1898
Prepare the ScanPolicy	1898
Sample ScanPolicy using Prisma Policies	1898
Sample ScanPolicy using Local Policies	1899
Install Prisma Scanner	1900
Self-Signed Registry Certificate	1900
Tanzu Application Platform Values Shared CA	1900
Secret within Developer Namespace	1901
Connect to Prisma through a Proxy	1901
Known Limits	1901
Install Trivy for Supply Chain Security Tools - Scan (alpha)	1901
Verify the latest alpha package version	1901
Relocate images to a registry	1902
Add Trivy package repository	1903
Prepare Trivy configuration	1903
SCST - Store integration	1905
Multiple scanners installed	1905
Trivy is the only scanner installed	1906
No store integration	1906
Prepare the ScanPolicy	1907
Install Trivy	1908
Air-gap configuration	1908
Relocate a Trivy database to your registry	1908
Use another Trivy version	1909
Use another Trivy Aqua plug-in version	1910
Integrate with the Aqua SaaS platform	1911
Self-signed registry certificate	1912
Spec reference	1913
About source and image scans	1913

About policy enforcement around vulnerabilities found	1914
Scan samples for Supply Chain Security Tools - Scan	1914
Scan samples for Supply Chain Security Tools - Scan	1914
Sample public image scan with compliance check for Supply Chain Security Tools - Scan	1914
Public image scan	1914
Define the ScanPolicy and ImageScan	1915
(Optional) Set up a watch	1916
Deploy the resources	1916
View the scan results	1916
Edit the ScanPolicy	1916
Clean up	1916
Sample public source code scan with compliance check for Supply Chain Security Tools - Scan	1917
Public source scan	1917
Run an example public source scan	1917
Sample private image scan for Supply Chain Security Tools - Scan	1919
Define the resources	1919
Set up target image pull secret	1919
Create the private image scan	1920
(Optional) Set up a watch	1920
Deploy the resources	1921
View the scan results	1921
Clean up	1921
View vulnerability reports	1921
Sample private source scan for Supply Chain Security Tools - Scan	1921
Define the resources	1921
(Optional) Set up a watch	1923
Deploy the resources	1923
View the scan status	1923
Clean up	1923
View vulnerability reports	1923
Sample public source scan of a blob for Supply Chain Security Tools - Scan	1923
Define the resources	1924
(Optional) Set up a watch	1924
Deploy the resources	1924
View the scan results	1924

Clean up	1924
View vulnerability reports	1924
Using Grype in air-gapped (offline) environments for Supply Chain Security Tools - Scan	1925
Host the Grype vulnerability database	1925
To enable Grype in offline air-gapped environments	1926
Configure Grype environmental variables	1926
Troubleshooting	1927
ERROR failed to fetch latest cli version	1927
Solution	1927
Database is too old	1928
Solution	1928
Vulnerability database is invalid	1929
Solution	1929
Debug Grype database in a cluster	1931
Grype package overlays are not applied to scantemplates created by Namespace Provisioner	1932
Triage and Remediate CVEs for Supply Chain Security Tools - Scan	1932
Confirm that Supply Chain stopped due to failed policy enforcement	1932
Triage	1932
Remediation	1932
Updating the affected component	1933
Amending the scan policy	1933
Observe Supply Chain Security Tools - Scan	1933
Observability	1933
Troubleshoot Supply Chain Security Tools - Scan	1933
Debugging commands	1933
Debugging Tekton TaskRun	1933
Debugging Scan pods	1934
Debugging SourceScan and ImageScan	1934
Debugging Scanning within a SupplyChain	1935
Viewing the Scan-Controller manager logs	1935
Restarting Deployment	1935
Troubleshooting scanner to MetadataStore configuration	1935
Insight CLI failed to post scan results to metadata store due to failed certificate verification	1935
Troubleshooting issues	1936
Source scan missing in supply chain	1936
Troubleshooting Grype in air gap Environments	1936
Missing target SSH secret	1937
Missing target image pull secret	1937

Deactivate Supply Chain Security Tools (SCST) - Store	1937
Resolving Incompatible Syft Schema Version	1937
Resolving incompatible scan policy	1938
Could not find CA in secret	1938
Blob Source Scan is reporting wrong source URL	1938
Resolving failing scans that block a Supply Chain	1939
Policy not defined in the Tanzu Developer Portal	1939
Lookup error when connecting to SCST - Store	1939
Sourcscan error with SCST - Store endpoint without a prefix	1939
Deprecated pre-v1.2 templates	1940
Incorrectly configured self-signed certificate	1940
Unable to pull scan controller and scanner images from a specified registry	1940
Grype database not available	1940
Scanner Pod restarts once in SCST - Scan v1.5.0 or later	1941

Troubleshoot Rego files with a scan policy for Supply Chain Security Tools - Scan 1941

Using the Rego playground	1941
Sample input in CycloneDX's XML re-encoded as JSON format	1941
Example input in SPDX JSON format	1944

Configure code repositories and image artifacts for Supply Chain Security Tools - Scan 1955

Prerequisite	1956
Deploy scan custom resources	1956
SourceScan	1956
ImageScan	1957

Configure code repositories and image artifacts for Supply Chain Security Tools - Scan 1959

Prerequisite	1959
Deploy scan custom resources	1959
SourceScan	1959
ImageScan	1960

Enforce compliance policy using Open Policy Agent 1962

Writing a policy template	1962
Rego file contract	1962
Define a Rego file for policy enforcement	1962
Further refine the Scan Policy for use	1964
Troubleshooting Rego files (Scan Policy)	1966
Enable Tanzu Developer Portal to view ScanPolicy Resource	1966
Deprecated Rego file Definition	1967

Create a ScanTemplate with Supply Chain Security Tools - Scan	1967
Overview	1967
Output Model	1968
ScanTemplate Structure	1968
Sample Outputs	1969
View scan status conditions for Supply Chain Security Tools - Scan	1970
Viewing scan status	1970
Overview of conditions	1970
Condition types for the scans	1970
Scanning	1970
Succeeded	1970
SendingResults	1970
PolicySucceeded	1970
Overview of CVECount	1971
Overview of MetadataURL	1971
Overview of Phase	1971
Overview of ScannedBy	1971
Overview of ScannedAt	1971
Troubleshoot Rego files with a scan policy for Supply Chain Security Tools - Scan	1971
Using the Rego playground	1972
Sample input in CycloneDX's XML re-encoded as JSON format	1972
Example input in SPDX JSON format	1975
Supply Chain Security Tools - Scan 2.0 (beta)	1986
Overview	1986
Integrating in to a supply chain	1987
Getting started with Scan 2.0	1987
Getting Started with Supply Chain Security Tools - Scan 2.0	1987
Install Supply Chain Security Tools - Scan 2.0 in a cluster	1987
Prerequisites	1987
Configure properties	1987
Install	1988
Configure service accounts and registry credentials	1989
(Optional) Set up your registry retention policy	1992
Add App Scanning to default Test and Scan supply chains	1992
Overview	1992
Prerequisites	1993
Integrate with OOTB Supply Chain	1993

Bring your own scanner with Supply Chain Security Tools - Scan 2.0	1993
Overview	1993
Prerequisites	1994
Bring your own scanner using an ImageVulnerabilityScan	1994
Customize an ImageVulnerabilityScan	1994
Configuration options	1995
Default environment	1996
Environment variables	1997
Retrieving an image digest	1997
Verifying an ImageVulnerabilityScan	1997
Overview	1997
Trigger and observe scanning	1998
Retrieve scan results	1998
Validating scan format	1998
Verifying an ImageVulnerabilityScan	1998
Author a ClusterImageTemplate for Supply Chain integration	1999
Prerequisites	2000
Create a ClusterImageTemplate	2000
Configure your custom ImageVulnerabilityScan samples for Supply Chain Security Tools - Scan	2003
ImageVulnerabilityScan samples	2003
Use custom ImageVulnerabilityScan samples	2003
Retrieving an image digest	2004
Configure a ImageVulnerabilityScan for Carbon Black	2004
Example secret	2004
Example ImageVulnerabilityScan	2005
Disclaimer	2006
Configure an ImageVulnerabilityScan for Snyk	2006
Example Secret	2006
Configure an ImageVulnerabilityScan for Prisma	2008
Example secret	2008
Example ImageVulnerabilityScan	2008
Configure an ImageVulnerabilityScan for Trivy	2010
Example ImageVulnerabilityScan	2010
Configure a ImageVulnerabilityScan for Grype	2010
Example ImageVulnerabilityScan	2010

Verify scanning with Supply Chain integration	2011
Create a workload	2011
Retrieve scan results	2012
Supply Chain Security Tools - Scan 2.0 Observability	2012
Scanning Steps	2012
Troubleshooting Supply Chain Security Tools - Scan 2.0	2013
Overview	2013
Viewing resources	2013
Debugging commands	2013
Debugging resources	2014
Debugging scan pods	2014
Viewing the Scan-Controller manager logs	2015
Troubleshooting issues	2015
Volume permission error	2015
Incompatible Tekton version	2015
Scan results empty	2016
Overview of Supply Chain Security Tools for VMware Tanzu - Sign	2016
Overview of Supply Chain Security Tools for Tanzu – Store	2016
Overview	2016
Using the Tanzu Insight CLI plug-in	2017
Multicluster configuration	2017
Integrating with Tanzu Developer Portal	2017
Additional documentation	2017
Overview of Supply Chain Security Tools for Tanzu – Store	2017
Overview	2017
Using the Tanzu Insight CLI plug-in	2018
Multicluster configuration	2018
Integrating with Tanzu Developer Portal	2018
Additional documentation	2018
Data models and concepts for Supply Chain Security Tools - Store	2018
Overview	2018
Software Bill of Material per build	2019
Vulnerability triage	2020
Configure your target endpoint and certificate for Supply Chain Security Tools - Store	2021
Overview	2021
Using Ingress	2022

Single-cluster setup	2022
Set the target	2022
Next Step	2023
Additional Resources	2023
Configure your access tokens for Supply Chain Security Tools - Store	2023
Setting the Access Token	2023
Additional Resources	2023
Security details for Supply Chain Security Tools - Store	2023
Application security	2024
TLS encryption	2024
Cryptographic algorithms	2024
Access controls	2024
Authentication	2024
Authorization	2024
Container security	2025
Non-root user	2025
Security scanning	2025
Static Application Security Testing (SAST)	2025
Software Composition Analysis (SCA)	2025
Artifact Metadata Repository (alpha/beta)	2025
AMR Observer (alpha)	2026
AMR CloudEvent Handler (beta)	2026
Known Issues	2026
Additional Resources	2026
Artifact Metadata Repository (alpha/beta)	2026
AMR Observer (alpha)	2026
AMR CloudEvent Handler (beta)	2027
Known Issues	2027
Additional Resources	2027
Artifact Metadata Repository architecture	2027
AMR Observer	2028
Watched resources	2028
ImageVulnerabilityScans	2028
ReplicaSet	2028
Configure Artifact Metadata Repository	2028
AMR Observer	2029
Artifact Metadata Repository (AMR) data model and concepts	2030

Overview	2030
AMR data models	2031
Apps	2031
Locations	2031
AMR GraphQL Querying	2031
Connecting to GraphQL playground	2031
Querying for locations	2032
Locations query arguments	2032
Locations fields	2032
Sample locations queries	2033
Querying for apps	2033
Apps query arguments	2033
Apps fields	2034
Sample apps queries	2035
Additional resources	2036
CloudEvent JSON specification for Supply Chain Security Tools - Artifact Metadata Repository	2036
JSON specification	2036
Required CloudEvent attributes	2037
Optional CloudEvent attributes	2038
CloudEvent extension attributes	2038
Batch CloudEvents	2039
Artifact Metadata Repository CloudEvent Handler	2039
Switching Context	2039
Install	2039
Uninstall	2039
Artifact Metadata Repository Observer for Supply Chain Security Tools - Store	2040
Prerequisites	2040
Switching Context	2040
Install	2040
Installing Artifact Metadata Repository Observer Standalone	2041
Troubleshooting Artifact Metadata Repository (AMR)	2042
Debugging AMR	2042
Health Check	2042
AMR Observer Logs	2044
AMR CloudEvent Handler Logs	2045
Additional documentation for Supply Chain Security Tools - Store	2046

Use and operate	2047
Troubleshooting and logging	2047
Configuration	2047
Access control	2047
Certificates	2047
Database	2047
Other	2047
Additional documentation for Supply Chain Security Tools - Store	2047
Use and operate	2048
Troubleshooting and logging	2048
Configuration	2048
Access control	2048
Certificates	2048
Database	2048
Other	2048
API reference for Supply Chain Security Tools - Store	2048
Information	2049
Version	2049
Content negotiation	2049
URI Schemes	2049
Consumes	2049
Produces	2049
All endpoints	2049
images	2049
Operations	2049
Packages	2049
Sources	2050
v1artifact_groups	2050
v1images	2050
v1packages	2051
v1reports	2051
v1sources	2051
v1trriage	2051
v1vulnerabilities	2051
vulnerabilities	2052
Paths	2052
Create an artifact group with specified labels and entity (CreateArtifactGroup)	2052
Parameters	2052
All responses	2052
Responses	2052

201 - ArtifactGroupCreatePostResponse	2052
Schema	2052
400 - ErrorMessage	2053
Schema	2053
Default Response	2053
Schema	2053
(Use POST /api/M/images instead) Create a new image report. Related packages and vulnerabilities are also created. (CreateImageReport)	2053
Parameters	2053
All responses	2053
Responses	2053
200 - Image	2053
Schema	2053
Default Response	2053
Schema	2053
(Use POST /api/M/sources instead) Create a new source report. Related packages and vulnerabilities are also created. (CreateSourceReport)	2054
Parameters	2054
All responses	2054
Responses	2054
200 - Source	2054
Schema	2054
Default Response	2054
Schema	2054
List the packages in an image. (GetImagePackages)	2054
Parameters	2054
All responses	2054
Responses	2055
200 - Package	2055
Schema	2055
Default Response	2055
Schema	2055
List packages of the given image. (GetImagePackagesQuery)	2055
Parameters	2055
All responses	2055
Responses	2055
200 - Package	2055
Schema	2055
Default Response	2055
Schema	2055
List vulnerabilities from the given image. (GetImageVulnerabilities)	2056
Parameters	2056

All responses	2056
Responses	2056
200 - Vulnerability	2056
Schema	2056
Default Response	2056
Schema	2056
Search image by id, name or digest . (GetImages)	2056
All responses	2056
Responses	2057
200 - Image	2057
Schema	2057
Default Response	2057
Schema	2057
Search package by ID (GetPackageByID)	2057
Parameters	2057
All responses	2057
Responses	2057
200 - Package	2057
Schema	2057
404 - ErrorMessage	2057
Schema	2057
Default Response	2058
Schema	2058
List the images that contain the given package. (GetPackageImages)	2058
Parameters	2058
All responses	2058
Responses	2058
200 - Image	2058
Schema	2058
Default Response	2058
Schema	2058
List the sources containing the given package. (GetPackageSources)	2058
Parameters	2058
All responses	2059
Responses	2059
200 - Source	2059
Schema	2059
Default Response	2059
Schema	2059
List vulnerabilities from the given package. (GetPackageVulnerabilities)	2059
Parameters	2059
All responses	2059

Responses	2059
200 - Vulnerability	2059
Schema	2060
Default Response	2060
Schema	2060
Search packages by id, name and/or version. (GetPackages)	2060
Parameters	2060
All responses	2060
Responses	2060
200 - Package	2060
Schema	2060
Default Response	2060
Schema	2060
get source packages (GetSourcePackages)	2061
Parameters	2061
All responses	2061
Responses	2061
200 - Package	2061
Schema	2061
Default Response	2061
Schema	2061
List packages of the given source. (GetSourcePackagesQuery)	2061
Parameters	2061
All responses	2061
Responses	2062
200 - Package	2062
Schema	2062
Default Response	2062
Schema	2062
get source vulnerabilities (GetSourceVulnerabilities)	2062
Parameters	2062
All responses	2062
Responses	2062
200 - Vulnerability	2062
Schema	2062
Default Response	2062
Schema	2063
List vulnerabilities of the given source. (GetSourceVulnerabilitiesQuery)	2063
Parameters	2063
All responses	2063
Responses	2063
200 - Vulnerability	2063

Schema	2063
Default Response	2063
Schema	2063
Search for sources by ID, repository, commit sha and/or organization. (GetSources)	2063
Parameters	2064
All responses	2064
Responses	2064
200 - Source	2064
Schema	2064
Default Response	2064
Schema	2064
Search for vulnerabilities by CVE id. (GetVulnerabilities)	2064
Parameters	2064
All responses	2064
Responses	2065
200 - Vulnerability	2065
Schema	2065
Default Response	2065
Schema	2065
Search vulnerability by ID (GetVulnerabilityByID)	2065
Parameters	2065
All responses	2065
Responses	2065
200 - Vulnerability	2065
Schema	2065
404 - ErrorMessage	2065
Schema	2066
Default Response	2066
Schema	2066
List the images that contain the given vulnerability. (GetVulnerabilityImages)	2066
Parameters	2066
All responses	2066
Responses	2066
200 - Image	2066
Schema	2066
Default Response	2066
Schema	2066
List packages that contain the given CVE id. (GetVulnerabilityPackages)	2066
Parameters	2067
All responses	2067
Responses	2067
200 - Package	2067

Schema	2067
Default Response	2067
Schema	2067
List sources that contain the given vulnerability. (GetVulnerabilitySources)	2067
Parameters	2067
All responses	2067
Responses	2067
200 - Source	2068
Schema	2068
Default Response	2068
Schema	2068
health check (HealthCheck)	2068
All responses	2068
Responses	2068
200	2068
Schema	2068
Default Response	2068
Schema	2068
Query for a list of artifact group that contains image(s) with specified digests, and or source(s) with specified shas. At least one image digest or source sha must be provided. This query can be further refined by matching images and sources with a specific combination of package name and/or cve id. (SearchArtifactGroups)	2068
Parameters	2069
All responses	2069
Responses	2069
200 - PaginatedArtifactGroupSearchPostResponse	2069
Schema	2069
400 - ErrorMessage	2069
Schema	2069
Default Response	2069
Schema	2069
Search for how many artifact groups are affected by vulnerabilities associated with the specified image(s) digests, and/or source(s) shas. At least one image digest or source sha must be provided. (SearchArtifactGroupsVulnReach)	2069
Parameters	2069
All responses	2070
Responses	2070
200 - PaginatedArtifactGroupVulnReachPostResponse	2070
Schema	2070
400 - ErrorMessage	2070
Schema	2070
Default Response	2070
Schema	2070

Search for all vulnerabilities associated with an artifact group that contains image(s) with specified digests, and/or source(s) with specified shas. At least one image digest or source sha must be provided. (SearchArtifactGroupsVulnerabilities)	2070
Parameters	2070
All responses	2071
Responses	2071
200 - PaginatedArtifactGroupVulnSearchPostResponse	2071
Schema	2071
400 - ErrorMessage	2071
Schema	2071
Default Response	2071
Schema	2071
Copies the analysis of an existing triage to a new target. (V1CopyVulnerabilityAnalysis)	2071
Consumes	2071
Parameters	2072
All responses	2072
Responses	2072
200 - V1AnalysisInstanceUIDResponse	2072
Schema	2072
201 - V1AnalysisInstanceUIDResponse	2072
Schema	2072
400 - ErrorMessage	2072
Schema	2072
404 - ErrorMessage	2072
Schema	2073
503 - ErrorMessage	2073
Schema	2073
Inserts or updates a vulnerability analysis (V1CreateVulnerabilityAnalysis)	2073
Consumes	2073
Parameters	2073
All responses	2073
Responses	2073
200 - V1AnalysisInstanceUIDResponse	2073
Schema	2073
201 - V1AnalysisInstanceUIDResponse	2074
Schema	2074
400 - ErrorMessage	2074
Schema	2074
503 - ErrorMessage	2074
Schema	2074
Search image by ID or DIGEST (V1GetImage)	2074
Parameters	2074

All responses	2074
Responses	2075
200 - Image	2075
Schema	2075
404 - ErrorMessage	2075
Schema	2075
Default Response	2075
Schema	2075
Query for images. If no parameters are given, this endpoint will return all images. (V1GetImages)	2075
Parameters	2075
All responses	2076
Responses	2076
200 - PaginatedImageResponse	2076
Schema	2076
404 - ErrorMessage	2076
Schema	2076
Default Response	2076
Schema	2076
Query for packages with images parameters. If no parameters are given, this endpoint will return all packages related to images. (V1GetImagesPackages)	2076
Parameters	2076
All responses	2077
Responses	2077
200 - PaginatedPackageResponse	2077
Schema	2077
404 - ErrorMessage	2077
Schema	2077
Default Response	2077
Schema	2078
Query for vulnerabilities with image parameters. If no parameters are give, this endpoint will return all vulnerabilities. (V1GetImagesVulnerabilities)	2078
Parameters	2078
All responses	2078
Responses	2078
200 - PaginatedVulnerabilityResponse	2078
Schema	2078
404 - ErrorMessage	2079
Schema	2079
Default Response	2079
Schema	2079

Query for packages. If no parameters are given, this endpoint will return all packages. (V1GetPackages)	2079
Parameters	2079
All responses	2079
Responses	2080
200 - PaginatedPackageResponse	2080
Schema	2080
404 - ErrorMessage	2080
Schema	2080
Default Response	2080
Schema	2080
Get a specific report by its unique identifier (V1GetReport)	2080
Parameters	2080
All responses	2080
Responses	2081
200 - ReportResponse	2081
Schema	2081
400 - ErrorMessage	2081
Schema	2081
404 - ErrorMessage	2081
Schema	2081
503 - ErrorMessage	2081
Schema	2081
Search source by ID or SHA (V1GetSource)	2081
Parameters	2082
All responses	2082
Responses	2082
200 - Source	2082
Schema	2082
404 - ErrorMessage	2082
Schema	2082
Default Response	2082
Schema	2082
Query for sources. If no parameters are given, this endpoint will return all sources. (V1GetSources)	2082
Parameters	2083
All responses	2083
Responses	2083
200 - PaginatedSourceResponse	2083
Schema	2083
404 - ErrorMessage	2083
Schema	2083

Default Response	2083
Schema	2083
Query for packages with source parameters. If no parameters are given, this endpoint will return all packages related to sources. (V1GetSourcesPackages)	2084
All responses	2084
Responses	2084
200 - PaginatedPackageResponse	2084
Schema	2084
404 - ErrorMessage	2084
Schema	2084
Default Response	2084
Schema	2084
Query for vulnerabilities with source parameters. If no parameters are given, this endpoint will return all vulnerabilities. (V1GetSourcesVulnerabilities)	2084
Parameters	2084
All responses	2085
Responses	2085
200 - PaginatedVulnerabilityResponse	2085
Schema	2085
404 - ErrorMessage	2085
Schema	2085
Default Response	2085
Schema	2086
Query for Triage Analysis. If no parameters are given, this endpoint will return all analysis instances. (V1GetTriage)	2086
Parameters	2086
All responses	2086
Responses	2086
200 - PaginatedVulnerabilityAnalysisResponse	2086
Schema	2086
400 - ErrorMessage	2086
Schema	2086
Add an image with a CycloneDX or SPDX report (V1PostImages)	2087
Consumes	2087
Parameters	2087
All responses	2088
Responses	2088
200 - V1ImagePostResponse	2088
Schema	2088
400 - ErrorMessage	2088
Schema	2088
Default Response	2088

Schema	2088
Add a source with a CycloneDX or SPDX report (V1PostSources)	2088
Consumes	2089
Parameters	2089
All responses	2089
Responses	2090
200 - V1SourcePostResponse	2090
Schema	2090
400 - ErrorMessage	2090
Schema	2090
Query for a list of reports with specified image digest, source sha, or original location. (V1SearchReports)	2090
Parameters	2090
All responses	2091
Responses	2091
200 - PaginatedSearchReportResponse	2091
Schema	2091
400 - ErrorMessage	2091
Schema	2091
404 - ErrorMessage	2091
Schema	2091
500 - ErrorMessage	2092
Schema	2092
Models	2092
AnalysisInstanceImageDependency	2092
AnalysisInstancePackageDependency	2092
AnalysisInstanceSourceDependency	2092
AnalysisInstanceUIDResponse	2092
AnalysisRequest	2093
ArtifactGroupCreatePostResponse	2093
ArtifactGroupPostRequest	2093
ArtifactGroupResponse	2094
ArtifactGroupSearchEntityPostResponse	2094
ArtifactGroupSearchFilters	2095
ArtifactGroupSearchPackagePostResponse	2096
ArtifactGroupSearchPostResponse	2096
ArtifactGroupVulnReachFiltersPostRequest	2096
ArtifactGroupVulnReachPostResponse	2097
ArtifactGroupVulnSearchFilters	2097
ArtifactGroupVulnSearchPostResponse	2098
BaseArtifactGroupResponse	2099
BaseEntityResponse	2099

BasePackageResponse	2099
BaseRatingResponse	2099
BaseReportResponse	2099
BaseVulnerabilityResponse	2099
DeletedAt	2099
EntityCreatePostResponse	2099
EntityResponse	2100
ErrorMessage	2100
GetVulnerabilityAnalysisResponse	2100
Image	2101
MethodType	2101
Model	2102
NullTime	2102
Package	2102
PackageResponse	2102
PaginatedArtifactGroupSearchPostResponse	2103
PaginatedArtifactGroupVulnReachPostResponse	2103
PaginatedArtifactGroupVulnSearchPostResponse	2103
PaginatedResponse	2104
PaginatedSearchReportResponse	2104
PaginatedVulnerabilityAnalysisResponse	2104
Rating	2105
RatingResponse	2105
ReportArtifactGroupResponse	2105
ReportEntityResponse	2106
ReportPackageResponse	2106
ReportRatingResponse	2107
ReportResponse	2107
ReportToolResponse	2107
ReportVulnerabilityResponse	2108
SearchReportResponse	2108
Source	2109
StringArray	2109
V1ImagePostResponse	2109
V1SourcePostResponse	2110
VAAalysisResponse	2110
V1ImageResponse	2110
VAPackageResponse	2111
VASourceResponse	2111
VAVulnerabilityResponse	2111
Vulnerability	2111
VulnerabilityAnalysisCopyRequest	2112

VulnerabilityAnalysisRequest	2112
Inlined models	2112
VulnerabilityResponse	2113
paginatedImageResponse	2113
paginatedPackageResponse	2114
paginatedSourceResponse	2114
paginatedVulnerabilityResponse	2114
responseImage	2115
responsePackage	2115
responseSource	2115
responseVulnerability	2116
API walkthrough for Supply Chain Security Tools - Store	2116
Use curl to post an image report	2116
Connecting to the PostgreSQL Database	2118
Deployment details and configuration for Supply Chain Security Tools - Store	2119
What is deployed	2119
Deployment configuration	2120
Supported Network Configurations	2120
Deploying AMR	2120
App service type	2120
Ingress support	2121
Database configuration	2121
Use an AWS RDS PostgreSQL database	2122
Use an external PostgreSQL database	2122
Custom database password	2122
Service accounts	2122
Export certificates	2122
Configure your AWS RDS PostgreSQL configuration	2123
Prerequisite	2123
Set up a certificate and configuration	2123
Use an external PostgreSQL database for Supply Chain Security Tools - Store	2124
Prerequisites	2124
Set up certificate and configuration	2124
Validation	2124
Database backup recommendations for Supply Chain Security Tools - Store	2124

Backup	2125
Restore	2125
Log configuration and usage for Supply Chain Security Tools - Store	2126
Verbosity levels	2126
Slow SQL	2126
Error logs	2127
Obtaining logs	2127
API endpoint log output	2127
Format	2128
Key-value pairs	2128
Common to all logs	2128
Logging query and path parameter values	2129
API payload log output	2129
GraphQL endpoint log output	2129
Format	2130
Key-value pairs	2130
Common to all logs	2130
API payload log output	2131
Slow SQL query log output	2131
SQL Query log output	2131
SQL Query log output	2132
Format	2132
Connecting to the PostgreSQL Database	2132
Troubleshooting Supply Chain Security Tools - Store	2133
Querying by insight source returns zero CVEs even though there are CVEs in the source scan	2133
Symptom	2133
Solution	2133
Persistent volume retains data	2133
Symptom	2133
Solution	2134
Missing persistent volume	2134
Symptom	2134
Solution	2134
Builds fail due to volume errors on EKS running Kubernetes v1.23	2134
Symptom	2134
Explanation	2135
Solution	2135
Certificate Expiries	2135
Symptom	2135
Explanation	2135

Solution	2135
Database index corruption issue in SCST - Store	2136
Errors from Tanzu Developer Portal related to SCST - Store	2136
An error occurred while loading data from the Metadata Store	2136
Symptom	2136
Cause	2137
Solution	2137
Troubleshoot upgrading Supply Chain Security Tools - Store	2137
Database deployment does not exist	2137
Invalid checkpoint record	2137
Upgraded pod hanging	2138
Failover, redundancy, and backups for Supply Chain Security Tools - Store	2138
API Server	2138
Database	2138
Custom certificate configuration for Supply Chain Security Tools - Store	2139
Default configuration	2139
(Optional) Set up a custom ingress TLS certificate	2139
Place the certificates in a secret	2139
Edit the tap-values.yaml to use the secret	2139
Additional resources	2140
TLS configuration for Supply Chain Security Tools - Store	2140
Setting up custom ingress TLS ciphers	2140
Example custom TLS settings	2140
Additional resources	2141
Certificate rotation for Supply Chain Security Tools - Store	2141
Certificates	2141
Certificate duration setting	2141
Ingress support for Supply Chain Security Tools - Store	2142
Ingress configuration	2142
Get the TLS CA certificate	2143
Additional Resources	2143
Use your LoadBalancer with Supply Chain Security Tools - Store	2144
Configure LoadBalancer	2144
Port forwarding	2144
Edit your /etc/hosts file for port-forwarding	2144
Configure the Insight plug-in	2145

Use your NodePort with Supply Chain Security Tools - Store	2145
Overview	2145
Edit your /etc/hosts file for port-forwarding	2146
Configure the Insight plug-in	2146
Multicluster setup for Supply Chain Security Tools - Store	2146
Overview	2146
Prerequisites	2147
Procedure summary	2147
Copy SCST - Store CA certificate from View cluster	2147
Copy SCST - Store authentication token from the View cluster	2147
Apply the CA certificate and authentication token to a new Kubernetes cluster	2148
Install Build profile	2148
More information about how Build profile uses the configuration	2148
Configure developer namespaces	2149
Exporting SCST - Store secrets to a developer namespace in a Tanzu Application Platform multicluster deployment	2149
Additional resources	2149
Developer namespace setup for Supply Chain Security Tools - Store	2149
Overview	2150
Single cluster - using the Tanzu Application Platform values file	2150
Multicluster - using SecretExport	2150
Next steps	2150
Retrieve access tokens for Supply Chain Security Tools - Store	2151
Overview	2151
Retrieving the read-write access token	2151
Retrieving the read-only access token	2151
Using an access token	2151
Additional Resources	2151
Retrieve and create service accounts for Supply Chain Security Tools - Store	2151
Overview	2151
Create read-write service account	2152
Create a read-only service account	2153
With a default cluster role	2153
With a custom cluster role	2153
Additional Resources	2153
Create a service account with a custom cluster role for Supply Chain Security Tools - Store	2153
Example service account	2154

Additional Resources	2154
Install Supply Chain Security Tools - Store	2154
Prerequisites	2155
Install	2155
Prerequisite for Standalone SCST - Store	2159
Supply Chain Security Tools - Store Database Index Corruption	2159
Overview	2160
Solve a database index corruption issue reported in Metadata Store App Container logs	2160
Symptom	2160
Output	2160
Solutions	2160
Edit the auto_correct_db_indexes property to be true in tap-values.yaml	2161
Connect to the Metadata Store database with the account that the Metadata Store API uses	2161
Connect to the Metadata Store database with a superuser account and manually fix the index	2161
Overview of Tanzu Application Platform Telemetry	2162
Tanzu Application Platform usage reports	2162
Overview of Tanzu Application Platform Telemetry	2164
Tanzu Application Platform usage reports	2164
Install Tanzu Application Platform Telemetry	2166
Prerequisites	2166
Install	2167
Deployment details and configurations of Tanzu Application Platform Telemetry	2168
What is deployed	2168
Deployment configuration	2168
Overview of Tanzu Build Service	2169
Overview	2169
Overview of Tanzu Build Service	2169
Overview	2169
Install Tanzu Build Service	2170
Before you begin	2170
Prerequisites	2170
Deprecated Features	2170
Install the Tanzu Build Service package	2170

Use AWS IAM authentication for registry credentials	2172
Install full dependencies	2173
Install Tanzu Build Service on an air-gapped environment	2174
Before you begin	2175
Prerequisites	2175
Deprecated Features	2175
Install the Tanzu Build Service package	2175
Install the Tanzu Build Service dependencies	2176
Configure Tanzu Build Service properties on a workload	2177
Overview	2177
Configure build-time service bindings	2177
Configure environment variables	2178
Configure the service account	2178
Configure the cluster builder	2178
Configure the workload container image registry	2179
Configure custom CA certificates for a single workload using service bindings	2179
Using custom CA certificates for all workloads	2180
Create a signed container image with Tanzu Build Service	2180
Prerequisites	2180
Configure Tanzu Build Service to sign your image builds	2180
Tanzu Build Service Dependencies	2183
How dependencies are installed	2183
View installed dependencies	2183
Bionic and Jammy stacks	2184
About lite and full dependencies	2184
Lite dependencies	2184
Lite dependencies: stacks	2184
Lite dependencies: buildpacks	2184
Full dependencies	2185
Full dependencies: stacks	2185
Full dependencies: buildpacks	2185
Dependency comparison	2186
Update dependencies	2186
Upgrade Buildpacks between Tanzu Application Platform releases	2187
Security context constraint for OpenShift	2188
Troubleshoot Tanzu Build Service	2189
Builds fail due to volume errors on EKS running Kubernetes v1.23	2190
Symptom	2190

Cause	2190
Solution	2190
Smart-warmer-image-fetcher reports ErrImagePull due to dockerd's layer depth limitation	2190
Symptom	2190
Cause	2190
Solution	2190
Nodes fail due to “trying to send message larger than max” error	2191
Symptom	2191
Cause	2191
Solution	2191
Build platform uses the old build cache after upgrade to new stack	2191
Symptom	2191
Solution	2191
Switching from buildservice.kp_default_repository to shared.image_registry	2191
Symptom	2191
Cause	2192
Solution	2192
Create a GitHub build action (Alpha)	2192
Prerequisites	2192
Procedure	2192
Developer namespace	2192
Access to Kubernetes API server	2192
Permissions Required	2192
Use the action	2194
Debugging	2195
Overview of Tanzu Developer Portal	2195
Overview of Tanzu Developer Portal	2196
Install Tanzu Developer Portal	2197
Prerequisites	2197
Procedure	2198
Runtime configuration options for Tanzu Developer Portal	2199
Identify the Tanzu Developer Portal version you have available	2199
Display the possible values options for Tanzu Developer Portal	2200
Customize the portal	2200
Customize branding	2200
Customize the Software Catalog page	2201
Customize the name of the organization	2201
Prevent changes to the software catalog	2202

Customize the Authentication page	2202
Customize the default view	2203
Customize security banners	2203
Customize the portal	2204
Customize branding	2204
Customize the Software Catalog page	2205
Customize the name of the organization	2205
Prevent changes to the software catalog	2206
Customize the Authentication page	2206
Customize the default view	2206
Customize security banners	2207
Customize the Support menu	2208
Overview	2208
Customizing	2208
Structure of the support configuration	2209
URL	2209
Items	2209
Title	2209
Icon	2209
Links	2210
Customize the Tanzu Developer Portal telemetry collection	2210
Customize organization ID	2210
Access Tanzu Developer Portal	2211
Access with the LoadBalancer method (default)	2211
Access with the shared Ingress method	2211
Catalog operations	2212
Adding catalog entities	2212
Users and groups	2213
Systems	2214
Components	2214
Update software catalogs	2214
Register components	2214
Deregister components	2215
Add or change organization catalog locations	2215
Install demo apps and their catalogs	2216
Yelb system	2216
Install Yelb	2216
Install the Yelb catalog	2216

View resources on multiple clusters in Tanzu Developer Portal	2217
Set up a Service Account to view resources on a cluster	2217
Update Tanzu Developer Portal to view resources on multiple clusters	2220
View resources on multiple clusters in the Runtime Resources Visibility plug-in	2221
Set up authentication for Tanzu Developer Portal	2222
View your Backstage Identity	2222
Configure an authentication provider	2223
(Optional) Allow guest access	2225
(Optional) Customize the login page	2225
View resources on remote clusters	2225
Set up the permission framework for your Tanzu Developer Portal	2226
Overview of the permission framework	2226
Enable the permission framework	2226
Enable catalog entity visibility	2227
View resources on remote clusters	2228
View resources on remote EKS clusters	2229
Set up the OIDC provider	2229
Configure the Kubernetes cluster with the OIDC provider	2229
Configure the Tanzu Developer Portal	2230
Upgrade the Tanzu Developer Portal package	2231
View resources on remote GKE clusters	2231
Leverage an external OIDC provider	2232
Set up the OIDC provider	2232
Configure the GKE cluster with the OIDC provider	2232
Configure visibility of the remote cluster	2232
Update the tap-gui package to finish leveraging the external OIDC provider	2233
Leverage Google's OIDC provider	2234
Add redirect configuration on the OIDC side	2234
Configure visibility of the remote GKE cluster	2234
Update the tap-gui package to finish leveraging the Google OIDC provider	2235
View runtime resources on authorization-enabled clusters	2235
Globally-scoped components	2236
Namespace-scoped components	2236
Assign roles and permissions on Kubernetes clusters	2237
Create roles	2237
Cluster-scoped roles	2237
Namespace-scoped roles	2237

Create users	2238
Assign users to their roles	2238
Add Tanzu Developer Portal integrations	2239
Add a GitHub provider integration	2239
Add a Git-based provider integration that isn't GitHub	2239
Add a non-Git provider integration	2240
Update the package profile	2240
Configure the Tanzu Developer Portal database	2240
Configure a PostgreSQL database	2241
Edit tap-values.yaml	2241
(Optional) Configure extra parameters	2241
Update the package profile	2242
Generate and publish TechDocs	2242
Create an Amazon S3 bucket	2242
Configure Amazon S3 access	2242
Create an AWS IAM user group	2243
Create an AWS IAM user	2243
Find the catalog locations and their entities' namespace, kind, and name	2243
Use the TechDocs CLI to generate and publish TechDocs	2244
Update the techdocs section in app-config.yaml to point to the Amazon S3 bucket	2245
Overview of Configurator (beta)	2246
Differences between the pre-built Tanzu Developer Portal and a customized portal	2246
How Configurator works	2246
Next steps	2246
Overview of Configurator (beta)	2247
Differences between the pre-built Tanzu Developer Portal and a customized portal	2247
How Configurator works	2247
Next steps	2247
Tanzu Developer Portal Configurator Concepts	2247
Overview of how to customize your portal	2248
Overviews of buildtime configuration and runtime configuration	2248
Buildtime configuration	2248
Runtime configuration	2248
Tanzu Developer Portal Configurator Foundation	2249
Internal plug-ins and external plug-ins	2249
Plug-in surfaces and wrappers	2249
Plug-in surfaces	2249
Plug-in wrappers	2249

Build your Customized Tanzu Developer Portal with Configurator (beta)	2250
Prerequisites	2250
Prepare your Configurator configuration file	2251
Identify your Configurator image	2251
Prepare your Configurator workload definition file	2252
Submit your workload	2253
Run your Customized Tanzu Developer Portal	2254
Identify the customized image reference	2254
Prepare to overlay your customized image onto the currently running instance	2255
Troubleshoot Tanzu Developer Portal Configurator (beta)	2256
Symptom	2256
Cause	2256
Solution	2256
Overview of Tanzu Developer Portal plug-ins	2257
Overview of Tanzu Developer Portal plug-ins	2257
Runtime resources visibility in Tanzu Developer Portal	2258
Prerequisite	2258
If you have a metrics server	2258
Visualize Workloads on Tanzu Developer Portal	2259
Navigate to the Runtime Resources Visibility screen	2259
Resources	2259
Resources details page	2260
Overview card	2261
Status card	2262
Ownership card	2263
Annotations and Labels	2263
Selecting completed supply chain pods	2264
Navigating to the pod Details page	2264
Overview of pod metrics	2264
Navigating to Application Live View	2265
Viewing pod logs	2265
Pausing and resuming logs	2266
Filtering by container	2266
Filtering by date and time	2266
Changing log levels	2266
Line wrapping	2267
Downloading logs	2267
Connection interruptions	2267

Application Live View in Tanzu Developer Portal	2268
Overview	2268
Entry point to Application Live View plug-in	2268
Application Live View in Tanzu Developer Portal	2268
Overview	2268
Entry point to Application Live View plug-in	2269
Application Live View for Spring Boot Applications in Tanzu Developer Portal	2269
Details page	2269
Health page	2270
Environment page	2270
Log Levels page	2271
Threads page	2272
Memory page	2272
Request Mappings page	2273
HTTP Requests page	2274
Caches page	2275
Configuration Properties page	2275
Conditions page	2276
Scheduled Tasks page	2276
Beans page	2277
Metrics page	2277
Actuator page	2278
Troubleshooting	2278
Application Live View for Spring Cloud Gateway applications in Tanzu Developer Portal	2278
API Success Rate page	2279
API Overview page	2279
API Authentications By Path page	2279
Troubleshooting	2280
Application Live View for Steeltoe applications in Tanzu Developer Portal	2280
Details page	2280
Health page	2280
Environment page	2281
Log Levels page	2282
Threads page	2283
Memory page	2283
Request Mappings page	2283
HTTP Requests page	2284

Metrics page	2284
Actuator page	2285
Troubleshooting	2285
Application Accelerator in Tanzu Developer Portal	2285
Overview	2286
Access Application Accelerator	2286
Configure project generation	2286
Create the project	2287
Develop your code	2287
Next steps	2288
Application Accelerator in Tanzu Developer Portal	2288
Overview	2288
Access Application Accelerator	2288
Configure project generation	2289
Create the project	2290
Develop your code	2290
Next steps	2290
Install Application Accelerator	2291
Prerequisites	2291
Install	2291
Configure properties and resource use	2293
Create an Application Accelerator Git repository during project creation	2294
Overview	2294
Supported Providers	2294
Configure	2295
(Optional) Deactivate Git repository creation	2295
Create a Project	2295
API documentation plug-in in Tanzu Developer Portal	2296
Overview	2296
Use the API documentation plug-in	2297
Create a new API entry	2299
Manually create a new API entry	2299
Automatically create a new API entry	2300
API documentation plug-in in Tanzu Developer Portal	2300
Overview	2301
Use the API documentation plug-in	2301
Create a new API entry	2303
Manually create a new API entry	2303

Automatically create a new API entry	2304
Get started with the API documentation plug-in	2304
API entries	2305
About API entities	2305
Add a demo API entity to the Tanzu Developer Portal software catalog	2305
Update your demo API entry	2308
Validation Analysis of API specifications	2308
About the Validation Analysis card	2308
Automatic OpenAPI specification validation	2309
Security Analysis in Tanzu Developer Portal	2309
Overview	2309
Installing and configuring	2310
Accessing the plug-in	2310
Viewing vulnerability data	2310
Viewing CVE and package details	2311
Supply Chain Choreographer in Tanzu Developer Portal	2312
Overview	2312
Prerequisites	2312
Enable CVE scan results	2312
Automatically connect Tanzu Developer Portal to SCST - Store	2313
Troubleshooting	2313
Manually connect Tanzu Developer Portal to the Metadata Store	2314
Enable GitOps Pull Request Flow	2314
Supply Chain Visibility	2314
View Vulnerability Scan Results	2316
Overview of enabling TLS for Tanzu Developer Portal	2316
Concepts	2316
Certificate delegation	2316
cert-manager, certificates, and ClusterIssuers	2317
Guides	2318
Overview of enabling TLS for Tanzu Developer Portal	2318
Concepts	2318
Certificate delegation	2318
cert-manager, certificates, and ClusterIssuers	2319
Guides	2320
Configure a TLS certificate by using an existing certificate	2320
Prerequisites	2320
Procedure	2321

Configure a TLS certificate by using a self-signed certificate	2322
Prerequisite	2322
Procedure	2322
Configure a TLS certificate by using cert-manager and a ClusterIssuer	2323
Prerequisites	2324
Procedure	2324
Upgrade Tanzu Developer Portal	2326
Considerations	2326
Upgrade within a Tanzu Application Platform profile	2326
Upgrade Tanzu Developer Portal individually	2326
Troubleshoot Tanzu Developer Portal	2327
General issues	2327
Tanzu Developer Portal reports that the port range is not valid	2327
Symptom	2327
Cause	2327
Solution	2328
Tanzu Developer Portal does not load the catalog	2328
Symptom	2328
Cause	2328
Solution	2328
Updating a supply chain causes an error (Can not create edge...)	2329
Symptom	2329
Solution	2329
Catalog not found	2329
Symptom	2329
Cause	2329
Solution	2329
No configured authentication provider	2330
Symptom	2330
Cause	2330
Solution	2330
Issues updating the values file	2330
Symptom	2330
Solution	2330
Pull logs from Tanzu Developer Portal	2331
Symptom	2331
Solution	2331
Ad-blocking software interference	2331
Symptom	2331
Cause	2331

Solution	2331
Runtime Resources tab issues	2331
Error communicating with Tanzu Application Platform web server	2331
Symptom	2331
Causes	2332
Solution	2332
No data available	2332
Symptom	2332
Cause	2332
Solution	2332
Errors retrieving resources	2332
Symptom	2332
Accelerators page issues	2333
No accelerators	2333
Symptom	2333
Cause	2333
Solution	2333
Supporting ImageVulnerabilityScan issues	2333
No Vulnerability data	2333
Symptom	2333
Cause	2333
Solution	2333
Security Analysis plug-in issues	2334
Empty Impacted Workloads table	2334
Symptom	2334
Cause	2334
Solution	2334
Supply Chain Choreographer plug-in issues	2335
An error occurred while loading data from the Metadata Store	2335
Symptom	2335
Cause	2335
Solution	2335
SBOMs do not download when automatically configuring Tanzu Developer Portal for SCST - Store	2335
Symptom	2335
Cause	2335
Solution	2336
Overview of Tanzu Developer Tools for IntelliJ	2336
Extension features	2336
Next steps	2337
Overview of Tanzu Developer Tools for IntelliJ	2337

Extension features	2337
Next steps	2338
Install Tanzu Developer Tools for IntelliJ	2338
Prerequisites	2338
Install	2338
Update	2339
Uninstall	2339
Next steps	2339
Get Started with Tanzu Developer Tools for IntelliJ	2339
Prerequisite	2339
Configure Local Source Proxy or use a source image registry	2339
Run Tanzu Developer Tools for IntelliJ	2340
Set up Tanzu Developer Tools for IntelliJ	2340
Create the workload.yaml file	2341
Create the catalog-info.yaml file	2341
Create the Tiltfile file	2342
Create the .tanuignore file	2343
View an example project	2343
Next steps	2344
Use Tanzu Developer Tools for IntelliJ	2344
Workload Actions	2344
Apply a workload	2344
Delete a workload	2344
Debugging on the cluster	2345
Start debugging on the cluster	2345
Stop Debugging on the Cluster	2346
Live Update	2347
Start Live Update	2347
Stop Live Update	2347
Tanzu Workloads panel	2348
Working with microservices in a monorepo	2348
Recommended structure: Microservices that can be built independently	2349
Alternative structure: Services with build-time interdependencies	2349
Change logging verbosity	2351
Work with Native Image for Java	2351
Use native images with Maven	2351
Supported Features	2352
Glossary of terms	2353
Live Update	2353

Tiltfile	2353
Debugging on the cluster	2353
YAML file format	2353
workload.yaml file	2353
catalog-info.yaml file	2353
Code snippet	2353
Source image	2353
Local path	2354
Kubernetes context	2354
Kubernetes namespace	2354
Troubleshoot Tanzu Developer Tools for IntelliJ	2354
Unable to view workloads on the panel when connected to GKE cluster	2354
Symptom	2354
Cause	2354
Solution	2354
Deactivated launch controls after running a launch configuration	2354
Symptom	2354
Cause	2354
Starting a Tanzu Debug session fails with Unable to open debugger port	2355
Symptom	2355
Cause	2355
Solution	2355
Timeout error when Live Updating	2355
Symptom	2355
Cause	2355
Solution	2355
Tanzu Panel empty when using a GKE cluster on macOS	2356
Symptom	2356
Cause	2356
Solution	2356
Tanzu Panel is empty when the context is set by using the KUBECONFIG environment variable	2356
Symptom	2356
Cause	2356
Solution	2356
Tanzu panel shows workloads but doesn't show Kubernetes resources	2356
Symptom	2356
Cause	2356
Solution	2357
Tanzu Workloads panel workloads only have describe and delete action	2357
Symptom	2357

Cause	2357
Solution	2357
Workload actions do not work when in a project with spaces in the name	2357
Symptom	2357
Cause	2357
Solution	2357
A lock wrongly prevents Live Update from starting again	2357
Symptom	2357
Cause	2358
Solution	2358
UI liveness check causes an EDT Thread Exception error	2358
Symptom	2358
Cause	2358
Solution	2358
Frequent application restarts	2358
Symptom	2358
Cause	2358
Solution	2358
Overview of Tanzu Developer Tools for Visual Studio	2359
Extension features	2359
Next steps	2359
Overview of Tanzu Developer Tools for Visual Studio	2360
Extension features	2360
Next steps	2360
Install Tanzu Developer Tools for Visual Studio	2361
Prerequisites	2361
Install	2361
Update	2361
Uninstall	2361
Next steps	2361
Get Started with Tanzu Developer Tools for Visual Studio	2362
Prerequisite	2362
Configure Local Source Proxy	2362
Set up Tanzu Developer Tools	2362
Create the workload.yaml file	2362
Create the catalog-info.yaml file	2363
Create the Tiltfile file	2364
Create the .tanuignore file	2365
View an example project	2365

Next steps	2366
Use Tanzu Developer Tools for Visual Studio	2366
Configure settings	2366
Workload Actions	2366
Apply a workload	2366
Delete a workload	2366
Start debugging on the cluster	2366
Live Update	2367
Start Live Update	2367
Stop Live Update	2367
Tanzu Workloads panel	2367
Extension logs	2368
Troubleshoot Tanzu Developer Tools for Visual Studio	2368
Stop button causes workload to fail	2368
Symptom	2368
Solution	2368
Frequent application restarts	2368
Symptom	2368
Cause	2368
Solution	2369
Overview of Tanzu Developer Tools for VS Code	2369
Extension features	2369
Overview of Tanzu Developer Tools for VS Code	2369
Extension features	2370
Install Tanzu Developer Tools for VS Code	2370
Prerequisites	2370
Install	2371
Configure	2371
Uninstall	2372
Next steps	2372
Get started with Tanzu Developer Tools for VS Code	2372
Prerequisite	2372
Configure Local Source Proxy or use a source image registry	2372
Set up Tanzu Developer Tools	2373
Create the workload.yaml file	2373
Create the catalog-info.yaml file	2374
Create the Tiltfile file	2375
Create a .tanzuignore file	2376

View an example project	2376
Next steps	2377
Use Tanzu Developer Tools for VS Code	2377
Configure for multiple projects in the workspace	2377
Workload Commands	2377
Apply a workload	2378
Debugging on the cluster	2379
Start debugging on the cluster	2379
Stop Debugging on the cluster	2379
Debug apps in a microservice repository	2380
Live Update	2380
Start Live Update	2380
Stop Live Update	2380
Live Update apps in a microservices repository	2381
Delete a workload	2381
Deploy to different namespaces	2382
Tanzu Workloads panel	2382
Working with Microservices in a Monorepo	2384
Recommended structure: Microservices that can be built independently	2384
Alternative structure: Services with build-time interdependencies	2385
Changing logging verbosity	2386
Working with Java Native images	2386
Use native images with Maven	2386
Supported Features	2387
Pinniped compatibility	2387
OAuth	2387
LDAP	2388
Integrate Live Hover by using Spring Boot Tools	2388
Prerequisites	2388
Activate the Live Hover feature	2388
Deploy a Workload to the Cluster	2388
Use Memory View in Spring Boot Dashboard	2390
Prerequisites	2390
Deploy a workload	2390
View memory use in Spring Boot Dashboard	2391
Troubleshoot Tanzu Developer Tools for VS Code	2395
Unable to view workloads on the panel when connected to GKE cluster	2395
Symptom	2395

Cause	2395
Solution	2395
Live Update fails with <code>UnsupportedClassVersionError</code>	2395
Symptom	2395
Cause	2395
Solution	2396
Timeout error when Live Updating	2396
Symptom	2396
Cause	2396
Solution	2396
Task-related error when running a Tanzu Debug launch configuration	2396
Symptom	2396
Cause	2396
Solution	2396
Tanzu Workloads panel workloads only show delete command	2396
Symptom	2396
Cause	2397
Solution	2397
Workload actions do not work when in a project with spaces in the name	2397
Symptom	2397
Cause	2397
Solution	2397
Cannot apply workload because of a malformed kubeconfig file	2397
Symptom	2397
Cause	2397
Solution	2397
Frequent application restarts	2397
Symptom	2397
Cause	2398
Solution	2398
Overview of Tekton	2398
Overview of Tekton	2398
Install Tekton	2398
Prepare	2398
Install Tekton Pipelines	2398
Configure a namespace to use Tekton Pipelines	2399

Tanzu Application Platform v1.6



Important

Tanzu Application Platform v1.6 is no longer supported under the standard [VMware Tanzu Support Life Cycle Policy](#).

To stay up to date with the latest software and security updates, upgrade to a supported version. For supported upgrade paths, see the topic *Upgrade Tanzu Application Platform* in the version documentation that you want to upgrade to.

VMware Tanzu Application Platform (commonly known as TAP) is an application development platform with a rich set of developer tools. Tanzu Application Platform offers developers a paved path to production to build and deploy software quickly and securely on any compliant public cloud or on-premises Kubernetes cluster.

Tanzu Application Platform overview

Tanzu Application Platform:

- Delivers a superior developer experience for enterprises building and deploying cloud-native applications on Kubernetes.
- Allows developers to quickly build and test applications regardless of their familiarity with Kubernetes.
- Helps application teams get to production faster by automating source-to-production pipelines.
- Clearly defines the roles of developers and operators so they can work collaboratively and integrate their efforts.

Operations teams can create application scaffolding templates with built-in security and compliance guardrails, making those considerations mostly invisible to developers. Starting with the templates, developers turn source code into a container and get a URL to test their application in minutes.

After the container is built, it updates every time there's a new code commit or dependency patch. An internal API management portal facilitates connecting to other applications and data, regardless of how they're built or the infrastructure they run on.

Simplified workflows

When creating supply chains, you can simplify workflows in both the inner and outer loop of Kubernetes-based application development with Tanzu Application Platform.

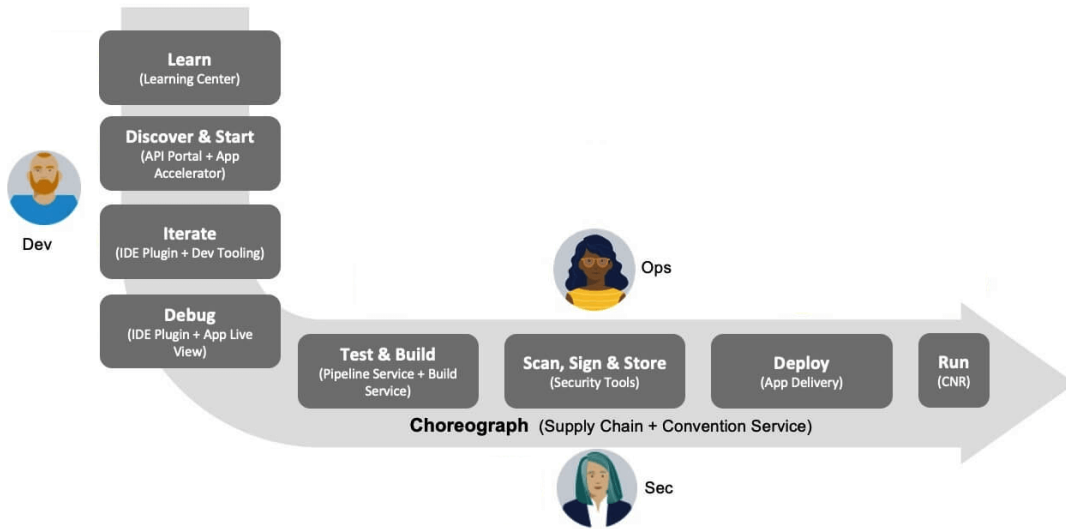

- **Inner Loop**

- The inner loop describes a developer’s development cycle of iterating on code.
- Inner loop activities include coding, testing, and debugging before making a commit.
- On cloud-native or Kubernetes platforms, developers in the inner loop often build container images and connect their applications to all necessary services and APIs to deploy them to a development environment.

- **Outer Loop**

- The outer loop describes how operators deploy applications to production and maintain them over time.
- On a cloud-native platform, outer loop activities include:
 - Building container images.
 - Adding container security.
 - Configuring continuous integration and continuous delivery (CI/CD) pipelines.
- Outer loop activities are challenging in a Kubernetes-based development environment. Application delivery platforms are constructed from various third-party and open source components with numerous configuration options.

- **Supply Chains and choreography**

- Tanzu Application Platform uses the choreography pattern inherited from the context of microservices^{^1} and applies it to CI/CD to create a path to production.^{^2}

Supply chains provide a way of codifying all of the steps of your path to production, or what is more commonly known as CI/CD. A supply chain differs from CI/CD in that with a supply chain, you can add every step necessary for an application to reach production or a lower environment.



To account for the developer experience gap, the path to production allows users to create a unified access point for all of the tools required for their applications to reach a customer-facing environment.

Instead of having separate tools that are loosely coupled to each other for testing and building, security, deploying, and running applications, a path to production defines all four tools in a single unified layer of abstraction. Where tools typically cannot integrate with one another and additional

scripting or webhooks are necessary, a unified automation tool codifies all interactions between each of the tools.

Tanzu Application Platform provides a default set of components that automates pushing an application to staging and production on Kubernetes. This removes the pain points for both inner and outer loops. Operators can customize the platform by replacing Tanzu Application Platform components with other products.

The following diagram shows the layered API and capabilities of Tanzu Application Platform.

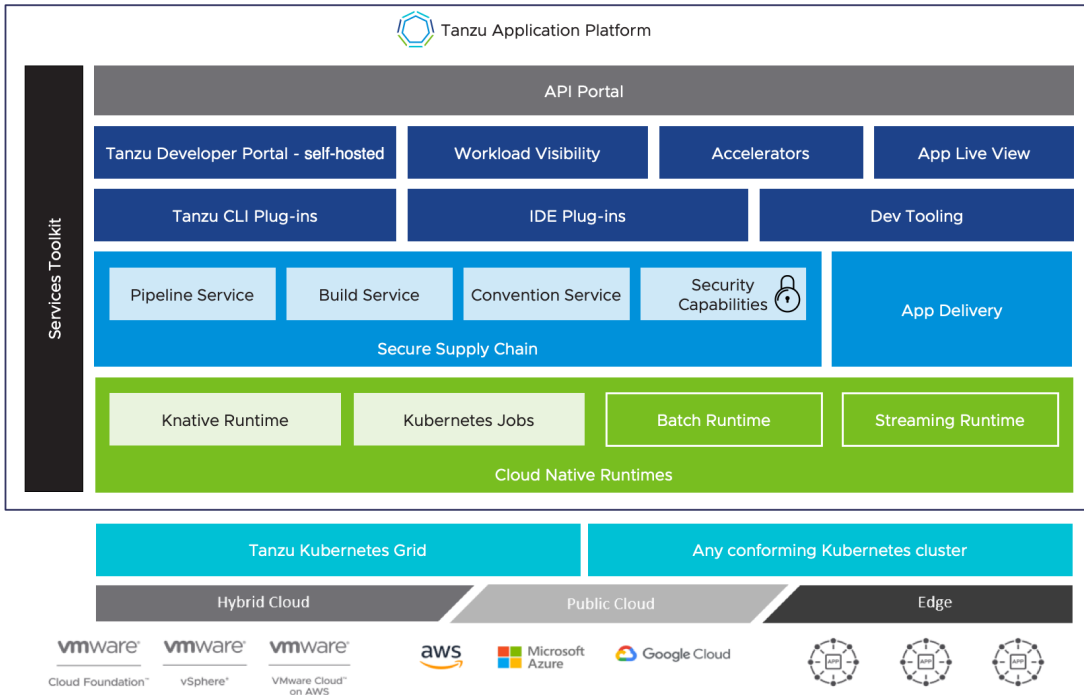

For more information about Tanzu Application Platform components, see [Components and installation profiles](#).

Notice of telemetry collection for Tanzu Application Platform

Tanzu Application Platform participates in the VMware Customer Experience Improvement Program (CEIP). As part of CEIP, VMware collects technical information about your organization’s use of VMware products and services in association with your organization’s VMware license keys. For information about CEIP, see the [Trust & Assurance Center](#).

You may join or leave CEIP at any time. The CEIP Standard Participation Level provides VMware with information to improve its products and services, identify and fix problems, and advise you on how to best deploy and use VMware products. For example, this information can enable a proactive product deployment discussion with your VMware account team or VMware support team to help resolve your issues. This information cannot directly identify any individual.

You must acknowledge that you have read the VMware CEIP policy before you can proceed with the installation. For more information, see [Install your Tanzu Application Platform profile](#). To opt out of telemetry participation after installation, see [Opting out of telemetry collection](#).

Tanzu Application Platform release notes



Important

Tanzu Application Platform v1.6 is no longer supported under the standard [VMware Tanzu Support Life Cycle Policy](#).

To stay up to date with the latest software and security updates, upgrade to a supported version. For supported upgrade paths, see the topic [Upgrade Tanzu Application Platform](#) in the version documentation that you want to upgrade to.

This topic contains release notes for Tanzu Application Platform v1.6.

v1.6.13

Release Date: 02 July 2024

v1.6.13 Breaking changes

This release includes the following changes, listed by component and area.

v1.6.13 Breaking changes: Tanzu Application Platform

- Tanzu Application Platform releases have migrated from VMware Tanzu Network to the Broadcom Support Portal and Broadcom registry. Using VMware Tanzu Network to install or upgrade Tanzu Application Platform is no longer supported.

Before you upgrade, you must relocate the Tanzu Application Platform images from the Broadcom registry tanzu.packages.broadcom.com to your own registry. Make sure you relocate the images to your container image registry as part of the instructions in [Upgrade Tanzu Application Platform](#).

v1.6.13 Security fixes

This release has the following security fixes, listed by package.

Package Name	Vulnerabilities Resolved
base-jammy-stack-lite.buildpacks.tanzu.vmware.com	<ul style="list-style-type: none"> ▼ Expand to see the list • CVE-2024-33602 • CVE-2024-33601 • CVE-2024-33600 • CVE-2024-33599 • CVE-2024-32465 • CVE-2024-32021 • CVE-2024-32020 • CVE-2024-32004 • CVE-2024-32002 • CVE-2024-26920 • CVE-2024-26916 • CVE-2024-26910 • CVE-2024-26829 • CVE-2024-26826 • CVE-2024-26825 • CVE-2024-26808 • CVE-2024-26722 • CVE-2024-26720 • CVE-2024-26717 • CVE-2024-26715 • CVE-2024-26712 • CVE-2024-26707 • CVE-2024-26704 • CVE-2024-26702 • CVE-2024-26698 • CVE-2024-26697 • CVE-2024-26696 • CVE-2024-26695 • CVE-2024-26689 • CVE-2024-26685 • CVE-2024-26684 • CVE-2024-26679 • CVE-2024-26676 • CVE-2024-26675 • CVE-2024-26673 • CVE-2024-26671 • CVE-2024-26668 • CVE-2024-26665 • CVE-2024-26664 • CVE-2024-26663 • CVE-2024-26660 • CVE-2024-26645

Package Name	Vulnerabilities Resolved
	<ul style="list-style-type: none"> • CVE-2024-26644 • CVE-2024-26641 • CVE-2024-26640 • CVE-2024-26636 • CVE-2024-26635 • CVE-2024-26627 • CVE-2024-26625 • CVE-2024-26622 • CVE-2024-26615 • CVE-2024-26614 • CVE-2024-26610 • CVE-2024-26608 • CVE-2024-26606 • CVE-2024-26602 • CVE-2024-26600 • CVE-2024-26594 • CVE-2024-26593 • CVE-2024-26592 • CVE-2024-23849 • CVE-2024-2201 • CVE-2024-1151 • CVE-2023-52643 • CVE-2023-52642 • CVE-2023-52638 • CVE-2023-52637 • CVE-2023-52635 • CVE-2023-52633 • CVE-2023-52631 • CVE-2023-52627 • CVE-2023-52623 • CVE-2023-52622 • CVE-2023-52619 • CVE-2023-52618 • CVE-2023-52617 • CVE-2023-52616 • CVE-2023-52615 • CVE-2023-52614 • CVE-2023-52608 • CVE-2023-52607 • CVE-2023-52606 • CVE-2023-52604 • CVE-2023-52602 • CVE-2023-52601

Package Name	Vulnerabilities Resolved
	<ul style="list-style-type: none">• CVE-2023-52599• CVE-2023-52598• CVE-2023-52597• CVE-2023-52595• CVE-2023-52594• CVE-2023-52588• CVE-2023-52587• CVE-2023-52530• CVE-2023-52498• CVE-2023-52494• CVE-2023-52493• CVE-2023-52492• CVE-2023-52491• CVE-2023-52489• CVE-2023-52486• CVE-2023-52435• CVE-2023-47233
<hr/> cert-manager.tanzu.vmware.com	<hr/> <p>▼ Expand to see the list</p> <ul style="list-style-type: none">• GHSA-4v7x-pqxf-cx7m• CVE-2023-39326 <hr/>

Package Name	Vulnerabilities Resolved
ootb-templates.tanzu.vmware.com	<ul style="list-style-type: none"> ▼ Expand to see the list • CVE-2024-2961 • CVE-2024-28835 • CVE-2024-28834 • CVE-2024-28757 • CVE-2024-28085 • CVE-2024-26633 • CVE-2024-26631 • CVE-2024-26598 • CVE-2024-26597 • CVE-2024-26591 • CVE-2024-26589 • CVE-2024-26586 • CVE-2024-26581 • CVE-2024-24860 • CVE-2024-24855 • CVE-2024-2398 • CVE-2024-23851 • CVE-2024-23850 • CVE-2024-23196 • CVE-2024-22705 • CVE-2024-22365 • CVE-2024-1086 • CVE-2024-1085 • CVE-2024-0775 • CVE-2024-0727 • CVE-2024-0646 • CVE-2024-0641 • CVE-2024-0639 • CVE-2024-0607 • CVE-2024-0567 • CVE-2024-0565 • CVE-2024-0553 • CVE-2024-0340 • CVE-2024-0193 • CVE-2023-7192 • CVE-2023-6932 • CVE-2023-6931 • CVE-2023-6918 • CVE-2023-6915 • CVE-2023-6817 • CVE-2023-6622 • CVE-2023-6606

Package Name	Vulnerabilities Resolved
	<ul style="list-style-type: none"> • CVE-2023-6546 • CVE-2023-6237 • CVE-2023-6176 • CVE-2023-6129 • CVE-2023-6121 • CVE-2023-6040 • CVE-2023-6039 • CVE-2023-6004 • CVE-2023-5981 • CVE-2023-5717 • CVE-2023-5678 • CVE-2023-5363 • CVE-2023-52628 • CVE-2023-52612 • CVE-2023-52610 • CVE-2023-52609 • CVE-2023-52603 • CVE-2023-52600 • CVE-2023-52581 • CVE-2023-52580 • CVE-2023-52573 • CVE-2023-52567 • CVE-2023-52564 • CVE-2023-52563 • CVE-2023-52529 • CVE-2023-52523 • CVE-2023-52520 • CVE-2023-52519 • CVE-2023-52515 • CVE-2023-52513 • CVE-2023-52474 • CVE-2023-52470 • CVE-2023-52469 • CVE-2023-52467 • CVE-2023-52464 • CVE-2023-52463 • CVE-2023-52462 • CVE-2023-52458 • CVE-2023-52457 • CVE-2023-52456 • CVE-2023-52454 • CVE-2023-52451 • CVE-2023-52449

Package Name	Vulnerabilities Resolved
	<ul style="list-style-type: none"> • CVE-2023-52448 • CVE-2023-52445 • CVE-2023-52444 • CVE-2023-52443 • CVE-2023-52442 • CVE-2023-52441 • CVE-2023-52436 • CVE-2023-52429 • CVE-2023-52425 • CVE-2023-52340 • CVE-2023-5197 • CVE-2023-5178 • CVE-2023-51782 • CVE-2023-51781 • CVE-2023-51780 • CVE-2023-51779 • CVE-2023-5158 • CVE-2023-5156 • CVE-2023-51043 • CVE-2023-51042 • CVE-2023-50868 • CVE-2023-50387 • CVE-2023-4921 • CVE-2023-4911 • CVE-2023-48795 • CVE-2023-4813 • CVE-2023-4806 • CVE-2023-47038 • CVE-2023-46862 • CVE-2023-46838 • CVE-2023-46813 • CVE-2023-4641 • CVE-2023-46343 • CVE-2023-4623 • CVE-2023-4622 • CVE-2023-46218 • CVE-2023-45871 • CVE-2023-45863 • CVE-2023-45862 • CVE-2023-4569 • CVE-2023-44487 • CVE-2023-44466 • CVE-2023-42756

Package Name	Vulnerabilities Resolved
	<ul style="list-style-type: none"> • CVE-2023-42755 • CVE-2023-42754 • CVE-2023-42753 • CVE-2023-42752 • CVE-2023-4273 • CVE-2023-4244 • CVE-2023-4208 • CVE-2023-4207 • CVE-2023-4206 • CVE-2023-4194 • CVE-2023-4155 • CVE-2023-4147 • CVE-2023-4134 • CVE-2023-4132 • CVE-2023-40283 • CVE-2023-4016 • CVE-2023-4015 • CVE-2023-4004 • CVE-2023-39804 • CVE-2023-39198 • CVE-2023-39197 • CVE-2023-39194 • CVE-2023-39193 • CVE-2023-39192 • CVE-2023-39189 • CVE-2023-3867 • CVE-2023-3866 • CVE-2023-3865 • CVE-2023-3863 • CVE-2023-38546 • CVE-2023-38545 • CVE-2023-38432 • CVE-2023-38431 • CVE-2023-38430 • CVE-2023-38429 • CVE-2023-38428 • CVE-2023-38427 • CVE-2023-38426 • CVE-2023-3817 • CVE-2023-3777 • CVE-2023-3776 • CVE-2023-3773 • CVE-2023-3772

Package Name	Vulnerabilities Resolved
	<ul style="list-style-type: none">• CVE-2023-37453• CVE-2023-3611• CVE-2023-3610• CVE-2023-3609• CVE-2023-36054• CVE-2023-35829• CVE-2023-35828• CVE-2023-35827• CVE-2023-35824• CVE-2023-35823• CVE-2023-35788• CVE-2023-3567• CVE-2023-35001• CVE-2023-3446• CVE-2023-3439• CVE-2023-34324• CVE-2023-34319• CVE-2023-34256• CVE-2023-3390• CVE-2023-3389• CVE-2023-3355• CVE-2023-3338• CVE-2023-33288• CVE-2023-33203• CVE-2023-3268• CVE-2023-32269• CVE-2023-32258• CVE-2023-32257• CVE-2023-32254• CVE-2023-32252• CVE-2023-32250• CVE-2023-32248• CVE-2023-32247• CVE-2023-32233• CVE-2023-3220• CVE-2023-3212• CVE-2023-3161• CVE-2023-31484• CVE-2023-31436• CVE-2023-3141• CVE-2023-31248• CVE-2023-31085• CVE-2023-31084

Package Name	Vulnerabilities Resolved
	<ul style="list-style-type: none"> • CVE-2023-31083 • CVE-2023-3090 • CVE-2023-30772 • CVE-2023-30456 • CVE-2023-2985 • CVE-2023-2975 • CVE-2023-2953 • CVE-2023-29491 • CVE-2023-29007 • CVE-2023-2898 • CVE-2023-28466 • CVE-2023-28322 • CVE-2023-28321 • CVE-2023-2650 • CVE-2023-2612 • CVE-2023-2603 • CVE-2023-2602 • CVE-2023-25815 • CVE-2023-25775 • CVE-2023-25652 • CVE-2023-25588 • CVE-2023-25585 • CVE-2023-25584 • CVE-2023-25012 • CVE-2023-24023 • CVE-2023-23004 • CVE-2023-23000 • CVE-2023-22995 • CVE-2023-2283 • CVE-2023-2269 • CVE-2023-2235 • CVE-2023-2194 • CVE-2023-2163 • CVE-2023-2162 • CVE-2023-2156 • CVE-2023-21400 • CVE-2023-21255 • CVE-2023-2124 • CVE-2023-20938 • CVE-2023-20593 • CVE-2023-20588 • CVE-2023-20569 • CVE-2023-2002

Package Name	Vulnerabilities Resolved
	<ul style="list-style-type: none"> • CVE-2023-1998 • CVE-2023-1990 • CVE-2023-1972 • CVE-2023-1859 • CVE-2023-1855 • CVE-2023-1670 • CVE-2023-1667 • CVE-2023-1611 • CVE-2023-1513 • CVE-2023-1380 • CVE-2023-1255 • CVE-2023-1206 • CVE-2023-1194 • CVE-2023-1192 • CVE-2023-1079 • CVE-2023-1078 • CVE-2023-1077 • CVE-2023-1076 • CVE-2023-1075 • CVE-2023-0597 • CVE-2023-0459 • CVE-2022-48522 • CVE-2022-48502 • CVE-2022-48425 • CVE-2022-48065 • CVE-2022-48063 • CVE-2022-47696 • CVE-2022-47695 • CVE-2022-47673 • CVE-2022-47011 • CVE-2022-47010 • CVE-2022-47008 • CVE-2022-47007 • CVE-2022-45919 • CVE-2022-45886 • CVE-2022-45703 • CVE-2022-44840 • CVE-2022-4285 • CVE-2022-4269 • CVE-2022-41715 • CVE-2022-40982 • CVE-2022-3715 • CVE-2022-3707

Package Name	Vulnerabilities Resolved
	<ul style="list-style-type: none"> • CVE-2022-36402 • CVE-2022-35205 • CVE-2022-27672

v1.6.13 Known issues

This release has the following known issues, listed by component and area.

v1.6.13 Known issues: Tanzu Application Platform

- This Tanzu Application Platform release is not supported with Tanzu Kubernetes releases (TKR) v1.26 on vSphere with Tanzu.

v1.6.13 Known issues: Artifact Metadata Repository Observer and CloudEvent Handler

- Periodic reconciliation or restarting of the AMR Observer causes reattempted posting of ImageVulnerabilityScan results. There is an error on duplicate submission of identical ImageVulnerabilityScans you can ignore if the previous submission was successful.
- ReplicaSet status in AMR only has two states: `created` and `deleted`. There is a known issue where the `available` and `unavailable` state is not showing. The workaround is that you can interpolate this information from the `instances` metadata in the AMR for the ReplicaSet.

v1.6.13 Known issues: Bitnami Services

- If you try to configure private registry integration for the Bitnami services after having already created a claim for one or more of the Bitnami services using the default configuration, the updated private registry configuration does not appear to take effect. This is due to caching behavior in the system which is not accounted for during configuration updates. For a workaround, see [Troubleshoot Bitnami Services](#).

v1.6.13 Known issues: Cloud Native Runtimes

- For Knative Serving, certain app name, namespace, and domain combinations produce Knative Services with status `CertificateNotReady`. For more information, see [Troubleshooting](#).

v1.6.13 Known issues: Crossplane

- Crossplane Providers cannot communicate with systems using a custom CA. For more information and a workaround, see [Troubleshoot Crossplane](#).
- The Crossplane `validatingwebhookconfiguration` is not removed when you uninstall the Crossplane Package. To workaround, delete the `validatingwebhookconfiguration` manually by running `kubectl delete validatingwebhookconfiguration crossplane`.

v1.6.13 Known issues: Eventing

- When using vSphere sources in Eventing, the vsphere-source is using a high number of informers to alleviate load on the API server. This causes high memory use.

v1.6.13 Known issues: Learning Center

- [CVE-2023-26114](#): Versions of VS Code server before v4.10.1 are vulnerable to Missing Origin Validation in WebSocket handshakes. For mitigation steps, see [Known issues for Learning Center](#).

v1.6.13 Known issues: Services Toolkit

- An error occurs if `additionalProperties` is `true` in a CompositeResourceDefinition. For more information and a workaround, see [Troubleshoot Services Toolkit](#).

v1.6.13 Known issues: Supply Chain Choreographer

- When using the Carvel Package Supply Chains, if the operator updates the parameter `carvel_package.name_suffix`, existing workloads incorrectly output a Carvel package to the GitOps repository that uses the old value of `carvel_package.name_suffix`. You can ignore or delete this package.
- If the size of the resulting OpenAPIv3 specification exceeds a certain size, approximately 3 KB, the Supply Chain does not function. If you use the default Carvel package parameters, you this issue does not occur. If you use custom Carvel package parameters, you might encounter this size limit. If you exceed the size limit, you can either deactivate this feature, or use a workaround. The workaround requires enabling a Tekton feature flag. For more information, see the [Tekton documentation](#).

v1.6.13 Known issues: Supply Chain Security Tools - Scan

- The Snyk scanner outputs an incorrectly created date, resulting in an invalid date. If the workload is in a failed state due to an invalid date, wait approximately 10 hours and the workload automatically goes into the ready state. For more information, see this [issue](#) in the Snyk Github repository.

v1.6.13 Supply Chain Security Tools - Store

- SCST - Store automatically detects PostgreSQL database index corruptions. If SCST - Store finds a PostgreSQL database index corruption issue, it does not reconcile. For how to fix this issue, see [Fix Postgres Database Index Corruption](#).

v1.6.13 Known issues: Tanzu Developer Portal (formerly named Tanzu Application Platform GUI)

- If you do not configure any authentication providers, and do not allow guest access, the following message appears when loading Tanzu Developer Portal in a browser:

```
No configured authentication providers. Please configure at least one.
```

To resolve this issue, see [Troubleshooting](#).

- Ad-blocking browser extensions and standalone ad-blocking software can interfere with telemetry collection within the VMware [Customer Experience Improvement Program](#) and restrict access to all or parts of Tanzu Developer Portal. For more information, see [Troubleshooting](#).
- `ScmAuth` is a Backstage concept that abstracts Source Code Management (SCM) authentication into a package. An oversight in a recent code-base migration led to the accidental exclusion of custom `ScmAuth` functions. This exclusion affected some client operations, such as using Application Accelerators to create Git repositories on behalf of users.

- The back-end Kubernetes plug-in reports failure in multicluster environments. In a multicluster environment when one request to a Kubernetes cluster fails, `backstage-kubernetes-backend` reports a failure to the front end. This is a known issue with upstream Backstage and it applies to all released versions of Tanzu Developer Portal. For more information, see [this Backstage code in GitHub](#). This behavior arises from the API at the Backstage level. There are currently no known workarounds. There are plans for upstream commits to Backstage to resolve this issue.

v1.6.13 Known issues: Tanzu Developer Portal - Supply Chain GUI plug-in

- Any workloads created by using a custom resource definition (CRD) might not work as expected. Only Out of the Box (OOTB) Supply Chains are supported in the UI.
- Downloading the SBOM from a vulnerability scan requires additional configuration in `tap-values.yaml`. For more information, see [Troubleshooting](#).

v1.6.13 Known issues: Tanzu Developer Tools for IntelliJ

- The error `com.vdurmont.semver4j.SemverException: Invalid version (no major version)` is shown in the error logs when attempting to perform a workload action before installing the Tanzu CLI apps plug-in.
- If you restart your computer while running Live Update without terminating the Tilt process beforehand, there is a lock that incorrectly shows that Live Update is still running and prevents it from starting again. For the fix, see [Troubleshooting](#).
- Workload actions and Live Update do not work when in a project with spaces in its name, such as `my app`, or in its path, such as `C:\Users\My User\my-app`. For more information, see [Troubleshooting](#).
- An **EDT Thread Exception** error is logged or reported as a notification with a message similar to `"com.intellij.diagnostic.PluginException: 2007 ms to call on EDT TanzuApplyAction#update@ProjectViewPopup"`. For more information, see [Troubleshooting](#).

v1.6.13 Known issues: Tanzu Developer Tools for Visual Studio

- Clicking the red square Stop button in the Visual Studio top toolbar can cause a workload to fail. For more information, see [Troubleshooting](#).

v1.6.13 Known issues: Tanzu Developer Tools for VS Code

- In the Tanzu activity panel, the `config-writer-pull-requester` of type `Runnable` is incorrectly categorized as **Unknown**. The correct category is **Supply Chain**.

v1.6.13 Component versions

The following table lists the Tanzu Application Platform package versions included with this release.

Component Name	Version
API Auto Registration	0.3.5
API portal	1.4.7
Application Accelerator	1.6.6
Application Configuration Service	2.1.4
Application Live View APIServer	1.6.3

Component Name	Version
Application Live View back end	1.6.4
Application Live View connector	1.6.4
Application Live View conventions	1.6.3
Application Single Sign-On	4.0.7
Artifact Metadata Repository Observer (alpha)	0.1.2
Bitnami Services	0.2.0
Carbon Black Scanner for SCST - Scan (beta)	1.2.5
Cartographer Conventions	0.7.5
cert-manager	2.4.8
Cloud Native Runtimes	2.3.14
Contour	2.0.0
Crossplane	0.2.2
Default Roles	1.1.0
Developer Conventions	0.11.2
Eventing (deprecated)	2.2.10
External Secrets Operator	0.6.1+tap.6
Flux CD Source Controller	0.36.1+tanzu.2
Grype Scanner for SCST - Scan	1.6.140
Learning Center (deprecated)	0.3.2
Learning Center workshops (deprecated)	0.3.1
Local Source Proxy	0.1.1
Namespace Provisioner	0.4.1
Out of the Box Delivery - Basic	0.13.21
Out of the Box Supply Chain - Basic	0.13.21
Out of the Box Supply Chain - Testing	0.13.21
Out of the Box Supply Chain - Testing and Scanning	0.13.21
Out of the Box Templates	0.13.21
Service Bindings	0.9.4
Services Toolkit	0.11.1
Snyk Scanner for SCST - Scan (beta)	1.0.0-beta.156
Source Controller	0.8.4
Spring Boot conventions	1.6.3
Spring Cloud Gateway	2.0.12
Supply Chain Choreographer	0.7.5
Supply Chain Security Tools - Policy Controller	1.4.2

Component Name	Version
Supply Chain Security Tools - Scan	1.6.141
Supply Chain Security Tools - Scan 2.0 (beta)	0.1.0-beta.137
Supply Chain Security Tools - Store	1.6.14
Tanzu Application Platform Telemetry	0.6.2
Tanzu Build Service	1.11.18
Tanzu CLI	1.3.0
Tanzu Developer Portal (formerly Tanzu Application Platform GUI)	1.6.8
Tanzu Developer Portal Configurator (beta)	0.1.2
Tekton Pipelines	0.41.0+tap.9

v1.6.12

Release Date: 11 June 2024

v1.6.12 Security fixes

This release has the following security fixes, listed by package.

Package Name	Vulnerabilities Resolved
base-jammy-stack-lite.buildpacks.tanzu.vmware.com	<ul style="list-style-type: none"> ▼ Expand to see the list • CVE-2024-26920 • CVE-2024-26916 • CVE-2024-26910 • CVE-2024-26829 • CVE-2024-26826 • CVE-2024-26825 • CVE-2024-26808 • CVE-2024-26722 • CVE-2024-26720 • CVE-2024-26717 • CVE-2024-26715 • CVE-2024-26712 • CVE-2024-26707 • CVE-2024-26704 • CVE-2024-26702 • CVE-2024-26698 • CVE-2024-26697 • CVE-2024-26696 • CVE-2024-26695 • CVE-2024-26689 • CVE-2024-26685 • CVE-2024-26684 • CVE-2024-26679 • CVE-2024-26676 • CVE-2024-26675 • CVE-2024-26673 • CVE-2024-26671 • CVE-2024-26668 • CVE-2024-26665 • CVE-2024-26664 • CVE-2024-26663 • CVE-2024-26660 • CVE-2024-26645 • CVE-2024-26644 • CVE-2024-26641 • CVE-2024-26640 • CVE-2024-26636 • CVE-2024-26635 • CVE-2024-26627 • CVE-2024-26625 • CVE-2024-26615 • CVE-2024-26614

Package Name	Vulnerabilities Resolved
	<ul style="list-style-type: none"> • CVE-2024-26610 • CVE-2024-26608 • CVE-2024-26606 • CVE-2024-26602 • CVE-2024-26600 • CVE-2024-26594 • CVE-2024-26593 • CVE-2024-26592 • CVE-2024-23849 • CVE-2024-2201 • CVE-2024-1151 • CVE-2023-52643 • CVE-2023-52642 • CVE-2023-52638 • CVE-2023-52637 • CVE-2023-52635 • CVE-2023-52633 • CVE-2023-52631 • CVE-2023-52627 • CVE-2023-52623 • CVE-2023-52622 • CVE-2023-52619 • CVE-2023-52618 • CVE-2023-52617 • CVE-2023-52616 • CVE-2023-52615 • CVE-2023-52614 • CVE-2023-52608 • CVE-2023-52607 • CVE-2023-52606 • CVE-2023-52604 • CVE-2023-52602 • CVE-2023-52601 • CVE-2023-52599 • CVE-2023-52598 • CVE-2023-52597 • CVE-2023-52595 • CVE-2023-52594 • CVE-2023-52588 • CVE-2023-52587 • CVE-2023-52498 • CVE-2023-52494 • CVE-2023-52493

Package Name	Vulnerabilities Resolved
	<ul style="list-style-type: none"><li data-bbox="909 219 1109 246">• CVE-2023-52492<li data-bbox="909 257 1109 284">• CVE-2023-52491<li data-bbox="909 295 1109 322">• CVE-2023-52489<li data-bbox="909 333 1109 360">• CVE-2023-52486<li data-bbox="909 371 1109 398">• CVE-2023-52435
cert-manager.tanzu.vmware.com	<p data-bbox="845 436 1077 463">▼ Expand to see the list</p> <ul style="list-style-type: none"><li data-bbox="909 474 1157 501">• GHSA-4v7x-pqxf-cx7m<li data-bbox="909 512 1109 539">• CVE-2023-39326

Package Name	Vulnerabilities Resolved
ootb-templates.tanzu.vmware.com	<ul style="list-style-type: none"> ▼ Expand to see the list • CVE-2024-28757 • CVE-2024-28085 • CVE-2024-24855 • CVE-2024-2398 • CVE-2024-22365 • CVE-2024-1086 • CVE-2024-1085 • CVE-2024-0727 • CVE-2024-0646 • CVE-2024-0641 • CVE-2024-0607 • CVE-2024-0567 • CVE-2024-0565 • CVE-2024-0553 • CVE-2024-0340 • CVE-2024-0193 • CVE-2023-7192 • CVE-2023-6932 • CVE-2023-6931 • CVE-2023-6918 • CVE-2023-6817 • CVE-2023-6622 • CVE-2023-6606 • CVE-2023-6546 • CVE-2023-6237 • CVE-2023-6176 • CVE-2023-6129 • CVE-2023-6121 • CVE-2023-6040 • CVE-2023-6039 • CVE-2023-6004 • CVE-2023-5981 • CVE-2023-5717 • CVE-2023-5678 • CVE-2023-5363 • CVE-2023-52425 • CVE-2023-5197 • CVE-2023-5178 • CVE-2023-51782 • CVE-2023-51781 • CVE-2023-51780 • CVE-2023-51779

Package Name	Vulnerabilities Resolved
	<ul style="list-style-type: none"> • CVE-2023-5158 • CVE-2023-5156 • CVE-2023-50868 • CVE-2023-50387 • CVE-2023-4921 • CVE-2023-4911 • CVE-2023-48795 • CVE-2023-4813 • CVE-2023-4806 • CVE-2023-47038 • CVE-2023-46862 • CVE-2023-46813 • CVE-2023-4641 • CVE-2023-46343 • CVE-2023-4623 • CVE-2023-4622 • CVE-2023-46218 • CVE-2023-45871 • CVE-2023-45863 • CVE-2023-45862 • CVE-2023-4569 • CVE-2023-44487 • CVE-2023-44466 • CVE-2023-42756 • CVE-2023-42755 • CVE-2023-42754 • CVE-2023-42753 • CVE-2023-42752 • CVE-2023-4273 • CVE-2023-4244 • CVE-2023-4208 • CVE-2023-4207 • CVE-2023-4206 • CVE-2023-4194 • CVE-2023-4155 • CVE-2023-4147 • CVE-2023-4134 • CVE-2023-4132 • CVE-2023-4128 • CVE-2023-40283 • CVE-2023-4016 • CVE-2023-4015 • CVE-2023-4004

Package Name	Vulnerabilities Resolved
	<ul style="list-style-type: none"> • CVE-2023-3995 • CVE-2023-39804 • CVE-2023-39198 • CVE-2023-39197 • CVE-2023-39194 • CVE-2023-39193 • CVE-2023-39192 • CVE-2023-39189 • CVE-2023-3866 • CVE-2023-3865 • CVE-2023-3863 • CVE-2023-38546 • CVE-2023-38545 • CVE-2023-38432 • CVE-2023-38429 • CVE-2023-38428 • CVE-2023-38426 • CVE-2023-3817 • CVE-2023-3777 • CVE-2023-3776 • CVE-2023-3773 • CVE-2023-3772 • CVE-2023-37453 • CVE-2023-3611 • CVE-2023-3610 • CVE-2023-3609 • CVE-2023-36054 • CVE-2023-35829 • CVE-2023-35828 • CVE-2023-35827 • CVE-2023-35824 • CVE-2023-35823 • CVE-2023-35788 • CVE-2023-3567 • CVE-2023-35001 • CVE-2023-3446 • CVE-2023-3439 • CVE-2023-34324 • CVE-2023-34319 • CVE-2023-34256 • CVE-2023-3390 • CVE-2023-3389 • CVE-2023-3355

Package Name	Vulnerabilities Resolved
	<ul style="list-style-type: none">• CVE-2023-3338• CVE-2023-33288• CVE-2023-33203• CVE-2023-3268• CVE-2023-32269• CVE-2023-32257• CVE-2023-32252• CVE-2023-32250• CVE-2023-32248• CVE-2023-32247• CVE-2023-32233• CVE-2023-3220• CVE-2023-3212• CVE-2023-3161• CVE-2023-31484• CVE-2023-31436• CVE-2023-3141• CVE-2023-31248• CVE-2023-3117• CVE-2023-31085• CVE-2023-31084• CVE-2023-31083• CVE-2023-3090• CVE-2023-30772• CVE-2023-30456• CVE-2023-2985• CVE-2023-2975• CVE-2023-2953• CVE-2023-29491• CVE-2023-29007• CVE-2023-2898• CVE-2023-28466• CVE-2023-28322• CVE-2023-28321• CVE-2023-2650• CVE-2023-2612• CVE-2023-2603• CVE-2023-2602• CVE-2023-25815• CVE-2023-25775• CVE-2023-25652• CVE-2023-25588• CVE-2023-25585

Package Name	Vulnerabilities Resolved
	<ul style="list-style-type: none"> • CVE-2023-25584 • CVE-2023-25012 • CVE-2023-23004 • CVE-2023-23000 • CVE-2023-22995 • CVE-2023-2283 • CVE-2023-2269 • CVE-2023-2235 • CVE-2023-2194 • CVE-2023-2163 • CVE-2023-2162 • CVE-2023-2156 • CVE-2023-21400 • CVE-2023-21255 • CVE-2023-2124 • CVE-2023-20938 • CVE-2023-20593 • CVE-2023-20588 • CVE-2023-20569 • CVE-2023-2002 • CVE-2023-1998 • CVE-2023-1990 • CVE-2023-1972 • CVE-2023-1859 • CVE-2023-1855 • CVE-2023-1670 • CVE-2023-1667 • CVE-2023-1611 • CVE-2023-1513 • CVE-2023-1380 • CVE-2023-1255 • CVE-2023-1206 • CVE-2023-1192 • CVE-2023-1079 • CVE-2023-1078 • CVE-2023-1077 • CVE-2023-1076 • CVE-2023-1075 • CVE-2023-0597 • CVE-2023-0459 • CVE-2022-48522 • CVE-2022-48502 • CVE-2022-48425

Package Name	Vulnerabilities Resolved
	<ul style="list-style-type: none"> • CVE-2022-48065 • CVE-2022-48063 • CVE-2022-47696 • CVE-2022-47695 • CVE-2022-47673 • CVE-2022-47011 • CVE-2022-47010 • CVE-2022-47008 • CVE-2022-47007 • CVE-2022-45919 • CVE-2022-45886 • CVE-2022-45703 • CVE-2022-44840 • CVE-2022-4285 • CVE-2022-4269 • CVE-2022-40982 • CVE-2022-3715 • CVE-2022-3707 • CVE-2022-35205 • CVE-2022-27672

v1.6.12 Known issues

This release has the following known issues, listed by component and area.

v1.6.12 Known issues: Tanzu Application Platform

- This Tanzu Application Platform release is not supported with Tanzu Kubernetes releases (TKR) v1.26 on vSphere with Tanzu.

v1.6.12 Known issues: Artifact Metadata Repository Observer and CloudEvent Handler

- Periodic reconciliation or restarting of the AMR Observer causes reattempted posting of ImageVulnerabilityScan results. There is an error on duplicate submission of identical ImageVulnerabilityScans you can ignore if the previous submission was successful.
- ReplicaSet status in AMR only has two states: `created` and `deleted`. There is a known issue where the `available` and `unavailable` state is not showing. The workaround is that you can interpolate this information from the `instances` metadata in the AMR for the ReplicaSet.

v1.6.12 Known issues: Bitnami Services

- If you try to configure private registry integration for the Bitnami services after having already created a claim for one or more of the Bitnami services using the default configuration, the updated private registry configuration does not appear to take effect. This is due to caching behavior in the system which is not accounted for during configuration updates. For a workaround, see [Troubleshoot Bitnami Services](#).

v1.6.12 Known issues: Cloud Native Runtimes

- For Knative Serving, certain app name, namespace, and domain combinations produce Knative Services with status `CertificateNotReady`. For more information, see [Troubleshooting](#).

v1.6.12 Known issues: Crossplane

- Crossplane Providers cannot communicate with systems using a custom CA. For more information and a workaround, see [Troubleshoot Crossplane](#).
- The Crossplane `validatingwebhookconfiguration` is not removed when you uninstall the Crossplane Package. To workaround, delete the `validatingwebhookconfiguration` manually by running `kubectl delete validatingwebhookconfiguration crossplane`.

v1.6.12 Known issues: Eventing

- When using vSphere sources in Eventing, the vsphere-source is using a high number of informers to alleviate load on the API server. This causes high memory use.

v1.6.12 Known issues: Learning Center

- [CVE-2023-26114](#): Versions of VS Code server before v4.10.1 are vulnerable to Missing Origin Validation in WebSocket handshakes. For mitigation steps, see [Known issues for Learning Center](#).

v1.6.12 Known issues: Services Toolkit

- An error occurs if `additionalProperties` is `true` in a CompositeResourceDefinition. For more information and a workaround, see [Troubleshoot Services Toolkit](#).

v1.6.12 Known issues: Supply Chain Choreographer

- When using the Carvel Package Supply Chains, if the operator updates the parameter `carvel_package.name_suffix`, existing workloads incorrectly output a Carvel package to the GitOps repository that uses the old value of `carvel_package.name_suffix`. You can ignore or delete this package.
- If the size of the resulting OpenAPIv3 specification exceeds a certain size, approximately 3 KB, the Supply Chain does not function. If you use the default Carvel package parameters, you this issue does not occur. If you use custom Carvel package parameters, you might encounter this size limit. If you exceed the size limit, you can either deactivate this feature, or use a workaround. The workaround requires enabling a Tekton feature flag. For more information, see the [Tekton documentation](#).

v1.6.12 Known issues: Supply Chain Security Tools - Scan

- The Snyk scanner outputs an incorrectly created date, resulting in an invalid date. If the workload is in a failed state due to an invalid date, wait approximately 10 hours and the workload automatically goes into the ready state. For more information, see this [issue](#) in the Snyk Github repository.

v1.6.12 Supply Chain Security Tools - Store

- SCST - Store automatically detects PostgreSQL database index corruptions. If SCST - Store finds a PostgreSQL database index corruption issue, it does not reconcile. For how to fix this issue, see [Fix Postgres Database Index Corruption](#).

v1.6.12 Known issues: Tanzu Developer Portal (formerly named Tanzu Application Platform GUI)

- If you do not configure any authentication providers, and do not allow guest access, the following message appears when loading Tanzu Developer Portal in a browser:

```
No configured authentication providers. Please configure at least one.
```

To resolve this issue, see [Troubleshooting](#).

- Ad-blocking browser extensions and standalone ad-blocking software can interfere with telemetry collection within the VMware [Customer Experience Improvement Program](#) and restrict access to all or parts of Tanzu Developer Portal. For more information, see [Troubleshooting](#).
- [ScmAuth](#) is a Backstage concept that abstracts Source Code Management (SCM) authentication into a package. An oversight in a recent code-base migration led to the accidental exclusion of custom ScmAuth functions. This exclusion affected some client operations, such as using Application Accelerators to create Git repositories on behalf of users.
- The back-end Kubernetes plug-in reports failure in multicluster environments. In a multicluster environment when one request to a Kubernetes cluster fails, `backstage-kubernetes-backend` reports a failure to the front end. This is a known issue with upstream Backstage and it applies to all released versions of Tanzu Developer Portal. For more information, see [this Backstage code in GitHub](#). This behavior arises from the API at the Backstage level. There are currently no known workarounds. There are plans for upstream commits to Backstage to resolve this issue.

v1.6.12 Known issues: Tanzu Developer Portal - Supply Chain GUI plug-in

- Any workloads created by using a custom resource definition (CRD) might not work as expected. Only Out of the Box (OOTB) Supply Chains are supported in the UI.
- Downloading the SBOM from a vulnerability scan requires additional configuration in `tap-values.yaml`. For more information, see [Troubleshooting](#).

v1.6.12 Known issues: Tanzu Developer Tools for IntelliJ

- The error `com.vdurmont.semver4j.SemverException: Invalid version (no major version)` is shown in the error logs when attempting to perform a workload action before installing the Tanzu CLI apps plug-in.
- If you restart your computer while running Live Update without terminating the Tilt process beforehand, there is a lock that incorrectly shows that Live Update is still running and prevents it from starting again. For the fix, see [Troubleshooting](#).
- Workload actions and Live Update do not work when in a project with spaces in its name, such as `my app`, or in its path, such as `C:\Users\My User\my-app`. For more information, see [Troubleshooting](#).
- An **EDT Thread Exception** error is logged or reported as a notification with a message similar to `"com.intellij.diagnostic.PluginException: 2007 ms to call on EDT TanzuApplyAction#update@ProjectViewPopup"`. For more information, see [Troubleshooting](#).

v1.6.12 Known issues: Tanzu Developer Tools for Visual Studio

- Clicking the red square Stop button in the Visual Studio top toolbar can cause a workload to fail. For more information, see [Troubleshooting](#).

v1.6.12 Known issues: Tanzu Developer Tools for VS Code

- In the Tanzu activity panel, the `config-writer-pull-requester` of type `Runnable` is incorrectly categorized as **Unknown**. The correct category is **Supply Chain**.

v1.6.12 Component versions

The following table lists the supported component versions for this Tanzu Application Platform release.

Component Name	Version
API Auto Registration	0.3.5
API portal	1.4.7
Application Accelerator	1.6.6
Application Configuration Service	2.1.4
Application Live View APIServer	1.6.3
Application Live View back end	1.6.4
Application Live View connector	1.6.4
Application Live View conventions	1.6.3
Application Single Sign-On	4.0.7
Artifact Metadata Repository Observer (alpha)	0.1.2
Bitnami Services	0.2.0
Carbon Black Scanner for SCST - Scan (beta)	1.2.5
Cartographer Conventions	0.7.5
cert-manager	2.4.8
Cloud Native Runtimes	2.3.14
Contour	2.0.0
Crossplane	0.2.2
Default Roles	1.1.0
Developer Conventions	0.11.2
Eventing (deprecated)	2.2.10
External Secrets Operator	0.6.1+tap.6
Flux CD Source Controller	0.36.1+tanzu.2
Grype Scanner for SCST - Scan	1.6.140
Learning Center (deprecated)	0.3.2
Learning Center workshops (deprecated)	0.3.1
Local Source Proxy	0.1.1
Namespace Provisioner	0.4.1
Out of the Box Delivery - Basic	0.13.21
Out of the Box Supply Chain - Basic	0.13.21

Component Name	Version
Out of the Box Supply Chain - Testing	0.13.21
Out of the Box Supply Chain - Testing and Scanning	0.13.21
Out of the Box Templates	0.13.21
Service Bindings	0.9.4
Services Toolkit	0.11.1
Snyk Scanner for SCST - Scan (beta)	1.0.0-beta.156
Source Controller	0.8.4
Spring Boot conventions	1.6.3
Spring Cloud Gateway	2.0.12
Supply Chain Choreographer	0.7.5
Supply Chain Security Tools - Policy Controller	1.4.2
Supply Chain Security Tools - Scan	1.6.141
Supply Chain Security Tools - Scan 2.0 (beta)	0.1.0-beta.137
Supply Chain Security Tools - Store	1.6.13
Tanzu Application Platform Telemetry	0.6.2
Tanzu Build Service	1.11.18
Tanzu CLI	1.3.0
Tanzu Developer Portal (formerly Tanzu Application Platform GUI)	1.6.8
Tanzu Developer Portal Configurator (beta)	0.1.2
Tekton Pipelines	0.41.0+tap.9

v1.6.11

Release Date: 07 May 2024

v1.6.11 Security fixes

This release has the following security fixes, listed by package.

Package Name	Vulnerabilities Resolved
base-jammy-stack-lite.buildpacks.tanzu.vmware.com	<ul style="list-style-type: none"> ▼ Expand to see the list • CVE-2024-2961 • CVE-2024-28835 • CVE-2024-28834 • CVE-2024-28085 • CVE-2024-26633 • CVE-2024-26631 • CVE-2024-26598 • CVE-2024-26597 • CVE-2024-26591 • CVE-2024-26589 • CVE-2024-26586 • CVE-2024-26581 • CVE-2024-24860 • CVE-2024-2398 • CVE-2024-23851 • CVE-2024-23850 • CVE-2024-22705 • CVE-2023-52612 • CVE-2023-52610 • CVE-2023-52609 • CVE-2023-52603 • CVE-2023-52600 • CVE-2023-52480 • CVE-2023-52470 • CVE-2023-52469 • CVE-2023-52467 • CVE-2023-52464 • CVE-2023-52463 • CVE-2023-52462 • CVE-2023-52458 • CVE-2023-52457 • CVE-2023-52456 • CVE-2023-52454 • CVE-2023-52451 • CVE-2023-52449 • CVE-2023-52448 • CVE-2023-52445 • CVE-2023-52444 • CVE-2023-52443 • CVE-2023-52442 • CVE-2023-52441 • CVE-2023-52436

Package Name	Vulnerabilities Resolved
	<ul style="list-style-type: none"> • CVE-2023-52429 • CVE-2023-52340 • CVE-2023-46838 • CVE-2023-3867 • CVE-2023-38431 • CVE-2023-38430 • CVE-2023-38427 • CVE-2023-32258 • CVE-2023-32254 • CVE-2023-24023 • CVE-2023-1194
cert-manager.tanzu.vmware.com	<p>▼ Expand to see the list</p> <ul style="list-style-type: none"> • GHSA-8r3f-844c-mc37 • GHSA-45x7-px36-x8w8
metadata-store.apps.tanzu.vmware.com	<p>▼ Expand to see the list</p> <ul style="list-style-type: none"> • GHSA-qppj-fm5r-hxr3 • GHSA-m425-mq94-257g • GHSA-45x7-px36-x8w8 • CVE-2024-25062 • CVE-2023-7104 • CVE-2023-4911 • CVE-2023-47038 • CVE-2023-44487 • CVE-2023-39325 • CVE-2023-39323 • CVE-2023-29939 • CVE-2023-29934 • CVE-2023-29932 • CVE-2023-2953 • CVE-2022-48522 • CVE-2022-46908
sso.apps.tanzu.vmware.com	<p>▼ Expand to see the list</p> <ul style="list-style-type: none"> • GHSA-v682-8vv8-vpwr • GHSA-hgjh-9rj2-g67j • GHSA-f3jh-qvm4-mg39 • GHSA-7w75-32cg-r6g2 • GHSA-2wrp-6fg6-hmc5 • CVE-2024-24549 • CVE-2024-23672

v1.6.11 Known issues

This release has the following known issues, listed by component and area.

v1.6.11 Known issues: Tanzu Application Platform

- This Tanzu Application Platform release is not supported with Tanzu Kubernetes releases (TKR) v1.26 on vSphere with Tanzu.

v1.6.11 Known issues: Artifact Metadata Repository Observer and CloudEvent Handler

- Periodic reconciliation or restarting of the AMR Observer causes reattempted posting of ImageVulnerabilityScan results. There is an error on duplicate submission of identical ImageVulnerabilityScans you can ignore if the previous submission was successful.
- ReplicaSet status in AMR only has two states: `created` and `deleted`. There is a known issue where the `available` and `unavailable` state is not showing. The workaround is that you can interpolate this information from the `instances` metadata in the AMR for the ReplicaSet.

v1.6.11 Known issues: Bitnami Services

- If you try to configure private registry integration for the Bitnami services after having already created a claim for one or more of the Bitnami services using the default configuration, the updated private registry configuration does not appear to take effect. This is due to caching behavior in the system which is not accounted for during configuration updates. For a workaround, see [Troubleshoot Bitnami Services](#).

v1.6.11 Known issues: Cloud Native Runtimes

- For Knative Serving, certain app name, namespace, and domain combinations produce Knative Services with status `CertificateNotReady`. For more information, see [Troubleshooting](#).

v1.6.11 Known issues: Crossplane

- Crossplane Providers cannot communicate with systems using a custom CA. For more information and a workaround, see [Troubleshoot Crossplane](#).
- The Crossplane `validatingwebhookconfiguration` is not removed when you uninstall the Crossplane Package. To workaround, delete the `validatingwebhookconfiguration` manually by running `kubectl delete validatingwebhookconfiguration crossplane`.

v1.6.11 Known issues: Eventing

- When using vSphere sources in Eventing, the vsphere-source is using a high number of informers to alleviate load on the API server. This causes high memory use.

v1.6.11 Known issues: Learning Center

- [CVE-2023-26114](#): Versions of VS Code server before v4.10.1 are vulnerable to Missing Origin Validation in WebSocket handshakes. For mitigation steps, see [Known issues for Learning Center](#).

v1.6.11 Known issues: Services Toolkit

- An error occurs if `additionalProperties` is `true` in a CompositeResourceDefinition. For more information and a workaround, see [Troubleshoot Services Toolkit](#).

v1.6.11 Known issues: Supply Chain Choreographer

- When using the Carvel Package Supply Chains, if the operator updates the parameter `carvel_package.name_suffix`, existing workloads incorrectly output a Carvel package to the GitOps repository that uses the old value of `carvel_package.name_suffix`. You can ignore or delete this package.
- If the size of the resulting OpenAPIv3 specification exceeds a certain size, approximately 3 KB, the Supply Chain does not function. If you use the default Carvel package parameters, you this issue does not occur. If you use custom Carvel package parameters, you might encounter this size limit. If you exceed the size limit, you can either deactivate this feature, or use a workaround. The workaround requires enabling a Tekton feature flag. For more information, see the [Tekton documentation](#).

v1.6.11 Known issues: Supply Chain Security Tools - Scan

- The Snyk scanner outputs an incorrectly created date, resulting in an invalid date. If the workload is in a failed state due to an invalid date, wait approximately 10 hours and the workload automatically goes into the ready state. For more information, see this [issue](#) in the Snyk Github repository.

v1.6.11 Supply Chain Security Tools - Store

- SCST - Store automatically detects PostgreSQL database index corruptions. If SCST - Store finds a PostgreSQL database index corruption issue, it does not reconcile. For how to fix this issue, see [Fix Postgres Database Index Corruption](#).

v1.6.11 Known issues: Tanzu Developer Portal (formerly named Tanzu Application Platform GUI)

- If you do not configure any authentication providers, and do not allow guest access, the following message appears when loading Tanzu Developer Portal in a browser:

```
No configured authentication providers. Please configure at least one.
```

To resolve this issue, see [Troubleshooting](#).

- Ad-blocking browser extensions and standalone ad-blocking software can interfere with telemetry collection within the VMware [Customer Experience Improvement Program](#) and restrict access to all or parts of Tanzu Developer Portal. For more information, see [Troubleshooting](#).
- [ScmAuth](#) is a Backstage concept that abstracts Source Code Management (SCM) authentication into a package. An oversight in a recent code-base migration led to the accidental exclusion of custom ScmAuth functions. This exclusion affected some client operations, such as using Application Accelerators to create Git repositories on behalf of users.
- The back-end Kubernetes plug-in reports failure in multicluster environments. In a multicluster environment when one request to a Kubernetes cluster fails, `backstage-kubernetes-backend` reports a failure to the front end. This is a known issue with upstream Backstage and it applies to all released versions of Tanzu Developer Portal. For more information, see [this Backstage code in GitHub](#). This behavior arises from the API at the Backstage level. There are currently no known workarounds. There are plans for upstream commits to Backstage to resolve this issue.

v1.6.11 Known issues: Tanzu Developer Portal - Supply Chain GUI plug-in

- Any workloads created by using a custom resource definition (CRD) might not work as expected. Only Out of the Box (OOTB) Supply Chains are supported in the UI.
- Downloading the SBOM from a vulnerability scan requires additional configuration in `tap-values.yaml`. For more information, see [Troubleshooting](#).

v1.6.11 Known issues: Tanzu Developer Tools for IntelliJ

- The error `com.vdurmont.semver4j.SemverException: Invalid version (no major version)` is shown in the error logs when attempting to perform a workload action before installing the Tanzu CLI apps plug-in.
- If you restart your computer while running Live Update without terminating the Tilt process beforehand, there is a lock that incorrectly shows that Live Update is still running and prevents it from starting again. For the fix, see [Troubleshooting](#).
- Workload actions and Live Update do not work when in a project with spaces in its name, such as `my app`, or in its path, such as `C:\Users\My User\my-app`. For more information, see [Troubleshooting](#).
- An **EDT Thread Exception** error is logged or reported as a notification with a message similar to `"com.intellij.diagnostic.PluginException: 2007 ms to call on EDT TanzuApplyAction#update@ProjectViewPopup"`. For more information, see [Troubleshooting](#).

v1.6.11 Known issues: Tanzu Developer Tools for Visual Studio

- Clicking the red square Stop button in the Visual Studio top toolbar can cause a workload to fail. For more information, see [Troubleshooting](#).

v1.6.11 Known issues: Tanzu Developer Tools for VS Code

- In the Tanzu activity panel, the `config-writer-pull-requester` of type `Runnable` is incorrectly categorized as **Unknown**. The correct category is **Supply Chain**.

v1.6.11 Component versions

The following table lists the supported component versions for this Tanzu Application Platform release.

Component Name	Version
API Auto Registration	0.3.5
API portal	1.4.7
Application Accelerator	1.6.6
Application Configuration Service	2.1.4
Application Live View APIServer	1.6.3
Application Live View back end	1.6.4
Application Live View connector	1.6.4
Application Live View conventions	1.6.3
Application Single Sign-On	4.0.7
Artifact Metadata Repository Observer (alpha)	0.1.2
Bitnami Services	0.2.0

Component Name	Version
Carbon Black Scanner for SCST - Scan (beta)	1.2.5
Cartographer Conventions	0.7.5
cert-manager	2.4.5
Cloud Native Runtimes	2.3.14
Contour	2.0.0
Crossplane	0.2.1
Default Roles	1.1.0
Developer Conventions	0.11.2
Eventing (deprecated)	2.2.10
External Secrets Operator	0.6.1+tap.6
Flux CD Source Controller	0.36.1+tanzu.2
Grype Scanner for SCST - Scan	1.6.140
Learning Center (deprecated)	0.3.2
Learning Center workshops (deprecated)	0.3.1
Local Source Proxy	0.1.1
Namespace Provisioner	0.4.1
Out of the Box Delivery - Basic	0.13.18
Out of the Box Supply Chain - Basic	0.13.18
Out of the Box Supply Chain - Testing	0.13.18
Out of the Box Supply Chain - Testing and Scanning	0.13.18
Out of the Box Templates	0.13.18
Service Bindings	0.9.4
Services Toolkit	0.11.1
Snyk Scanner for SCST - Scan (beta)	1.0.0-beta.156
Source Controller	0.8.4
Spring Boot conventions	1.6.3
Spring Cloud Gateway	2.0.12
Supply Chain Choreographer	0.7.5
Supply Chain Security Tools - Policy Controller	1.4.2
Supply Chain Security Tools - Scan	1.6.141
Supply Chain Security Tools - Scan 2.0 (beta)	0.1.0-beta.137
Supply Chain Security Tools - Store	1.6.13
Tanzu Application Platform Telemetry	0.6.2
Tanzu Build Service	1.11.18
Tanzu CLI	1.3.0

Component Name	Version
Tanzu Developer Portal (formerly Tanzu Application Platform GUI)	1.6.8
Tanzu Developer Portal Configurator (beta)	0.1.2
Tekton Pipelines	0.41.0+tap.9

v1.6.10

Release Date: 09 April 2024

v1.6.10 Security fixes

This release has the following security fixes, listed by package.

Package Name	Vulnerabilities Resolved
apiserver.appliveview.tanzu.vmware.com	▼ Expand to see the list <ul style="list-style-type: none"> • CVE-2024-0727 • CVE-2023-6237 • CVE-2023-6129 • CVE-2023-5678 • CVE-2023-5363 • CVE-2023-5156 • CVE-2023-4813 • CVE-2023-4806 • CVE-2023-3817 • CVE-2023-3446 • CVE-2023-2975

Package Name	Vulnerabilities Resolved
base-jammy-stack-lite.buildpacks.tanzu.vmware.com	<p data-bbox="853 230 1069 253">▼ Expand to see the list</p> <ul data-bbox="901 264 1101 1317" style="list-style-type: none"><li data-bbox="901 264 1101 286">• CVE-2024-28757<li data-bbox="901 309 1101 331">• CVE-2024-24855<li data-bbox="901 353 1101 376">• CVE-2024-1086<li data-bbox="901 398 1101 421">• CVE-2024-1085<li data-bbox="901 443 1101 465">• CVE-2024-0646<li data-bbox="901 488 1101 510">• CVE-2024-0607<li data-bbox="901 533 1101 555">• CVE-2024-0565<li data-bbox="901 577 1101 600">• CVE-2024-0340<li data-bbox="901 622 1101 645">• CVE-2023-6915<li data-bbox="901 667 1101 689">• CVE-2023-6121<li data-bbox="901 712 1101 734">• CVE-2023-52425<li data-bbox="901 757 1101 779">• CVE-2023-51782<li data-bbox="901 801 1101 824">• CVE-2023-51781<li data-bbox="901 846 1101 869">• CVE-2023-51780<li data-bbox="901 891 1101 913">• CVE-2023-51779<li data-bbox="901 936 1101 958">• CVE-2023-46862<li data-bbox="901 981 1101 1003">• CVE-2023-46343<li data-bbox="901 1025 1101 1048">• CVE-2023-4134<li data-bbox="901 1070 1101 1093">• CVE-2023-32247<li data-bbox="901 1115 1101 1137">• CVE-2023-23000<li data-bbox="901 1160 1101 1182">• CVE-2023-22995<li data-bbox="901 1205 1101 1227">• CVE-2022-48065<li data-bbox="901 1249 1101 1272">• CVE-2022-48063<li data-bbox="901 1294 1101 1317">• CVE-2022-47695<li data-bbox="901 1339 1101 1361">• CVE-2022-3715

Package Name	Vulnerabilities Resolved
connector.appliveview.tanzu.vmware.com	<ul style="list-style-type: none"> ▼ Expand to see the list <ul style="list-style-type: none"> • GHSA-jjfh-589g-3hjx • GHSA-jgvc-jfgh-rjvv • GHSA-6qvw-249j-h44c • GHSA-6mqj-h674-j845 • GHSA-5jpm-x58v-624v • GHSA-564r-hj7v-mcr5 • CVE-2024-29025 • CVE-2024-26308 • CVE-2024-25710 • CVE-2024-0727 • CVE-2023-6237 • CVE-2023-6129 • CVE-2023-5678 • CVE-2023-5363 • CVE-2023-5156 • CVE-2023-4813 • CVE-2023-4806 • CVE-2023-3817 • CVE-2023-3446 • CVE-2023-34462 • CVE-2023-2975 • CVE-2023-20863
controller.source.apps.tanzu.vmware.com	<ul style="list-style-type: none"> ▼ Expand to see the list <ul style="list-style-type: none"> • GHSA-qppj-fm5r-hxr3 • GHSA-jq35-85cj-fj4p • GHSA-45x7-px36-x8w8
conventions.appliveview.tanzu.vmware.com	<ul style="list-style-type: none"> ▼ Expand to see the list <ul style="list-style-type: none"> • CVE-2024-0727 • CVE-2023-6237 • CVE-2023-6129 • CVE-2023-5678 • CVE-2023-5363 • CVE-2023-5156 • CVE-2023-4813 • CVE-2023-4806 • CVE-2023-3817 • CVE-2023-3446 • CVE-2023-2975
sso.apps.tanzu.vmware.com	<ul style="list-style-type: none"> ▼ Expand to see the list <ul style="list-style-type: none"> • GHSA-x637-x8p3-5p22

v1.6.10 Known issues

This release has the following known issues, listed by component and area.

v1.6.10 Known issues: Tanzu Application Platform

- This Tanzu Application Platform release is not supported with Tanzu Kubernetes releases (TKR) v1.26 on vSphere with Tanzu.

v1.6.10 Known issues: Artifact Metadata Repository Observer and CloudEvent Handler

- Periodic reconciliation or restarting of the AMR Observer causes reattempted posting of ImageVulnerabilityScan results. There is an error on duplicate submission of identical ImageVulnerabilityScans you can ignore if the previous submission was successful.
- ReplicaSet status in AMR only has two states: `created` and `deleted`. There is a known issue where the `available` and `unavailable` state is not showing. The workaround is that you can interpolate this information from the `instances` metadata in the AMR for the ReplicaSet.

v1.6.10 Known issues: Bitnami Services

- If you try to configure private registry integration for the Bitnami services after having already created a claim for one or more of the Bitnami services using the default configuration, the updated private registry configuration does not appear to take effect. This is due to caching behavior in the system which is not accounted for during configuration updates. For a workaround, see [Troubleshoot Bitnami Services](#).

v1.6.10 Known issues: Cloud Native Runtimes

- For Knative Serving, certain app name, namespace, and domain combinations produce Knative Services with status `CertificateNotReady`. For more information, see [Troubleshooting](#).

v1.6.10 Known issues: Crossplane

- Crossplane Providers cannot communicate with systems using a custom CA. For more information and a workaround, see [Troubleshoot Crossplane](#).
- The Crossplane `validatingwebhookconfiguration` is not removed when you uninstall the Crossplane Package. To workaround, delete the `validatingwebhookconfiguration` manually by running `kubectl delete validatingwebhookconfiguration crossplane`.

v1.6.10 Known issues: Eventing

- When using vSphere sources in Eventing, the vsphere-source is using a high number of informers to alleviate load on the API server. This causes high memory use.

v1.6.10 Known issues: Learning Center

- [CVE-2023-26114](#): Versions of VS Code server before v4.10.1 are vulnerable to Missing Origin Validation in WebSocket handshakes. For mitigation steps, see [Known issues for Learning Center](#).

v1.6.10 Known issues: Services Toolkit

- An error occurs if `additionalProperties` is `true` in a `CompositeResourceDefinition`. For more information and a workaround, see [Troubleshoot Services Toolkit](#).

v1.6.10 Known issues: Supply Chain Choreographer

- When using the Carvel Package Supply Chains, if the operator updates the parameter `carvel_package.name_suffix`, existing workloads incorrectly output a Carvel package to the GitOps repository that uses the old value of `carvel_package.name_suffix`. You can ignore or delete this package.
- If the size of the resulting OpenAPIv3 specification exceeds a certain size, approximately 3 KB, the Supply Chain does not function. If you use the default Carvel package parameters, you this issue does not occur. If you use custom Carvel package parameters, you might encounter this size limit. If you exceed the size limit, you can either deactivate this feature, or use a workaround. The workaround requires enabling a Tekton feature flag. For more information, see the [Tekton documentation](#).

v1.6.10 Known issues: Supply Chain Security Tools - Scan

- The Snyk scanner outputs an incorrectly created date, resulting in an invalid date. If the workload is in a failed state due to an invalid date, wait approximately 10 hours and the workload automatically goes into the ready state. For more information, see this [issue](#) in the Snyk Github repository.

v1.6.10 Supply Chain Security Tools - Store

- SCST - Store automatically detects PostgreSQL database index corruptions. If SCST - Store finds a PostgreSQL database index corruption issue, it does not reconcile. For how to fix this issue, see [Fix Postgres Database Index Corruption](#).

v1.6.10 Known issues: Tanzu Developer Portal (formerly named Tanzu Application Platform GUI)

- If you do not configure any authentication providers, and do not allow guest access, the following message appears when loading Tanzu Developer Portal in a browser:

```
No configured authentication providers. Please configure at least one.
```

To resolve this issue, see [Troubleshooting](#).

- Ad-blocking browser extensions and standalone ad-blocking software can interfere with telemetry collection within the VMware [Customer Experience Improvement Program](#) and restrict access to all or parts of Tanzu Developer Portal. For more information, see [Troubleshooting](#).
- `ScmAuth` is a Backstage concept that abstracts Source Code Management (SCM) authentication into a package. An oversight in a recent code-base migration led to the accidental exclusion of custom `ScmAuth` functions. This exclusion affected some client operations, such as using Application Accelerators to create Git repositories on behalf of users.
- The back-end Kubernetes plug-in reports failure in multicluster environments. In a multicluster environment when one request to a Kubernetes cluster fails, `backstage-kubernetes-backend` reports a failure to the front end. This is a known issue with upstream Backstage and it applies to all released versions of Tanzu Developer Portal. For more information, see [this Backstage code in GitHub](#). This behavior arises from the API at the

Backstage level. There are currently no known workarounds. There are plans for upstream commits to Backstage to resolve this issue.

v1.6.10 Known issues: Tanzu Developer Portal - Supply Chain GUI plug-in

- Any workloads created by using a custom resource definition (CRD) might not work as expected. Only Out of the Box (OOTB) Supply Chains are supported in the UI.
- Downloading the SBOM from a vulnerability scan requires additional configuration in `tap-values.yaml`. For more information, see [Troubleshooting](#).

v1.6.10 Known issues: Tanzu Developer Tools for IntelliJ

- The error `com.vdurmont.semver4j.SemverException: Invalid version (no major version)` is shown in the error logs when attempting to perform a workload action before installing the Tanzu CLI apps plug-in.
- If you restart your computer while running Live Update without terminating the Tilt process beforehand, there is a lock that incorrectly shows that Live Update is still running and prevents it from starting again. For the fix, see [Troubleshooting](#).
- Workload actions and Live Update do not work when in a project with spaces in its name, such as `my app`, or in its path, such as `C:\Users\My User\my-app`. For more information, see [Troubleshooting](#).
- An **EDT Thread Exception** error is logged or reported as a notification with a message similar to `"com.intellij.diagnostic.PluginException: 2007 ms to call on EDT TanzuApplyAction#update@ProjectViewPopup"`. For more information, see [Troubleshooting](#).

v1.6.10 Known issues: Tanzu Developer Tools for Visual Studio

- Clicking the red square Stop button in the Visual Studio top toolbar can cause a workload to fail. For more information, see [Troubleshooting](#).

v1.6.10 Known issues: Tanzu Developer Tools for VS Code

- In the Tanzu activity panel, the `config-writer-pull-requester` of type `Runnable` is incorrectly categorized as **Unknown**. The correct category is **Supply Chain**.

v1.6.10 Component versions

The following table lists the supported component versions for this Tanzu Application Platform release.

Component Name	Version
API Auto Registration	0.3.5
API portal	1.4.7
Application Accelerator	1.6.6
Application Configuration Service	2.1.4
Application Live View APIServer	1.6.3
Application Live View back end	1.6.4
Application Live View connector	1.6.4
Application Live View conventions	1.6.3

Component Name	Version
Application Single Sign-On	4.0.6
Artifact Metadata Repository Observer (alpha)	0.1.2
Bitnami Services	0.2.0
Carbon Black Scanner for SCST - Scan (beta)	1.2.5
Cartographer Conventions	0.7.5
cert-manager	2.4.3
Cloud Native Runtimes	2.3.14
Contour	2.0.0
Crossplane	0.2.1
Default Roles	1.1.0
Developer Conventions	0.11.2
Eventing (deprecated)	2.2.10
External Secrets Operator	0.6.1+tap.6
Flux CD Source Controller	0.36.1+tanzu.2
Grype Scanner for SCST - Scan	1.6.140
Learning Center (deprecated)	0.3.2
Learning Center workshops (deprecated)	0.3.1
Local Source Proxy	0.1.1
Namespace Provisioner	0.4.1
Out of the Box Delivery - Basic	0.13.18
Out of the Box Supply Chain - Basic	0.13.18
Out of the Box Supply Chain - Testing	0.13.18
Out of the Box Supply Chain - Testing and Scanning	0.13.18
Out of the Box Templates	0.13.18
Service Bindings	0.9.4
Services Toolkit	0.11.1
Snyk Scanner for SCST - Scan (beta)	1.0.0-beta.156
Source Controller	0.8.4
Spring Boot conventions	1.6.3
Spring Cloud Gateway	2.0.12
Supply Chain Choreographer	0.7.5
Supply Chain Security Tools - Policy Controller	1.4.2
Supply Chain Security Tools - Scan	1.6.141
Supply Chain Security Tools - Scan 2.0 (beta)	0.1.0-beta.137
Supply Chain Security Tools - Store	1.6.9

Component Name	Version
Tanzu Application Platform Telemetry	0.6.2
Tanzu Build Service	1.11.18
Tanzu CLI	1.1.0
Tanzu Developer Portal (formerly Tanzu Application Platform GUI)	1.6.8
Tanzu Developer Portal Configurator (beta)	0.1.2
Tekton Pipelines	0.41.0+tap.9

v1.6.9

Release Date: 12 March 2024

v1.6.9 Security fixes

This release has the following security fixes, listed by package.

Package Name	Vulnerabilities Resolved
amr-observer.apps.tanzu.vmware.com	<ul style="list-style-type: none"> ▼ Expand to see the list • CVE-2024-22365 • CVE-2024-0727 • CVE-2024-0567 • CVE-2024-0553 • CVE-2023-7008 • CVE-2023-6780 • CVE-2023-6779 • CVE-2023-6246 • CVE-2023-6237 • CVE-2023-6129 • CVE-2023-5981 • CVE-2023-5678 • CVE-2023-5363 • CVE-2023-52426 • CVE-2023-52425 • CVE-2023-5156 • CVE-2023-50495 • CVE-2023-4911 • CVE-2023-4813 • CVE-2023-4806 • CVE-2023-47100 • CVE-2023-47038 • CVE-2023-4641 • CVE-2023-45918 • CVE-2023-45853 • CVE-2023-4527 • CVE-2023-4039 • CVE-2023-4016 • CVE-2023-39804 • CVE-2023-3817 • CVE-2023-36660 • CVE-2023-3446 • CVE-2023-31484 • CVE-2023-31439 • CVE-2023-31438 • CVE-2023-31437 • CVE-2023-2975 • CVE-2023-29491 • CVE-2023-29383 • CVE-2023-26604 • CVE-2023-2650 • CVE-2023-0465

Package Name	Vulnerabilities Resolved
	<ul style="list-style-type: none"> • CVE-2023-0464 • CVE-2022-48522 • CVE-2022-3821 • CVE-2022-3219 • CVE-2020-22916 • CVE-2020-21583 • CVE-2020-19190 • CVE-2020-19189 • CVE-2020-19188 • CVE-2020-19187 • CVE-2020-19186 • CVE-2020-19185 • CVE-2020-13844 • CVE-2016-2781 • CVE-2015-20109 • CVE-2013-4235
<hr/> base-jammy-stack-lite.buildpacks.tanzu.vmware.com	▼ Expand to see the list <ul style="list-style-type: none"> • CVE-2024-0727 • CVE-2024-0641 • CVE-2024-0193 • CVE-2023-6932 • CVE-2023-6931 • CVE-2023-6817 • CVE-2023-6622 • CVE-2023-6606 • CVE-2023-6237 • CVE-2023-6176 • CVE-2023-6129 • CVE-2023-6040 • CVE-2023-6039 • CVE-2023-5678 • CVE-2023-46813 • CVE-2023-4641 • CVE-2023-4563 • CVE-2023-35827 • CVE-2023-34324 • CVE-2023-32257 • CVE-2023-32252 • CVE-2023-32250 • CVE-2023-2953 <hr/>

Package Name	Vulnerabilities Resolved
controller.source.apps.tanzu.vmware.com	<ul style="list-style-type: none"> ▼ Expand to see the list <ul style="list-style-type: none"> • CVE-2024-0727 • CVE-2023-6237 • CVE-2023-6129 • CVE-2023-5678 • CVE-2023-5363 • CVE-2023-5156 • CVE-2023-4813 • CVE-2023-4806 • CVE-2023-3817 • CVE-2023-3446 • CVE-2023-2975
metadata-store.apps.tanzu.vmware.com	<ul style="list-style-type: none"> ▼ Expand to see the list <ul style="list-style-type: none"> • GHSA-4374-p667-p6c8 • GHSA-2wrh-6pvc-2jm9
ootb-templates.tanzu.vmware.com	<ul style="list-style-type: none"> ▼ Expand to see the list <ul style="list-style-type: none"> • GHSA-p782-xgp4-8hr8 • CVE-2023-4881 • CVE-2022-30633 • CVE-2022-28131
spring-cloud-gateway.tanzu.vmware.com	<ul style="list-style-type: none"> ▼ Expand to see the list <ul style="list-style-type: none"> • GHSA-hr8g-6v94-x4m9 • GHSA-ccgv-vj62-xf9h • GHSA-4g9r-vxhx-9pgx • GHSA-45x7-px36-x8w8 • GHSA-4265-ccf5-phj5 • CVE-2024-26308 • CVE-2024-25710 • CVE-2024-22365 • CVE-2024-20952 • CVE-2024-20932 • CVE-2024-20926 • CVE-2024-20918 • CVE-2024-0727 • CVE-2024-0567 • CVE-2024-0553 • CVE-2023-6237 • CVE-2023-6129 • CVE-2023-5678 • CVE-2023-4641 • CVE-2023-39326

Package Name	Vulnerabilities Resolved
sso.apps.tanzu.vmware.com	<p>▼ Expand to see the list</p> <ul style="list-style-type: none">• CVE-2024-26462• CVE-2024-26461• CVE-2024-26458• CVE-2024-0553• CVE-2023-7008• CVE-2023-5981• CVE-2023-4813• CVE-2023-4806• CVE-2022-48303• CVE-2021-36087• CVE-2021-36086• CVE-2021-36085• CVE-2021-36084

Package Name	Vulnerabilities Resolved
tekton.tanzu.vmware.com	<ul style="list-style-type: none"> ▼ Expand to see the list <ul style="list-style-type: none"> • GHSAs: hp87-p4gw-j4gq • CVE-2024-22365 • CVE-2024-0567 • CVE-2024-0553 • CVE-2023-7192 • CVE-2023-6918 • CVE-2023-6546 • CVE-2023-6004 • CVE-2023-5981 • CVE-2023-5717 • CVE-2023-5363 • CVE-2023-5197 • CVE-2023-5178 • CVE-2023-5158 • CVE-2023-5156 • CVE-2023-4921 • CVE-2023-4881 • CVE-2023-48795 • CVE-2023-4813 • CVE-2023-4806 • CVE-2023-47038 • CVE-2023-4623 • CVE-2023-4622 • CVE-2023-46218 • CVE-2023-45871 • CVE-2023-45863 • CVE-2023-45862 • CVE-2023-4569 • CVE-2023-44487 • CVE-2023-44466 • CVE-2023-42756 • CVE-2023-42755 • CVE-2023-42754 • CVE-2023-42753 • CVE-2023-42752 • CVE-2023-4273 • CVE-2023-4244 • CVE-2023-4208 • CVE-2023-4207 • CVE-2023-4206 • CVE-2023-4194 • CVE-2023-4155

Package Name	Vulnerabilities Resolved
	• CVE-2023-4147
	• CVE-2023-4132
	• CVE-2023-4128
	• CVE-2023-40283
	• CVE-2023-4016
	• CVE-2023-4015
	• CVE-2023-4004
	• CVE-2023-3995
	• CVE-2023-39804
	• CVE-2023-39198
	• CVE-2023-39197
	• CVE-2023-39194
	• CVE-2023-39193
	• CVE-2023-39192
	• CVE-2023-39189
	• CVE-2023-3866
	• CVE-2023-3865
	• CVE-2023-3863
	• CVE-2023-38546
	• CVE-2023-38432
	• CVE-2023-38429
	• CVE-2023-38428
	• CVE-2023-38426
	• CVE-2023-3817
	• CVE-2023-3777
	• CVE-2023-3776
	• CVE-2023-3773
	• CVE-2023-3772
	• CVE-2023-37453
	• CVE-2023-3611
	• CVE-2023-3610
	• CVE-2023-3609
	• CVE-2023-36054
	• CVE-2023-35829
	• CVE-2023-35828
	• CVE-2023-35824
	• CVE-2023-35823
	• CVE-2023-35788
	• CVE-2023-3567
	• CVE-2023-35001
	• CVE-2023-3446
	• CVE-2023-3439
	• CVE-2023-34319

Package Name	Vulnerabilities Resolved
	<ul style="list-style-type: none"> • CVE-2023-34256 • CVE-2023-3390 • CVE-2023-3389 • CVE-2023-3358 • CVE-2023-3357 • CVE-2023-3355 • CVE-2023-3338 • CVE-2023-33288 • CVE-2023-33203 • CVE-2023-3268 • CVE-2023-32269 • CVE-2023-32248 • CVE-2023-32233 • CVE-2023-3220 • CVE-2023-3212 • CVE-2023-3161 • CVE-2023-31484 • CVE-2023-31436 • CVE-2023-3141 • CVE-2023-31248 • CVE-2023-3117 • CVE-2023-31085 • CVE-2023-31084 • CVE-2023-31083 • CVE-2023-3090 • CVE-2023-30772 • CVE-2023-30456 • CVE-2023-2985 • CVE-2023-2975 • CVE-2023-29491 • CVE-2023-29007 • CVE-2023-2898 • CVE-2023-28466 • CVE-2023-28328 • CVE-2023-28322 • CVE-2023-28321 • CVE-2023-27538 • CVE-2023-27536 • CVE-2023-27535 • CVE-2023-27534 • CVE-2023-27533 • CVE-2023-26607 • CVE-2023-26606

Package Name	Vulnerabilities Resolved
	• CVE-2023-26605
	• CVE-2023-26545
	• CVE-2023-26544
	• CVE-2023-2650
	• CVE-2023-2612
	• CVE-2023-2603
	• CVE-2023-2602
	• CVE-2023-25815
	• CVE-2023-25775
	• CVE-2023-25652
	• CVE-2023-25588
	• CVE-2023-25585
	• CVE-2023-25584
	• CVE-2023-25012
	• CVE-2023-24329
	• CVE-2023-23946
	• CVE-2023-23916
	• CVE-2023-23915
	• CVE-2023-23914
	• CVE-2023-23559
	• CVE-2023-23455
	• CVE-2023-23454
	• CVE-2023-23004
	• CVE-2023-2283
	• CVE-2023-2269
	• CVE-2023-22490
	• CVE-2023-2235
	• CVE-2023-2194
	• CVE-2023-2166
	• CVE-2023-2163
	• CVE-2023-2162
	• CVE-2023-2156
	• CVE-2023-21400
	• CVE-2023-21255
	• CVE-2023-2124
	• CVE-2023-21102
	• CVE-2023-20938
	• CVE-2023-20593
	• CVE-2023-20588
	• CVE-2023-20569
	• CVE-2023-2006
	• CVE-2023-2002
	• CVE-2023-1998

Package Name	Vulnerabilities Resolved
	• CVE-2023-1990
	• CVE-2023-1972
	• CVE-2023-1872
	• CVE-2023-1859
	• CVE-2023-1855
	• CVE-2023-1829
	• CVE-2023-1670
	• CVE-2023-1667
	• CVE-2023-1652
	• CVE-2023-1611
	• CVE-2023-1513
	• CVE-2023-1382
	• CVE-2023-1380
	• CVE-2023-1281
	• CVE-2023-1255
	• CVE-2023-1206
	• CVE-2023-1195
	• CVE-2023-1192
	• CVE-2023-1079
	• CVE-2023-1078
	• CVE-2023-1077
	• CVE-2023-1076
	• CVE-2023-1075
	• CVE-2023-1074
	• CVE-2023-1073
	• CVE-2023-0597
	• CVE-2023-0468
	• CVE-2023-0465
	• CVE-2023-0464
	• CVE-2023-0461
	• CVE-2023-0459
	• CVE-2023-0458
	• CVE-2023-0394
	• CVE-2023-0386
	• CVE-2023-0361
	• CVE-2023-0266
	• CVE-2023-0210
	• CVE-2023-0179
	• CVE-2023-0045
	• CVE-2022-48522
	• CVE-2022-48502
	• CVE-2022-4842
	• CVE-2022-48425

Package Name	Vulnerabilities Resolved
	• CVE-2022-48424
	• CVE-2022-48423
	• CVE-2022-48303
	• CVE-2022-47929
	• CVE-2022-47696
	• CVE-2022-47673
	• CVE-2022-47521
	• CVE-2022-47520
	• CVE-2022-47519
	• CVE-2022-47518
	• CVE-2022-47011
	• CVE-2022-47010
	• CVE-2022-47008
	• CVE-2022-47007
	• CVE-2022-45919
	• CVE-2022-45886
	• CVE-2022-45869
	• CVE-2022-45703
	• CVE-2022-44840
	• CVE-2022-4415
	• CVE-2022-4382
	• CVE-2022-4379
	• CVE-2022-4285
	• CVE-2022-4269
	• CVE-2022-42329
	• CVE-2022-42328
	• CVE-2022-4139
	• CVE-2022-4129
	• CVE-2022-41218
	• CVE-2022-40982
	• CVE-2022-3996
	• CVE-2022-3821
	• CVE-2022-3707
	• CVE-2022-36280
	• CVE-2022-3545
	• CVE-2022-3521
	• CVE-2022-35205
	• CVE-2022-3435
	• CVE-2022-3424
	• CVE-2022-3344
	• CVE-2022-3169
	• CVE-2022-27672
	• CVE-2022-2196

Package Name	Vulnerabilities Resolved
	<ul style="list-style-type: none"> CVE-2007-4559

v1.6.9 Resolved issues

The following issues, listed by component and area, are resolved in this release.

v1.6.9 Resolved issues: Cloud Native Runtimes

- Resolved the issue where web workloads created with Tanzu Application Platform v1.6.3 and earlier failed to update with the error `API server says: admission webhook "validation.webhook.serving.knative.dev" denied the request: validation failed: annotation value is immutable.`

v1.6.9 Known issues

This release has the following known issues, listed by component and area.

v1.6.9 Known issues: Tanzu Application Platform

- This Tanzu Application Platform release is not supported with Tanzu Kubernetes releases (TKR) v1.26 on vSphere with Tanzu.

v1.6.9 Known issues: Artifact Metadata Repository Observer and CloudEvent Handler

- Periodic reconciliation or restarting of the AMR Observer causes reattempted posting of ImageVulnerabilityScan results. There is an error on duplicate submission of identical ImageVulnerabilityScans you can ignore if the previous submission was successful.
- ReplicaSet status in AMR only has two states: `created` and `deleted`. There is a known issue where the `available` and `unavailable` state is not showing. The workaround is that you can interpolate this information from the `instances` metadata in the AMR for the ReplicaSet.

v1.6.9 Known issues: Bitnami Services

- If you try to configure private registry integration for the Bitnami services after having already created a claim for one or more of the Bitnami services using the default configuration, the updated private registry configuration does not appear to take effect. This is due to caching behavior in the system which is not accounted for during configuration updates. For a workaround, see [Troubleshoot Bitnami Services](#).

v1.6.9 Known issues: Cloud Native Runtimes

- For Knative Serving, certain app name, namespace, and domain combinations produce Knative Services with status `CertificateNotReady`. For more information, see [Troubleshooting](#).

v1.6.9 Known issues: Crossplane

- Crossplane Providers cannot communicate with systems using a custom CA. For more information and a workaround, see [Troubleshoot Crossplane](#).
- The Crossplane `validatingwebhookconfiguration` is not removed when you uninstall the Crossplane Package. To workaround, delete the `validatingwebhookconfiguration` manually by running `kubectl delete validatingwebhookconfiguration crossplane`.

v1.6.9 Known issues: Eventing

- When using vSphere sources in Eventing, the vsphere-source is using a high number of informers to alleviate load on the API server. This causes high memory use.

v1.6.9 Known issues: Learning Center

- [CVE-2023-26114](#): Versions of VS Code server before v4.10.1 are vulnerable to Missing Origin Validation in WebSocket handshakes. For mitigation steps, see [Known issues for Learning Center](#).

v1.6.9 Known issues: Services Toolkit

- An error occurs if `additionalProperties` is `true` in a CompositeResourceDefinition. For more information and a workaround, see [Troubleshoot Services Toolkit](#).

v1.6.9 Known issues: Supply Chain Choreographer

- When using the Carvel Package Supply Chains, if the operator updates the parameter `carvel_package.name_suffix`, existing workloads incorrectly output a Carvel package to the GitOps repository that uses the old value of `carvel_package.name_suffix`. You can ignore or delete this package.
- If the size of the resulting OpenAPIV3 specification exceeds a certain size, approximately 3 KB, the Supply Chain does not function. If you use the default Carvel package parameters, you this issue does not occur. If you use custom Carvel package parameters, you might encounter this size limit. If you exceed the size limit, you can either deactivate this feature, or use a workaround. The workaround requires enabling a Tekton feature flag. For more information, see the [Tekton documentation](#).

v1.6.9 Known issues: Supply Chain Security Tools - Scan

- The Snyk scanner outputs an incorrectly created date, resulting in an invalid date. If the workload is in a failed state due to an invalid date, wait approximately 10 hours and the workload automatically goes into the ready state. For more information, see this [issue](#) in the Snyk Github repository.

v1.6.9 Supply Chain Security Tools - Store

- SCST - Store automatically detects PostgreSQL database index corruptions. If SCST - Store finds a PostgreSQL database index corruption issue, it does not reconcile. For how to fix this issue, see [Fix Postgres Database Index Corruption](#).

v1.6.9 Known issues: Tanzu Developer Portal (formerly named Tanzu Application Platform GUI)

- If you do not configure any authentication providers, and do not allow guest access, the following message appears when loading Tanzu Developer Portal in a browser:

```
No configured authentication providers. Please configure at least one.
```

To resolve this issue, see [Troubleshooting](#).

- Ad-blocking browser extensions and standalone ad-blocking software can interfere with telemetry collection within the VMware [Customer Experience Improvement Program](#) and restrict access to all or parts of Tanzu Developer Portal. For more information, see [Troubleshooting](#).

- **ScmAuth** is a Backstage concept that abstracts Source Code Management (SCM) authentication into a package. An oversight in a recent code-base migration led to the accidental exclusion of custom ScmAuth functions. This exclusion affected some client operations, such as using Application Accelerators to create Git repositories on behalf of users.
- The back-end Kubernetes plug-in reports failure in multicluster environments. In a multicluster environment when one request to a Kubernetes cluster fails, `backstage-kubernetes-backend` reports a failure to the front end. This is a known issue with upstream Backstage and it applies to all released versions of Tanzu Developer Portal. For more information, see [this Backstage code in GitHub](#). This behavior arises from the API at the Backstage level. There are currently no known workarounds. There are plans for upstream commits to Backstage to resolve this issue.

v1.6.9 Known issues: Tanzu Developer Portal - Supply Chain GUI plug-in

- Any workloads created by using a custom resource definition (CRD) might not work as expected. Only Out of the Box (OOTB) Supply Chains are supported in the UI.
- Downloading the SBOM from a vulnerability scan requires additional configuration in `tap-values.yaml`. For more information, see [Troubleshooting](#).

v1.6.9 Known issues: Tanzu Developer Tools for IntelliJ

- The error `com.vdurmont.semver4j.SemverException: Invalid version (no major version)` is shown in the error logs when attempting to perform a workload action before installing the Tanzu CLI apps plug-in.
- If you restart your computer while running Live Update without terminating the Tilt process beforehand, there is a lock that incorrectly shows that Live Update is still running and prevents it from starting again. For the fix, see [Troubleshooting](#).
- Workload actions and Live Update do not work when in a project with spaces in its name, such as `my app`, or in its path, such as `C:\Users\My User\my-app`. For more information, see [Troubleshooting](#).
- An **EDT Thread Exception** error is logged or reported as a notification with a message similar to `"com.intellij.diagnostic.PluginException: 2007 ms to call on EDT TanzuApplyAction#update@ProjectViewPopup"`. For more information, see [Troubleshooting](#).

v1.6.9 Known issues: Tanzu Developer Tools for Visual Studio

- Clicking the red square Stop button in the Visual Studio top toolbar can cause a workload to fail. For more information, see [Troubleshooting](#).

v1.6.9 Known issues: Tanzu Developer Tools for VS Code

- In the Tanzu activity panel, the `config-writer-pull-requester` of type `Runnable` is incorrectly categorized as **Unknown**. The correct category is **Supply Chain**.

v1.6.9 Component versions

The following table lists the supported component versions for this Tanzu Application Platform release.

Component Name	Version
API Auto Registration	0.3.5
API portal	1.4.7
Application Accelerator	1.6.5
Application Configuration Service	2.1.4
Application Live View APIServer	1.6.2
Application Live View back end	1.6.2
Application Live View connector	1.6.2
Application Live View conventions	1.6.2
Application Single Sign-On	4.0.5
Artifact Metadata Repository Observer (alpha)	0.1.2
Bitnami Services	0.2.0
Carbon Black Scanner for SCST - Scan (beta)	1.2.5
Cartographer Conventions	0.7.5
cert-manager	2.4.3
Cloud Native Runtimes	2.3.14
Contour	2.0.0
Crossplane	0.2.1
Default Roles	1.1.0
Developer Conventions	0.11.2
Eventing (deprecated)	2.2.10
External Secrets Operator	0.6.1+tap.6
Flux CD Source Controller	0.36.1+tanzu.2
Grype Scanner for SCST - Scan	1.6.140
Learning Center (deprecated)	0.3.2
Learning Center workshops (deprecated)	0.3.1
Local Source Proxy	0.1.1
Namespace Provisioner	0.4.1
Out of the Box Delivery - Basic	0.13.18
Out of the Box Supply Chain - Basic	0.13.18
Out of the Box Supply Chain - Testing	0.13.18
Out of the Box Supply Chain - Testing and Scanning	0.13.18
Out of the Box Templates	0.13.18
Service Bindings	0.9.4
Services Toolkit	0.11.1
Snyk Scanner for SCST - Scan (beta)	1.0.0-beta.156

Component Name	Version
Source Controller	0.8.4
Spring Boot conventions	1.6.2
Spring Cloud Gateway	2.0.12
Supply Chain Choreographer	0.7.5
Supply Chain Security Tools - Policy Controller	1.4.2
Supply Chain Security Tools - Scan	1.6.141
Supply Chain Security Tools - Scan 2.0 (beta)	0.1.0-beta.137
Supply Chain Security Tools - Store	1.6.9
Tanzu Application Platform Telemetry	0.6.2
Tanzu Build Service	1.11.18
Tanzu Developer Portal (formerly Tanzu Application Platform GUI)	1.6.8
Tanzu Developer Portal Configurator (beta)	0.1.2
Tanzu CLI	1.2.0
Tekton Pipelines	0.41.0+tap.9

v1.6.8

Release Date: 13 February 2024

v1.6.8 Security fixes

This release has the following security fixes, listed by package.

Package Name	Vulnerabilities Resolved
accelerator.apps.tanzu.vmware.com	▼ Expand to see the list <ul style="list-style-type: none"> • CVE-2023-34053 • CVE-2023-22049 • CVE-2023-22045 • CVE-2023-22044 • CVE-2023-22041 • CVE-2023-22036 • CVE-2023-22006
application-configuration-service.tanzu.vmware.com	▼ Expand to see the list <ul style="list-style-type: none"> • GHSA-wjxj-5m7g-mg7q • GHSA-cgwf-w82q-5jrr • GHSA-45x7-px36-x8w8 • CVE-2023-42503

Package Name	Vulnerabilities Resolved
base-jammy-stack-lite.buildpacks.tanzu.vmware.com	<ul style="list-style-type: none"> ▼ Expand to see the list <ul style="list-style-type: none"> • CVE-2024-22365 • CVE-2024-0567 • CVE-2024-0553 • CVE-2023-6918 • CVE-2023-6004 • CVE-2022-47011 • CVE-2022-47010 • CVE-2022-47008 • CVE-2022-47007 • CVE-2022-45703 • CVE-2022-44840
carbonblack.scanning.apps.tanzu.vmware.com	<ul style="list-style-type: none"> ▼ Expand to see the list <ul style="list-style-type: none"> • GHSA-6xv5-86q9-7xr8 • GHSA-6wrf-mxfj-pf5p • GHSA-33pg-m6jh-5237
cert-manager.tanzu.vmware.com	<ul style="list-style-type: none"> ▼ Expand to see the list <ul style="list-style-type: none"> • CVE-2023-39326
metadata-store.apps.tanzu.vmware.com	<ul style="list-style-type: none"> ▼ Expand to see the list <ul style="list-style-type: none"> • CVE-2023-45285 • CVE-2023-29409
sso.apps.tanzu.vmware.com	<ul style="list-style-type: none"> ▼ Expand to see the list <ul style="list-style-type: none"> • CVE-2023-45145 • CVE-2023-41056 • CVE-2023-41053 • CVE-2023-39319 • CVE-2023-39318 • CVE-2023-3817 • CVE-2023-36054 • CVE-2023-3446 • CVE-2023-29409 • CVE-2023-29406
tap-gui.tanzu.vmware.com	<ul style="list-style-type: none"> ▼ Expand to see the list <ul style="list-style-type: none"> • CVE-2024-0641 • CVE-2023-6121 • CVE-2023-5197 • CVE-2023-46862 • CVE-2023-45863 • CVE-2021-44879

v1.6.8 Resolved issues

The following issues, listed by component and area, are resolved in this release.

v1.6.8 Resolved issues: Application Single Sign-On

- When requesting an `access_token` by using the the Authorization Code flow, scopes in the token are filtered based on user roles. In this version, the `scope` parameter of the access token response is also filtered, with the same rules. For more information, see the [OAuth documentation](#).

v1.6.8 Resolved issues: Contour

- Ships with Contour v1.24.6.
- Supports upgrades to Tanzu Application Platform v1.6.8 without downtime when transitioning from `DaemonSet` to `Deployments`.



Note

Downtime-free upgrades require more than one node in the cluster.

v1.6.8 Known issues

This release has the following known issues, listed by component and area.

v1.6.8 Known issues: Tanzu Application Platform

- This Tanzu Application Platform release is not supported with Tanzu Kubernetes releases (TKR) v1.26 on vSphere with Tanzu.

v1.6.8 Known issues: Artifact Metadata Repository Observer and CloudEvent Handler

- Periodic reconciliation or restarting of the AMR Observer causes reattempted posting of ImageVulnerabilityScan results. There is an error on duplicate submission of identical ImageVulnerabilityScans you can ignore if the previous submission was successful.
- ReplicaSet status in AMR only has two states: `created` and `deleted`. There is a known issue where the `available` and `unavailable` state is not showing. The workaround is that you can interpolate this information from the `instances` metadata in the AMR for the ReplicaSet.

v1.6.8 Known issues: Bitnami Services

- If you try to configure private registry integration for the Bitnami services after having already created a claim for one or more of the Bitnami services using the default configuration, the updated private registry configuration does not appear to take effect. This is due to caching behavior in the system which is not accounted for during configuration updates. For a workaround, see [Troubleshoot Bitnami Services](#).

v1.6.8 Known issues: Cloud Native Runtimes

- For Knative Serving, certain app name, namespace, and domain combinations produce Knative Services with status `CertificateNotReady`. For more information, see [Troubleshooting](#).
- Web workloads created with Tanzu Application Platform v1.6.3 and earlier fail to update with the error `API server says: admission webhook`

`"validation.webhook.serving.knative.dev"` denied the request: validation failed: annotation value is immutable. For a workaround, see [Troubleshoot Cloud Native Runtimes for Tanzu](#).

v1.6.8 Known issues: Crossplane

- Crossplane Providers cannot communicate with systems using a custom CA. For more information and a workaround, see [Troubleshoot Crossplane](#).
- The Crossplane `validatingwebhookconfiguration` is not removed when you uninstall the Crossplane Package. To workaround, delete the `validatingwebhookconfiguration` manually by running `kubectl delete validatingwebhookconfiguration crossplane`.

v1.6.8 Known issues: Eventing

- When using vSphere sources in Eventing, the vsphere-source is using a high number of informers to alleviate load on the API server. This causes high memory use.

v1.6.8 Known issues: Learning Center

- [CVE-2023-26114](#): Versions of VS Code server before v4.10.1 are vulnerable to Missing Origin Validation in WebSocket handshakes. For mitigation steps, see [Known issues for Learning Center](#).

v1.6.8 Known issues: Services Toolkit

- An error occurs if `additionalProperties` is `true` in a CompositeResourceDefinition. For more information and a workaround, see [Troubleshoot Services Toolkit](#).

v1.6.8 Known issues: Supply Chain Choreographer

- When using the Carvel Package Supply Chains, if the operator updates the parameter `carvel_package.name_suffix`, existing workloads incorrectly output a Carvel package to the GitOps repository that uses the old value of `carvel_package.name_suffix`. You can ignore or delete this package.
- If the size of the resulting OpenAPIv3 specification exceeds a certain size, approximately 3 KB, the Supply Chain does not function. If you use the default Carvel package parameters, you this issue does not occur. If you use custom Carvel package parameters, you might encounter this size limit. If you exceed the size limit, you can either deactivate this feature, or use a workaround. The workaround requires enabling a Tekton feature flag. For more information, see the [Tekton documentation](#).

v1.6.8 Known issues: Supply Chain Security Tools - Scan

- The Snyk scanner outputs an incorrectly created date, resulting in an invalid date. If the workload is in a failed state due to an invalid date, wait approximately 10 hours and the workload automatically goes into the ready state. For more information, see this [issue](#) in the Snyk Github repository.

v1.6.8 Supply Chain Security Tools - Store

- SCST - Store automatically detects PostgreSQL database index corruptions. If SCST - Store finds a PostgreSQL database index corruption issue, it does not reconcile. For how to fix this issue, see [Fix Postgres Database Index Corruption](#).

v1.6.8 Known issues: Tanzu Developer Portal (formerly named Tanzu Application Platform GUI)

- If you do not configure any authentication providers, and do not allow guest access, the following message appears when loading Tanzu Developer Portal in a browser:

```
No configured authentication providers. Please configure at least one.
```

To resolve this issue, see [Troubleshooting](#).

- Ad-blocking browser extensions and standalone ad-blocking software can interfere with telemetry collection within the VMware [Customer Experience Improvement Program](#) and restrict access to all or parts of Tanzu Developer Portal. For more information, see [Troubleshooting](#).
- [ScmAuth](#) is a Backstage concept that abstracts Source Code Management (SCM) authentication into a package. An oversight in a recent code-base migration led to the accidental exclusion of custom ScmAuth functions. This exclusion affected some client operations, such as using Application Accelerators to create Git repositories on behalf of users.
- The back-end Kubernetes plug-in reports failure in multicluster environments. In a multicluster environment when one request to a Kubernetes cluster fails, `backstage-kubernetes-backend` reports a failure to the front end. This is a known issue with upstream Backstage and it applies to all released versions of Tanzu Developer Portal. For more information, see [this Backstage code in GitHub](#). This behavior arises from the API at the Backstage level. There are currently no known workarounds. There are plans for upstream commits to Backstage to resolve this issue.

v1.6.8 Known issues: Tanzu Developer Portal - Supply Chain GUI plug-in

- Any workloads created by using a custom resource definition (CRD) might not work as expected. Only Out of the Box (OOTB) Supply Chains are supported in the UI.
- Downloading the SBOM from a vulnerability scan requires additional configuration in `tap-values.yaml`. For more information, see [Troubleshooting](#).

v1.6.8 Known issues: Tanzu Developer Tools for IntelliJ

- The error `com.vdurmont.semver4j.SemverException: Invalid version (no major version)` is shown in the error logs when attempting to perform a workload action before installing the Tanzu CLI apps plug-in.
- If you restart your computer while running Live Update without terminating the Tilt process beforehand, there is a lock that incorrectly shows that Live Update is still running and prevents it from starting again. For the fix, see [Troubleshooting](#).
- Workload actions and Live Update do not work when in a project with spaces in its name, such as `my app`, or in its path, such as `C:\Users\My User\my-app`. For more information, see [Troubleshooting](#).
- An **EDT Thread Exception** error is logged or reported as a notification with a message similar to `"com.intellij.diagnostic.PluginException: 2007 ms to call on EDT TanzuApplyAction#update@ProjectViewPopup"`. For more information, see [Troubleshooting](#).

v1.6.8 Known issues: Tanzu Developer Tools for Visual Studio

- Clicking the red square Stop button in the Visual Studio top toolbar can cause a workload to fail. For more information, see [Troubleshooting](#).

v1.6.8 Known issues: Tanzu Developer Tools for VS Code

- In the Tanzu activity panel, the `config-writer-pull-requester` of type `Runnable` is incorrectly categorized as **Unknown**. The correct category is **Supply Chain**.

v1.6.8 Component versions

The following table lists the supported component versions for this Tanzu Application Platform release.

Component Name	Version
API Auto Registration	0.3.5
API portal	1.4.7
Application Accelerator	1.6.5
Application Configuration Service	2.1.4
Application Live View API Server	1.6.2
Application Live View Backend	1.6.2
Application Live View Connector	1.6.2
Application Live View Conventions	1.6.2
Application Single Sign-On	4.0.4
Artifact Metadata Repository Observer (alpha)	0.11-alpha.2
Bitnami Services	0.2.0
Carbon Black Scanner for SCST - Scan (beta)	1.2.5
Cartographer Conventions	0.7.5
cert-manager	2.4.3
Cloud Native Runtimes	2.3.14
Contour	2.0.0
Crossplane	0.2.1
Default Roles	1.1.0
Developer Conventions	0.11.2
Eventing (deprecated)	2.2.10
External Secrets Operator	0.6.1+tap.6
Flux CD Source Controller	0.36.1+tanzu.2
Grype Scanner for SCST - Scan	1.6.140
Learning Center (deprecated)	0.3.2
Learning Center workshops (deprecated)	0.3.1
Local Source Proxy	0.1.1
Namespace Provisioner	0.4.1
Out of the Box Delivery - Basic	0.13.15
Out of the Box Supply Chain - Basic	0.13.15

Component Name	Version
Out of the Box Supply Chain - Testing	0.13.15
Out of the Box Supply Chain - Testing and Scanning	0.13.15
Out of the Box Templates	0.13.15
Service Bindings	0.9.4
Services Toolkit	0.11.1
Snyk Scanner for SCST - Scan (beta)	1.0.0-beta.156
Source Controller	0.8.3
Spring Boot conventions	1.6.2
Spring Cloud Gateway	2.0.10
Supply Chain Choreographer	0.7.5
Supply Chain Security Tools - Policy Controller	1.4.2
Supply Chain Security Tools - Scan	1.6.141
Supply Chain Security Tools - Scan 2.0 (beta)	0.1.0-beta.137
Supply Chain Security Tools - Store	1.6.8
Tanzu Developer Portal (formerly Tanzu Application Platform GUI)	1.6.8
Tanzu Developer Portal Configurator (beta)	0.1.2
Tanzu Application Platform Telemetry	0.6.2
Tanzu Build Service	1.11.17
Tanzu CLI	1.1.0
Tekton Pipelines	0.41.0+tap.8

v1.6.7

Release Date: 09 January 2024

v1.6.7 Security fixes

This release has the following security fixes, listed by package.

Package Name	Vulnerabilities Resolved
api-portal.tanzu.vmware.com	▼ Expand to see the list <ul style="list-style-type: none"> GHSA-vmq6-5m68-f53m CVE-2023-5981 CVE-2023-47038 CVE-2023-4016 CVE-2023-36054 CVE-2022-48522

Package Name	Vulnerabilities Resolved
application-configuration-service.tanzu.vmware.com	<ul style="list-style-type: none"> ▼ Expand to see the list <ul style="list-style-type: none"> • CVE-2023-6378 • CVE-2023-44487 • CVE-2023-39325 • CVE-2023-3635 • CVE-2023-34053
base-jammy-stack-lite.buildpacks.tanzu.vmware.com	<ul style="list-style-type: none"> ▼ Expand to see the list <ul style="list-style-type: none"> • CVE-2023-5717 • CVE-2023-5178 • CVE-2023-5158 • CVE-2023-5156 • CVE-2023-48795 • CVE-2023-4813 • CVE-2023-4806 • CVE-2023-47038 • CVE-2023-46218 • CVE-2023-44487 • CVE-2023-42754 • CVE-2023-39804 • CVE-2023-39198 • CVE-2023-39194 • CVE-2023-39193 • CVE-2023-39192 • CVE-2023-39189 • CVE-2023-3773 • CVE-2023-37453 • CVE-2022-48522 • CVE-2022-4285 • CVE-2022-35205
cnrs.tanzu.vmware.com	<ul style="list-style-type: none"> ▼ Expand to see the list <ul style="list-style-type: none"> • CVE-2023-5156 • CVE-2023-4813 • CVE-2023-4806 • CVE-2023-45285 • CVE-2023-39326

Package Name	Vulnerabilities Resolved
developer-conventions.tanzu.vmware.com	<p>▼ Expand to see the list</p> <ul style="list-style-type: none">• GHSA-qppj-fm5r-hxr3• GHSA-4374-p667-p6c8• GHSA-2wrh-6pvc-2jm9• CVE-2023-5363• CVE-2023-3817• CVE-2023-3446• CVE-2023-2975• CVE-2023-2650• CVE-2023-1255
metadata-store.apps.tanzu.vmware.com	<p>▼ Expand to see the list</p> <ul style="list-style-type: none">• CVE-2023-29406• CVE-2023-29405• CVE-2023-29404• CVE-2023-29403• CVE-2023-29402• CVE-2023-29400• CVE-2023-24540• CVE-2023-24539• CVE-2023-24538• CVE-2023-24537• CVE-2023-24536• CVE-2023-24534
spring-cloud-gateway.tanzu.vmware.com	<p>▼ Expand to see the list</p> <ul style="list-style-type: none">• GHSA-jjfh-589g-3hix• CVE-2023-5981• CVE-2023-5156• CVE-2023-4813• CVE-2023-4806• CVE-2023-47038• CVE-2023-4016• CVE-2023-39804• CVE-2023-34053• CVE-2022-48522

Package Name	Vulnerabilities Resolved
sso.apps.tanzu.vmware.com	<ul style="list-style-type: none"> ▼ Expand to see the list <ul style="list-style-type: none"> • GHSA-vmq6-5m68-f53m • CVE-2023-5363 • CVE-2023-5156 • CVE-2023-34053 • CVE-2023-34035 • CVE-2023-2975 • CVE-2023-22049 • CVE-2023-22045 • CVE-2023-22044 • CVE-2023-22041 • CVE-2023-22036 • CVE-2023-22006

v1.6.7 Known issues

This release has the following known issues, listed by component and area.

v1.6.7 Known issues: Tanzu Application Platform

- This Tanzu Application Platform release is not supported with Tanzu Kubernetes releases (TKR) v1.26 on vSphere with Tanzu.

v1.6.7 Known issues: Artifact Metadata Repository Observer and CloudEvent Handler

- Periodic reconciliation or restarting of the AMR Observer causes reattempted posting of ImageVulnerabilityScan results. There is an error on duplicate submission of identical ImageVulnerabilityScans you can ignore if the previous submission was successful.
- ReplicaSet status in AMR only has two states: `created` and `deleted`. There is a known issue where the `available` and `unavailable` state is not showing. The workaround is that you can interpolate this information from the `instances` metadata in the AMR for the ReplicaSet.

v1.6.7 Known issues: Bitnami Services

- If you try to configure private registry integration for the Bitnami services after having already created a claim for one or more of the Bitnami services using the default configuration, the updated private registry configuration does not appear to take effect. This is due to caching behavior in the system which is not accounted for during configuration updates. For a workaround, see [Troubleshoot Bitnami Services](#).

v1.6.7 Known issues: Cloud Native Runtimes

- For Knative Serving, certain app name, namespace, and domain combinations produce Knative Services with status `CertificateNotReady`. For more information, see [Troubleshooting](#).
- Web workloads created with Tanzu Application Platform v1.6.3 and earlier fail to update with the error `API server says: admission webhook "validation.webhook.serving.knative.dev" denied the request: validation failed:`

`annotation value is immutable`. For a workaround, see [Troubleshoot Cloud Native Runtimes for Tanzu](#).

v1.6.7 Known issues: Crossplane

- Crossplane Providers cannot communicate with systems using a custom CA. For more information and a workaround, see [Troubleshoot Crossplane](#).
- The Crossplane `validatingwebhookconfiguration` is not removed when you uninstall the Crossplane Package. To workaround, delete the `validatingwebhookconfiguration` manually by running `kubectl delete validatingwebhookconfiguration crossplane`.

v1.6.7 Known issues: Eventing

- When using vSphere sources in Eventing, the `vsphere-source` is using a high number of informers to alleviate load on the API server. This causes high memory use.

v1.6.7 Known issues: Learning Center

- [CVE-2023-26114](#): Versions of VS Code server before v4.10.1 are vulnerable to Missing Origin Validation in WebSocket handshakes. For mitigation steps, see [Known issues for Learning Center](#).

v1.6.7 Known issues: Services Toolkit

- An error occurs if `additionalProperties` is `true` in a CompositeResourceDefinition. For more information and a workaround, see [Troubleshoot Services Toolkit](#).

v1.6.7 Known issues: Supply Chain Choreographer

- When using the Carvel Package Supply Chains, if the operator updates the parameter `carvel_package.name_suffix`, existing workloads incorrectly output a Carvel package to the GitOps repository that uses the old value of `carvel_package.name_suffix`. You can ignore or delete this package.
- If the size of the resulting OpenAPIv3 specification exceeds a certain size, approximately 3 KB, the Supply Chain does not function. If you use the default Carvel package parameters, you this issue does not occur. If you use custom Carvel package parameters, you might encounter this size limit. If you exceed the size limit, you can either deactivate this feature, or use a workaround. The workaround requires enabling a Tekton feature flag. For more information, see the [Tekton documentation](#).

v1.6.7 Known issues: Supply Chain Security Tools - Scan

- The Snyk scanner outputs an incorrectly created date, resulting in an invalid date. If the workload is in a failed state due to an invalid date, wait approximately 10 hours and the workload automatically goes into the ready state. For more information, see this [issue](#) in the Snyk Github repository.

v1.6.7 Supply Chain Security Tools - Store

- SCST - Store automatically detects PostgreSQL database index corruptions. If SCST - Store finds a PostgreSQL database index corruption issue, it does not reconcile. For how to fix this issue, see [Fix Postgres Database Index Corruption](#).

v1.6.7 Known issues: Tanzu Developer Portal (formerly named Tanzu Application Platform GUI)

- If you do not configure any authentication providers, and do not allow guest access, the following message appears when loading Tanzu Developer Portal in a browser:

```
No configured authentication providers. Please configure at least one.
```

To resolve this issue, see [Troubleshooting](#).

- Ad-blocking browser extensions and standalone ad-blocking software can interfere with telemetry collection within the VMware [Customer Experience Improvement Program](#) and restrict access to all or parts of Tanzu Developer Portal. For more information, see [Troubleshooting](#).
- [ScmAuth](#) is a Backstage concept that abstracts Source Code Management (SCM) authentication into a package. An oversight in a recent code-base migration led to the accidental exclusion of custom ScmAuth functions. This exclusion affected some client operations, such as using Application Accelerators to create Git repositories on behalf of users.
- The back-end Kubernetes plug-in reports failure in multicluster environments. In a multicluster environment when one request to a Kubernetes cluster fails, `backstage-kubernetes-backend` reports a failure to the front end. This is a known issue with upstream Backstage and it applies to all released versions of Tanzu Developer Portal. For more information, see [this Backstage code in GitHub](#). This behavior arises from the API at the Backstage level. There are currently no known workarounds. There are plans for upstream commits to Backstage to resolve this issue.

v1.6.7 Known issues: Tanzu Developer Portal - Supply Chain GUI plug-in

- Any workloads created by using a custom resource definition (CRD) might not work as expected. Only Out of the Box (OOTB) Supply Chains are supported in the UI.
- Downloading the SBOM from a vulnerability scan requires additional configuration in `tap-values.yaml`. For more information, see [Troubleshooting](#).

v1.6.7 Known issues: Tanzu Developer Tools for IntelliJ

- The error `com.vdurmont.semver4j.SemverException: Invalid version (no major version)` is shown in the error logs when attempting to perform a workload action before installing the Tanzu CLI apps plug-in.
- If you restart your computer while running Live Update without terminating the Tilt process beforehand, there is a lock that incorrectly shows that Live Update is still running and prevents it from starting again. For the fix, see [Troubleshooting](#).
- Workload actions and Live Update do not work when in a project with spaces in its name, such as `my app`, or in its path, such as `C:\Users\My User\my-app`. For more information, see [Troubleshooting](#).
- An **EDT Thread Exception** error is logged or reported as a notification with a message similar to `"com.intellij.diagnostic.PluginException: 2007 ms to call on EDT TanzuApplyAction#update@ProjectViewPopup"`. For more information, see [Troubleshooting](#).

v1.6.7 Known issues: Tanzu Developer Tools for Visual Studio

- Clicking the red square Stop button in the Visual Studio top toolbar can cause a workload to fail. For more information, see [Troubleshooting](#).

v1.6.7 Known issues: Tanzu Developer Tools for VS Code

- In the Tanzu activity panel, the `config-writer-pull-requester` of type `Runnable` is incorrectly categorized as **Unknown**. The correct category is **Supply Chain**.

v1.6.7 Component versions

The following table lists the supported component versions for this Tanzu Application Platform release.

Component Name	Version
API Auto Registration	0.3.5
API portal	1.4.6
Application Accelerator	1.6.2
Application Configuration Service	2.1.3
Application Live View API Server	1.6.2
Application Live View Backend	1.6.2
Application Live View Connector	1.6.2
Application Live View Conventions	1.6.2
Application Single Sign-On	4.0.2
Artifact Metadata Repository Observer (alpha)	0.11-alpha.2
Bitnami Services	0.2.0
Carbon Black Scanner for SCST - Scan (beta)	1.2.2-beta.1
Cartographer Conventions	0.7.5
cert-manager	2.4.2
Cloud Native Runtimes	2.3.6
Contour	1.24.6
Crossplane	0.2.1
Default Roles	1.1.0
Developer Conventions	0.11.2
Eventing (deprecated)	2.2.10
External Secrets Operator	0.6.1+tap.6
Flux CD Source Controller	0.36.1+tanzu.2
Grype Scanner for SCST - Scan	1.6.140
Learning Center (deprecated)	0.3.2
Learning Center workshops (deprecated)	0.3.1
Local Source Proxy	0.1.1
Namespace Provisioner	0.4.1
Out of the Box Delivery - Basic	0.13.11
Out of the Box Supply Chain - Basic	0.13.11
Out of the Box Supply Chain - Testing	0.13.11

Component Name	Version
Out of the Box Supply Chain - Testing and Scanning	0.13.11
Out of the Box Templates	0.13.11
Service Bindings	0.9.4
Services Toolkit	0.11.1
Snyk Scanner for SCST - Scan (beta)	1.0.0-beta.156
Source Controller	0.8.3
Spring Boot conventions	1.6.2
Spring Cloud Gateway	2.0.10
Supply Chain Choreographer	0.7.5
Supply Chain Security Tools - Policy Controller	1.4.2
Supply Chain Security Tools - Scan	1.6.141
Supply Chain Security Tools - Scan 2.0 (beta)	0.1.0-beta.137
Supply Chain Security Tools - Store	1.6.6
Tanzu Developer Portal (formerly Tanzu Application Platform GUI)	1.6.6
Tanzu Developer Portal Configurator (beta)	0.1.2
Tanzu Application Platform Telemetry	0.6.2
Tanzu Build Service	1.11.16
Tanzu CLI	1.1.0
Tekton Pipelines	0.41.0+tap.8

v1.6.6

Release Date: 12 December 2023

v1.6.6 Security fixes

This release has the following security fixes, listed by package.

Package Name	Vulnerabilities Resolved
api-portal.tanzu.vmware.com	▼ Expand to see the list <ul style="list-style-type: none"> • GHSA-qppj-fm5r-hxr3 • CVE-2023-5363 • CVE-2023-3817 • CVE-2023-35116 • CVE-2023-3446 • CVE-2023-2975 • CVE-2023-22081 • CVE-2023-22025

Package Name	Vulnerabilities Resolved
apis.apps.tanzu.vmware.com	▼ Expand to see the list <ul style="list-style-type: none"> • GHSA-qppj-fm5r-hxr3 • GHSA-2wrh-6pvc-2jm9 • CVE-2023-5363 • CVE-2023-3817 • CVE-2023-3446 • CVE-2023-2975
base-jammy-stack-lite.buildpacks.tanzu.vmware.com	▼ Expand to see the list <ul style="list-style-type: none"> • CVE-2023-5981 • CVE-2023-45871 • CVE-2023-4016 • CVE-2023-3772 • CVE-2023-36054 • CVE-2023-31085 • CVE-2023-31083 • CVE-2023-25775
buildservice.tanzu.vmware.com	▼ Expand to see the list <ul style="list-style-type: none"> • GHSA-m8cg-xc2p-r3fc • GHSA-g2j6-57v7-gm8c • GHSA-6wrf-mxfj-pf5p • GHSA-4374-p667-p6c8 • GHSA-33pg-m6jh-5237 • GHSA-2wrh-6pvc-2jm9 • GHSA-2c7c-3mj9-8fqh • CVE-2023-5981 • CVE-2023-5363 • CVE-2023-4016 • CVE-2023-39319 • CVE-2023-39318 • CVE-2023-3817 • CVE-2023-36054 • CVE-2023-3446 • CVE-2023-2975 • CVE-2023-29409 • CVE-2023-29406 • CVE-2023-2650 • CVE-2023-24532 • CVE-2023-1255 • CVE-2023-0465 • CVE-2023-0464 • CVE-2022-41724 • CVE-2022-3996

Package Name	Vulnerabilities Resolved
cert-manager.tanzu.vmware.com	▼ Expand to see the list <ul style="list-style-type: none"><li data-bbox="877 257 1133 291">• GHSA-qpj-fm5r-hxr3<li data-bbox="877 302 1133 336">• GHSA-2wrh-6pvc-2jm9
cnrs.tanzu.vmware.com	▼ Expand to see the list <ul style="list-style-type: none"><li data-bbox="877 392 1085 425">• CVE-2023-39319<li data-bbox="877 436 1085 470">• CVE-2023-39318

Package Name	Vulnerabilities Resolved
eventing.tanzu.vmware.com	<ul style="list-style-type: none"> ▼ Expand to see the list • GHSA-qppj-fm5r-hxr3 • GHSA-m425-mq94-257g • GHSA-4374-p667-p6c8 • GHSA-2wrh-6pvc-2jm9 • CVE-2023-44487 • CVE-2023-39323 • CVE-2023-39319 • CVE-2023-39318 • CVE-2023-29409 • CVE-2023-29406 • CVE-2023-29405 • CVE-2023-29404 • CVE-2023-29403 • CVE-2023-29402 • CVE-2023-29400 • CVE-2023-24540 • CVE-2023-24539 • CVE-2023-24538 • CVE-2023-24537 • CVE-2023-24536 • CVE-2023-24534 • CVE-2023-24532 • CVE-2022-41725 • CVE-2022-41724 • CVE-2022-41723 • CVE-2022-41722 • CVE-2022-41717 • CVE-2022-41715 • CVE-2022-32189 • CVE-2022-32148 • CVE-2022-30635 • CVE-2022-30633 • CVE-2022-30632 • CVE-2022-30631 • CVE-2022-30630 • CVE-2022-2880 • CVE-2022-2879 • CVE-2022-28131 • CVE-2022-27664 • CVE-2022-1962 • CVE-2022-1705

Package Name	Vulnerabilities Resolved
spring-cloud-gateway.tanzu.vmware.com	<p data-bbox="837 230 1053 253">▼ Expand to see the list</p> <ul data-bbox="885 264 1157 801" style="list-style-type: none"><li data-bbox="885 264 1157 291">• GHSA-xpw8-rcwv-8f8p<li data-bbox="885 309 1157 336">• GHSA-vmq6-5m68-f53m<li data-bbox="885 353 1157 380">• GHSA-qppj-fm5r-hxr3<li data-bbox="885 398 1157 425">• GHSA-jgvc-jfgh-rjvv<li data-bbox="885 443 1157 470">• CVE-2023-5363<li data-bbox="885 488 1157 515">• CVE-2023-4911<li data-bbox="885 533 1157 560">• CVE-2023-44487<li data-bbox="885 577 1157 604">• CVE-2023-3817<li data-bbox="885 622 1157 649">• CVE-2023-36054<li data-bbox="885 667 1157 694">• CVE-2023-3446<li data-bbox="885 712 1157 739">• CVE-2023-2975<li data-bbox="885 757 1157 784">• CVE-2023-22081<li data-bbox="885 801 1157 828">• CVE-2023-22025

Package Name	Vulnerabilities Resolved
tap-gui.tanzu.vmware.com	<ul style="list-style-type: none"> ▼ Expand to see the list • CVE-2023-6176 • CVE-2023-42756 • CVE-2023-42755 • CVE-2023-42754 • CVE-2023-4273 • CVE-2023-4194 • CVE-2023-4132 • CVE-2023-39197 • CVE-2023-39194 • CVE-2023-39193 • CVE-2023-39192 • CVE-2023-39189 • CVE-2023-3863 • CVE-2023-3773 • CVE-2023-3772 • CVE-2023-37453 • CVE-2023-34256 • CVE-2023-3338 • CVE-2023-3212 • CVE-2023-31084 • CVE-2023-2898 • CVE-2023-2269 • CVE-2023-21400 • CVE-2023-20588 • CVE-2023-20569 • CVE-2023-2002 • CVE-2023-1206 • CVE-2022-45887 • CVE-2022-4269 • CVE-2022-40982

v1.6.6 Resolved issues

The following issues, listed by component and area, are resolved in this release.

v1.6.6 Resolved issues: cert-manager

- Resolved the known vulnerability with ACME HTTP01 in Tanzu Application Platform.

v1.6.6 Known issues

This release has the following known issues, listed by component and area.

v1.6.6 Known issues: Tanzu Application Platform

- This Tanzu Application Platform release is not supported with Tanzu Kubernetes releases (TKR) v1.26 on vSphere with Tanzu.

v1.6.6 Known issues: Artifact Metadata Repository Observer and CloudEvent Handler

- Periodic reconciliation or restarting of the AMR Observer causes reattempted posting of ImageVulnerabilityScan results. There is an error on duplicate submission of identical ImageVulnerabilityScans you can ignore if the previous submission was successful.
- ReplicaSet status in AMR only has two states: `created` and `deleted`. There is a known issue where the `available` and `unavailable` state is not showing. The workaround is that you can interpolate this information from the `instances` metadata in the AMR for the ReplicaSet.

v1.6.6 Known issues: Bitnami Services

- If you try to configure private registry integration for the Bitnami services after having already created a claim for one or more of the Bitnami services using the default configuration, the updated private registry configuration does not appear to take effect. This is due to caching behavior in the system which is not accounted for during configuration updates. For a workaround, see [Troubleshoot Bitnami Services](#).

v1.6.6 Known issues: Cloud Native Runtimes

- For Knative Serving, certain app name, namespace, and domain combinations produce Knative Services with status `CertificateNotReady`. For more information, see [Troubleshooting](#).
- Web workloads created with Tanzu Application Platform v1.6.3 and earlier fail to update with the error `API server says: admission webhook "validation.webhook.serving.knative.dev" denied the request: validation failed: annotation value is immutable`. For a workaround, see [Troubleshoot Cloud Native Runtimes for Tanzu](#).

v1.6.6 Known issues: Crossplane

- Crossplane Providers cannot communicate with systems using a custom CA. For more information and a workaround, see [Troubleshoot Crossplane](#).
- The Crossplane `validatingwebhookconfiguration` is not removed when you uninstall the Crossplane Package. To workaround, delete the `validatingwebhookconfiguration` manually by running `kubectl delete validatingwebhookconfiguration crossplane`.

v1.6.6 Known issues: Eventing

- When using vSphere sources in Eventing, the vsphere-source is using a high number of informers to alleviate load on the API server. This causes high memory use.

v1.6.6 Known issues: Learning Center

- [CVE-2023-26114](#): Versions of VS Code server before v4.10.1 are vulnerable to Missing Origin Validation in WebSocket handshakes. For mitigation steps, see [Known issues for Learning Center](#).

v1.6.6 Known issues: Services Toolkit

- An error occurs if `additionalProperties` is `true` in a `CompositeResourceDefinition`. For more information and a workaround, see [Troubleshoot Services Toolkit](#).

v1.6.6 Known issues: Supply Chain Choreographer

- When using the Carvel Package Supply Chains, if the operator updates the parameter `carvel_package.name_suffix`, existing workloads incorrectly output a Carvel package to the GitOps repository that uses the old value of `carvel_package.name_suffix`. You can ignore or delete this package.
- If the size of the resulting OpenAPIv3 specification exceeds a certain size, approximately 3 KB, the Supply Chain does not function. If you use the default Carvel package parameters, you this issue does not occur. If you use custom Carvel package parameters, you might encounter this size limit. If you exceed the size limit, you can either deactivate this feature, or use a workaround. The workaround requires enabling a Tekton feature flag. For more information, see the [Tekton documentation](#).

v1.6.6 Supply Chain Security Tools - Store

- SCST - Store automatically detects PostgreSQL database index corruptions. If SCST - Store finds a PostgreSQL database index corruption issue, it does not reconcile. For how to fix this issue, see [Fix Postgres Database Index Corruption](#).

v1.6.6 Known issues: Tanzu Developer Portal (formerly named Tanzu Application Platform GUI)

- If you do not configure any authentication providers, and do not allow guest access, the following message appears when loading Tanzu Developer Portal in a browser:

```
No configured authentication providers. Please configure at least one.
```

To resolve this issue, see [Troubleshooting](#).

- Ad-blocking browser extensions and standalone ad-blocking software can interfere with telemetry collection within the VMware [Customer Experience Improvement Program](#) and restrict access to all or parts of Tanzu Developer Portal. For more information, see [Troubleshooting](#).
- `ScmAuth` is a Backstage concept that abstracts Source Code Management (SCM) authentication into a package. An oversight in a recent code-base migration led to the accidental exclusion of custom `ScmAuth` functions. This exclusion affected some client operations, such as using Application Accelerators to create Git repositories on behalf of users.
- The back-end Kubernetes plug-in reports failure in multicluster environments. In a multicluster environment when one request to a Kubernetes cluster fails, `backstage-kubernetes-backend` reports a failure to the front end. This is a known issue with upstream Backstage and it applies to all released versions of Tanzu Developer Portal. For more information, see [this Backstage code in GitHub](#). This behavior arises from the API at the Backstage level. There are currently no known workarounds. There are plans for upstream commits to Backstage to resolve this issue.

v1.6.6 Known issues: Tanzu Developer Portal - Supply Chain GUI plug-in

- Any workloads created by using a custom resource definition (CRD) might not work as expected. Only Out of the Box (OOTB) Supply Chains are supported in the UI.

- Downloading the SBOM from a vulnerability scan requires additional configuration in `tap-values.yaml`. For more information, see [Troubleshooting](#).

v1.6.6 Known issues: Tanzu Developer Tools for IntelliJ

- The error `com.vdurmont.semver4j.SemverException: Invalid version (no major version)` is shown in the error logs when attempting to perform a workload action before installing the Tanzu CLI apps plug-in.
- If you restart your computer while running Live Update without terminating the Tilt process beforehand, there is a lock that incorrectly shows that Live Update is still running and prevents it from starting again. For the fix, see [Troubleshooting](#).
- Workload actions and Live Update do not work when in a project with spaces in its name, such as `my app`, or in its path, such as `C:\Users\My User\my-app`. For more information, see [Troubleshooting](#).
- An **EDT Thread Exception** error is logged or reported as a notification with a message similar to `"com.intellij.diagnostic.PluginException: 2007 ms to call on EDT TanzuApplyAction#update@ProjectViewPopup"`. For more information, see [Troubleshooting](#).

v1.6.6 Known issues: Tanzu Developer Tools for Visual Studio

- Clicking the red square Stop button in the Visual Studio top toolbar can cause a workload to fail. For more information, see [Troubleshooting](#).

v1.6.6 Known issues: Tanzu Developer Tools for VS Code

- In the Tanzu activity panel, the `config-writer-pull-requester` of type `Runnable` is incorrectly categorized as **Unknown**. The correct category is **Supply Chain**.

v1.6.6 Component versions

The following table lists the supported component versions for this Tanzu Application Platform release.

Component Name	Version
API Auto Registration	0.3.5
API portal	1.4.5
Application Accelerator	1.6.2
Application Configuration Service	2.1.2
Application Live View API Server	1.6.2
Application Live View Backend	1.6.2
Application Live View Connector	1.6.2
Application Live View Conventions	1.6.2
Application Single Sign-On	4.0.1
Artifact Metadata Repository Observer (alpha)	0.11-alpha.2
Bitnami Services	0.2.0
Carbon Black Scanner for SCST - Scan (beta)	1.2.2-beta.1
Cartographer Conventions	0.7.5

Component Name	Version
cert-manager	2.4.2
Cloud Native Runtimes	2.3.5
Contour	1.24.6
Crossplane	0.2.1
Default Roles	1.1.0
Developer Conventions	0.11.0
Eventing (deprecated)	2.2.10
External Secrets Operator	0.6.1+tap.6
Flux CD Source Controller	0.36.1+tanzu.2
Grype Scanner for SCST - Scan	1.6.140
Learning Center (deprecated)	0.3.2
Learning Center workshops (deprecated)	0.3.1
Local Source Proxy	0.1.1
Namespace Provisioner	0.4.1
Out of the Box Delivery - Basic	0.13.11
Out of the Box Supply Chain - Basic	0.13.11
Out of the Box Supply Chain - Testing	0.13.11
Out of the Box Supply Chain - Testing and Scanning	0.13.11
Out of the Box Templates	0.13.11
Service Bindings	0.9.4
Services Toolkit	0.11.1
Snyk Scanner for SCST - Scan (beta)	1.0.0-beta.156
Source Controller	0.8.3
Spring Boot conventions	1.6.2
Spring Cloud Gateway	2.0.9
Supply Chain Choreographer	0.7.5
Supply Chain Security Tools - Policy Controller	1.4.2
Supply Chain Security Tools - Scan	1.6.141
Supply Chain Security Tools - Scan 2.0 (beta)	0.1.0-beta.137
Supply Chain Security Tools - Store	1.6.5
Tanzu Developer Portal (formerly Tanzu Application Platform GUI)	1.6.6
Tanzu Developer Portal Configurator (beta)	0.1.2
Tanzu Application Platform Telemetry	0.6.2
Tanzu Build Service	1.11.16
Tanzu CLI	1.1.0

Component Name	Version
Tekton Pipelines	0.41.0+tap.8

v1.6.5

Release Date: 14 November 2023

v1.6.5 Security fixes

This release has the following security fixes, listed by package.

Package Name	Vulnerabilities Resolved
api-portal.tanzu.vmware.com	<p>▼ Expand to see the list</p> <ul style="list-style-type: none">• GHSA-4374-p667-p6c8• GHSA-2wrh-6pvc-2jm9• CVE-2023-4911• CVE-2023-22049• CVE-2023-22045• CVE-2023-22044• CVE-2023-22041• CVE-2023-22036• CVE-2023-22006

Package Name	Vulnerabilities Resolved
base-jammy-stack-lite.buildpacks.tanzu.vmware.com	<ul style="list-style-type: none"> ▼ Expand to see the list • CVE-2023-5363 • CVE-2023-5197 • CVE-2023-4921 • CVE-2023-4911 • CVE-2023-4881 • CVE-2023-4623 • CVE-2023-4622 • CVE-2023-44466 • CVE-2023-42756 • CVE-2023-42755 • CVE-2023-42753 • CVE-2023-42752 • CVE-2023-4273 • CVE-2023-4244 • CVE-2023-4194 • CVE-2023-4155 • CVE-2023-4132 • CVE-2023-3866 • CVE-2023-3865 • CVE-2023-3863 • CVE-2023-38546 • CVE-2023-38545 • CVE-2023-38432 • CVE-2023-3817 • CVE-2023-3446 • CVE-2023-34319 • CVE-2023-3338 • CVE-2023-2975 • CVE-2023-2156 • CVE-2023-1206
cnrs.tanzu.vmware.com	<ul style="list-style-type: none"> ▼ Expand to see the list • GHSA-4374-p667-p6c8 • GHSA-2wrh-6pvc-2jm9 • CVE-2023-5363 • CVE-2023-3817 • CVE-2023-3446 • CVE-2023-2975

Package Name	Vulnerabilities Resolved
contour.tanzu.vmware.com	<ul style="list-style-type: none"> ▼ Expand to see the list <ul style="list-style-type: none"> • GHSA-qppj-fm5r-hxr3 • GHSA-m425-mq94-257g • GHSA-4374-p667-p6c8 • GHSA-2wrh-6pvc-2jm9

v1.6.5 Resolved issues

This release has the following resolved issues, listed by component and area.

v1.6.5 Resolved issues: Local Source Proxy

- When installing Local Source Proxy outside of a Tanzu Application Platform profile, there is no longer failure at the OpenShift distribution stage.

v1.6.5 Known issues

This release has the following known issues, listed by component and area.

v1.6.5 Known issues: Tanzu Application Platform

- This Tanzu Application Platform release is not supported with Tanzu Kubernetes releases (TKR) v1.26 on vSphere with Tanzu.

v1.6.5 Known issues: Artifact Metadata Repository Observer and CloudEvent Handler

- Periodic reconciliation or restarting of the AMR Observer causes reattempted posting of ImageVulnerabilityScan results. There is an error on duplicate submission of identical ImageVulnerabilityScans you can ignore if the previous submission was successful.
- ReplicaSet status in AMR only has two states: `created` and `deleted`. There is a known issue where the `available` and `unavailable` state is not showing. The workaround is that you can interpolate this information from the `instances` metadata in the AMR for the ReplicaSet.

v1.6.5 Known issues: Bitnami Services

- If you try to configure private registry integration for the Bitnami services after having already created a claim for one or more of the Bitnami services using the default configuration, the updated private registry configuration does not appear to take effect. This is due to caching behavior in the system which is not accounted for during configuration updates. For a workaround, see [Troubleshoot Bitnami Services](#).

v1.6.5 Known issues: cert-manager

- There is a known vulnerability with ACME HTTP01 in Tanzu Application Platform v1.6.5. Although the likelihood of exploitation of the cert-manager's ACME HTTP01 solver `Pod` is minimal, if your organization heavily relies on ACME HTTP01 challenges and deems it too risky to retry certificate issuance, consider using DNS01 until VMware provides a technical solution in the future patch release.

v1.6.5 Known issues: Cloud Native Runtimes

- For Knative Serving, certain app name, namespace, and domain combinations produce Knative Services with status `CertificateNotReady`. For more information, see [Troubleshooting](#).
- Web workloads created with Tanzu Application Platform v1.6.3 and earlier fail to update with the error `API server says: admission webhook "validation.webhook.serving.knative.dev" denied the request: validation failed: annotation value is immutable`. For a workaround, see [Troubleshoot Cloud Native Runtimes for Tanzu](#).

v1.6.5 Known issues: Crossplane

- Crossplane Providers cannot communicate with systems using a custom CA. For more information and a workaround, see [Troubleshoot Crossplane](#).
- The Crossplane `validatingwebhookconfiguration` is not removed when you uninstall the Crossplane Package. To workaround, delete the `validatingwebhookconfiguration` manually by running `kubectl delete validatingwebhookconfiguration crossplane`.

v1.6.5 Known issues: Eventing

- When using vSphere sources in Eventing, the vsphere-source is using a high number of informers to alleviate load on the API server. This causes high memory use.

v1.6.5 Known issues: Learning Center

- [CVE-2023-26114](#): Versions of VS Code server before v4.10.1 are vulnerable to Missing Origin Validation in WebSocket handshakes. For mitigation steps, see [Known issues for Learning Center](#).

v1.6.5 Known issues: Services Toolkit

- An error occurs if `additionalProperties` is `true` in a CompositeResourceDefinition. For more information and a workaround, see [Troubleshoot Services Toolkit](#).

v1.6.5 Known issues: Supply Chain Choreographer

- When using the Carvel Package Supply Chains, if the operator updates the parameter `carvel_package.name_suffix`, existing workloads incorrectly output a Carvel package to the GitOps repository that uses the old value of `carvel_package.name_suffix`. You can ignore or delete this package.
- If the size of the resulting OpenAPIv3 specification exceeds a certain size, approximately 3 KB, the Supply Chain does not function. If you use the default Carvel package parameters, you this issue does not occur. If you use custom Carvel package parameters, you might encounter this size limit. If you exceed the size limit, you can either deactivate this feature, or use a workaround. The workaround requires enabling a Tekton feature flag. For more information, see the [Tekton documentation](#).

v1.6.5 Supply Chain Security Tools - Store

- SCST - Store automatically detects PostgreSQL database index corruptions. If SCST - Store finds a PostgreSQL database index corruption issue, it does not reconcile. For how to fix this issue, see [Fix Postgres Database Index Corruption](#).

v1.6.5 Known issues: Tanzu Developer Portal (formerly named Tanzu Application Platform GUI)

- If you do not configure any authentication providers, and do not allow guest access, the following message appears when loading Tanzu Developer Portal in a browser:

```
No configured authentication providers. Please configure at least one.
```

To resolve this issue, see [Troubleshooting](#).

- Ad-blocking browser extensions and standalone ad-blocking software can interfere with telemetry collection within the VMware [Customer Experience Improvement Program](#) and restrict access to all or parts of Tanzu Developer Portal. For more information, see [Troubleshooting](#).
- [ScmAuth](#) is a Backstage concept that abstracts Source Code Management (SCM) authentication into a package. An oversight in a recent code-base migration led to the accidental exclusion of custom ScmAuth functions. This exclusion affected some client operations, such as using Application Accelerators to create Git repositories on behalf of users.
- The back-end Kubernetes plug-in reports failure in multicluster environments. In a multicluster environment when one request to a Kubernetes cluster fails, `backstage-kubernetes-backend` reports a failure to the front end. This is a known issue with upstream Backstage and it applies to all released versions of Tanzu Developer Portal. For more information, see [this Backstage code in GitHub](#). This behavior arises from the API at the Backstage level. There are currently no known workarounds. There are plans for upstream commits to Backstage to resolve this issue.

v1.6.5 Known issues: Tanzu Developer Portal - Supply Chain GUI plug-in

- Any workloads created by using a custom resource definition (CRD) might not work as expected. Only Out of the Box (OOTB) Supply Chains are supported in the UI.
- Downloading the SBOM from a vulnerability scan requires additional configuration in `tap-values.yaml`. For more information, see [Troubleshooting](#).

v1.6.5 Known issues: Tanzu Developer Tools for IntelliJ

- The error `com.vdurmont.semver4j.SemverException: Invalid version (no major version)` is shown in the error logs when attempting to perform a workload action before installing the Tanzu CLI apps plug-in.
- If you restart your computer while running Live Update without terminating the Tilt process beforehand, there is a lock that incorrectly shows that Live Update is still running and prevents it from starting again. For the fix, see [Troubleshooting](#).
- Workload actions and Live Update do not work when in a project with spaces in its name, such as `my app`, or in its path, such as `C:\Users\My User\my-app`. For more information, see [Troubleshooting](#).
- An **EDT Thread Exception** error is logged or reported as a notification with a message similar to `"com.intellij.diagnostic.PluginException: 2007 ms to call on EDT TanzuApplyAction#update@ProjectViewPopup"`. For more information, see [Troubleshooting](#).

v1.6.5 Known issues: Tanzu Developer Tools for Visual Studio

- Clicking the red square Stop button in the Visual Studio top toolbar can cause a workload to fail. For more information, see [Troubleshooting](#).

v1.6.5 Known issues: Tanzu Developer Tools for VS Code

- In the Tanzu activity panel, the `config-writer-pull-requester` of type `Runnable` is incorrectly categorized as **Unknown**. The correct category is **Supply Chain**.

v1.6.5 Component versions

The following table lists the supported component versions for this Tanzu Application Platform release.

Component Name	Version
API Auto Registration	0.3.4
API portal	1.4.4
Application Accelerator	1.6.2
Application Configuration Service	2.1.2
Application Live View API Server	1.6.2
Application Live View Backend	1.6.2
Application Live View Connector	1.6.2
Application Live View Conventions	1.6.2
Application Single Sign-On	4.0.1
Artifact Metadata Repository Observer (alpha)	0.11-alpha.2
Bitnami Services	0.2.0
Carbon Black Scanner for SCST - Scan (beta)	1.2.2-beta.1
Cartographer Conventions	0.7.5
cert-manager	2.3.1
Cloud Native Runtimes	2.3.4
Contour	1.24.6
Crossplane	0.2.1
Default Roles	1.1.0
Developer Conventions	0.11.0
Eventing (deprecated)	2.2.6
External Secrets Operator	0.6.1+tap.6
Flux CD Source Controller	0.36.1+tanzu.2
Grype Scanner for SCST - Scan	1.6.140
Learning Center (deprecated)	0.3.2
Learning Center workshops (deprecated)	0.3.1
Local Source Proxy	0.1.1
Namespace Provisioner	0.4.1
Out of the Box Delivery - Basic	0.13.11
Out of the Box Supply Chain - Basic	0.13.11
Out of the Box Supply Chain - Testing	0.13.11

Component Name	Version
Out of the Box Supply Chain - Testing and Scanning	0.13.11
Out of the Box Templates	0.13.11
Service Bindings	0.9.4
Services Toolkit	0.11.1
Snyk Scanner for SCST - Scan (beta)	1.0.0-beta.156
Source Controller	0.8.3
Spring Boot conventions	1.6.2
Spring Cloud Gateway	2.0.8
Supply Chain Choreographer	0.7.5
Supply Chain Security Tools - Policy Controller	1.4.2
Supply Chain Security Tools - Scan	1.6.141
Supply Chain Security Tools - Scan 2.0 (beta)	0.1.0-beta.137
Supply Chain Security Tools - Store	1.6.3
Tanzu Developer Portal (formerly Tanzu Application Platform GUI)	1.6.5
Tanzu Developer Portal Configurator (beta)	0.1.2
Tanzu Application Platform Telemetry	0.6.2
Tanzu Build Service	1.11.14
Tanzu CLI	1.0.0
Tekton Pipelines	0.41.0+tap.8

v1.6.4

Release Date: 10 October 2023

v1.6.4 Breaking changes

This release has the following breaking changes, listed by component and area.

v1.6.4 Breaking changes: Services Toolkit

- Services Toolkit forces explicit cluster-wide permissions to `claim` from a `ClusterInstanceClass`. You must now grant the permission to `claim` from a `ClusterInstanceClass` by using a `ClusterRole` and `ClusterRoleBinding`. For more information, see [The claim verb for ClusterInstanceClass](#).

v1.6.4 Security fixes

This release has the following security fixes, listed by package.

Package Name	Vulnerabilities Resolved
accelerator.apps.tanzu.vmware.com	▼ Expand to see the list <ul style="list-style-type: none"> CVE-2023-43642

Package Name	Vulnerabilities Resolved
api-portal.tanzu.vmware.com	<p>▼ Expand to see the list</p> <ul style="list-style-type: none">• GHSA-r47r-87p9-8jh3• GHSA-6mjg-h674-j845• CVE-2023-34035• CVE-2023-2603• CVE-2023-2602
apis.apps.tanzu.vmware.com	<p>▼ Expand to see the list</p> <ul style="list-style-type: none">• CVE-2023-31484• CVE-2023-29491• CVE-2023-29383• CVE-2023-26604• CVE-2023-2650• CVE-2023-0465• CVE-2023-0464• CVE-2022-3821• CVE-2022-3219• CVE-2020-13844• CVE-2016-2781• CVE-2013-4235
application-configuration-service.tanzu.vmware.com	<p>▼ Expand to see the list</p> <ul style="list-style-type: none">• GHSA-mjmq-gwgm-5qhm• GHSA-3p86-9955-h393

Package Name	Vulnerabilities Resolved
base-jammy-stack-lite.buildpacks.tanzu.vmware.com	<ul style="list-style-type: none"> ▼ Expand to see the list <ul style="list-style-type: none"> • GHSA-hp87-p4gw-j4gq • CVE-2023-38429 • CVE-2023-38428 • CVE-2023-38426 • CVE-2023-35829 • CVE-2023-35828 • CVE-2023-35824 • CVE-2023-35823 • CVE-2023-3439 • CVE-2023-34256 • CVE-2023-33288 • CVE-2023-33203 • CVE-2023-3268 • CVE-2023-32248 • CVE-2023-3212 • CVE-2023-3141 • CVE-2023-3117 • CVE-2023-31084 • CVE-2023-30772 • CVE-2023-2898 • CVE-2023-28466 • CVE-2023-23004 • CVE-2023-2269 • CVE-2023-2235 • CVE-2023-2194 • CVE-2023-2163 • CVE-2023-21255 • CVE-2023-2124 • CVE-2023-2002 • CVE-2023-1990 • CVE-2023-1855 • CVE-2023-1611 • CVE-2023-1192 • CVE-2023-0597 • CVE-2022-48502 • CVE-2022-48425 • CVE-2022-48064 • CVE-2022-45919 • CVE-2022-45887 • CVE-2022-4269 • CVE-2022-40982

Package Name	Vulnerabilities Resolved
learningcenter.tanzu.vmware.com	▼ Expand to see the list <ul style="list-style-type: none"> CVE-2022-48064 CVE-2022-45919 CVE-2022-45887 CVE-2021-3712
ootb-templates.tanzu.vmware.com	▼ Expand to see the list <ul style="list-style-type: none"> CVE-2022-48064 CVE-2022-45919 CVE-2022-45887
policy.apps.tanzu.vmware.com	▼ Expand to see the list <ul style="list-style-type: none"> CVE-2023-2650 CVE-2023-1255 CVE-2023-0465 CVE-2023-0464 CVE-2022-3996
spring-cloud-gateway.tanzu.vmware.com	▼ Expand to see the list <ul style="list-style-type: none"> GHSA-cgwf-w82q-5jrr GHSA-7g45-4rm6-3mm3 GHSA-5mg8-w23w-74h3 CVE-2023-42503 CVE-2023-3635 CVE-2023-2976 CVE-2023-22049 CVE-2023-22045 CVE-2023-22044 CVE-2023-22041 CVE-2023-22036 CVE-2023-22006 CVE-2020-8908
tap-gui.tanzu.vmware.com	▼ Expand to see the list <ul style="list-style-type: none"> CVE-2023-32559
tekton.tanzu.vmware.com	▼ Expand to see the list <ul style="list-style-type: none"> CVE-2022-48566 CVE-2022-48565 CVE-2022-48564 CVE-2022-48560 CVE-2022-48064 CVE-2022-45919 CVE-2022-45887

v1.6.4 Resolved issues

The following issues, listed by component and area, are resolved in this release.

v1.6.4 Resolved issues: Application Configuration Service

- Resolves an issue which caused client applications that include the `spring-cloud-config-client` dependency to fail to start or properly load the configuration that Application Configuration Service produced. The fix is adding the property `spring.cloud.config.enabled=false` in secret resources that Application Configuration Service produced.
- Resolves some installation failure scenarios by setting the pod security context to adhere to the restricted pod security standard.

v1.6.4 Known issues

This release has the following known issues, listed by component and area.

v1.6.4 Known issues: Tanzu Application Platform

- This Tanzu Application Platform release is not supported with Tanzu Kubernetes releases (TKR) v1.26 on vSphere with Tanzu.

v1.6.4 Known issues: Artifact Metadata Repository Observer and CloudEvent Handler

- Periodic reconciliation or restarting of the AMR Observer causes reattempted posting of ImageVulnerabilityScan results. There is an error on duplicate submission of identical ImageVulnerabilityScans you can ignore if the previous submission was successful.
- ReplicaSet status in AMR only has two states: `created` and `deleted`. There is a known issue where the `available` and `unavailable` state is not showing. The workaround is that you can interpolate this information from the `instances` metadata in the AMR for the ReplicaSet.

v1.6.4 Known issues: Bitnami Services

- If you try to configure private registry integration for the Bitnami services after having already created a claim for one or more of the Bitnami services using the default configuration, the updated private registry configuration does not appear to take effect. This is due to caching behavior in the system which is not accounted for during configuration updates. For a workaround, see [Troubleshoot Bitnami Services](#).

v1.6.4 Known issues: Cloud Native Runtimes

- For Knative Serving, certain app name, namespace, and domain combinations produce Knative Services with status `CertificateNotReady`. For more information, see [Troubleshooting](#).
- Web workloads created with Tanzu Application Platform v1.6.3 and earlier fail to update with the error `API server says: admission webhook "validation.webhook.serving.knative.dev" denied the request: validation failed: annotation value is immutable`. For a workaround, see [Troubleshoot Cloud Native Runtimes for Tanzu](#).

v1.6.4 Known issues: Crossplane

- Crossplane Providers cannot communicate with systems using a custom CA. For more information and a workaround, see [Troubleshoot Crossplane](#).

- The Crossplane `validatingwebhookconfiguration` is not removed when you uninstall the Crossplane Package. To workaround, delete the `validatingwebhookconfiguration` manually by running `kubectl delete validatingwebhookconfiguration crossplane`.

v1.6.4 Known issues: Eventing

- When using vSphere sources in Eventing, the `vsphere-source` is using a high number of informers to alleviate load on the API server. This causes high memory use.

v1.6.4 Known issues: Learning Center

- [CVE-2023-26114](#): Versions of VS Code server before v4.10.1 are vulnerable to Missing Origin Validation in WebSocket handshakes. For mitigation steps, see [Known issues for Learning Center](#).

v1.6.4 Known issues: Services Toolkit

- An error occurs if `additionalProperties` is `true` in a CompositeResourceDefinition. For more information and a workaround, see [Troubleshoot Services Toolkit](#).

v1.6.4 Known issues: Supply Chain Choreographer

- When using the Carvel Package Supply Chains, if the operator updates the parameter `carvel_package.name_suffix`, existing workloads incorrectly output a Carvel package to the GitOps repository that uses the old value of `carvel_package.name_suffix`. You can ignore or delete this package.
- If the size of the resulting OpenAPIv3 specification exceeds a certain size, approximately 3 KB, the Supply Chain does not function. If you use the default Carvel package parameters, you this issue does not occur. If you use custom Carvel package parameters, you might encounter this size limit. If you exceed the size limit, you can either deactivate this feature, or use a workaround. The workaround requires enabling a Tekton feature flag. For more information, see the [Tekton documentation](#).

v1.6.4 Supply Chain Security Tools - Store

- SCST - Store automatically detects PostgreSQL database index corruptions. If SCST - Store finds a PostgreSQL database index corruption issue, it does not reconcile. For how to fix this issue, see [Fix Postgres Database Index Corruption](#).

v1.6.4 Known issues: Tanzu Developer Portal (formerly named Tanzu Application Platform GUI)

- Ad-blocking browser extensions and standalone ad-blocking software can interfere with telemetry collection within the VMware [Customer Experience Improvement Program](#) and restrict access to all or parts of Tanzu Developer Portal. For more information, see [Troubleshooting](#).
- [ScmAuth](#) is a Backstage concept that abstracts Source Code Management (SCM) authentication into a package. An oversight in a recent code-base migration led to the accidental exclusion of custom ScmAuth functions. This exclusion affected some client operations, such as using Application Accelerators to create Git repositories on behalf of users.
- The back-end Kubernetes plug-in reports failure in multicluster environments. In a multicluster environment when one request to a Kubernetes cluster fails, `backstage-kubernetes-backend` reports a failure to the front end. This is a known issue with upstream

Backstage and it applies to all released versions of Tanzu Developer Portal. For more information, see [this Backstage code in GitHub](#). This behavior arises from the API at the Backstage level. There are currently no known workarounds. There are plans for upstream commits to Backstage to resolve this issue.

v1.6.4 Known issues: Tanzu Developer Portal - Supply Chain GUI plug-in

- Any workloads created by using a custom resource definition (CRD) might not work as expected. Only Out of the Box (OOTB) Supply Chains are supported in the UI.
- Downloading the SBOM from a vulnerability scan requires additional configuration in `tap-values.yaml`. For more information, see [Troubleshooting](#).

v1.6.4 Known issues: Tanzu Developer Tools for IntelliJ

- The error `com.vdurmont.semver4j.SemverException: Invalid version (no major version)` is shown in the error logs when attempting to perform a workload action before installing the Tanzu CLI apps plug-in.
- If you restart your computer while running Live Update without terminating the Tilt process beforehand, there is a lock that incorrectly shows that Live Update is still running and prevents it from starting again. For the fix, see [Troubleshooting](#).
- Workload actions and Live Update do not work when in a project with spaces in its name, such as `my app`, or in its path, such as `C:\Users\My User\my-app`. For more information, see [Troubleshooting](#).
- An **EDT Thread Exception** error is logged or reported as a notification with a message similar to `"com.intellij.diagnostic.PluginException: 2007 ms to call on EDT TanzuApplyAction#update@ProjectViewPopup"`. For more information, see [Troubleshooting](#).

v1.6.4 Known issues: Tanzu Developer Tools for Visual Studio

- Clicking the red square Stop button in the Visual Studio top toolbar can cause a workload to fail. For more information, see [Troubleshooting](#).

v1.6.4 Known issues: Tanzu Developer Tools for VS Code

- In the Tanzu activity panel, the `config-writer-pull-requester` of type `Runnable` is incorrectly categorized as **Unknown**. The correct category is **Supply Chain**.

v1.6.4 Component versions

The following table lists the supported component versions for this Tanzu Application Platform release.

Component Name	Version
API Auto Registration	0.3.4
API portal	1.4.2
Application Accelerator	1.6.2
Application Configuration Service	2.1.2
Application Live View API Server	1.6.2
Application Live View Backend	1.6.2

Component Name	Version
Application Live View Connector	1.6.2
Application Live View Conventions	1.6.2
Application Single Sign-On	4.0.1
Artifact Metadata Repository Observer (alpha)	0.1.1-alpha.2
Bitnami Services	0.2.0
Carbon Black Scanner for SCST - Scan (beta)	1.2.2-beta.1
Cartographer Conventions	0.7.4
cert-manager	2.3.1
Cloud Native Runtimes	2.3.2
Contour	1.24.4
Crossplane	0.2.1
Default Roles	1.1.0
Developer Conventions	0.11.0
Eventing (deprecated)	2.2.4
External Secrets Operator	0.6.1
Flux CD Source Controller	0.36.1
Grype Scanner for SCST - Scan	1.6.140
Learning Center (deprecated)	0.3.2
Learning Center workshops (deprecated)	0.3.1
Local Source Proxy	0.1.0
Namespace Provisioner	0.4.1
Out of the Box Delivery - Basic	0.13.11
Out of the Box Supply Chain - Basic	0.13.11
Out of the Box Supply Chain - Testing	0.13.11
Out of the Box Supply Chain - Testing and Scanning	0.13.11
Out of the Box Templates	0.13.11
Service Bindings	0.9.1
Services Toolkit	0.11.1
Snyk Scanner for SCST - Scan (beta)	1.0.0-beta.156
Source Controller	0.8.3
Spring Boot conventions	1.6.2
Spring Cloud Gateway	2.0.8
Supply Chain Choreographer	0.7.4
Supply Chain Security Tools - Policy Controller	1.4.2
Supply Chain Security Tools - Scan	1.6.141

Component Name	Version
Supply Chain Security Tools - Scan 2.0 (beta)	0.1.0-beta.137
Supply Chain Security Tools - Store	1.6.3
Tanzu Developer Portal (formerly Tanzu Application Platform GUI)	1.6.5
Tanzu Developer Portal Configurator (beta)	0.1.2
Tanzu Application Platform Telemetry	0.6.2
Tanzu Build Service	1.11.13
Tanzu CLI	1.0.0
Tekton Pipelines	0.41.0+tap.8

v1.6.3

Release Date: 12 September 2023

v1.6.3 Security fixes

This release has the following security fixes, listed by package.

Package Name	Vulnerabilities Resolved
accelerator.apps.tanzu.vmware.com	▼ Expand to see the list <ul style="list-style-type: none"> GHSA-hp87-p4gw-j4gq
application-configuration-service.tanzu.vmware.com	▼ Expand to see the list <ul style="list-style-type: none"> CVE-2023-2650 CVE-2023-1255 CVE-2023-0465 CVE-2023-0464 CVE-2022-3996
base-jammy-stack-lite.buildpacks.tanzu.vmware.com	▼ Expand to see the list <ul style="list-style-type: none"> CVE-2022-47696 CVE-2022-47673
buildservice.tanzu.vmware.com	▼ Expand to see the list <ul style="list-style-type: none"> CVE-2023-31484 CVE-2023-29491 CVE-2023-2603 CVE-2023-2602 CVE-2022-4415 CVE-2022-3821
carbonblack.scanning.apps.tanzu.vmware.com	▼ Expand to see the list <ul style="list-style-type: none"> GHSA-2q89-485c-9j2x

Package Name	Vulnerabilities Resolved
eventing.tanzu.vmware.com	<p>▼ Expand to see the list</p> <ul style="list-style-type: none">• CVE-2023-2650• CVE-2023-1255• CVE-2023-0465• CVE-2023-0464• CVE-2022-3996

Package Name	Vulnerabilities Resolved
learningcenter.tanzu.vmware.com	<ul style="list-style-type: none"> ▼ Expand to see the list • GHSA-p5gc-c584-jj6v • GHSA-j8xg-fqg3-53r7 • GHSA-frjg-g767-7363 • CVE-2023-38408 • CVE-2023-38289 • CVE-2023-38288 • CVE-2023-3618 • CVE-2023-35829 • CVE-2023-35828 • CVE-2023-35824 • CVE-2023-35823 • CVE-2023-3567 • CVE-2023-3439 • CVE-2023-33288 • CVE-2023-33203 • CVE-2023-3316 • CVE-2023-3268 • CVE-2023-32665 • CVE-2023-32643 • CVE-2023-32636 • CVE-2023-32611 • CVE-2023-32269 • CVE-2023-32248 • CVE-2023-3220 • CVE-2023-3161 • CVE-2023-31484 • CVE-2023-3141 • CVE-2023-3138 • CVE-2023-3117 • CVE-2023-30772 • CVE-2023-2985 • CVE-2023-29499 • CVE-2023-29491 • CVE-2023-2908 • CVE-2023-28466 • CVE-2023-28322 • CVE-2023-28321 • CVE-2023-26966 • CVE-2023-26965 • CVE-2023-2612 • CVE-2023-2610 • CVE-2023-2609

Package Name	Vulnerabilities Resolved
	<ul style="list-style-type: none"> • CVE-2023-2603 • CVE-2023-2602 • CVE-2023-25588 • CVE-2023-25585 • CVE-2023-25584 • CVE-2023-25433 • CVE-2023-25180 • CVE-2023-25012 • CVE-2023-24593 • CVE-2023-2426 • CVE-2023-23936 • CVE-2023-23004 • CVE-2023-2283 • CVE-2023-2269 • CVE-2023-2235 • CVE-2023-2194 • CVE-2023-2163 • CVE-2023-2162 • CVE-2023-2124 • CVE-2023-20938 • CVE-2023-2002 • CVE-2023-1999 • CVE-2023-1998 • CVE-2023-1990 • CVE-2023-1972 • CVE-2023-1859 • CVE-2023-1855 • CVE-2023-1670 • CVE-2023-1667 • CVE-2023-1611 • CVE-2023-1513 • CVE-2023-1079 • CVE-2023-1078 • CVE-2023-1077 • CVE-2023-1076 • CVE-2023-1075 • CVE-2023-0597 • CVE-2023-0459 • CVE-2022-48502 • CVE-2022-48281 • CVE-2022-47696 • CVE-2022-47673 • CVE-2022-4269

Package Name	Vulnerabilities Resolved
	<ul style="list-style-type: none"> • CVE-2022-3707 • CVE-2022-3153 • CVE-2022-3134 • CVE-2022-3099 • CVE-2022-3037 • CVE-2022-3016 • CVE-2022-2982 • CVE-2022-2889 • CVE-2022-2874 • CVE-2022-2862 • CVE-2022-2819 • CVE-2022-2817 • CVE-2022-2816 • CVE-2022-27672 • CVE-2022-2598 • CVE-2022-2580 • CVE-2022-2522 • CVE-2022-2289 • CVE-2022-2287 • CVE-2022-2286 • CVE-2022-2285 • CVE-2022-2284 • CVE-2022-2264 • CVE-2022-2257 • CVE-2022-2231 • CVE-2022-2210 • CVE-2022-2208 • CVE-2022-2182 • CVE-2022-0696 • CVE-2022-0407 • CVE-2022-0393 • CVE-2022-0158 • CVE-2022-0156 • CVE-2022-0128
ootb-templates.tanzu.vmware.com	▼ Expand to see the list <ul style="list-style-type: none"> • GHSA-hp87-p4gw-j4gq
workshops.learningcenter.tanzu.vmware.com	▼ Expand to see the list <ul style="list-style-type: none"> • CVE-2023-0466 • CVE-2023-0465

v1.6.3 Resolved issues

The following issues, listed by component and area, are resolved in this release.

v1.6.3 Resolved issues: Application Configuration Service

- `GitRepository` is now consistently observed beyond 15 minutes. The `interval` property for a `ConfigurationSlice` now continues to work as expected.
- Error-logging is improved where a `ConfigurationSlice` references a non-existent `ConfigurationSource`. A `ConfigurationSlice` properly reconciles after the referenced `ConfigurationSource` is created.

v1.6.3 Resolved issues: Tanzu CLI and plugins

- This release includes Tanzu CLI v1.2.0 and a set of installable plug-in groups that are versioned so that the CLI is compatible with every supported version of Tanzu Application Platform. For more information, see [Install Tanzu CLI](#).

v1.6.3 Known issues

This release has the following known issues, listed by component and area.

v1.6.3 Known issues: Tanzu Application Platform

- This Tanzu Application Platform release is not supported with Tanzu Kubernetes releases (TKR) v1.26 on vSphere with Tanzu.

v1.6.3 Known issues: Application Configuration Service

- Client applications that include the `spring-cloud-config-client` dependency might fail to start or properly load the configuration that Application Configuration Service produced.
- Installation might fail because the pod security context does not perfectly adhere to the restricted pod security standard.

v1.6.3 Known issues: Artifact Metadata Repository Observer and CloudEvent Handler

- Periodic reconciliation or restarting of the AMR Observer causes reattempted posting of ImageVulnerabilityScan results. There is an error on duplicate submission of identical ImageVulnerabilityScans you can ignore if the previous submission was successful.
- ReplicaSet status in AMR only has two states: `created` and `deleted`. There is a known issue where the `available` and `unavailable` state is not showing. The workaround is that you can interpolate this information from the `instances` metadata in the AMR for the ReplicaSet.

v1.6.3 Known issues: Bitnami Services

- If you try to configure private registry integration for the Bitnami services after having already created a claim for one or more of the Bitnami services using the default configuration, the updated private registry configuration does not appear to take effect. This is due to caching behavior in the system which is not accounted for during configuration updates. For a workaround, see [Troubleshoot Bitnami Services](#).

v1.6.3 Known issues: Cloud Native Runtimes

- For Knative Serving, certain app name, namespace, and domain combinations produce Knative Services with status `CertificateNotReady`. For more information, see [Troubleshooting](#).

v1.6.3 Known issues: Crossplane

- Crossplane Providers cannot communicate with systems using a custom CA. For more information and a workaround, see [Troubleshoot Crossplane](#).
- The Crossplane `validatingwebhookconfiguration` is not removed when you uninstall the Crossplane Package. To workaround, delete the `validatingwebhookconfiguration` manually by running `kubectl delete validatingwebhookconfiguration crossplane`.

v1.6.3 Known issues: Eventing

- When using vSphere sources in Eventing, the vsphere-source is using a high number of informers to alleviate load on the API server. This causes high memory use.

v1.6.3 Known issues: Learning Center

- [CVE-2023-26114](#): Versions of VS Code server before v4.10.1 are vulnerable to Missing Origin Validation in WebSocket handshakes. For mitigation steps, see [Known issues for Learning Center](#).

v1.6.3 Known issues: Services Toolkit

- An error occurs if `additionalProperties` is `true` in a CompositeResourceDefinition. For more information and a workaround, see [Troubleshoot Services Toolkit](#).

v1.6.3 Known issues: Supply Chain Choreographer

- When using the Carvel Package Supply Chains, if the operator updates the parameter `carvel_package.name_suffix`, existing workloads incorrectly output a Carvel package to the GitOps repository that uses the old value of `carvel_package.name_suffix`. You can ignore or delete this package.
- If the size of the resulting OpenAPIv3 specification exceeds a certain size, approximately 3 KB, the Supply Chain does not function. If you use the default Carvel package parameters, you this issue does not occur. If you use custom Carvel package parameters, you might encounter this size limit. If you exceed the size limit, you can either deactivate this feature, or use a workaround. The workaround requires enabling a Tekton feature flag. For more information, see the [Tekton documentation](#).

v1.6.3 Supply Chain Security Tools - Store

- SCST - Store automatically detects PostgreSQL database index corruptions. If SCST - Store finds a PostgreSQL database index corruption issue, it does not reconcile. For how to fix this issue, see [Fix Postgres Database Index Corruption](#).

v1.6.3 Known issues: Tanzu Developer Portal (formerly named Tanzu Application Platform GUI)

- Ad-blocking browser extensions and standalone ad-blocking software can interfere with telemetry collection within the VMware [Customer Experience Improvement Program](#) and restrict access to all or parts of Tanzu Developer Portal. For more information, see [Troubleshooting](#).
- `ScmAuth` is a Backstage concept that abstracts Source Code Management (SCM) authentication into a package. An oversight in a recent code-base migration led to the accidental exclusion of custom `ScmAuth` functions. This exclusion affected some client

operations, such as using Application Accelerators to create Git repositories on behalf of users.

- The back-end Kubernetes plug-in reports failure in multicluster environments. In a multicluster environment when one request to a Kubernetes cluster fails, `backstage-kubernetes-backend` reports a failure to the front end. This is a known issue with upstream Backstage and it applies to all released versions of Tanzu Developer Portal. For more information, see [this Backstage code in GitHub](#). This behavior arises from the API at the Backstage level. There are currently no known workarounds. There are plans for upstream commits to Backstage to resolve this issue.

v1.6.3 Known issues: Tanzu Developer Portal - Supply Chain GUI plug-in

- Any workloads created by using a custom resource definition (CRD) might not work as expected. Only Out of the Box (OOTB) Supply Chains are supported in the UI.
- Downloading the SBOM from a vulnerability scan requires additional configuration in `tap-values.yaml`. For more information, see [Troubleshooting](#).

v1.6.3 Known issues: Tanzu Developer Tools for IntelliJ

- The error `com.vdurmont.semver4j.SemverException: Invalid version (no major version)` is shown in the error logs when attempting to perform a workload action before installing the Tanzu CLI apps plug-in.
- If you restart your computer while running Live Update without terminating the Tilt process beforehand, there is a lock that incorrectly shows that Live Update is still running and prevents it from starting again. For the fix, see [Troubleshooting](#).
- Workload actions and Live Update do not work when in a project with spaces in its name, such as `my app`, or in its path, such as `C:\Users\My User\my-app`. For more information, see [Troubleshooting](#).
- An **EDT Thread Exception** error is logged or reported as a notification with a message similar to `"com.intellij.diagnostic.PluginException: 2007 ms to call on EDT TanzuApplyAction#update@ProjectViewPopup"`. For more information, see [Troubleshooting](#).

v1.6.3 Known issues: Tanzu Developer Tools for Visual Studio

- Clicking the red square Stop button in the Visual Studio top toolbar can cause a workload to fail. For more information, see [Troubleshooting](#).

v1.6.3 Known issues: Tanzu Developer Tools for VS Code

- In the Tanzu activity panel, the `config-writer-pull-requester` of type `Runnable` is incorrectly categorized as **Unknown**. The correct category is **Supply Chain**.

v1.6.3 Component versions

The following table lists the supported component versions for this Tanzu Application Platform release.

Component Name	Version
API Auto Registration	0.3.3
API portal	1.4.1
Application Accelerator	1.6.2

Component Name	Version
Application Configuration Service	2.1.1
Application Live View API Server	1.6.1
Application Live View Backend	1.6.1
Application Live View Connector	1.6.1
Application Live View Conventions	1.6.1
Application Single Sign-On	4.0.0
Artifact Metadata Repository Observer (alpha)	0.1.1-alpha.2
Bitnami Services	0.2.0
Carbon Black Scanner for SCST - Scan (beta)	1.2.2-beta.1
Cartographer Conventions	0.7.3
cert-manager	2.3.1
Cloud Native Runtimes	2.3.1
Contour	1.24.4
Crossplane	0.2.1
Default Roles	1.1.0
Developer Conventions	0.11.0
Eventing (deprecated)	2.2.4
External Secrets Operator	0.6.1+tap.6
Flux CD Source Controller	0.36.1+tanzu.2
Grype Scanner for SCST - Scan	1.6.140
Learning Center (deprecated)	0.3.2
Learning Center workshops (deprecated)	0.3.1
Local Source Proxy	0.1.0
Namespace Provisioner	0.4.0
Out of the Box Delivery - Basic	0.13.9
Out of the Box Supply Chain - Basic	0.13.9
Out of the Box Supply Chain - Testing	0.13.9
Out of the Box Supply Chain - Testing and Scanning	0.13.9
Out of the Box Templates	0.13.9
Service Bindings	0.9.1
Services Toolkit	0.11.0
Snyk Scanner for SCST - Scan (beta)	1.0.0-beta.156
Source Controller	0.8.1
Spring Boot conventions	1.6.1
Spring Cloud Gateway	2.0.6

Component Name	Version
Supply Chain Choreographer	0.7.3
Supply Chain Security Tools - Policy Controller	1.4.0
Supply Chain Security Tools - Scan	1.6.141
Supply Chain Security Tools - Scan 2.0 (beta)	0.1.0-beta.137
Supply Chain Security Tools - Store	1.6.3
Tanzu Developer Portal (formerly Tanzu Application Platform GUI)	1.6.5
Tanzu Developer Portal Configurator (beta)	0.1.2
Tanzu Application Platform Telemetry	0.6.1
Tanzu Build Service	1.11.13
Tanzu CLI	1.0.0
Tekton Pipelines	0.41.0+tap.8

v1.6.2

Release Date: 15 August 2023

v1.6.2 Security fixes

This release has the following security fixes, listed by package.

Package Name	Vulnerabilities Resolved
accelerator.apps.tanzu.vmware.com	▼ Expand to see the list <ul style="list-style-type: none"> CVE-2023-2603 CVE-2023-2602
api-portal.tanzu.vmware.com	▼ Expand to see the list <ul style="list-style-type: none"> CVE-2023-31484
app-scanning.apps.tanzu.vmware.com	▼ Expand to see the list <ul style="list-style-type: none"> GHSA-g2j6-57v7-gm8c GHSA-m8cg-xc2p-r3fc

Package Name	Vulnerabilities Resolved
base-jammy-stack-lite.buildpacks.tanzu.vmware.com	<ul style="list-style-type: none"> ▼ Expand to see the list <ul style="list-style-type: none"> • CVE-2023-4015 • CVE-2023-4004 • CVE-2023-3995 • CVE-2023-3777 • CVE-2023-3776 • CVE-2023-3611 • CVE-2023-3610 • CVE-2023-3609 • CVE-2023-35788 • CVE-2023-35001 • CVE-2023-3390 • CVE-2023-3389 • CVE-2023-32233 • CVE-2023-3220 • CVE-2023-31484 • CVE-2023-31436 • CVE-2023-31248 • CVE-2023-3090 • CVE-2023-30456 • CVE-2023-2985 • CVE-2023-28322 • CVE-2023-28321 • CVE-2023-2650 • CVE-2023-2612 • CVE-2023-2603 • CVE-2023-2602 • CVE-2023-25012 • CVE-2023-2283 • CVE-2023-20593 • CVE-2023-1998 • CVE-2023-1859 • CVE-2023-1670 • CVE-2023-1667 • CVE-2023-1380 • CVE-2023-1255 • CVE-2023-1079 • CVE-2023-1077 • CVE-2023-1076
fluxcd.source.controller.tanzu.vmware.com	<ul style="list-style-type: none"> ▼ Expand to see the list <ul style="list-style-type: none"> • CVE-2023-2650 • CVE-2023-1255

Package Name	Vulnerabilities Resolved
metadata-store.apps.tanzu.vmware.com	▼ Expand to see the list <ul style="list-style-type: none"> CVE-2023-2603 CVE-2023-2602
spring-cloud-gateway.tanzu.vmware.com	▼ Expand to see the list <ul style="list-style-type: none"> GHSA-crqg-jrpi-fc84 GHSA-6mjq-h674-j845 CVE-2023-34035 CVE-2023-34034 CVE-2023-33008 CVE-2023-31484 CVE-2023-2650 CVE-2023-2603 CVE-2023-2602 CVE-2023-1255
tap-gui.tanzu.vmware.com	▼ Expand to see the list <ul style="list-style-type: none"> GHSA-h755-8qp9-cq85 CVE-2023-23936 CVE-2023-23920 CVE-2023-23919 CVE-2023-0466 CVE-2023-0465 CVE-2022-4304 CVE-2022-3821 CVE-2022-2097

v1.6.2 Resolved issues

The following issues, listed by component and area, are resolved in this release.

v1.6.2 Resolved issues: Supply Chain Choreographer

- Fixed an issue where if a user attempted to update the `ootb_supply_chain_testing_scanning` field in their `tap-values.yaml` file to use a specified ClusterImageTemplate, it did not update because the ClusterSupplyChain was already preset to `image-scanner-template`. You can now update the `ootb_supply_chain_testing_scanning` field in their `tap-values.yaml` to use a specified ClusterImageTemplate.

v1.6.2 Resolved issues: Tanzu Developer Portal - Supply Chain GUI plug-in

- [Supply Chain Security Tools - Scan v2.0](#), which introduces the `ImageVulnerabilityScanner` custom resource definition (CRD), is now supported in the Supply Chain UI.

v1.6.2 Resolved issues: Tanzu Developer Tools for VS Code

- Fixed an issue that prevented Tanzu Debug from working on new untracked workloads on Windows.
-

v1.6.2 Known issues

This release has the following known issues, listed by component and area.

v1.6.2 Known issues: Application Configuration Service

- Client applications that include the `spring-cloud-config-client` dependency might fail to start or properly load the configuration that Application Configuration Service produced.
- Installation might fail because the pod security context does not perfectly adhere to the restricted pod security standard.

v1.6.2 Known issues: Artifact Metadata Repository Observer and CloudEvent Handler

- Periodic reconciliation or restarting of the AMR Observer causes reattempted posting of ImageVulnerabilityScan results. There is an error on duplicate submission of identical ImageVulnerabilityScans you can ignore if the previous submission was successful.
- ReplicaSet status in AMR only has two states: `created` and `deleted`. There is a known issue where the `available` and `unavailable` state is not showing. The workaround is that you can interpolate this information from the `instances` metadata in the AMR for the ReplicaSet.

v1.6.2 Known issues: Bitnami Services

- If you try to configure private registry integration for the Bitnami services after having already created a claim for one or more of the Bitnami services using the default configuration, the updated private registry configuration does not appear to take effect. This is due to caching behavior in the system which is not accounted for during configuration updates. For a workaround, see [Troubleshoot Bitnami Services](#).

v1.6.2 Known issues: Cloud Native Runtimes

- For Knative Serving, certain app name, namespace, and domain combinations produce Knative Services with status `CertificateNotReady`. For more information, see [Troubleshooting](#).

v1.6.2 Known issues: Crossplane

- Crossplane Providers cannot communicate with systems using a custom CA. For more information and a workaround, see [Troubleshoot Crossplane](#).
- The Crossplane `validatingwebhookconfiguration` is not removed when you uninstall the Crossplane Package. To workaround, delete the `validatingwebhookconfiguration` manually by running `kubectl delete validatingwebhookconfiguration crossplane`.

v1.6.2 Known issues: Eventing

- When using vSphere sources in Eventing, the `vsphere-source` is using a high number of informers to alleviate load on the API server. This causes high memory use.

v1.6.2 Known issues: Learning Center

- [CVE-2023-26114](#): Versions of VS Code server before v4.10.1 are vulnerable to Missing Origin Validation in WebSocket handshakes. For mitigation steps, see [Known issues for Learning Center](#).

v1.6.2 Known issues: Services Toolkit

- An error occurs if `additionalProperties` is `true` in a CompositeResourceDefinition. For more information and a workaround, see [Troubleshoot Services Toolkit](#).

v1.6.2 Known issues: Supply Chain Choreographer

- When using the Carvel Package Supply Chains, if the operator updates the parameter `carvel_package.name_suffix`, existing workloads incorrectly output a Carvel package to the GitOps repository that uses the old value of `carvel_package.name_suffix`. You can ignore or delete this package.
- If the size of the resulting OpenAPIv3 specification exceeds a certain size, approximately 3 KB, the Supply Chain does not function. If you use the default Carvel package parameters, you this issue does not occur. If you use custom Carvel package parameters, you might encounter this size limit. If you exceed the size limit, you can either deactivate this feature, or use a workaround. The workaround requires enabling a Tekton feature flag. For more information, see the [Tekton documentation](#).

v1.6.2 Supply Chain Security Tools - Store

- SCST - Store automatically detects PostgreSQL database index corruptions. If SCST - Store finds a PostgreSQL database index corruption issue, it does not reconcile. For how to fix this issue, see [Fix Postgres Database Index Corruption](#).

v1.6.2 Known issues: Tanzu Developer Portal (formerly named Tanzu Application Platform GUI)

- Ad-blocking browser extensions and standalone ad-blocking software can interfere with telemetry collection within the VMware [Customer Experience Improvement Program](#) and restrict access to all or parts of Tanzu Developer Portal. For more information, see [Troubleshooting](#).
- `ScmAuth` is a Backstage concept that abstracts Source Code Management (SCM) authentication into a package. An oversight in a recent code-base migration led to the accidental exclusion of custom `ScmAuth` functions. This exclusion affected some client operations, such as using Application Accelerators to create Git repositories on behalf of users.
- The back-end Kubernetes plug-in reports failure in multicluster environments. In a multicluster environment when one request to a Kubernetes cluster fails, `backstage-kubernetes-backend` reports a failure to the front end. This is a known issue with upstream Backstage and it applies to all released versions of Tanzu Developer Portal. For more information, see [this Backstage code in GitHub](#). This behavior arises from the API at the Backstage level. There are currently no known workarounds. There are plans for upstream commits to Backstage to resolve this issue.

v1.6.2 Known issues: Tanzu Developer Portal - Supply Chain GUI plug-in

- Any workloads created by using a custom resource definition (CRD) might not work as expected. Only Out of the Box (OOTB) Supply Chains are supported in the UI.

- Downloading the SBOM from a vulnerability scan requires additional configuration in `tap-values.yaml`. For more information, see [Troubleshooting](#).

v1.6.2 Known issues: Tanzu Developer Tools for IntelliJ

- The error `com.vdurmont.semver4j.SemverException: Invalid version (no major version)` is shown in the error logs when attempting to perform a workload action before installing the Tanzu CLI apps plug-in.
- If you restart your computer while running Live Update without terminating the Tilt process beforehand, there is a lock that incorrectly shows that Live Update is still running and prevents it from starting again. For the fix, see [Troubleshooting](#).
- Workload actions and Live Update do not work when in a project with spaces in its name, such as `my app`, or in its path, such as `C:\Users\My User\my-app`. For more information, see [Troubleshooting](#).
- An **EDT Thread Exception** error is logged or reported as a notification with a message similar to `"com.intellij.diagnostic.PluginException: 2007 ms to call on EDT TanzuApplyAction#update@ProjectViewPopup"`. For more information, see [Troubleshooting](#).

v1.6.2 Known issues: Tanzu Developer Tools for Visual Studio

- Clicking the red square Stop button in the Visual Studio top toolbar can cause a workload to fail. For more information, see [Troubleshooting](#).

v1.6.2 Known issues: Tanzu Developer Tools for VS Code

- In the Tanzu activity panel, the `config-writer-pull-requester` of type `Runnable` is incorrectly categorized as **Unknown**. The correct category is **Supply Chain**.

v1.6.2 Component versions

The following table lists the supported component versions for this Tanzu Application Platform release.

Component Name	Version
API Auto Registration	0.3.3
API portal	1.4.1
Application Accelerator	1.6.2
Application Configuration Service	2.1.0
Application Live View APIServer	1.6.1
Application Live View back end	1.6.1
Application Live View connector	1.6.1
Application Live View conventions	1.6.1
Application Single Sign-On	4.0.0
Artifact Metadata Repository Observer (alpha)	0.11-alpha.2
Bitnami Services	0.2.0
Carbon Black Scanner for SCST - Scan (beta)	1.2.1-beta.2
Cartographer Conventions	0.7.3

Component Name	Version
cert-manager	2.3.1
Cloud Native Runtimes	2.3.1
Contour	1.24.4
Crossplane	0.2.1
Default Roles	1.1.0
Developer Conventions	0.11.0
Eventing (deprecated)	2.2.3
External Secrets Operator	0.6.1+tap.6
Flux CD Source Controller	0.36.1+tanzu.1
Grype Scanner for SCST - Scan	1.6.140
Learning Center (deprecated)	0.3.1
Learning Center workshops (deprecated)	0.3.0
Local Source Proxy	0.1.0
Namespace Provisioner	0.4.0
Out of the Box Delivery - Basic	0.13.8
Out of the Box Supply Chain - Basic	0.13.8
Out of the Box Supply Chain - Testing	0.13.8
Out of the Box Supply Chain - Testing and Scanning	0.13.8
Out of the Box Templates	0.13.8
Service Bindings	0.9.1
Services Toolkit	0.11.0
Snyk Scanner for SCST - Scan (beta)	1.0.0-beta.156
Source Controller	0.8.0
Spring Boot conventions	1.6.1
Spring Cloud Gateway	2.0.6
Supply Chain Choreographer	0.7.3
Supply Chain Security Tools - Policy Controller	1.4.0
Supply Chain Security Tools - Scan	1.6.141
Supply Chain Security Tools - Scan 2.0 (beta)	0.1.0-beta.137
Supply Chain Security Tools - Store	1.6.3
Tanzu Developer Portal (formerly Tanzu Application Platform GUI)	1.6.5
Tanzu Developer Portal Configurator (beta)	0.1.2
Tanzu Application Platform Telemetry	0.6.1
Tanzu Build Service	1.11.10
Tanzu CLI	0.90.1

Component Name	Version
Tanzu CLI Application Accelerator plug-in	1.6.0
Tanzu CLI Apps plug-in	0.12.1
Tanzu CLI Build Service plug-in	1.0.0
Tanzu CLI Insight plug-in	1.6.3
Tanzu Service CLI plug-in	0.7.0
Tekton Pipelines	0.41.0+tap.8

v1.6.1

Release Date: 27 July 2023

What's new in Tanzu Application Platform v1.6

This release includes the following platform-wide enhancements.

New platform-wide features

- New services available with the Bitnami Service package: MongoDB and Kafka.
- Best practices required to build and deploy workloads at scale are now available in the documentation. For more information, see [Scale workloads](#).

New components

- [Local Source Proxy](#) offers developers a secure and user-friendly approach to seamlessly upload their local source code to a Tanzu Application Platform cluster. This enables developers to navigate their code smoothly through a predefined production pathway using supply chains.

This component reduces the obstacles faced by developers who would otherwise need to manually specify a registry and provide their credentials on their local systems for iterative inner loop workflows.

v1.6.1 New features by component and area

This release includes the following changes, listed by component and area.

v1.6.1 Features: Application Accelerator

- The Application Accelerator plug-in for IntelliJ has now reached general availability. The plug-in for IntelliJ now supports Git repository creation and custom type declarations for options, and embeds telemetry and bootstrapping provenance. For more information, see [Application Accelerator IntelliJ Plug-in](#).

v1.6.1 Features: Application Live View

- You can secure access, at the user level, to sensitive operations that can be executed on a running application using the actuator endpoints. For more information, see [Authorize a user to execute sensitive operations](#).

- Developers can view the live information of natively compiled Spring applications by using Application Live View for lightweight troubleshooting. The pages and metrics that are currently unavailable for natively compiled Spring applications include threads, heap dump, memory graphs, cache manager, conditions, schedules tasks, and actuator information. For more information, see [Enable Spring Native apps for Application Live View](#).

v1.6.1 Features: Application Single Sign-On (AppSSO)

- Incorporates the token expiry settings into the `AuthServer` resource. Service operators can customize the expiry settings of access, refresh, or identity tokens. For more information, see [Token settings](#).
- You can map custom user attributes or claims from upstream identity providers, such as OpenID, LDAP, and SAML. You can also configure the internal unsafe provider with custom claims. For more information, see [Identity providers](#).
- Adds `ClusterUnsafeTestLogin`, which is an unsafe, ready-to-claim Application Single Sign-On service offering that you can use to get started. It is not safe for production environments. For more information, see [ClusterUnsafeTestLogin API](#).
- Adds `ClusterWorkloadRegistrationClass`, which exposes an `AuthServer` as a ready-to-claim Application Single Sign-On service offering. For more information, see [ClusterWorkloadRegistrationClass API](#).
- Adds `WorkloadRegistration`, which is a portable client registration that templates redirect URIs. For more information, see [WorkloadRegistration API](#).
- Adds `XWorkloadRegistration`, which is a composite resource definition (XRD) and an integration API between Services Toolkit, Crossplane, and Application Single Sign-On. For more information, see [XWorkloadRegistration API](#).

v1.6.1 Features: Bitnami Services

The `bitnami.services.tanzu.vmware.com` package v0.2.0 includes the following:

- New services available: MongoDB and Kafka

v1.6.1 Features: Cloud Native Runtimes

- Adds a new configuration option that configures `default-external-scheme` on Knative's `config-network` ConfigMap with a default scheme you can use for Knative Service URLs. Supported values are either `http` or `https`. You cannot set this option at the same time as the `default_tls_secret` option.

v1.6.1 Features: Contour

- Adds new parameters to specify `contour` and `envoy` resources requests and limits for CPU and memory. For more information, see [Install Contour](#).
- For more information about the new features in Contour v1.24.4, see the [Contour release notes](#) in GitHub.

v1.6.1 Features: Crossplane

The `crossplane.tanzu.vmware.com` package v0.2.1 includes the following:

- Includes updates to the following software components:

- Updates Universal Crossplane (UXP) to v1.12.1-up.1, which includes new Crossplane features such as ObserveOnly resources, Composition Validation, and Pluggable Secret Stores. For the full release notes, see [universal-crossplane releases](#) in GitHub.
- Updates provider-helm to v0.15.0. For the full release notes, see [provider-helm releases](#) in GitHub.
- Updates provider-kubernetes to v0.8.0. For the full release notes, see [provider-kubernetes releases](#) in GitHub.

For more information about versions of software comprising the Crossplane package, See [Version matrix for Crossplane](#).

- The Crossplane package now more gracefully handles situations in which Crossplane is already installed to a cluster by using another method, for example, through Helm install. For more information, see [Use your existing Crossplane installation](#).
- Includes kapp wait rules that match on `Healthy=True` for the Providers. This means that package installation now waits for the Providers to become healthy before reporting success.
- Adds support for installing Providers in environments that use custom CA certificates.
- Adds the `orphan_resources` package value to allow you to configure whether to orphan all Crossplane Custom Resource Definitions (CRDs), providers, and managed resources when the package is uninstalled. This setting is optional. The default is `true`.



Caution

setting this value to `false` causes all Crossplane CRDs, providers, and managed resources to be deleted when the `crossplane.tanzu.vmware.com` package is uninstalled. This might also cause any existing service instances also being deleted. For more information, see [Delete Crossplane resources when you uninstall Tanzu Application Platform](#).

v1.6.1 Features: Flux CD Source Controller

Flux Source Controller v0.36.1-build.2 release includes the following API changes:

- `GitRepository` API:
 - `spec.ref.name` is the reference value for Git checkout. It takes precedence over Branch, Tag, and SemVer. It must be a valid [Git reference](#).

Examples:

- `"refs/heads/main"`
- `"refs/tags/v0.1.0"`
- `"refs/pull/420/head"`
- `"refs/merge-requests/1/head"`
- `status.artifact.digest` represents the value of the file in the form of `ALGORITHM:CHECKSUM`.
- `status.observedIgnore` represents the latest `spec.ignore` value. It indicates the ignore rules for building the current artifact in storage.

- `status.observedRecurseSubmodules` represents the latest `spec.recurseSubmodules` value during the latest reconciliation.
 - `status.observedInclude` represents the list of `GitRepository` resources that produces the current artifact.
- `OCIRepository` API:
 - `spec.layerSelector` specifies which layer is extracted from an OCI Artifact. This field is optional and set to extracting the first layer in the artifact by default.
 - `spec.verify` includes the secret name that holds the trusted public keys for signature verification. It also indicates the provider responsible for validating the authenticity of the OCI image.
 - `spec.insecure` enables connections to a non-TLS HTTP container image registry.
- `HelmChart` API:
 - Adds the new field `spec.verify`, which includes the secret name that holds the trusted public keys for signature verification. It also indicates the provider responsible for validating the authenticity of the OCI image. This field is only supported when using the `HelmRepository` source with the `spec.type` `OCI`. Chart dependencies, which are not bundled in the umbrella chart artifact, are not verified.
- `HelmRepository` API:
 - Adds the new field `spec.provider` for authentication purposes. Supported values are `aws`, `azure`, `gcp`, or `generic`. `generic` is its default value. This field is only required when the `.spec.type` field is set to `oci`
- `Bucket` API:
 - Adds the new field `status.observedIgnore`, which represents the latest `spec.ignore` value. It indicates the ignore rules for building the current artifact in storage.

v1.6.1 Features: Namespace Provisioner

- Implements the capability to skip creating certain default resources for the Namespace Provisioner, providing greater flexibility for customization.
- Enables you to deactivate the default installation of the Grype scanner by using `default_parameters` in the `tap-values.yaml` file or by using namespace parameters. For more information, see [Deactivate Grype install](#).
- Enhances support for adding `secrets` and `imagePullSecrets` to the service account used by the Supply Chain and Delivery components. You can do this by using either `default_parameters` or namespace-level parameters. For more information, see [Customize service accounts](#).
- Introduces the option to deactivate the creation of the `LimitRange` object in `full`, `iterate`, and `run` profile clusters. For more information, see [Deactivate LimitRange Setup](#).
- Adds support for passing lists or objects with annotations for complex namespace parameters. This simplifies the configuration process. For more information about how to use this feature, see [Namespace parameters](#).
- The `path` value in `additional_sources` is now automatically generated, eliminating the need for you to provide it manually. This simplifies the configuration of external sources.

v1.6.1 Features: Services Toolkit

The `services-toolkit.tanzu.vmware.com` package v0.11.0 includes the following:

- Adds Kubernetes events to make debugging easier:
 - Normal events: CreatedCompositeResource, DeletedCompositeResource, ClaimableInstanceFound, NoClaimableInstancesFound
 - Warning events: ParametersValidationFailed, CompositeResourceDeletionFailed
- Updates reconciler-runtime to v0.11.1.

The Tanzu Service CLI plug-in v0.7.0 includes the following:

- The Tanzu Service CLI plug-in is now compiled using the new Tanzu CLI runtime (v0.90.0).
- There are no new features or changes to existing commands.

v1.6.1 Features: Supply Chain Choreographer

- [Carvel Package Supply Chains](#) are promoted from [alpha](#) to [beta](#).

v1.6.1 Features: Supply Chain Security Tools (SCST) - Scan

- The source scanning step is removed from the Out of the Box Supply Chain - Testing and Scanning. For information about how to add the source scanning step to the test and scan supply chain, see [Scan Types for Supply Chain Security Tools - Scan](#).
- [Supply Chain Security Tools - Scan 2.0](#) is promoted from [alpha](#) to [beta](#). This promotion primarily includes capabilities to integrate the SCST-Scan 2.0 component with other components of the Tanzu Application Platform, including:
 - The ability to enable Supply Chain Security Tools (SCST) - Scan 2.0 in the Out of the Box Supply Chain - Testing and Scanning. For more information, see [Add app scanning to default test and scan supply chains](#).
 - [Artifact Metadata Repository \(AMR\) Observer \(alpha\)](#) observes scan results from SCST - Scan 2.0 and archives them to the [AMR \(beta\)](#) for long-term storage and reporting, and use by other Tanzu Application Platform components.
 - Results from image scans with SCST - Scan 2.0 are now available in [Supply Chain Choreographer](#) and [Security Analysis](#) plug-ins for the Tanzu Developer Portal.
 - [Sample scan templates](#) are created to help users get started with examples of how to bring your own scanner:
 - [Carbon Black](#)
 - [Snyk](#)
 - [Prisma](#)
 - [Trivy](#)
 - [Grype](#)
 - VMware encourages feedback about SCST - Scan 2.0. Email your VMware representative or [contact us here](#).

v1.6.1 Features: Supply Chain Security Tools (SCST) - Store

- Adds a new report feature that links all packages, vulnerabilities, and ratings associated from a specific vulnerability scan SBOM to a Store report. When querying a report, it returns information linked to the original SBOM report instead of returning the aggregated data of all reports for the linked image or source.
 - Updates to the `POST /api/v1/images` and `POST /api/v1/sources` APIs:
 - New optional header request fields:

- **Report-UID:** A unique identifier to assign to the report. If omitted, a unique identifier is randomly generated for the report. Supported characters: uppercase letters (A-Z), lowercase letters (a-z), numbers (0-9), hyphen (-), period (.), underscore (_), and tilde (~).
 - **Original-Location:** The stored location of the original SBOM vulnerability scan result used to create this report.
 - New response field returned **ReportUID**, the report's unique identifier associated with the data submitted by this image.
- Updates to the **POST /api/v1/artifact-groups** API:
 - New **ReportUID** optional body payload field that links an existing report, tagged by its UID, to this artifact group.
- New **GET /api/v1/report/{ReportUID}** API gets a specific report by its unique identifier.
- New **GET /api/v1/reports** API queries for a list of reports with specified image digest, source SHA, or original location.



Note

When you request SPDX or CycloneDX format, the report date is set to the date of the original vulnerability scan SBOM. In addition, the tooling section includes the tool used to generate the original vulnerability scan report, if provided, and SCST - Store.

- Artifact Metadata Repository Observer (alpha). For more information, see [Artifact Metadata Repository overview](#)
 - Registers the cluster's location using user defined labels and the kube-system UID as the reference
 - Observes ImageVulnerabilityScan CustomResources from [SCST - Scan 2.0 package](#)
 - Observes workload ReplicaSets. These are ReplicaSets that have a container with the name `workload`, which are produced by the Out of the Box Supply Chains.
 - Sends CloudEvents for observed resources to the Artifact Metadata Repository CloudEvent Handler
- Artifact Metadata Repository CloudEvent Handler (alpha). See [Artifact Metadata Repository overview](#).
 - The name Artifact Metadata Repository Persister is deprecated in favor of Artifact Metadata Repository CloudEvent Handler.
 - Handles ImageVulnerabilityScan configured CloudEvents from the Artifact Metadata Repository Observer.
 - Handles Location configured CloudEvents from the Artifact Metadata Repository Observer.
 - Handles ReplicaSet configured CloudEvents from the Artifact Metadata Repository Observer.
- Adds a new vulnerability triage feature allows you to store analysis data for vulnerabilities detected in their workloads. The vulnerability analysis data allows you to record the impact of a particular vulnerability, to discover an effective remediation plan.

- New triage API supports the creating, updating, and searching vulnerability analysis. For more information, see [v1trriage](#).
- New triage subcommands for the Tanzu CLI Insight plug-in enable interaction with the triage API. For more information, see [Triage vulnerabilities](#).

v1.6.1 Features: Tanzu CLI

- This Tanzu Application Platform release introduces the new Tanzu CLI v0.90.1.



Important

Newer versions of Tanzu CLI might be supported when they are released, for more information, see [Product Interoperability Matrix](#). VMware strongly encourages you to upgrade to the latest Tanzu CLI version.

- Backward compatibility with earlier versions of Tanzu CLI plug-ins is provided.
- Install Tanzu CLI using a package manager. For more information, see [Install the Tanzu CLI](#).
- Install plug-ins from the new centralized plug-in repository using plug-in groups. For more information, see [Install Tanzu CLI Plug-ins](#).
- For Internet-restricted environments, plug-ins and plug-in groups can be migrated to, and installed from internal registries.
- There is now central Tanzu CLI documentation where more detailed information about the CLI architecture, the centralized plug-in repository, plug-in groups, and Internet-restricted environments is available. For more information, see [VMware Tanzu CLI documentation](#).
- If you have any issues, questions, or suggestions, you can submit feedback, feature requests, or issue reports in the open-source [Tanzu CLI project on GitHub](#).

v1.6.1 Features: Tanzu CLI plug-in distribution change

- Tanzu CLI plug-ins are no longer distributed as part of the Tanzu Application Platform bundle on VMware Tanzu Network. The Tanzu CLI is still included in the bundle.
- The plug-ins are now installed using Tanzu CLI commands. Manual download of the plug-in binaries to the local file system is no longer required.
- For Internet-restricted environments, see [Installing the Tanzu CLI in Internet-Restricted Environments](#).

v1.6.1 Features: Tanzu CLI Apps plug-in

- The apps plug-in is integrated with Local Source Proxy for seamless iterative inner-loop development using the Tanzu CLI or IDE plug-ins.
- The `tanzu apps workload apply` and `tanzu apps workload create` commands can now seamlessly create a workload from local source using only the `--local-path` flag.
- The `--source-image` flag is now optional. If `--source-image` flag is used with `--local-path`, the local source proxy is not used and bypassed for backward compatibility.
- A new command, `tanzu apps lsp health` is available. It allows you to verify the status of the Local Source Proxy. This command performs several checks, including:
 - Verifies whether the developer has Role-Based Access Control (RBAC) permissions to access the Local Source Proxy using their kubeconfig.

- Checks if the Local Source Proxy is installed on the cluster.
 - Ensures that the Local Source Proxy deployment is healthy and accessible.
 - Verifies that the Local Source Proxy is correctly configured and can access the registry using the credentials set up by the operator during Tanzu Application Platform installation.
- Auto-completion is available for workload types. Additionally, the default workload type is set to `web`, making the `--type` flag optional. The flag is only required if the type is something other than `web`.
- The shorthand option `-e` is available as a convenient alternative for the `--export` flag.
- The `tanzu apps workload get` command is enhanced to include Git revision information in the overview section. This provides a quick reference to the Git revision associated with the workload.

v1.6.1 Features: Tanzu CLI Build Service plug-in

- Adds a new Build Service plug-in that allows you to view all Tanzu Build Service resources on any Kubernetes cluster that has Tanzu Application Platform or Tanzu Build Service installed. For more information, see [Build Service CLI plug-in overview](#).

v1.6.1 Features: Tanzu CLI Insight plug-in

- Triage vulnerabilities with the `tanzu insight triage` command. For more information, see [Triage vulnerabilities](#).

v1.6.1 Features: Tanzu Developer Portal (formerly named Tanzu Application Platform GUI)

- Download the Software Bill of Materials (SBOM) from the Supply Chain Cartographer (SCC) plug-in. Obtain the SCST - Store-generated SBOM in SPDX or CycloneDX formats.
- The component is renamed as Tanzu Developer Portal to reflect that it's more than just a graphical user interface (GUI) for Tanzu Application Platform.
- As of this release, the tool Configurator is available in beta. Configurator enables the integration of Backstage-compatible plug-ins in Tanzu Developer Portal. For more information, see [Tanzu Developer Portal Configurator](#).
- Permission framework is released in alpha. Permission framework enables the Platform Operator to evaluate visibility restriction of the software catalog entities based on ownership property. For more information, see [Set up permission framework for your Tanzu Developer Portal](#)

v1.6.1 Features: Tanzu Developer Tools for IntelliJ

- Added support for Local Source Proxy that eliminates the need to provide source image configuration for rapid iteration in the inner loop.
- You can now use Tanzu Developer Tools for IntelliJ to rapidly iterate on Spring-native applications. Developers can Live Update and debug spring-native applications non-natively and then deploy to a cluster as a native image.
- Developers can now use Tanzu Developer Tools for IntelliJ to rapidly iterate and build Gradle projects in their preferred IDE.

v1.6.1 Features: Tanzu Developer Tools for VS Code

- Added support for Local Source Proxy that eliminates the need to provide source image configuration for rapid iteration in the inner loop.
- You can now use Tanzu Developer Tools for VS Code to rapidly iterate on Spring-native applications. Developers can Live Update and debug spring-native applications non-natively and then deploy to a cluster as a native image.
- Developers can now use Tanzu Developer Tools for VS Code to rapidly iterate and build Gradle projects in their preferred IDE.

v1.6.1 Features: Tanzu Developer Tools for Visual Studio

- Added a Tanzu Workloads panel to easily view deployed workloads in a Tanzu Application Platform cluster.
- You can now use Tanzu Developer Tools for Visual Studio to directly manage workloads, which includes the functions Apply Workload, Start Live Update, and Debug Workload.

v1.6.1 Breaking changes

This release includes the following changes, listed by component and area.

v1.6.1 Breaking changes: Application Single Sign-On (AppSSO)

- Consumes Application Single Sign-On service offerings using `ClassClaim` instead of the lower-level `WorkloadRegistration` or `ClientRegistration`.
- Crossplane is an installation and runtime dependency of Application Single Sign-On.
- The field `AuthServer.spec.tls.disabled` is removed. Use `AuthServer.spec.tls.deactivated` instead.
- The default for field `ClientRegistration.spec.redirectURIs` is no longer `["http://127.0.0.0:8080"]`.

v1.6.1 Breaking changes: Cloud Native Runtimes

- The `provider` configuration option is removed in this release. For more information, see the [Deprecation notice](#) in the Cloud Native Runtimes v2.0 release notes.

v1.6.1 Breaking changes: Contour

- By default, Tanzu Application Platform uses TLS 1.3 as the minimum TLS version for Contour. Certain infrastructure setups might cause request failures if the Envoy clients do not support TLS 1.3. You might see the following errors in the Envoy logs:

```
[source/extensions/transport_sockets/tls/ssl_socket.cc:233] [C112] remote address:20.27.140.81:3073,TLS error: 268435696:SSL routines:OPENSSSL_internal:UNSUPPORTED_PROTOCOL
```

To set the minimum TLS version to 1.2, see [Configure Cipher Suites and TLS version in Contour](#).

v1.6.1 Breaking changes: Flux CD Source Controller

- The format of the `status.artifact.revision` value in the `GitRepository` resource's status field is updated from `BRANCH/CHECKSUM` to `BRANCH@sha1:CHECKSUM`. For example,

```
main/6db88c7a7e7dec1843809b058195b68480c4c12a is now  
main@sha1:6db88c7a7e7dec1843809b058195b68480c4c12a.
```

v1.6.1 Breaking changes: Tanzu Build Service

- The full dependencies package is renamed and the installation process is modified.
 - You must remove existing full dependencies installations before installing the new version.
 - You must provide the `tap-values.yaml` file during the full dependencies package installation.
- The full dependencies package repository is tagged with the Tanzu Application Platform package version instead of the Tanzu Build Service package version.
- The Ubuntu Bionic stack is no longer included with the Tanzu Application Platform and the full dependencies package repository.
- Introduced a cluster buildpack resource to enable individually packaged dependencies and provide insights into installed buildpack versions.

v1.6.1 Breaking changes: Tanzu CLI Apps plug-in

- The deprecated command `tanzu apps workload update` is removed from the CLI. Use the command `tanzu apps workload apply` instead.

v1.6.1 Breaking changes: Tanzu Developer Portal (formerly named Tanzu Application Platform GUI)

- The `allowGuestAccess` configuration option: Previously this was not needed in the configuration because users were permitted to log in without credentials by default. In v1.6 and later, guest users must be permitted explicitly. The recommended values files in the installation sections are updated to include this setting. Add the following lines to `tap-values.yaml` to enable guest access explicitly:

```
# Existing tap-values.yaml settings  
tap_gui:  
  app_config:  
    auth:  
      allowGuestAccess: true # Allows unauthenticated users to log in to your  
portal. If you deactivate it, configure an alternative auth provider.
```

v1.6.1 Security fixes

This release has the following security fixes, listed by package.

Package name	Vulnerabilities resolved
accelerator.apps.tanzu.vmware.com	▼ Expand to see the list <ul style="list-style-type: none"> • GHSA-3f7h-mf4q-vrm4 • CVE-2023-31484 • CVE-2023-29491 • CVE-2023-2650 • CVE-2023-20863 • CVE-2023-20861 • CVE-2023-1255 • CVE-2023-0466 • CVE-2023-0465 • CVE-2023-0464 • CVE-2022-3996 • CVE-2022-29458
api-portal.tanzu.vmware.com	▼ Expand to see the list <ul style="list-style-type: none"> • CVE-2023-29491 • CVE-2023-2650 • CVE-2023-1255 • CVE-2022-29458
apis.apps.tanzu.vmware.com	▼ Expand to see the list <ul style="list-style-type: none"> • CVE-2023-1255 • CVE-2022-3996
apiserver.appliveview.tanzu.vmware.com	▼ Expand to see the list <ul style="list-style-type: none"> • CVE-2023-2650 • CVE-2023-1255 • CVE-2023-0466 • CVE-2023-0465 • CVE-2023-0464 • CVE-2022-3996
app-scanning.apps.tanzu.vmware.com	▼ Expand to see the list <ul style="list-style-type: none"> • CVE-2023-2650 • CVE-2023-1255 • CVE-2023-0466 • CVE-2023-0465 • CVE-2023-0464 • CVE-2022-3996
application-configuration-service.tanzu.vmware.com	▼ Expand to see the list <ul style="list-style-type: none"> • CVE-2023-20863 • CVE-2023-20861

Package name	Vulnerabilities resolved
backend.appliveview.tanzu.vmware.com	<p data-bbox="829 224 1053 257">▼ Expand to see the list</p> <ul data-bbox="877 257 1077 504" style="list-style-type: none"><li data-bbox="877 257 1077 291">• CVE-2023-2650<li data-bbox="877 302 1077 336">• CVE-2023-1255<li data-bbox="877 347 1077 380">• CVE-2023-0466<li data-bbox="877 392 1077 425">• CVE-2023-0465<li data-bbox="877 436 1077 470">• CVE-2023-0464<li data-bbox="877 481 1077 515">• CVE-2022-3996

Package name	Vulnerabilities resolved
buildservice.tanzu.vmware.com	<ul style="list-style-type: none"> ▼ Expand to see the list <ul style="list-style-type: none"> • GHSA-m5m3-46gj-wch8 • GHSA-hw7c-3rfg-p46j • GHSA-gwrp-pvrq-jmwv • GHSA-gp7f-rwcx-9369 • GHSA-2qjp-425j-52j9 • CVE-2023-33288 • CVE-2023-33203 • CVE-2023-32254 • CVE-2023-32250 • CVE-2023-32233 • CVE-2023-31436 • CVE-2023-30772 • CVE-2023-30456 • CVE-2023-2953 • CVE-2023-28466 • CVE-2023-28327 • CVE-2023-28322 • CVE-2023-28321 • CVE-2023-26242 • CVE-2023-2612 • CVE-2023-25012 • CVE-2023-23004 • CVE-2023-23000 • CVE-2023-22995 • CVE-2023-2283 • CVE-2023-2269 • CVE-2023-2235 • CVE-2023-2194 • CVE-2023-2156 • CVE-2023-2124 • CVE-2023-20863 • CVE-2023-20861 • CVE-2023-2007 • CVE-2023-2002 • CVE-2023-1998 • CVE-2023-1990 • CVE-2023-1989 • CVE-2023-1859 • CVE-2023-1855 • CVE-2023-1670 • CVE-2023-1667 • CVE-2023-1611

Package name	Vulnerabilities resolved
	<ul style="list-style-type: none"> • CVE-2023-1380 • CVE-2023-1194 • CVE-2023-1193 • CVE-2023-1192 • CVE-2023-1079 • CVE-2023-1077 • CVE-2023-1076 • CVE-2023-0597 • CVE-2023-0030 • CVE-2022-48425 • CVE-2022-45919 • CVE-2022-45888 • CVE-2022-45887 • CVE-2022-45886 • CVE-2022-45885 • CVE-2022-45884 • CVE-2022-4543 • CVE-2022-44034 • CVE-2022-44033 • CVE-2022-44032 • CVE-2022-4285 • CVE-2022-4269 • CVE-2022-41848 • CVE-2022-40133 • CVE-2022-38457 • CVE-2022-38096 • CVE-2022-36402 • CVE-2022-36033 • CVE-2022-3523 • CVE-2022-3238 • CVE-2022-3114 • CVE-2022-2961 • CVE-2022-27943 • CVE-2022-25836 • CVE-2022-1247 • CVE-2022-0995 • CVE-2022-0480 • CVE-2022-0400 • CVE-2021-45261 • CVE-2021-4148 • CVE-2021-4095 • CVE-2021-3864 • CVE-2021-29425

Package name	Vulnerabilities resolved
	<ul style="list-style-type: none"> • CVE-2021-26934 • CVE-2020-35501 • CVE-2020-14304 • CVE-2020-13844 • CVE-2019-19814 • CVE-2019-19378 • CVE-2019-15213 • CVE-2019-14899 • CVE-2019-1010204 • CVE-2018-6952 • CVE-2018-20657 • CVE-2018-17977 • CVE-2018-12931 • CVE-2018-12930 • CVE-2018-12929 • CVE-2018-12928 • CVE-2018-1121 • CVE-2018-1000021 • CVE-2017-13716 • CVE-2017-13693 • CVE-2017-13165 • CVE-2017-0537 • CVE-2016-8660 • CVE-2015-8553 • CVE-2013-7445
<hr/> cnrs.tanzu.vmware.com	<ul style="list-style-type: none"> ▼ Expand to see the list <ul style="list-style-type: none"> • CVE-2023-2650 • CVE-2023-1255 • CVE-2023-0466 • CVE-2023-0465 • CVE-2023-0464 • CVE-2022-3996
<hr/> connector.appliveview.tanzu.vmware.com	<ul style="list-style-type: none"> ▼ Expand to see the list <ul style="list-style-type: none"> • CVE-2023-2650 • CVE-2023-1255 • CVE-2023-0466 • CVE-2023-0465 • CVE-2023-0464 • CVE-2022-3996 <hr/>

Package name	Vulnerabilities resolved
controller.source.apps.tanzu.vmware.com	<p>▼ Expand to see the list</p> <ul style="list-style-type: none">• GHSA-hw7c-3rfg-p46j• GHSA-6wrf-mxfj-pf5p• GHSA-33pg-m6jh-5237• CVE-2023-2650• CVE-2023-1255
conventions.appliveview.tanzu.vmware.com	<p>▼ Expand to see the list</p> <ul style="list-style-type: none">• CVE-2023-2650• CVE-2023-1255• CVE-2023-0466• CVE-2023-0465• CVE-2023-0464• CVE-2022-3996
developer-conventions.tanzu.vmware.com	<p>▼ Expand to see the list</p> <ul style="list-style-type: none">• CVE-2023-0466• CVE-2023-0465• CVE-2023-0464• CVE-2022-3996
fluxcd.source.controller.tanzu.vmware.com	<p>▼ Expand to see the list</p> <ul style="list-style-type: none">• GHSA-pwcw-6f5g-gxf8• GHSA-hmfx-3pcx-653p• GHSA-7hfp-qfw3-5jxh• GHSA-6rx9-889q-vv2r• GHSA-67fx-wx78-jx33• GHSA-53c4-hhnh-vw5q• GHSA-2qjp-425j-52j9• GHSA-259w-8hf6-59c2• CVE-2023-0466• CVE-2023-0465• CVE-2023-0464• CVE-2022-3996

Package name	Vulnerabilities resolved
learningcenter.tanzu.vmware.com	<ul style="list-style-type: none"> ▼ Expand to see the list • GHSA-hhbj-cfjx-vj25 • GHSA-gp7f-rwcx-9369 • GHSA-cxcx-vr6p-4858 • GHSA-8gw7-4j42-w388 • GHSA-3633-5h82-39pq • CVE-2023-29469 • CVE-2023-29007 • CVE-2023-28487 • CVE-2023-28486 • CVE-2023-28484 • CVE-2023-28328 • CVE-2023-27538 • CVE-2023-27536 • CVE-2023-27535 • CVE-2023-27534 • CVE-2023-27533 • CVE-2023-27522 • CVE-2023-27320 • CVE-2023-26607 • CVE-2023-26606 • CVE-2023-26605 • CVE-2023-26545 • CVE-2023-26544 • CVE-2023-25815 • CVE-2023-25690 • CVE-2023-25652 • CVE-2023-23918 • CVE-2023-23916 • CVE-2023-23915 • CVE-2023-23914 • CVE-2023-23559 • CVE-2023-23455 • CVE-2023-23454 • CVE-2023-21843 • CVE-2023-21835 • CVE-2023-21830 • CVE-2023-2166 • CVE-2023-21102 • CVE-2023-2006 • CVE-2023-2004 • CVE-2023-1872 • CVE-2023-1652

Package name	Vulnerabilities resolved
	<ul style="list-style-type: none"> • CVE-2023-1382 • CVE-2023-1264 • CVE-2023-1195 • CVE-2023-1175 • CVE-2023-1170 • CVE-2023-1074 • CVE-2023-1073 • CVE-2023-0804 • CVE-2023-0803 • CVE-2023-0802 • CVE-2023-0801 • CVE-2023-0800 • CVE-2023-0799 • CVE-2023-0798 • CVE-2023-0797 • CVE-2023-0796 • CVE-2023-0795 • CVE-2023-0458 • CVE-2023-0433 • CVE-2023-0394 • CVE-2023-0361 • CVE-2023-0288 • CVE-2023-0266 • CVE-2023-0210 • CVE-2023-0054 • CVE-2023-0051 • CVE-2023-0049 • CVE-2023-0045 • CVE-2022-48424 • CVE-2022-48423 • CVE-2022-4842 • CVE-2022-48303 • CVE-2022-47929 • CVE-2022-47521 • CVE-2022-47520 • CVE-2022-47519 • CVE-2022-47518 • CVE-2022-47024 • CVE-2022-45869 • CVE-2022-4415 • CVE-2022-4382 • CVE-2022-4379 • CVE-2022-42329

Package name	Vulnerabilities resolved
	<ul style="list-style-type: none"> • CVE-2022-42328 • CVE-2022-4139 • CVE-2022-4129 • CVE-2022-41218 • CVE-2022-40898 • CVE-2022-3996 • CVE-2022-3821 • CVE-2022-36280 • CVE-2022-36056 • CVE-2022-36033 • CVE-2022-3545 • CVE-2022-3521 • CVE-2022-3435 • CVE-2022-3424 • CVE-2022-3344 • CVE-2022-3169 • CVE-2022-2980 • CVE-2022-2946 • CVE-2022-2923 • CVE-2022-2849 • CVE-2022-2845 • CVE-2022-2581 • CVE-2022-2571 • CVE-2022-24963 • CVE-2022-23649 • CVE-2022-2345 • CVE-2022-2344 • CVE-2022-2304 • CVE-2022-2207 • CVE-2022-2206 • CVE-2022-2196 • CVE-2022-2183 • CVE-2022-2175 • CVE-2022-2129 • CVE-2022-2126 • CVE-2022-2125 • CVE-2022-2124 • CVE-2022-1968 • CVE-2022-1942 • CVE-2022-1927 • CVE-2022-1898 • CVE-2022-1851 • CVE-2022-1796

Package name	Vulnerabilities resolved
	<ul style="list-style-type: none"> • CVE-2022-1785 • CVE-2022-1735 • CVE-2022-1733 • CVE-2022-1720 • CVE-2022-1674 • CVE-2022-1629 • CVE-2022-0729 • CVE-2022-0714 • CVE-2022-0685 • CVE-2022-0629 • CVE-2022-0572 • CVE-2022-0554 • CVE-2022-0443 • CVE-2022-0413 • CVE-2022-0408 • CVE-2022-0368 • CVE-2022-0361 • CVE-2022-0359 • CVE-2022-0351 • CVE-2022-0319 • CVE-2022-0318 • CVE-2022-0261 • CVE-2022-0213
<p>metadata-store.apps.tanzu.vmware.com</p>	<p>▼ Expand to see the list</p> <ul style="list-style-type: none"> • CVE-2023-29469 • CVE-2023-28484 • CVE-2023-2455 • CVE-2023-2454 • CVE-2023-0466 • CVE-2023-0465 • CVE-2023-0464 • CVE-2022-4415 • CVE-2022-3996 • CVE-2022-3821 • CVE-2021-39537 • CVE-2019-17595 • CVE-2019-17594

Package name	Vulnerabilities resolved
ootb-templates.tanzu.vmware.com	<ul style="list-style-type: none"> ▼ Expand to see the list • GHSA-m8cg-xc2p-r3fc • GHSA-hw7c-3rfg-p46j • GHSA-g2j6-57v7-gm8c • CVE-2023-28328 • CVE-2023-27538 • CVE-2023-27536 • CVE-2023-27535 • CVE-2023-27534 • CVE-2023-27533 • CVE-2023-26606 • CVE-2023-26545 • CVE-2023-26544 • CVE-2023-23559 • CVE-2023-23455 • CVE-2023-23454 • CVE-2023-21102 • CVE-2023-1872 • CVE-2023-1829 • CVE-2023-1652 • CVE-2023-1281 • CVE-2023-1074 • CVE-2023-1073 • CVE-2023-0466 • CVE-2023-0465 • CVE-2023-0464 • CVE-2023-0458 • CVE-2023-0394 • CVE-2023-0386 • CVE-2023-0266 • CVE-2023-0210 • CVE-2023-0045 • CVE-2022-48424 • CVE-2022-48423 • CVE-2022-4842 • CVE-2022-47929 • CVE-2022-4382 • CVE-2022-4129 • CVE-2022-41218 • CVE-2022-3996 • CVE-2022-36280 • CVE-2022-3424

Package name	Vulnerabilities resolved
	<ul style="list-style-type: none"> • CVE-2022-2196
scanning.apps.tanzu.vmware.com	<p>▼ Expand to see the list</p> <ul style="list-style-type: none"> • CVE-2023-2650 • CVE-2023-1255
services-toolkit.tanzu.vmware.com	<p>▼ Expand to see the list</p> <ul style="list-style-type: none"> • GHSA-vfvj-3m3g-m532 • GHSA-v829-x6hh-cqfq • CVE-2023-27484 • CVE-2023-2650 • CVE-2023-1255 • CVE-2023-0466 • CVE-2023-0465 • CVE-2023-0464 • CVE-2022-3996
sso.apps.tanzu.vmware.com	<p>▼ Expand to see the list</p> <ul style="list-style-type: none"> • GHSA-m8cg-xc2p-r3fc • GHSA-g2j6-57v7-gm8c • GHSA-f3fp-gc8g-vw66 • CVE-2023-2650 • CVE-2023-20863 • CVE-2023-20861 • CVE-2023-1255 • CVE-2023-0466 • CVE-2023-0465 • CVE-2023-0464 • CVE-2022-3996 • CVE-2022-3821
tap-gui.tanzu.vmware.com	<p>▼ Expand to see the list</p> <ul style="list-style-type: none"> • GHSA-x77j-w7wf-fjmw • GHSA-qwph-4952-7xr6 • GHSA-p5gc-c584-jj6v • GHSA-jv3g-j58f-9mq9 • GHSA-hjrf-2m68-5959 • GHSA-8cf7-32gw-wr33 • GHSA-7hv8-3fr9-j2hv • GHSA-6w63-h3fj-q4vw

Package name	Vulnerabilities resolved
workshops.learningcenter.tanzu.vmware.com	<ul style="list-style-type: none"> ▼ Expand to see the list <ul style="list-style-type: none"> • GHSA-wxc4-f4m6-wwqv • GHSA-v95c-p5hm-xq8f • GHSA-qq97-vm5h-rrhg • GHSA-p782-xgp4-8hr8 • GHSA-p5gc-c584-jj6v • GHSA-m8cg-xc2p-r3fc • GHSA-hmfx-3pcx-653p • GHSA-hhqj-cfjx-vj25 • GHSA-h86h-8ppg-mxmh • GHSA-gp7f-rwcx-9369 • GHSA-gc89-7gcr-jxqc • GHSA-g2j6-57v7-gm8c • GHSA-f3fp-gc8g-vw66 • GHSA-c2h3-6mxw-7mvq • GHSA-8gw7-4j42-w388 • GHSA-77vh-xpmg-72qh • GHSA-6wrf-mxfj-pf5p • GHSA-5j5w-g665-5m35 • GHSA-5ffw-gxpp-mxpf • GHSA-45rm-2893-5f49 • GHSA-3633-5h82-39pq • GHSA-33pg-m6jh-5237 • GHSA-2qjp-425j-52j9 • GHSA-259w-8hf6-59c2 • CVE-2023-34969 • CVE-2023-33288 • CVE-2023-33203 • CVE-2023-32665 • CVE-2023-32643 • CVE-2023-32636 • CVE-2023-32611 • CVE-2023-32269 • CVE-2023-32254 • CVE-2023-32250 • CVE-2023-31484 • CVE-2023-30772 • CVE-2023-2953 • CVE-2023-29499 • CVE-2023-29491 • CVE-2023-29469 • CVE-2023-29007 • CVE-2023-28531

Package name	Vulnerabilities resolved
	<ul style="list-style-type: none">• CVE-2023-28487• CVE-2023-28486• CVE-2023-28484• CVE-2023-28466• CVE-2023-28328• CVE-2023-28327• CVE-2023-28322• CVE-2023-28321• CVE-2023-27538• CVE-2023-27536• CVE-2023-27535• CVE-2023-27534• CVE-2023-27533• CVE-2023-27522• CVE-2023-27320• CVE-2023-27043• CVE-2023-26607• CVE-2023-26606• CVE-2023-26605• CVE-2023-26545• CVE-2023-26544• CVE-2023-2650• CVE-2023-26242• CVE-2023-2612• CVE-2023-2610• CVE-2023-2609• CVE-2023-2603• CVE-2023-2602• CVE-2023-25815• CVE-2023-25690• CVE-2023-25652• CVE-2023-25588• CVE-2023-25585• CVE-2023-25584• CVE-2023-25180• CVE-2023-25012• CVE-2023-24593• CVE-2023-2426• CVE-2023-23936• CVE-2023-23920• CVE-2023-23918• CVE-2023-23916• CVE-2023-23915

Package name	Vulnerabilities resolved
	<ul style="list-style-type: none"> • CVE-2023-23914 • CVE-2023-23559 • CVE-2023-23455 • CVE-2023-23454 • CVE-2023-23004 • CVE-2023-23000 • CVE-2023-22995 • CVE-2023-2283 • CVE-2023-2269 • CVE-2023-2235 • CVE-2023-2194 • CVE-2023-21843 • CVE-2023-21835 • CVE-2023-21830 • CVE-2023-2166 • CVE-2023-2162 • CVE-2023-2156 • CVE-2023-2124 • CVE-2023-21102 • CVE-2023-20938 • CVE-2023-2007 • CVE-2023-2006 • CVE-2023-2004 • CVE-2023-2002 • CVE-2023-1999 • CVE-2023-1998 • CVE-2023-1990 • CVE-2023-1989 • CVE-2023-1972 • CVE-2023-1872 • CVE-2023-1859 • CVE-2023-1855 • CVE-2023-1670 • CVE-2023-1667 • CVE-2023-1652 • CVE-2023-1611 • CVE-2023-1513 • CVE-2023-1382 • CVE-2023-1264 • CVE-2023-1255 • CVE-2023-1195 • CVE-2023-1194 • CVE-2023-1193

Package name	Vulnerabilities resolved
	<ul style="list-style-type: none"> • CVE-2023-1192 • CVE-2023-1175 • CVE-2023-1170 • CVE-2023-1118 • CVE-2023-1079 • CVE-2023-1078 • CVE-2023-1077 • CVE-2023-1076 • CVE-2023-1075 • CVE-2023-1074 • CVE-2023-1073 • CVE-2023-0804 • CVE-2023-0803 • CVE-2023-0802 • CVE-2023-0801 • CVE-2023-0800 • CVE-2023-0799 • CVE-2023-0798 • CVE-2023-0797 • CVE-2023-0796 • CVE-2023-0795 • CVE-2023-0597 • CVE-2023-0464 • CVE-2023-0459 • CVE-2023-0458 • CVE-2023-0433 • CVE-2023-0401 • CVE-2023-0394 • CVE-2023-0361 • CVE-2023-0288 • CVE-2023-0266 • CVE-2023-0217 • CVE-2023-0216 • CVE-2023-0215 • CVE-2023-0210 • CVE-2023-0054 • CVE-2023-0051 • CVE-2023-0049 • CVE-2023-0045 • CVE-2023-0030 • CVE-2022-4899 • CVE-2022-48425 • CVE-2022-48424

Package name	Vulnerabilities resolved
	<ul style="list-style-type: none"> • CVE-2022-48423 • CVE-2022-4842 • CVE-2022-48281 • CVE-2022-47929 • CVE-2022-47521 • CVE-2022-47520 • CVE-2022-47519 • CVE-2022-47518 • CVE-2022-47024 • CVE-2022-46908 • CVE-2022-45919 • CVE-2022-45888 • CVE-2022-45887 • CVE-2022-45886 • CVE-2022-45885 • CVE-2022-45884 • CVE-2022-45869 • CVE-2022-4543 • CVE-2022-4450 • CVE-2022-4415 • CVE-2022-44034 • CVE-2022-44033 • CVE-2022-44032 • CVE-2022-4382 • CVE-2022-4379 • CVE-2022-4304 • CVE-2022-4285 • CVE-2022-4269 • CVE-2022-42329 • CVE-2022-42328 • CVE-2022-4203 • CVE-2022-41848 • CVE-2022-4139 • CVE-2022-4129 • CVE-2022-41218 • CVE-2022-40898 • CVE-2022-40735 • CVE-2022-40133 • CVE-2022-3996 • CVE-2022-3857 • CVE-2022-38457 • CVE-2022-3821 • CVE-2022-38096

Package name	Vulnerabilities resolved
	<ul style="list-style-type: none"> • CVE-2022-3715 • CVE-2022-3707 • CVE-2022-36402 • CVE-2022-36280 • CVE-2022-36056 • CVE-2022-36033 • CVE-2022-3545 • CVE-2022-3523 • CVE-2022-3521 • CVE-2022-3435 • CVE-2022-3424 • CVE-2022-3344 • CVE-2022-3238 • CVE-2022-32215 • CVE-2022-32214 • CVE-2022-32213 • CVE-2022-32212 • CVE-2022-3169 • CVE-2022-3114 • CVE-2022-2982 • CVE-2022-2980 • CVE-2022-2961 • CVE-2022-2946 • CVE-2022-29458 • CVE-2022-2923 • CVE-2022-2889 • CVE-2022-2862 • CVE-2022-2849 • CVE-2022-2845 • CVE-2022-27943 • CVE-2022-27672 • CVE-2022-25836 • CVE-2022-2581 • CVE-2022-2571 • CVE-2022-24963 • CVE-2022-23649 • CVE-2022-2345 • CVE-2022-2344 • CVE-2022-2343 • CVE-2022-2304 • CVE-2022-2207 • CVE-2022-2206 • CVE-2022-2196

Package name	Vulnerabilities resolved
	<ul style="list-style-type: none"> • CVE-2022-2183 • CVE-2022-2182 • CVE-2022-2175 • CVE-2022-2129 • CVE-2022-2126 • CVE-2022-2125 • CVE-2022-2124 • CVE-2022-2097 • CVE-2022-2068 • CVE-2022-1968 • CVE-2022-1942 • CVE-2022-1927 • CVE-2022-1898 • CVE-2022-1886 • CVE-2022-1851 • CVE-2022-1796 • CVE-2022-1785 • CVE-2022-1735 • CVE-2022-1733 • CVE-2022-1720 • CVE-2022-1674 • CVE-2022-1629 • CVE-2022-1292 • CVE-2022-1247 • CVE-2022-0995 • CVE-2022-0729 • CVE-2022-0714 • CVE-2022-0696 • CVE-2022-0685 • CVE-2022-0629 • CVE-2022-0572 • CVE-2022-0554 • CVE-2022-0480 • CVE-2022-0443 • CVE-2022-0413 • CVE-2022-0408 • CVE-2022-0407 • CVE-2022-0400 • CVE-2022-0393 • CVE-2022-0368 • CVE-2022-0361 • CVE-2022-0359 • CVE-2022-0351

Package name	Vulnerabilities resolved
	<ul style="list-style-type: none"> • CVE-2022-0319 • CVE-2022-0318 • CVE-2022-0261 • CVE-2022-0213 • CVE-2022-0158 • CVE-2022-0156 • CVE-2022-0128 • CVE-2021-45261 • CVE-2021-4148 • CVE-2021-4095 • CVE-2021-40812 • CVE-2021-3864 • CVE-2021-3712 • CVE-2021-26934 • CVE-2021-23840 • CVE-2020-36634 • CVE-2020-35501 • CVE-2020-17753 • CVE-2020-14304 • CVE-2020-14145 • CVE-2020-13844 • CVE-2020-13401 • CVE-2019-19814 • CVE-2019-19378 • CVE-2019-1563 • CVE-2019-15213 • CVE-2019-14899 • CVE-2019-1010204 • CVE-2018-6952 • CVE-2018-20699 • CVE-2018-20657 • CVE-2018-17977 • CVE-2018-12931 • CVE-2018-12930 • CVE-2018-12929 • CVE-2018-12928 • CVE-2018-1121 • CVE-2018-10126 • CVE-2018-1000021 • CVE-2017-13716 • CVE-2017-13693 • CVE-2017-13165 • CVE-2017-0537

Package name	Vulnerabilities resolved
	<ul style="list-style-type: none"> • CVE-2016-8660 • CVE-2016-4472 • CVE-2016-20013 • CVE-2016-1585 • CVE-2016-0718 • CVE-2015-8553 • CVE-2015-1283 • CVE-2013-7445 • CVE-2013-1779 • CVE-2012-1148 • CVE-2012-0876 • CVE-2009-3720 • CVE-2007-2379 • CVE-2004-2761

v1.6.1 Resolved issues

The following issues, listed by component and area, are resolved in this release.

v1.6.1 Resolved issues: Cloud Native Runtimes

- New toggle feature for how to make ConfigMap updates. For some ConfigMaps in Cloud Native Runtimes, such as config-features, the option to update using an overlay was not taking effect. This issue is fixed.

With this version, the legacy behavior remains the same, but VMware introduced a configuration to opt-in into updating ConfigMaps using overlays in Cloud Native Runtimes. To configure this option, edit your `cnr-values.yaml` file to change the following configuration:

```
allow_manual_configmap_update: false
```

v1.6.1 Resolved issues: Crossplane

- The Crossplane package now more gracefully handles situations in which Crossplane is already installed to a cluster by using another method, for example, Helm install.

Previously the Crossplane Package assumed that Crossplane was not already installed on the cluster, which is not always true. Rather than fail, the package completed installing, which caused non-deterministic behavior.

Now, if you attempt to install or upgrade the Crossplane package on a cluster that has Crossplane installed by other means, it fails with the error `Resource already exists`. In such cases, you can either exclude the Crossplane package from the Tanzu Application Platform installation, or set `adopt_resources` to true in the Crossplane package to adopt resources from your existing installation. For more information, see [Use your existing Crossplane installation](#).

- Resolved an issue where Crossplane Providers did not transition to `HEALTHY=True` if using a custom certificate for your registry. This prevented the class claims used for dynamic provisioning from reconciling. The Crossplane Package now inherits the data configured in `shared.ca_cert_data` of `tap-values.yaml`.

v1.6.1 Resolved issues: Namespace Provisioner

- Resolved an issue that prevented updates to the AWS Identity and Access Management (IAM) role from reflecting in the service accounts used by Supply Chains and Delivery components.
- Resolved a behavior where the Namespace Provisioner failed if the same Git secret was used multiple times within the `additional_sources` section of the `tap-values.yaml` file. This fix requires Cluster Essentials v1.6 or later installed on the cluster.
- Resolved an issue where a namespace managed by the Namespace Provisioner became stuck in the `Terminating` phase during deletion if it contained a workload. This fix requires Cluster Essentials v1.6 or later installed on the cluster.

v1.6.1 Resolved issues: Services Toolkit

- Resolved an issue that prevented the default cluster-admin IAM role on Google Kubernetes Engine (GKE) clusters from claiming any of the Bitnami services.

Previously, if a user with the cluster-admin role on a GKE cluster attempted to claim any of the Bitnami services, they received a validation error.

- Resolved an issue affecting the dynamic provisioning flow if you used a `CompositeResourceDefinition` that specified a schema that defined `.status` without also defining `.spec`. You can now use a `CompositeResourceDefinition` which only specifies `.status` in the schema.

Previously, if you attempted to create a `ClassClaim` for a `ClusterInstanceClass` that referred to such a `CompositeResourceDefinition`, the `ClassClaim` did not transition into `Ready=True` and instead reported `unexpected end of JSON input`.

v1.6.1 Resolved issues: Supply Chain Security Tools (SCST) - Store

- Implemented basic logging in the AMR database.
- AMR database no longer creates a load balancer when enabling the shared ingress domain and ingress values in `tap-values.yaml`.
- Modified the behavior of the `/v1/artifact-groups/vulnerabilities/_search` endpoint. It now returns a list of artifact groups affected by the vulnerability even if the images or sources in the query are not linked to them.

Previously the endpoint returned the list of artifact groups the images or sources were linked to, even if the artifact group was not affected by the vulnerability.

v1.6.1 Resolved issues: Tanzu CLI Apps plug-in

- Implemented validations to prevent the inclusion of multiple sources through flags in the `workload create` and `workload apply` commands.
- Modified the behavior of the commands when waiting to apply workload changes. If the workload was previously in a failed state, it no longer immediately fails. When the `--wait` flag is used, the command continues to wait until the workload either succeeds or fails again. When the `--tail` flag is used, the command continues tailing logs from the Supply chain steps that were impacted by the workload update.

v1.6.1 Resolved issues: Tanzu Developer Tools for IntelliJ

- The `apply` action no longer stores the workload file path, which prevented modifying the workload file path later. Now this information is either computed or obtained by prompting the user as needed.
- In the Tanzu activity panel, the `config-writer-pull-requester` of the type `Runnable` is no longer incorrectly categorized as **Unknown**.

v1.6.1 Resolved issues: Tanzu Developer Tools for VS Code

- Errors in the kubeconfig file `~/.kube/config` that are not related to the current context are now ignored, allowing you to work with Tanzu panel without any issues.

v1.6.1 Known issues

This release has the following known issues, listed by component and area.



Note

Starting in this release, the release notes list known issues in every release until they are resolved.

v1.6.1 Known issues: Application Configuration Service

- Client applications that include the `spring-cloud-config-client` dependency might fail to start or properly load the configuration that Application Configuration Service produced.
- Installation might fail because the pod security context does not perfectly adhere to the restricted pod security standard.

v1.6.1 Known issues: Artifact Metadata Repository Observer and CloudEvent Handler

- Periodic reconciliation or restarting of the AMR Observer causes reattempted posting of ImageVulnerabilityScan results. There is an error on duplicate submission of identical ImageVulnerabilityScans you can ignore if the previous submission was successful.
- ReplicaSet status in AMR only has two states: `created` and `deleted`. There is a known issue where the `available` and `unavailable` state is not showing. The workaround is that you can interpolate this information from the `instances` metadata in the AMR for the ReplicaSet.

v1.6.1 Known issues: Bitnami Services

- If you try to configure private registry integration for the Bitnami services after having already created a claim for one or more of the Bitnami services using the default configuration, the updated private registry configuration does not appear to take effect. This is due to caching behavior in the system which is not accounted for during configuration updates. For a workaround, see [Troubleshoot Bitnami Services](#).

v1.6.1 Known issues: Cloud Native Runtimes

- For Knative Serving, certain app name, namespace, and domain combinations produce Knative Services with status `CertificateNotReady`. For more information, see [Troubleshooting](#).

v1.6.1 Known issues: Crossplane

- Crossplane Providers cannot communicate with systems using a custom CA. For more information and a workaround, see [Troubleshoot Crossplane](#).
- The Crossplane `validatingwebhookconfiguration` is not removed when you uninstall the Crossplane Package. To workaround, delete the `validatingwebhookconfiguration` manually by running `kubectl delete validatingwebhookconfiguration crossplane`.

v1.6.1 Known issues: Eventing

- When using vSphere sources in Eventing, the `vsphere-source` is using a high number of informers to alleviate load on the API server. This causes high memory use.

v1.6.1 Known issues: Learning Center

- [CVE-2023-26114](#): Versions of VS Code server before v4.10.1 are vulnerable to Missing Origin Validation in WebSocket handshakes. For mitigation steps, see [Known issues for Learning Center](#).

v1.6.1 Known issues: Services Toolkit

- An error occurs if `additionalProperties` is `true` in a CompositeResourceDefinition. For more information and a workaround, see [Troubleshoot Services Toolkit](#).

v1.6.1 Known issues: Supply Chain Choreographer

- When using the Carvel Package Supply Chains, if the operator updates the parameter `carvel_package.name_suffix`, existing workloads incorrectly output a Carvel package to the GitOps repository that uses the old value of `carvel_package.name_suffix`. You can ignore or delete this package.
- If the size of the resulting OpenAPIv3 specification exceeds a certain size, approximately 3 KB, the Supply Chain does not function. If you use the default Carvel package parameters, you this issue does not occur. If you use custom Carvel package parameters, you might encounter this size limit. If you exceed the size limit, you can either deactivate this feature, or use a workaround. The workaround requires enabling a Tekton feature flag. For more information, see the [Tekton documentation](#).
- The ClusterSupplyChain `scanning-image-scan-to-url` does not update if you attempt to update the `ootb_supply_chain_testing_scanning` field in the `tap-values.yaml` file to use a specified ClusterImageTemplate as follows:

```
ootb_supply_chain_testing_scanning:
  image_scanner_template_name: CLUSTERIMAGETEMPLATE
```

This is because the ClusterSupplyChain is preset to `image-scanner-template`. To workaround, edit the Out of the Box Supply template following the steps [Modifying an Out of the Box Supply template](#).

v1.6.1 Supply Chain Security Tools - Store

- SCST - Store automatically detects PostgreSQL database index corruptions. If SCST - Store finds a PostgreSQL database index corruption issue, it does not reconcile. For how to fix this issue, see [Fix Postgres Database Index Corruption](#).

v1.6.1 Known issues: Tanzu Developer Portal (formerly named Tanzu Application Platform GUI)

- Ad-blocking browser extensions and standalone ad-blocking software can interfere with telemetry collection within the VMware [Customer Experience Improvement Program](#) and restrict access to all or parts of Tanzu Developer Portal. For more information, see [Troubleshooting](#).
- [ScmAuth](#) is a Backstage concept that abstracts Source Code Management (SCM) authentication into a package. An oversight in a recent code-base migration led to the accidental exclusion of custom ScmAuth functions. This exclusion affected some client operations, such as using Application Accelerators to create Git repositories on behalf of users.
- The back-end Kubernetes plug-in reports failure in multicluster environments. In a multicluster environment when one request to a Kubernetes cluster fails, `backstage-kubernetes-backend` reports a failure to the front end. This is a known issue with upstream Backstage and it applies to all released versions of Tanzu Developer Portal. For more information, see [this Backstage code in GitHub](#). This behavior arises from the API at the Backstage level. There are currently no known workarounds. There are plans for upstream commits to Backstage to resolve this issue.

v1.6.1 Known issues: Tanzu Developer Portal - Supply Chain GUI plug-in

- Any workloads created by using a custom resource definition (CRD) might not work as expected. Only Out of the Box (OOTB) Supply Chains are supported in the GUI.
- [Supply Chain Security Tools - Scan v2.0](#), which introduces the `ImageVulnerabilityScanner` CRD, is not currently supported in the Supply Chain GUI.
- Downloading the SBOM from a vulnerability scan requires additional configuration in `tap-values.yaml`. For more information, see [Troubleshooting](#).

v1.6.1 Known issues: Tanzu Developer Tools for IntelliJ

- The error `com.vdurmont.semver4j.SemverException: Invalid version (no major version)` is shown in the error logs when attempting to perform a workload action before installing the Tanzu CLI apps plug-in.
- If you restart your computer while running Live Update without terminating the Tilt process beforehand, there is a lock that incorrectly shows that Live Update is still running and prevents it from starting again. For the fix, see [Troubleshooting](#).
- Workload actions and Live Update do not work when in a project with spaces in its name, such as `my app`, or in its path, such as `C:\Users\My User\my-app`. For more information, see [Troubleshooting](#).
- An **EDT Thread Exception** error is logged or reported as a notification with a message similar to `"com.intellij.diagnostic.PluginException: 2007 ms to call on EDT TanzuApplyAction#update@ProjectViewPopup"`. For more information, see [Troubleshooting](#).

v1.6.1 Known issues: Tanzu Developer Tools for Visual Studio

- Clicking the red square Stop button in the Visual Studio top toolbar can cause a workload to fail. For more information, see [Troubleshooting](#).

v1.6.1 Known issues: Tanzu Developer Tools for VS Code

- In the Tanzu activity panel, the `config-writer-pull-requester` of type `Runnable` is incorrectly categorized as **Unknown**. The correct category is **Supply Chain**.

- Tanzu Debug does not work on Windows for new workloads. When attempting to Tanzu Debug on Windows, the user sees an error message similar to the following:

```
Error: unable to check if filepath "'FILE-PATH'" is a valid url.
```

For more information, see [Troubleshooting](#).

v1.6.1 Component versions

The following table lists the supported component versions for this Tanzu Application Platform release.

Component Name	Version
API Auto Registration	0.3.3
API portal	1.4.0
Application Accelerator	1.6.1
Application Configuration Service	2.1.0
Application Live View APIserver	1.6.1
Application Live View back end	1.6.1
Application Live View connector	1.6.1
Application Live View conventions	1.6.1
Application Single Sign-On	4.0.0
Artifact Metadata Repository Observer (alpha)	0.1.0-alpha.8
Bitnami Services	0.2.0
Carbon Black Scanner for SCST - Scan (beta)	1.2.1-beta.1
Cartographer Conventions	0.7.3
cert-manager	2.3.1
Cloud Native Runtimes	2.3.1
Contour	1.24.4
Crossplane	0.2.1
Default Roles	1.1.0
Developer Conventions	0.11.0
Eventing (deprecated)	2.2.3-build.36
External Secrets Operator	0.6.1+tap.6
Flux CD Source Controller	0.36.1-build.2
Grype Scanner for SCST - Scan	1.6.66
Learning Center (deprecated)	0.3.1
Learning Center workshops (deprecated)	0.3.0
Local Source Proxy	0.1.0
Namespace Provisioner	0.4.0
Out of the Box Delivery - Basic	0.13.6

Component Name	Version
Out of the Box Supply Chain - Basic	0.13.6
Out of the Box Supply Chain - Testing	0.13.6
Out of the Box Supply Chain - Testing and Scanning	0.13.6
Out of the Box Templates	0.13.6
Service Bindings	0.9.1
Services Toolkit	0.11.0
Snyk Scanner for SCST - Scan (beta)	1.0.0-beta.71
Source Controller	0.8.0
Spring Boot conventions	1.6.1
Spring Cloud Gateway	2.0.3
Supply Chain Choreographer	0.7.3
Supply Chain Security Tools - Policy Controller	1.4.0
Supply Chain Security Tools - Scan	1.6.67
Supply Chain Security Tools - Scan 2.0 (beta)	0.1.0-beta.45
Supply Chain Security Tools - Store	1.6.2
Tanzu Developer Portal (formerly Tanzu Application Platform GUI)	1.6.3
Tanzu Developer Portal Configurator (beta)	0.1.2
Tanzu Application Platform Telemetry	0.6.1
Tanzu Build Service	1.11.10
Tanzu CLI	0.90.0
Tanzu CLI Application Accelerator plug-in	1.6.0
Tanzu CLI Apps plug-in	0.12.1
Tanzu CLI Build Service plug-in	1.0.0
Tanzu CLI Insight plug-in	1.6.0
Tanzu Service CLI plug-in	0.7.0
Tekton Pipelines	0.41.0+tap.8

Deprecations

The following features, listed by component, are deprecated. Deprecated features will remain on this list until they are retired from Tanzu Application Platform.

Tanzu Application Platform deprecations

- Minikube support is deprecated and will be removed in Tanzu Application Platform v1.7.

Application Live View deprecations

- `appliveview_connector.backend.sslDisabled` is deprecated and marked for removal in Tanzu Application Platform v1.7.0. For more information about the migration, see

Deprecate the `sslDisabled` key.

Application Single Sign-On (AppSSO) deprecations

- `ClientRegistration` resource `clientAuthenticationMethod` field values `post` and `basic` are deprecated and marked for removal in Tanzu Application Platform v1.7.0. Use `client_secret_post` and `client_secret_basic` instead.

Eventing deprecations

- Eventing in Tanzu Application Platform is deprecated and marked for removal in Tanzu Application Platform v1.7.0.

Flux CD Source Controller deprecations

- Deprecations for the `GitRepository` API:
 - `spec.gitImplementation` is deprecated. `GitImplementation` defines the Git client library implementation. `go-git` is the default and only supported implementation. `libgit2` is no longer supported.
 - `spec.accessFrom` is deprecated. `AccessFrom`, which defines an Access Control List for enabling cross-namespace references to this object, was never implemented.
 - `status.contentConfigChecksum` is deprecated in favor of the explicit fields defined in the observed artifact content config within the status.
 - `status.artifact.checksum` is deprecated in favor of `status.artifact.digest`.
 - `status.url` is deprecated in favor of `status.artifact.url`.
- Deprecations for the `OCIRepository` API:
 - `status.contentConfigChecksum` is deprecated in favor of the explicit fields defined in the observed artifact content config within the status.

Learning Center deprecations

- Learning Center is deprecated and marked for removal in Tanzu Application Platform v1.7.0. Use [Tanzu Academy](#) instead for all Tanzu Application Platform learning and education needs.

Services Toolkit deprecations

- The `tanzu services claims` CLI plug-in command is now deprecated. It is hidden from help text output, but continues to work until officially removed after the deprecation period. The new `tanzu services resource-claims` command provides the same function.

Source Controller deprecations

- The Source Controller `ImageRepository` API is deprecated and is marked for removal. Use the `OCIRepository` API instead. The Flux Source Controller installation includes the `OCIRepository` API. For more information about the `OCIRepository` API, see the [Flux documentation](#).

Supply Chain Choreographer deprecations

- Supply Chain Choreographer no longer uses the `git_implementation` field. The `go-git` implementation now assumes that `libgit2` is not supported.

- Flux CD no longer supports the `spec.gitImplementation` field as of v0.33.0. For more information, see the [fluxcd/source-controller Changelog](#).
- Existing references to the `git_implementation` field are ignored and references to `libgit2` do not cause failures. This is assured up to Tanzu Application Platform v1.9.0.
- Azure DevOps works without specifying `git_implementation` in Tanzu Application Platform v1.6.1.

Supply Chain Security Tools (SCST) - Scan deprecations

- The `docker` field and related sub-fields used in SCST - Scan are deprecated and marked for removal in Tanzu Application Platform v1.7.0.

The deprecation impacts the following components: Scan Controller, Grype Scanner, and Snyk Scanner. Carbon Black Scanner is not impacted. For information about the migration path, see [Troubleshooting](#).

- The profile based installation of Grype to a developer namespace and related fields in the values file, such as `grype.namespace` and `grype.targetImagePullSecret`, are deprecated and marked for removal in Tanzu Application Platform v1.8.0.

VMware recommends using the namespace provisioner to populate namespaces with all the required resources, including the Grype installation. For information about how to use namespace provisioner to populate a namespace with SCST - SCST scan, see [Setup for OOTB Supply Chains](#).

Tanzu Build Service deprecations

- The Ubuntu Bionic stack is deprecated: Ubuntu Bionic stops receiving support in April 2023. VMware recommends you migrate builds to Jammy stacks in advance. For how to migrate builds, see [Use Jammy stacks for a workload](#).
- The Cloud Native Buildpack Bill of Materials (CNB BOM) format is deprecated. VMware plans to deactivate this format by default in Tanzu Application Platform v1.6.1 and remove support in Tanzu Application Platform v1.8.

Tanzu CLI Apps plug-in deprecations

- The default value for the `-update-strategy` flag is planned to change from `merge` to `replace` in Tanzu Application Platform v1.7.0.

Tekton Pipelines deprecations

- Tekton `ClusterTask` is deprecated and marked for removal. Use the `Task` API instead. For more information, see the [Tekton documentation](#).

Linux Kernel CVEs

Kernel level vulnerabilities are regularly identified and patched by Canonical. Tanzu Application Platform releases with available images, which might contain known vulnerabilities. When Canonical makes patched images available, Tanzu Application Platform incorporates these fixed images into future releases.

The kernel runs on your container host VM, not the Tanzu Application Platform container image. Even with a patched Tanzu Application Platform image, the vulnerability is not mitigated until you

deploy your containers on a host with a patched OS. An unpatched host OS might be exploitable if the base image is deployed.

Components and installation profiles for Tanzu Application Platform

This topic lists the components you can install with Tanzu Application Platform (commonly known as TAP). You can install components as individual packages or you can install them using a profile containing a predefined group of packages.

Tanzu Application Platform components

- **API Auto Registration**

When users deploy a [workload](#) that exposes an API, they want that API to automatically show in Tanzu Developer Portal (formerly named Tanzu Application Platform GUI) without requiring any added manual steps.

API Auto Registration is an automated workflow that can use a supply chain to create and manage a Kubernetes Custom Resource (CR) of type [APIDescriptor](#). A Kubernetes controller reconciles the CR and updates the API entity in Tanzu Developer Portal to achieve automated API registration from workloads. You can also use API Auto Registration without supply chains by directly applying an [APIDescriptor](#) CR to the cluster.

- **API portal**

API portal for VMware Tanzu enables API consumers to find APIs they can use in their own applications.

Consumers can view detailed API documentation and try out an API to see if it meets their needs. API portal assembles its dashboard and detailed API documentation views by ingesting OpenAPI documentation from the source URLs. An API portal operator can add any number of OpenAPI source URLs to appear in a single instance.

- **API Scoring and Validation**

API Validation and Scoring focuses on scanning and validating an OpenAPI specification. The API specification is generated from the [API Auto Registration](#). After an API is registered, the API specification goes through static scan analysis and is validated. Based on the validation, a scoring is provided to indicate the quality and health of the API specification as it relates to Documentation, OpenAPI best practices, and Security.

- **Application Accelerator**

The Application Accelerator component helps app developers and app operators create application accelerators.

Accelerators are templates that codify best practices and ensure that important configurations and structures are in place. Developers can bootstrap their applications and get started with feature development right away.

Application operators can create custom accelerators that reflect their desired architectures and configurations and enable fleets of developers to use them. This helps ease operator concerns about whether developers are implementing their best practices.

- **Application Configuration Service**

Application Configuration Service provides a Kubernetes-native experience to enable the runtime configuration of existing Spring applications that were previously leveraged by using Spring Cloud Config Server.

Application Configuration Service is compatible with the existing Git repository configuration management approach. It filters runtime configuration for any application by using slices that produce secrets.

- **Application Live View**

Application Live View is a lightweight insight and troubleshooting tool that helps application developers and application operators look inside running applications.

It is based on the concept of Spring Boot Actuators. The application provides information from inside the running processes by using endpoints (in our case, HTTP endpoints).

Application Live View uses those endpoints to get the data from the application and to interact with it.

- **Application Single Sign-On**

Application Single Sign-On enables application users to sign in to their identity provider once and be authorized and identified to access any Kubernetes-deployed workload. It is a secure and straightforward approach for developers and operators to manage access across all workloads in the enterprise.

- **Bitnami Services**

Bitnami Services provides a set of services for Tanzu Application Platform backed by corresponding Bitnami Helm Charts. Through integration with [Crossplane](#) and [Services Toolkit](#), these Bitnami Services are immediately ready for apps teams to consume, with no additional setup or configuration required from ops teams. This makes it incredibly quick and easy to get started working with services on Tanzu Application Platform.

- **Cartographer Conventions**

Use Cartographer Conventions to ensure infrastructure uniformity across workloads deployed on the cluster. Cartographer Conventions provide a way to control how applications should be deployed on Kubernetes using a convention. Use Cartographer Conventions to apply the runtime best practices, policies, and conventions of your organization to workloads as they are created on the platform.

- **cert-manager**

cert-manager adds certificates and certificate issuers as resource types to Kubernetes clusters. It also helps you to obtain, renew, and use those certificates. For more information about cert-manager, see the [cert-manager documentation](#).

- **Cloud Native Runtimes**

Cloud Native Runtimes for Tanzu is a serverless application runtime for Kubernetes that is based on Knative and runs on a single Kubernetes cluster. For information about Knative, see the [Knative documentation](#).

- **Contour**

Contour is an ingress controller for Kubernetes that supports dynamic configuration updates and multi-team ingress delegation. It provides the control plane for the Envoy edge and service proxy. For more information about Contour, see the [Contour documentation](#).

- **Default roles for Tanzu Application Platform**

This package includes five default roles for users, including app-editor, app-viewer, app-operator, and service accounts including workload and deliverable. These roles are available to help operators limit permissions a user or service account requires on a cluster that runs

Tanzu Application Platform. They are built by using aggregated cluster roles in Kubernetes role-based access control (RBAC). Default roles only apply to a user interacting with the cluster by using `kubectl` and Tanzu CLI.

- **Crossplane**

Crossplane is an open source, Cloud Native Computing Foundation (CNCF) project built on the foundation of Kubernetes. Tanzu Application Platform uses Crossplane to power a number of capabilities, such as dynamic provisioning of services instances with [Services Toolkit](#) and the [Bitnami Services](#).

- **Developer Conventions**

Developer conventions configure workloads to prepare them for inner loop development.

It's meant to be a "deploy and forget" component for developers. After it is installed on the cluster with the Tanzu Package CLI, developers do not need to directly interact with it.

Developers instead interact with the Tanzu Developer Tools for VSCode IDE Extension or Tanzu CLI Apps plug-in, which rely on the Developer Conventions to edit the workload to enable inner loop capabilities.

- **Eventing**

Eventing for VMware Tanzu focuses on providing tooling and patterns for Kubernetes applications to manage event-triggered systems through Knative Eventing. For information about Knative, see the [Knative documentation](#).

- **Flux CD Source Controller**

The main role of this source management component is to provide a common interface for artifact acquisition.

- **Learning Center**

Learning Center provides a platform for creating and self-hosting workshops. With Learning Center, content creators can create workshops from markdown files that learners can view in a terminal shell environment with an instructional wizard UI. The UI can embed slide content, an integrated development environment (IDE), a web console for accessing the Kubernetes cluster, and other custom web applications.

Although Learning Center requires Kubernetes to run, and it teaches users about Kubernetes, you can use it to host training for other purposes as well. For example, you can use it to train users on web-based applications, use of databases, or programming languages.

- **Local Source Proxy**

Local Source Proxy is a secure and convenient means for you to interact with external registries without providing a lot of registry details.

With Local Source Proxy, developers can interact with external registries without needing to know registry specifics, such as endpoints, credentials, and certificates. This eliminates the burden of platform and app operators having to distribute registry credentials to developer workstations.

Developers can also seamlessly deploy their applications without managing registry credentials on their local machines or keeping track of where their local source is uploaded.

- **Namespace Provisioner**

Namespace Provisioner provides an easy, secure, automated way for Platform Operators to provision namespaces with the resources and proper namespace-level privileges needed for developer workloads to function as intended.

- **Service Bindings**

Service Bindings create a Kubernetes-wide specification for communicating service secrets to workloads in a consistent way.

- **Services Toolkit**

Services Toolkit is responsible for backing many of the most exciting and powerful capabilities for services in Tanzu Application Platform. From the integration of an extensive list of cloud-based and on-prem services, through to the offering and discovery of those services, and finally to the claiming and binding of service instances to application workloads, Services Toolkit has the tools you need to make working with services on Tanzu Application Platform simple, easy, and effective.

- **Source Controller**

Tanzu Source Controller provides a standard interface for artifact acquisition and extends the function of [Flux CD Source Controller](#). Tanzu Source Controller supports the following two resource types:

- ImageRepository (deprecated)
- MavenArtifact

- **Spring Boot conventions**

The Spring Boot convention server has a bundle of smaller conventions applied to any Spring Boot application that is submitted to the supply chain in which the convention controller is configured.

- **Spring Cloud Gateway**

Spring Cloud Gateway for Kubernetes is an API gateway solution based on the open-source Spring Cloud Gateway project. It provides a simple means to route internal or external API requests to application services that expose APIs.

- **Supply Chain Choreographer**

Supply Chain Choreographer is based on open-source [Cartographer](#). It enables app operators to create preapproved paths to production by integrating Kubernetes resources with the elements of their existing toolchains, such as Jenkins.

Each pre-approved supply chain creates a paved road to production. It orchestrates supply chain resources, namely test, build, scan, and deploy. Enabling developers to focus on delivering value to their users. Pre-approved supply chains also assure application operators that all code in production has passed through the steps of an approved workflow.

- **Supply Chain Security Tools - Policy Controller**

Supply Chain Security Tools - Policy is an admission controller that allows a cluster operator to specify policies to verify image container signatures before admitting them to a cluster. It works with [cosign signature format](#) and allows for fine-tuned configuration of policies based on image source patterns.

- **Supply Chain Security tools for Tanzu - Scan**

With Supply Chain Security Tools for VMware Tanzu - Scan, you can build and deploy secure trusted software that complies with their corporate security requirements.

To enable this, Supply Chain Security Tools - Scan provides scanning and gate keeping capabilities that Application and DevSecOps teams can incorporate earlier in their path to production. This is an established industry best practice for reducing security risk and ensuring more efficient remediation.

- **Supply Chain Security Tools - Store**

Supply Chain Security Tools - Store saves software bills of materials (SBoMs) to a database and enables you to query for image, source, package, and vulnerability relationships. It integrates with SCST - Scan to automatically store the resulting source and image vulnerability reports.

- **Tanzu Developer Portal**

Tanzu Developer Portal lets your developers view your organization's running applications and services. It provides a central location for viewing dependencies, relationships, technical documentation, and even service status. Tanzu Developer Portal is built from the Cloud Native Computing Foundation's project Backstage.

- **Tanzu Application Platform Telemetry**

Tanzu Application Platform Telemetry is a set of objects that collect data about the use of Tanzu Application Platform and send it back to VMware for product improvements. A benefit of remaining enrolled in telemetry and identifying your company during Tanzu Application Platform installation is that VMware can provide your organization with use reports about Tanzu Application Platform. For information about enrolling in telemetry reports, see [Tanzu Application Platform usage reports](#).



Note

You can opt out of telemetry collection by following the instructions in [Opting out of telemetry collection](#).

- **Tanzu Build Service**

Tanzu Build Service uses the open-source Cloud Native Build packs project to turn application source code into container images.

Tanzu Build Service executes reproducible builds that align with modern container standards and keeps images up to date. It does so by leveraging Kubernetes infrastructure with kpack, a Cloud Native Build packs Platform, to orchestrate the image life cycle.

The kpack CLI tool, `kp`, can aid in managing kpack resources. Build Service helps you develop and automate containerized software workflows securely and at scale.

- **Tanzu Buildpacks**

Tanzu Buildpacks provide framework and runtime support for applications. Buildpacks typically examine your applications to work out what dependencies to download and how to configure the apps to communicate with bound services.

Tanzu Buildpacks use open-source [Paketo Buildpacks](#) to allow Tanzu Application Platform users to turn their application source code into container images. From Tanzu Application Platform v1.6, builders, stacks, and buildpacks are packaged separately from Tanzu Build Service, but are included in the same Tanzu Application Platform profiles as Tanzu Build Service. All buildpacks follow the package name format `*.buildpacks.tanzu.vmware.com`.

- **Tanzu Developer Tools for IntelliJ**

Tanzu Developer Tools for IntelliJ is the official VMware Tanzu IDE extension for IntelliJ IDEA to help you develop code by using Tanzu Application Platform. This extension enables you to rapidly iterate on your workloads on supported Kubernetes clusters that have Tanzu Application Platform installed.

- **Tanzu Developer Tools for Visual Studio**

Tanzu Developer Tools for Visual Studio is the official VMware Tanzu IDE extension for Visual Studio to help you develop code by using Tanzu Application Platform. The Visual

Studio extension enables live updates of your application while it runs on the cluster and lets you debug your application directly on the cluster.

- **Tanzu Developer Tools for Visual Studio Code**

Tanzu Developer Tools for VS Code is the official VMware Tanzu IDE extension for VS Code to help you develop code by using Tanzu Application Platform. The VS Code extension enables live updates of your application while it runs on the cluster and lets you debug your application directly on the cluster.

- **Tekton Pipelines**

Tekton is a powerful and flexible open-source framework for creating CI/CD systems, enabling developers to build, test, and deploy across cloud providers and on-premise systems.

Installation profiles in Tanzu Application Platform v1.6

You can deploy Tanzu Application Platform through predefined profiles, each containing various packages, or you can install the packages individually. The profiles allow Tanzu Application Platform to scale across an organization's multicluster, multi-cloud, or hybrid cloud infrastructure. These profiles are not meant to cover all use cases, but serve as a starting point to allow for further customization.

The following profiles are available in Tanzu Application Platform:

- **Full** (`full`): Contains nearly all Tanzu Application Platform packages. For the exceptions to the full profile, see the packages with a check mark in the **Not in a profile** column in the table later in this section.
- **Iterate** (`iterate`): Intended for iterative application development.
- **Build** (`build`): Intended for the transformation of source revisions to workload revisions. Specifically, hosting workloads and SupplyChains.
- **Run** (`run`): Intended for the transformation of workload revisions to running pods. Specifically, hosting deliveries and deliverables.
- **View** (`view`): Intended for instances of applications related to centralized developer experiences. Specifically, Tanzu Developer Portal and Metadata Store.

The following tables list the packages contained in each profile. Packages not included in any profile are available to install as individual packages only. See the component documentation for the package for installation instructions. For a diagram showing the packages contained in each profile, see [Overview of multicluster Tanzu Application Platform](#).

Packages: A to C

Package Name	Full	Iterate	Build	Run	View	Not in a profile
API Auto Registration	✓	✓		✓		
API portal	✓				✓	
Application Accelerator	✓				✓	
Application Configuration Service						✓
Application Live View APIServer	✓	✓		✓		
Application Live View back end	✓				✓	
Application Live View connector	✓	✓		✓		

Package Name	Full	Iterate	Build	Run	View	Not in a profile
Application Live View conventions	✓	✓	✓			
Application Single Sign-On	✓	✓		✓		
Artifact Metadata Repository Observer (alpha)						✓
Bitnami Services	✓	✓		✓		
Carbon Black Scanner for SCST - Scan (beta)						✓
cert-manager	✓	✓	✓	✓	✓	
Cloud Native Runtimes	✓	✓		✓		
Contour	✓	✓	✓	✓	✓	
Crossplane	✓	✓		✓		

Packages: D to R

Package Name	Full	Iterate	Build	Run	View	Not in a profile
Default Roles	✓	✓	✓	✓		
Developer Conventions	✓	✓				
External Secrets Operator						✓
Eventing	✓	✓		✓		
Flux Source Controller	✓	✓	✓	✓	✓	
Grype Scanner for SCST - Scan	✓		✓			
Learning Center	✓				✓	
Local Source Proxy	✓	✓				
Namespace Provisioner	✓	✓	✓	✓		
Out of the Box Delivery - Basic	✓	✓		✓		
Out of the Box Supply Chain - Basic	✓	✓	✓			
Out of the Box Supply Chain - Testing	✓	✓	✓			
Out of the Box Supply Chain - Testing and Scanning	✓		✓			
Out of the Box Templates	✓	✓	✓	✓		

Packages: S to Z

Package Name	Full	Iterate	Build	Run	View	Not in a profile
Service Bindings	✓	✓		✓		
Services Toolkit	✓	✓		✓		
Source Controller	✓	✓	✓	✓	✓	
Snyk Scanner for SCST - Scan (beta)						✓
Spring Boot conventions	✓	✓	✓			
Spring Cloud Gateway						✓

Package Name	Full	Iterate	Build	Run	View	Not in a profile
Supply Chain Choreographer	✓	✓	✓	✓		
SCST - Policy Controller	✓	✓		✓		
SCST - Scan	✓		✓			
SCST - Scan 2.0 (beta)						✓
SCST - Store	✓				✓	
Tanzu Build Service	✓	✓	✓			
Tanzu Developer Portal	✓				✓	
Tekton Pipelines	✓	✓	✓			
Telemetry	✓	✓	✓	✓	✓	



Note

You can only install one supply chain at any given time. For information about switching supply chains, see [Add testing and scanning to your application](#).

Language and framework support in Tanzu Application Platform

The following table shows the languages and frameworks supported by Tanzu Application Platform components.

Language or Framework	Tanzu Build Service	Runtime Conventions	Tanzu Developer Tooling	Application Live View	Functions	Extended Scanning Coverage using Buildpack SBOM's
Java	✓	✓	✓		✓	✓
Spring Boot	✓	✓	✓	✓	✓	✓
.NET Core	✓		✓	✓		✓
Steeltoe	✓		✓	✓		
NodeJS	✓				✓	✓
Python	✓				✓	✓
golang	✓					✓
PHP	✓					✓
Ruby	✓					✓

Notes:

- **Tanzu Developer Tooling:** This refers to the developer conventions that enable debugging and Live Update function in the inner loop.
- **Extended Scanning Coverage:** When building container images with the Tanzu Build Service, the Cloud Native Build Packs used in the build process for the specified languages produce a Software Bill of Materials (SBOM). Some scan engines support the enhanced ability to use this SBOM as a source for the scan. Out of the Box Supply Chain - Testing and Scanning leverages Anchore's Grype for the image scan, which supports this capability. In

addition, users have the ability to leverage Carbon Black Container image scans, which also supports this enhanced scan coverage.

- **Spring Boot:** You must use a supported version of Spring Boot to ensure compatibility with Tanzu Application Platform components. For more information, see [Spring Boot Support](#).

Installing Tanzu Application Platform

For more information about installing Tanzu Application Platform, see [Installing Tanzu Application Platform](#).

Install Tanzu Application Platform

You can install Tanzu Application Platform (commonly known as TAP) by using one of the following methods:

- [Install Tanzu Application Platform online](#). For Tanzu Application Platform on a Kubernetes cluster with internet access.
- [Install Tanzu Application Platform in an air-gapped environment](#). For Tanzu Application Platform on a Kubernetes cluster air-gapped from external traffic.
- [Install Tanzu Application Platform with GitOps \(beta\)](#). For Tanzu Application Platform on a Kubernetes cluster via a GitOps approach.
- [Install Tanzu Application Platform in AWS](#). For installing Tanzu Application platform using AWS Cloud Services.
- [Install Tanzu Application Platform in Azure](#). For installing Tanzu Application platform using Azure Cloud Services.
- [Install Tanzu Application Platform on OpenShift](#). For Tanzu Application Platform on an OpenShift cluster with internet access.
- [Install Tanzu Application Platform with Tanzu Mission Control](#). For installing Tanzu Application platform on a managed cluster using Tanzu Mission Control.

Install Tanzu Application Platform

You can install Tanzu Application Platform (commonly known as TAP) by using one of the following methods:

- [Install Tanzu Application Platform online](#). For Tanzu Application Platform on a Kubernetes cluster with internet access.
- [Install Tanzu Application Platform in an air-gapped environment](#). For Tanzu Application Platform on a Kubernetes cluster air-gapped from external traffic.
- [Install Tanzu Application Platform with GitOps \(beta\)](#). For Tanzu Application Platform on a Kubernetes cluster via a GitOps approach.
- [Install Tanzu Application Platform in AWS](#). For installing Tanzu Application platform using AWS Cloud Services.
- [Install Tanzu Application Platform in Azure](#). For installing Tanzu Application platform using Azure Cloud Services.
- [Install Tanzu Application Platform on OpenShift](#). For Tanzu Application Platform on an OpenShift cluster with internet access.
- [Install Tanzu Application Platform with Tanzu Mission Control](#). For installing Tanzu Application platform on a managed cluster using Tanzu Mission Control.

Prerequisites for installing Tanzu Application Platform

The following are required to install Tanzu Application Platform (commonly known as TAP):

Broadcom Support Portal and container image registry requirements

Installation requires:

- Access to Broadcom Support Portal:
 - A [Broadcom Support Portal](#) account to download Tanzu Application Platform packages.
 - Network access to Broadcom registry tanzu.packages.broadcom.com.
- Cluster-specific registry:
 - A container image registry, such as [Harbor](#) or [Docker Hub](#) for application images, base images, and runtime dependencies. When available, VMware recommends using a paid registry account to avoid potential rate-limiting associated with some free registry offerings.
 - Recommended storage space for container image registry:
 - 1 GB of available storage if installing Tanzu Build Service with the `lite` set of dependencies.
 - 10 GB of available storage if installing Tanzu Build Service with the `full` set of dependencies, which are suitable for offline environments.



Note

For production environments, `full` dependencies are recommended to optimize security and performance. For more information about Tanzu Build Service dependencies, see [About lite and full dependencies](#).

- Registry credentials with read and write access available to Tanzu Application Platform to store images.
- Network access to your chosen container image registry.

DNS Records

There are some optional but recommended DNS records you must allocate if you decide to use these particular components:

- Cloud Native Runtimes (Knative): Allocate a wildcard subdomain for your developer's applications. This is specified in the `shared.ingress_domain` key of the `tap-values.yaml` configuration file that you input with the installation. This wildcard must be pointed at the external IP address of the `tanzu-system-ingress`'s `envoy` service. See [Access with the shared Ingress method](#) for more information about `tanzu-system-ingress`.
- Tanzu Learning Center: Similar to Cloud Native Runtimes, allocate a wildcard subdomain for your workshops and content. This is also specified by the `shared.ingress_domain` key of the `tap-values.yaml` configuration file that you input with the installation. This wildcard must be pointed at the external IP address of the `tanzu-system-ingress`'s `envoy` service.
- Tanzu Developer Portal (formerly named Tanzu Application Platform GUI): If you decide to implement the shared ingress and include Tanzu Developer Portal, allocate a fully Qualified Domain Name (FQDN) that can be pointed at the `tanzu-system-ingress` service. The default host name consists of `tap-gui` and the `shared.ingress_domain` value. For example, `tap-gui.example.com`.

- Supply Chain Security Tools - Store: Similar to Tanzu Developer Portal, allocate a fully Qualified Domain Name (FQDN) that can be pointed at the `tanzu-system-ingress` service. The default host name consists of `metadata-store` and the `shared.ingress_domain` value. For example, `metadata-store.example.com`.
- Application Live View: If you select the `ingressEnabled` option, allocate a corresponding fully Qualified Domain Name (FQDN) that can be pointed at the `tanzu-system-ingress` service. The default host name consists of `appliveview` and the `shared.ingress_domain` value. For example, `appliveview.example.com`.

Tanzu Developer Portal

For Tanzu Developer Portal, you must have:

- Latest version of Chrome, Firefox, or Edge. Tanzu Developer Portal currently does not support Safari browser.
- Git repository for Tanzu Developer Portal's software catalogs, with a token allowing read access. For more information about how to use your Git repository, see [Create an application accelerator](#). Supported Git infrastructure includes:
 - GitHub
 - GitLab
 - Azure DevOps
- Tanzu Developer Portal Blank Catalog from the [Broadcom Support Portal](#).
 - To install, download the file named **Tanzu Developer Portal Blank Catalog**. You must extract the catalog to the preceding Git repository of choice. This serves as the configuration location for your organization's catalog inside Tanzu Developer Portal.
- The Tanzu Developer Portal catalog allows for two approaches to store catalog information:
 - The default option uses an in-memory database and is suitable for test and development scenarios. This reads the catalog data from Git URLs that you specify in the `tap-values.yaml` file. This data is temporary. Any operations that cause the `server` pod in the `tap-gui` namespace to be re-created also cause this data to be rebuilt from the Git location. This can cause issues when you manually register entities by using the UI, because they only exist in the database and are lost when that in-memory database gets rebuilt.
 - For production use cases, use a PostgreSQL database that exists outside the Tanzu Application Platform packaging. The PostgreSQL database stores all the catalog data persistently both from the Git locations and the UI manual entity registrations. For more information, see [Configure the Tanzu Developer Portal database](#)

Kubernetes cluster requirements

Installation requires Kubernetes cluster v1.25, v1.26 or v1.27 on one of the following Kubernetes providers:

- Azure Kubernetes Service.
- Amazon Elastic Kubernetes Service.
 - containerd must be used as the Container Runtime Interface (CRI). Some versions of EKS default to Docker as the container runtime and must be changed to containerd.
 - EKS clusters on Kubernetes version 1.23 and above require the [Amazon EBS CSI Driver](#) due to [CSIMigrationAWS](#) is enabled by default in Kubernetes version 1.23 and

above.

- Users currently on EKS Kubernetes version 1.22 must install the Amazon EBS CSI Driver before upgrading to Kubernetes version 1.23 and above. See [AWS documentation](#) for more information.
 - AWS Fargate is not supported.
- Google Kubernetes Engine.
 - GKE Autopilot clusters do not have the required features enabled.
 - GKE clusters that are set up in zonal mode might detect Kubernetes API errors when the GKE control plane is resized after traffic increases. Users can mitigate this by creating a regional cluster with three control-plane nodes right from the start.
- Minikube.
 - Reference the [resource requirements](#) in the following section.
 - Hyperkit driver is supported on macOS only. Docker driver is not supported.
- Red Hat OpenShift Container Platform v4.12 or v4.13.
 - vSphere
 - Baremetal
- Tanzu Kubernetes Grid (commonly called TKG) with Standalone Management Cluster. For more information, see the [Tanzu Kubernetes Grid documentation](#).
- vSphere with Tanzu v8.0.1c or later and Tanzu Application Platform v1.6.2 or later.
 - For vSphere with Tanzu, you must configure the pod security policies so the Tanzu Application Platform controller pods can run as root. For more information, see the [Kubernetes documentation](#).

To set the pod security policies, run:

```
kubectl create clusterrolebinding default-tkg-admin-privileged-binding --
clusterrole=psp:vmware-system-privileged --group=system:authenticated
```

For more information about the pod security policies on Tanzu for vSphere, see the [VMware vSphere documentation](#).

For more information about the supported Kubernetes versions, see [Kubernetes version support for Tanzu Application Platform](#).

Resource requirements

- To deploy Tanzu Application Platform packages iterate profile on local Minikube cluster, your cluster must have at least:
 - 8 vCPUs for i9 (or equivalent) available to Tanzu Application Platform components on Mac OS.
 - 12 vCPUs for i7 (or equivalent) available to Tanzu Application Platform components on Mac OS.
 - 8 vCPUs available to Tanzu Application Platform components on Linux and Windows.
 - 12 GB of RAM available to Tanzu Application Platform components on Mac OS, Linux and Windows.
 - 70 GB of disk space available per node.
- To deploy Tanzu Application Platform packages full profile, your cluster must have at least:

- 8 GB of RAM available per node to Tanzu Application Platform.
- 16 vCPUs available across all nodes to Tanzu Application Platform.
- 100 GB of disk space available per node.



Important

Tanzu Application Platform requires a minimum of 120 GB per node of ephemeral storage. If you do not allocate at least this amount of ephemeral storage for kubelet on all cluster nodes, you receive the error `minDiskPerNode: some cluster nodes don't meet minimum disk space requirement of '100Gi'`. For more information about configuring the storage for a TKG cluster on Supervisor, see [v1alpha3 Example: TKC with Default Storage and Node Volumes](#) and [v1beta1 Example: Custom Cluster Based on the Default ClusterClass](#).

- To deploy Tanzu Application Platform packages build, run and iterate (shared) profile, your cluster must have at least:
 - 8 GB of RAM available per node to Tanzu Application Platform.
 - 12 vCPUs available across all nodes to Tanzu Application Platform.
 - 100 GB of disk space available per node.
- To deploy Tanzu Application Platform packages view profile, your cluster must have at least:
 - 8 GB of RAM available per node to Tanzu Application Platform.
 - 8 vCPUs available across all nodes to Tanzu Application Platform.
 - 100 GB of disk space available per node.
- For the [full profile](#) or use of Security Chain Security Tools - Store, your cluster must have a configured default StorageClass.
- Pod security policies must be configured so that Tanzu Application Platform controller pods can run as root in the following optional configurations:
 - Tanzu Build Service, in which CustomStacks require root privileges. For more information, see [Tanzu Build Service documentation](#).
 - Supply Chain, in which Kaniko usage requires root privileges to build containers.
 - Tanzu Learning Center, which requires root privileges.

For more information about pod security policies, see [Kubernetes documentation](#).

Tools and CLI requirements

Installation requires:

- The Kubernetes CLI (kubectl) v1.25, v1.26 or v1.27 installed and authenticated with admin rights for your target cluster. See [Install Tools](#) in the Kubernetes documentation.

Next steps

- [Install the Tanzu CLI](#)

Kubernetes version support for Tanzu Application Platform

The following is a matrix table providing details of the compatible Kubernetes cluster versions for Tanzu Application Platform v1.6.

Kubernetes Cluster	Support Information	Notes
Kubernetes	v1.25, v1.26, v1.27	
VMware Tanzu Kubernetes Grid	v2.4.0, v2.3.0, v2.2.0	Support for Tanzu Kubernetes Grid v2.4.x begins with Tanzu Application Platform v1.6.4 Support for Tanzu Kubernetes Grid v2.3.x begins with Tanzu Application Platform v1.6.2
Tanzu Kubernetes releases (vSphere with Tanzu)	TKr v1.25.7 for vSphere v8.x	Support for TKr v1.25.7 begins with Tanzu Application Platform v1.6.2
OpenShift	v4.12, v4.13	
Azure Kubernetes Service	Supported	
Elastic Kubernetes Service	Supported	
Google Kubernetes Engine	Supported	

Install the Tanzu CLI

This topic tells you how to install the Tanzu CLI and plug-ins on Tanzu Application Platform (commonly known as TAP).

Set the Kubernetes cluster context

For information about the supported Kubernetes cluster providers and versions, see [Kubernetes cluster requirements](#).

To set the Kubernetes cluster context:

1. List the existing contexts by running:

```
kubectl config get-contexts
```

For example:

```
$ kubectl config get-contexts
CURRENT   NAME                                CLUSTER           AUTHINFO
NAMESPACE
          aks-repo-trial                      aks-repo-trial    clusterUser_aks-r
g-01_aks-repo-trial
*         aks-tap-cluster                     aks-tap-cluster   clusterUser_aks-r
g-01_aks-tap-cluster
```

2. If you are managing multiple cluster contexts, set the context to the cluster that you want to use for the Tanzu Application Platform packages installation by running:

```
kubectl config use-context CONTEXT
```

Where `CONTEXT` is the cluster that you want to use. For example, `aks-tap-cluster`.

For example:

```
$ kubectl config use-context aks-tap-cluster
Switched to context "aks-tap-cluster".
```

Install or update the Tanzu CLI and plug-ins

The Tanzu CLI and plug-ins enable you to install and use the Tanzu Application Platform functions and features.

Install the Tanzu CLI

The Tanzu CLI core v1.0.0 distributed with Tanzu Application Platform is forward and backward compatible with all supported releases of Tanzu Application Platform.

Run a single command to install the plug-in group version that matches the Tanzu Application Platform version on any target environment. For more information, see [Install Tanzu CLI Plug-ins](#).

Use a package manager to install Tanzu CLI on Windows, Mac, or Linux OS. Alternatively, download and install manually from [Broadcom Support Portal](#) or [GitHub](#).

Basic installation instructions are provided below. For more information including how to install the Tanzu CLI and CLI plug-ins in Internet-restricted environments, see the [VMware Tanzu CLI](#) documentation.



Note

To retain an existing installation of the Tanzu CLI, move the CLI binary from `/usr/local/bin/tanzu` or `C:\Program Files\tanzu` on Windows to a different location before following the steps below.

Install using a package manager

To install the Tanzu CLI using a package manager:

1. Follow the instructions for your package manager below. This installs the latest version of the CLI available in the package registry.

- o **Homebrew (MacOS):**

```
brew update
brew install vmware-tanzu/tanzu/tanzu-cli
```

- o **Chocolatey (Windows):**

```
choco install tanzu-cli
```

The `tanzu-cli` package is part of the main [Chocolatey Community Repository](#). When a new `tanzu-cli` version is released, it might not be available immediately. If the above command fails, run:

```
choco install tanzu-cli --version TANZU-CLI-VERSION
```

Where `TANZU-CLI-VERSION` is the Tanzu CLI version you want to install.

For example:

```
choco install tanzu-cli --version 1.3.0
```

- o **APT (Debian or Ubuntu):**

```
sudo mkdir -p /etc/apt/keyrings/
sudo apt-get update
sudo apt-get install -y ca-certificates curl gpg
```

```
curl -fsSL https://packages.vmware.com/tools/keys/VMWARE-PACKAGING-GPG-RSA-KEY.pub | sudo gpg --dearmor -o /etc/apt/keyrings/tanzu-archive-keyring.gpg
echo "deb [arch=amd64 signed-by=/etc/apt/keyrings/tanzu-archive-keyring.gpg] https://storage.googleapis.com/tanzu-cli-os-packages/apt tanzu-cli-jessie main" | sudo tee /etc/apt/sources.list.d/tanzu.list
sudo apt-get update
sudo apt-get install -y tanzu-cli
```

- o **YUM or DNF (RHEL):**

```
cat << EOF | sudo tee /etc/yum.repos.d/tanzu-cli.repo
[tanzu-cli]
name=Tanzu CLI
baseurl=https://storage.googleapis.com/tanzu-cli-os-packages/rpm/tanzu-cli
enabled=1
gpgcheck=1
repo_gpgcheck=1
gpgkey=https://packages.vmware.com/tools/keys/VMWARE-PACKAGING-GPG-RSA-KEY.pub
EOF

sudo yum install -y tanzu-cli # If you are using DNF, run sudo dnf install -y tanzu-cli.
```

2. Check that the correct version of the CLI is properly installed.

```
tanzu version
version: v1.3.0
...
```

Install from a binary release

Complete the following steps:

1. Download the Tanzu CLI binary from one of the following locations:

- o **Broadcom Support Portal:**

1. Go to the [Broadcom Support Portal](#), expand the **VMware Tanzu Application Platform** dropdown, and click the 1.6.13 release.
2. If you have not done so already, select the **I agree to Terms and Conditions** check box.
3. Download the tanzu-core-cli binary. Choose from **tanzu-core-cli-linux**, **tanzu-core-cli-mac**, or **tanzu-core-cli-windows**.
4. Download the Tanzu CLI binary for your operating system.

- o **GitHub:**

1. Go to [Tanzu CLI release v1.3.0 on GitHub](#).
2. Download the Tanzu CLI binary for your operating system, for example, [tanzu-cli-windows-amd64.tar.gz](#).

2. Use an extraction tool to unpack the binary file:

- o **macOS:**

```
tar -xvf tanzu-cli-darwin-amd64.tar.gz
```

- o **Linux:**

```
tar -xvf tanzu-cli-linux-amd64.tar.gz
```

- **Windows:**

Use the Windows extractor tool to unzip `tanzu-cli-windows-amd64.zip`.

3. Make the CLI available to the system. `cd` to the directory containing the extracted CLI binary then install the binary:

- **macOS:**

Install the binary to `/usr/local/bin`:

```
install tanzu-cli-darwin_amd64 /usr/local/bin/tanzu
```

- **Linux:**

Install the binary to `/usr/local/bin`:

```
sudo install tanzu-cli-linux_amd64 /usr/local/bin/tanzu
```

- **Windows:**

1. Create a new `Program Files\tanzu` folder.
2. Copy the `tanzu-cli-windows_amd64.exe` file into the new `Program Files\tanzu` folder.
3. Rename `tanzu-cli-windows_amd64.exe` to `tanzu.exe`.
4. Right-click the `tanzu` folder, select **Properties > Security**, and make sure that your user account has the **Full Control** permission.
5. Use Windows Search to search for `env`.
6. Select **Edit the system environment variables** and click the **Environment Variables** button.
7. Select the `Path` row under **System variables**, and click **Edit**.
8. Click **New** to add a new row and enter the path to the Tanzu CLI. The path value must not include the `.exe` extension. For example, `C:\Program Files\tanzu`.

4. Check that the correct version of the CLI is properly installed:

```
tanzu version
version: v1.3.0
...
```

Install Tanzu CLI Plug-ins

There is a group of Tanzu CLI plug-ins which extend the Tanzu CLI Core with Tanzu Application Platform specific functionality. The plug-ins can be installed as a group with a single command.

Versioned releases of the Tanzu Application Platform specific plug-in group align to each supported Tanzu Application Platform version.

This makes it easy to switch between different versions of Tanzu Application Platforms environments.

Use the following commands to search for, install, and verify Tanzu CLI plug-in groups.

List the versions of each plug-in group available across Tanzu

```
tanzu plugin group search --show-details
```

List the versions of the Tanzu Application Platform specific plug-in group

```
tanzu plugin group search --name vmware-tanzu/default --show-details
```

Install the version of the Tanzu Application Platform specific plug-in group matching your target environment

```
tanzu plugin install --group vmware-tap/default:v1.6.13
```

Verify the plug-in group list against the plug-ins that were installed

```
tanzu plugin group get vmware-tap/default:v1.6.13
```

```
tanzu plugin list
```

For air-gapped installation, see the [Installing the Tanzu CLI in Internet-Restricted Environments](#) section of the Tanzu CLI documentation.

Next steps

For online installation:

- [Deploy Cluster Essentials*](#)
- [Install Tanzu Application Platform package and profiles](#)

For air-gapped installation:

- [Deploy Cluster Essentials*](#)
- [Install Tanzu Application Platform in your air-gapped environment](#)

For installation on AWS Cloud:

- [Create AWS Resources for Tanzu Application Platform](#)
- [Deploy Cluster Essentials*](#)
- [Install Tanzu Application Platform package and profiles on AWS](#)

For installation on Azure Cloud:

- [Create Azure Resources for Tanzu Application Platform](#)
- [Deploy Cluster Essentials*](#)
- [Install Tanzu Application Platform package and profiles on Azure](#)

For installation on OpenShift clusters:

- [Deploy Cluster Essentials*](#)
- [Install the Tanzu Application Platform package and profiles](#)

For GitOps (beta) installation:

- [Deploy Cluster Essentials*](#)
- [Install Tanzu Application Platform through GitOps with External Secrets Operator \(ESO\)](#)
- [Install Tanzu Application Platform through Gitops with Secrets OPERATIONs \(SOPS\)](#)

* When you use a VMware Tanzu Kubernetes Grid cluster, you do not need to install Cluster Essentials because the contents of Cluster Essentials are already installed on your cluster.

Install Tanzu Application Platform (online)

To install Tanzu Application Platform (commonly known as TAP) on your Kubernetes clusters with internet access:

Step	Task	Link
1.	Review the prerequisites to ensure you have met all requirements before installing.	Prerequisites
2.	Install the Tanzu CLI.	Install the Tanzu CLI
3.	Install Cluster Essentials for Tanzu*.	Deploy Cluster Essentials
4.	Add the Tanzu Application Platform package repository, prepare your Tanzu Application Platform profile, and install the profile to the cluster.	Install the Tanzu Application Platform package and profiles
5.	(Optional) Install any additional packages that were not in the profile.	Install individual packages
6.	Set up developer namespaces to use your installed packages.	Set up developer namespaces to use your installed packages
7.	Install developer tools into your integrated development environment (IDE).	Install Tanzu Developer Tools for your VS Code

* When you use a VMware Tanzu Kubernetes Grid cluster, there is no need to install Cluster Essentials because the contents of Cluster Essentials are already installed on your cluster.

After installing Tanzu Application Platform on to your Kubernetes clusters, proceed with [Get started with Tanzu Application Platform](#).

Install Tanzu Application Platform (online)

To install Tanzu Application Platform (commonly known as TAP) on your Kubernetes clusters with internet access:

Step	Task	Link
1.	Review the prerequisites to ensure you have met all requirements before installing.	Prerequisites
2.	Install the Tanzu CLI.	Install the Tanzu CLI
3.	Install Cluster Essentials for Tanzu*.	Deploy Cluster Essentials
4.	Add the Tanzu Application Platform package repository, prepare your Tanzu Application Platform profile, and install the profile to the cluster.	Install the Tanzu Application Platform package and profiles
5.	(Optional) Install any additional packages that were not in the profile.	Install individual packages
6.	Set up developer namespaces to use your installed packages.	Set up developer namespaces to use your installed packages
7.	Install developer tools into your integrated development environment (IDE).	Install Tanzu Developer Tools for your VS Code

* When you use a VMware Tanzu Kubernetes Grid cluster, there is no need to install Cluster Essentials because the contents of Cluster Essentials are already installed on your cluster.

After installing Tanzu Application Platform on to your Kubernetes clusters, proceed with [Get started with Tanzu Application Platform](#).

Install Tanzu Application Platform package and profiles

This topic tells you how to install Tanzu Application Platform (commonly known as TAP) packages from your Tanzu Application Platform package repository.

Before installing the packages, ensure you have:

- Completed the [Prerequisites](#).
- Configured and verified the cluster.
- Installed [Tanzu CLI](#) with any required plug-ins.

Relocate images to a registry

Before installation, you must relocate the Tanzu Application Platform images from tanzu.packages.broadcom.com to your own container image registry.

The supported registries are Harbor, Azure Container Registry, Google Container Registry, and Quay.io. See the following documentation to learn how to set up your container image registry:

- [Harbor documentation](#)
- [Google Container Registry documentation](#)
- [Quay.io documentation](#)

To relocate images from tanzu.packages.broadcom.com to your registry:

1. Retrieve your Broadcom registry API token:
 1. Sign in to the [Broadcom Support Portal](#).
 2. Go to [Tanzu Application Platform \(TAP\)](#) and expand the **VMware Tanzu Application Platform** dropdown.
 3. Click the Token Download icon next to the Tanzu Application Platform version you want to download.

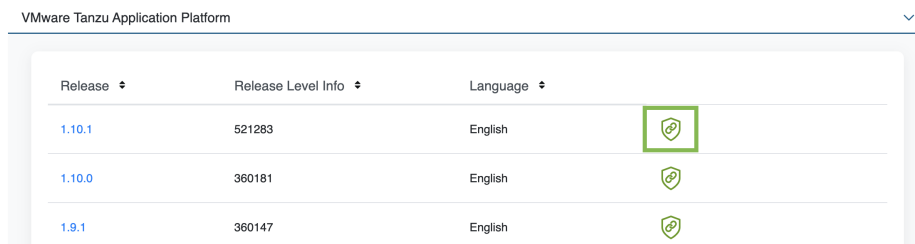

4. Follow the instructions in the dialog box. Save the token as a variable named `MY_BROADCOM_SUPPORT_ACCESS_TOKEN`. For example:

```
export MY_BROADCOM_SUPPORT_ACCESS_TOKEN=API-TOKEN
```

Where `API-TOKEN` is your token from the Broadcom Support Portal.

2. Set up the environment variables required for installation by running:

```
# Set tanzu.packages.broadcom.com as the source registry to copy the Tanzu Appl
ication Platform packages from.
export IMGPKG_REGISTRY_HOSTNAME_0=tanzu.packages.broadcom.com
export IMGPKG_REGISTRY_USERNAME_0=MY-BROADCOM-SUPPORT-USERNAME
export IMGPKG_REGISTRY_PASSWORD_0=${MY_BROADCOM_SUPPORT_ACCESS_TOKEN}

# The user's registry for copying the Tanzu Application Platform package to.
export IMGPKG_REGISTRY_HOSTNAME_1=MY-REGISTRY
```

```

export IMGPKG_REGISTRY_USERNAME_1=MY-REGISTRY-USER
export IMGPKG_REGISTRY_PASSWORD_1=MY-REGISTRY-PASSWORD
# These environment variables starting with IMGPKG_* are used by the imgpkg com
mand only.

# The registry from which the Tanzu Application Platform package is retrieved.
export INSTALL_REGISTRY_USERNAME="${IMGPKG_REGISTRY_USERNAME_1}"
export INSTALL_REGISTRY_PASSWORD="${IMGPKG_REGISTRY_PASSWORD_1}"
export INSTALL_REGISTRY_HOSTNAME="${IMGPKG_REGISTRY_HOSTNAME_1}"
export TAP_VERSION=VERSION-NUMBER
export INSTALL_REPO=TARGET-REPOSITORY

# The user's registry used by Tanzu Application Platform to store built images
and the Tanzu Build Service dependencies. These credentials must have write per
mission.
export MY_REGISTRY_USERNAME="${IMGPKG_REGISTRY_USERNAME_1}"
export MY_REGISTRY_PASSWORD="${IMGPKG_REGISTRY_PASSWORD_1}"
export MY_REGISTRY_HOSTNAME="${IMGPKG_REGISTRY_HOSTNAME_1}"

```

Where:

- o `MY-BROADCOM-SUPPORT-USERNAME` is the user with access to the images in `tanzu.packages.broadcom.com`.
- o `MY-REGISTRY` is your own container registry.
- o `MY-REGISTRY-USER` is the user with write access to `MY-REGISTRY`.
- o `MY-REGISTRY-PASSWORD` is the password for `MY-REGISTRY-USER`.
- o `VERSION-NUMBER` is your Tanzu Application Platform version. For example, `1.6.13`.
- o `TARGET-REPOSITORY` is your target repository. This is a folder or repository on `MY-REGISTRY` that serves as the location for the Tanzu Application Platform installation files.

VMware recommends using a JSON key file to authenticate with Google Container Registry. In this case, the value of `INSTALL_REGISTRY_USERNAME` is `_json_key` and the value of `INSTALL_REGISTRY_PASSWORD` is the content of the JSON key file. For more information about how to generate the JSON key file, see [Google Container Registry documentation](#).

3. Install the Carvel tool `imgpkg` CLI.

To query for the available versions of Tanzu Application Platform on `tanzu.packages.broadcom.com`, run:

```
imgpkg tag list -i tanzu.packages.broadcom.com/tanzu-application-platform/tap-p
ackages | sort -V
```

4. Relocate the images with the `imgpkg` CLI by running:

```
imgpkg copy -b tanzu.packages.broadcom.com/tanzu-application-platform/tap-packa
ges:${TAP_VERSION} --to-repo ${INSTALL_REGISTRY_HOSTNAME}/${INSTALL_REPO}/tap-p
ackages
```

Add the Tanzu Application Platform package repository

Tanzu CLI packages are available through repositories. Adding the Tanzu Application Platform package repository makes Tanzu Application Platform and its packages available for installation.

```

# The user's registry used by Tanzu Application Platform to store built images and the
Tanzu Build Service dependencies. These credentials must have write permission.
export MY_REGISTRY_USERNAME=MY-REGISTRY-USERNAME

```

```
export MY_REGISTRY_PASSWORD=MY-REGISTRY-PASSWORD
export MY_REGISTRY_HOSTNAME=MY-REGISTRY
```

Where:

- `MY-REGISTRY-USERNAME` is the user with write access to your container registry.
- `MY-REGISTRY-PASSWORD` is the password for `MY-REGISTRY-USERNAME`.
- `MY-REGISTRY` is your own container registry.

To add the Tanzu Application Platform package repository to your cluster:

1. Create a namespace called `tap-install` for deploying any component packages by running:

```
kubectl create ns tap-install
```

This namespace keeps the objects grouped together logically.

2. Create a registry secret by running:

```
tanzu secret registry add tap-registry \
  --username ${INSTALL_REGISTRY_USERNAME} --password ${INSTALL_REGISTRY_PASSWORD} \
  \
  --server ${INSTALL_REGISTRY_HOSTNAME} \
  --export-to-all-namespaces --yes --namespace tap-install
```

3. Create a secret for accessing the user's registry by running:

```
tanzu secret registry add registry-credentials \
  --server ${MY_REGISTRY_HOSTNAME} \
  --username ${MY_REGISTRY_USERNAME} \
  --password ${MY_REGISTRY_PASSWORD} \
  --namespace tap-install \
  --export-to-all-namespaces \
  --yes
```

4. Add the Tanzu Application Platform package repository to the cluster by running:

```
tanzu package repository add tanzu-tap-repository \
  --url ${INSTALL_REGISTRY_HOSTNAME}/${INSTALL_REPO}/tap-packages:$TAP_VERSION \
  --namespace tap-install
```

5. Get the status of the Tanzu Application Platform package repository, and ensure the status updates to `Reconcile succeeded` by running:

```
tanzu package repository get tanzu-tap-repository --namespace tap-install
```

For example:

```
$ tanzu package repository get tanzu-tap-repository --namespace tap-install
- Retrieving repository tap...
NAME:          tanzu-tap-repository
VERSION:       16253001
REPOSITORY:    tapmdc.azurecr.io/mdc/1.4.0/tap-packages
TAG:           1.6.13
STATUS:        Reconcile succeeded
REASON:
```



Note

The **VERSION** and **TAG** numbers differ from the earlier example if you are on Tanzu Application Platform v1.0.2 or earlier.

6. List the available packages by running:

```
tanzu package available list --namespace tap-install
```

For example:

```
$ tanzu package available list --namespace tap-install
/ Retrieving available packages...
NAME                                DISPLAY-NAME
SHORT-DESCRIPTION
  accelerator.apps.tanzu.vmware.com  Application Accelerator
for VMware Tanzu                    Used to create new projects a
nd configurations.
  api-portal.tanzu.vmware.com        API portal
A unified user interface for API discovery and exploration at scale.
  apis.apps.tanzu.vmware.com        API Auto Registration fo
r VMware Tanzu                      A TAP component to automatica
lly register API exposing workloads as API entities
in TAP GUI.
  backend.appliveview.tanzu.vmware.com  Application Live View fo
r VMware Tanzu                      App for monitoring and troubl
eshooting running apps
  buildservice.tanzu.vmware.com        Tanzu Build Service
Tanzu Build Service enables the building and automation of containerized
software workflows securely and at scale.
  carbonblack.scanning.apps.tanzu.vmware.com  VMware Carbon Black for
Supply Chain Security Tools - Scan  Default scan templates using
VMware Carbon Black
  cartographer.tanzu.vmware.com        Cartographer
Kubernetes native Supply Chain Choreographer.
  cnrs.tanzu.vmware.com                Cloud Native Runtimes
Cloud Native Runtimes is a serverless runtime based on Knative
  connector.appliveview.tanzu.vmware.com  Application Live View Co
nconnector for VMware Tanzu          App for discovering and regis
tering running apps
  controller.source.apps.tanzu.vmware.com  Tanzu Source Controller
Tanzu Source Controller enables workload create/update from source code.
  conventions.appliveview.tanzu.vmware.com  Application Live View Co
nventions for VMware Tanzu          Application Live View convent
ion server
  developer-conventions.tanzu.vmware.com  Tanzu App Platform Devel
oper Conventions                    Developer Conventions
  eventing.tanzu.vmware.com            Eventing
Eventing is an event-driven architecture platform based on Knative Eventing
  external-secrets.apps.tanzu.vmware.com  External Secrets Operato
r                                      External Secrets Operator is
a Kubernetes operator that integrates external
secret management systems.
  fluxcd.source.controller.tanzu.vmware.com  Flux Source Controller
The source-controller is a Kubernetes operator, specialised in artifacts
acquisition from external sources such as Git, Helm repositories and S3 bucket
s.
  grype.scanning.apps.tanzu.vmware.com  Grype for Supply Chain S
ecurity Tools - Scan                 Default scan templates using
Anchore Grype
  learningcenter.tanzu.vmware.com        Learning Center for Tanz
u Application Platform                Guided technical workshops
```

metadata-store.apps.tanzu.vmware.com ols - Store e, package, and vulnerability metadata.	Supply Chain Security To Post SBOMs and query for imag
namespace-provisioner.apps.tanzu.vmware.com Automatic Provisioning of Developer Namespaces.	Namespace Provisioner
ootb-delivery-basic.tanzu.vmware.com f The Box Delivery Basic c.	Tanzu App Platform Out o Out of The Box Delivery Basi
ootb-supply-chain-basic.tanzu.vmware.com f The Box Supply Chain Basic asic.	Tanzu App Platform Out o Out of The Box Supply Chain B
ootb-supply-chain-testing-scanning.tanzu.vmware.com f The Box Supply Chain with Testing and Scanning ith Testing and Scanning.	Tanzu App Platform Out o Out of The Box Supply Chain w
ootb-supply-chain-testing.tanzu.vmware.com f The Box Supply Chain with Testing ith Testing.	Tanzu App Platform Out o Out of The Box Supply Chain w
ootb-templates.tanzu.vmware.com f The Box Templates	Tanzu App Platform Out o Out of The Box Templates.
policy.apps.tanzu.vmware.com ols - Policy Controller ining of a policy to restrict unsigned container images.	Supply Chain Security To Policy Controller enables def
scanning.apps.tanzu.vmware.com ols - Scan enforce policies directly within Kubernetes native	Supply Chain Security To Scan for vulnerabilities and
Supply Chains.	
service-bindings.labs.vmware.com ernetes es implements the Service Binding Specification.	Service Bindings for Kub Service Bindings for Kubernet
services-toolkit.tanzu.vmware.com The Services Toolkit enables the management, lifecycle, discoverability and connectivity of Service Resources (databases, message queues, DNS records, etc.).	Services Toolkit
snyk.scanning.apps.tanzu.vmware.com curity Tools - Scan Snyk	Snyk for Supply Chain Se Default scan templates using
spring-boot-conventions.tanzu.vmware.com tions Server n server.	Tanzu Spring Boot Conven Default Spring Boot conventio
sso.apps.tanzu.vmware.com Application Single Sign-On for Tanzu	AppSSO
tap-auth.tanzu.vmware.com Application Platform Application Platform	Default roles for Tanzu Default roles for Tanzu Appli
tap-gui.tanzu.vmware.com rm GUI ace for Tanzu Application Platform	Tanzu Application Platfo web app graphical user interf
tap-telemetry.tanzu.vmware.com Tanzu Application Platform lemetry	Telemetry Collector for Tanzu Application Platform Te
tap.tanzu.vmware.com rm AP components to get you started based on your use case.	Tanzu Application Platfo Package to install a set of T
tekton.tanzu.vmware.com Tekton Pipelines is a framework for creating CI/CD systems.	Tekton Pipelines
workshops.learningcenter.tanzu.vmware.com al	Workshop Building Tutori Workshop Building Tutorial

Install your Tanzu Application Platform profile

The `tap.tanzu.vmware.com` package installs predefined sets of packages based on your profile settings. This is done by using the package manager installed by Tanzu Cluster Essentials.

For more information about profiles, see [Components and installation profiles](#).

To prepare to install a profile:

1. List version information for the package by running:

```
tanzu package available list tap.tanzu.vmware.com --namespace tap-install
```

2. Create a `tap-values.yaml` file by using the [Full Profile sample](#) in the following section as a guide. These samples have the minimum configuration required to deploy Tanzu Application Platform. The sample values file contains the necessary defaults for:
 - o The meta-package, or parent Tanzu Application Platform package.
 - o Subordinate packages, or individual child packages.

Keep the values file for future configuration use.



Note

`tap-values.yaml` is set as a Kubernetes secret, which provides secure means to read credentials for Tanzu Application Platform components.

3. [View possible configuration settings for your package](#)

Full profile

The following is the YAML file sample for the full-profile. The `profile:` field takes `full` as the default value, but you can also set it to `iterate`, `build`, `run` or `view`. Refer to [Install multicluster Tanzu Application Platform profiles](#) for more information.

```
shared:
  ingress_domain: "INGRESS-DOMAIN"
  ingress_issuer: # Optional, can denote a cert-manager.io/v1/ClusterIssuer of your choice. Defaults to "tap-ingress-selfsigned".

  image_registry:
    project_path: "SERVER-NAME/REPO-NAME"
    secret:
      name: "KP-DEFAULT-REPO-SECRET"
      namespace: "KP-DEFAULT-REPO-SECRET-NAMESPACE"

  kubernetes_distribution: "K8S-DISTRO" # Only required if the distribution is OpenShift and must be used with the following kubernetes_version key.

  kubernetes_version: "K8S-VERSION" # Required regardless of distribution when Kubernetes version is 1.25 or later.

  ca_cert_data: | # To be passed if using custom certificates.
    -----BEGIN CERTIFICATE-----
    MIIFFzCCA0egAwIBAgIJAJYm37SFocjlMA0GCSqGSIb3DQEjBDDQUAMEY...
    -----END CERTIFICATE-----

  ceip_policy_disclosed: FALSE-OR-TRUE-VALUE # Installation fails if this is not set to true. Not a string.

#The above keys are minimum numbers of entries needed in tap-values.yaml to get a func
```



```

tioning TAP Full profile installation.

#Below are the keys which may have default values set, but can be overridden.

profile: full # Can take iterate, build, run, view.

supply_chain: basic # Can take testing, testing_scanning.

ootb_supply_chain_basic: # Based on supply_chain set above, can be changed to ootb_s
upply_chain_testing, ootb_supply_chain_testing_scanning.
  registry:
    server: "SERVER-NAME" # Takes the value from the shared section by default, but ca
n be overridden by setting a different value.
    repository: "REPO-NAME" # Takes the value from the shared section by default, but
can be overridden by setting a different value.
  gitops:
    ssh_secret: "SSH-SECRET-KEY" # Takes "" as value by default; but can be overridden
by setting a different value.

contour:
  envoy:
    service:
      type: LoadBalancer # This is set by default, but can be overridden by setting a
different value.

buildservice:
  # Takes the value from the shared section by default, but can be overridden by setti
ng a different value.
  kp_default_repository: "KP-DEFAULT-REPO"
  kp_default_repository_secret: # Takes the value from the shared section above by def
ault, but can be overridden by setting a different value.
  name: "KP-DEFAULT-REPO-SECRET"
  namespace: "KP-DEFAULT-REPO-SECRET-NAMESPACE"

local_source_proxy:
  # Takes the value from the project_path under the image_registry section of shared b
y default, but can be overridden by setting a different value.
  repository: "EXTERNAL-REGISTRY-FOR-LOCAL-SOURCE"
  push_secret:
    # When set to true, the secret mentioned in this section is automatically exported
to Local Source Proxy's namespace.
    name: "EXTERNAL-REGISTRY-FOR-LOCAL-SOURCE-SECRET"
    namespace: "EXTERNAL-REGISTRY-FOR-LOCAL-SOURCE-SECRET-NAMESPACE"
    # When set to true, the secret mentioned in this section is automatically exported
to Local Source Proxy's namespace.
    create_export: true

tap_gui:
  metadataStoreAutoconfiguration: true # Creates a service account, the Kubernetes con
trol plane token and the requisite app_config block to enable communications between T
anzu Developer Portal and SCST - Store.
  app_config:
    auth:
      allowGuestAccess: true # This allows unauthenticated users to log in to your po
rtal. If you want to deactivate it, make sure you configure an alternative auth provid
er.
    catalog:
      locations:
        - type: url
          target: https://GIT-CATALOG-URL/catalog-info.yaml

metadata_store:
  ns_for_export_app_cert: "MY-DEV-NAMESPACE" # Verify this namespace is available with
in your cluster before initiating the Tanzu Application Platform installation.
  app_service_type: ClusterIP # Defaults to LoadBalancer. If shared.ingress_domain is
set earlier, this must be set to ClusterIP.

```

```

scanning:
  metadataStore:
    # In a single cluster, the connection between the scanning pod and the metadata store happens inside the cluster and does not pass through ingress. This is automatically configured, you do not need to provide an ingress connection to the store.
    url: "" # Configuration is moved, so set this string to empty.

policy:
  tuf_enabled: false # By default, TUF initialization and keyless verification are deactivated.
tap_telemetry:
  customer_entitlement_account_number: "CUSTOMER-ENTITLEMENT-ACCOUNT-NUMBER" # (Optional) Identify data for creating the Tanzu Application Platform usage reports.

```



Important

The profile installation no longer includes Grype out of the box. Instead, you can use Namespace Provisioner to install Grype. Namespace Provisioner still uses Grype values to configure the scanner:

```

grype:
  namespace: "MY-DEV-NAMESPACE"
  targetImagePullSecret: "TARGET-REGISTRY-CREDENTIALS-SECRET"

```

Where:

- `INGRESS-DOMAIN` is the subdomain for the host name that you point at the `tanzu-shared-ingress` service's External IP address. It is not required to know the External IP address or set up the DNS record while installing. Installing the Tanzu Application Platform package creates the `tanzu-shared-ingress` and its External IP address. You can create the DNS record after completing the installation.
- `KP-DEFAULT-REPO` is a writable repository in your registry. Tanzu Build Service dependencies are written to this location. Examples:
 - Harbor has the form `kp_default_repository: "my-harbor.io/my-project/build-service"`.
 - Docker Hub has the form `kp_default_repository: "my-dockerhub-user/build-service"` or `kp_default_repository: "index.docker.io/my-user/build-service"`.
 - Google Cloud Registry has the form `kp_default_repository: "gcr.io/my-project/build-service"`.
- `KP-DEFAULT-REPO-SECRET` is the secret with user credentials that can write to `KP-DEFAULT-REPO`. You can `docker push` to this location with this credential.
 - You can create a secret configured with a valid registry credential with a name and namespace of your choice. For Google Cloud Registry, use `kp_default_repository_username: _json_key`.
 - You must create the secret before the installation. For example, you can use the `registry-credentials` secret created earlier.
- `KP-DEFAULT-REPO-SECRET-NAMESPACE` is the namespace where `KP-DEFAULT-REPO-SECRET` is created.
 - You must create the namespace before the installation. For example, you can use the `tap-install` namespace created earlier.

- `K8S-DISTRO` (optional) is the type of Kubernetes infrastructure in use. It is only required if the distribution is OpenShift and must be used in coordination with `kubernetes_version`. Supported value: `openshift`.
- `K8S-VERSION` (optional) is the Kubernetes version in use. You can use it independently or in coordination with `kubernetes_distribution`. For example, `1.24.x`, where `x` is the Kubernetes patch version.
- `SERVER-NAME` is the host name of the registry server. Examples:
 - Harbor has the form `server: "my-harbor.io"`.
 - Docker Hub has the form `server: "index.docker.io"`.
 - Google Cloud Registry has the form `server: "gcr.io"`.
- `REPO-NAME` is where workload images are stored in the registry. If this key is passed through the shared section earlier and AWS ECR registry is used, you must ensure that the `SERVER-NAME/REPO-NAME/buildservice` and `SERVER-NAME/REPO-NAME/workloads` exist. AWS ECR expects the paths to be pre-created. Images are written to `SERVER-NAME/REPO-NAME/workload-name`. Examples:
 - Harbor has the form `repository: "my-project/supply-chain"`.
 - Docker Hub has the form `repository: "my-dockerhub-user"`.
 - Google Cloud Registry has the form `repository: "my-project/supply-chain"`.
- `EXTERNAL-REGISTRY-FOR-LOCAL-SOURCE` is where the developer's local source is uploaded when using Tanzu CLI to use Local Source Proxy for workload creation.

If an AWS ECR registry is being used, ensure that the repository already exists. AWS ECR expects the repository path to already exist. This destination is represented as `REGISTRY-SERVER/REPOSITORY-PATH`. For more information, see [Install Local Source Proxy](#).

- `EXTERNAL-REGISTRY-FOR-LOCAL-SOURCE-SECRET` is the name of the secret with credentials that allow pushing to the `EXTERNAL-REGISTRY-FOR-LOCAL-SOURCE` repository.
- `EXTERNAL-REGISTRY-FOR-LOCAL-SOURCE-SECRET-NAMESPACE` is the namespace in which `EXTERNAL-REGISTRY-FOR-LOCAL-SOURCE-SECRET` is available.
- `SSH-SECRET-KEY` is the SSH secret key in the developer namespace for the supply chain to fetch source code from and push configuration to. This field is only required if you use a private repository, otherwise, leave it empty. See [Git authentication](#) for more information.
- `GIT-CATALOG-URL` is the path to the `catalog-info.yaml` catalog definition file. You can download either a blank or populated catalog file from the [Broadcom Support Portal](#) (file name **Tanzu Application Platform Developer Portal Blank Catalog** or **Tanzu Application Platform Developer Portal Yelb Catalog**). Otherwise, you can use a Backstage-compliant catalog you've already built and posted on the Git infrastructure.
- `MY-DEV-NAMESPACE` is the name of the developer namespace. SCST - Store exports secrets to the namespace, and SCST - Scan deploys the `ScanTemplates` there. This allows the scanning feature to run in this namespace. If there are multiple developer namespaces, use `ns_for_export_app_cert: "*"` to export the SCST - Store CA certificate to all namespaces. To install Grype in multiple namespaces, use a namespace provisioner. For more information, see [Namespace Provisioner](#).
- `TARGET-REGISTRY-CREDENTIALS-SECRET` is the name of the secret that contains the credentials to pull an image from the registry for scanning.
- `CUSTOMER-ENTITLEMENT-ACCOUNT-NUMBER` (optional) refers to the Entitlement Account Number (EAN), which is a unique identifier VMware assigns to its customers. Tanzu

Application Platform telemetry uses this number to identify data that belongs to a particular customer and prepare usage reports.

If you use custom CA certificates, you must provide one or more PEM-encoded CA certificates under the `ca_cert_data` key. If you configured `shared.ca_cert_data`, Tanzu Application Platform component packages inherit that value by default.

If you use AWS, the default settings creates a classic LoadBalancer. To use the Network LoadBalancer instead of the classic LoadBalancer for ingress, add the following to your `tap-values.yaml`:

```
contour:
  infrastructure_provider: aws
envoy:
  service:
    aws:
      LBType: nlb
```

CEIP policy disclosure

Tanzu Application Platform is part of [VMware's CEIP program](#) where data is collected to help improve the customer experience. By setting `ceip_policy_disclosed` to `true` (not a string), you acknowledge the program is disclosed to you and you are aware data collection is happening. This field must be set for the installation to be completed.

See [Opt out of telemetry collection](#) for more information.

(Optional) Configure your profile with full dependencies

When you install a profile that includes Tanzu Build Service, Tanzu Application Platform is installed with the `lite` set of dependencies. These dependencies consist of `buildpacks` and `stacks` required for application builds.

The `lite` set of dependencies do not contain all buildpacks and stacks. To use all buildpacks and stacks, you must install the `full` dependencies. For more information about the differences between `lite` and `full` dependencies, see [About lite and full dependencies](#).

To configure `full` dependencies, add the key-value pair `exclude_dependencies: true` to your `tap-values.yaml` file under the `buildservice` section. For example:

```
buildservice:
  kp_default_repository: "KP-DEFAULT-REPO"
  kp_default_repository_secret: # Takes the value from the shared section by default,
  but can be overridden by setting a different value.
    name: "KP-DEFAULT-REPO-SECRET"
    namespace: "KP-DEFAULT-REPO-SECRET-NAMESPACE"
  exclude_dependencies: true
```

After configuring `full` dependencies, you must install the dependencies after you have finished installing your Tanzu Application Platform package. See [Install the full dependencies package](#) for more information.

Tanzu Application Platform v1.6.1 supports building applications with Ubuntu v22.04 (Jammy).

(Optional) Override the default retention behavior for Crossplane CRDs

By default, the `crossplane.tanzu.vmware.com` package is configured to retain all Crossplane CRDs, providers, and managed resources when the package is uninstalled. This is in the interest of caution in relation to accidental deletion of stateful data.

You can configure Tanzu Application Platform to delete Crossplane resources to avoid orphaned resources. To do so, update the `tap-values.yaml` as follows:

```
# tap-values.yaml

crossplane:
  orphan_resources: false
```

Install your Tanzu Application Platform package

Follow these steps to install the Tanzu Application Platform package:

1. Install the package by running:

```
tanzu package install tap -p tap.tanzu.vmware.com -v $TAP_VERSION --values-file
tap-values.yaml -n tap-install
```

2. Verify the package install by running:

```
tanzu package installed get tap -n tap-install
```

This can take 5-10 minutes because it installs several packages on your cluster.

3. Verify that the necessary packages in the profile are installed by running:

```
tanzu package installed list -A
```

4. If you configured `full` dependencies in your `tap-values.yaml` file, install the `full` dependencies by following the procedure in [Install full dependencies](#).



Important

After installing the full profile on your cluster, you must set up developer namespaces. Otherwise, creating a workload, a Knative service or other Tanzu Application Platform packages fails. For more information, see [Set up developer namespaces to use your installed packages](#).

You can run the following command after reconfiguring the profile to reinstall the Tanzu Application Platform:

```
tanzu package installed update tap -p tap.tanzu.vmware.com -v $TAP_VERSION --values-f
ile tap-values.yaml -n tap-install
```

Install the full dependencies package

If you configured `full` dependencies in your `tap-values.yaml` file in [Configure your profile with full dependencies](#) earlier, you must install the `full` dependencies package.

1. (Optional) If you have an existing installation of the full dependencies package from a version earlier than Tanzu Application Platform v1.6.1, you must uninstall the full dependencies package and remove the package repository:

Uninstall the package:

```
tanzu package installed delete full-tbs-deps -n tap-install
```

Remove the package repository:

```
tanzu package repository delete tbs-full-deps-repository -n tap-install
```

2. If you have not done so already, add the key-value pair `exclude_dependencies: true` to your `tap-values.yaml` file under the `buildservice` section. For example:

```
buildservice:
...
  exclude_dependencies: true
...
```

3. If you have not updated your Tanzu Application Platform package install after adding the `exclude_dependencies: true` to your values file, you must perform the update by running:

```
tanzu package installed update tap --namespace tap-install --values-file PATH-TO-UPDATED-VALUES
```

4. Get the latest version of the `tap` package by running:

```
tanzu package available list tap.tanzu.vmware.com --namespace tap-install
```

5. Relocate the Tanzu Build Service full dependencies package repository by running:

```
imgpkg copy -b tanzu.packages.broadcom.com/tanzu-application-platform/full-deps
--package-repo:${TAP_VERSION} \
  --to-repo ${INSTALL_REGISTRY_HOSTNAME}/${INSTALL_REPO}/full-deps-package-repo
```

6. Add the Tanzu Build Service full dependencies package repository by running:

```
tanzu package repository add full-deps-package-repo \
  --url ${INSTALL_REGISTRY_HOSTNAME}/${INSTALL_REPO}/full-deps-package-repo:${TAP_VERSION} \
  --namespace tap-install
```

7. Install the full dependencies package by running:

```
tanzu package install full-deps -p full-deps.buildservice.tanzu.vmware.com -v
"> 0.0.0" -n tap-install --values-file PATH-TO-TAP-VALUES-FILE
```

For more information about the differences between `lite` and `full` dependencies, see [About lite and full dependencies](#).

Access Tanzu Developer Portal

To access Tanzu Developer Portal, you can use the host name that you configured earlier. This host name is pointed at the shared ingress. To configure LoadBalancer for Tanzu Developer Portal, see [Access Tanzu Developer Portal](#).

You're now ready to start using Tanzu Developer Portal. Proceed to the [Getting Started](#) topic or the [Tanzu Developer Portal - Catalog Operations](#) topic.

Exclude packages from a Tanzu Application Platform profile

To exclude packages from a Tanzu Application Platform profile:

1. Find the full subordinate (child) package name:

```
tanzu package available list --namespace tap-install
```

2. Update your `tap-values` file with a section listing the exclusions:

```
profile: PROFILE-VALUE
excluded_packages:
  - tap-gui.tanzu.vmware.com
  - service-bindings.lab.vmware.com
```



Important

If you exclude a package after performing a profile installation including that package, you cannot see the accurate package states immediately after running `tap package installed list -n tap-install`. Also, you can break package dependencies by removing a package. Allow 20 minutes to verify that all packages have reconciled correctly while troubleshooting.

Next steps

- (Optional) [Install individual packages](#)
- [Set up developer namespaces to use your installed packages](#)
- [Replace the default ingress issuer](#)

View possible configuration settings for your package

To view possible configuration settings for a package, run:

```
tanzu package available get tap.tanzu.vmware.com/$TAP_VERSION --values-schema --namespace tap-install
```



Note

The `tap.tanzu.vmware.com` package does not show all configuration settings for packages it plans to install. The package only shows top-level keys. You can view individual package configuration settings with the same `tanzu package available get` command. For example, to find the keys for Cloud Native Runtimes, you must first identify the version of the package with `tanzu package installed list -n tap-install`, which lists all the installed packages versions. Then run the command `tanzu package available get -n tap-install cnrs.tanzu.vmware.com/CNR-VERSION --values-schema` by using the package version listed for Cloud Native Runtimes.

```
profile: full

# Shared configurations go under the shared key.
shared:
  ingress_domain: tap.example.com

# ...

# For example, Cloud Native Runtimes specific values go under its name.
cnrs:
  provider: local

# For example, App Accelerator specific values go under its name.
```

```

accelerator:
  server:
    service_type: "ClusterIP"

```

Shared Keys define values that configure multiple packages. These keys are defined under the `shared` Top-level Key, as summarized in the following table:

Shared Key	Description	Optional
<code>ca_cert_data</code>	PEM-encoded certificate data to trust TLS connections with a private CA. This shared key is used by <code>convention_controller</code> , <code>scanning</code> and the Tanzu <code>source_controller</code> (not the Flux CD Source Controller).	Yes
<code>ingress_domain</code>	Domain name to be used in service routes and host names for instances of Tanzu Application Platform components.	Yes
<code>ingress_issuer</code>	A <code>cert-manager.io/v1/ClusterIssuer</code> for issuing TLS certificates to Tanzu Application Platform components. Default value: <code>tap-ingress-selfsigned</code>	Yes
<code>kubernetes_distribution</code>	Type of Kubernetes infrastructure being used. You can use this shared key in coordination with the <code>kubernetes_version</code> key. Supported value: <code>openshift</code> .	Yes
<code>kubernetes_version</code>	Kubernetes version. You can use this shared key independently or in coordination with the <code>kubernetes_distribution</code> key. Supported value: <code>1.24.x</code> , where <code>x</code> stands for the Kubernetes patch version.	Yes
<code>image_registry.project_path</code>	Project path in the container image registry server used for builder and application images.	Yes
<code>image_registry.username</code>	User name for the container image registry. Mutually exclusive with <code>shared.image_registry.secret.name/namespace</code>	Yes
<code>image_registry.password</code>	Password for the container image registry. Mutually exclusive with <code>shared.image_registry.secret.name/namespace</code>	Yes
<code>secret.name</code>	Secret name for the container image registry credentials of type <code>kubernetes.io/dockerconfigjson</code> . Mutually exclusive with <code>shared.image_registry.username/password</code>	Yes
<code>secret.namespace</code>	Secret namespace for the container image registry credentials. Mutually exclusive with <code>shared.image_registry.username/password</code>	Yes
<code>activateAppLiveViewSecureAccessController</code>	Enable secure access connection between Application Live View components.	Yes

The following table summarizes the top-level keys used for package-specific configuration within your `tap-values.yaml`.

Package	Top-level Key
See table above.	<code>shared</code>
API Auto Registration	<code>api_auto_registration</code>
API portal	<code>api_portal</code>
Application Accelerator	<code>accelerator</code>
Application Live View	<code>appliveview</code>
Application Live View connector	<code>appliveview_connector</code>
Application Live View conventions	<code>appliveview-conventions</code>
Cartographer	<code>cartographer</code>
Cloud Native Runtimes	<code>cnrs</code>

Package	Top-level Key
Source Controller	<code>source_controller</code>
Supply Chain	<code>supply_chain</code>
Supply Chain Basic	<code>ootb_supply_chain_basic</code>
Supply Chain Testing	<code>ootb_supply_chain_testing</code>
Supply Chain Testing Scanning	<code>ootb_supply_chain_testing_scanning</code>
Supply Chain Security Tools - Scan	<code>scanning</code>
Supply Chain Security Tools - Scan (Grype Scanner)	<code>grype</code>
Supply Chain Security Tools - Store	<code>metadata_store</code>
Build Service	<code>buildservice</code>
Tanzu Developer Portal	<code>tap_gui</code>
Learning Center	<code>learningcenter</code>

For information about package-specific configuration, see [Install individual packages](#).

Install individual packages

You can install Tanzu Application Platform (commonly known as TAP) through predefined profiles or through individual packages. Use this topic to learn how to install each individual package. For more information about installing through profiles, see [Components and installation profiles](#).

Installing individual Tanzu Application Platform packages is useful if you do not want to use a profile to install packages or if you want to install additional packages after installing a profile. Before installing the packages, be sure to complete the prerequisites, configure and verify the cluster, and install the Tanzu CLI with any required plug-ins. For more information, see [Prerequisites](#).

Install pages for individual Tanzu Application Platform packages

- [Install API Auto Registration](#)
- [Install API portal](#)
- [Install Application Accelerator](#)
- [Install Application Configuration Service](#)
- [Install Application Live View](#)
- [Install Application Single Sign-On](#)
- [Install Bitnami Services](#)
- [Install cert-manager](#)
- [Install Cloud Native Runtimes](#)
- [Install Contour](#)
- [Install Crossplane](#)
- [Install default roles for Tanzu Application Platform](#)
- [Install Developer Conventions](#)
- [Install Eventing](#)

- [Install Flux CD Source Controller](#)
- [Install Learning Center for Tanzu Application Platform](#)
- [Install Out of the Box Templates](#)
- [Install Out of the Box Supply Chain with Testing](#)
- [Install Out of the Box Supply Chain with Testing and Scanning](#)
- [Install Service Bindings](#)
- [Install Services Toolkit](#)
- [Install Source Controller](#)
- [Install Spring Boot conventions](#)
- [Install Supply Chain Choreographer](#)
- [Install Supply Chain Security Tools - Store](#)
- [Install Supply Chain Security Tools - Policy Controller](#)
- [Install Supply Chain Security Tools - Scan](#)
- [Install Tanzu Developer Portal](#)
- [Install Tanzu Build Service](#)
- [Install Tekton](#)
- [Install Telemetry](#)

Verify the installed packages

Use the following procedure to verify that the packages are installed.

1. List the installed packages by running:

```
tanzu package installed list --namespace tap-install
```

For example:

```
$ tanzu package installed list --namespace tap-install
\ Retrieving installed packages...
NAME                                PACKAGE-NAME                                PAC
KAGE-VERSION  STATUS
api-portal    api-portal.tanzu.vmware.com                1.
0.3           Reconcile succeeded
app-accelerator  accelerator.apps.tanzu.vmware.com          1.
0.0           Reconcile succeeded
app-live-view   appliveview.tanzu.vmware.com               1.
0.2           Reconcile succeeded
appliveview-conventions  build.appliveview.tanzu.vmware.com         1.
0.2           Reconcile succeeded
cartographer    cartographer.tanzu.vmware.com              0.
1.0           Reconcile succeeded
cloud-native-runtimes  cnrs.tanzu.vmware.com                      1.
0.3           Reconcile succeeded
convention-controller  controller.conventions.apps.tanzu.vmware.com 0.
7.0           Reconcile succeeded
developer-conventions  developer-conventions.tanzu.vmware.com       0.
3.0-build.1  Reconcile succeeded
grype-scanner    grype.scanning.apps.tanzu.vmware.com        1.
0.0           Reconcile succeeded
image-policy-webhook  image-policy-webhook.signing.apps.tanzu.vmware.com 1.
1.2           Reconcile succeeded
```

metadata-store		metadata-store.apps.tanzu.vmware.com	1.
0.2	Reconcile	succeeded	
ootb-supply-chain-basic		ootb-supply-chain-basic.tanzu.vmware.com	0.
5.1	Reconcile	succeeded	
ootb-templates		ootb-templates.tanzu.vmware.com	0.
5.1	Reconcile	succeeded	
scan-controller		scanning.apps.tanzu.vmware.com	1.
0.0	Reconcile	succeeded	
service-bindings		service-bindings.labs.vmware.com	0.
5.0	Reconcile	succeeded	
services-toolkit		services-toolkit.tanzu.vmware.com	0.
8.0	Reconcile	succeeded	
source-controller		controller.source.apps.tanzu.vmware.com	0.
2.0	Reconcile	succeeded	
sso4k8s-install		sso.apps.tanzu.vmware.com	1.
0.0-beta.2-31	Reconcile	succeeded	
tap-gui		tap-gui.tanzu.vmware.com	0.
3.0-rc.4	Reconcile	succeeded	
tekton-pipelines		tekton.tanzu.vmware.com	0.3
0.0	Reconcile	succeeded	
tbs		buildservice.tanzu.vmware.com	1.
5.0	Reconcile	succeeded	

Next steps

- [Set up developer namespaces to use your installed packages](#)

Set up developer namespaces to use your installed packages

For details about how to automatically set up your developer namespaces, see [Provision developer namespaces in Namespace Provisioner](#).

Additional configuration for testing and scanning

If you plan to install or have already installed Out of the Box Supply Chains with Testing and Scanning, you can use Namespace Provisioner to set up the required resources. For more information, see [Customize installation](#) in the Namespace Provisioner documentation for configuration steps.

Legacy namespace setup

To use the legacy manual process for setting up developer namespaces, see [Legacy namespace setup](#).

Next steps

- [Install Tanzu Developer Tools for your VS Code](#)

Provision namespaces manually

This topic tells you how to use Namespace Provisioner to provision namespaces manually in Tanzu Application Platform (commonly known as TAP).

Using [Namespace Provisioner](#) is the recommended best practice for setting up developer namespaces on Tanzu Application Platform.

To provision namespaces manually, complete the following steps:

1. [Enable single user access.](#)
2. (Optional) [Enable additional users with Kubernetes RBAC.](#)

Enable single user access

1. To add read/write registry credentials to the developer namespace, run the following command:

```
tanzu secret registry add registry-credentials --server REGISTRY-SERVER --username REGISTRY-USERNAME --password REGISTRY-PASSWORD --namespace YOUR-NAMESPACE
```

Where:

- o `YOUR-NAMESPACE` is the name you give to the developer namespace. For example, use `default` for the default namespace.
- o `REGISTRY-SERVER` is the URL of the registry. You can use the same registry server as in `ootb_supply_chain_basic - registry - server`. For more information, see [Install Tanzu Application Platform package and profiles](#).
 - For Docker Hub, the value is `https://index.docker.io/v1/`. It must have the leading `https://`, the `v1` path, and the trailing `/`.
 - For Google Container Registry (GCR), the value is `gcr.io`.
- o `REGISTRY-PASSWORD` is the password of the registry.
 - For GCR or Google Artifact Registry, this must be the concatenated version of the JSON key. For example: `"$(cat ~/gcp-key.json)"`

If you observe the following issue:

```
panic: runtime error: invalid memory address or nil pointer dereference
[signal SIGSEGV: segmentation violation code=0x1 addr=0x128 pc=0x2bcce00]
```

Use `kubectl` to create the secret instead:

```
kubectl create secret docker-registry registry-credentials --docker-server=REGISTRY-SERVER --docker-username=REGISTRY-USERNAME --docker-password=REGISTRY-PASSWORD -n YOUR-NAMESPACE
```



Note

This step is not required if you install Tanzu Application Platform on AWS with EKS and use [IAM Roles for Kubernetes Service Accounts](#) instead of secrets. You can specify the Role Amazon Resource Name (ARN) in the next step.

2. Run the following to add secrets, a service account to execute the supply chain, and RBAC rules to authorize the service account to the developer namespace:

```
cat <<EOF | kubectl -n YOUR-NAMESPACE apply -f -
apiVersion: v1
kind: Secret
metadata:
  name: tap-registry
  annotations:
    secretgen.carvel.dev/image-pull-secret: ""
type: kubernetes.io/dockerconfigjson
data:
```

```

    .dockerconfigjson: e30K
    ---
    apiVersion: v1
    kind: ServiceAccount
    metadata:
      name: default
    secrets:
      - name: registry-credentials
    imagePullSecrets:
      - name: registry-credentials
      - name: tap-registry
    ---
    apiVersion: rbac.authorization.k8s.io/v1
    kind: RoleBinding
    metadata:
      name: default-permit-deliverable
    roleRef:
      apiGroup: rbac.authorization.k8s.io
      kind: ClusterRole
      name: deliverable
    subjects:
      - kind: ServiceAccount
        name: default
    ---
    apiVersion: rbac.authorization.k8s.io/v1
    kind: RoleBinding
    metadata:
      name: default-permit-workload
    roleRef:
      apiGroup: rbac.authorization.k8s.io
      kind: ClusterRole
      name: workload
    subjects:
      - kind: ServiceAccount
        name: default
    EOF

```



Note

If you install Tanzu Application Platform on AWS with EKS and use [IAM Roles for Kubernetes Service Accounts](#), you must annotate the ARN of the IAM Role and remove the `registry-credentials` secret. Your service account entry then looks like the following:

```

    apiVersion: v1
    kind: ServiceAccount
    metadata:
      name: default
      annotations:
        eks.amazonaws.com/role-arn: <Role ARN>
    imagePullSecrets:
      - name: tap-registry

```

Enable additional users with Kubernetes RBAC

Follow these steps to enable additional users in your namespace by using Kubernetes RBAC:

1. (Optional) Before you begin, ensure that you have [enabled single user access](#). If you've set up your developer namespace using [Namespace Provisioner](#), you can skip this step.

2. Choose either of the following options to give developers namespace-level access and view access to the appropriate cluster-level resources:

- o **Option 1:** Use the [Tanzu Application Platform RBAC CLI plug-in \(beta\)](#).

To use the `tanzu rbac` plug-in to grant `app-viewer` and `app-editor` roles to an identity provider group, run:

```
tanzu rbac binding add -g GROUP-FOR-APP-VIEWER -n YOUR-NAMESPACE -r app-viewer
tanzu rbac binding add -g GROUP-FOR-APP-EDITOR -n YOUR-NAMESPACE -r app-editor
```

Where:

- `YOUR-NAMESPACE` is the name you give to the developer namespace.
- `GROUP-FOR-APP-VIEWER` is the user group from the upstream identity provider that requires access to `app-viewer` resources on the current namespace and cluster.
- `GROUP-FOR-APP-EDITOR` is the user group from the upstream identity provider that requires access to `app-editor` resources on the current namespace and cluster.

For more information about `tanzu rbac`, see [Bind a user or group to a default role](#)

VMware recommends creating a user group in your identity provider's grouping system for each developer namespace and then adding the users accordingly.

Depending on your identity provider, you might need to take further action to federate user groups appropriately with your cluster. For an example of how to set up Azure Active Directory (Azure AD) with your cluster, see [Integrate Azure Active Directory](#).

- o **Option 2:** Use the native Kubernetes YAML.

Run the following to apply the RBAC policy:

```
cat <<EOF | kubectl -n YOUR-NAMESPACE apply -f -
apiVersion: rbac.authorization.k8s.io/v1
kind: RoleBinding
metadata:
  name: dev-permit-app-viewer
roleRef:
  apiGroup: rbac.authorization.k8s.io
  kind: ClusterRole
  name: app-viewer
subjects:
- kind: Group
  name: GROUP-FOR-APP-VIEWER
  apiGroup: rbac.authorization.k8s.io
---
apiVersion: rbac.authorization.k8s.io/v1
kind: ClusterRoleBinding
metadata:
  name: YOUR-NAMESPACE-permit-app-viewer
roleRef:
  apiGroup: rbac.authorization.k8s.io
  kind: ClusterRole
  name: app-viewer-cluster-access
subjects:
- kind: Group
  name: GROUP-FOR-APP-VIEWER
  apiGroup: rbac.authorization.k8s.io
```

```

---
apiVersion: rbac.authorization.k8s.io/v1
kind: RoleBinding
metadata:
  name: dev-permit-app-editor
roleRef:
  apiGroup: rbac.authorization.k8s.io
  kind: ClusterRole
  name: app-editor
subjects:
- kind: Group
  name: GROUP-FOR-APP-EDITOR
  apiGroup: rbac.authorization.k8s.io
---
apiVersion: rbac.authorization.k8s.io/v1
kind: ClusterRoleBinding
metadata:
  name: YOUR-NAMESPACE-permit-app-editor
roleRef:
  apiGroup: rbac.authorization.k8s.io
  kind: ClusterRole
  name: app-editor-cluster-access
subjects:
- kind: Group
  name: GROUP-FOR-APP-EDITOR
  apiGroup: rbac.authorization.k8s.io
EOF

```

Where:

- `YOUR-NAMESPACE` is the name you give to the developer namespace.
- `GROUP-FOR-APP-VIEWER` is the user group from the upstream identity provider that requires access to `app-viewer` resources on the current namespace and cluster.
- `GROUP-FOR-APP-EDITOR` is the user group from the upstream identity provider that requires access to `app-editor` resources on the current namespace and cluster.

VMware recommends creating a user group in your identity provider's grouping system for each developer namespace and then adding the users accordingly.

Depending on your identity provider, you might need to take further action to federate user groups appropriately with your cluster.

Rather than granting roles directly to individuals, VMware recommends using your identity provider's user groups system to grant access to a group of developers.

For an example of how to set up Azure Active Directory (AD) with your cluster, see [Integrate Azure Active Directory](#).

3. (Optional) Log in as a non-admin user, such as a developer, to see the effects of RBAC after the role bindings are applied.

Additional configuration for testing and scanning

If you plan to install Out of the Box Supply Chains with Testing and Scanning, see [Developer Namespace](#).

Install Tanzu Developer Tools for your VS Code

This topic tells you how to install VMware Tanzu Developer Tools for Visual Studio Code (VS Code).

Prerequisites

Before installing the extension, you must have:

- [VS Code](#)
- [kubectl](#)
- [Tilt v0.30.12](#) or later
- [Tanzu CLI and plug-ins](#)
- [A cluster with the Tanzu Application Platform Full profile or Iterate profile](#)

If you are an app developer, someone else in your organization might have already set up the Tanzu Application Platform environment.

Docker Desktop and local Kubernetes are not prerequisites for using Tanzu Developer Tools for VS Code.

Install

To install the extension:

1. Download Tanzu Developer Tools for Visual Studio Code from the [Broadcom Support Portal](#).
2. Open VS Code.
3. Press `cmd+shift+P` to open the Command Palette and run `Extensions: Install from VSIX...`



4. Select the extension file `tanzu-vscode-extension.vsix`.
5. If you do not have the following extensions, and they do not automatically install, install them from VS Code Marketplace:
 - [Debugger for Java](#)
 - [Language Support for Java\(™\) by Red Hat](#)
 - [YAML](#)
6. Ensure Language Support for Java is running in [Standard Mode](#). You can configure it in the **Settings** menu by going to **Code > Preferences > Settings** under **Java > Server: Launch Mode**.

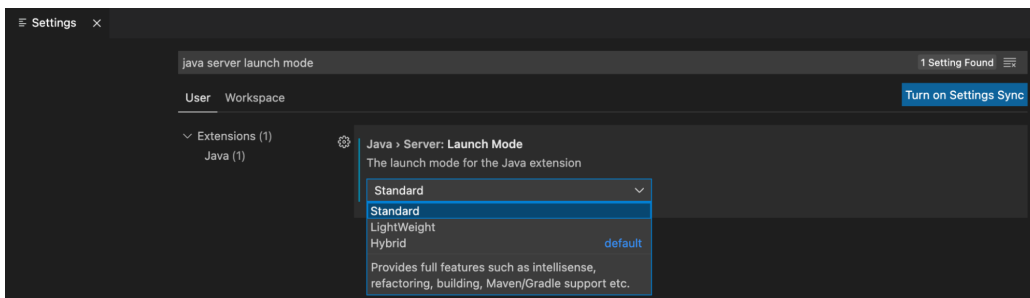

When the JDK and Language Support for Java are configured correctly, you see that the integrated development environment creates a directory target where the code is compiled.

Configure

To configure VMware Tanzu Developer Tools for VS Code:

1. Ensure that you are targeting the correct cluster. For more information, see the [Kubernetes documentation](#).
2. Go to **Code > Preferences > Settings > Extensions > Tanzu Developer Tools** and set the following:
 - **Confirm Delete:** This controls whether the extension asks for confirmation when deleting a workload.
 - **Enable Live Hover:** For more information, see [Integrating Live Hover by using Spring Boot Tools](#). Reload VS Code for this change to take effect.
 - **Source Image:** The registry location for publishing local source code. For example, `registry.io/yourapp-source`. This must include both a registry and a project name. A source image registry location is optional when Local Source Proxy is configured.
 - **Local Path:** (Optional) The path on the local file system to a directory of source code to build. This is the current directory by default.
 - **Namespace:** (Optional) This is the namespace that workloads are deployed into. The namespace set in `kubeconfig` is the default.

Uninstall

To uninstall VMware Tanzu Developer Tools for VS Code:

1. Go to **Code > Preferences > Settings > Extensions**.
2. Right-click the extension and select **Uninstall**.

Next steps

Proceed to [Getting started with Tanzu Developer Tools for Visual Studio Code](#).

Install Tanzu Application Platform (offline)

To install Tanzu Application Platform (commonly known as TAP) on your Kubernetes clusters in an air-gapped environment:

Step	Task	Link
1.	Review the prerequisites to ensure you have met all requirements before installing.	Prerequisites
2.	Install the Tanzu CLI.	Install the Tanzu CLI
3.	Install Cluster Essentials for Tanzu*.	Deploy Cluster Essentials
4.	Add the Tanzu Application Platform package repository, prepare your Tanzu Application Platform profile, and install the profile to the cluster.	Install Tanzu Application Platform in your air-gapped environment
5.	Install Tanzu Build Service full dependencies.	Install the Tanzu Build Service dependencies
6.	Configure custom certificate authorities for Tanzu Developer Portal.	Configure custom certificate authorities for Tanzu Developer Portal

Step	Task	Link
7.	Add the certificate for the private Git repository in the Accelerator system namespace.	Configure Application Accelerator
8.	Apply patch to Grype.	Use Grype in offline and air-gapped environments
9.	Set up developer namespaces to use your installed packages.	Set up developer namespaces to use your installed packages
10.	Install IDE extensions from Marketplace	Install IDE Extensions in your air-gapped environment

** When you use a VMware Tanzu Kubernetes Grid cluster, there is no need to install Cluster Essentials because the contents of Cluster Essentials are already installed on your cluster.*

After installing Tanzu Application Platform on to your air-gapped cluster, you can start creating workloads that run in your air-gapped containers.

For more information about the Namespace Provisioner mode, see [Work with Git repositories in air-gapped environments with Namespace Provisioner](#).

For more information about the manual mode, see [Deploy an air-gapped workload](#).

Install Tanzu Application Platform (offline)

To install Tanzu Application Platform (commonly known as TAP) on your Kubernetes clusters in an air-gapped environment:

Step	Task	Link
1.	Review the prerequisites to ensure you have met all requirements before installing.	Prerequisites
2.	Install the Tanzu CLI.	Install the Tanzu CLI
3.	Install Cluster Essentials for Tanzu*.	Deploy Cluster Essentials
4.	Add the Tanzu Application Platform package repository, prepare your Tanzu Application Platform profile, and install the profile to the cluster.	Install Tanzu Application Platform in your air-gapped environment
5.	Install Tanzu Build Service full dependencies.	Install the Tanzu Build Service dependencies
6.	Configure custom certificate authorities for Tanzu Developer Portal.	Configure custom certificate authorities for Tanzu Developer Portal
7.	Add the certificate for the private Git repository in the Accelerator system namespace.	Configure Application Accelerator
8.	Apply patch to Grype.	Use Grype in offline and air-gapped environments
9.	Set up developer namespaces to use your installed packages.	Set up developer namespaces to use your installed packages
10.	Install IDE extensions from Marketplace	Install IDE Extensions in your air-gapped environment

** When you use a VMware Tanzu Kubernetes Grid cluster, there is no need to install Cluster Essentials because the contents of Cluster Essentials are already installed on your cluster.*

After installing Tanzu Application Platform on to your air-gapped cluster, you can start creating workloads that run in your air-gapped containers.

For more information about the Namespace Provisioner mode, see [Work with Git repositories in air-gapped environments with Namespace Provisioner](#).

For more information about the manual mode, see [Deploy an air-gapped workload](#).

Install Tanzu Application Platform in your air-gapped environment

This topic tells you how to install Tanzu Application Platform (commonly known as TAP) on your Kubernetes cluster and registry that are air-gapped from external traffic.



Before installing the packages, ensure that you have completed the following tasks:

- Review the [Prerequisites](#) to ensure that you have set up everything required before beginning the installation.
- [Install Tanzu CLI](#).
- [Deploy Cluster Essentials](#). This step is optional if you are using VMware Tanzu Kubernetes Grid cluster.

Relocate images to a registry

To relocate images from tanzu.packages.broadcom.com registry to your air-gapped registry:

1. Retrieve your Broadcom registry API token:
 1. Sign in to the [Broadcom Support Portal](#).
 2. Go to [Tanzu Application Platform \(TAP\)](#) and expand the **VMware Tanzu Application Platform** dropdown.
 3. Click the Token Download icon next to the Tanzu Application Platform version you want to download.

Release	Release Level Info	Language	
1.10.1	521283	English	
1.10.0	360181	English	
1.9.1	360147	English	

4. Follow the instructions in the dialog box. Save the token as a variable named `MY_BROADCOM_SUPPORT_ACCESS_TOKEN`. For example:

```
export MY_BROADCOM_SUPPORT_ACCESS_TOKEN=API-TOKEN
```

Where `API-TOKEN` is your token from the Broadcom Support Portal.

2. Set up environment variables for installation use by running:

```
# Set tanzu.packages.broadcom.com as the source registry to copy the Tanzu Appl
ication Platform packages from.
export IMGPKG_REGISTRY_HOSTNAME_0=tanzu.packages.broadcom.com
export IMGPKG_REGISTRY_USERNAME_0=MY-BROADCOM-SUPPORT-USERNAME
export IMGPKG_REGISTRY_PASSWORD_0=${MY_BROADCOM_SUPPORT_ACCESS_TOKEN}

# The user's registry for copying the Tanzu Application Platform package to.
export IMGPKG_REGISTRY_HOSTNAME_1=MY-REGISTRY
export IMGPKG_REGISTRY_USERNAME_1=MY-REGISTRY-USER
export IMGPKG_REGISTRY_PASSWORD_1=MY-REGISTRY-PASSWORD
```

```
# These environment variables starting with IMGPKG_* are used by the imgpkg command only.

export TAP_VERSION=VERSION-NUMBER
export REGISTRY_CA_PATH=PATH-TO-CA
export TO_REPO=MY-REPO
```

Where:

- o `MY-BROADCOM-SUPPORT-USERNAME` is the user with access to the images in `tanzu.packages.broadcom.com`.
 - o `MY-REGISTRY` is your air-gapped container registry.
 - o `MY-REGISTRY-USER` is the user with write access to `MY-REGISTRY`.
 - o `MY-REGISTRY-PASSWORD` is the password for `MY-REGISTRY-USER`.
 - o `VERSION-NUMBER` is your Tanzu Application Platform version. For example, `1.6.13`.
 - o `PATH-TO-CA` is the path to your CA certificate.
 - o `MY-REPO` is your repository in the air-gapped container image registry. Examples:
 - Harbor has the form `MY-REGISTRY/REPO-NAME/tap-packages`.
 - Docker Hub has the form `MY-REGISTRY/tap-packages`.
 - Google Cloud Registry has the form `MY-REGISTRY/MY-PROJECT/REPO-NAME/tap-packages`.
3. Copy the images into a `.tar` file from `tanzu.packages.broadcom.com` onto an external storage device with the Carvel tool `imgpkg` by running:

```
imgpkg copy \
  -b tanzu.packages.broadcom.com/tanzu-application-platform/tap-packages:$TAP_VERSION \
  --to-tar tap-packages-$TAP_VERSION.tar \
  --include-non-distributable-layers
```

4. Relocate the images with the Carvel tool `imgpkg` by running:

```
imgpkg copy \
  --tar tap-packages-$TAP_VERSION.tar \
  --to-repo $TO_REPO \
  --include-non-distributable-layers \
  --registry-ca-cert-path $REGISTRY_CA_PATH
```

Add the Tanzu Application Platform package repository

Tanzu CLI packages are available through repositories. Adding the Tanzu Application Platform package repository makes Tanzu Application Platform and its packages available for installation.

To add the Tanzu Application Platform package repository to your cluster:

1. Create a namespace called `tap-install` for deploying any component packages by running:

```
kubectl create ns tap-install
```

This namespace keeps the objects grouped together logically.

2. Create a registry secret by running:

```
tanzu secret registry add tap-registry \
  --server $IMGPKG_REGISTRY_HOSTNAME_1 \
  --username $IMGPKG_REGISTRY_USERNAME_1 \
```

```
--password $IMGPKG_REGISTRY_PASSWORD_1 \
--namespace tap-install \
--export-to-all-namespaces \
--yes
```

3. Create a secret for accessing the user's registry by running:

```
tanzu secret registry add registry-credentials \
--server $IMGPKG_REGISTRY_HOSTNAME_1 \
--username $IMGPKG_REGISTRY_USERNAME_1 \
--password $IMGPKG_REGISTRY_PASSWORD_1 \
--namespace tap-install \
--export-to-all-namespaces \
--yes
```

4. Add the Tanzu Application Platform package repository to the cluster by running:

```
tanzu package repository add tanzu-tap-repository \
--url $IMGPKG_REGISTRY_HOSTNAME_1/tap-packages:$TAP_VERSION \
--namespace tap-install
```

Where `$TAP_VERSION` is the Tanzu Application Platform version environment variable you defined earlier.

5. Get the status of the Tanzu Application Platform package repository, and ensure the status updates to `Reconcile succeeded` by running:

```
tanzu package repository get tanzu-tap-repository --namespace tap-install
```



Note

The `VERSION` and `TAG` numbers differ from the earlier example if you are on Tanzu Application Platform v1.0.2 or earlier.

6. List the available packages by running:

```
tanzu package available list --namespace tap-install
```

For example:

```
$ tanzu package available list --namespace tap-install
/ Retrieving available packages...
NAME                                DISPLAY-NAME
SHORT-DESCRIPTION
accelerator.apps.tanzu.vmware.com    Application Accelerator
for VMware Tanzu                    Used to create new projects a
nd configurations.
api-portal.tanzu.vmware.com          API portal
A unified user interface for API discovery and exploration at scale.
apis.apps.tanzu.vmware.com           API Auto Registration fo
r VMware Tanzu                       A TAP component to automatica
lly register API exposing workloads as API entities
in TAP GUI.
backend.appliveview.tanzu.vmware.com Application Live View fo
r VMware Tanzu                        App for monitoring and troubl
eshooting running apps
buildservice.tanzu.vmware.com        Tanzu Build Service
Tanzu Build Service enables the building and automation of containerized
software workflows securely and at scale.
```

carbonblack.scanning.apps.tanzu.vmware.com Supply Chain Security Tools - Scan VMware Carbon Black	VMware Carbon Black for Default scan templates using VMware Carbon Black
cartographer.tanzu.vmware.com Kubernetes native Supply Chain Choreographer.	Cartographer
cnrs.tanzu.vmware.com Cloud Native Runtimes is a serverless runtime based on Knative	Cloud Native Runtimes
connector.appliveview.tanzu.vmware.com connector for VMware Tanzu	Application Live View Co App for discovering and regis tering running apps
controller.source.apps.tanzu.vmware.com Tanzu Source Controller enables workload create/update from source code.	Tanzu Source Controller
conventions.appliveview.tanzu.vmware.com nventions for VMware Tanzu	Application Live View Co Application Live View convent ion server
developer-conventions.tanzu.vmware.com oper Conventions	Tanzu App Platform Devel Developer Conventions
eventing.tanzu.vmware.com Eventing is an event-driven architecture platform based on Knative Eventing	Eventing
external-secrets.apps.tanzu.vmware.com r a Kubernetes operator that integrates external secret management systems.	External Secrets Operato External Secrets Operator is
fluxcd.source.controller.tanzu.vmware.com The source-controller is a Kubernetes operator, specialised in artifacts acquisition from external sources such as Git, Helm repositories and S3 bucket s.	Flux Source Controller
grype.scanning.apps.tanzu.vmware.com ecurity Tools - Scan Anchore Grype	Grype for Supply Chain S Default scan templates using
learningcenter.tanzu.vmware.com u Application Platform	Learning Center for Tanz Guided technical workshops
metadata-store.apps.tanzu.vmware.com ols - Store e, package, and vulnerability metadata.	Supply Chain Security To Post SBOMs and query for imag
namespace-provisioner.apps.tanzu.vmware.com Automatic Provisioning of Developer Namespaces.	Namespace Provisioner
ootb-delivery-basic.tanzu.vmware.com f The Box Delivery Basic c.	Tanzu App Platform Out o Out of The Box Delivery Basi
ootb-supply-chain-basic.tanzu.vmware.com f The Box Supply Chain Basic asic.	Tanzu App Platform Out o Out of The Box Supply Chain B
ootb-supply-chain-testing-scanning.tanzu.vmware.com f The Box Supply Chain with Testing and Scanning ith Testing and Scanning.	Tanzu App Platform Out o Out of The Box Supply Chain w
ootb-supply-chain-testing.tanzu.vmware.com f The Box Supply Chain with Testing ith Testing.	Tanzu App Platform Out o Out of The Box Supply Chain w
ootb-templates.tanzu.vmware.com f The Box Templates	Tanzu App Platform Out o Out of The Box Templates.
policy.apps.tanzu.vmware.com ols - Policy Controller ining of a policy to restrict unsigned container images.	Supply Chain Security To Scan for vulnerabilities and enforce policies directly within Kubernetes native
scanning.apps.tanzu.vmware.com ols - Scan enforce policies directly within Kubernetes native	Supply Chain Security To Scan for vulnerabilities and enforce policies directly within Kubernetes native
Supply Chains. service-bindings.labs.vmware.com ernetes es implements the Service Binding Specification.	Service Bindings for Kub Service Bindings for Kubernet

services-toolkit.tanzu.vmware.com	Services Toolkit
The Services Toolkit enables the management, lifecycle, discoverability and connectivity of Service Resources (databases, message queues, DNS records, etc.).	
snyk.scanning.apps.tanzu.vmware.com	Snyk for Supply Chain Security Tools - Scan
Snyk	Default scan templates using Snyk
spring-boot-conventions.tanzu.vmware.com	Tanzu Spring Boot Conventions Server
Default Spring Boot convention server.	Default Spring Boot convention server.
sso.apps.tanzu.vmware.com	AppSSO
Application Single Sign-On for Tanzu	Application Single Sign-On for Tanzu
tap-auth.tanzu.vmware.com	Default roles for Tanzu Application Platform
Application Platform	Default roles for Tanzu Application Platform
tap-gui.tanzu.vmware.com	Tanzu Application Platform GUI
web app graphical user interface for Tanzu Application Platform	web app graphical user interface for Tanzu Application Platform
tap-telemetry.tanzu.vmware.com	Telemetry Collector for Tanzu Application Platform
Tanzu Application Platform Telemetry	Tanzu Application Platform Telemetry
tap.tanzu.vmware.com	Tanzu Application Platform
Package to install a set of Tanzu Application Platform components to get you started based on your use case.	Package to install a set of Tanzu Application Platform components to get you started based on your use case.
tekton.tanzu.vmware.com	Tekton Pipelines
Tekton Pipelines is a framework for creating CI/CD systems.	Tekton Pipelines
workshops.learningcenter.tanzu.vmware.com	Workshop Building Tutorial
al	Workshop Building Tutorial

Prepare Sigstore Stack for air-gapped policy controller



Important

This section only applies if the target environment requires support for keyless authorities in `ClusterImagePolicy`. You must set the `policy.tuf_enabled` field to `true` when installing Tanzu Application Platform. By default, keyless authorities support is deactivated.

By default, the public official Sigstore “The Update Framework (TUF) server” is used. You can use an alternative Sigstore Stack by setting `policy.tuf_mirror` and `policy.tuf_root`.

The Sigstore Stack consists of:

- [Trillian](#)
- [Rekor](#)
- [Fulcio](#)
- [Certificate Transparency Log \(CTLog\)](#)
- [The Update Framework \(TUF\)](#)

For an air-gapped environment, an internally accessible Sigstore Stack is required for keyless authorities.

Install your Tanzu Application Platform profile

The `tap.tanzu.vmware.com` package installs predefined sets of packages based on your profile settings. This is done by using the package manager installed by Tanzu Cluster Essentials.

For more information about profiles, see [Components and installation profiles](#).

To prepare to install a profile:

1. List version information for the package by running:

```
tanzu package available list tap.tanzu.vmware.com --namespace tap-install
```

2. Create a `tap-values.yaml` file by using the [Full Profile sample](#) as a guide. These samples have the minimum configuration required to deploy Tanzu Application Platform. The sample values file contains the necessary defaults for:
 - o The meta-package, or parent Tanzu Application Platform package
 - o Subordinate packages, or individual child packages

Keep the values file for future configuration use.

Full Profile

To install Tanzu Application Platform with Supply Chain Basic, you must retrieve your cluster's base64 encoded ca certificate from `$HOME/.kube/config`. Retrieve the `certificate-authority-data` from the respective cluster section and input it as `B64_ENCODED_CA` in the `tap-values.yaml`.

The following is the YAML file sample for the full-profile:

```
shared:
  ingress_domain: "INGRESS-DOMAIN"
  image_registry:
    project_path: "SERVER-NAME/REPO-NAME"
    secret:
      name: "KP-DEFAULT-REPO-SECRET"
      namespace: "KP-DEFAULT-REPO-SECRET-NAMESPACE"
  ca_cert_data: |
    -----BEGIN CERTIFICATE-----
    MIIFXzCCA0egAwIBAgIJAJYm37SFocjlMA0GCSqGSIb3DQEEDQUAMEY...
    -----END CERTIFICATE-----
profile: full
ceip_policy_disclosed: true
buildservice:
  kp_default_repository: "KP-DEFAULT-REPO"
  kp_default_repository_secret: # Takes the value from the shared section by default,
  but can be overridden by setting a different value.
  name: "KP-DEFAULT-REPO-SECRET"
  namespace: "KP-DEFAULT-REPO-SECRET-NAMESPACE"
  exclude_dependencies: true
supply_chain: basic
scanning:
  metadataStore:
    url: ""
contour:
  infrastructure_provider: aws
  envoy:
    service:
      type: LoadBalancer
      annotations:
        # This annotation is for air-gapped AWS only.
        service.kubernetes.io/aws-load-balancer-internal: "true"
ootb_supply_chain_basic:
  registry:
    server: "SERVER-NAME" # Takes the value from the shared section by default, but
```



```

can be overridden by setting a different value.
  repository: "REPO-NAME" # Takes the value from the shared section by default, but
t can be overridden by setting a different value.
gitops:
  ssh_secret: "SSH-SECRET"
maven:
  repository:
    url: https://MAVEN-URL
    secret_name: "MAVEN-CREDENTIALS"

accelerator:
  ingress:
    include: true
    enable_tls: false
  git_credentials:
    secret_name: git-credentials
    username: GITLAB-USER
    password: GITLAB-PASSWORD

appliveview:
  ingressEnabled: true

appliveview_connector:
  backend:
    ingressEnabled: true
    sslDeactivated: false
    host: appliveview.INGRESS-DOMAIN
    caCertData: |-
      -----BEGIN CERTIFICATE-----
      MIIGMzCCBBUGAwIBAgIJALHHzQjxM6wMMA0GCSqGSIb3DQEBDQUAMGcxCzAJBgNV
      BAgMAk10MRQwEgYDVQQHDAtNaW5uZWZwb2xpczEPMA0GA1UECgwGVk13YXJlMRMw
      -----END CERTIFICATE-----

local_source_proxy:
  # Takes the value from the project_path under the image_registry section of shared b
y default, but can be overridden by setting a different value.
  repository: "EXTERNAL-REGISTRY-FOR-LOCAL-SOURCE"
  push_secret:
    # When set to true, the secret mentioned in this section is automatically exported
to Local Source Proxy's namespace.
    name: "EXTERNAL-REGISTRY-FOR-LOCAL-SOURCE-SECRET"
    namespace: "EXTERNAL-REGISTRY-FOR-LOCAL-SOURCE-SECRET-NAMESPACE"
    # When set to true, the secret mentioned in this section is automatically exported
to Local Source Proxy's namespace.
    create_export: true

tap_gui:
  app_config:
    auth:
      allowGuestAccess: true # This allows unauthenticated users to log in to your po
rtal. If you want to deactivate it, make sure you configure an alternative auth provid
er.
  kubernetes:
    serviceLocatorMethod:
      type: multiTenant
    clusterLocatorMethods:
      - type: config
        clusters:
          - url: https://${KUBERNETES_SERVICE_HOST}:${KUBERNETES_SERVICE_PORT}
            name: host
            authProvider: serviceAccount
            serviceAccountToken: ${KUBERNETES_SERVICE_ACCOUNT_TOKEN}
            skipTLSVerify: false
            caData: B64_ENCODED_CA
  catalog:
    locations:

```

```

- type: url
  target: https://GIT-CATALOG-URL/catalog-info.yaml
#Example Integration for custom GitLab:
integrations:
  gitlab:
    - host: GITLAB-URL
      token: GITLAB-TOKEN
      apiBaseUrl: https://GITLABURL/api/v4/
  backend:
    reading:
      allow:
        - host: GITLAB-URL # Example URL: gitlab.example.com

metadata_store:
  ns_for_export_app_cert: "MY-DEV-NAMESPACE"
  app_service_type: ClusterIP # Defaults to LoadBalancer. If shared.ingress_domain is
  set earlier, this must be set to ClusterIP.

```



Important

- Tanzu Build Service is installed by default with `lite` dependencies. When installing Tanzu Build Service in an air-gapped environment, the `lite` dependencies are not available because they require Internet access. You must install the `full` dependencies by setting `exclude_dependencies` to `true`. The existing ClusterStore instances will not be updated if you switch from `lite` dependencies to `full` dependencies after the initial installation completes.
- Installing Grype by using `tap-values.yaml` as follows is deprecated in v1.6 and will be removed in v1.8:

```

grype:
  namespace: "MY-DEV-NAMESPACE"
  targetImagePullSecret: "TARGET-REGISTRY-CREDENTIALS-SECRET"

```

You can install Grype by using Namespace Provisioner instead.

Where:

- `INGRESS-DOMAIN` is the subdomain for the host name that you point at the `tanzu-shared-ingress` service's External IP address.
- `KP-DEFAULT-REPO` is a writable repository in your registry. Tanzu Build Service dependencies are written to this location. Examples:
 - Harbor has the form `kp_default_repository: "my-harbor.io/my-project/build-service"`.
 - Docker Hub has the form `kp_default_repository: "my-dockerhub-user/build-service"` Or `kp_default_repository: "index.docker.io/my-user/build-service"`.
 - Google Cloud Registry has the form `kp_default_repository: "gcr.io/my-project/build-service"`.
- `KP-DEFAULT-REPO-SECRET` is the secret with user credentials that can write to `KP-DEFAULT-REPO`. You can `docker push` to this location with this credential.
 - For Google Cloud Registry, use `kp_default_repository_username: _json_key`.
 - You must create the secret before the installation. For example, you can use the `registry-credentials` secret created earlier.

- `KP-DEFAULT-REPO-SECRET-NAMESPACE` is the namespace where `KP-DEFAULT-REPO-SECRET` is created.
- `SERVER-NAME` is the host name of the registry server. Examples:
 - Harbor has the form `server: "my-harbor.io"`.
 - Docker Hub has the form `server: "index.docker.io"`.
 - Google Cloud Registry has the form `server: "gcr.io"`.
- `REPO-NAME` is where workload images are stored in the registry. If this key is passed through the shared section earlier and AWS ECR registry is used, you must ensure that the `SERVER-NAME/REPO-NAME/buildservice` and `SERVER-NAME/REPO-NAME/workloads` exist. AWS ECR expects the paths to be pre-created.
- Images are written to `SERVER-NAME/REPO-NAME/workload-name`. Examples:
 - Harbor has the form `repository: "my-project/supply-chain"`.
 - Docker Hub has the form `repository: "my-dockerhub-user"`.
 - Google Cloud Registry has the form `repository: "my-project/supply-chain"`.
- `EXTERNAL-REGISTRY-FOR-LOCAL-SOURCE` is where the developer's local source is uploaded when using Tanzu CLI to use Local Source Proxy for workload creation.

If an AWS ECR registry is being used, ensure that the repository already exists. AWS ECR expects the repository path to already exist. This destination is represented as `REGISTRY-SERVER/REPOSITORY-PATH`. For more information, see [Install Local Source Proxy](#).

- `EXTERNAL-REGISTRY-FOR-LOCAL-SOURCE-SECRET` is the name of the secret with credentials that allow pushing to the `EXTERNAL-REGISTRY-FOR-LOCAL-SOURCE` repository.
- `EXTERNAL-REGISTRY-FOR-LOCAL-SOURCE-SECRET-NAMESPACE` is the namespace in which `EXTERNAL-REGISTRY-FOR-LOCAL-SOURCE-SECRET` is available.
- `SSH-SECRET` is the secret name for https authentication, certificate authority, and SSH authentication. See [Git authentication](#) for more information.
- `MAVEN-CREDENTIALS` is the name of the [secret with maven creds](#). This secret must be in the developer namespace. You can create it after the fact.
- `GIT-CATALOG-URL` is the path to the `catalog-info.yaml` catalog definition file. You can download either a blank or populated catalog file from the [Broadcom Support Portal](#) (file name **Tanzu Application Platform Developer Portal Blank Catalog** or **Tanzu Application Platform Developer Portal Yelb Catalog**). Otherwise, you can use a Backstage-compliant catalog you've already built and posted on the Git infrastructure.
- `GITLABURL` is the host name of your GitLab instance.
- `GITLAB-USER` is the user name of your GitLab instance.
- `GITLAB-PASSWORD` is the password for the `GITLAB-USER` of your GitLab instance. This can also be the `GITLAB-TOKEN`.
- `GITLAB-TOKEN` is the API token for your GitLab instance.
- `MY-DEV-NAMESPACE` is the name of the developer namespace. SCST - Store exports secrets to the namespace, and SCST - Scan deploys the `ScanTemplates` there. This allows the scanning feature to run in this namespace. If there are multiple developer namespaces, use `ns_for_export_app_cert: "*"` to export the SCST - Store CA certificate to all namespaces. To install Grype in multiple namespaces, use a namespace provisioner. See [Namespace Provisioner](#).

- `TARGET-REGISTRY-CREDENTIALS-SECRET` is the name of the secret that contains the credentials to pull an image from the registry for scanning.



Note

The `appliveview_connector.backend.sslDisabled` key is deprecated and renamed to `appliveview_connector.backend.sslDeactivated`.

If you use custom CA certificates, you must provide one or more PEM-encoded CA certificates under the `ca_cert_data` key. If you configured `shared.ca_cert_data`, Tanzu Application Platform component packages inherit that value by default.

TLS is enabled by default on Application Live View back end using ClusterIssuer. Set the `ingressEnabled` key to `true` for TLS to be enabled on Application Live View back end using ClusterIssuer. This key is set to `false` by default.

The `appliveview-cert` certificate is generated by default and its `issuerRef` points to the `.ingress_issuer` value. The `ingress_issuer` key consumes the value `shared.ingress_issuer` from `tap-values.yaml` by default when you don't specify the `ingress_issuer` in `tap-values.yaml`.

When `ingressEnabled` is `true`, an HTTPProxy object is created in the cluster and `appliveview-cert` certificate is generated by default in the `app_live_view` namespace. The secretName `appliveview-cert` stores this certificate.

To verify the HTTPProxy object with the secret, run:

```
kubectl get httpproxy -A
```

Expected output:

NAMESPACE	NAME	TLS SECRET
FQDN		
STATUS	STATUS DESCRIPTION	
app-live-view	appliveview	
appliveview.192.168.42.55.nip.io		appliveview-cert va
lid	Valid HTTPProxy	

The `appliveview_connector.backend.host` key is the back end host in the view cluster. The `appliveview_connector.backend.caCertData` key is the certificate retrieved from the HTTPProxy secret exposed by Application Live View back end in the view cluster. To retrieve this certificate, run the following command in the view cluster:

```
kubectl get secret appliveview-cert -n app-live-view -o yaml | yq '.data."ca.crt"' | base64 -d
```

Install your Tanzu Application Platform package

Follow these steps to install the Tanzu Application Platform package:

1. Install the package by running:

```
tanzu package install tap -p tap.tanzu.vmware.com -v $TAP_VERSION --values-file tap-values.yaml -n tap-install
```

Where `$TAP_VERSION` is the Tanzu Application Platform version environment variable you defined earlier.

2. Verify the package install by running:

```
tanzu package installed get tap -n tap-install
```

This may take 5-10 minutes because it installs several packages on your cluster.

3. Verify that all the necessary packages in the profile are installed by running:

```
tanzu package installed list -A
```

Next steps

- [Install the Tanzu Build Service dependencies](#)

Install the Tanzu Build Service dependencies

This topic tells you how to install the Tanzu Build Service (TBS) full dependencies on Tanzu Application Platform (commonly known as TAP).

By default, Tanzu Build Service is installed with `lite` dependencies.

When installing Tanzu Build Service on an air-gapped environment, the `lite` dependencies cannot be used as they require Internet access. You must install the `full` dependencies.

To install `full` dependencies:

1. Get the latest version of the Tanzu Application Platform package by running:

```
tanzu package available list tap.tanzu.vmware.com --namespace tap-install
```

2. Relocate the Tanzu Build Service `full` dependencies package repository by running:

```
imgpkg copy -b tanzu.packages.broadcom.com/tanzu-application-platform/full-deps
-package-repo:VERSION \
  --to-tar=full-deps-package-repo.tar
# move full-deps-package-repo.tar to environment with registry access
imgpkg copy --tar full-deps-package-repo.tar \
  --to-repo=INSTALL-REGISTRY-HOSTNAME/TARGET-REPOSITORY/full-deps-package-repo
```

Where:

- `VERSION` is the version of the TAP package you retrieved earlier.
- `INSTALL-REGISTRY-HOSTNAME` is your container registry.
- `TARGET-REPOSITORY` is your target repository.

3. Add the Tanzu Build Service `full` dependencies package repository by running:

```
tanzu package repository add full-deps-package-repo \
  --url INSTALL-REGISTRY-HOSTNAME/TARGET-REPOSITORY/full-deps-package-repo:VERS
ION \
  --namespace tap-install
```

Where:

- `INSTALL-REGISTRY-HOSTNAME` is your container registry.
- `TARGET-REPOSITORY` is your target repository.
- `VERSION` is the version of the TAP package you retrieved earlier.

4. Install the `full` dependencies package by running:

```
tanzu package install full-deps -p full-deps.buildservice.tanzu.vmware.com -v
"> 0.0.0" -n tap-install --values-file PATH-TO-TAP-VALUES-FILE
```

Next steps

- [Configure custom CAs for Tanzu Developer Portal](#)

Configure custom certificate authorities for Tanzu Developer Portal

This topic tells you how to configure your Tanzu Developer Portal (formerly named Tanzu Application Platform GUI) to trust unusual certificate authorities (CA) when making outbound connections.

Tanzu Developer Portal might require custom certificates when connecting to persistent databases or custom catalog locations that require SSL. You use overlays with PackageInstalls to make this possible. There are two ways to implement this workaround: you can add a custom CA or you can deactivate all SSL verification.

Add a custom CA

The overlay previously available in this section is no longer necessary. As of Tanzu Application Platform v1.3, the value `ca_cert_data` is supported at the top level of its values file. Any number of newline-delimited CA certificates in PEM format are accepted.

For example:

```
# tap-gui-values.yaml
ca_cert_data: |
  -----BEGIN CERTIFICATE-----
  cert data here
  -----END CERTIFICATE-----

  -----BEGIN CERTIFICATE-----
  other cert data here
  -----END CERTIFICATE-----
app_config:
# ...
```

Tanzu Developer Portal also inherits `shared.ca_cert_data` from your `tap-values.yaml` file. `shared.ca_cert_data` is newline-concatenated with `ca_certs` given directly to Tanzu Developer Portal.

```
shared:
  ca_cert_data: |
    -----BEGIN CERTIFICATE-----
    cert data here
    -----END CERTIFICATE-----

tap_gui:
  ca_cert_data: |
    -----BEGIN CERTIFICATE-----
    other cert data here
    -----END CERTIFICATE-----
  app_config:
  # ...
```

To verify that Tanzu Developer Portal has processed the custom CA certificates, check that the `ca-certs-data` volume with mount path `/etc/custom-ca-certs-data` is mounted in the Tanzu

Developer Portal server pod.

Deactivate all SSL verification

To deactivate SSL verification to allow for self-signed certificates, set the Tanzu Developer Portal pod's environment variable as `NODE_TLS_REJECT_UNAUTHORIZED=0`. When the value equals 0, certificate validation is deactivated for TLS connections.

To do this, use the `package_overlays` key in the Tanzu Application Platform values file. For instructions, see [Customize Package Installation](#).

The following YAML is an example `Secret` containing an overlay to deactivate TLS:

```
apiVersion: v1
kind: Secret
metadata:
  name: deactivate-tls-overlay
  namespace: tap-install
stringData:
  deactivate-tls-overlay.yml: |
    #@ load("@ytt:overlay", "overlay")
    #@overlay/match by=overlay.subset({"kind":"Deployment", "metadata": {"name": "server", "namespace": "NAMESPACE"}}),expects="1+"
    ---
    spec:
      template:
        spec:
          containers:
            #@overlay/match by=overlay.all,expects="1+"
            #@overlay/match-child-defaults missing_ok=True
            - env:
              - name: NODE_TLS_REJECT_UNAUTHORIZED
                value: "0"
```

Where `NAMESPACE` is the namespace in which your Tanzu Developer Portal instance is deployed. For example, `tap-gui`.

Next steps

- [Configure Application Accelerator](#)

Configure Application Accelerator

This topic describes advanced configuration options available for Application Accelerator. This includes configuring Git-Ops style deployments of accelerators and configurations for use with non-public repositories and in air-gapped environments.

Accelerators are created either using the Tanzu CLI or by applying a YAML manifest using `kubectl`. Another option is [Using a Git-Ops style configuration for deploying a set of managed accelerators](#).

Application Accelerator pulls content from accelerator source repositories using either the “Flux SourceController” or the “Tanzu Application Platform Source Controller” components. If the repository used is accessible anonymously from a public server, you do not have to configure anything additional. Otherwise, provide authentication as explained in [Using non-public repositories](#). There are also options for making these configurations easier explained in [Configuring tap-values.yaml with Git credentials secret](#)

Using a Git-Ops style configuration for deploying a set of managed accelerators

To enable a Git-Ops style of managing resources used for deploying accelerators, there is a new set of properties for the Application Accelerator configuration. The resources are managed using a Carvel kapp-controller App in the `accelerator-system` namespace that watches a Git repository containing the manifests for the accelerators. This means that you can make changes to the manifests, or to the accelerators they point to, and the changes are reconciled and reflected in the deployed resources.

You can specify the following accelerator configuration properties when installing the Application Accelerator. The same properties are provided in the `accelerator` section of the `tap-values.yaml` file:

```

accelerator:
  managed_resources:
    enable: true
  git:
    url: GIT-REPO-URL
    ref: origin/main
    sub_path: null
    secret_ref: git-credentials

```

Where:

- `GIT-REPO-URL` is the URL of a Git repository that contains manifest YAML files for the accelerators that you want to have managed. The URL must start with `https://` or `git@`. You can specify a `sub_path` if necessary and also a `secret_ref` if the repository requires authentication. If not needed, then leave these additional properties out.

For more information, see [Configure tap-values.yaml with Git credentials secret](#) and [Creating a manifest with multiple accelerators and fragments](#) in this topic.

Functional and Organizational Considerations

Any accelerator manifest that is defined under the `GIT-REPO-URL` and optional `sub_path` is selected by the kapp-controller app. If there are multiple manifests at the defined `GIT-REPO-URL`, they are all watched for changes and displayed to the user as a merged catalog.

For example: if you have two manifests containing multiple accelerator or fragment definitions, `manifest-1.yaml`, and `manifest-2.yaml`, on the same path in the organizational considerations. The resulting catalog is (`manifest-1.yaml + manifest-2.yaml`).

Examples for creating accelerators

A minimal example for creating an accelerator

A minimal example might look like the following manifest:

`spring-cloud-serverless.yaml`

```

apiVersion: accelerator.apps.tanzu.vmware.com/v1alpha1
kind: Accelerator
metadata:
  name: spring-cloud-serverless
spec:
  git:
    url: https://github.com/vmware-tanzu/application-accelerator-samples
    subPath: spring-cloud-serverless
    ref:
      branch: main

```

This example creates an accelerator named `spring-cloud-serverless`. The `displayName`, `description`, `iconUrl`, and `tags` text boxes are populated based on the content under the `accelerator` key in the `accelerator.yaml` file found in the `main` branch of the Git repository at [Application Accelerator Samples](#) under the sub-path `spring-cloud-serverless`. For example:

`accelerator.yaml`

```

accelerator:
  displayName: Spring Cloud Serverless
  description: A simple Spring Cloud Function serverless app
  iconUrl: https://raw.githubusercontent.com/vmware-tanzu/application-accelerator-samples/main/icons/icon-cloud.png
  tags:
    - java
    - spring
    - cloud
    - function
    - serverless
    - tanzu
  ...

```

To create this accelerator with `kubectl`, run:

```
kubectl apply --namespace --accelerator-system --filename spring-cloud-serverless.yaml
```

Or, you can use the Tanzu CLI and run:

```
tanzu accelerator create spring-cloud-serverless --git-repo https://github.com/vmware-tanzu/application-accelerator-samples.git --git-branch main --git-sub-path spring-cloud-serverless
```

An example for creating an accelerator with customized properties

You can specify the `displayName`, `description`, `iconUrl`, and `tags` text boxes and this overrides any values provided in the accelerator's Git repository. The following example explicitly sets those text boxes and the `ignore` text box:

`my-spring-cloud-serverless.yaml`

```

apiVersion: accelerator.apps.tanzu.vmware.com/v1alpha1
kind: Accelerator
metadata:
  name: my-spring-cloud-serverless
spec:
  displayName: My Spring Cloud Serverless
  description: My own Spring Cloud Function serverless app
  iconUrl: https://raw.githubusercontent.com/vmware-tanzu/application-accelerator-samples/main/icons/icon-cloud.png
  tags:
    - spring
    - cloud
    - function
    - serverless
  git:
    ignore: ".git/, bin/"
    url: https://github.com/vmware-tanzu/application-accelerator-samples
    subPath: spring-cloud-serverless
    ref:
      branch: test

```

To create this accelerator with `kubectl`, run:

```
kubectl apply --namespace --accelerator-system --filename my-spring-cloud-serverless.yaml
```

To use the Tanzu CLI, run:

```
tanzu accelerator create my-spring-cloud-serverless --git-repo https://github.com/vmware-tanzu/application-accelerator-samples --git-branch main --git-sub-path spring-cloud-serverless \
--description "My own Spring Cloud Function serverless app" \
--display-name "My Spring Cloud Serverless" \
--icon-url https://raw.githubusercontent.com/vmware-tanzu/application-accelerator-samples/main/icons/icon-cloud.png \
--tags "spring,cloud,function,serverless"
```



Note

It is not possible to provide the `git.ignore` option with the Tanzu CLI.

Creating a manifest with multiple accelerators and fragments

You might have a manifest that contains multiple accelerators or fragments. For example:

`accelerator-collection.yaml`

```
---
apiVersion: accelerator.apps.tanzu.vmware.com/v1alpha1
kind: Accelerator
metadata:
  name: spring-cloud-serverless
spec:
  git:
    url: https://github.com/vmware-tanzu/application-accelerator-samples
    subPath: spring-cloud-serverless
    ref:
      branch: main
---
apiVersion: accelerator.apps.tanzu.vmware.com/v1alpha1
kind: Accelerator
metadata:
  name: tanzu-java-web-app
spec:
  git:
    url: https://github.com/vmware-tanzu/application-accelerator-samples.git
    subPath: tanzu-java-web-app
    ref:
      branch: main
```

For a larger example of this, see [Sample Accelerators Main](#). Optionally, use this to create an initial catalog of accelerators and fragments during a fresh Application Accelerator install.

Configure `tap-values.yaml` with Git credentials secret



Note

For how to create a new OAuth Token for optional Git repository creation, see [Create an Application Accelerator Git repository during project creation](#).

When deploying accelerators using Git repositories that requires authentication or are installed with custom CA certificates, you must provide some additional authentication values in a secret. The examples in the next section provide more details. This section describes how to configure a Git credentials secret that is used in later Git-based examples.

You can specify the following accelerator configuration properties when installing Application Accelerator. The same properties are provided in the `accelerator` section of the `tap-values.yaml` file:

```

accelerator:
  git_credentials:
    secret_name: git-credentials
    username: GIT-USER-NAME
    password: GIT-CREDENTIALS
    ca_file: CUSTOM-CA-CERT

```

Where:

- `GIT-USER-NAME` is the user name for authenticating with the Git repository.
- `GIT-CREDENTIALS` is the password or access token used for authenticating with the Git repository. VMware recommends using an access token for this.
- `CUSTOM-CA-CERT` is the certificate data needed when accessing the Git repository.

This is an example of this part of a `tap-values.yaml` configuration:

```

accelerator:
  git_credentials:
    secret_name: git-credentials
    username: testuser
    password: s3cret
    ca_file: |
      -----BEGIN CERTIFICATE-----
      .
      .
      . < certificate data >
      .
      .
      -----END CERTIFICATE-----

```

You can specify the custom CA certificate data using the shared config value `shared.ca_cert_data` and it propagates to all components that can make use of it, including the App Accelerator configuration. The example earlier produces an output such as this using the shared value:

```

shared:
  ca_cert_data: |
    -----BEGIN CERTIFICATE-----
    .
    .
    . < certificate data >
    .
    .
    -----END CERTIFICATE-----

accelerator:
  git_credentials:
    secret_name: git-credentials
    username: testuser
    password: s3cret

```

Using non-public repositories

For GitHub repositories that aren't accessible anonymously, you must provide credentials in a Secret.

- For HTTPS repositories the secret must contain user name and password fields. The password field can contain a personal access token instead of an actual password. For more information, see [Fluxcd/source-controller basic access authentication](#).
- For HTTPS with self-signed certificates, you can add a `.data.caFile` value to the secret created for HTTPS authentication. For more information, see [fluxcd/source-controller HTTPS Certificate Authority](#).
- For SSH repositories, the secret must contain identity, identity.pub, and known_hosts text boxes. For more information, see [fluxcd/source-controller SSH authentication](#).
- For Image repositories that aren't publicly available, an image pull secret might be provided. For more information, see [Kubernetes documentation on using imagePullSecrets](#).

Examples for a private Git repository

Example using http credentials

To create an accelerator using a private Git repository, first create a secret with the HTTP credentials.



Note

For better security, use an access token as the password.

```
kubectl create secret generic https-credentials \
  --namespace accelerator-system \
  --from-literal=username=<user> \
  --from-literal=password=<access-token>
```

Verify that your secret was created by running:

```
kubectl get secret --namespace accelerator-system https-credentials -o yaml
```

The output is similar to:

```
apiVersion: v1
kind: Secret
metadata:
  name: https-credentials
  namespace: accelerator-system
type: Opaque
data:
  username: <BASE64>
  password: <BASE64>
```

After you created and verified the secret, you can create the accelerator by using the `spec.git.secretRef.name` property:

`private-acc.yaml`

```
apiVersion: accelerator.apps.tanzu.vmware.com/v1alpha1
kind: Accelerator
metadata:
  name: private-acc
spec:
  displayName: private
```

```
description: Accelerator using a private repository
git:
  url: REPOSITORY-URL
  ref:
    branch: main
  secretRef:
    name: https-credentials
```

For https credentials, the `REPOSITORY-URL` must use `https://` as the URL scheme.

If you are using the Tanzu CLI, add the `--secret-ref` flag to your `tanzu accelerator create` command and provide the name of the secret for that flag.

Example using http credentials with self-signed certificate

To create an accelerator using a private Git repository with a self-signed certificate, create a secret with the HTTP credentials and the certificate.



Note

For better security, use an access token as the password.

```
kubectl create secret generic https-ca-credentials \
  --namespace accelerator-system \
  --from-literal=username=<user> \
  --from-literal=password=<access-token> \
  --from-file=caFile=<path-to-CA-file>
```

Verify that your secret was created by running:

```
kubectl get secret --namespace accelerator-system https-ca-credentials -o yaml
```

The output is similar to:

```
apiVersion: v1
kind: Secret
metadata:
  name: https-ca-credentials
  namespace: accelerator-system
type: Opaque
data:
  username: <BASE64>
  password: <BASE64>
  caFile: <BASE64>
```

After you have the secret created, you can create the accelerator by using the `spec.git.secretRef.name` property:

`private-acc.yaml`

```
apiVersion: accelerator.apps.tanzu.vmware.com/v1alpha1
kind: Accelerator
metadata:
  name: private-acc
spec:
  displayName: private
  description: Accelerator using a private repository
  git:
    url: REPOSITORY-URL
    ref:
      branch: main
```

```
secretRef:
  name: https-ca-credentials
```



Important

For https credentials, the `REPOSITORY-URL` must use `https://` as the URL scheme.

If you are using the Tanzu CLI, add the `--secret-ref` flag to your `tanzu accelerator create` command and provide the name of the secret for that flag.

Example using SSH credentials

To create an accelerator using a private Git repository, create a secret with the SSH credentials such as this example:

```
ssh-keygen -q -N "" -f ./identity
ssh-keyscan github.com > ./known_hosts
kubectl create secret generic ssh-credentials \
  --namespace accelerator-system \
  --from-file=./identity \
  --from-file=./identity.pub \
  --from-file=./known_hosts
```

If you have a key file already created, skip the `ssh-keygen` and `ssh-keyscan` steps and replace the values for the `kubectl create secret` command. Such as:

- `--from-file=identity=<path to your identity file>`
- `--from-file=identity.pub=<path to your identity.pub file>`
- `--from-file=known_hosts=<path to your know_hosts file>`

Verify that your secret was created by running:

```
kubectl get secret --namespace accelerator-system ssh-credentials -o yaml
```

The output is similar to :

```
apiVersion: v1
kind: Secret
metadata:
  name: ssh-credentials
  namespace: accelerator-system
type: Opaque
data:
  identity: <BASE64>
  identity.pub: <BASE64>
  known_hosts: <BASE64>
```

To use this secret when creating an accelerator, provide the secret name in the `spec.git.secretRef.name` property:

`private-acc-ssh.yaml`

```
apiVersion: accelerator.apps.tanzu.vmware.com/v1alpha1
kind: Accelerator
metadata:
  name: private-acc
spec:
  displayName: private
  description: Accelerator using a private repository
```

```
git:
  url: REPOSITORY-URL
  ref:
    branch: main
  secretRef:
    name: ssh-credentials
```

When using SSH credentials, the `REPOSITORY-URL` must include the user name as part of the URL. For example: `ssh://user@example.com:22/repository.git`. For more information, see [Flux documentation](#).

If you are using the Tanzu CLI, add the `--secret-ref` flag to your `tanzu accelerator create` command and provide the name of the secret for that flag.

Examples for a private source-image repository

If your registry uses a self-signed certificate then you must add the CA certificate data to the configuration for the “Tanzu Application Platform Source Controller” component. Add it under `source_controller.ca_cert_data` in your `tap-values.yaml` file that is used during installation.

`tap-values.yaml`

```
source_controller:
  ca_cert_data: |-
    -----BEGIN CERTIFICATE-----
    .
    .
    . < certificate data >
    .
    .
    -----END CERTIFICATE-----
```

Example using image-pull credentials

To create an accelerator using a private source-image repository, create a secret with the image-pull credentials:

```
create secret generic registry-credentials \
  --namespace accelerator-system \
  --from-literal=username=<user> \
  --from-literal=password=<password>
```

Verify that your secret was created by running:

```
kubectl get secret --namespace accelerator-system registry-credentials -o yaml
```

The output is similar to:

```
apiVersion: v1
kind: Secret
metadata:
  name: registry-credentials
  namespace: accelerator-system
type: Opaque
data:
  username: <BASE64>
  password: <BASE64>
```

After you have the secret created, you can create the accelerator by using the `spec.git.secretRef.name` property:

`private-acc.yaml`

```

apiVersion: accelerator.apps.tanzu.vmware.com/v1alpha1
kind: Accelerator
metadata:
  name: private-acc
spec:
  displayName: private
  description: Accelerator using a private repository
  source:
    image: "registry.example.com/test/private-acc-src:latest"
    imagePullSecrets:
      - name: registry-credentials

```

If you are using the Tanzu CLI, add the `--secret-ref` flag to your `tanzu accelerator create` command and provide the name of the secret for that flag.

Configure ingress timeouts when some accelerators take longer to generate

If Tanzu Application Platform is configured to use an ingress for Tanzu Developer Portal and the Accelerator Server, then it might detect a timeout during accelerator generation. This can happen if the accelerator takes a longer time to generate than the default timeout. When this happens, Tanzu Developer Portal appears to continue to run for an indefinite period. In the IDE extension, it shows a 504 error. To mitigate this, you can increase the timeout value for the HTTPProxy resources used for the ingress by applying secrets with overlays to edit the HTTPProxy resources.

Configure an ingress timeout overlay secret for each HTTPProxy

For Tanzu Developer Portal, create the following overlay secret in the `tap-install` namespace:

```

apiVersion: v1
kind: Secret
metadata:
  name: patch-tap-gui-timeout
  namespace: tap-install
stringData:
  patch.yaml: |
    #@ load("@ytt:overlay", "overlay")
    #@overlay/match by=overlay.subset({"kind": "HTTPProxy", "metadata": {"name": "tap-gui"}})
    ---
    spec:
      routes:
        #@overlay/match by=overlay.subset({"services": [{"name": "server"}]})
        #@overlay/match-child-defaults missing_ok=True
        - timeoutPolicy:
            idle: 30s
            response: 30s

```

For Accelerator Server (used for IDE extension), create the following overlay secret in the `tap-install` namespace:

```

apiVersion: v1
kind: Secret
metadata:
  name: patch-accelerator-timeout
  namespace: tap-install
stringData:
  patch.yaml: |
    #@ load("@ytt:overlay", "overlay")

```



```
#@overlay/match by=overlay.subset({"kind": "HTTPProxy", "metadata": {"name": "accelerator"}})
---
spec:
  routes:
    #@overlay/match by=overlay.subset({"services": [{"name": "acc-server"}]})
    #@overlay/match-child-defaults missing_ok=True
    - timeoutPolicy:
        idle: 30s
        response: 30s
```

Apply the timeout overlay secrets in tap-values.yaml

Add the following `package_overlays` section to `tap-values.yaml` before installing or updating Tanzu Application Platform:

```
package_overlays:
- name: tap-gui
  secrets:
  - name: patch-tap-gui-timeout
- name: accelerator
  secrets:
  - name: patch-accelerator-timeout
```

Configuring skipping TLS verification for access to Source Controller

You can configure the Flux or Tanzu Application Platform Source Controller to use Transport Layer Security (TLS) and use custom certificates. In that case, configure the Accelerator System to skip the TLS verification for calls to access the sources by providing the following property in the `accelerator` section of the `tap-values.yaml` file:

```
sources:
  skip_tls_verify: true
```

Enabling TLS for Accelerator Server

To enable TLS for the Accelerator Server, the following properties must be provided in the `accelerator` section of the `tap-values.yaml` file:

```
server:
  tls:
    enabled: true
    key: SERVER-PRIVATE-KEY
    crt: SERVER-CERTIFICATE
```

Where:

- `SERVER-PRIVATE-KEY` is the pem encoded server private key.
- `SERVER-CERTIFICATE` is the pem encoded server certificate.

Here is a sample `tap-values.yaml` configuration with TLS enabled for Accelerators Server:

```
server:
  tls:
    enabled: true
    key: |
      -----BEGIN PRIVATE KEY-----
      .
```

```

. < private key data >
.
-----END PRIVATE KEY-----
cert: |
-----BEGIN CERTIFICATE-----
.
. < certificate data >
.
-----END CERTIFICATE-----

```

Configuring skipping TLS verification of Engine calls for Accelerator Server

If you configure the Accelerator Engine to use TLS and use custom certificates, then you can configure the Accelerator Server to skip the TLS verification for calls to the Engine by providing the following property in the `accelerator` section of the `tap-values.yaml` file:

```

server:
  engine_skip_tls_verify: true

```

Enabling TLS for Accelerator Engine

To enable TLS for the Accelerator Engine, the following properties are provided in the `accelerator` section of the `tap-values.yaml` file:

```

engine:
  tls:
    enabled: true
    key: ENGINE-PRIVATE-KEY
    crt: ENGINE-CERTIFICATE

```

Where:

- `ENGINE-PRIVATE-KEY` is the pem encoded acc-engine private key.
- `ENGINE-CERTIFICATE` is the pem encoded acc-engine certificate.

Here is a sample `tap-values.yaml` configuration with TLS enabled for Accelerators Engine:

```

engine:
  tls:
    enabled: true
    key: |
      -----BEGIN PRIVATE KEY-----
      .
      . < private key data >
      .
      -----END PRIVATE KEY-----
    crt: |
      -----BEGIN CERTIFICATE-----
      .
      . < certificate data >
      .
      -----END CERTIFICATE-----

```

Next steps

- [Using Grype in offline and air-gapped environments](#)

Use Grype in offline and air-gapped environments

The `grype` CLI attempts to perform two over the Internet calls:

- One to verify for later versions of the CLI.
- One to update the vulnerability database before scanning.

For the `grype` CLI to function in an offline or air-gapped environment, the vulnerability database must be hosted within the environment. You must configure the `grype` CLI with the internal URL.

The `grype` CLI accepts environment variables to satisfy these needs.

Host the Grype vulnerability database

To host Grype's vulnerability database in an air-gapped environment:

1. Retrieve Grype's listing file from its public endpoint: <https://toolbox-data.anchore.io/grype/databases/listing.json>.
2. Create your own `listing.json` file.

Note Different Grype versions require specific database schema versions. To avoid compatibility issues between different versions, include a database schema for each version. For example:

```
{
  "available": {
    "1": [
      {
        "built": "2023-06-16T01:33:30Z",
        "version": 1,
        "url": "https://toolbox-data.anchore.io/grype/databases/vulnerability-db_v1_2023-06-16T01:33:30Z_1621f4169ffd15bea9e5.tar.gz",
        "checksum": "sha256:3f2c1b432945cca9a69b2e604f6fb231fec450fdd27f4946fc5608692b63a9d1"
      }
    ],
    "2": [
      {
        "built": "2023-06-16T01:33:30Z",
        "version": 2,
        "url": "https://toolbox-data.anchore.io/grype/databases/vulnerability-db_v2_2023-06-16T01:33:30Z_d6eee5e78d9b78285e1a.tar.gz",
        "checksum": "sha256:7b7e3a2a7712c72b8c5cc777733c4d8d140d8cfee65e4f04540abbdfe3ef1f65"
      }
    ],
    "3": [
      {
        "built": "2023-06-16T01:33:30Z",
        "version": 3,
        "url": "https://toolbox-data.anchore.io/grype/databases/vulnerability-db_v3_2023-06-16T01:33:30Z_f96ae38a7b05987c3ece.tar.gz",
        "checksum": "sha256:8ea9fae3fda3bf3bf35bd5e5eb656fc127b59cd3c42db4c36795556aab8a9cf0"
      }
    ],
    "4": [
      {
        "built": "2023-06-16T01:33:30Z",
        "version": 4,
        "url": "https://toolbox-data.anchore.io/grype/databases/vulnerability-db_v4_2023-06-16T01:33:30Z_13bba2fa8ff62b7f8b26.tar.gz",
        "checksum": "sha256:3b53d20241b88e5aa45feb817b325c53d6efbe9falfc5a6"
      }
    ]
  }
}
```

```

7eeddaecaafa7687e0"
    }
  ],
  "5": [
    {
      "built": "2023-06-16T01:33:30Z",
      "version": 5,
      "url": "https://toolbox-data.anchore.io/grype/databases/vulnerability-db_v5_2023-06-16T01:33:30Z_e07da3853f6db6eb1104.tar.gz",
      "checksum": "sha256:93d4d9d2f9e39f86570f832cf85b7149a949ca6f1613581b10c12393509d884f"
    }
  ]
}
}
}

```

Where `url` points to a tarball containing Grype's `vulnerability`, `db`, and `metadata.json` files.

- Download and host the tarballs in your internal file server.



Note

Some storage solutions for internal file servers change the name of TAR files automatically because of their limits. Notice these modified names and reflect the changes in the `url`. Ensure that the timestamp in the name is correctly formatted because Grype parses the name of TAR artifact to get the timestamp.

- Update the download `url` to point at your internal endpoint.

For information about setting up an offline vulnerability database, see the [Anchore Grype README](#) in GitHub.

To enable Grype in offline air-gapped environments

- Add the following to your `tap-values.yaml` file:

```

grype:
  db:
    dbUpdateUrl: INTERNAL-VULN-DB-URL

```

Where `INTERNAL-VULN-DB-URL` is the URL that points to the internal file server.

- Update Tanzu Application Platform:

```
tanzu package installed update tap -f tap-values.yaml -n tap-install
```

Configure Grype environmental variables

- Create a secret that contains the ytt overlay to add the Grype environment variable to the ScanTemplates.

```

apiVersion: v1
kind: Secret
metadata:
  name: grype-airgap-environmental-variables
  namespace: tap-install
stringData:
  patch.yaml: |

```

```

#@ load("@ytt:overlay", "overlay")

#@overlay/match by=overlay.subset({"kind":"ScanTemplate"}),expects="1+"
---
spec:
  template:
    initContainers:
      #@overlay/match by=overlay.subset({"name": "scan-plugin"}), expects
      ="1+"
      - name: scan-plugin
        #@overlay/match missing_ok=True
        env:
          #@overlay/append
          - name: GRYPE_CHECK_FOR_APP_UPDATE
            value: "false"

```

Where `spec.template.initContainers[]` specifies setting one or more environment variables in the `scan-plugin` `initContainer`.



Note

If you are using the Namespace Provisioner to provision a new developer namespace and want to apply a package overlay for Grype, you must import the overlay `Secret`. See [Import overlay secrets](#).

Troubleshooting

ERROR failed to fetch latest cli version



Note

This message is a warning and the Grype scan still runs with this message.

The Grype CLI checks for later versions of the CLI by contacting the anchore endpoint over the Internet.

```

ERROR failed to fetch latest version: Get "https://toolbox-data.anchore.io/grype/releases/latest/VERSION": dial tcp: lookup toolbox-data.anchore.io on [::1]:53: read udp [::1]:65010->[::1]:53: read: connection refused

```

Solution

To deactivate this check, set the environment variable `GRYPE_CHECK_FOR_APP_UPDATE` to `false` by using a package overlay with the following steps:

1. Create a secret that contains the ytt overlay to add the Grype environment variable to the `ScanTemplates`.

```

apiVersion: v1
kind: Secret
metadata:
  name: grype-airgap-deactivate-cli-check-overlay
  namespace: tap-install #! namespace where tap is installed
stringData:
  patch.yaml: |
    #@ load("@ytt:overlay", "overlay")

```

```

#@overlay/match by=overlay.subset({"kind":"ScanTemplate"}),expects="1+"
---
spec:
  template:
    initContainers:
      #@overlay/match by=overlay.subset({"name": "scan-plugin"}), expects
      = "1+"
      - name: scan-plugin
        #@overlay/match missing_ok=True
        env:
          #@overlay/append
          - name: GRYPE_CHECK_FOR_APP_UPDATE
            value: "false"

```

2. Configure `tap-values.yaml` to use `package_overlays`. Add the following to your `tap-values.yaml` file:

```

package_overlays:
  - name: "grype"
  secrets:
    - name: "grype-airgap-deactivate-cli-check-overlay"

```

3. Update Tanzu Application Platform:

```
tanzu package installed update tap -f tap-values.yaml -n tap-install
```

Database is too old

```

1 error occurred:
 * db could not be loaded: the vulnerability database was built N days/weeks ago (max
allowed age is 5 days)

```

Grype needs up-to-date vulnerability information to provide accurate matches. By default, it fails to run if the local database was not built in the last 5 days.

Solution

Two options to resolve this:

1. Stale databases weaken your security posture. VMware recommends updating the database daily as the first recommended solution.
2. If updating the database daily is not an option, the data staleness check is configurable by using the environment variable `GRYPE_DB_MAX_ALLOWED_BUILT_AGE` and is addressed using a package overlay with the following steps:
 1. Create a secret that contains the ytt overlay to add the Grype environment variable to the ScanTemplates.

```

apiVersion: v1
kind: Secret
metadata:
  name: grype-airgap-override-stale-db-overlay
  namespace: tap-install #! namespace where tap is installed
stringData:
  patch.yaml: |
    #@ load("@ytt:overlay", "overlay")

    #@overlay/match by=overlay.subset({"kind":"ScanTemplate"}),expects="1
    +"
    ---
    spec:

```

```

template:
  initContainers:
    #@overlay/match by=overlay.subset({"name": "scan-plugin"}), ex
    pects="1+"
    - name: scan-plugin
      #@overlay/match missing_ok=True
      env:
        #@overlay/append
        - name: GRYPE_DB_MAX_ALLOWED_BUILT_AGE #! see note on best
          practices
            value: "120h"

```



Note

The default maximum allowed built age of Grype's vulnerability database is 5 days. This means that scanning with a 6 day old database causes the scan to fail. You can use the `GRYPE_DB_MAX_ALLOWED_BUILT_AGE` parameter to override the default in accordance with your security posture.

2. Configure `tap-values.yaml` to use `package_overlays`. Add the following to your `tap-values.yaml` file:

```

package_overlays:
  - name: "grype"
    secrets:
      - name: "grype-airgap-override-stale-db-overlay"

```

3. Update Tanzu Application Platform:

```
tanzu package installed update tap -f tap-values.yaml -n tap-install
```

Vulnerability database is invalid

```

scan-pod[scan-plugin] 1 error occurred:
scan-pod[scan-plugin] * failed to load vulnerability db: vulnerability database is in
valid (run db update to correct): database metadata not found: /.cache/grype/db/5

```

Solution

Examine the `listing.json` file you created. This matches the format of the listing file. The listing file is located at Anchore Grype's public endpoint. See the [Grype README.md](#) in GitHub.

An example `listing.json`:

```

{
  "available": {
    "5": [
      {
        "built": "2023-03-28T01:29:38Z",
        "version": 5,
        "url": "https://toolbox-data.anchore.io/grype/databases/vulnerability-db_v5_20
23-03-28T01:29:38Z_e49d318c32a6113eed07.tar.gz",
        "checksum": "sha256:408ce2932f04dee929a5df524e92494f2d635c6b19e30ff9f0a50425b1
fc29a1"
      },
      .....
    ]
  }
}

```

```
}
}
```

Where:

- `5` refers to the Grype's vulnerability database schema.
- `built` is the build timestamp in the format `yyyy-MM-ddTHH:mm:ssZ`.
- `url` is the download URL for the tarball containing the database. This points at your internal endpoint. The tarball contains the following files:
 - `vulnerability.db` is an SQLite file that is Grype's vulnerability database. Each time the data shape of the vulnerability database changes, a new schema is created. Different Grype versions require specific database schema versions. For example, Grype `v0.54.0` requires database schema version `v5`.
 - `metadata.json` file
- `checksum` is the SHA used to verify the database's integrity.

Verify these possible reasons why the vulnerability database is not valid:

1. The database schema is invalid. Confirm that the required database schema for the installed Grype version is used. Confirm that the top level version key matches the nested `version`. For example, the top level version `1` in the following snippet does not match the nested `version: 5`.

```
{
  "available": {
    "1": [{
      "built": "2023-02-08T08_17_20Z",
      "version": 5,
      "url": "https://INTERNAL-ENDPOINT/PATH-TO-TARBALL/vulnerability-db_v
5_2023-02-08T08_17_20Z_6ef73016d160043c630f.tar.gz",
      "checksum": "sha256:aab8d369933c845878ef1b53bb5c26ee49b91ddc5cd87c9e
b57ffb203a88a72f"
    }]
  }
}
```

Where `PATH-TO-TARBALL` is the path to the tarball containing the vulnerability database.

As stale databases weaken your security posture, VMware recommends using the newest entry of the relevant schema version in the `listing.json` file. See Anchore's [grype-db](#) in GitHub.

2. The `built` parameters in the `listing.json` file are incorrectly formatted. The proper format is `yyyy-MM-ddTHH:mm:ssZ`.
3. The `url` that you modified to point at an internal endpoint is not reachable from within the cluster. For information about verifying connectivity, see [Debug Grype database in a cluster](#).
4. Verify if there are syntax errors in the `listing.json`:

```
grype db check
```

5. Validate the configured `listing.json`:

```
grype db list -o raw
```

Debug Grype database in a cluster

- Describe the failed source scan or image scan to verify the name of the ScanTemplate being used.

- For `sourcescan`, run:

```
kubectl describe sourcescan SCAN-NAME -n DEV-NAMESPACE
```

- For `imagescan`, run:

```
kubectl describe imagescan SCAN-NAME -n DEV-NAMESPACE
```

Where `SCAN-NAME` is the name of the source or image scan that failed.

- Pause reconciliation of the `grype.scanning.apps.tanzu.vmware.com` package:

```
kctrl package installed pause -i <PACKAGE-INSTALL-NAME> -n tap-install
```

Where `PACKAGE-INSTALL-NAME` is the name of the `grype.scanning.apps.tanzu.vmware.com` package (e.g. `grype`)

- Edit the ScanTemplate's `scan-plugin` container to include a "sleep" entrypoint which allows you to troubleshoot inside the container:

```
- name: scan-plugin
  volumeMounts:
    ...
  image: #@ data.values.scanner.image
  imagePullPolicy: IfNotPresent
  env:
    ...
  command: ["/bin/bash"]
  args:
    - "sleep 1800" # insert 30 min sleep here
```

- Re-run the scan.
- Get the name of the `scan-plugin` pod.

```
kubectl get pods -n DEV-NAMESPACE
```

- Get a shell to the container.

```
kubectl exec --stdin --tty SCAN-PLUGIN-POD -c step-scan-plugin -- /bin/bash
```

Where `SCAN-PLUGIN-POD` is the name of the `scan-plugin` pod. For more information, see the [Kubernetes documentation](#).

- Inside the container, run Grype CLI commands to report database status and verify connectivity from the cluster to the mirror. See the [Grype documentation](#) in GitHub.
 - Report current status of Grype's database, such as location, build date, and checksum:

```
grype db status
```

- Ensure that the built parameters in the `listing.json` has timestamps in this proper format `yyyy-MM-ddTHH:mm:ssZ`.
- After you complete troubleshooting, use the following command to trigger reconciliation:

```
kctrl package installed kick -i <PACKAGE-INSTALL-NAME> -n tap-install
```

Where `PACKAGE-INSTALL-NAME` is the name of the `grype.scanning.apps.tanzu.vmware.com` package, such as Grype.

Grype package overlays are not applied to scantemplates created by Namespace Provisioner

If you used the Namespace Provisioner to provision a new developer namespace and want to apply a package overlay for Grype, see [Import overlay secrets](#).

Set up developer namespaces to use your installed packages

For details about how to automatically set up your developer namespaces, see [Provision developer namespaces in Namespace Provisioner](#).

Additional configuration for testing and scanning

If you plan to install or have already installed Out of the Box Supply Chains with Testing and Scanning, you can use Namespace Provisioner to set up the required resources. For more information, see [Customize installation](#) in the Namespace Provisioner documentation for configuration steps.

Legacy namespace setup

To use the legacy manual process for setting up developer namespaces, see [Legacy namespace setup](#).

Next steps

For more information about the Namespace Provisioner mode, see [Work with Git repositories in air-gapped environments with Namespace Provisioner](#).

For more information about the manual mode, see [Deploy an air-gapped workload](#).

Install IDE extensions in your air-gapped environment

This topic tells you how to install IDE extensions in your air-gapped environment.

To install VS Code or IntelliJ extensions in an air-gapped environment, you cannot use IDE's built-in UI, because it downloads and install extensions directly from VS Code or IntelliJ Marketplace.

The following are high-level steps to install IDE extensions in your air-gapped environment:

1. Outside the air-gapped environment:
 1. Download the extension as an archive from VS Code or IntelliJ Marketplace.
 2. Copy the extension to a location that is accessible from within the air-gapped environment.
2. In the air-gapped environment:
 1. Install the extension into the IDE by using the archive generated earlier.

Install VS Code in your air-gapped environment

Follow these steps to retrieve the `.vsix` archive and install VS Code in your air-gapped environment:

1. Find the extension you want to install on VS Code Marketplace. For example:
 - [Tanzu Developer Tools for Vscode](#)
 - [Tanzu App Accelerator for Vscode](#)

2. In a column on the right side of the screen, under **Resources**, click the **Download Extension** link.

A file called `vmware.tanzu-dev-tools-${version}.vsix` is downloaded.

3. Save the file to a location that is accessible from your air-gapped environment. For example, a USB drive.
4. Repeat these steps for all extensions you want to install, including any dependencies.

For example, Tanzu Developer Tools for VS Code requires all of the following extensions as dependencies:

- [Red Hat Java](#)
- [Red Hat Yaml](#)
- [Debugger for Java](#)

The Application Accelerator extension, on the other hand, does not require additional dependencies.

5. In your air-gapped environment, install VS Code extensions as follows:
 1. Open VS Code
 2. Open the command palette by pressing CTRL-SHIFT-P or CMD-SHIFT-P on Mac.
 3. In the search box, type **vsix** and select **Install from VSIX...**

You can script this step by using commands such as:

```
code --install-extension ${path_to_vsix_file}
```

Install IntelliJ in your air-gapped environment

Follow these steps to retrieve the `.zip` archive and install IntelliJ in your air-gapped environment:

1. Find the extension you want to install on [Jetbrains Marketplace](#). For example, [Tanzu Developer Tools for IntelliJ](#).
2. Click **Get** near the top-right of the screen.
3. Find the version you want to download and click the **Download** link.

A file called `Tanzu_Developer_Tools-${version}.zip` is downloaded.
4. Save the file to a location that is accessible from your air-gapped environment. For example, a USB drive.
5. Repeat these steps for all extensions you want to install.
6. Follow the instructions in the [IntelliJ documentation](#) to install IntelliJ.

Install Tanzu Application Platform (AWS)

You can install Tanzu Application Platform (commonly known as TAP) on [Amazon Elastic Kubernetes Services \(EKS\)](#) by using [Amazon Elastic Container Registry \(ECR\)](#).

To install, take the following steps.

Step	Task	Link
1.	Review the prerequisites to ensure that you have set up everything required before beginning the installation	Prerequisites
2.	Install the Tanzu CLI	Install the Tanzu CLI
3.	Create AWS Resources (EKS Cluster, roles, etc)	Create AWS Resources
4.	Install Cluster Essentials for Tanzu	Deploy Cluster Essentials
5.	Add the Tanzu Application Platform package repository, prepare your Tanzu Application Platform profile, and install the profile to the cluster	Install the Tanzu Application Platform package and profiles
6.	(Optional) Install any additional packages that were not in the profile	Install individual packages
7.	Set up developer namespaces to use your installed packages	Set up developer namespaces to use your installed packages
8.	Install developer tools into your integrated development environment (IDE)	Install Tanzu Developer Tools for your VS Code

After installing Tanzu Application Platform on your Kubernetes clusters, [get started with Tanzu Application Platform](#) and create your ECR repositories for your workload, such as `tanzu-application-platform/tanzu-java-web-app-default`, `tanzu-application-platform/tanzu-java-web-app-default-bundle`, and `tanzu-application-platform/tanzu-java-web-app-default-source`.

Install Tanzu Application Platform (AWS)

You can install Tanzu Application Platform (commonly known as TAP) on [Amazon Elastic Kubernetes Services \(EKS\)](#) by using [Amazon Elastic Container Registry \(ECR\)](#).

To install, take the following steps.

Step	Task	Link
1.	Review the prerequisites to ensure that you have set up everything required before beginning the installation	Prerequisites
2.	Install the Tanzu CLI	Install the Tanzu CLI
3.	Create AWS Resources (EKS Cluster, roles, etc)	Create AWS Resources
4.	Install Cluster Essentials for Tanzu	Deploy Cluster Essentials
5.	Add the Tanzu Application Platform package repository, prepare your Tanzu Application Platform profile, and install the profile to the cluster	Install the Tanzu Application Platform package and profiles
6.	(Optional) Install any additional packages that were not in the profile	Install individual packages
7.	Set up developer namespaces to use your installed packages	Set up developer namespaces to use your installed packages
8.	Install developer tools into your integrated development environment (IDE)	Install Tanzu Developer Tools for your VS Code

After installing Tanzu Application Platform on your Kubernetes clusters, [get started with Tanzu Application Platform](#) and create your ECR repositories for your workload, such as `tanzu-application-platform/tanzu-java-web-app-default`, `tanzu-application-platform/tanzu-java-web-app-default-bundle`, and `tanzu-application-platform/tanzu-java-web-app-default-source`.

Create AWS Resources for Tanzu Application Platform

To install Tanzu Application Platform (commonly known as TAP) within the Amazon Web Services (AWS) Ecosystem, you must create several AWS resources. Use this topic to learn how to create:

- An Amazon Elastic Kubernetes Service (EKS) cluster to install Tanzu Application Platform.
- Identity and Access Management (IAM) roles to allow authentication and authorization to read and write from Amazon Elastic Container Registry (ECR).
- ECR Repositories for the Tanzu Application Platform container images. This is because AWS ECR does not support automatically creating container repositories on initial push. For more information, see the [AWS repository](#) in GitHub.

Creating these resources enables Tanzu Application Platform to use an IAM role bound to a Kubernetes service account for authentication, rather than the typical username and password stored in a Kubernetes secret strategy. For more information, see this [AWS documentation](#).

This is important when using ECR because authenticating to ECR is a two-step process:

1. Retrieve a token using your AWS credentials.
2. Use the token to authenticate to the registry.

To increase security, the token has a lifetime of 12 hours. This makes storing it as a secret for a service impractical because it has to be refreshed every 12 hours.

Using an IAM role on a service account mitigates the need to retrieve the token at all because it is handled by credential helpers within the services.

Prerequisites

There are numerous methods to manage AWS cloud resources and create EKS clusters. The method presented in the following guide was chosen for simplicity.

Before installing Tanzu Application Platform on AWS, you need:

- An AWS Account. You need to create all of your resources within Amazon Web Services, so you need an Amazon account. For more information, see [How do I create and activate a new AWS account?](#). You need your account ID for this walkthrough.
- AWS CLI. This walkthrough uses the AWS CLI to both query and configure resources in AWS, such as IAM roles. For more information, see this [AWS documentation](#).
- `eksctl` command line. The `eksctl` command line helps you manage the life cycle of EKS clusters. This guide uses it to create clusters. To install `eksctl`, see the [eksctl documentation](#).

Export environment variables

Variables are used throughout this guide. To simplify the process and minimize the opportunity for errors, export these variables:

```
export AWS_ACCOUNT_ID=012345678901
export AWS_REGION=us-west-2
export EKS_CLUSTER_NAME=tap-on-aws
```

Where:

Variable	Description
AWS_ACCOUNT_ID	Your AWS account ID
AWS_REGION	The AWS region you are going to deploy to
EKS_CLUSTER_NAME	The name of your EKS Cluster

Create an EKS cluster

To create an EKS cluster in the specified region, run:

```
eksctl create cluster --name $EKS_CLUSTER_NAME --managed --region $AWS_REGION --instance-types t3.xlarge --version 1.25 --with-oidc -N 5
```

Creating the control plane and node group can take anywhere from 30-60 minutes.



Note

This step is optional if you already have an existing EKS Cluster v1.23 or later with OpenID Connect (OIDC) authentication enabled. For more information about how to enable the OIDC provider, see [AWS documentation](#).

Install the EBS CSI driver

Tanzu Application Platform requires stateful services. Starting from EKS v1.23, the EBS CSI driver is no longer installed by default. For more information about how to install the EBS CSI driver, see the [AWS documentation](#).

Create the platform container repositories

ECR requires that the container repositories are already created for images to be pushed to them. For Tanzu Application Platform, you must create the following two repositories:

- A repository to store the Tanzu Application Platform service container images
- A repository to store Tanzu Build Service generated Base OS and Builder container images

To create these repositories, run:

```
aws ecr create-repository --repository-name tap-images --region $AWS_REGION
aws ecr create-repository --repository-name tap-build-service --region $AWS_REGION
```

Depending on your installation choices, you might also require the following additional system-related repositories:

- A repository to store Tanzu Build Service full dependencies container images
- A repository to store Tanzu Application Platform's Local Source Proxy container images
- A repository to store Tanzu Cluster Essentials container images

To create these repositories, run:

```
aws ecr create-repository --repository-name full-deps --region $AWS_REGION
aws ecr create-repository --repository-name tap-lsp --region $AWS_REGION
aws ecr create-repository --repository-name tanzu-cluster-essentials --region $AWS_REGION
```

Name the repositories any name you want, but remember the names for when you later build the configuration.

Create the workload container repositories

Similar to the platform container repositories, you must create repositories for each workload that Tanzu Application Platform creates before creating any workloads so that a repository is available to

upload container images and workload bundles.

When installing Tanzu Application Platform, you must specify a prefix for all workload registries. This topic uses `tanzu-application-platform` as the default value, but you can customize this value in the profile configuration created in [Install Tanzu Application Platform package and profiles on AWS](#).

To use the default value, create two workload repositories for each workload with the following format:

```
tanzu-application-platform/WORKLOADNAME-NAMESPACE
tanzu-application-platform/WORKLOADNAME-NAMESPACE-bundle
```

For example, to create these repositories for the the sample workload `tanzu-java-web-app` in the `default` namespace, you can run the following ECR command:

```
aws ecr create-repository --repository-name tanzu-application-platform/tanzu-java-web-app-default --region $AWS_REGION
aws ecr create-repository --repository-name tanzu-application-platform/tanzu-java-web-app-default-bundle --region $AWS_REGION
```



Note

The default Supply Chain Choreographer method of storing Kubernetes configuration is RegistryOps, which requires the `bundle` repository. If you enabled the GitOps capability, this repository is not required. For more information about the differences between RegistryOps and GitOps, see [Use GitOps or RegistryOps with Supply Chain Choreographer](#).

Create IAM roles

By default, the EKS cluster is provisioned with an EC2 instance profile that provides read-only access for the entire EKS cluster to the ECR registry within your AWS account. For more information, see this [AWS documentation](#).

However, some of the services within Tanzu Application Platform require write access or batch read access to the container repositories. To provide that access, create IAM roles and add the ARN to the Kubernetes service accounts that those services use. This ensures that only the required services have access to write container images to ECR and the ability for batch read access, rather than a blanket policy that applies to the entire cluster.

Create the following IAM Roles:

- **Tanzu Build Service:** Gives write access to the repository to allow the service to automatically upload new images. Also provides elevated batch read access to the `tap-images` and `full-deps` repositories. This is limited in scope to the service account for `kpack` and the dependency updater.
- **Workload:** Gives write access to the entire ECR registry with a prepended path. Also provides elevated batch read access to the `full-deps` repository if you use Tanzu Build Service full dependencies. This prevents you from updating the policy for each new workload created.
- **Local Source Proxy:** Gives write access to the repository to allow the service to automatically upload new images. This is limited in scope to the service account for Local Source Proxy.

To create the roles, you must establish two policies:

- Trust Policy: Limits the scope to the OIDC endpoint for the Kubernetes cluster and the Kubernetes service account you attach the role to.
- Permission Policy: Limits the scope of actions the role can take on resources.



Note

These policies attempt to achieve a least privilege model. Review them to confirm they adhere to your organization's policies.

To simplify this walkthrough, use a script to create these policy documents and the roles. This script outputs the files and then creates the IAM roles by using the policy documents. If [Local Source Proxy](#) is not in your installation plan, you can omit the associated commands.

Run:

```
# Retrieve the OIDC endpoint from the Kubernetes cluster and store it for use in the p
olicy.
export OIDCPROVIDER=$(aws eks describe-cluster --name $EKS_CLUSTER_NAME --region $AWS_
REGION --output json | jq '.cluster.identity.oidc.issuer' | tr -d '"' | sed 's/http
s://')
cat << EOF > build-service-trust-policy.json
{
  "Version": "2012-10-17",
  "Statement": [
    {
      "Effect": "Allow",
      "Principal": {
        "Federated": "arn:aws:iam::${AWS_ACCOUNT_ID}:oidc-provider/${OIDCPROVI
DER}"
      },
      "Action": "sts:AssumeRoleWithWebIdentity",
      "Condition": {
        "StringEquals": {
          "${OIDCPROVIDER}:aud": "sts.amazonaws.com"
        },
        "StringLike": {
          "${OIDCPROVIDER}:sub": [
            "system:serviceaccount:kpack:controller",
            "system:serviceaccount:build-service:dependency-updater-contro
ller-serviceaccount"
          ]
        }
      }
    }
  ]
}
EOF

cat << EOF > build-service-policy.json
{
  "Version": "2012-10-17",
  "Statement": [
    {
      "Action": [
        "ecr:DescribeRegistry",
        "ecr:GetAuthorizationToken",
        "ecr:GetRegistryPolicy",
        "ecr:PutRegistryPolicy",
        "ecr:PutReplicationConfiguration",
        "ecr>DeleteRegistryPolicy"
      ],
      "Resource": "*",
    }
  ]
}
```



```

    "Effect": "Allow",
    "Sid": "TAPEcrBuildServiceGlobal"
  },
  {
    "Action": [
      "ecr:DescribeImages",
      "ecr:ListImages",
      "ecr:BatchCheckLayerAvailability",
      "ecr:BatchGetImage",
      "ecr:BatchGetRepositoryScanningConfiguration",
      "ecr:DescribeImageReplicationStatus",
      "ecr:DescribeImageScanFindings",
      "ecr:DescribeRepositories",
      "ecr:GetDownloadUrlForLayer",
      "ecr:GetLifecyclePolicy",
      "ecr:GetLifecyclePolicyPreview",
      "ecr:GetRegistryScanningConfiguration",
      "ecr:GetRepositoryPolicy",
      "ecr:ListTagsForResource",
      "ecr:TagResource",
      "ecr:UntagResource",
      "ecr:BatchDeleteImage",
      "ecr:BatchImportUpstreamImage",
      "ecr:CompleteLayerUpload",
      "ecr>CreatePullThroughCacheRule",
      "ecr>CreateRepository",
      "ecr>DeleteLifecyclePolicy",
      "ecr>DeletePullThroughCacheRule",
      "ecr>DeleteRepository",
      "ecr:InitiateLayerUpload",
      "ecr:PutImage",
      "ecr:PutImageScanningConfiguration",
      "ecr:PutImageTagMutability",
      "ecr:PutLifecyclePolicy",
      "ecr:PutRegistryScanningConfiguration",
      "ecr:ReplicateImage",
      "ecr:StartImageScan",
      "ecr:StartLifecyclePolicyPreview",
      "ecr:UploadLayerPart",
      "ecr>DeleteRepositoryPolicy",
      "ecr:SetRepositoryPolicy"
    ],
    "Resource": [
      "arn:aws:ecr:${AWS_REGION}:${AWS_ACCOUNT_ID}:repository/full-deps",
      "arn:aws:ecr:${AWS_REGION}:${AWS_ACCOUNT_ID}:repository/tap-build-service",
      "arn:aws:ecr:${AWS_REGION}:${AWS_ACCOUNT_ID}:repository/tap-images"
    ],
    "Effect": "Allow",
    "Sid": "TAPEcrBuildServiceScoped"
  }
]
}
EOF

cat << EOF > workload-policy.json
{
  "Version": "2012-10-17",
  "Statement": [
    {
      "Action": [
        "ecr:DescribeRegistry",
        "ecr:GetAuthorizationToken",
        "ecr:GetRegistryPolicy",
        "ecr:PutRegistryPolicy",
        "ecr:PutReplicationConfiguration",

```

```

        "ecr:DeleteRegistryPolicy"
    ],
    "Resource": "*",
    "Effect": "Allow",
    "Sid": "TAPEcrWorkloadGlobal"
},
{
    "Action": [
        "ecr:DescribeImages",
        "ecr:ListImages",
        "ecr:BatchCheckLayerAvailability",
        "ecr:BatchGetImage",
        "ecr:BatchGetRepositoryScanningConfiguration",
        "ecr:DescribeImageReplicationStatus",
        "ecr:DescribeImageScanFindings",
        "ecr:DescribeRepositories",
        "ecr:GetDownloadUrlForLayer",
        "ecr:GetLifecyclePolicy",
        "ecr:GetLifecyclePolicyPreview",
        "ecr:GetRegistryScanningConfiguration",
        "ecr:GetRepositoryPolicy",
        "ecr:ListTagsForResource",
        "ecr:TagResource",
        "ecr:UntagResource",
        "ecr:BatchDeleteImage",
        "ecr:BatchImportUpstreamImage",
        "ecr:CompleteLayerUpload",
        "ecr:CreatePullThroughCacheRule",
        "ecr:CreateRepository",
        "ecr>DeleteLifecyclePolicy",
        "ecr>DeletePullThroughCacheRule",
        "ecr>DeleteRepository",
        "ecr:InitiateLayerUpload",
        "ecr:PutImage",
        "ecr:PutImageScanningConfiguration",
        "ecr:PutImageTagMutability",
        "ecr:PutLifecyclePolicy",
        "ecr:PutRegistryScanningConfiguration",
        "ecr:ReplicateImage",
        "ecr:StartImageScan",
        "ecr:StartLifecyclePolicyPreview",
        "ecr:UploadLayerPart",
        "ecr>DeleteRepositoryPolicy",
        "ecr:SetRepositoryPolicy"
    ],
    "Resource": [
        "arn:aws:ecr:${AWS_REGION}:${AWS_ACCOUNT_ID}:repository/full-deps",
        "arn:aws:ecr:${AWS_REGION}:${AWS_ACCOUNT_ID}:repository/tanzu-applicat
ion-platform/*"
    ],
    "Effect": "Allow",
    "Sid": "TAPEcrWorkloadScoped"
}
]
}
EOF

cat << EOF > workload-trust-policy.json
{
    "Version": "2012-10-17",
    "Statement": [
        {
            "Effect": "Allow",
            "Principal": {
                "Federated": "arn:aws:iam::${AWS_ACCOUNT_ID}:oidc-provider/${OIDCPROVI
DER}"
            }
        }
    ]
}

```

```

    },
    "Action": "sts:AssumeRoleWithWebIdentity",
    "Condition": {
      "StringLike": {
        "${OIDCPROVIDER}:sub": "system:serviceaccount:*:default",
        "${OIDCPROVIDER}:aud": "sts.amazonaws.com"
      }
    }
  }
}
]
}
EOF

cat << EOF > local-source-proxy-trust-policy.json
{
  "Version": "2012-10-17",
  "Statement": [
    {
      "Effect": "Allow",
      "Principal": {
        "Federated": "arn:aws:iam::${AWS_ACCOUNT_ID}:oidc-provider/${OIDCPROVI
DER}"
      },
      "Action": "sts:AssumeRoleWithWebIdentity",
      "Condition": {
        "StringEquals": {
          "${OIDCPROVIDER}:aud": "sts.amazonaws.com"
        },
        "StringLike": {
          "${OIDCPROVIDER}:sub": [
            "system:serviceaccount:tap-local-source-system:proxy-manager"
          ]
        }
      }
    }
  ]
}
EOF

cat << EOF > local-source-proxy-policy.json
{
  "Version": "2012-10-17",
  "Statement": [
    {
      "Action": [
        "ecr:GetAuthorizationToken"
      ],
      "Resource": "*",
      "Effect": "Allow",
      "Sid": "TAPLSPGlobal"
    },
    {
      "Effect": "Allow",
      "Action": [
        "ecr:BatchCheckLayerAvailability",
        "ecr:GetDownloadUrlForLayer",
        "ecr:GetRepositoryPolicy",
        "ecr:DescribeRepositories",
        "ecr:ListImages",
        "ecr:DescribeImages",
        "ecr:BatchGetImage",
        "ecr:GetLifecyclePolicy",
        "ecr:GetLifecyclePolicyPreview",
        "ecr:ListTagsForResource",
        "ecr:DescribeImageScanFindings",
        "ecr:InitiateLayerUpload",

```

```

        "ecr:UploadLayerPart",
        "ecr:CompleteLayerUpload",
        "ecr:PutImage"
    ],
    "Resource": [
        "arn:aws:ecr:${AWS_REGION}:${AWS_ACCOUNT_ID}:repository/tap-lsp"
    ],
    "Sid": "TAPLSPScoped"
}
]
}
EOF

# Create the Tanzu Build Service Role.
aws iam create-role --role-name tap-build-service --assume-role-policy-document file://build-service-trust-policy.json
# Attach the Policy to the Build Role.
aws iam put-role-policy --role-name tap-build-service --policy-name tapBuildServicePolicy --policy-document file://build-service-policy.json

# Create the Workload Role.
aws iam create-role --role-name tap-workload --assume-role-policy-document file://workload-trust-policy.json
# Attach the Policy to the Workload Role.
aws iam put-role-policy --role-name tap-workload --policy-name tapWorkload --policy-document file://workload-policy.json

# Create the TAP Local Source Proxy Role.
aws iam create-role --role-name tap-local-source-proxy --assume-role-policy-document file://local-source-proxy-trust-policy.json
# Attach the Policy to the tap-local-source-proxy Role created earlier.
aws iam put-role-policy --role-name tap-local-source-proxy --policy-name tapLocalSourcePolicy --policy-document file://local-source-proxy-policy.json

```

Next steps

- [Deploy Cluster Essentials](#)



Important

When you use a VMware Tanzu Kubernetes Grid cluster, you do not need to install Cluster Essentials because the contents of Cluster Essentials are already installed on your cluster.

- [Install Tanzu Application Platform package and profiles on AWS](#)

Install Tanzu Application Platform package and profiles on AWS

This topic tells you how to install Tanzu Application Platform (commonly known as TAP) packages from your Tanzu Application Platform package repository on to AWS.

Before installing the packages, ensure you have:

- Completed the [Prerequisites](#).
- Created [AWS Resources](#).
- Installed [Tanzu CLI](#) with any required plug-ins.
- Installed [Cluster Essentials for Tanzu](#).

Relocate images to a registry

Before installation, you must relocate the Tanzu Application Platform images from tanzu.packages.broadcom.com to your own container image registry.

This section describes how to relocate images to the `tap-images` repository created in [Amazon Elastic Container Registry \(ECR\)](#). See [Creating AWS Resources](#) for more information.

To relocate images from tanzu.packages.broadcom.com to the ECR registry:

1. Retrieve your Broadcom registry API token:
 1. Sign in to the [Broadcom Support Portal](#).
 2. Go to [Tanzu Application Platform \(TAP\)](#) and expand the **VMware Tanzu Application Platform** dropdown.
 3. Click the Token Download icon next to the Tanzu Application Platform version you want to download.

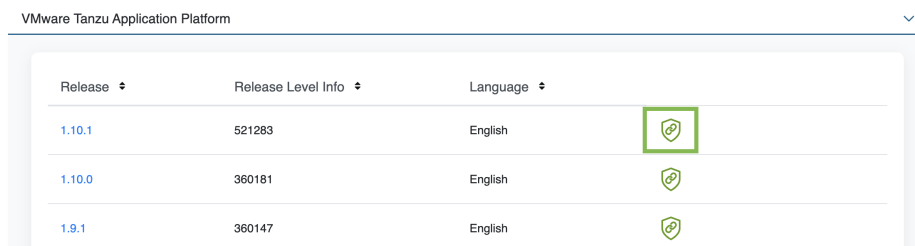

4. Follow the instructions in the dialog box. Save the token as a variable named `MY_BROADCOM_SUPPORT_ACCESS_TOKEN`. For example:

```
export MY_BROADCOM_SUPPORT_ACCESS_TOKEN=API-TOKEN
```

Where `API-TOKEN` is your token from the Broadcom Support Portal.

2. Set up environment variables for installation use by running:

```
export AWS_ACCOUNT_ID=MY-AWS-ACCOUNT-ID
export AWS_REGION=TARGET-AWS-REGION

# Set tanzu.packages.broadcom.com as the source registry to copy the Tanzu Appl
# ication Platform packages from.
export IMGPKG_REGISTRY_HOSTNAME_0=tanzu.packages.broadcom.com
export IMGPKG_REGISTRY_USERNAME_0=MY-BROADCOM-SUPPORT-USERNAME
export IMGPKG_REGISTRY_PASSWORD_0=$MY_BROADCOM_SUPPORT_ACCESS_TOKEN

# The user's registry for copying the Tanzu Application Platform package to.
export IMGPKG_REGISTRY_HOSTNAME_1=$AWS_ACCOUNT_ID.dkr.ecr.$AWS_REGION.amazonaw
#  s.com
export IMGPKG_REGISTRY_USERNAME_1=AWS
export IMGPKG_REGISTRY_PASSWORD_1=`aws ecr get-login-password --region $AWS_REG
#  ION`
# These environment variables starting with IMGPKG_* are used by the imgpkg com
#  mand only.

# The registry from which the Tanzu Application Platform package is retrieved.
export INSTALL_REGISTRY_HOSTNAME=$AWS_ACCOUNT_ID.dkr.ecr.$AWS_REGION.amazonaws.
#  com
export TAP_VERSION=VERSION-NUMBER
export INSTALL_REPO=tap-images
```

Where:

- `MY-AWS-ACCOUNT-ID` is the account ID you deploy Tanzu Application Platform in. No dashes and must be in the format `012345678901`.
- `TARGET-AWS-REGION` is the region you deploy the Tanzu Application Platform to.
- `MY-BROADCOM-SUPPORT-USERNAME` is the user with access to the images in `tanzu.packages.broadcom.com`.
- `VERSION-NUMBER` is your Tanzu Application Platform version. For example, `1.6.13`

3. Install the Carvel tool `imgpkg` CLI.

4. Relocate the images with the `imgpkg` CLI by running:

```
imgpkg copy --concurrency 1 -b tanzu.packages.broadcom.com/tanzu-application-pl
atform/tap-packages:${TAP_VERSION} --to-repo ${INSTALL_REGISTRY_HOSTNAME}/${INS
TALL_REPO}
```

Add the Tanzu Application Platform package repository

Tanzu CLI packages are available on repositories. Adding the Tanzu Application Platform package repository makes Tanzu Application Platform and its packages available for installation.

To add the Tanzu Application Platform package repository to your cluster:

1. Create a namespace called `tap-install` for deploying any component packages by running:

```
kubectl create ns tap-install
```

This namespace keeps the objects grouped together logically.

2. (Optional) If you haven't relocated the images to ECR, create a secret to your registry by running:

```
tanzu secret registry add tap-registry \
  --username ${INSTALL_REGISTRY_USERNAME} --password ${INSTALL_REGISTRY_PASSWOR
D} \
  --server ${INSTALL_REGISTRY_HOSTNAME} \
  --export-to-all-namespaces --yes --namespace tap-install
```

3. Add the Tanzu Application Platform package repository to the cluster by running:

```
tanzu package repository add tanzu-tap-repository \
  --url ${INSTALL_REGISTRY_HOSTNAME}/${INSTALL_REPO}:${TAP_VERSION} \
  --namespace tap-install
```

4. Get the status of the Tanzu Application Platform package repository, and ensure the status updates to `Reconcile succeeded` by running:

```
tanzu package repository get tanzu-tap-repository --namespace tap-install
```

For example:

```
$ tanzu package repository get tanzu-tap-repository --namespace tap-install
- Retrieving repository tap...
NAME:          tanzu-tap-repository
VERSION:       16253001
REPOSITORY:    123456789012.dkr.ecr.us-west-2.amazonaws.com/tap-images
TAG:           1.6.13
STATUS:        Reconcile succeeded
REASON:
```

5. List the available packages by running:

```
tanzu package available list --namespace tap-install
```

For example:

```
$ tanzu package available list --namespace tap-install
NAME                                     DISPLAY-NAME
accelerator.apps.tanzu.vmware.com       Application Accelerator
for VMware Tanzu
amr-observer.apps.tanzu.vmware.com      Supply Chain Security To
ols - AMR Observer
api-portal.tanzu.vmware.com             API portal
apis.apps.tanzu.vmware.com             API Auto Registration fo
r VMware Tanzu
apiserver.appliveview.tanzu.vmware.com  Application Live View Ap
iServer for VMware Tanzu
app-scanning.apps.tanzu.vmware.com      SCST - Scan 2.0
application-configuration-service.tanzu.vmware.com Application Configuratio
n Service
backend.appliveview.tanzu.vmware.com    Application Live View fo
r VMware Tanzu
base-jammy-builder-lite.buildpacks.tanzu.vmware.com base-jammy-builder-lite
base-jammy-stack-lite.buildpacks.tanzu.vmware.com base-jammy-stack
bitnami.services.tanzu.vmware.com       bitnami-services
buildservice.tanzu.vmware.com           Tanzu Build Service
carbonblack.scanning.apps.tanzu.vmware.com VMware Carbon Black for
Supply Chain Security Tools - Scan
cartographer.tanzu.vmware.com           Cartographer
cnrs.tanzu.vmware.com                   Cloud Native Runtimes
connector.appliveview.tanzu.vmware.com  Application Live View Co
nnecto for VMware Tanzu
controller.source.apps.tanzu.vmware.com Tanzu Source Controller
conventions.appliveview.tanzu.vmware.com Application Live View Co
nventions for VMware Tanzu
crossplane.tanzu.vmware.com             crossplane
developer-conventions.tanzu.vmware.com  Tanzu App Platform Devel
oper Conventions
dotnet-core-lite.buildpacks.tanzu.vmware.com dotnet-core-lite
eventing.tanzu.vmware.com               Eventing
external-secrets.apps.tanzu.vmware.com  External Secrets Operato
r
fluxcd.source.controller.tanzu.vmware.com Flux Source Controller
go-lite.buildpacks.tanzu.vmware.com     go-lite
grype.scanning.apps.tanzu.vmware.com    Grype for Supply Chain S
ecurity Tools - Scan
java-lite.buildpacks.tanzu.vmware.com   java-lite
java-native-image-lite.buildpacks.tanzu.vmware.com java-native-image-lite
learningcenter.tanzu.vmware.com         Learning Center for Tanz
u Application Platform
local-source-proxy.apps.tanzu.vmware.com Local Source Proxy
metadata-store.apps.tanzu.vmware.com    Supply Chain Security To
ols - Store
namespace-provisioner.apps.tanzu.vmware.com Namespace Provisioner
nodejs-lite.buildpacks.tanzu.vmware.com nodejs-lite
ootb-delivery-basic.tanzu.vmware.com    Tanzu App Platform Out o
f The Box Delivery Basic
ootb-supply-chain-basic.tanzu.vmware.com Tanzu App Platform Out o
f The Box Supply Chain Basic
ootb-supply-chain-testing-scanning.tanzu.vmware.com Tanzu App Platform Out o
f The Box Supply Chain with Testing and Scanning
ootb-supply-chain-testing.tanzu.vmware.com Tanzu App Platform Out o
f The Box Supply Chain with Testing
ootb-templates.tanzu.vmware.com         Tanzu App Platform Out o
f The Box Templates
```

policy.apps.tanzu.vmware.com ols - Policy Controller	Supply Chain Security To
python-lite.buildpacks.tanzu.vmware.com	python-lite
ruby-lite.buildpacks.tanzu.vmware.com	ruby-lite
scanning.apps.tanzu.vmware.com ols - Scan	Supply Chain Security To
service-bindings.labs.vmware.com ernetes	Service Bindings for Kub
services-toolkit.tanzu.vmware.com	Services Toolkit
snyk.scanning.apps.tanzu.vmware.com curity Tools - Scan	Snyk for Supply Chain Se
spring-boot-conventions.tanzu.vmware.com tions Server	Tanzu Spring Boot Conven
spring-cloud-gateway.tanzu.vmware.com	Spring Cloud Gateway
sso.apps.tanzu.vmware.com	AppSSO
tap-auth.tanzu.vmware.com Application Platform	Default roles for Tanzu
tap-gui.tanzu.vmware.com rm GUI	Tanzu Application Platfo
tap-telemetry.tanzu.vmware.com Tanzu Application Platform	Telemetry Collector for
tap.tanzu.vmware.com rm	Tanzu Application Platfo
tekton.tanzu.vmware.com	Tekton Pipelines
tpb.tanzu.vmware.com	Tanzu Portal Builder
web-servers-lite.buildpacks.tanzu.vmware.com	web-servers-lite
workshops.learningcenter.tanzu.vmware.com	Workshop Building Tutori
al	

Install your Tanzu Application Platform profile

The `tap.tanzu.vmware.com` package installs predefined sets of packages based on your profile settings. This is done by using the package manager installed by Tanzu Cluster Essentials.

For more information about profiles, see [Components and installation profiles](#).

To prepare to install a profile:

1. List version information for the package by running:

```
tanzu package available list tap.tanzu.vmware.com --namespace tap-install
```

2. Create a `tap-values.yaml` file by using the [Full Profile \(AWS\)](#), which contains the minimum configurations required to deploy Tanzu Application Platform on AWS. The sample values file contains the necessary defaults for:
 - o The meta-package, or parent Tanzu Application Platform package.
 - o Subordinate packages, or individual child packages.

Keep the values file for future configuration use.



Note

`tap-values.yaml` is set as a Kubernetes secret, which provides secure means to read credentials for Tanzu Application Platform components.

3. [View possible configuration settings for your package](#)

Full profile (AWS)

The following command generates the YAML file sample for the full-profile on AWS by using the ECR repositories you created earlier. The `profile:` field takes `full` as the default value, but you can also set it to `iterate`, `build`, `run`, or `view`. Refer to [Install multicluster Tanzu Application Platform profiles](#) for more information.

```
cat << EOF > tap-values.yaml
shared:
  ingress_domain: "INGRESS-DOMAIN"

ceip_policy_disclosed: true

# The above keys are minimum numbers of entries needed in tap-values.yaml to get a functioning TAP Full profile installation.

# Below are the keys which may have default values set, but can be overridden.

profile: full # Can take iterate, build, run, view.

supply_chain: basic # Can take testing, testing_scanning.

ootb_supply_chain_basic: # Based on supply_chain set above, can be changed to ootb_supply_chain_testing, ootb_supply_chain_testing_scanning.
  registry:
    server: ${AWS_ACCOUNT_ID}.dkr.ecr.${AWS_REGION}.amazonaws.com
    # The prefix of the ECR repository. Workloads will need
    # two repositories created:
    #
    # tanzu-application-platform/<workloadname>-<namespace>
    # tanzu-application-platform/<workloadname>-<namespace>-bundle
    repository: tanzu-application-platform

contour:
  envoy:
    service:
      type: LoadBalancer # This is set by default, but can be overridden by setting a different value.

buildservice:
  kp_default_repository: ${AWS_ACCOUNT_ID}.dkr.ecr.${AWS_REGION}.amazonaws.com/tap-build-service
  # Enable the build service k8s service account to bind to the AWS IAM Role
  kp_default_repository_aws_iam_role_arn: "arn:aws:iam::${AWS_ACCOUNT_ID}:role/tap-build-service"

local_source_proxy:
  # Takes the value from the project_path under the image_registry section of shared by default, but can be overridden by setting a different value.
  repository: "EXTERNAL-REGISTRY-FOR-LOCAL-SOURCE"
  push_secret:
    # When set to true, the secret mentioned in this section is automatically exported to Local Source Proxy's namespace.
    name: "EXTERNAL-REGISTRY-FOR-LOCAL-SOURCE-SECRET"
    namespace: "EXTERNAL-REGISTRY-FOR-LOCAL-SOURCE-SECRET-NAMESPACE"
    # When set to true, the secret mentioned in this section is automatically exported to Local Source Proxy's namespace.
    create_export: true

ootb_templates:
  # Enable the config writer service to use cloud based iaas authentication
  # which are retrieved from the developer namespace service account by
  # default
  iaas_auth: true

tap_gui:
  app_config:
```

```

auth:
  allowGuestAccess: true # This allows unauthenticated users to log in to your po
rtal. If you want to deactivate it, make sure you configure an alternative auth provid
er.

catalog:
  locations:
    - type: url
      target: https://GIT-CATALOG-URL/catalog-info.yaml

metadata_store:
  ns_for_export_app_cert: "MY-DEV-NAMESPACE" # Verify this namespace is available with
in your cluster before initiating the Tanzu Application Platform installation.
  app_service_type: ClusterIP # Defaults to LoadBalancer. If shared.ingress_domain is
set earlier, this must be set to ClusterIP.

scanning:
  metadataStore:
    url: "" # Configuration is moved, so set this string to empty.

tap_telemetry:
  customer_entitlement_account_number: "CUSTOMER-ENTITLEMENT-ACCOUNT-NUMBER" # (Option
al) Identify data for creating Tanzu Application Platform usage reports.
EOF

```

Where:

- `INGRESS-DOMAIN` is the subdomain for the host name that you point at the `tanzu-shared-ingress` service's External IP address.
- `kp_default_repository_aws_iam_role_arn` is the ARN that was created to write to the ECR repository for the build service. This value is generated by the script, but you can modify it manually.
- `EXTERNAL-REGISTRY-FOR-LOCAL-SOURCE` is where the developer's local source is uploaded when using Tanzu CLI to use Local Source Proxy for workload creation.

If an AWS ECR registry is being used, ensure that the repository already exists. AWS ECR expects the repository path to already exist. This destination is represented as `REGISTRY-SERVER/REPOSITORY-PATH`. For more information, see [Install Local Source Proxy](#).

- `EXTERNAL-REGISTRY-FOR-LOCAL-SOURCE-SECRET` is the name of the secret with credentials that allow pushing to the `EXTERNAL-REGISTRY-FOR-LOCAL-SOURCE` repository.
- `EXTERNAL-REGISTRY-FOR-LOCAL-SOURCE-SECRET-NAMESPACE` is the namespace in which `EXTERNAL-REGISTRY-FOR-LOCAL-SOURCE-SECRET` is available.
- `GIT-CATALOG-URL` is the path to the `catalog-info.yaml` catalog definition file. You can download either a blank or populated catalog file from the [Broadcom Support Portal](#) (file name **Tanzu Application Platform Developer Portal Blank Catalog** or **Tanzu Application Platform Developer Portal Yelb Catalog**). Otherwise, you can use a Backstage-compliant catalog you've already built and posted on the Git infrastructure.
- `MY-DEV-NAMESPACE` is the name of the developer namespace. SCST - Store exports secrets to the namespace, and SCST - Scan deploys the `ScanTemplates` there. This allows the scanning feature to run in this namespace. If there are multiple developer namespaces, use `ns_for_export_app_cert: "*"` to export the SCST - Store CA certificate to all namespaces.
- `CUSTOMER-ENTITLEMENT-ACCOUNT-NUMBER` (optional) refers to the Entitlement Account Number (EAN), which is a unique identifier VMware assigns to its customers. Tanzu Application Platform telemetry uses this number to identify data that belongs to a particular customer and prepare usage reports.

For AWS, the default settings creates a classic LoadBalancer. To use the Network LoadBalancer instead of the classic LoadBalancer for ingress, add the following to your `tap-values.yaml`:

```

contour:
  infrastructure_provider: aws
envoy:
  service:
    aws:
      LBType: nlb

```

(Optional) Additional Build Service configurations

The following tasks are optional during the Tanzu Application Platform installation process:

- [\(Optional\) Configure your profile with full dependencies](#)
- [\(Optional\) Configure your profile with the Jammy stack only](#)

(Optional) Configure your profile with full dependencies

When you install a profile that includes Tanzu Build Service, Tanzu Application Platform is installed with the `lite` set of dependencies. These dependencies consist of `buildpacks` and `stacks` required for application builds.

The `lite` set of dependencies do not contain all buildpacks and stacks. To use all buildpacks and stacks, you must install the `full` dependencies. For more information about the differences between `lite` and `full` dependencies, see [About lite and full dependencies](#).

To configure `full` dependencies, add the key-value pair `exclude_dependencies: true` to your `tap-values.yaml` file under the `buildservice` section. For example:

```

buildservice:
  kp_default_repository: ${AWS_ACCOUNT_ID}.dkr.ecr.${AWS_REGION}.amazonaws.com/tap-build-service
  exclude_dependencies: true

```

After configuring `full` dependencies, you must install the dependencies after you have finished installing your Tanzu Application Platform package. See [Install the full dependencies package](#) for more information.

Tanzu Application Platform v1.6.13 supports building applications with Ubuntu v22.04 (Jammy).

Install your Tanzu Application Platform package

Follow these steps to install the Tanzu Application Platform package:

1. Install the package by running:

```

tanzu package install tap -p tap.tanzu.vmware.com -v ${TAP_VERSION} --values-file tap-values.yaml -n tap-install

```

2. Verify the package install by running:

```

tanzu package installed get tap -n tap-install

```

This can take 5-10 minutes because it installs several packages on your cluster.

3. Verify that the necessary packages in the profile are installed by running:

```

tanzu package installed list -A

```

4. If you configured `full` dependencies in your `tbs-values.yaml` file, install the `full` dependencies by following the procedure in [Install full dependencies](#).

After installing the Full profile on your cluster, you can install the Tanzu Developer Tools for VS Code Extension to help you develop against it. For instructions, see [Install Tanzu Developer Tools for your VS Code](#).



Note

You can run the following command after reconfiguring the profile to reinstall the Tanzu Application Platform:

```
tanzu package installed update tap -p tap.tanzu.vmware.com -v ${TAP_VERSION} --values
-file tap-values.yaml -n tap-install
```

Install the full dependencies package

If you configured `full` dependencies in your `tap-values.yaml` file in [Configure your profile with full dependencies](#) earlier, you must install the `full` dependencies package.

1. Create an ECR repository for Tanzu Build Service full dependencies by running:

```
aws ecr create-repository --repository-name full-deps --region ${AWS_REGION}
```

2. (Optional) If you have an existing installation of the full dependencies package from a version earlier than Tanzu Application Platform v1.6.13, you must uninstall the full dependencies package and remove the package repository:

1. Uninstall the package:

```
tanzu package installed delete full-tbs-deps -n tap-install
```

2. Remove the package repository:

```
tanzu package repository delete tbs-full-deps-repository -n tap-install
```



Important

The package and repository names might differ depending on your installation configurations.

3. If you have not done so already, add the key-value pair `exclude_dependencies: true` to your `tap-values.yaml` file under the `buildservice` section. For example:

```
buildservice:
...
  exclude_dependencies: true
...
```

4. If you have not updated your Tanzu Application Platform package install after adding the `exclude_dependencies: true` to your values file, you must perform the update by running:

```
tanzu package installed update tap --namespace tap-install --values-file PATH-T
O-UPDATED-VALUES
```

5. Get the latest version of the `tap` package by running:

```
tanzu package available list tap.tanzu.vmware.com --namespace tap-install
```

- Relocate the Tanzu Build Service full dependencies package repository by running:

```
imgpkg copy -b tanzu.packages.broadcom.com/tanzu-application-platform/full-deps:VERSION \
  --to-repo ${INSTALL_REGISTRY_HOSTNAME}/full-deps
```

Where `VERSION` is the version of the `tap` package you retrieved in the previous step.

- Add the Tanzu Build Service full dependencies package repository by running:

```
tanzu package repository add full-deps \
  --url ${INSTALL_REGISTRY_HOSTNAME}/${INSTALL_REPO}/full-deps:VERSION \
  --namespace tap-install
```

Where `VERSION` is the version of the `tap` package you retrieved earlier.

- Install the full dependencies package by running:

```
tanzu package install full-deps -p full-deps.buildservice.tanzu.vmware.com -v
"> 0.0.0" -n tap-install --values-file PATH-TO-TAP-VALUES-FILE
```

For more information about the differences between `lite` and `full` dependencies, see [About lite and full dependencies](#).

Access Tanzu Developer Portal

To access Tanzu Developer Portal (formerly named Tanzu Application Platform GUI), you can use the host name that you configured earlier. This host name is pointed at the shared ingress. To configure LoadBalancer for Tanzu Developer Portal, see [Access Tanzu Developer Portal](#).

You're now ready to start using Tanzu Developer Portal. Proceed to the [Getting Started](#) topic or the [Tanzu Developer Portal - Catalog Operations](#) topic.

Exclude packages from a Tanzu Application Platform profile

To exclude packages from a Tanzu Application Platform profile:

- Find the full subordinate (child) package name:

```
tanzu package available list --namespace tap-install
```

- Update your `tap-values` file with a section listing the exclusions:

```
profile: PROFILE-VALUE
excluded_packages:
  - tap-gui.tanzu.vmware.com
  - service-bindings.lab.vmware.com
```



Important

If you exclude a package after performing a profile installation including that package, you cannot see the accurate package states immediately after running `tanzu package installed list -n tap-install`. Also, you can break package

dependencies by removing a package. Allow 20 minutes to verify that all packages have reconciled correctly while troubleshooting.

Next steps

- (Optional) [Install Individual Packages](#)
- [Set up developer namespaces to use your installed packages](#)

View possible configuration settings for your package

To view possible configuration settings for a package, run:

```
tanzu package available get tap.tanzu.vmware.com/$TAP_VERSION --values-schema --namespace tap-install
```



Note

The `tap.tanzu.vmware.com` package does not show all configuration settings for packages it plans to install. The package only shows top-level keys. You can view individual package configuration settings with the same `tanzu package available get` command. For example, to find the keys for Cloud Native Runtimes, you must first identify the version of the package with `tanzu package installed list -n tap-install`, which lists all the installed packages versions. Then run the command `tanzu package available get -n tap-install cnrs.tanzu.vmware.com/CNR-VERSION --values-schema` by using the package version listed for Cloud Native Runtimes.

```
profile: full

# Shared configurations go under the shared key.
shared:
  ingress_domain: tap.example.com

# ...

# For example, Cloud Native Runtimes specific values go under its name.
cnrs:
  provider: local

# For example, App Accelerator specific values go under its name.
accelerator:
  server:
    service_type: "ClusterIP"
```

Shared Keys define values that configure multiple packages. These keys are defined under the `shared` Top-level Key, as summarized in the following table:

Shared Key	Description	Optional
<code>ca_cert_data</code>	PEM-encoded certificate data to trust TLS connections with a private CA. This shared key is used by <code>convention_controller</code> , <code>scanning</code> and the <code>Tanzu source_controller</code> (not the Flux CD Source Controller).	Yes
<code>ingress_domain</code>	Domain name to be used in service routes and host names for instances of Tanzu Application Platform components.	Yes

Shared Key	Description	Optional
<code>ingress_issuer</code>	A <code>cert-manager.io/v1/ClusterIssuer</code> for issuing TLS certificates to Tanzu Application Platform components. Default value: <code>tap-ingress-selfsigned</code>	Yes
<code>kubernetes_distribution</code>	Type of Kubernetes infrastructure being used. You can use this shared key in coordination with the <code>kubernetes_version</code> key. Supported value: <code>openshift</code> .	Yes
<code>kubernetes_version</code>	Kubernetes version. You can use this shared key independently or in coordination with the <code>kubernetes_distribution</code> key. Supported value: <code>1.24.x</code> , where <code>x</code> stands for the Kubernetes patch version.	Yes
<code>image_registry.project_path</code>	Project path in the container image registry server used for builder and application images.	Yes
<code>image_registry.username</code>	User name for the container image registry. Mutually exclusive with <code>shared.image_registry.secret.name/namespace</code>	Yes
<code>image_registry.password</code>	Password for the container image registry. Mutually exclusive with <code>shared.image_registry.secret.name/namespace</code>	Yes
<code>secret.name</code>	Secret name for the container image registry credentials of type <code>kubernetes.io/dockerconfigjson</code> . Mutually exclusive with <code>shared.image_registry.username/password</code>	Yes
<code>secret.namespace</code>	Secret namespace for the container image registry credentials. Mutually exclusive with <code>shared.image_registry.username/password</code>	Yes
<code>activateAppLiveViewSecureAccessController</code>	Enable secure access connection between Application Live View components.	Yes

The following table summarizes the top-level keys used for package-specific configuration within YOUR `tap-values.yaml`.

Package	Top-level Key
See table above.	<code>shared</code>
API Auto Registration	<code>api_auto_registration</code>
API portal	<code>api_portal</code>
Application Accelerator	<code>accelerator</code>
Application Live View	<code>appliveview</code>
Application Live View connector	<code>appliveview_connector</code>
Application Live View conventions	<code>appliveview-conventions</code>
Cartographer	<code>cartographer</code>
Cloud Native Runtimes	<code>cnrs</code>
Source Controller	<code>source_controller</code>
Supply Chain	<code>supply_chain</code>
Supply Chain Basic	<code>ootb_supply_chain_basic</code>
Supply Chain Testing	<code>ootb_supply_chain_testing</code>
Supply Chain Testing Scanning	<code>ootb_supply_chain_testing_scanning</code>
Supply Chain Security Tools - Scan	<code>scanning</code>
Supply Chain Security Tools - Scan (Grype Scanner)	<code>grype</code>
Supply Chain Security Tools - Store	<code>metadata_store</code>

Package	Top-level Key
Build Service	<code>buildservice</code>
Tanzu Developer Portal	<code>tap_gui</code>
Learning Center	<code>learningcenter</code>

For information about package-specific configuration, see [Install individual packages](#).

Install individual packages

You can install Tanzu Application Platform (commonly known as TAP) through predefined profiles or through individual packages. Use this topic to learn how to install each individual package. For more information about installing through profiles, see [Components and installation profiles](#).

Installing individual Tanzu Application Platform packages is useful if you do not want to use a profile to install packages or if you want to install additional packages after installing a profile. Before installing the packages, be sure to complete the prerequisites, configure and verify the cluster, and install the Tanzu CLI with any required plug-ins. For more information, see [Prerequisites](#).

Install pages for individual Tanzu Application Platform packages

- [Install API Auto Registration](#)
- [Install API portal](#)
- [Install Application Accelerator](#)
- [Install Application Configuration Service](#)
- [Install Application Live View](#)
- [Install Application Single Sign-On](#)
- [Install Bitnami Services](#)
- [Install cert-manager](#)
- [Install Cloud Native Runtimes](#)
- [Install Contour](#)
- [Install Crossplane](#)
- [Install default roles for Tanzu Application Platform](#)
- [Install Developer Conventions](#)
- [Install Eventing](#)
- [Install Flux CD Source Controller](#)
- [Install Learning Center for Tanzu Application Platform](#)
- [Install Out of the Box Templates](#)
- [Install Out of the Box Supply Chain with Testing](#)
- [Install Out of the Box Supply Chain with Testing and Scanning](#)
- [Install Service Bindings](#)
- [Install Services Toolkit](#)
- [Install Source Controller](#)

- [Install Spring Boot conventions](#)
- [Install Supply Chain Choreographer](#)
- [Install Supply Chain Security Tools - Store](#)
- [Install Supply Chain Security Tools - Policy Controller](#)
- [Install Supply Chain Security Tools - Scan](#)
- [Install Tanzu Developer Portal](#)
- [Install Tanzu Build Service](#)
- [Install Tekton](#)
- [Install Telemetry](#)

Verify the installed packages

Use the following procedure to verify that the packages are installed.

1. List the installed packages by running:

```
tanzu package installed list --namespace tap-install
```

For example:

```
$ tanzu package installed list --namespace tap-install
\ Retrieving installed packages...
NAME                                PACKAGE-NAME                                PAC
KAGE-VERSION  STATUS
api-portal    api-portal.tanzu.vmware.com                1.
0.3           Reconcile succeeded
app-accelerator  accelerator.apps.tanzu.vmware.com        1.
0.0           Reconcile succeeded
app-live-view   appliveview.tanzu.vmware.com             1.
0.2           Reconcile succeeded
appliveview-conventions  build.appliveview.tanzu.vmware.com      1.
0.2           Reconcile succeeded
cartographer    cartographer.tanzu.vmware.com           0.
1.0           Reconcile succeeded
cloud-native-runtimes  cnrs.tanzu.vmware.com                   1.
0.3           Reconcile succeeded
convention-controller  controller.conventions.apps.tanzu.vmware.com  0.
7.0           Reconcile succeeded
developer-conventions  developer-conventions.tanzu.vmware.com     0.
3.0-build.1   Reconcile succeeded
grype-scanner   grype.scanning.apps.tanzu.vmware.com     1.
0.0           Reconcile succeeded
image-policy-webhook  image-policy-webhook.signing.apps.tanzu.vmware.com  1.
1.2           Reconcile succeeded
metadata-store  metadata-store.apps.tanzu.vmware.com      1.
0.2           Reconcile succeeded
ootb-supply-chain-basic  ootb-supply-chain-basic.tanzu.vmware.com  0.
5.1           Reconcile succeeded
ootb-templates   ootb-templates.tanzu.vmware.com         0.
5.1           Reconcile succeeded
scan-controller   scanning.apps.tanzu.vmware.com           1.
0.0           Reconcile succeeded
service-bindings  service-bindings.labs.vmware.com         0.
5.0           Reconcile succeeded
services-toolkit  services-toolkit.tanzu.vmware.com        0.
8.0           Reconcile succeeded
source-controller  controller.source.apps.tanzu.vmware.com   0.
2.0           Reconcile succeeded
```

```

sso4k8s-install      sso.apps.tanzu.vmware.com      1.
0.0-beta.2-31      Reconcile succeeded
tap-gui              tap-gui.tanzu.vmware.com        0.
3.0-rc.4            Reconcile succeeded
tekton-pipelines    tekton.tanzu.vmware.com         0.3
0.0                  Reconcile succeeded
tbs                  buildservice.tanzu.vmware.com   1.
5.0                  Reconcile succeeded

```

Next steps

- [Set up developer namespaces to use your installed packages](#)

Set up developer namespaces to use your installed packages

You can choose either one of the following two approaches to create a [Workload](#) for your application by using the registry credentials specified, add credentials and Role-Based Access Control (RBAC) rules to the namespace that you plan to create the [Workload](#) in:

- [Enable single user access.](#)
- [Enable additional users access with Kubernetes RBAC.](#)

Enable single user access

Follow these steps to enable your current user to submit jobs to the Supply Chain:

1. (Optional) If the variable `AWS_ACCOUNT_ID` environment is not set during the [installation](#) process, export the AWS Account ID.

```
export AWS_ACCOUNT_ID=MY-AWS-ACCOUNT-ID
```

2. Add a service account to execute the supply chain and RBAC rules to authorize the service account to the developer namespace.

```

cat <<EOF | kubectl -n YOUR-NAMESPACE apply -f -
apiVersion: v1
kind: ServiceAccount
metadata:
  name: default
  annotations:
    eks.amazonaws.com/role-arn: "arn:aws:iam::${AWS_ACCOUNT_ID}:role/tap-workload"
---
apiVersion: rbac.authorization.k8s.io/v1
kind: RoleBinding
metadata:
  name: default-permit-deliverable
roleRef:
  apiGroup: rbac.authorization.k8s.io
  kind: ClusterRole
  name: deliverable
subjects:
  - kind: ServiceAccount
    name: default
---
apiVersion: rbac.authorization.k8s.io/v1
kind: RoleBinding
metadata:
  name: default-permit-workload

```

```

roleRef:
  apiGroup: rbac.authorization.k8s.io
  kind: ClusterRole
  name: workload
subjects:
- kind: ServiceAccount
  name: default
EOF

```

Where `YOUR-NAMESPACE` is your developer namespace.

3. (Optional) If you haven't relocated the images to ECR, add a placeholder secret for gathering the credentials used for pulling container images.

```

cat <<EOF | kubectl -n YOUR-NAMESPACE apply -f -
apiVersion: v1
kind: Secret
metadata:
  name: tap-registry
  annotations:
    secretgen.carvel.dev/image-pull-secret: ""
type: kubernetes.io/dockerconfigjson
data:
  .dockerconfigjson: e30K
---
apiVersion: v1
kind: ServiceAccount
metadata:
  name: default
  annotations:
    eks.amazonaws.com/role-arn: "arn:aws:iam::${AWS_ACCOUNT_ID}:role/tap-workload"
imagePullSecrets:
- name: tap-registry
EOF

```

Where `YOUR-NAMESPACE` is your developer namespace.

Enable additional users access with Kubernetes RBAC

Follow these steps to enable additional users by using Kubernetes RBAC to submit jobs to the Supply Chain:

1. [Enable single user access.](#)
2. Choose either of the following options to give developers namespace-level access and view access to appropriate cluster-level resources:
 - o **Option 1:** Use the [Tanzu Application Platform RBAC CLI plug-in \(beta\)](#).

To use the `tanzu rbac` plug-in to grant `app-viewer` and `app-editor` roles to an identity provider group, run:

```

tanzu rbac binding add -g GROUP-FOR-APP-VIEWER -n YOUR-NAMESPACE -r app-viewer
tanzu rbac binding add -g GROUP-FOR-APP-EDITOR -n YOUR-NAMESPACE -r app-editor

```

Where:

- `YOUR-NAMESPACE` is the name you give to the developer namespace.
- `GROUP-FOR-APP-VIEWER` is the user group from the upstream identity provider that requires access to `app-viewer` resources on the current namespace and

cluster.

- `GROUP-FOR-APP-EDITOR` is the user group from the upstream identity provider that requires access to `app-editor` resources on the current namespace and cluster.

For more information about `tanzu rbac`, see [Bind a user or group to a default role](#).

VMware recommends creating a user group in your identity provider's grouping system for each developer namespace and then adding the users accordingly.

Depending on your identity provider, you might need to take further action to federate user groups appropriately with your cluster. For an example of how to set up Azure Active Directory (AD) with your cluster, see [Integrating Azure Active Directory](#).

- **Option 2:** Use the native Kubernetes YAML.

To apply the RBAC policy, run:

```
cat <<EOF | kubectl -n YOUR-NAMESPACE apply -f -
apiVersion: rbac.authorization.k8s.io/v1
kind: RoleBinding
metadata:
  name: dev-permit-app-viewer
roleRef:
  apiGroup: rbac.authorization.k8s.io
  kind: ClusterRole
  name: app-viewer
subjects:
- kind: Group
  name: GROUP-FOR-APP-VIEWER
  apiGroup: rbac.authorization.k8s.io
---
apiVersion: rbac.authorization.k8s.io/v1
kind: ClusterRoleBinding
metadata:
  name: YOUR-NAMESPACE-permit-app-viewer
roleRef:
  apiGroup: rbac.authorization.k8s.io
  kind: ClusterRole
  name: app-viewer-cluster-access
subjects:
- kind: Group
  name: GROUP-FOR-APP-VIEWER
  apiGroup: rbac.authorization.k8s.io
---
apiVersion: rbac.authorization.k8s.io/v1
kind: RoleBinding
metadata:
  name: dev-permit-app-editor
roleRef:
  apiGroup: rbac.authorization.k8s.io
  kind: ClusterRole
  name: app-editor
subjects:
- kind: Group
  name: GROUP-FOR-APP-EDITOR
  apiGroup: rbac.authorization.k8s.io
---
apiVersion: rbac.authorization.k8s.io/v1
kind: ClusterRoleBinding
metadata:
  name: YOUR-NAMESPACE-permit-app-editor
roleRef:
  apiGroup: rbac.authorization.k8s.io
```

```

kind: ClusterRole
name: app-editor-cluster-access
subjects:
- kind: Group
  name: GROUP-FOR-APP-EDITOR
  apiGroup: rbac.authorization.k8s.io
EOF

```

Where:

- `YOUR-NAMESPACE` is the name you give to the developer namespace.
- `GROUP-FOR-APP-VIEWER` is the user group from the upstream identity provider that requires access to `app-viewer` resources on the current namespace and cluster.
- `GROUP-FOR-APP-EDITOR` is the user group from the upstream identity provider that requires access to `app-editor` resources on the current namespace and cluster.

VMware recommends creating a user group in your identity provider's grouping system for each developer namespace and then adding the users accordingly.

Depending on your identity provider, you might need to take further action to federate user groups appropriately with your cluster. For an example of how to set up Azure Active Directory (AD) with your cluster, see [Integrating Azure Active Directory](#).

Rather than granting roles directly to individuals, VMware recommends using your identity provider's user groups system to grant access to a group of developers. For an example of how to set up Azure AD with your cluster, see [Integrating Azure Active Directory](#).

3. (Optional) Log in as a non-admin user, such as a developer, to see the effects of RBAC after the bindings are applied.

Next steps

- [Install Tanzu Developer Tools for your VS Code](#)

Install Tanzu Developer Tools for your VS Code

This topic tells you how to install VMware Tanzu Developer Tools for Visual Studio Code (VS Code).

Prerequisites

Before installing the extension, you must have:

- [VS Code](#)
- [kubectl](#)
- [Tilt v0.30.12 or later](#)
- [Tanzu CLI and plug-ins](#)
- [A cluster with the Tanzu Application Platform Full profile or Iterate profile](#)

If you are an app developer, someone else in your organization might have already set up the Tanzu Application Platform environment.

Docker Desktop and local Kubernetes are not prerequisites for using Tanzu Developer Tools for VS Code.

Install

To install the extension:

1. Download Tanzu Developer Tools for Visual Studio Code from the [Broadcom Support Portal](#).
2. Open VS Code.
3. Press `cmd+shift+P` to open the Command Palette and run `Extensions: Install from VSIX...`



4. Select the extension file `tanzu-vscode-extension.vsix`.
5. If you do not have the following extensions, and they do not automatically install, install them from VS Code Marketplace:
 - o [Debugger for Java](#)
 - o [Language Support for Java\(™\) by Red Hat](#)
 - o [YAML](#)
6. Ensure Language Support for Java is running in [Standard Mode](#). You can configure it in the **Settings** menu by going to **Code > Preferences > Settings** under **Java > Server: Launch Mode**.

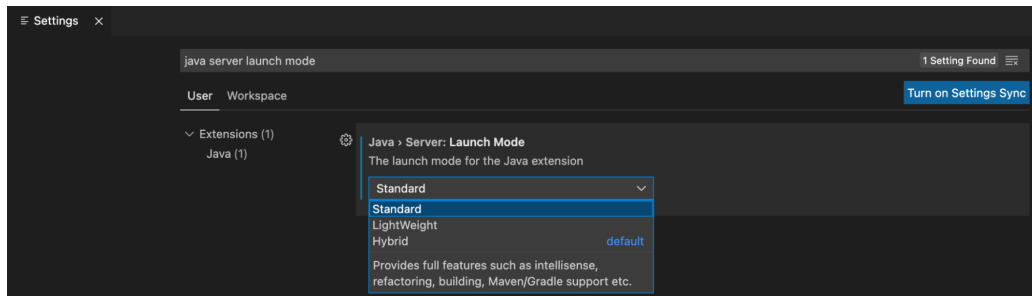

When the JDK and Language Support for Java are configured correctly, you see that the integrated development environment creates a directory target where the code is compiled.

Configure

To configure VMware Tanzu Developer Tools for VS Code:

1. Ensure that you are targeting the correct cluster. For more information, see the [Kubernetes documentation](#).
2. Go to **Code > Preferences > Settings > Extensions > Tanzu Developer Tools** and set the following:
 - o **Confirm Delete:** This controls whether the extension asks for confirmation when deleting a workload.
 - o **Enable Live Hover:** For more information, see [Integrating Live Hover by using Spring Boot Tools](#). Reload VS Code for this change to take effect.
 - o **Source Image:** The registry location for publishing local source code. For example, `registry.io/yourapp-source`. This must include both a registry and a project name. A source image registry location is optional when Local Source Proxy is configured.

- **Local Path:** (Optional) The path on the local file system to a directory of source code to build. This is the current directory by default.
- **Namespace:** (Optional) This is the namespace that workloads are deployed into. The namespace set in `kubeconfig` is the default.

Uninstall

To uninstall VMware Tanzu Developer Tools for VS Code:

1. Go to **Code > Preferences > Settings > Extensions**.
2. Right-click the extension and select **Uninstall**.

Next steps

Proceed to [Getting started with Tanzu Developer Tools for Visual Studio Code](#).

Install Tanzu Application Platform (Azure)

To install Tanzu Application Platform (commonly known as TAP) on Azure:

Step	Task	Link
1.	Review the prerequisites to ensure that you have set up everything required before beginning the installation	Prerequisites
2.	Install the Tanzu CLI	Install the Tanzu CLI
3.	Create Azure Resources	Create Azure Resources
4.	Install Cluster Essentials for Tanzu	Deploy Cluster Essentials
5.	Add the Tanzu Application Platform package repository, prepare your Tanzu Application Platform profile, and install the profile to the cluster	Install the Tanzu Application Platform package and profiles
6.	(Optional) Install any additional packages that were not in the profile	Install individual packages
7.	Set up developer namespaces to use your installed packages	Set up developer namespaces to use your installed packages
8.	Install developer tools into your integrated development environment (IDE)	Install Tanzu Developer Tools for your VS Code

After installing Tanzu Application Platform on to your Kubernetes clusters, proceed with [Get started with Tanzu Application Platform](#).

Install Tanzu Application Platform (Azure)

To install Tanzu Application Platform (commonly known as TAP) on Azure:

Step	Task	Link
1.	Review the prerequisites to ensure that you have set up everything required before beginning the installation	Prerequisites
2.	Install the Tanzu CLI	Install the Tanzu CLI
3.	Create Azure Resources	Create Azure Resources
4.	Install Cluster Essentials for Tanzu	Deploy Cluster Essentials
5.	Add the Tanzu Application Platform package repository, prepare your Tanzu Application Platform profile, and install the profile to the cluster	Install the Tanzu Application Platform package and profiles

Step	Task	Link
6.	(Optional) Install any additional packages that were not in the profile	Install individual packages
7.	Set up developer namespaces to use your installed packages	Set up developer namespaces to use your installed packages
8.	Install developer tools into your integrated development environment (IDE)	Install Tanzu Developer Tools for your VS Code

After installing Tanzu Application Platform on to your Kubernetes clusters, proceed with [Get started with Tanzu Application Platform](#).

Create Azure Resources for Tanzu Application Platform

To install Tanzu Application Platform (commonly known as TAP) within the Azure ecosystem, you must create several Azure resources. Use this topic to learn how to create:

- An Azure Kubernetes Service (AKS) cluster to install Tanzu Application Platform.
- ACR repositories for the Tanzu Application Platform container images.

Creating these resources enables Tanzu Application Platform to use an IAM role bound to a Kubernetes service account for authentication, rather than the typical username and password stored in a Kubernetes secret strategy.

This is important when using ACR because authenticating to ACR is a two-step process:

1. Retrieve a token using your Azure credentials.
2. Use the token to authenticate to the registry.

To increase security, the token has a lifetime of 12 hours. This makes storing it as a secret for a service impractical because it must be refreshed every 12 hours.

Using an IAM role on a service account mitigates the need to retrieve the token because it is handled by credential helpers within the services.

Prerequisites

Before installing Tanzu Application Platform on Azure, you need:

- **An Azure subscription:**
You must create all of your resources within an [Azure subscription](#) and create an [Azure free account](#).
- **Azure CLI:**
To run CLI reference commands locally, you must [install the Azure CLI](#). This topic uses Azure CLI to both query and configure resources in Azure, such as IAM roles. For more information, see [Azure CLI documentation](#).

Create Azure Resource Group

1. Log in to Azure.

```
az login
az account set --subscription SUBSCRIPTION-NAME
```

2. Create a resource group with the `az group create` command.

```
az group create --name myTAPResourceGroup --location eastus
```

Create an AKS cluster

To create an AKS cluster, you can run the `az aks create` command with the `--enable-addons monitoring` and `--enable-msi-auth-for-monitoring` parameter to enable [Azure Monitor Container insights](#) with managed identity authentication (preview).

The following example creates a cluster named `tap-on-azure` with one node and enables a system-assigned managed identity:

```
az aks create -g myTAPResourceGroup -n tap-on-azure --enable-managed-identity --node-count 6 --enable-addons monitoring --enable-msi-auth-for-monitoring --generate-ssh-keys --node-vm-size Standard_D4ds_v4 --kubernetes-version K8S-VERSION
```

Where `K8S-VERSION` is the compatible Kubernetes version that can be retrieved by running `az aks get-versions`.



Note

You might need to increase quota for Standard DDSv4 Family vCPUs. For more information, see the [Azure documentation](#).

After a few minutes, the command completes and returns JSON-formatted information about the cluster.

When you create an AKS cluster, a second resource group is automatically created to store the AKS resources. For more information, see [Why are two resource groups created with AKS?](#)

Connect to the AKS cluster

To manage a Kubernetes cluster, use the Kubernetes command-line client, `kubectl`. `kubectl` is already installed if you use Azure Cloud Shell.

1. Install `kubectl` locally by using the `az aks install-cli` command:

```
az aks install-cli
```

2. Configure `kubectl` to connect to your Kubernetes cluster by using the `az aks get-credentials` command that:
 - o Downloads credentials and configures the Kubernetes CLI to use them.
 - o Uses `~/.kube/config`, the default location for the [Kubernetes configuration file](#). You can specify a different location for your Kubernetes configuration file by using the `--file` argument.

```
az aks get-credentials --resource-group myTAPResourceGroup --name tap-on-azure
```

Create the container repositories

1. Set an environment variable for your registry by running:

```
export REGISTRY_NAME=YOUR-REGISTRY-NAME
```

Where `YOUR-REGISTRY-NAME` is the name that you want for your container image registry. Use lowercase.

2. Create the Azure Container Registry by running:

```
az acr create -n $REGISTRY_NAME -g myTAPResourceGroup --sku Standard
```



Note

Azure Container Registry (ACR) does not require that the container repositories are already created. Repositories are created automatically when images are uploaded.

Enable registry admin account

To enable push and pull to your registries, you must enable the admin user account, which is created with each registry. Run the following command to enable the admin user account:

```
az acr update -n $REGISTRY_NAME --admin-enabled true
```

There are two passwords created for each admin user account per registry. To retrieve the passwords, run the following for each registry:

```
az acr credential show --name $REGISTRY_NAME --resource-group myTAPResourceGroup
```

Expect to see the following outputs:

```
{
  "passwords": [
    {
      "name": "password",
      "value": YOUR-PASSWORD
    },
    {
      "name": "password2",
      "value": YOUR-PASSWORD-2
    }
  ],
  "username": ""
}
```

Export the username and password by running:

```
export KP_REGISTRY_USERNAME=$REGISTRY_NAME
export KP_REGISTRY_PASSWORD=YOUR-PASSWORD
```

Next steps

- [Install Tanzu Application Platform package and profiles on Azure](#)

Install Tanzu Application Platform package and profiles on Azure

This topic tells you how to install Tanzu Application Platform (commonly known as TAP) packages from your Tanzu Application Platform package repository on to Azure.

Before installing the packages, ensure you have:

- Completed the [Prerequisites](#).
- Created [Azure Resources](#).
- Installed [Tanzu CLI](#) with any required plug-ins.
- Installed [Cluster Essentials for Tanzu](#).

Relocate images to a registry



Before installation, you must relocate the Tanzu Application Platform images from tanzu.packages.broadcom.com to your own container image registry.

The supported registries are Harbor, Azure Container Registry, Google Container Registry, and Quay.io. See the following documentation to learn how to set up your container image registry:

- [Harbor documentation](#)
- [Google Container Registry documentation](#)
- [Quay.io documentation](#)

To relocate images from tanzu.packages.broadcom.com to your registry:

1. Retrieve your Broadcom registry API token:
 1. Sign in to the [Broadcom Support Portal](#).
 2. Go to [Tanzu Application Platform \(TAP\)](#) and expand the **VMware Tanzu Application Platform** dropdown.
 3. Click the Token Download icon next to the Tanzu Application Platform version you want to download.

Release	Release Level Info	Language	
1.10.1	521283	English	
1.10.0	360181	English	
1.9.1	360147	English	

4. Follow the instructions in the dialog box. Save the token as a variable named `MY_BROADCOM_SUPPORT_ACCESS_TOKEN`. For example:

```
export MY_BROADCOM_SUPPORT_ACCESS_TOKEN=API-TOKEN
```

Where `API-TOKEN` is your token from the Broadcom Support Portal.

2. Set up environment variables for installation use by running:

```
# Set tanzu.packages.broadcom.com as the source registry to copy the Tanzu Appl
ication Platform packages from.
export IMGPKG_REGISTRY_HOSTNAME_0=tanzu.packages.broadcom.com
export IMGPKG_REGISTRY_USERNAME_0=MY-BROADCOM-SUPPORT-USERNAME
export IMGPKG_REGISTRY_PASSWORD_0=$MY_BROADCOM_SUPPORT_ACCESS_TOKEN

# The user's registry for copying the Tanzu Application Platform package to.
export IMGPKG_REGISTRY_HOSTNAME_1=$REGISTRY_NAME.azurecr.io
export IMGPKG_REGISTRY_USERNAME_1=$REGISTRY_NAME
export IMGPKG_REGISTRY_PASSWORD_1=REGISTRY-PASSWORD
# These environment variables starting with IMGPKG_* are used by the imgpkg com
mand only.
```

```
# The registry from which the Tanzu Application Platform package is retrieved.
export INSTALL_REGISTRY_HOSTNAME=$REGISTRY_NAME.azurecr.io
export TAP_VERSION=VERSION-NUMBER
export INSTALL_REPO=tapimages
```

Where:

- `MY-BROADCOM-SUPPORT-USERNAME` is the user with access to the images in `tanzu.packages.broadcom.com`.
- `REGISTRY-PASSWORD` is the password for your Azure container registry.
- `VERSION-NUMBER` is your Tanzu Application Platform version. For example, `1.6.13`.

3. Install the Carvel tool `imgpkg` CLI.

4. Relocate the images with the `imgpkg` CLI by running:

```
imgpkg copy --concurrency 1 -b ${IMGPKG_REGISTRY_HOSTNAME_0}/tanzu-application-
platform/tap-packages:${TAP_VERSION} --to-repo ${IMGPKG_REGISTRY_HOSTNAME_1}/
${INSTALL_REPO}
```

Add the Tanzu Application Platform package repository

Tanzu CLI packages are available through repositories. Adding the Tanzu Application Platform package repository makes Tanzu Application Platform and its packages available for installation.

To add the Tanzu Application Platform package repository to your cluster:

1. Create a namespace called `tap-install` for deploying any component packages by running:

```
kubectl create ns tap-install
```

This namespace keeps the objects grouped together logically.

2. Create a registry secret for `tanzu.packages.broadcom.com` registry by running:

```
tanzu secret registry add tap-registry \
--username ${INSTALL_REGISTRY_USERNAME} --password ${INSTALL_REGISTRY_PASSWORD} \
--server ${INSTALL_REGISTRY_HOSTNAME} \
--export-to-all-namespaces --yes --namespace tap-install
tanzu secret registry list --namespace tap-install
```

3. Add the Tanzu Application Platform package repository to the cluster by running:

```
tanzu package repository add tanzu-tap-repository \
--url ${INSTALL_REGISTRY_HOSTNAME}/full-deps-package-repo
--namespace tap-install
```

4. Get the status of the Tanzu Application Platform package repository, and ensure the status updates to `Reconcile succeeded` by running:

```
tanzu package repository get tanzu-tap-repository --namespace tap-install
```

For example:

```
$ tanzu package repository get tanzu-tap-repository --namespace tap-install
- Retrieving repository tap...
NAME:          tanzu-tap-repository
VERSION:      16253001
REPOSITORY:   123456789012.dkr.acr.us-east.azure.com/tap-images
```

```
TAG:          1.6.13
STATUS:       Reconcile succeeded
REASON:
```



Note

The **VERSION** and **TAG** numbers differ from the earlier example if you are on Tanzu Application Platform v1.0.2 or earlier.

- List the available packages by running:

```
tanzu package available list --namespace tap-install
```

For example:

```
$ tanzu package available list --namespace tap-install
/ Retrieving available packages...
NAME                                DISPLAY-NAME
SHORT-DESCRIPTION
  accelerator.apps.tanzu.vmware.com  Application Accelerator
for VMware Tanzu                    Used to create new projects a
nd configurations.
  api-portal.tanzu.vmware.com        API portal
A unified user interface for API discovery and exploration at scale.
  apis.apps.tanzu.vmware.com         API Auto Registration fo
r VMware Tanzu                    A TAP component to automatica
lly register API exposing workloads as API entities
in TAP GUI.
  backend.appliveview.tanzu.vmware.com Application Live View fo
r VMware Tanzu                    App for monitoring and troubl
eshooting running apps
  buildservice.tanzu.vmware.com      Tanzu Build Service
Tanzu Build Service enables the building and automation of containerized
software workflows securely and at scale.
  carbonblack.scanning.apps.tanzu.vmware.com VMware Carbon Black for
Supply Chain Security Tools - Scan Default scan templates using
VMware Carbon Black
  cartographer.tanzu.vmware.com       Cartographer
Kubernetes native Supply Chain Choreographer.
  cnrs.tanzu.vmware.com               Cloud Native Runtimes
Cloud Native Runtimes is a serverless runtime based on Knative
  connector.appliveview.tanzu.vmware.com Application Live View Co
nconnector for VMware Tanzu        App for discovering and regis
tering running apps
  controller.source.apps.tanzu.vmware.com Tanzu Source Controller
Tanzu Source Controller enables workload create/update from source code.
  conventions.appliveview.tanzu.vmware.com Application Live View Co
nventions for VMware Tanzu        Application Live View convent
ion server
  developer-conventions.tanzu.vmware.com Tanzu App Platform Devel
oper Conventions                  Developer Conventions
  eventing.tanzu.vmware.com           Eventing
Eventing is an event-driven architecture platform based on Knative Eventing
  external-secrets.apps.tanzu.vmware.com External Secrets Operato
r                                    External Secrets Operator is
a Kubernetes operator that integrates external
secret management systems.
  fluxcd.source.controller.tanzu.vmware.com Flux Source Controller
The source-controller is a Kubernetes operator, specialised in artifacts
```

acquisition from external sources such as Git, Helm repositories and S3 buckets.

`grype.scanning.apps.tanzu.vmware.com` Grype for Supply Chain Security Tools - Scan Default scan templates using Anchore Grype

`learningcenter.tanzu.vmware.com` Learning Center for Tanzu Application Platform Guided technical workshops

`metadata-store.apps.tanzu.vmware.com` Supply Chain Security Tools - Store Post SBOMs and query for image, package, and vulnerability metadata.

`namespace-provisioner.apps.tanzu.vmware.com` Namespace Provisioner Automatic Provisioning of Developer Namespaces.

`ootb-delivery-basic.tanzu.vmware.com` Tanzu App Platform Out of The Box Delivery Basic

`ootb-supply-chain-basic.tanzu.vmware.com` Tanzu App Platform Out of The Box Supply Chain Basic

`ootb-supply-chain-testing-scanning.tanzu.vmware.com` Tanzu App Platform Out of The Box Supply Chain with Testing and Scanning

`ootb-supply-chain-testing.tanzu.vmware.com` Tanzu App Platform Out of The Box Supply Chain with Testing

`ootb-templates.tanzu.vmware.com` Tanzu App Platform Out of The Box Templates

`policy.apps.tanzu.vmware.com` Supply Chain Security Tools - Policy Controller Policy Controller enables defining of a policy to restrict unsigned container images.

`scanning.apps.tanzu.vmware.com` Supply Chain Security Tools - Scan Scan for vulnerabilities and enforce policies directly within Kubernetes native

Supply Chains.

`service-bindings.labs.vmware.com` Service Bindings for Kubernetes Service Bindings for Kubernetes implements the Service Binding Specification.

`services-toolkit.tanzu.vmware.com` Services Toolkit The Services Toolkit enables the management, lifecycle, discoverability and connectivity of Service Resources (databases, message queues, DNS records, etc.).

`snky.scanning.apps.tanzu.vmware.com` Snyk for Supply Chain Security Tools - Scan Default scan templates using Snyk

`spring-boot-conventions.tanzu.vmware.com` Tanzu Spring Boot Conventions Server Default Spring Boot convention server.

`sso.apps.tanzu.vmware.com` AppSSO Application Single Sign-On for Tanzu

`tap-auth.tanzu.vmware.com` Default roles for Tanzu Application Platform Default roles for Tanzu Application Platform

`tap-gui.tanzu.vmware.com` Tanzu Application Platform GUI web app graphical user interface for Tanzu Application Platform

`tap-telemetry.tanzu.vmware.com` Telemetry Collector for Tanzu Application Platform Telemetry

`tap.tanzu.vmware.com` Tanzu Application Platform Package to install a set of TAP components to get you started based on your use

```

case.
  tekton.tanzu.vmware.com           Tekton Pipelines
Tekton Pipelines is a framework for creating CI/CD systems.
  workshops.learningcenter.tanzu.vmware.com   Workshop Building Tutorial
al                                     Workshop Building Tutorial

```

Install your Tanzu Application Platform profile

The `tap.tanzu.vmware.com` package installs predefined sets of packages based on your profile settings by using the package manager installed by Tanzu Cluster Essentials. For more information about profiles, see [Components and installation profiles](#).

Some components use `kpack` and require a repository to publish artifacts to. This registry does not have to be the same registry used for installing the Tanzu Application Platform packages. To create a registry secret and add it to a developer namespace, run:

```

export KP_REGISTRY_USERNAME=YOUR-USERNAME
export KP_REGISTRY_PASSWORD=YOUR-PASSWORD
export KP_REGISTRY_HOSTNAME=YOUR-HOSTNAME

echo $KP_REGISTRY_USERNAME
echo $KP_REGISTRY_PASSWORD
echo $KP_REGISTRY_HOSTNAME

docker login $KP_REGISTRY_HOSTNAME -u $KP_REGISTRY_USERNAME -p $KP_REGISTRY_PASSWORD

export YOUR_NAMESPACE=mydev-ns

echo $YOUR_NAMESPACE

kubectl create ns $YOUR_NAMESPACE

tanzu secret registry add registry-credentials --server $KP_REGISTRY_HOSTNAME --username $KP_REGISTRY_USERNAME --password $KP_REGISTRY_PASSWORD --namespace $YOUR_NAMESPACE

kubectl get secret registry-credentials -o jsonpath='{.data.\.dockerconfigjson}' -n $YOUR_NAMESPACE | base64 --decode

```

To prepare to install a profile:

1. List version information for the package by running:

```
tanzu package available list tap.tanzu.vmware.com --namespace tap-install
```

2. Create a `tap-values.yaml` file by using the [Full Profile \(Azure\)](#), which contains the minimum configurations required to deploy Tanzu Application Platform on Azure. The sample values file contains the necessary defaults for:
 - o The meta-package, or parent Tanzu Application Platform package.
 - o Subordinate packages, or individual child packages.

Keep the values file for future configuration use.



Note

`tap-values.yaml` is set as a Kubernetes secret, which provides secure means to read credentials for the Tanzu Application Platform components.

3. [View possible configuration settings for your package](#)

Full profile (Azure)

The following is the YAML file sample for the full-profile on Azure by using the ACR repositories you created earlier. The `profile:` field takes `full` as the default value, but you can also set it to `iterate`, `build`, `run`, or `view`. See [Install multicluster Tanzu Application Platform profiles](#) for more information.

```
cat << EOF > tap-values.yaml
shared:
  ingress_domain: YOUR_DOMAIN
  ingress_issuer: CLUSTER_ISSUER # use "" to disable SSL

  image_registry:
    project_path: ${KP_REGISTRY_HOSTNAME}/tap
    secret:
      name: registry-credentials
      namespace: ${YOUR_NAMESPACE}

ceip_policy_disclosed: true
profile: full # Can take iterate, build, run, view.

supply_chain: basic # Can take testing, testing_scanning.

ootb_templates:
  iaas_auth: true

ootb_supply_chain_basic:
  registry: # (Optional) Takes the value from the project_path under the shared.image_
  registry section by default, but you can override it by setting different values.
  server: ${KP_REGISTRY_HOSTNAME}
  repository: tap-apps
  gitops:
    ssh_secret: ""

contour:
  envoy:
    service:
      type: LoadBalancer

buildservice:
  # (Optional) Takes the value from the project_path under the shared.image_registry s
  ection by default, but you can override it by setting a different value.
  kp_default_repository: ${KP_REGISTRY_HOSTNAME}/buildservice
  kp_default_repository_secret:
    name: registry-credentials
    namespace: ${YOUR_NAMESPACE}

local_source_proxy:
  # (Optional) Takes the value from the project_path under the shared.image_registry s
  ection by default, but you can override it by setting a different value.
  repository: "EXTERNAL-REGISTRY-FOR-LOCAL-SOURCE"
  push_secret:
    name: "EXTERNAL-REGISTRY-FOR-LOCAL-SOURCE-SECRET"
    namespace: "EXTERNAL-REGISTRY-FOR-LOCAL-SOURCE-SECRET-NAMESPACE"
    create_export: true # When set to true, the secret mentioned in this section is a
  utomatically exported to Local Source Proxy's namespace.

learningcenter:
  ingressDomain: learning-center.tap.com

ootb_delivery_basic:
  service_account: default

tap_gui:
  app_config:
```



```

auth:
  allowGuestAccess: true

metadata_store:
  app_service_type: ClusterIP
  ns_for_export_app_cert: ${YOUR_NAMESPACE}

scanning:
  metadataStore:
    url: "" # Configuration is moved, so set this string to empty.

accelerator:
  server:
    service_type: "ClusterIP"

EOF

```

Where:

- `YOUR_DOMAIN` is the subdomain for the host name that you point at the `tanzu-shared-ingress` service's External IP address.



Note

You can update this field when knowing the external IP address of the ingress after the initial install of Tanzu Application Platform.

- `CLUSTER_ISSUER` is the name of the deployed `ClusterIssuer` to enable TLS on your ingress domain. You can disable TLS by using an empty string `""`.
- `YOUR_NAMESPACE` is the environment variable you defined earlier to describe the name of the developer namespace. Supply Chain Security Tools - Store exports secrets to the namespace, and Supply Chain Security Tools - Scan deploys the `ScanTemplates` there. This allows the scanning feature to run in this namespace. If there are multiple developer namespaces, use `ns_for_export_app_cert: "*"` to export the Supply Chain Security Tools - Store CA certificate to all namespaces.
- `EXTERNAL-REGISTRY-FOR-LOCAL-SOURCE` is where the developer's local source is uploaded when using Tanzu CLI to use Local Source Proxy for workload creation.
- `EXTERNAL-REGISTRY-FOR-LOCAL-SOURCE-SECRET` is the name of the secret with credentials that allow pushing to the `EXTERNAL-REGISTRY-FOR-LOCAL-SOURCE` repository.
- `EXTERNAL-REGISTRY-FOR-LOCAL-SOURCE-SECRET-NAMESPACE` is the namespace in which `EXTERNAL-REGISTRY-FOR-LOCAL-SOURCE-SECRET` is available.



Important

Installing Grype by using `tap-values.yaml` as follows is deprecated in v1.6 and will be removed in v1.8:

```

grype:
  namespace: tap-workload
  targetImagePullSecret: registry-credentials

```

You can install Grype by using Namespace Provisioner instead.

(Optional) Configure your profile with full dependencies

When you install a profile that includes Tanzu Build Service, Tanzu Application Platform is installed with the `lite` set of dependencies. These dependencies consist of `buildpacks` and `stacks` required for application builds.

The `lite` set of dependencies do not contain all buildpacks and stacks. To use all buildpacks and stacks, you must install the `full` dependencies. For more information about the differences between `lite` and `full` dependencies, see [About lite and full dependencies](#).

To configure `full` dependencies, add the key-value pair `exclude_dependencies: true` to your `tap-values.yaml` file under the `buildservice` section. For example:

```
buildservice:
  kp_default_repository: "KP-DEFAULT-REPO"
  kp_default_repository_secret: # Takes the value from the shared section by default,
  but can be overridden by setting a different value.
  name: "KP-DEFAULT-REPO-SECRET"
  namespace: "KP-DEFAULT-REPO-SECRET-NAMESPACE"
  exclude_dependencies: true
```

After configuring `full` dependencies, you must install the dependencies after you have finished installing your Tanzu Application Platform package. See [Install the full dependencies package](#) for more information.

Tanzu Application Platform v1.6.1 supports building applications with Ubuntu v22.04 (Jammy).

Install your Tanzu Application Platform package

Follow these steps to install the Tanzu Application Platform package:

1. Install the package by running:

```
tanzu package install tap -p tap.tanzu.vmware.com -v $TAP_VERSION --values-file
tap-values.yaml -n tap-install
```

2. Verify the package install by running:

```
tanzu package installed get tap -n tap-install
```

This can take 5-10 minutes because it installs several packages on your cluster.

3. Verify that the necessary packages in the profile are installed by running:

```
tanzu package installed list -A
```

4. If you configured `full` dependencies in your `tbs-values.yaml` file, install the `full` dependencies by following the procedure in [Install full dependencies](#).

After installing the Full profile on your cluster, you can install the Tanzu Developer Tools for VS Code Extension to help you develop against it. For more information, see [Install Tanzu Developer Tools for your VS Code](#).

Install the full dependencies package

If you configured `full` dependencies in your `tap-values.yaml` file in [Configure your profile with full dependencies](#) earlier, you must install the `full` dependencies package.

For more information about the differences between `lite` and `full` dependencies, see [About lite and full dependencies](#).

To install the `full` dependencies package:

1. To execute a clean install of the full dependencies, you must exclude the default dependencies by adding the key-value pair `exclude_dependencies: true` to your `tap-values.yaml` file under the `buildservice` section. For example:

```
buildservice:
  kp_default_repository: ${KP_REGISTRY_HOSTNAME}.azurecr.io/${REPOSITORY_NAME}
  exclude_dependencies: true
  ...
```

2. Get the latest version of the `tap` package by running:

```
tanzu package available list tap.tanzu.vmware.com --namespace tap-install
```

3. Relocate the Tanzu Build Service full dependencies package repository by running:

```
imgpkg copy -b tanzu.packages.broadcom.com/tanzu-application-platform/full-deps
-package-repo:VERSION \
  --to-repo ${INSTALL_REGISTRY_HOSTNAME}/full-deps-package-repo
```

Where `VERSION` is the version of the `tap` package you retrieved in the previous step.

4. Add the Tanzu Build Service full dependencies package repository by running:

```
tanzu package repository add full-deps-package-repo \
  --url ${INSTALL_REGISTRY_HOSTNAME}/${INSTALL_REPO}/full-deps-package-repo:VER
SION \
  --namespace tap-install
```

Where `VERSION` is the version of the `tap` package you retrieved earlier.

5. Install the full dependencies package by running:

```
tanzu package install full-deps -p full-deps.buildservice.tanzu.vmware.com -v
"> 0.0.0" -n tap-install --values-file PATH-TO-TAP-VALUES-FILE
```

Access Tanzu Developer Portal

You can use the host name configured in [Access Tanzu Developer Portal](#) to access Tanzu Developer Portal. This host name is pointed at the shared ingress.

You're now ready to start using Tanzu Developer Portal. Proceed to the [Getting Started](#) topic or the [Tanzu Developer Portal - Catalog Operations](#) topic.

Next steps

- (Optional) [Install Individual Packages](#)
- [Set up developer namespaces to use your installed packages](#)

View possible configuration settings for your package

To view possible configuration settings for a package, run:

```
tanzu package available get tap.tanzu.vmware.com/$TAP_VERSION --values-schema --namesp
ace tap-install
```



Note

The `tap.tanzu.vmware.com` package does not show all configuration settings for packages it plans to install. The package only shows top-level keys. You can view individual package configuration settings with the same `tanzu package available get` command. For example, to find the keys for Cloud Native Runtimes, you must first identify the version of the package with `tanzu package installed list -n tap-install`, which lists all the installed packages versions. Then run the command `tanzu package available get -n tap-install cnrs.tanzu.vmware.com/CNR-VERSION --values-schema` by using the package version listed for Cloud Native Runtimes.

```
profile: full

# Shared configurations go under the shared key.
shared:
  ingress_domain: tap.example.com

# ...

# For example, Cloud Native Runtimes specific values go under its name.
cnrs:
  provider: local

# For example, App Accelerator specific values go under its name.
accelerator:
  server:
    service_type: "ClusterIP"
```

Shared Keys define values that configure multiple packages. These keys are defined under the `shared` Top-level Key, as summarized in the following table:

Shared Key	Description	Optional
<code>ca_cert_data</code>	PEM-encoded certificate data to trust TLS connections with a private CA. This shared key is used by <code>convention_controller</code> , <code>scanning</code> and the Tanzu <code>source_controller</code> (not the Flux CD Source Controller).	Yes
<code>ingress_domain</code>	Domain name to be used in service routes and host names for instances of Tanzu Application Platform components.	Yes
<code>ingress_issuer</code>	A <code>cert-manager.io/v1/ClusterIssuer</code> for issuing TLS certificates to Tanzu Application Platform components. Default value: <code>tap-ingress-selfsigned</code>	Yes
<code>kubernetes_distribution</code>	Type of Kubernetes infrastructure being used. You can use this shared key in coordination with the <code>kubernetes_version</code> key. Supported value: <code>openshift</code> .	Yes
<code>kubernetes_version</code>	Kubernetes version. You can use this shared key independently or in coordination with the <code>kubernetes_distribution</code> key. Supported value: <code>1.24.x</code> , where <code>x</code> stands for the Kubernetes patch version.	Yes
<code>image_registry.project_path</code>	Project path in the container image registry server used for builder and application images.	Yes
<code>image_registry.username</code>	User name for the container image registry. Mutually exclusive with <code>shared.image_registry.secret.name/namespace</code>	Yes
<code>image_registry.password</code>	Password for the container image registry. Mutually exclusive with <code>shared.image_registry.secret.name/namespace</code>	Yes
<code>secret.name</code>	Secret name for the container image registry credentials of type <code>kubernetes.io/dockerconfigjson</code> . Mutually exclusive with <code>shared.image_registry.username/password</code>	Yes

Shared Key	Description	Optional
<code>secret.namespace</code>	Secret namespace for the container image registry credentials. Mutually exclusive with <code>shared.image_registry.username/password</code>	Yes
<code>activateAppLiveViewSecureAccessController</code>	Enable secure access connection between Application Live View components.	Yes

The following table summarizes the top-level keys used for package-specific configuration within your `tap-values.yaml`.

Package	Top-level Key
See table above.	<code>shared</code>
API Auto Registration	<code>api_auto_registration</code>
API portal	<code>api_portal</code>
Application Accelerator	<code>accelerator</code>
Application Live View	<code>appliveview</code>
Application Live View connector	<code>appliveview_connector</code>
Application Live View conventions	<code>appliveview-conventions</code>
Cartographer	<code>cartographer</code>
Cloud Native Runtimes	<code>cnrs</code>
Source Controller	<code>source_controller</code>
Supply Chain	<code>supply_chain</code>
Supply Chain Basic	<code>ootb_supply_chain_basic</code>
Supply Chain Testing	<code>ootb_supply_chain_testing</code>
Supply Chain Testing Scanning	<code>ootb_supply_chain_testing_scanning</code>
Supply Chain Security Tools - Scan	<code>scanning</code>
Supply Chain Security Tools - Scan (Grype Scanner)	<code>grype</code>
Supply Chain Security Tools - Store	<code>metadata_store</code>
Build Service	<code>buildservice</code>
Tanzu Developer Portal	<code>tap_gui</code>
Learning Center	<code>learningcenter</code>

For information about package-specific configuration, see [Install individual packages](#).

Install individual packages

You can install Tanzu Application Platform (commonly known as TAP) through predefined profiles or through individual packages. Use this topic to learn how to install each individual package. For more information about installing through profiles, see [Components and installation profiles](#).

Installing individual Tanzu Application Platform packages is useful if you do not want to use a profile to install packages or if you want to install additional packages after installing a profile. Before installing the packages, be sure to complete the prerequisites, configure and verify the cluster, and install the Tanzu CLI with any required plug-ins. For more information, see [Prerequisites](#).

Install pages for individual Tanzu Application Platform packages

- [Install API Auto Registration](#)
- [Install API portal](#)
- [Install Application Accelerator](#)
- [Install Application Configuration Service](#)
- [Install Application Live View](#)
- [Install Application Single Sign-On](#)
- [Install Bitnami Services](#)
- [Install cert-manager](#)
- [Install Cloud Native Runtimes](#)
- [Install Contour](#)
- [Install Crossplane](#)
- [Install default roles for Tanzu Application Platform](#)
- [Install Developer Conventions](#)
- [Install Eventing](#)
- [Install Flux CD Source Controller](#)
- [Install Learning Center for Tanzu Application Platform](#)
- [Install Out of the Box Templates](#)
- [Install Out of the Box Supply Chain with Testing](#)
- [Install Out of the Box Supply Chain with Testing and Scanning](#)
- [Install Service Bindings](#)
- [Install Services Toolkit](#)
- [Install Source Controller](#)
- [Install Spring Boot conventions](#)
- [Install Supply Chain Choreographer](#)
- [Install Supply Chain Security Tools - Store](#)
- [Install Supply Chain Security Tools - Policy Controller](#)
- [Install Supply Chain Security Tools - Scan](#)
- [Install Tanzu Developer Portal](#)
- [Install Tanzu Build Service](#)
- [Install Tekton](#)
- [Install Telemetry](#)

Verify the installed packages

Use the following procedure to verify that the packages are installed.

1. List the installed packages by running:

```
tanzu package installed list --namespace tap-install
```

For example:

```
$ tanzu package installed list --namespace tap-install
\ Retrieving installed packages...
NAME                                PACKAGE-NAME                                PAC
KAGE-VERSION  STATUS
api-portal    0.3          Reconcile  succeeded  api-portal.tanzu.vmware.com  1.
app-accelerator 0.0          Reconcile  succeeded  accelerator.apps.tanzu.vmware.com  1.
app-live-view  0.2          Reconcile  succeeded  appliveview.tanzu.vmware.com  1.
appliveview-conventions 0.2          Reconcile  succeeded  build.appliveview.tanzu.vmware.com  1.
cartographer   1.0          Reconcile  succeeded  cartographer.tanzu.vmware.com  0.
cloud-native-runtimes 0.3          Reconcile  succeeded  cnrs.tanzu.vmware.com  1.
convention-controller 7.0          Reconcile  succeeded  controller.conventions.apps.tanzu.vmware.com  0.
developer-conventions 3.0-build.1  Reconcile  succeeded  developer-conventions.tanzu.vmware.com  0.
grype-scanner  0.0          Reconcile  succeeded  grype.scanning.apps.tanzu.vmware.com  1.
image-policy-webhook 1.2          Reconcile  succeeded  image-policy-webhook.signing.apps.tanzu.vmware.com  1.
metadata-store  0.2          Reconcile  succeeded  metadata-store.apps.tanzu.vmware.com  1.
ootb-supply-chain-basic 5.1          Reconcile  succeeded  ootb-supply-chain-basic.tanzu.vmware.com  0.
ootb-templates  5.1          Reconcile  succeeded  ootb-templates.tanzu.vmware.com  0.
scan-controller 0.0          Reconcile  succeeded  scanning.apps.tanzu.vmware.com  1.
service-bindings 5.0          Reconcile  succeeded  service-bindings.labs.vmware.com  0.
services-toolkit 8.0          Reconcile  succeeded  services-toolkit.tanzu.vmware.com  0.
source-controller 2.0          Reconcile  succeeded  controller.source.apps.tanzu.vmware.com  0.
sso4k8s-install 0.0-beta.2-31 Reconcile  succeeded  sso.apps.tanzu.vmware.com  1.
tap-gui        3.0-rc.4     Reconcile  succeeded  tap-gui.tanzu.vmware.com  0.
tekton-pipelines 0.0          Reconcile  succeeded  tekton.tanzu.vmware.com  0.3
tbs           5.0          Reconcile  succeeded  buildservice.tanzu.vmware.com  1.
```

Next steps

- [Set up developer namespaces to use your installed packages](#)

Set up developer namespaces to use your installed packages

This topic tells you how to set up developer namespaces by using the legacy manual process. For more information about how to automatically set up your developer namespaces, see [Namespace Provisioner](#).

Additional configuration for testing and scanning

If you plan to install or have already installed Out of the Box Supply Chains with Testing and Scanning, you can use Namespace Provisioner to set up the required resources. For more information, see [Customize installation](#) in the Namespace Provisioner documentation for configuration steps.

Legacy namespace setup

You can choose either one of the following two approaches to create a [Workload](#) for your application by using the registry credentials specified, add credentials and Role-Based Access Control (RBAC) rules to the namespace that you plan to create the [Workload](#) in:

- [Enable single user access.](#)
- [Enable additional users access with Kubernetes RBAC.](#)

Enable single user access

Run the following command to add secrets, a service account to execute the supply chain, and RBAC rules to authorize the service account to the developer namespace:

```
cat <<EOF |kubectl -n YOUR-NAMESPACE apply -f -
apiVersion: v1
kind: Secret
metadata:
  name: tap-registry
  annotations:
    secretgen.carvel.dev/image-pull-secret: ""
type: kubernetes.io/dockerconfigjson
data:
  .dockerconfigjson: e30K

---
apiVersion: v1
kind: ServiceAccount
metadata:
  name: default
secrets:
  - name: registry-credentials
imagePullSecrets:
  - name: registry-credentials
  - name: tap-registry

---
apiVersion: rbac.authorization.k8s.io/v1
kind: Role
metadata:
  name: default
rules:
- apiGroups: [source.toolkit.fluxcd.io]
  resources: [gitrepositories]
  verbs: ['*']
- apiGroups: [source.apps.tanzu.vmware.com]
  resources: [imagerepositories]
  verbs: ['*']
- apiGroups: [carto.run]
  resources: [deliverables, runnables]
  verbs: ['*']
- apiGroups: [kpack.io]
  resources: [images]
  verbs: ['*']
- apiGroups: [conventions.apps.tanzu.vmware.com]
```



```

resources: [podintents]
verbs: ['*']
- apiGroups: [""]
  resources: ['configmaps']
  verbs: ['*']
- apiGroups: [""]
  resources: ['pods']
  verbs: ['list']
- apiGroups: [tekton.dev]
  resources: [taskruns, pipelineruns]
  verbs: ['*']
- apiGroups: [tekton.dev]
  resources: [pipelines]
  verbs: ['list']
- apiGroups: [kappctrl.k14s.io]
  resources: [apps]
  verbs: ['*']
- apiGroups: [serving.knative.dev]
  resources: ['services']
  verbs: ['*']
- apiGroups: [servicebinding.io]
  resources: ['servicebindings']
  verbs: ['*']
- apiGroups: [services.apps.tanzu.vmware.com]
  resources: ['resourceclaims']
  verbs: ['*']
- apiGroups: [scanning.apps.tanzu.vmware.com]
  resources: ['imagescans', 'sourcescans']
  verbs: ['*']

---
apiVersion: rbac.authorization.k8s.io/v1
kind: RoleBinding
metadata:
  name: default
roleRef:
  apiGroup: rbac.authorization.k8s.io
  kind: Role
  name: default
subjects:
- kind: ServiceAccount
  name: default

```

Where `YOUR-NAMESPACE` is your developer namespace.

Enable additional users access with Kubernetes RBAC

Follow these steps to enable additional users by using Kubernetes RBAC to submit jobs to the Supply Chain:

1. [Enable single user access.](#)
2. Choose either of the following options to give developers namespace-level access and view access to appropriate cluster-level resources:
 - o **Option 1:** Use the [Tanzu Application Platform RBAC CLI plug-in \(beta\)](#).

To use the `tanzu rbac` plug-in to grant `app-viewer` and `app-editor` roles to an identity provider group, run:

```

tanzu rbac binding add -g GROUP-FOR-APP-VIEWER -n YOUR-NAMESPACE -r app-viewer
tanzu rbac binding add -g GROUP-FOR-APP-EDITOR -n YOUR-NAMESPACE -r app-editor

```

Where:

- `YOUR-NAMESPACE` is the name you give to the developer namespace.
- `GROUP-FOR-APP-VIEWER` is the user group from the upstream identity provider that requires access to `app-viewer` resources on the current namespace and cluster.
- `GROUP-FOR-APP-EDITOR` is the user group from the upstream identity provider that requires access to `app-editor` resources on the current namespace and cluster.

For more information about `tanzu rbac`, see [Bind a user or group to a default role](#).

VMware recommends creating a user group in your identity provider's grouping system for each developer namespace and then adding the users accordingly.

Depending on your identity provider, you might need to take further action to federate user groups appropriately with your cluster. For an example of how to set up Azure Active Directory (AD) with your cluster, see [Integrating Azure Active Directory](#).

- o **Option 2:** Use the native Kubernetes YAML.

To apply the RBAC policy, run:

```
cat <<EOF | kubectl -n YOUR-NAMESPACE apply -f -
apiVersion: rbac.authorization.k8s.io/v1
kind: RoleBinding
metadata:
  name: dev-permit-app-viewer
roleRef:
  apiGroup: rbac.authorization.k8s.io
  kind: ClusterRole
  name: app-viewer
subjects:
- kind: Group
  name: GROUP-FOR-APP-VIEWER
  apiGroup: rbac.authorization.k8s.io
---
apiVersion: rbac.authorization.k8s.io/v1
kind: ClusterRoleBinding
metadata:
  name: YOUR-NAMESPACE-permit-app-viewer
roleRef:
  apiGroup: rbac.authorization.k8s.io
  kind: ClusterRole
  name: app-viewer-cluster-access
subjects:
- kind: Group
  name: GROUP-FOR-APP-VIEWER
  apiGroup: rbac.authorization.k8s.io
---
apiVersion: rbac.authorization.k8s.io/v1
kind: RoleBinding
metadata:
  name: dev-permit-app-editor
roleRef:
  apiGroup: rbac.authorization.k8s.io
  kind: ClusterRole
  name: app-editor
subjects:
- kind: Group
  name: GROUP-FOR-APP-EDITOR
  apiGroup: rbac.authorization.k8s.io
---
```

```

apiVersion: rbac.authorization.k8s.io/v1
kind: ClusterRoleBinding
metadata:
  name: YOUR-NAMESPACE-permit-app-editor
roleRef:
  apiGroup: rbac.authorization.k8s.io
  kind: ClusterRole
  name: app-editor-cluster-access
subjects:
- kind: Group
  name: GROUP-FOR-APP-EDITOR
  apiGroup: rbac.authorization.k8s.io
EOF

```

Where:

- `YOUR-NAMESPACE` is the name you give to the developer namespace.
- `GROUP-FOR-APP-VIEWER` is the user group from the upstream identity provider that requires access to `app-viewer` resources on the current namespace and cluster.
- `GROUP-FOR-APP-EDITOR` is the user group from the upstream identity provider that requires access to `app-editor` resources on the current namespace and cluster.

VMware recommends creating a user group in your identity provider's grouping system for each developer namespace and then adding the users accordingly.

Depending on your identity provider, you might need to take further action to federate user groups appropriately with your cluster. For an example of how to set up Azure Active Directory (AD) with your cluster, see [Integrating Azure Active Directory](#).

Rather than granting roles directly to individuals, VMware recommends using your identity provider's user groups system to grant access to a group of developers. For an example of how to set up Azure AD with your cluster, see [Integrating Azure Active Directory](#).

3. (Optional) Log in as a non-admin user, such as a developer, to see the effects of RBAC after the bindings are applied.

Next steps

- [Install Tanzu Developer Tools for your VS Code](#)

Install Tanzu Developer Tools for your VS Code

This topic tells you how to install VMware Tanzu Developer Tools for Visual Studio Code (VS Code).

Prerequisites

Before installing the extension, you must have:

- [VS Code](#)
- [kubectl](#)
- [Tilt v0.30.12](#) or later
- [Tanzu CLI and plug-ins](#)
- [A cluster with the Tanzu Application Platform Full profile or Iterate profile](#)

If you are an app developer, someone else in your organization might have already set up the Tanzu Application Platform environment.

Docker Desktop and local Kubernetes are not prerequisites for using Tanzu Developer Tools for VS Code.

Install

To install the extension:

1. Download Tanzu Developer Tools for Visual Studio Code from the [Broadcom Support Portal](#).
2. Open VS Code.
3. Press `cmd+shift+P` to open the Command Palette and run `Extensions: Install from VSIX...`



4. Select the extension file `tanzu-vscode-extension.vsix`.
5. If you do not have the following extensions, and they do not automatically install, install them from VS Code Marketplace:
 - [Debugger for Java](#)
 - [Language Support for Java\(™\) by Red Hat](#)
 - [YAML](#)
6. Ensure Language Support for Java is running in [Standard Mode](#). You can configure it in the **Settings** menu by going to **Code > Preferences > Settings** under **Java > Server: Launch Mode**.

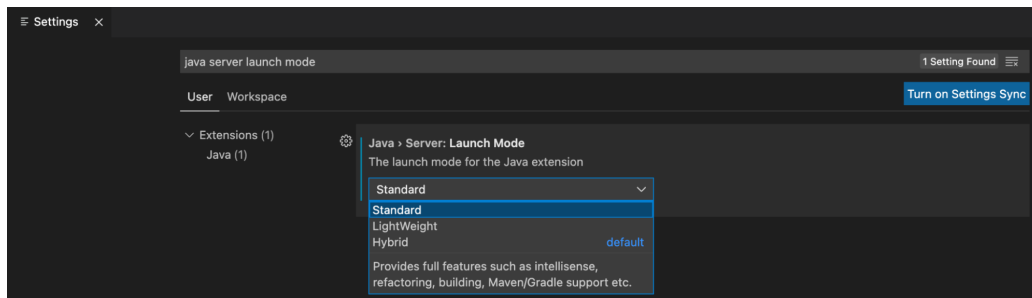

When the JDK and Language Support for Java are configured correctly, you see that the integrated development environment creates a directory target where the code is compiled.

Configure

To configure VMware Tanzu Developer Tools for VS Code:

1. Ensure that you are targeting the correct cluster. For more information, see the [Kubernetes documentation](#).
2. Go to **Code > Preferences > Settings > Extensions > Tanzu Developer Tools** and set the following:
 - **Confirm Delete:** This controls whether the extension asks for confirmation when deleting a workload.

- **Enable Live Hover:** For more information, see [Integrating Live Hover by using Spring Boot Tools](#). Reload VS Code for this change to take effect.
- **Source Image:** The registry location for publishing local source code. For example, `registry.io/yourapp-source`. This must include both a registry and a project name. A source image registry location is optional when Local Source Proxy is configured.
- **Local Path:** (Optional) The path on the local file system to a directory of source code to build. This is the current directory by default.
- **Namespace:** (Optional) This is the namespace that workloads are deployed into. The namespace set in `kubeconfig` is the default.

Uninstall

To uninstall VMware Tanzu Developer Tools for VS Code:

1. Go to **Code > Preferences > Settings > Extensions**.
2. Right-click the extension and select **Uninstall**.

Next steps

Proceed to [Getting started with Tanzu Developer Tools for Visual Studio Code](#).

Install Tanzu Application Platform (OpenShift)

To install Tanzu Application Platform (commonly known as TAP) on your OpenShift clusters with internet access:

Step	Task	Link
1.	Review the prerequisites to ensure you have met all requirements before installing.	Prerequisites
2.	Install the Tanzu CLI.	Install the Tanzu CLI
3.	Install Cluster Essentials for Tanzu.	Deploy Cluster Essentials
4.	Add the Tanzu Application Platform package repository, prepare your Tanzu Application Platform profile, and install the profile to the cluster.	Install the Tanzu Application Platform package and profiles
5.	(Optional) Install any additional packages that were not in the profile.	Install individual packages
6.	Set up developer namespaces to use your installed packages.	Set up developer namespaces to use your installed packages
7.	Install developer tools into your integrated development environment (IDE).	Install Tanzu Developer Tools for your VS Code

After installing Tanzu Application Platform on to your OpenShift clusters, proceed with [Get started with Tanzu Application Platform](#).

Install Tanzu Application Platform (OpenShift)

To install Tanzu Application Platform (commonly known as TAP) on your OpenShift clusters with internet access:

Step	Task	Link
1.	Review the prerequisites to ensure you have met all requirements before installing.	Prerequisites

Step	Task	Link
2.	Install the Tanzu CLI.	Install the Tanzu CLI
3.	Install Cluster Essentials for Tanzu.	Deploy Cluster Essentials
4.	Add the Tanzu Application Platform package repository, prepare your Tanzu Application Platform profile, and install the profile to the cluster.	Install the Tanzu Application Platform package and profiles
5.	(Optional) Install any additional packages that were not in the profile.	Install individual packages
6.	Set up developer namespaces to use your installed packages.	Set up developer namespaces to use your installed packages
7.	Install developer tools into your integrated development environment (IDE).	Install Tanzu Developer Tools for your VS Code

After installing Tanzu Application Platform on to your OpenShift clusters, proceed with [Get started with Tanzu Application Platform](#).

Install Tanzu Application Platform on your OpenShift clusters

This topic tells you how to install Tanzu Application Platform (commonly known as TAP) packages on your OpenShift clusters.

Before installing the packages, ensure you have:

- Completed the [Prerequisites](#).
- Configured and verified the cluster.
- [Installed Tanzu CLI](#) with any required plug-ins.

Relocate images to a registry



Before installation, you must relocate the Tanzu Application Platform images from tanzu.packages.broadcom.com to your own container image registry.

The supported registries are Harbor, Azure Container Registry, Google Container Registry, and Quay.io. See the following documentation to learn how to set up your container image registry:

- [Harbor documentation](#)
- [Google Container Registry documentation](#)
- [Quay.io documentation](#)

To relocate images from tanzu.packages.broadcom.com to your registry:

1. Retrieve your Broadcom registry API token:
 1. Sign in to the [Broadcom Support Portal](#).
 2. Go to [Tanzu Application Platform \(TAP\)](#) and expand the **VMware Tanzu Application Platform** dropdown.
 3. Click the Token Download icon next to the Tanzu Application Platform version you want to download.

Release	Release Level Info	Language	
1.10.1	521283	English	
1.10.0	360181	English	
1.9.1	360147	English	

- Follow the instructions in the dialog box. Save the token as a variable named `MY_BROADCOM_SUPPORT_ACCESS_TOKEN`. For example:

```
export MY_BROADCOM_SUPPORT_ACCESS_TOKEN=API-TOKEN
```

Where `API-TOKEN` is your token from the Broadcom Support Portal.

- Set up environment variables for installation use by running:

```
# Set tanzu.packages.broadcom.com as the source registry to copy the Tanzu Appl
# ication Platform packages from.
export IMGPKG_REGISTRY_HOSTNAME_0=tanzu.packages.broadcom.com
export IMGPKG_REGISTRY_USERNAME_0=MY-BROADCOM-SUPPORT-USERNAME
export IMGPKG_REGISTRY_PASSWORD_0=${MY_BROADCOM_SUPPORT_ACCESS_TOKEN}

# The user's registry for copying the Tanzu Application Platform package to.
export IMGPKG_REGISTRY_HOSTNAME_1=MY-REGISTRY
export IMGPKG_REGISTRY_USERNAME_1=MY-REGISTRY-USER
export IMGPKG_REGISTRY_PASSWORD_1=MY-REGISTRY-PASSWORD
# These environment variables starting with IMGPKG_* are used by the imgpkg com
# mand only.

# The registry from which the Tanzu Application Platform package is retrieved.
export INSTALL_REGISTRY_USERNAME="${IMGPKG_REGISTRY_USERNAME_1}"
export INSTALL_REGISTRY_PASSWORD="${IMGPKG_REGISTRY_PASSWORD_1}"
export INSTALL_REGISTRY_HOSTNAME="${IMGPKG_REGISTRY_HOSTNAME_1}"
export TAP_VERSION=VERSION-NUMBER
export INSTALL_REPO=TARGET-REPOSITORY
```

Where:

- `MY-BROADCOM-SUPPORT-USERNAME` is the user with access to the images in `tanzu.packages.broadcom.com`.
- `MY-REGISTRY` is your own container registry.
- `MY-REGISTRY-USER` is the user with write access to `MY-REGISTRY`.
- `MY-REGISTRY-PASSWORD` is the password for `MY-REGISTRY-USER`.
- `VERSION-NUMBER` is your Tanzu Application Platform version. For example, `1.6.13`.
- `TARGET-REPOSITORY` is your target repository. This is a folder or repository on `MY-REGISTRY` that serves as the location for the Tanzu Application Platform installation files.

- Install the Carvel tool `imgpkg` CLI.
- Relocate the images with the `imgpkg` CLI by running:

```
imgpkg copy -b tanzu.packages.broadcom.com/tanzu-application-platform/tap-pack
ages:${TAP_VERSION} --to-repo ${INSTALL_REGISTRY_HOSTNAME}/${INSTALL_REPO}/tap-
packages
```

Add the Tanzu Application Platform package repository

Tanzu CLI packages are available through repositories. Adding the Tanzu Application Platform package repository makes Tanzu Application Platform and its packages available for installation.

To add the Tanzu Application Platform package repository to your cluster:

1. Create a namespace called `tap-install` for deploying any component packages by running:

```
kubectl create ns tap-install
```

This namespace keeps the objects grouped together logically.

2. Create a registry secret by running:

```
tanzu secret registry add tap-registry \
  --username ${INSTALL_REGISTRY_USERNAME} --password ${INSTALL_REGISTRY_PASSWORD} \
  --server ${INSTALL_REGISTRY_HOSTNAME} \
  --export-to-all-namespaces --yes --namespace tap-install
```

3. (Optional) Create a registry secret for your writable image repository used for:

- Tanzu Build Service Dependencies
- Workloads when using the `shared.image_registry` key

```
tanzu secret registry add image-registry-creds \
  --server "${REGISTRY_HOSTNAME}" \
  --username "${REGISTRY_USERNAME}" \
  --password "${REGISTRY_PASSWORD}" \
  --namespace tap-install
```

Where:

- `REGISTRY_HOSTNAME` is the host name for the registry that contains your writable repository. Examples:
 - Harbor has the form `--server "my-harbor.io"`.
 - Docker Hub has the form `--server "index.docker.io"`.
 - Google Cloud Registry has the form `--server "gcr.io"`.
- `REGISTRY_USERNAME` and `REGISTRY_PASSWORD` are the user name and password for the user that can write to the repository used in the following step. For Google Cloud Registry, use `_json_key` as the user name and the contents of the service account JSON file for the password.



Note

If using the same repository as `tap-registry`, you can skip this step and use the `tap-registry` secret in your `tap-values.yaml` instead of `image-registry-creds`.

4. Add the Tanzu Application Platform package repository to the cluster by running:

```
tanzu package repository add tanzu-tap-repository \
  --url ${INSTALL_REGISTRY_HOSTNAME}/${INSTALL_REPO}/tap-packages:$TAP_VERSION \
  --namespace tap-install
```

5. Get the status of the Tanzu Application Platform package repository, and ensure the status updates to `Reconcile succeeded` by running:

```
tanzu package repository get tanzu-tap-repository --namespace tap-install
```

For example:

```
$ tanzu package repository get tanzu-tap-repository --namespace tap-install
- Retrieving repository tap...
NAME:          tanzu-tap-repository
VERSION:       16253001
REPOSITORY:    tapmdc.azurecr.io/mdc/1.4.0/tap-packages
TAG:           1.6.13
STATUS:        Reconcile succeeded
REASON:
```



Note

The **VERSION** and **TAG** numbers differ from the earlier example if you are on Tanzu Application Platform v1.0.2 or earlier.

6. List the available packages by running:

```
tanzu package available list --namespace tap-install
```

For example:

```
$ tanzu package available list --namespace tap-install
/ Retrieving available packages...
NAME                                DISPLAY-NAME
SHORT-DESCRIPTION
  accelerator.apps.tanzu.vmware.com  Application Accelerator
for VMware Tanzu                    Used to create new projects a
nd configurations.
  api-portal.tanzu.vmware.com        API portal
A unified user interface for API discovery and exploration at scale.
  apis.apps.tanzu.vmware.com         API Auto Registration fo
r VMware Tanzu                    A TAP component to automatica
lly register API exposing workloads as API entities
in TAP GUI.
  backend.appliveview.tanzu.vmware.com Application Live View fo
r VMware Tanzu                    App for monitoring and troubl
eshooting running apps
  buildservice.tanzu.vmware.com      Tanzu Build Service
Tanzu Build Service enables the building and automation of containerized
software workflows securely and at scale.
  carbonblack.scanning.apps.tanzu.vmware.com VMware Carbon Black for
Supply Chain Security Tools - Scan Default scan templates using
VMware Carbon Black
  cartographer.tanzu.vmware.com      Cartographer
Kubernetes native Supply Chain Choreographer.
  cnrs.tanzu.vmware.com              Cloud Native Runtimes
Cloud Native Runtimes is a serverless runtime based on Knative
  connector.appliveview.tanzu.vmware.com Application Live View Co
nnecter for VMware Tanzu          App for discovering and regis
tering running apps
  controller.source.apps.tanzu.vmware.com Tanzu Source Controller
Tanzu Source Controller enables workload create/update from source code.
  conventions.appliveview.tanzu.vmware.com Application Live View Co
nventions for VMware Tanzu        Application Live View convent
ion server
  developer-conventions.tanzu.vmware.com Tanzu App Platform Devel
oper Conventions                  Developer Conventions
```

eventing.tanzu.vmware.com	Eventing
Eventing is an event-driven architecture platform based on Knative Eventing	
external-secrets.apps.tanzu.vmware.com	External Secrets Operator
External Secrets Operator is a Kubernetes operator that integrates external	
secret management systems.	
fluxcd.source.controller.tanzu.vmware.com	Flux Source Controller
The source-controller is a Kubernetes operator, specialised in artifacts	
acquisition from external sources such as Git, Helm repositories and S3 buckets.	
grype.scanning.apps.tanzu.vmware.com	Grype for Supply Chain Security Tools - Scan
AnchorGrype	Default scan templates using
learningcenter.tanzu.vmware.com	Learning Center for Tanzu Application Platform
Guided technical workshops	
metadata-store.apps.tanzu.vmware.com	Supply Chain Security Tools - Store
Post SBOMs and query for image, package, and vulnerability metadata.	
namespace-provisioner.apps.tanzu.vmware.com	Namespace Provisioner
Automatic Provisioning of Developer Namespaces.	
ootb-delivery-basic.tanzu.vmware.com	Tanzu App Platform Out of The Box Delivery Basic
Out of The Box Delivery Basic.	
ootb-supply-chain-basic.tanzu.vmware.com	Tanzu App Platform Out of The Box Supply Chain Basic
Out of The Box Supply Chain Basic.	
ootb-supply-chain-testing-scanning.tanzu.vmware.com	Tanzu App Platform Out of The Box Supply Chain with Testing and Scanning
Out of The Box Supply Chain with Testing and Scanning.	
ootb-supply-chain-testing.tanzu.vmware.com	Tanzu App Platform Out of The Box Supply Chain with Testing
Out of The Box Supply Chain with Testing.	
ootb-templates.tanzu.vmware.com	Tanzu App Platform Out of The Box Templates
Out of The Box Templates.	
policy.apps.tanzu.vmware.com	Supply Chain Security Tools - Policy Controller
Policy Controller enables defining of a policy to restrict unsigned container	
images.	
scanning.apps.tanzu.vmware.com	Supply Chain Security Tools - Scan
Scan for vulnerabilities and enforce policies directly within Kubernetes native	
Supply Chains.	
service-bindings.labs.vmware.com	Service Bindings for Kubernetes
Service Bindings for Kubernetes implements the Service Binding Specification.	
services-toolkit.tanzu.vmware.com	Services Toolkit
The Services Toolkit enables the management, lifecycle, discoverability and	
connectivity of Service Resources (databases, message queues, DNS records,	
etc.).	
snky.scanning.apps.tanzu.vmware.com	Snyk for Supply Chain Security Tools - Scan
Default scan templates using Snyk	
spring-boot-conventions.tanzu.vmware.com	Tanzu Spring Boot Conventions Server
Default Spring Boot convention server.	
sso.apps.tanzu.vmware.com	AppSSO
Application Single Sign-On for Tanzu	
tap-auth.tanzu.vmware.com	Default roles for Tanzu Application Platform
Default roles for Tanzu Application Platform	

tap-gui.tanzu.vmware.com	Tanzu Application Platform GUI
tap-telemetry.tanzu.vmware.com	Telemetry Collector for Tanzu Application Platform
tap.tanzu.vmware.com	Tanzu Application Platform Package to install a set of TAP components to get you started based on your use case.
tekton.tanzu.vmware.com	Tekton Pipelines
workshops.learningcenter.tanzu.vmware.com	Workshop Building Tutorial

Install your Tanzu Application Platform profile

The `tap.tanzu.vmware.com` package installs predefined sets of packages based on your profile settings. This is done by using the package manager installed by Tanzu Cluster Essentials.

For more information about profiles, see [Components and installation profiles](#).

To prepare to install a profile:

1. List version information for the package by running:

```
tanzu package available list tap.tanzu.vmware.com --namespace tap-install
```

2. Create a `tap-values.yaml` file by using the [Full Profile sample](#) in the following section as a guide. These samples have the minimum configuration required to deploy Tanzu Application Platform. The sample values file contains the necessary defaults for:
 - The meta-package, or parent Tanzu Application Platform package.
 - Subordinate packages, or individual child packages.

Keep the values file for future configuration use.



Note

`tap-values.yaml` is set as a Kubernetes secret, which provides secure means to read credentials for Tanzu Application Platform components.

3. [View possible configuration settings for your package](#)

Full profile

The following is the YAML file sample for the full-profile. The `profile:` field takes `full` as the default value, but you can also set it to `iterate`, `build`, `run` or `view`. Refer to [Install multicluster Tanzu Application Platform profiles](#) for more information.

```
shared:
  ingress_domain: "INGRESS-DOMAIN"
  image_registry:
    project_path: "SERVER-NAME/REPO-NAME"
  secret:
    name: image-registry-creds
    namespace: tap-install
  kubernetes_distribution: "openshift" # To be passed only for OpenShift. Defaults to "".
```

```

kubernetes_version: "K8S-VERSION"
ca_cert_data: | # To be passed if using custom certificates.
  -----BEGIN CERTIFICATE-----
  MIIFXzCCA0egAwIBAgIJAjYm37SFocjlMA0GCSqGSIb3DQEjBQUAMEY...
  -----END CERTIFICATE-----

ceip_policy_disclosed: FALSE-OR-TRUE-VALUE # Installation fails if this is not set to
true. Not a string.

#The above keys are minimum numbers of entries needed in tap-values.yaml to get a func
tioning TAP Full profile installation.

#Below are the keys which may have default values set, but can be overridden.

profile: full # Can take iterate, build, run, view.

supply_chain: basic # Can take testing, testing_scanning.

ootb_supply_chain_basic: # Based on supply_chain set above, can be changed to ootb_sup
ply_chain_testing, ootb_supply_chain_testing_scanning.
  registry:
    server: "SERVER-NAME" # Takes the value from shared section above by default, but
can be overridden by setting a different value.
    repository: "REPO-NAME" # Takes the value from shared section above by default, bu
t can be overridden by setting a different value.
  gitops:
    ssh_secret: "SSH-SECRET-KEY" # Takes "" as value by default; but can be overridden
by setting a different value.

contour:
  envoy:
    service:
      type: LoadBalancer # This is set by default, but can be overridden by setting a
different value.

buildservice:
  kp_default_repository: "KP-DEFAULT-REPO"
  kp_default_repository_secret: # Takes the value from the shared section by default,
but can be overridden by setting a different value.
  name: image-registry-creds
  namespace: tap-install

local_source_proxy:
  # Takes the value from the project_path under the image_registry section of shared b
y default, but can be overridden by setting a different value.
  repository: "EXTERNAL-REGISTRY-FOR-LOCAL-SOURCE"
  push_secret:
    # When set to true, the secret mentioned in this section is automatically exported
to Local Source Proxy's namespace.
    name: "EXTERNAL-REGISTRY-FOR-LOCAL-SOURCE-SECRET"
    namespace: "EXTERNAL-REGISTRY-FOR-LOCAL-SOURCE-SECRET-NAMESPACE"
    # When set to true, the secret mentioned in this section is automatically exported
to Local Source Proxy's namespace.
    create_export: true

tap_gui:
  app_config:
    auth:
      allowGuestAccess: true # This allows unauthenticated users to log in to your po
rtal. If you want to deactivate it, make sure you configure an alternative auth provid
er.
    catalog:
      locations:
        - type: url
          target: https://GIT-CATALOG-URL/catalog-info.yaml

```

```

metadata_store:
  ns_for_export_app_cert: "MY-DEV-NAMESPACE"
  app_service_type: ClusterIP # Defaults to LoadBalancer. If shared.ingress_domain is
  set earlier, this must be set to ClusterIP.

scanning:
  metadataStore:
    url: "" # Configuration is moved, so set this string to empty.

```



Important

Installing Grype by using `tap-values.yaml` as follows is deprecated in v1.6 and will be removed in v1.8:

```

grype:
  namespace: "MY-DEV-NAMESPACE"
  targetImagePullSecret: "TARGET-REGISTRY-CREDENTIALS-SECRET"

```

You can install Grype by using Namespace Provisioner instead.

Where:

- `INGRESS-DOMAIN` is the subdomain for the host name that you point at the `tanzu-shared-ingress` service's External IP address.
- `KP-DEFAULT-REPO` is a writable repository in your registry. Tanzu Build Service dependencies are written to this location. Examples:
 - Harbor has the form `kp_default_repository: "my-harbor.io/my-project/build-service"`.
 - Docker Hub has the form `kp_default_repository: "my-dockerhub-user/build-service"` Or `kp_default_repository: "index.docker.io/my-user/build-service"`.
 - Google Cloud Registry has the form `kp_default_repository: "gcr.io/my-project/build-service"`.
- `K8S-VERSION` is the Kubernetes version used by your OpenShift cluster. It must be in the form of `1.25.x` or `1.26.x`, where `x` stands for the patch version. Examples:
 - Red Hat OpenShift Container Platform v4.12 uses the Kubernetes version `1.25.2`.
 - Red Hat OpenShift Container Platform v4.13 uses the Kubernetes version `1.26.3`.
- `SERVER-NAME` is the host name of the registry server. Examples:
 - Harbor has the form `server: "my-harbor.io"`.
 - Docker Hub has the form `server: "index.docker.io"`.
 - Google Cloud Registry has the form `server: "gcr.io"`.
- `REPO-NAME` is where workload images are stored in the registry. If this key is passed through the shared section earlier and AWS ECR registry is used, you must ensure that the `SERVER-NAME/REPO-NAME/buildservice` and `SERVER-NAME/REPO-NAME/workloads` exist. AWS ECR expects the paths to be pre-created. Images are written to `SERVER-NAME/REPO-NAME/workload-name`. Examples:
 - Harbor has the form `repository: "my-project/supply-chain"`.
 - Docker Hub has the form `repository: "my-dockerhub-user"`.
 - Google Cloud Registry has the form `repository: "my-project/supply-chain"`.

- `EXTERNAL-REGISTRY-FOR-LOCAL-SOURCE` is where the developer's local source is uploaded when using Tanzu CLI to use Local Source Proxy for workload creation.

If an AWS ECR registry is being used, ensure that the repository already exists. AWS ECR expects the repository path to already exist. This destination is represented as `REGISTRY-SERVER/REPOSITORY-PATH`. For more information, see [Install Local Source Proxy](#).

- `EXTERNAL-REGISTRY-FOR-LOCAL-SOURCE-SECRET` is the name of the secret with credentials that allow pushing to the `EXTERNAL-REGISTRY-FOR-LOCAL-SOURCE` repository.
- `EXTERNAL-REGISTRY-FOR-LOCAL-SOURCE-SECRET-NAMESPACE` is the namespace in which `EXTERNAL-REGISTRY-FOR-LOCAL-SOURCE-SECRET` is available.
- `SSH-SECRET-KEY` is the SSH secret key in the developer namespace for the supply chain to fetch source code from and push configuration to. This field is only required if you use a private repository, otherwise, leave it empty. See [Git authentication](#) for more information.
- `GIT-CATALOG-URL` is the path to the `catalog-info.yaml` catalog definition file. You can download either a blank or populated catalog file from the [Broadcom Support Portal](#) (file name **Tanzu Application Platform Developer Portal Blank Catalog** or **Tanzu Application Platform Developer Portal Yelb Catalog**). Otherwise, you can use a Backstage-compliant catalog you've already built and posted on the Git infrastructure.
- `MY-DEV-NAMESPACE` is the name of the developer namespace. SCST - Store exports secrets to the namespace, and SCST - Scan deploys the `ScanTemplates` there. This allows the scanning feature to run in this namespace. If there are multiple developer namespaces, use `ns_for_export_app_cert: "*"` to export the SCST - Store CA certificate to all namespaces.
- `TARGET-REGISTRY-CREDENTIALS-SECRET` is the name of the secret that contains the credentials to pull an image from the registry for scanning.

Tanzu Application Platform is part of [VMware's CEIP program](#) where data is collected to help improve the customer experience. By setting `ceip_policy_disclosed` to `true` (not a string), you acknowledge the program is disclosed to you and you are aware data collection is happening. This field must be set for the installation to be completed. See [Opt out of telemetry collection](#) for more information.

If you use custom CA certificates, you must provide one or more PEM-encoded CA certificates under the `ca_cert_data` key. If you configured `shared.ca_cert_data`, Tanzu Application Platform component packages inherit that value by default.

If you use AWS, the default settings creates a classic LoadBalancer. To use the Network LoadBalancer instead of the classic LoadBalancer for ingress, add the following to your `tap-values.yaml`:

```
contour:
  infrastructure_provider: aws
envoy:
  service:
    aws:
      LBType: nlb
```

(Optional) Additional Build Service configurations

The following tasks are optional during the Tanzu Application Platform installation process:

- [\(Optional\) Configure your profile with full dependencies](#)
- [\(Optional\) Configure your profile with the Jammy stack only](#)

(Optional) Configure your profile with full dependencies

When you install a profile that includes Tanzu Build Service, Tanzu Application Platform is installed with the `lite` set of dependencies. These dependencies consist of `buildpacks` and `stacks` required for application builds.

The `lite` set of dependencies do not contain all buildpacks and stacks. To use all buildpacks and stacks, you must install the `full` dependencies. For more information about the differences between `lite` and `full` dependencies, see [About lite and full dependencies](#).

To configure `full` dependencies, add the key-value pair `exclude_dependencies: true` to your `tap-values.yaml` file under the `buildservice` section. For example:

```
buildservice:
  ...
  exclude_dependencies: true
  ...
```

After configuring `full` dependencies, you must install the dependencies after you have finished installing your Tanzu Application Platform package. See [Install the full dependencies package](#) for more information.

(Optional) Configure your profile with the Jammy stack only

Tanzu Application Platform v1.5.0 supports building applications with both the Ubuntu v22.04 (Jammy) and v18.04 (Bionic) stack. For more information, see [Bionic and Jammy stacks](#).

To install Tanzu Application Platform with Jammy as the only available stack, include the `stack_configuration: jammy-only` field under the `buildservice:` section in `tap-values.yaml`.

Security Context Constraints

Security Context Constraints (SCC) define a set of rules that a pod must satisfy to be created. Tanzu Application Platform components use the built-in `nonroot-v2` or `restricted-v2` SCC.

In Red Hat OpenShift, SCC are used to restrict privileges for pods. In Tanzu Application Platform v1.4 there is no custom SCC.

Tanzu Application Platform packages reconcile without any issues when using OpenShift v4.11 with `restricted-v2` or `nonroot-v2`.

(Optional) Exclude components that require RedHat OpenShift privileged SCC

Learning Center package uses privileged SCC. To exclude this package, update your `tap-values` file with a section listing the exclusions:

```
...
excluded_packages:
  - learningcenter.tanzu.vmware.com
  - workshops.learningcenter.tanzu.vmware.com
...
```

See [Exclude packages from a Tanzu Application Platform profile](#) for more information.

Install your Tanzu Application Platform package

Follow these steps to install the Tanzu Application Platform package:

1. Install the package by running:

```
tanzu package install tap -p tap.tanzu.vmware.com -v $TAP_VERSION --values-file
```

```
tap-values.yaml -n tap-install
```

2. Verify the package install by running:

```
tanzu package installed get tap -n tap-install
```

This can take 5-10 minutes because it installs several packages on your cluster.

3. Verify that the necessary packages in the profile are installed by running:

```
tanzu package installed list -A
```

4. If you configured `full` dependencies in your `tbs-values.yaml` file, install the `full` dependencies by following the procedure in [Install full dependencies](#).

After installing the Full profile on your cluster, you can install the Tanzu Developer Tools for VS Code Extension to help you develop against it. For instructions, see [Install Tanzu Developer Tools for your VS Code](#).



Note

You can run the following command after reconfiguring the profile to reinstall the Tanzu Application Platform:

```
tanzu package installed update tap -p tap.tanzu.vmware.com -v $TAP_VERSION --values-file tap-values.yaml -n tap-install
```

Install the full dependencies package

If you configured `full` dependencies in your `tap-values.yaml` file in [Configure your profile with full dependencies](#) earlier, you must install the `full` dependencies package.

For more information about the differences between `lite` and `full` dependencies, see [About lite and full dependencies](#).

To install the `full` dependencies package:

1. If you have not done so already, add the key-value pair `exclude_dependencies: true` to your `tap-values.yaml` file under the `buildservice` section. For example:

```
buildservice:
  ...
  exclude_dependencies: true
  ...
```

2. Get the latest version of the `tap` package by running:

```
tanzu package available list tap.tanzu.vmware.com --namespace tap-install
```

3. Relocate the Tanzu Build Service full dependencies package repository by running:

```
imgpkg copy -b tanzu.packages.broadcom.com/tanzu-application-platform/full-deps
-package-repo:VERSION \
--to-repo ${INSTALL_REGISTRY_HOSTNAME}/${INSTALL_REPO}/full-deps-package-repo
```

Where `VERSION` is the version of the `tap` package you retrieved in the previous step.

4. Add the Tanzu Build Service full dependencies package repository by running:

```
tanzu package repository add full-deps-package-repo \
  --url ${INSTALL_REGISTRY_HOSTNAME}/${INSTALL_REPO}/full-deps-package-repo:VER
SION \
  --namespace tap-install
```

Where `VERSION` is the version of the `tap` package you retrieved earlier.

5. Install the full dependencies package by running:

```
tanzu package install full-deps -p full-deps.buildservice.tanzu.vmware.com -v
"> 0.0.0" -n tap-install --values-file PATH-TO-TAP-VALUES-FILE
```

Access Tanzu Developer Portal

To access Tanzu Developer Portal (formerly named Tanzu Application Platform GUI), you can use the host name that you configured earlier. This host name is pointed at the shared ingress. To configure LoadBalancer for Tanzu Developer Portal, see [Access Tanzu Developer Portal](#).

You're now ready to start using Tanzu Developer Portal. Proceed to the [Getting Started](#) topic or the [Tanzu Developer Portal - Catalog Operations](#) topic.

Exclude packages from a Tanzu Application Platform profile

To exclude packages from a Tanzu Application Platform profile:

1. Find the full subordinate (child) package name:

```
tanzu package available list --namespace tap-install
```

2. Update your `tap-values` file with a section listing the exclusions:

```
profile: PROFILE-VALUE
excluded_packages:
  - tap-gui.tanzu.vmware.com
  - service-bindings.lab.vmware.com
```



Important

If you exclude a package after performing a profile installation including that package, you cannot see the accurate package states immediately after running `tap package installed list -n tap-install`. Also, you can break package dependencies by removing a package. Allow 20 minutes to verify that all packages have reconciled correctly while troubleshooting.

View possible configuration settings for your package

To view possible configuration settings for a package, run:

```
tanzu package available get tap.tanzu.vmware.com/$TAP_VERSION --values-schema --namesp
ace tap-install
```



Note

The `tap.tanzu.vmware.com` package does not show all configuration settings for packages it plans to install. The package only shows top-level keys. You can view individual package configuration settings with the same `tanzu package available get` command. For example, to find the keys for Cloud Native Runtimes, you must first identify the version of the package with `tanzu package installed list -n tap-install`, which lists all the installed packages versions. Then run the command `tanzu package available get -n tap-install cnrs.tanzu.vmware.com/CNR-VERSION --values-schema` by using the package version listed for Cloud Native Runtimes.

```
profile: full

# Shared configurations go under the shared key.
shared:
  ingress_domain: tap.example.com

# ...

# For example, Cloud Native Runtimes specific values go under its name.
cnrs:
  provider: local

# For example, App Accelerator specific values go under its name.
accelerator:
  server:
    service_type: "ClusterIP"
```

Shared Keys define values that configure multiple packages. These keys are defined under the `shared` Top-level Key, as summarized in the following table:

Shared Key	Description	Optional
<code>ca_cert_data</code>	PEM-encoded certificate data to trust TLS connections with a private CA. This shared key is used by <code>convention_controller</code> , <code>scanning</code> and the Tanzu <code>source_controller</code> (not the Flux CD Source Controller).	Yes
<code>ingress_domain</code>	Domain name to be used in service routes and host names for instances of Tanzu Application Platform components.	Yes
<code>ingress_issuer</code>	A <code>cert-manager.io/v1/ClusterIssuer</code> for issuing TLS certificates to Tanzu Application Platform components. Default value: <code>tap-ingress-selfsigned</code>	Yes
<code>kubernetes_distribution</code>	Type of Kubernetes infrastructure being used. You can use this shared key in coordination with the <code>kubernetes_version</code> key. Supported value: <code>openshift</code> .	Yes
<code>kubernetes_version</code>	Kubernetes version. You can use this shared key independently or in coordination with the <code>kubernetes_distribution</code> key. Supported value: <code>1.24.x</code> , where <code>x</code> stands for the Kubernetes patch version.	Yes
<code>image_registry.project_path</code>	Project path in the container image registry server used for builder and application images.	Yes
<code>image_registry.username</code>	User name for the container image registry. Mutually exclusive with <code>shared.image_registry.secret.name/namespace</code>	Yes
<code>image_registry.password</code>	Password for the container image registry. Mutually exclusive with <code>shared.image_registry.secret.name/namespace</code>	Yes
<code>secret.name</code>	Secret name for the container image registry credentials of type <code>kubernetes.io/dockerconfigjson</code> . Mutually exclusive with <code>shared.image_registry.username/password</code>	Yes

Shared Key	Description	Optional
<code>secret.namespace</code>	Secret namespace for the container image registry credentials. Mutually exclusive with <code>shared.image_registry.username/password</code>	Yes
<code>activateAppLiveViewSecureAccessController</code>	Enable secure access connection between Application Live View components.	Yes

The following table summarizes the top-level keys used for package-specific configuration within your `tap-values.yaml`.

Package	Top-level Key
See table above.	<code>shared</code>
API Auto Registration	<code>api_auto_registration</code>
API portal	<code>api_portal</code>
Application Accelerator	<code>accelerator</code>
Application Live View	<code>appliveview</code>
Application Live View connector	<code>appliveview_connector</code>
Application Live View conventions	<code>appliveview-conventions</code>
Cartographer	<code>cartographer</code>
Cloud Native Runtimes	<code>cnrs</code>
Source Controller	<code>source_controller</code>
Supply Chain	<code>supply_chain</code>
Supply Chain Basic	<code>ootb_supply_chain_basic</code>
Supply Chain Testing	<code>ootb_supply_chain_testing</code>
Supply Chain Testing Scanning	<code>ootb_supply_chain_testing_scanning</code>
Supply Chain Security Tools - Scan	<code>scanning</code>
Supply Chain Security Tools - Scan (Grype Scanner)	<code>grype</code>
Supply Chain Security Tools - Store	<code>metadata_store</code>
Build Service	<code>buildservice</code>
Tanzu Developer Portal	<code>tap_gui</code>
Learning Center	<code>learningcenter</code>

For information about package-specific configuration, see [Install individual packages](#).

Install individual packages

You can install Tanzu Application Platform (commonly known as TAP) through predefined profiles or through individual packages. Use this topic to learn how to install each individual package. For more information about installing through profiles, see [Components and installation profiles](#).

Installing individual Tanzu Application Platform packages is useful if you do not want to use a profile to install packages or if you want to install additional packages after installing a profile. Before installing the packages, be sure to complete the prerequisites, configure and verify the cluster, and install the Tanzu CLI with any required plug-ins. For more information, see [Prerequisites](#).

Install pages for individual Tanzu Application Platform packages

- [Install API Auto Registration](#)
- [Install API portal](#)
- [Install Application Accelerator](#)
- [Install Application Configuration Service](#)
- [Install Application Live View](#)
- [Install Application Single Sign-On](#)
- [Install Bitnami Services](#)
- [Install cert-manager](#)
- [Install Cloud Native Runtimes](#)
- [Install Contour](#)
- [Install Crossplane](#)
- [Install default roles for Tanzu Application Platform](#)
- [Install Developer Conventions](#)
- [Install Eventing](#)
- [Install Flux CD Source Controller](#)
- [Install Learning Center for Tanzu Application Platform](#)
- [Install Out of the Box Templates](#)
- [Install Out of the Box Supply Chain with Testing](#)
- [Install Out of the Box Supply Chain with Testing and Scanning](#)
- [Install Service Bindings](#)
- [Install Services Toolkit](#)
- [Install Source Controller](#)
- [Install Spring Boot conventions](#)
- [Install Supply Chain Choreographer](#)
- [Install Supply Chain Security Tools - Store](#)
- [Install Supply Chain Security Tools - Policy Controller](#)
- [Install Supply Chain Security Tools - Scan](#)
- [Install Tanzu Developer Portal](#)
- [Install Tanzu Build Service](#)
- [Install Tekton](#)
- [Install Telemetry](#)

Verify the installed packages

Use the following procedure to verify that the packages are installed.

1. List the installed packages by running:

```
tanzu package installed list --namespace tap-install
```

For example:

```
$ tanzu package installed list --namespace tap-install
\ Retrieving installed packages...
NAME                                PACKAGE-NAME                                PAC
KAGE-VERSION  STATUS
api-portal    api-portal.tanzu.vmware.com                1.
0.3           Reconcile succeeded
app-accelerator  accelerator.apps.tanzu.vmware.com          1.
0.0           Reconcile succeeded
app-live-view   appliveview.tanzu.vmware.com               1.
0.2           Reconcile succeeded
appliveview-conventions  build.appliveview.tanzu.vmware.com         1.
0.2           Reconcile succeeded
cartographer    cartographer.tanzu.vmware.com              0.
1.0           Reconcile succeeded
cloud-native-runtimes  cnrs.tanzu.vmware.com                      1.
0.3           Reconcile succeeded
convention-controller  controller.conventions.apps.tanzu.vmware.com  0.
7.0           Reconcile succeeded
developer-conventions  developer-conventions.tanzu.vmware.com       0.
3.0-build.1   Reconcile succeeded
grype-scanner    grype.scanning.apps.tanzu.vmware.com        1.
0.0           Reconcile succeeded
image-policy-webhook  image-policy-webhook.signing.apps.tanzu.vmware.com  1.
1.2           Reconcile succeeded
metadata-store    metadata-store.apps.tanzu.vmware.com         1.
0.2           Reconcile succeeded
ootb-supply-chain-basic  ootb-supply-chain-basic.tanzu.vmware.com      0.
5.1           Reconcile succeeded
ootb-templates    ootb-templates.tanzu.vmware.com             0.
5.1           Reconcile succeeded
scan-controller   scanning.apps.tanzu.vmware.com              1.
0.0           Reconcile succeeded
service-bindings  service-bindings.labs.vmware.com            0.
5.0           Reconcile succeeded
services-toolkit  services-toolkit.tanzu.vmware.com            0.
8.0           Reconcile succeeded
source-controller  controller.source.apps.tanzu.vmware.com      0.
2.0           Reconcile succeeded
sso4k8s-install   sso.apps.tanzu.vmware.com                   1.
0.0-beta.2-31   Reconcile succeeded
tap-gui          tap-gui.tanzu.vmware.com                    0.
3.0-rc.4       Reconcile succeeded
tekton-pipelines  tekton.tanzu.vmware.com                     0.3
0.0           Reconcile succeeded
tbs             buildservice.tanzu.vmware.com                1.
5.0           Reconcile succeeded
```

Next steps

- [Set up developer namespaces to use your installed packages](#)

Set up developer namespaces to use your installed packages

For details about how to automatically set up your developer namespaces, see [Provision developer namespaces in Namespace Provisioner](#).

Additional configuration for testing and scanning

If you plan to install or have already installed Out of the Box Supply Chains with Testing and Scanning, you can use Namespace Provisioner to set up the required resources. For more information, see [Customize installation](#) in the Namespace Provisioner documentation for configuration steps.

Legacy namespace setup

To use the legacy manual process for setting up developer namespaces, see [Legacy namespace setup](#).

Next steps

- [Install Tanzu Developer Tools for your VS Code](#)

Install Tanzu Developer Tools for your VS Code

This topic tells you how to install VMware Tanzu Developer Tools for Visual Studio Code (VS Code).

Prerequisites

Before installing the extension, you must have:

- [VS Code](#)
- [kubectl](#)
- [Tilt v0.30.12 or later](#)
- [Tanzu CLI and plug-ins](#)
- [A cluster with the Tanzu Application Platform Full profile or Iterate profile](#)

If you are an app developer, someone else in your organization might have already set up the Tanzu Application Platform environment.

Docker Desktop and local Kubernetes are not prerequisites for using Tanzu Developer Tools for VS Code.

Install

To install the extension:

1. Download Tanzu Developer Tools for Visual Studio Code from the [Broadcom Support Portal](#).
2. Open VS Code.
3. Press `cmd+shift+P` to open the Command Palette and run `Extensions: Install from VSIX...`



4. Select the extension file `tanzu-vscode-extension.vsix`.
5. If you do not have the following extensions, and they do not automatically install, install them from VS Code Marketplace:
 - [Debugger for Java](#)

- [Language Support for Java\(™\) by Red Hat](#)
 - [YAML](#)
6. Ensure Language Support for Java is running in [Standard Mode](#). You can configure it in the **Settings** menu by going to **Code > Preferences > Settings** under **Java > Server: Launch Mode**.

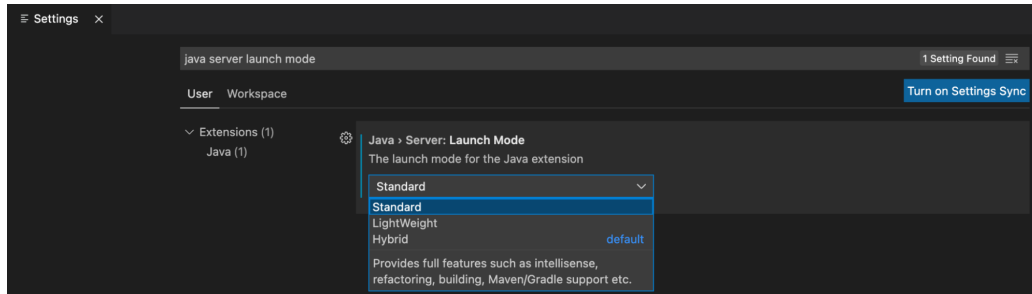

When the JDK and Language Support for Java are configured correctly, you see that the integrated development environment creates a directory target where the code is compiled.

Configure

To configure VMware Tanzu Developer Tools for VS Code:

1. Ensure that you are targeting the correct cluster. For more information, see the [Kubernetes documentation](#).
2. Go to **Code > Preferences > Settings > Extensions > Tanzu Developer Tools** and set the following:
 - **Confirm Delete:** This controls whether the extension asks for confirmation when deleting a workload.
 - **Enable Live Hover:** For more information, see [Integrating Live Hover by using Spring Boot Tools](#). Reload VS Code for this change to take effect.
 - **Source Image:** The registry location for publishing local source code. For example, [registry.io/yourapp-source](#). This must include both a registry and a project name. A source image registry location is optional when Local Source Proxy is configured.
 - **Local Path:** (Optional) The path on the local file system to a directory of source code to build. This is the current directory by default.
 - **Namespace:** (Optional) This is the namespace that workloads are deployed into. The namespace set in [kubeconfig](#) is the default.

Uninstall

To uninstall VMware Tanzu Developer Tools for VS Code:

1. Go to **Code > Preferences > Settings > Extensions**.
2. Right-click the extension and select **Uninstall**.

Next steps

Proceed to [Getting started with Tanzu Developer Tools for Visual Studio Code](#).

Custom Security Context Constraint details for Tanzu Application Platform

Custom Security Context Constraint (commonly known as SCC) details for Tanzu Application Platform (commonly known as TAP) components are as follows:

- [Application Accelerator on OpenShift cluster](#)
- [Application Live View on OpenShift](#)
- [Application Single Sign-On for OpenShift cluster](#)
- [Contour for OpenShift cluster](#)
- [Developer Conventions for OpenShift cluster](#)
- [Tanzu Build Service for OpenShift cluster](#)

Application Accelerator on OpenShift

On OpenShift clusters, Application Accelerator must run with a custom SecurityContextConstraint (SCC) to enable compliance with restricted Kubernetes pod security standards. Tanzu Application Platform configures the following SCC for Application Accelerator when you configure the `kubernetes_distribution: openshift` key in the `tap-values.yaml` file.

Specification follows:

```
#@ load("@ytt:data", "data")
#@ load("@ytt:assert", "assert")

#@ kubernetes_distribution = data.values.kubernetes_distribution
#@ validDistributions = [None, "", "openshift"]
#@ if kubernetes_distribution not in validDistributions:
#@   assert.fail("{} not in {}".format(kubernetes_distribution, validDistributions))
#@ end

#@ if kubernetes_distribution == "openshift":
---
apiVersion: rbac.authorization.k8s.io/v1
kind: Role
metadata:
  name: accelerator-system-nonroot-scc
  namespace: accelerator-system
rules:
- apiGroups:
  - security.openshift.io
  resourceNames:
  - nonroot
  resources:
  - securitycontextconstraints
  verbs:
  - use
---
apiVersion: rbac.authorization.k8s.io/v1
kind: RoleBinding
metadata:
  name: accelerator-system-nonroot-scc
  namespace: accelerator-system
roleRef:
  apiGroup: rbac.authorization.k8s.io
  kind: Role
  name: accelerator-system-nonroot-scc
subjects:
- apiGroup: rbac.authorization.k8s.io
```



```
kind: Group
name: system:serviceaccounts:accelerator-system
#@ end
```

Application Live View on OpenShift

Application Live View must run with a custom SecurityContextConstraint (SCC) to enable compliance with restricted Kubernetes Pod Security Standards on OpenShift. Tanzu Application Platform configures the following SCC for Application Live View back end, Application Live View connector, and Application Live View convention service when you configure the `kubernetes_distribution: openshift` key in the `tap-values.yaml` file.

The following is a `SecurityContextConstraints` specification for Application Live View connector:

```
---
apiVersion: security.openshift.io/v1
kind: SecurityContextConstraints
metadata:
  name: appliveview-connector-restricted-with-seccomp
allowHostDirVolumePlugin: false
allowHostIPC: false
allowHostNetwork: false
allowHostPID: false
allowHostPorts: false
allowPrivilegeEscalation: false
allowPrivilegedContainer: false
allowedCapabilities: null
defaultAddCapabilities: null
fsGroup:
  type: MustRunAs
priority: null
readOnlyRootFilesystem: false
requiredDropCapabilities:
  - ALL
runAsUser:
  type: MustRunAsNonRoot
seLinuxContext:
  type: MustRunAs
supplementalGroups:
  type: RunAsAny
volumes:
  - configMap
  - downwardAPI
  - emptyDir
  - persistentVolumeClaim
  - projected
  - secret
seccompProfiles:
  - runtime/default
```

The preceding `SecurityContextConstraints` specification is applicable to Application Live View back end and Application Live View convention service as well.

Application Single Sign-On for OpenShift cluster

On OpenShift clusters, AppSSO must run with a custom SecurityContextConstraint (SCC) to enable compliance with restricted Kubernetes Pod Security Standards. Tanzu Application Platform configures the following SCC for AppSSO controller and its `AuthServer` managed resources when you configure the `kubernetes_distribution: openshift` key in the `tap-values.yaml` file.

Specification follows:

```

---
kind: SecurityContextConstraints
apiVersion: security.openshift.io/v1
metadata:
  name: appssso-scc
allowHostDirVolumePlugin: false
allowHostIPC: false
allowHostNetwork: false
allowHostPID: false
allowHostPorts: false
allowPrivilegeEscalation: false
allowPrivilegedContainer: false
allowedCapabilities: null
defaultAddCapabilities: null
fsGroup:
  type: MustRunAs
priority: null
readOnlyRootFilesystem: false
requiredDropCapabilities:
  - KILL
  - MKNOD
  - SETUID
  - SETGID
runAsUser:
  type: MustRunAsNonRoot
seLinuxContext:
  type: MustRunAs
volumes:
  - configMap
  - downwardAPI
  - emptyDir
  - persistentVolumeClaim
  - projected
  - secret
seccompProfiles:
  - 'runtime/default'

```

AppSSO controller's [ServiceAccount](#) is given the following additional permissions, including a [use](#) permission for AppSSO SCC, so [AuthServer](#) can use the custom SCC:

```

- apiGroups:
  - security.openshift.io
resources:
  - securitycontextconstraints
verbs:
  - "get"
  - "list"
  - "watch"

```

```

- apiGroups:
  - security.openshift.io
resourceNames:
  - appssso-scc
resources:
  - securitycontextconstraints
verbs:
  - "use"

```

Contour for OpenShift cluster

On OpenShift clusters, Contour must run with a custom SecurityContextConstraint (SCC) to enable compliance with restricted Kubernetes Pod Security Standards. Tanzu Application Platform

configures the following SCC for the service accounts in the `tanzu-system-ingress` namespace, which applies to Contour's controller and Envoy pods, when you configure the `kubernetes_distribution: openshift` key in the `tap-values.yaml` file.

Specification follows:

```

apiVersion: security.openshift.io/v1
kind: SecurityContextConstraints
metadata:
  annotations:
    include.release.openshift.io/ibm-cloud-managed: "true"
    include.release.openshift.io/self-managed-high-availability: "true"
    include.release.openshift.io/single-node-developer: "true"
    kubernetes.io/description: nonroot provides all features of the restricted SCC
    but allows users to run with any non-root UID. The user must specify the UID
    or it must be specified on the by the manifest of the container runtime. On
    top of the legacy 'nonroot' SCC, it also requires to drop ALL capabilities and
    does not allow privilege escalation binaries. It will also default the seccomp
    profile to runtime/default if unset, otherwise this seccomp profile is required.
  name: contour-seccomp-nonroot-v2
allowHostDirVolumePlugin: false
allowHostIPC: false
allowHostNetwork: false
allowHostPID: false
allowHostPorts: false
allowPrivilegeEscalation: false
allowPrivilegedContainer: false
allowedCapabilities:
- NET_BIND_SERVICE
defaultAddCapabilities: null
fsGroup:
  type: RunAsAny
groups: []
priority: null
readOnlyRootFilesystem: false
requiredDropCapabilities:
- ALL
runAsUser:
  type: MustRunAsNonRoot
seLinuxContext:
  type: MustRunAs
seccompProfiles:
- runtime/default
supplementalGroups:
  type: RunAsAny
users: []
volumes:
- configMap
- downwardAPI
- emptyDir
- persistentVolumeClaim
- projected
- secret

```

The SCC is bound to the service accounts by using the following Role and RoleBinding:

```

---
apiVersion: rbac.authorization.k8s.io/v1
kind: Role
metadata:
  name: contour-seccomp-nonroot-v2
  namespace: tanzu-system-ingress
rules:
- apiGroups:

```

```

- security.openshift.io
resourceNames:
- contour-seccomp-nonroot-v2
resources:
- securitycontextconstraints
verbs:
- use
---
apiVersion: rbac.authorization.k8s.io/v1
kind: RoleBinding
metadata:
  name: contour-seccomp-nonroot-v2
  namespace: tanzu-system-ingress
roleRef:
  apiGroup: rbac.authorization.k8s.io
  kind: Role
  name: contour-seccomp-nonroot-v2
subjects:
- apiGroup: rbac.authorization.k8s.io
  kind: Group
  name: system:serviceaccounts:tanzu-system-ingress

```

Developer Conventions for OpenShift cluster

On OpenShift clusters, Developer Conventions must run with a custom SecurityContextConstraint (SCC) to enable compliance with restricted Kubernetes pod security standards. Tanzu Application Platform configures the following SCC for the Developer Convention's webhook when you configure the `kubernetes_distribution: openshift` key in the `tap-values.yaml` file.

Specification follows:

```

---
apiVersion: security.openshift.io/v1
kind: SecurityContextConstraints
metadata:
  name: developer-conventions-scc
allowHostDirVolumePlugin: false
allowHostIPC: false
allowHostNetwork: false
allowHostPID: false
allowHostPorts: false
allowPrivilegeEscalation: false
allowPrivilegedContainer: false
defaultAddCapabilities: null
fsGroup:
  type: RunAsAny
priority: null
readOnlyRootFilesystem: false
requiredDropCapabilities: null
runAsUser:
  type: MustRunAsNonRoot
seLinuxContext:
  type: MustRunAs
supplementalGroups:
  type: RunAsAny
volumes:
- secret
seccompProfiles: []
groups:
- system:serviceaccounts:developer-conventions

```

Tanzu Build Service for OpenShift cluster

On OpenShift clusters Tanzu Build Service must run with a custom [Security Context Constraint \(SCC\)](#) to enable compliance. Tanzu Application Platform configures the following SCC for Tanzu Build Service when you configure the `kubernetes_distribution: openshift` key in the `tap-values.yaml` file.

```
---
kind: SecurityContextConstraints
apiVersion: security.openshift.io/v1
metadata:
  name: tbs-restricted-scc-with-seccomp
allowHostDirVolumePlugin: false
allowHostIPC: false
allowHostNetwork: false
allowHostPID: false
allowHostPorts: false
allowPrivilegeEscalation: false
allowPrivilegedContainer: false
allowedCapabilities:
  - NET_BIND_SERVICE
defaultAddCapabilities: null
fsGroup:
  type: RunAsAny
groups: []
priority: null
readOnlyRootFilesystem: false
requiredDropCapabilities:
  - ALL
runAsUser:
  type: MustRunAsNonRoot
seLinuxContext:
  type: MustRunAs
seccompProfiles:
  - runtime/default
supplementalGroups:
  type: RunAsAny
users: []
volumes:
  - configMap
  - downwardAPI
  - emptyDir
  - persistentVolumeClaim
  - projected
  - secret
```

It also applies the following RBAC to allow Tanzu Build Service services to use the SCC:

```
---
apiVersion: rbac.authorization.k8s.io/v1
kind: ClusterRole
metadata:
  labels:
    apps.tanzu.vmware.com/aggregate-to-workload: "true"
  annotations:
    rbac.authorization.kubernetes.io/autoupdate: "true"
  name: system:tbs:scc:restricted-with-seccomp
rules:
  - apiGroups:
    - security.openshift.io
    resourceNames:
    - tbs-restricted-scc-with-seccomp
    resources:
    - securitycontextconstraints
    verbs:
    - use
```

```

---
apiVersion: rbac.authorization.k8s.io/v1
kind: ClusterRoleBinding
metadata:
  name: system:tbs:scc:restricted-with-seccomp
roleRef:
  apiGroup: rbac.authorization.k8s.io
  kind: ClusterRole
  name: system:tbs:scc:restricted-with-seccomp
subjects:
- kind: ServiceAccount
  namespace: build-service
  name: dependency-updater-serviceaccount
- kind: ServiceAccount
  namespace: build-service
  name: dependency-updater-controller-serviceaccount
- kind: ServiceAccount
  namespace: build-service
  name: secret-syncer-service-account
- kind: ServiceAccount
  namespace: build-service
  name: warmer-service-account
- kind: ServiceAccount
  namespace: build-service
  name: build-service-daemonset-serviceaccount
- kind: ServiceAccount
  namespace: cert-injection-webhook
  name: cert-injection-webhook-sa
- kind: ServiceAccount
  namespace: kpack
  name: kp-default-repository-serviceaccount
- kind: ServiceAccount
  namespace: kpack
  name: kpack-pull-lifecycle-serviceaccount
- kind: ServiceAccount
  namespace: kpack
  name: controller
- kind: ServiceAccount
  namespace: kpack
  name: webhook
- kind: ServiceAccount
  namespace: stacks-operator-system
  name: controller-manager

```

Install Tanzu Application Platform (GitOps)

GitOps is a set of practices and principles to manage Kubernetes infrastructure and application deployments using Git as the single source of truth. It promotes declarative configurations and automated workflows to ensure consistency, reliability, and traceability for your application deployments.

The key components involved in implementing GitOps with Kubernetes include:

- **Git as the single source of truth:** The desired state is stored in a Git repository. To change the cluster state, you must change it in the Git repository instead of modifying it directly on the cluster.
- **Declarative configuration:** GitOps follows a declarative approach, where the desired state is defined in the declarative configuration files.
- **Pull-based synchronization:** GitOps follows a pull-based model. Kubernetes cluster periodically pulls the desired state from the Git repository. This approach ensures that the cluster is always in sync with the desired configuration.

**Caution**

Tanzu Application Platform (GitOps) is currently in beta and is intended for evaluation and test purposes only. Do not use in a production environment.

How Tanzu RI supports GitOps

The Tanzu GitOps Reference Implementation (RI) is built upon Carvel, which shares the same packaging APIs as the Tanzu Application Platform. Carvel packaging APIs support all the GitOps features and enables a native GitOps flow.

- All the packaging APIs are declarative in nature.
- Among many options to fetch the manifest to be deployed, it can also pull the content from the Git repository, making Git the source of truth.
- Packages installed are reconciled every time after the SyncPeriod expires (10 minutes by default). As part of the reconciliation, it fetches the manifest from the Git repository and when the desired state is different from the actual state on Kubernetes, it converges the resources to their desired state declared in Git.

GitOps benefits

GitOps offers the following benefits:

- **Compliance and auditing capabilities:** In GitOps, Git is the single source of truth, enabling auditors to access a complete audit trail of all configuration changes.
- **Disaster recovery:** Disaster recovery involves an organization's efforts to restore access and function to its IT infrastructure. With all configurations securely stored in Git, disaster recovery becomes as straightforward as reapplying the desired configuration version.
- **Repeatable:** Running Tanzu CLI commands with environment variables or configuration files on a local machine is no longer required. Instead, all the necessary configurations and service accounts for access are configured in a shared Git repository. This approach allows any operator to make edits to a file, and the system's behavior remains independent of their local environment.

GitOps install paths

Choose one of the following install paths to install Tanzu Application Platform on your Kubernetes clusters through GitOps:

**Note**

To decide which approach to use, see [Choosing SOPS or ESO](#).

GitOps with Secrets OPERationsS (SOPS)

Applies to the scenario when you want a simple instance and store sensitive data encrypted in your Git repo:

Step	Task	Link
1.	Review the prerequisites to ensure you have met all requirements before installing.	Prerequisites
2.	Install the Tanzu CLI.	Install the Tanzu CLI
3.	Install Cluster Essentials for Tanzu*.	Deploy Cluster Essentials
4.	Install Tanzu Application Platform.	Install Tanzu Application Platform through Gitops with Secrets OPERATIONs (SOPS)
5.	(Optional) Install any additional packages that were not in the profile.	Install individual packages
6.	Set up developer namespaces to use your installed packages.	Set up developer namespaces to use your installed packages
7.	Install developer tools into your integrated development environment (IDE).	Install Tanzu Developer Tools for your VS Code

GitOps with External Secrets Operator (ESO)

AWS Secrets Manager

Applies to the scenario when you want to store sensitive data in AWS Secrets Manager:

Step	Task	Link
1.	Review the prerequisites to ensure you have met all requirements before installing.	Prerequisites
2.	Install the Tanzu CLI.	Install the Tanzu CLI
3.	Create AWS Resources such as EKS cluster and roles)	Create AWS Resources
4.	Install Cluster Essentials for Tanzu*.	Deploy Cluster Essentials
5.	Install Tanzu Application Platform.	Install Tanzu Application Platform through GitOps using AWS Secrets Manager
6.	(Optional) Install any additional packages that were not in the profile.	Install individual packages
7.	Set up developer namespaces to use your installed packages.	Set up developer namespaces to use your installed packages
8.	Install developer tools into your integrated development environment (IDE).	Install Tanzu Developer Tools for your VS Code

HashiCorp Vault

Applies to the scenario when you want to store sensitive data in HashiCorp Vault:

Step	Task	Link
1.	Review the prerequisites to ensure you have met all requirements before installing.	Prerequisites
2.	Install the Tanzu CLI.	Install the Tanzu CLI
3.	Install Cluster Essentials for Tanzu*.	Deploy Cluster Essentials
4.	Install Tanzu Application Platform.	Install Tanzu Application Platform through GitOps using HashiCorp Vault
5.	(Optional) Install any additional packages that were not in the profile.	Install individual packages

Step	Task	Link
6.	Set up developer namespaces to use your installed packages.	Set up developer namespaces to use your installed packages
7.	Install developer tools into your integrated development environment (IDE).	Install Tanzu Developer Tools for your VS Code

* *When you use a VMware Tanzu Kubernetes Grid cluster, there is no need to install Cluster Essentials because the contents of Cluster Essentials are already installed on your cluster.*

After installing Tanzu Application Platform on to your Kubernetes clusters, proceed with [Get started with Tanzu Application Platform](#).

Install Tanzu Application Platform (GitOps)

GitOps is a set of practices and principles to manage Kubernetes infrastructure and application deployments using Git as the single source of truth. It promotes declarative configurations and automated workflows to ensure consistency, reliability, and traceability for your application deployments.

The key components involved in implementing GitOps with Kubernetes include:

- **Git as the single source of truth:** The desired state is stored in a Git repository. To change the cluster state, you must change it in the Git repository instead of modifying it directly on the cluster.
- **Declarative configuration:** GitOps follows a declarative approach, where the desired state is defined in the declarative configuration files.
- **Pull-based synchronization:** GitOps follows a pull-based model. Kubernetes cluster periodically pulls the desired state from the Git repository. This approach ensures that the cluster is always in sync with the desired configuration.



Caution

Tanzu Application Platform (GitOps) is currently in beta and is intended for evaluation and test purposes only. Do not use in a production environment.

How Tanzu RI supports GitOps

The Tanzu GitOps Reference Implementation (RI) is built upon Carvel, which shares the same packaging APIs as the Tanzu Application Platform. Carvel packaging APIs support all the GitOps features and enables a native GitOps flow.

- All the packaging APIs are declarative in nature.
- Among many options to fetch the manifest to be deployed, it can also pull the content from the Git repository, making Git the source of truth.
- Packages installed are reconciled every time after the SyncPeriod expires (10 minutes by default). As part of the reconciliation, it fetches the manifest from the Git repository and when the desired state is different from the actual state on Kubernetes, it converges the resources to their desired state declared in Git.

GitOps benefits

GitOps offers the following benefits:

- **Compliance and auditing capabilities:** In GitOps, Git is the single source of truth, enabling auditors to access a complete audit trail of all configuration changes.
- **Disaster recovery:** Disaster recovery involves an organization’s efforts to restore access and function to its IT infrastructure. With all configurations securely stored in Git, disaster recovery becomes as straightforward as reapplying the desired configuration version.
- **Repeatable:** Running Tanzu CLI commands with environment variables or configuration files on a local machine is no longer required. Instead, all the necessary configurations and service accounts for access are configured in a shared Git repository. This approach allows any operator to make edits to a file, and the system’s behavior remains independent of their local environment.

GitOps install paths

Choose one of the following install paths to install Tanzu Application Platform on your Kubernetes clusters through GitOps:



Note

To decide which approach to use, see [Choosing SOPS or ESO](#).

GitOps with Secrets Operations (SOPS)

Applies to the scenario when you want a simple instance and store sensitive data encrypted in your Git repo:

Step	Task	Link
1.	Review the prerequisites to ensure you have met all requirements before installing.	Prerequisites
2.	Install the Tanzu CLI.	Install the Tanzu CLI
3.	Install Cluster Essentials for Tanzu*.	Deploy Cluster Essentials
4.	Install Tanzu Application Platform.	Install Tanzu Application Platform through Gitops with Secrets OPerationS (SOPS)
5.	(Optional) Install any additional packages that were not in the profile.	Install individual packages
6.	Set up developer namespaces to use your installed packages.	Set up developer namespaces to use your installed packages
7.	Install developer tools into your integrated development environment (IDE).	Install Tanzu Developer Tools for your VS Code

GitOps with External Secrets Operator (ESO)

AWS Secrets Manager

Applies to the scenario when you want to store sensitive data in AWS Secrets Manager:

Step	Task	Link
1.	Review the prerequisites to ensure you have met all requirements before installing.	Prerequisites
2.	Install the Tanzu CLI.	Install the Tanzu CLI

Step	Task	Link
3.	Create AWS Resources such as EKS cluster and roles)	Create AWS Resources
4.	Install Cluster Essentials for Tanzu*.	Deploy Cluster Essentials
5.	Install Tanzu Application Platform.	Install Tanzu Application Platform through GitOps using AWS Secrets Manager
6.	(Optional) Install any additional packages that were not in the profile.	Install individual packages
7.	Set up developer namespaces to use your installed packages.	Set up developer namespaces to use your installed packages
8.	Install developer tools into your integrated development environment (IDE).	Install Tanzu Developer Tools for your VS Code

HashiCorp Vault

Applies to the scenario when you want to store sensitive data in HashiCorp Vault:

Step	Task	Link
1.	Review the prerequisites to ensure you have met all requirements before installing.	Prerequisites
2.	Install the Tanzu CLI.	Install the Tanzu CLI
3.	Install Cluster Essentials for Tanzu*.	Deploy Cluster Essentials
4.	Install Tanzu Application Platform.	Install Tanzu Application Platform through GitOps using HashiCorp Vault
5.	(Optional) Install any additional packages that were not in the profile.	Install individual packages
6.	Set up developer namespaces to use your installed packages.	Set up developer namespaces to use your installed packages
7.	Install developer tools into your integrated development environment (IDE).	Install Tanzu Developer Tools for your VS Code

* When you use a VMware Tanzu Kubernetes Grid cluster, there is no need to install Cluster Essentials because the contents of Cluster Essentials are already installed on your cluster.

After installing Tanzu Application Platform on to your Kubernetes clusters, proceed with [Get started with Tanzu Application Platform](#).

Install Tanzu Application Platform through GitOps with External Secrets Operator (ESO)



Caution

Tanzu Application Platform (GitOps) is currently in beta and is intended for evaluation and test purposes only. Do not use in a production environment.

This topic tells you how to install Tanzu Application Platform (commonly known as TAP) through GitOps with secrets managed externally in AWS Secrets Manager.

Select a secrets manager for external secret storage:

- [AWS Secrets Manager](#)
- [HashiCorp Vault](#)

**Important**

Tanzu GitOps Reference Implementation (RI) does not support changing the secrets management strategy for a cluster.

Install Tanzu Application Platform through GitOps with AWS Secrets Manager

**Caution**

Tanzu Application Platform (GitOps) is currently in beta and is intended for evaluation and test purposes only. Do not use in a production environment.

This topic tells you how to install Tanzu Application Platform (commonly known as TAP) through GitOps with secrets managed externally in AWS Secrets Manager. To decide which approach to use, see [Choosing Secrets OPerationS \(SOPS\) or External Secrets Operator \(ESO\)](#).

Tanzu GitOps Reference Implementation (RI) does not support changing the secrets management strategy for a cluster, for example, SOPS to ESO. However, changing between AWS Secrets Manager and HashiCorp Vault is supported. The External Secrets Operator integration in this release of Tanzu GitOps RI is verified to support AWS Elastic Kubernetes Service (EKS) cluster with AWS Secrets Manager. Other combinations of Kubernetes distribution and ESO providers are not verified.

Prerequisites

Before installing Tanzu Application Platform, ensure you have:

- Completed the [Prerequisites](#).
- Created [AWS Resources](#).
- Installed [Tanzu CLI](#) with any required plug-ins.
- Installed [Cluster Essentials for Tanzu](#).
- Installed [eksctl CLI](#).

Relocate images to a registry

Before installation, you must relocate the Tanzu Application Platform images from tanzu.packages.broadcom.com to your own container image registry.



The supported registries are Harbor, Azure Container Registry, Google Container Registry, and Quay.io. See the following documentation to learn how to set up your container image registry:

- [Harbor documentation](#)
- [Google Container Registry documentation](#)
- [Quay.io documentation](#)

To relocate images from tanzu.packages.broadcom.com to your registry:

1. Retrieve your Broadcom registry API token:
 1. Sign in to the [Broadcom Support Portal](#).

- Go to [Tanzu Application Platform \(TAP\)](#) and expand the **VMware Tanzu Application Platform** dropdown.
- Click the Token Download icon next to the Tanzu Application Platform version you want to download.

Release	Release Level Info	Language	
1.10.1	521283	English	
1.10.0	360181	English	
1.9.1	360147	English	

- Follow the instructions in the dialog box. Save the token as a variable named `MY_BROADCOM_SUPPORT_ACCESS_TOKEN`. For example:

```
export MY_BROADCOM_SUPPORT_ACCESS_TOKEN=API-TOKEN
```

Where `API-TOKEN` is your token from the Broadcom Support Portal.

- Set up environment variables for installation use by running:

```
export IMGPKG_REGISTRY_HOSTNAME_0=tanzu.packages.broadcom.com
export IMGPKG_REGISTRY_USERNAME_0=MY-BROADCOM-SUPPORT-USERNAME
export IMGPKG_REGISTRY_PASSWORD_0=${MY_BROADCOM_SUPPORT_ACCESS_TOKEN}
export IMGPKG_REGISTRY_HOSTNAME_1=MY-REGISTRY
export IMGPKG_REGISTRY_USERNAME_1=MY-REGISTRY-USER
export IMGPKG_REGISTRY_PASSWORD_1=MY-REGISTRY-PASSWORD
export INSTALL_REGISTRY_USERNAME=MY-REGISTRY-USER
export INSTALL_REGISTRY_PASSWORD=MY-REGISTRY-PASSWORD
export INSTALL_REGISTRY_HOSTNAME=MY-REGISTRY
export TAP_VERSION=VERSION-NUMBER
export INSTALL_REPO=TARGET-REPOSITORY
```

Where:

- `MY-BROADCOM-SUPPORT-USERNAME` is the user with access to the images in `tanzu.packages.broadcom.com`.
- `MY-REGISTRY` is your own container registry.
- `MY-REGISTRY-USER` is the user with write access to `MY-REGISTRY`.
- `MY-REGISTRY-PASSWORD` is the password for `MY-REGISTRY-USER`.
- `VERSION-NUMBER` is your Tanzu Application Platform version. For example, `1.6.13`.
- `TARGET-REPOSITORY` is your target repository, a folder or repository on `MY-REGISTRY` that serves as the location for the installation files for Tanzu Application Platform.

VMware recommends using a JSON key file to authenticate with Google Container Registry. In this case, the value of `INSTALL_REGISTRY_USERNAME` is `_json_key` and the value of `INSTALL_REGISTRY_PASSWORD` is the content of the JSON key file. For more information about how to generate the JSON key file, see [Google Container Registry documentation](#).

- Install the Carvel tool `imgpkg` CLI.

To query for the available versions of Tanzu Application Platform on `tanzu.packages.broadcom.com`, run:

```
imgpkg tag list -i tanzu.packages.broadcom.com/tanzu-application-platform/tap-packages | sort -V
```

4. Relocate the images with the `imgpkg` CLI by running:

```
imgpkg copy -b tanzu.packages.broadcom.com/tanzu-application-platform/tap-packages:${TAP_VERSION} --to-repo ${INSTALL_REGISTRY_HOSTNAME}/${INSTALL_REPO}/tap-packages
```

(Optional) Install Tanzu Application Platform in an air-gapped environment

Complete the following steps if you install Tanzu Application Platform in an air-gapped environment:

1. Retrieve the Tanzu Build Service version by running:

```
kubectl get package -n tap-install | grep buildservice
```

2. Relocate the Tanzu Build Service images to your registry by running:

```
imgpkg copy -b tanzu.packages.broadcom.com/tanzu-application-platform/full-tbs-deps-package-repo:TBS-VERSION --to-repo ${INSTALL_REGISTRY_HOSTNAME}/${INSTALL_REPO}/full-tbs-deps-package-repo
```

Where `TBS-VERSION` is the version of Tanzu Build Service you retrieved.

3. [Configure custom certificate authorities for Tanzu Developer Portal.](#)
4. Host a `grype` database in the air-gapped environment. For more information, see [Use Grype in offline and air-gapped environments.](#)

Create a new Git repository

Follow these steps to create a new Git repository:

1. In a hosted Git service, for example, GitHub or GitLab, create a new repository.

This version of Tanzu GitOps RI supports authenticating to a hosted Git repository by using SSH and Basic Authentication.

2. Initialize a new Git repository:

```
mkdir -p $HOME/tap-gitops
cd $HOME/tap-gitops

git init
git remote add origin git@github.com:my-organization/tap-gitops.git
```

3. Set up the authentication method:

SSH

Create a read-only deploy key for this new repository (recommended) or SSH key for an account with read access to this repository. The private portion of this key is referred to as `GIT_SSH_PRIVATE_KEY`.

Basic Authentication

Have a user name with read access to the Git repository and password or personal access token for the same user.



Important

Only use one of `ssh` or `Basic Authentication`, not both.

Download and unpack Tanzu GitOps Reference Implementation (RI)

Follow these steps to download and unpack Tanzu GitOps Reference Implementation (RI):

1. Download **Tanzu GitOps Reference Implementation** for Tanzu Application Platform v1.6.13 from the [Broadcom Support Portal](#).
2. Unpack the downloaded TGZ file into the `$HOME/tap-gitops` directory by running:

```
tar -xvf tanzu-gitops-ri-*.tgz -C $HOME/tap-gitops
```

3. Commit the initial state:

```
cd $HOME/tap-gitops

git add . && git commit -m "Initialize Tanzu GitOps RI"
git push -u origin
```

Create your cluster configuration

Follow these steps to create your cluster configuration:

1. Seed configuration for a cluster by using the provided convenience script:

```
cd $HOME/tap-gitops

./setup-repo.sh CLUSTER-NAME aws-secrets-manager
```

Where:

- `CLUSTER-NAME` is the name for your cluster. Typically, this is the same as your EKS cluster's name, the name of the cluster as it appears in `eksctl get clusters`
- `aws-secrets-manager` selects the AWS Secrets Manager external Secret Store.

For example, if the name of your cluster is `iterate-green`:

```
cd $HOME/tap-gitops

./setup-repo.sh iterate-green aws-secrets-manager
```

This script creates the directory `clusters/iterate-green/` and copies in the configuration required to sync this Git repository with the cluster and installing Tanzu Application Platform.

2. Commit and push:

```
git add . && git commit -m 'Add "iterate-green" cluster'
git push
```

Saving the base configuration in an initial commit makes it easier to review customizations in the future.

Customize your cluster configuration

Configuring the Tanzu Application Platform installation involves setting up two components:

- An installation of Tanzu Application Platform.
- An instance of Tanzu Sync, the component that implements the GitOps workflow, fetching configuration from Git and applying it to the cluster.

Follow these steps to customize your Tanzu Application Platform cluster configuration:

1. Navigate to the created directory:

```
cd clusters/CLUSTER-NAME
```

For example, if the name of your cluster is `iterate-green`:

```
cd clusters/iterate-green
```

2. Define the following environment variables:

```
export AWS_ACCOUNT_ID=MY-AWS-ACCOUNT-ID
export AWS_REGION=AWS-REGION
export CLUSTER_NAME=CLUSTER-NAME
export TAP_PKGR_REPO=TAP-PACKAGE-OCI-REPOSITORY
```

Where:

- `MY-AWS-ACCOUNT-ID` is your AWS account ID as it appears in the output of `aws sts get-caller-identity`.
- `AWS-REGION` is the region where the Secrets Manager is and the EKS cluster was created.
- `CLUSTER-NAME` is the name of the target cluster as it appears in the output of `eksctl get clusters`.
- `TAP-PACKAGE-OCI-REPOSITORY` is the fully-qualified path to the OCI repository hosting the Tanzu Application Platform images. If they are relocated to a different registry as described in [Relocate images to a registry](#), the value is `${INSTALL_REGISTRY_HOSTNAME}/${INSTALL_REPO}/tap-packages`.

Grant read access to secret data

AWS Secrets Manager secrets store all sensitive configurations, which are accessed by both Tanzu Sync and the Tanzu Application Platform installation.

Follow these steps to configure the [IAM Role for a Service Account](#):

1. In AWS Identity and Access Manager, create two IAM Policies, one to read the Tanzu Sync secrets and another to read the Tanzu Application Platform installation secrets, by using the supplied script:

```
tanzu-sync/scripts/setup/create-policies.sh
```

2. Create two IAM Role-to-Service Account pairs for your cluster, one for Tanzu Sync and another for the Tanzu Application Platform installation, by using the supplied script:

```
tanzu-sync/scripts/setup/create-irsa.sh
```

For example, if the name of the EKS cluster is `iterate-green` using the defaults, there are two IAM roles in the AWS account:

```
$ aws iam list-roles --query 'Roles[?starts_with(RoleName,`iterate-green`)]'
[
  {
```



```

    "RoleName": "iterate-green--tanzu-sync-secrets",
    ...
  },
  {
    "RoleName": "iterate-green--tap-install-secrets",
    ...
  }
]

```

Generate the default configuration

You can use the following script to generate the default configuration for both Tanzu Sync and Tanzu Application Platform installation:

```
tanzu-sync/scripts/configure.sh
```

The following sections tell you how to edit the configuration values to suit your specific needs.

Review and store Tanzu Sync config

Configuration for Tanzu is stored in two locations:

- Sensitive configuration is stored in AWS Secrets Manager.
- Non-sensitive configuration are stored in YAML files in the Git repository.

Follow these steps to create the sensitive configuration and review the non-sensitive configuration:

1. Save the credentials that Tanzu Sync uses to authenticate with the Git repository.

SSH

Create a secret named `dev/CLUSTER-NAME/tanzu-sync/sync-git/ssh` containing the following information as plaintext:

```

{
  "privatekey": "... (private key portion here) ...",
  "knownhosts": "... (known_hosts for git host here) ..."
}

```

Where `CLUSTER-NAME` is the name as it appears in `eksctl get clusters`.

For example, if the Git repository is hosted on GitHub, and the private key created in [Create a new Git repository](#) is stored in the file `~/.ssh/id_ed25519`:

```

aws secretsmanager create-secret \
  --name dev/${CLUSTER_NAME}/tanzu-sync/sync-git/ssh \
  --secret-string "$(cat <<EOF
{
  "privatekey": "$(cat ~/.ssh/id_ed25519 | awk '{printf "%s\n", $0}')

```

Where:

- The content of `~/.ssh/id_ed25519` is the private portion of the SSH key.
- `ssh-keyscan` obtains the public keys for the SSH host.
- `awk '{printf "%s\n", $0}'` converts a multiline string into a single-line string with embedded newline chars (`\n`). JSON does not support multiline strings.

Basic Authentication

Create a secret named `dev/CLUSTER-NAME/tanzu-sync/sync-git/basic_auth` containing the following information as plaintext:

```
{
  "username": "... (username) ...",
  "password": "... (password) ..."
}
```

Where:

- `CLUSTER-NAME` is the name as it appears in `eksctl get clusters`.
- `username` is the username of a user account with read access to the Git repository.
- `password` is the password or personal access token for the user.

- To securely store the authentication credentials required for accessing the OCI registry that hosts the Tanzu Application Platform images, create a secret called `dev/CLUSTER-NAME/tanzu-sync/install-registry-dockerconfig`. This secret contains the following information in plaintext:

```
{
  "auths": {
    "MY-REGISTRY": {
      "username": "MY-REGISTRY-USER",
      "password": "MY-REGISTRY-PASSWORD"
    }
  }
}
```

Where:

- `CLUSTER-NAME` is the name as it appears in `eksctl get clusters`
- `MY-REGISTRY-USER` is the user with write access to `MY-REGISTRY`.
- `MY-REGISTRY-PASSWORD` is the password for `MY-REGISTRY-USER`.
- `MY-REGISTRY` is the container registry where the Tanzu Application Platform images are located.

For example:

```
aws secretsmanager create-secret \
  --name dev/${CLUSTER_NAME}/tanzu-sync/install-registry-dockerconfig \
  --secret-string "$(cat <<EOF
{
  "auths": {
    "${INSTALL_REGISTRY_HOSTNAME}": {
      "username": "${INSTALL_REGISTRY_USERNAME}",
      "password": "${INSTALL_REGISTRY_PASSWORD}"
    }
  }
}
EOF
)"
```

- Review the hosted Git URL and branch used by Tanzu Sync.

This configuration was generated by the `configure.sh` script. It reported:

```
...
wrote non-sensitive Tanzu Sync configuration to: tanzu-sync/app/values/tanzu-sync.yaml
...
```

For example, for the `iterate-green` cluster, if the Git repository is hosted on GitHub under `my-organization/tap-gitops` and is on the `main` branch, `tanzu-sync.yaml` contains the following information:

```
---
git:
  url: git@github.com:my-organization/tap-gitops.git
  ref: origin/main
  sub_path: clusters/iterate-green/cluster-config
```

You can review and edit these values as needed.

4. Review the integration with External Secrets Operator.

This configuration was generated by the `configure.sh` script. It reported:

```
...
wrote ESO configuration for Tanzu Sync to: tanzu-sync/app/values/tanzu-sync-aws-secrets-manager-values.yaml
...
```

For example, for the `iterate-green` cluster, if the AWS account is `665100000000`, `tanzu-sync-aws-secrets-manager-values.yaml` contains the following information:

```
---
secrets:
  eso:
    aws:
      region: us-west-2
      tanzu_sync_secrets:
        role_arn: arn:aws:iam::665100000000:role/iterate-green--tanzu-sync-secrets
    remote_refs:
      sync_git:
        # TO DO: Fill in your configuration for ssh or basic authentication here.
        See tanzu-sync/app/config/.tanzu-managed/schema--eso.yaml for details.
      install_registry_dockerconfig:
        dockerconfigjson:
          key: dev/iterate-green/tanzu-sync/install-registry-dockerconfig
```

Where:

- `role_arn` is the IAM role that grants permission to Tanzu Sync to read secrets specific to Tanzu Sync. This role was created in the [Grant read access to secret data](#) section.
- `install_registry_dockerconfig` contains the AWS Secrets Manager secret name that contains the Docker config authentication to the OCI registry hosting the Tanzu Application Platform images created earlier.

5. Replace any `TO DO` sections from line 10 in the earlier example with the relevant values.

Configuration example for SSH authentication:

```
---
secrets:
  eso:
    aws:
```

```

region: us-west-2
tanzu_sync_secrets:
  role_arn: arn:aws:iam::665100000000:role/iterate-green--tanzu-sync-secret
s
remote_refs:
sync_git:
  ssh:
    private_key:
      key: dev/iterate-green/tanzu-sync/sync-git/ssh
      property: privatekey
    known_hosts:
      key: dev/iterate-green/tanzu-sync/sync-git/ssh
      property: knownhosts
install_registry_dockerconfig:
dockerconfigjson:
  key: dev/iterate-green/tanzu-sync/install-registry-dockerconfig

```

Configuration example for basic authentication:

```

---
secrets:
  eso:
    aws:
      region: us-west-2
      tanzu_sync_secrets:
        role_arn: arn:aws:iam::665100000000:role/iterate-green--tanzu-sync-secret
s
remote_refs:
sync_git:
  basic_auth:
    username:
      key: dev/iterate-green/tanzu-sync/sync-git/basic_auth
      property: username
    password:
      key: dev/iterate-green/tanzu-sync/sync-git/basic_auth
      property: password
install_registry_dockerconfig:
dockerconfigjson:
  key: dev/iterate-green/tanzu-sync/install-registry-dockerconfig

```

6. Commit the Tanzu Sync configuration.

For example, for the “iterate-green” cluster, run:

```

git add tanzu-sync/
git commit -m 'Configure Tanzu Sync on "iterate-green"'

```

Review and store the Tanzu Application Platform installation config

Configuration for the Tanzu Application Platform installation is stored in two places:

- Sensitive configuration is stored in AWS Secrets Manager.
- Non-sensitive configuration is stored in YAML files in the Git repository.

Follow these steps to create the sensitive configuration and review the non-sensitive configuration:

1. Create a secret named `dev/${CLUSTER_NAME}/tap/sensitive-values.yaml` that stores the sensitive data such as username, password, private key from the `tap-values.yaml` file:

```

aws secretsmanager create-secret \
  --name dev/${CLUSTER_NAME}/tap/sensitive-values.yaml \
  --secret-string "$(cat <<EOF
---
# this document is intentionally initially blank.

```

```
EOF
)"
```

You can start with an empty document and edit it later on as described in the [Configure and push the Tanzu Application Platform values](#) section.

2. Review the integration with External Secrets Operator.

This configuration was generated by the `configure.sh` script. It reported:

```
...
wrote AWS Secrets Manager configuration for TAP Install to: cluster-config/values/tap-install-aws-secrets-manager-values.yaml
...
```

For example, for the `iterate-green` cluster, if the AWS account is `665100000000`, `tap-install-aws-secrets-manager-values.yaml` contains the following information:

```
---
tap_install:
  secrets:
    eso:
      aws:
        region: us-west-2
        tap_install_secrets:
          role_arn: arn:aws:iam:665100000000:iterate-green--tap-install-secrets
        remote_refs:
          tap_sensitive_values:
            sensitive_tap_values_yaml:
              key: dev/iterate-green/tap/sensitive-values.yaml
```

Where:

- `role_arn` is the IAM role that grants permission to the Tanzu Application Platform installation to read its associated secrets. This role was created in the [Grant read access to secret data](#) section.
- `sensitive_tap_values_yaml.key` is the AWS Secrets Manager secret name that contains the sensitive data from the `tap-values.yaml` file for this cluster in a YAML format.

3. (Optional) Update Tanzu Application Platform to use the latest patch:

Update the Tanzu Application Platform version in `GIT-REPO-ROOT/clusters/CLUSTER-NAME/cluster-config/values/tap-install-values.yaml`:

```
tap_install:
  ...
  version:
    package_repo_bundle_tag: "1.6.13" # Populate these values with the latest patch version.
    package_version: "1.6.13"
```

Where:

- `package_repo_bundle_tag` is the version of Tanzu Application Platform you want to upgrade to.
- `package_version` is the version of Tanzu Application Platform you want to upgrade to. This version must match `package_repo_bundle_tag`.



Note

Tanzu GitOps RI does not provide a separate artifact for each patch version within a minor line. For example, Tanzu Application Platform v1.6.x only contains the v1.6.1 GitOps artifact.

4. Commit the Tanzu Application Platform installation configuration.

For example, for the `iterate-green` cluster, run:

```
git add cluster-config/
git commit -m 'Configure installer for TAP 1.6.1 on "iterate-green"'
```

Configure and push the Tanzu Application Platform values

The configuration for the Tanzu Application Platform is divided into two separate locations:

- Sensitive configuration is stored in a AWS Secrets Manager secret created as described in the [Review and store Tanzu Application Platform installation config](#) section.
- Non-sensitive configuration is stored in a plain YAML file `cluster-config/values/tap-values.yaml`

Follow these steps to split the Tanzu Application Platform values:

1. Create the `cluster-config/values/tap-values.yaml` file by using the [Full Profile \(AWS\)](#), which contains the minimum configurations required to deploy Tanzu Application Platform on AWS.

The Tanzu Application Platform values are input configurations to the Tanzu Application Platform installation and are placed under the `tap_install.values` path.

```
tap_install:
  values:
    # Tanzu Application Platform values go here.
    shared:
      ingress_domain: "INGRESS-DOMAIN"
      ceip_policy_disclosed: true
    ...
```

To install Tanzu Application Platform in an offline environment, you must configure [Tanzu Build Service](#) and [Grype](#) to work in an air-gapped environment:

```
---
tap_install:
  values:
    ...
    buildservice:
      exclude_dependencies: true
    grype:
      db:
        dbUpdateUrl: INTERNAL-VULN-DB-URL
```

Where `INTERNAL-VULN-DB-URL` is the URL that points to the internal file server.

For more information, see [Components and installation profiles](#).

2. Review the contents of `tap-values.yaml` and move all the sensitive values into the AWS Secrets Store secret created in the [Review and store Tanzu Application Platform installation config](#) section.

For example, if the `iterate-green` cluster is configured with the basic Out of the Box Supply Chain, this might include a passphrase for that supply chain's GitOps flow:

```

---
tap_install:
  values:
    ...
    ootb_supply_chain_basic:
      registry:
        server: "SERVER-NAME"
        repository: "REPO-NAME"
      gitops:
        ssh_secret: "SSH-SECRET-KEY"
    ...

```

To maintain the secrecy of `ootb_supply_chain_basic.gitops.ssh_secret`, move this value from the `tap-values.yaml` file:

```

---
tap_install:
  values:
    ...
    ootb_supply_chain_basic:
      registry:
        server: "SERVER-NAME"
        repository: "REPO-NAME"
    ...

```

Add it to the AWS Secrets Store secret named `dev/iterate-green/tap/sensitive-values.yaml`, by default, without the `tap_install.values` root:

```

---
...
ootb_supply_chain_basic:
  gitops:
    ssh_secret: "SSH-SECRET-KEY"
...

```

To update the secret value, follow the instructions in [Modify an AWS Secrets Manager secret](#).

When moving values, you must omit the `tap_install.values` root, but keep the remaining structure. All of the parent keys, such as `ootb_supply_chain_basic.gitops` and `ssh_secret`, must be copied to the sensitive value YAML.

3. Commit and push the Tanzu Application Platform values:

```

git add cluster-config/
git commit -m "Configure initial values for TAP 1.6.1"
git push

```

Tanzu Sync fetches configuration from the hosted clone of the Git repository. For changes to take effect on the cluster, they must be pushed to that clone of the Git repository.

Deploy Tanzu Sync

Deploying Tanzu Sync starts the GitOps workflow that initiates the Tanzu Application Platform installation.

After deployed, Tanzu Sync periodically polls the Git repository for changes. The following deployment process is only required once per cluster:

1. Install the Carvel tools `kapp` and `ytt` onto your `$PATH`:

```
sudo cp $HOME/tanzu-cluster-essentials/kapp /usr/local/bin/kapp
sudo cp $HOME/tanzu-cluster-essentials/ytt /usr/local/bin/ytt
```

This step is required to ensure the successful deployment of the `tanzu-sync` app.

2. Ensure the Kubernetes cluster context is set to the EKS cluster.

1. List the existing contexts:

```
kubectl config get-contexts
```

2. Set the context to the cluster that you want to deploy:

```
kubectl config use-context CONTEXT-NAME
```

Where `CONTEXT-NAME` can be retrieved from the outputs of the previous step.

3. Bootstrap the deployment.

External Secrets Operator is installed from the package included in the Tanzu Application Platform package repository. That repository must be fetched from the OCI registry initially.

1. Set the following environment variables:

```
export INSTALL_REGISTRY_HOSTNAME=MY-REGISTRY
export INSTALL_REGISTRY_USERNAME=MY-REGISTRY-USER
export INSTALL_REGISTRY_PASSWORD=MY-REGISTRY-PASSWORD
```

Where:

- `MY-REGISTRY` is your container registry.
- `MY-REGISTRY-USER` is the user with read access to `MY-REGISTRY`.
- `MY-REGISTRY-PASSWORD` is the password for `MY-REGISTRY-USER`.

2. Create a secret containing credentials to fetch from that OCI registry by using the provided script:

```
tanzu-sync/scripts/bootstrap.sh
```

These credentials are used exactly once to install the External Secrets Operator (ESO) package.

4. Install Tanzu Sync and start the GitOps workflow by deploying it to the cluster using `kapp` and `ytt`.

```
tanzu-sync/scripts/deploy.sh
```

Depending on the profile and components included, it may take 5-10 minutes for the Tanzu Application Platform to install. During this time, `kapp` waits for the deployment of Tanzu Sync to reconcile successfully. This is normal.

You can track the progress of the installation by watching the installation of those packages in a separate terminal window:

```
watch kubectl get pkgi -n tap-install
```

Install Tanzu Application Platform through GitOps with HashiCorp Vault

**Caution**

Tanzu Application Platform (GitOps) is currently in beta and is intended for evaluation and test purposes only. Do not use in a production environment.

This topic tells you how to install Tanzu Application Platform (commonly known as TAP) through GitOps with secrets managed in an external secrets store. To decide which approach to use, see [Choosing Secrets OperationS \(SOPS\) or External Secrets Operator \(ESO\)](#).

Tanzu GitOps Reference Implementation (RI) does not support changing the secrets management strategy for a cluster, for example, SOPS to ESO. However, changing between AWS Secrets Manager and HashiCorp Vault is supported. The External Secrets Operator integration in this release of Tanzu GitOps RI is verified to support Kubernetes integration with HashiCorp Vault.

Prerequisites

Before installing Tanzu Application Platform, ensure you have:

- Completed the [Prerequisites](#).
- Installed [Tanzu CLI](#) with any required plug-ins.
- Installed [Cluster Essentials for Tanzu](#).
- Installed [eksctl CLI](#).

Relocate images to a registry

Before installation, you must relocate the Tanzu Application Platform images from tanzu.packages.broadcom.com to your own container image registry.

The supported registries are Harbor, Azure Container Registry, Google Container Registry, and Quay.io. See the following documentation to learn how to set up your container image registry:

- [Harbor documentation](#)
- [Google Container Registry documentation](#)
- [Quay.io documentation](#)

To relocate images from tanzu.packages.broadcom.com to your registry:

1. Retrieve your Broadcom registry API token:
 1. Sign in to the [Broadcom Support Portal](#).
 2. Go to [Tanzu Application Platform \(TAP\)](#) and expand the **VMware Tanzu Application Platform** dropdown.
 3. Click the Token Download icon next to the Tanzu Application Platform version you want to download.

Release	Release Level Info	Language	
1.10.1	521283	English	
1.10.0	360181	English	
1.9.1	360147	English	

- Follow the instructions in the dialog box. Save the token as a variable named `MY_BROADCOM_SUPPORT_ACCESS_TOKEN`. For example:

```
export MY_BROADCOM_SUPPORT_ACCESS_TOKEN=API-TOKEN
```

Where `API-TOKEN` is your token from the Broadcom Support Portal.

- Set up environment variables for installation use by running:

```
export IMGPKG_REGISTRY_HOSTNAME_0=tanzu.packages.broadcom.com
export IMGPKG_REGISTRY_USERNAME_0=MY-BROADCOM-SUPPORT-USERNAME
export IMGPKG_REGISTRY_PASSWORD_0=${MY_BROADCOM_SUPPORT_ACCESS_TOKEN}
export IMGPKG_REGISTRY_HOSTNAME_1=MY-REGISTRY
export IMGPKG_REGISTRY_USERNAME_1=MY-REGISTRY-USER
export IMGPKG_REGISTRY_PASSWORD_1=MY-REGISTRY-PASSWORD
export INSTALL_REGISTRY_USERNAME=MY-REGISTRY-USER
export INSTALL_REGISTRY_PASSWORD=MY-REGISTRY-PASSWORD
export INSTALL_REGISTRY_HOSTNAME=MY-REGISTRY
export TAP_VERSION=VERSION-NUMBER
export INSTALL_REPO=TARGET-REPOSITORY
```

Where:

- `MY-BROADCOM-SUPPORT-USERNAME` is the user with access to the images in `tanzu.packages.broadcom.com`.
- `MY-REGISTRY` is your own container registry.
- `MY-REGISTRY-USER` is the user with write access to `MY-REGISTRY`.
- `MY-REGISTRY-PASSWORD` is the password for `MY-REGISTRY-USER`.
- `VERSION-NUMBER` is your Tanzu Application Platform version. For example, `1.6.13`.
- `TARGET-REPOSITORY` is your target repository, a folder or repository on `MY-REGISTRY` that serves as the location for the installation files for Tanzu Application Platform.

VMware recommends using a JSON key file to authenticate with Google Container Registry. In this case, the value of `INSTALL_REGISTRY_USERNAME` is `_json_key` and the value of `INSTALL_REGISTRY_PASSWORD` is the content of the JSON key file. For more information about how to generate the JSON key file, see [Google Container Registry documentation](#).

- Install the Carvel tool `imgpkg` CLI.

To query for the available versions of Tanzu Application Platform on `tanzu.packages.broadcom.com`, run:

```
imgpkg tag list -i tanzu.packages.broadcom.com/tanzu-application-platform/tap-p
ackages | sort -V
```

- Relocate the images with the `imgpkg` CLI by running:

```
imgpkg copy -b tanzu.packages.broadcom.com/tanzu-application-platform/tap-packa
ges:${TAP_VERSION} --to-repo ${INSTALL_REGISTRY_HOSTNAME}/${INSTALL_REPO}/tap-p
ackages
```

(Optional) Install Tanzu Application Platform in an air-gapped environment

Complete the following steps if you install Tanzu Application Platform in an air-gapped environment:

- Retrieve the Tanzu Build Service version by running:

```
kubectl get package -n tap-install | grep buildservice
```

2. Relocate the Tanzu Build Service images to your registry by running:

```
imgpkg copy -b tanzu.packages.broadcom.com/tanzu-application-platform/full-tbs-deps-package-repo:TBS-VERSION --to-repo ${INSTALL_REGISTRY_HOSTNAME}/${INSTALL_REPO}/full-tbs-deps-package-repo
```

Where `TBS-VERSION` is the version of Tanzu Build Service you retrieved.

3. [Configure custom certificate authorities for Tanzu Developer Portal.](#)
4. Host a `grype` database in the air-gapped environment. For more information, see [Use Grype in offline and air-gapped environments.](#)

Create a new Git repository

1. In a hosted Git service, for example, GitHub or GitLab, create a new repository.

This version of Tanzu GitOps RI supports authenticating to a hosted Git repository by using SSH as well as Basic Authentication.

2. Initialize a new Git repository:

```
mkdir -p $HOME/tap-gitops
cd $HOME/tap-gitops

git init
git remote add origin git@github.com:my-organization/tap-gitops.git
```

3. Set up the authentication method.

SSH

Create a read-only deploy key for this new repository (recommended) or SSH key for an account with read access to this repository. The private portion of this key is referred to as `GIT_SSH_PRIVATE_KEY`.

Basic Authentication

Have a username with read access to the Git repository and password or personal access token for the same user.



Important

Only use one of `ssh` or `Basic Authentication`, not both.

Download and unpack Tanzu GitOps Reference Implementation (RI)

1. Download **Tanzu GitOps Reference Implementation** for Tanzu Application Platform v1.6.13 from the [Broadcom Support Portal](#).
2. Unpack the downloaded TGZ file into the `$HOME/tap-gitops` directory by running:

```
tar -xvf tanzu-gitops-ri-*.tgz -C $HOME/tap-gitops
```

3. Commit the initial state:

```
cd $HOME/tap-gitops

git add . && git commit -m "Initialize Tanzu GitOps RI"
git push -u origin
```

Create cluster configuration

1. Seed configuration for a cluster using Vault through the provided convenience script:

```
cd $HOME/tap-gitops

./setup-repo.sh CLUSTER-NAME vault
```

Where:

- `CLUSTER-NAME` is the name for your cluster. Typically, this is the same as your EKS cluster's name, the name of the cluster as it appears in `eksctl get clusters`.
- `vault` selects the Vault external Secret Store.

For example, if the name of your cluster is `iterate-green`:

```
cd $HOME/tap-gitops

./setup-repo.sh iterate-green vault
```

This script creates the directory `clusters/iterate-green/` and copies in the configuration required to sync this Git repository with the cluster and installing Tanzu Application Platform.

2. Commit and push:

```
git add . && git commit -m 'Add "iterate-green" cluster'
git push
```

Saving the base configuration in an initial commit makes it easier to review customizations in the future.

Customize cluster configuration

Configuring the Tanzu Application Platform installation involves setting up two components:

- An installation of Tanzu Application Platform.
- An instance of Tanzu Sync, the component that implements the GitOps workflow, fetching configuration from Git and applying it to the cluster.

Follow these steps to customize your Tanzu Application Platform cluster configuration:

1. Navigate to the created directory:

```
cd clusters/CLUSTER-NAME
```

For example, if the name of your cluster is `iterate-green`:

```
cd clusters/iterate-green
```

2. Define the following environment variables:

```
export VAULT_ADDR=MY-VAULT-ADDR
export CLUSTER_NAME=CLUSTER-NAME
```

```
export TAP_PKGR_REPO=TAP-PACKAGE-OCI-REPOSITORY
```

Where:

- `MY-VAULT-ADDR` is the accessible URL of your vault instance (Vault must be reachable by the Kubernetes cluster).
- `CLUSTER-NAME` is the name of the target cluster.
- `TAP-PACKAGE-OCI-REPOSITORY` is the fully-qualified path to the OCI repository hosting the Tanzu Application Platform images. If they are relocated to a different registry as described in [Relocate images to a registry](#), the value is `${INSTALL_REGISTRY_HOSTNAME}/${INSTALL_REPO}/tap-packages`.

Connect Vault to a Kubernetes cluster

Tanzu GitOps RI uses the Vault Kubernetes authentication method for establishing trust between the Kubernetes cluster and Vault, see [Vault Kubernetes auth](#) for more. This authentication method uses the Kubernetes Control Plane [TokenReview API](#) to authenticate the Kubernetes service accounts with Vault. For this reason, the clusters control plane must be able to communicate over the network to the Vault instance.

To configure Kubernetes authentication for Vault, you can create a new Kubernetes authentication engine instance on Vault and two IAM Roles by using the supplied script:

```
tanzu-sync/scripts/setup/create-kubernetes-auth.sh
```



Important

- If you use an Enterprise Vault Server with namespaces, run `export VAULT_NAMESPACE=MY-VAULT-NAMESPACE` before using the script.
- If you use token to access server, run `export VAULT_TOKEN=MY-VAULT-TOKEN` before using the script.

This creates a new vault Kubernetes authentication instance using the information for the current context in your `KUBECONFIG`.

Example:

```
vault write auth/iterate-green/config \
  kubernetes_host="MY-KUBERNETES-API-URL" \
  kubernetes_ca_cert="MY-KUBERNETES-CA-CERT" \
  ttl=1h
```

Grant read access to secret data

Vault secrets store all sensitive configurations, which are accessed by both Tanzu Sync and the Tanzu Application Platform installation.

Follow these steps to configure Roles in Vault:

1. Create two Policies, one to read the Tanzu Sync secrets and another to read the Tanzu Application Platform installation secrets, by using the supplied script:

```
tanzu-sync/scripts/setup/create-policies.sh
```

2. Create two Roles, one to read the Tanzu Sync secrets and another to read the Tanzu Application Platform installation secrets, by using the supplied script:

```
tanzu-sync/scripts/setup/create-roles.sh
```

Generate default configuration

You can use the following script to generate default configuration for both Tanzu Sync and Tanzu Application Platform installation:

```
tanzu-sync/scripts/configure.sh
```

The following sections tell you how to edit the configuration values to suit your specific needs.

Review and store Tanzu Sync config

Configuration for Tanzu is stored in two locations:

- Sensitive configuration is stored in Vault.
- Non-sensitive configuration are stored in YAML files in the Git repository.

Follow these steps to create the sensitive configuration and review the non-sensitive configuration:



Important

You must enable a key-value secret engine named `secret`.

1. Save the credentials that Tanzu Sync uses to authenticate with the Git repository. There are two supported authentication methods:

SSH

Create a secret named `secret/dev/CLUSTER-NAME/tanzu-sync/sync-git/ssh` containing the following information as plaintext:

```
{
  "privatekey": "... (private key portion here) ...",
  "knownhosts": "... (known_hosts for git host here) ..."
}
```

Where `CLUSTER-NAME` is the name of your cluster.

For example, if the Git repository is hosted on GitHub, and the private key created in [Create a new Git repository](#) is stored in the file `~/.ssh/id_ed25519`:

```
export GIT_SSH_PRIVATE_KEY_FILE=~/.ssh/id_ed25519
export GIT_KNOWN_HOSTS=$(ssh-keyscan github.com)
printf '%s\n' "$(cat <<EOF
{
  "privatekey": "$(cat $GIT_SSH_PRIVATE_KEY_FILE | awk '{printf "%s\n",
$0}')

```

Where:

- The content of `~/.ssh/id_ed25519` is the private portion of the SSH key.
- `ssh-keyscan` obtains the public keys for the SSH host.

- `awk '{printf "%s\n", $0}'` converts a multiline string into a single-line string with embedded newline chars (`\n`). JSON does not support multiline strings.

Basic Authentication

Create a secret named `secret/dev/CLUSTER-NAME/tanzu-sync/sync-git/basic_auth` containing the following information as plaintext:

```
{
  "username": "... (username) ...",
  "password": "... (password) ..."
}
```

Where:

- `CLUSTER-NAME` is the name of your cluster.
- `username` is the username of a user account with read access to the Git repository.
- `password` is the password or personal access token for the user.

- To securely store the authentication credentials required for accessing the OCI registry hosting the Tanzu Application Platform images, create a secret called `dev/CLUSTER-NAME/tanzu-sync/install-registry-dockerconfig`. This secret contains the following information in plaintext:

```
{
  "auths": {
    "MY-REGISTRY": {
      "username": "MY-REGISTRY-USER",
      "password": "MY-REGISTRY-PASSWORD"
    }
  }
}
```

Where:

- `CLUSTER-NAME` is the name of your cluster.
- `MY-REGISTRY-USER` is the user with write access to `MY-REGISTRY`.
- `MY-REGISTRY-PASSWORD` is the password for `MY-REGISTRY-USER`.
- `MY-REGISTRY` is the container registry where the Tanzu Application Platform images are located.

For example:

```
printf '%s\n' "$(cat <<EOF
{
  "auths": {
    "${INSTALL_REGISTRY_HOSTNAME}": {
      "username": "${INSTALL_REGISTRY_USERNAME}",
      "password": "${INSTALL_REGISTRY_PASSWORD}"
    }
  }
}
EOF
)" | vault kv put secret/dev/${CLUSTER_NAME}/tanzu-sync/install-registry-docker
config -
```

- Review the hosted Git URL and branch used by Tanzu Sync.

This configuration was generated by the `configure.sh` script. It reported:

```
...
wrote non-sensitive Tanzu Sync configuration to: tanzu-sync/app/values/tanzu-sync.yaml
...
```

For example, for the `iterate-green` cluster, if the Git repository is hosted on GitHub at `my-organization/tap-gitops` on the `main` branch, `tanzu-sync.yaml` contains the following information:

```
---
git:
  url: git@github.com:my-organization/tap-gitops.git
  ref: origin/main
  sub_path: clusters/iterate-green/cluster-config
```

You can review and edit these values as needed.

4. Review the integration with External Secrets Operator.

This configuration was generated by the `configure.sh` script. It reported:

```
...
wrote ESO configuration for Tanzu Sync to: tanzu-sync/app/values/tanzu-sync-vault-values.yaml
...
```

For example, for the `iterate-green` cluster, if the Vault URL is `https://vault.example.com`, `tanzu-sync-vault-values.yaml` contains the following information:

```
---
secrets:
  eso:
    vault:
      server: https://vault.example.com
      namespace: ""
      auth:
        kubernetes:
          mountPath: iterate-green
          role: iterate-green--tanzu-sync-secrets
    remote_refs:
      sync_git:
        # TO DO: Fill in your configuration for ssh or basic authentication here. See tanzu-sync/app/config/.tanzu-managed/schema--eso.yaml for details.
      install_registry_dockerconfig:
        dockerconfigjson:
          key: secret/dev/iterate-green/tanzu-sync/install-registry-dockerconfig
```

Where:

- `kubernetes.role` is the IAM role that grants permission to Tanzu Application Platform installation to read its associated secrets. This role was created in the [Grant read access to secret data](#) section.
- `install_registry_dockerconfig` contains the Vault secret name that contains the Docker config authentication to the OCI registry hosting the Tanzu Application Platform images created earlier.

5. Replace any `TO DO` sections from line 12 in the earlier example with the relevant values.

Configuration example for SSH authentication:

```
---
secrets:
```



```

eso:
  vault:
    server: https://vault.example.com
    namespace: ""
    auth:
      kubernetes:
        mountPath: iterate-green
        role: iterate-green--tanzu-sync-secrets
  remote_refs:
    sync_git:
      ssh:
        private_key:
          key: secret/dev/iterate-green/tanzu-sync/sync-git/ssh
          property: privatekey
        known_hosts:
          key: secret/dev/iterate-green/tanzu-sync/sync-git/ssh
          property: knownhosts
    install_registry_dockerconfig:
      dockerconfigjson:
        key: secret/dev/iterate-green/tanzu-sync/install-registry-dockerconfig

```

Configuration example for basic authentication:

```

---
secrets:
  eso:
    vault:
      server: https://vault.example.com
      namespace: ""
      auth:
        kubernetes:
          mountPath: iterate-green
          role: iterate-green--tanzu-sync-secrets
    remote_refs:
      sync_git:
        basic_auth:
          username:
            key: secret/dev/iterate-green/tanzu-sync/sync-git/basic_auth
            property: username
          password:
            key: secret/dev/iterate-green/tanzu-sync/sync-git/basic_auth
            property: password
      install_registry_dockerconfig:
        dockerconfigjson:
          key: secret/dev/iterate-green/tanzu-sync/install-registry-dockerconfig

```

6. (Optional) Update Tanzu Application Platform to use the latest patch:

Update the Tanzu Application Platform version in `GIT-REPO-ROOT/clusters/CLUSTER-NAME/cluster-config/values/tap-install-values.yaml`:

```

tap_install:
  ...
  version:
    package_repo_bundle_tag: "1.6.13" # Populate these values with the latest patch version.
    package_version: "1.6.13"

```

Where:

- `package_repo_bundle_tag` is the version of Tanzu Application Platform you want to upgrade to.
- `package_version` is the version of Tanzu Application Platform you want to upgrade to. This version must match `package_repo_bundle_tag`.

**Note**

Tanzu Application Platform (GitOps) does not provide a separate artifact for each patch version within a minor line. For example, Tanzu Application Platform v1.6.x only contains the v1.6.1 GitOps artifact.

7. Commit the Tanzu Sync configuration.

For example, for the “iterate-green” cluster, run:

```
git add tanzu-sync/
git commit -m 'Configure Tanzu Sync on "iterate-green"'
```

Review and store the Tanzu Application Platform installation config

Configuration for the Tanzu Application Platform installation is stored in two places:

- Sensitive configuration is stored in Vault.
- Non-sensitive configuration is stored in YAML files in the Git repository.

Follow these steps to create the sensitive configuration and review the non-sensitive configuration:

1. Create a secret named `secret/dev/${CLUSTER_NAME}/tap/sensitive-values.yaml` that stores the sensitive data such as username, password, private key from the `tap-values.yaml` file:

```
printf '%s\n' "$ (cat <<EOF
---
# this document is intentionally initially blank.
EOF
)" | vault kv put secret/dev/${CLUSTER_NAME}/tap/sensitive-values.yaml -
```

You can start with an empty document and edit it later on as described in the [Configure and push the Tanzu Application Platform values](#) section.

Vault does not support storing YAML files, all secrets must be in `key-value` format. You must convert your sensitive-values YAML file to `json` before storage.

2. Review the integration with External Secrets Operator.

This configuration was generated by the `configure.sh` script. It reported:

```
...
wrote Vault configuration for TAP Install to: cluster-config/values/tap-install-vault-values.yaml
...
```

For example, for the `iterate-green` cluster `tap-install-vault-values.yaml` contains the following information:

```
---
tap_install:
  secrets:
    eso:
      vault:
        server: https://vault.example.com
        namespace: ""
        auth:
          kubernetes:
            mountPath: iterate-green
            role: iterate-green--tap-install-secrets
```

```
remote_refs:
  tap_sensitive_values:
    sensitive_tap_values_yaml:
      key: secret/dev/iterate-green/tap/sensitive-values.yaml
```

Where:

- `kubernetes.role` is the IAM role that grants permission to Tanzu Application Platform installation to read its associated secrets. This role was created in the [Grant read access to secret data](#) section.
 - `sensitive_tap_values_yaml.key` is the Vault secret name that contains the sensitive data from the `tap-values.yaml` file for this cluster in a YAML format.
3. Commit the Tanzu Application Platform installation configuration.

For example, for the `iterate-green` cluster, run:

```
git add cluster-config/
git commit -m 'Configure installer for TAP 1.6.1 on "iterate-green"'
```

Configure and push the Tanzu Application Platform values

The configuration for the Tanzu Application Platform is divided into two separate locations:

- Sensitive configuration is stored in a Vault secret created in the [Review and store Tanzu Application Platform installation config](#) section.
- Non-sensitive configuration is stored in a plain YAML file `cluster-config/values/tap-values.yaml`

Follow these steps to split the Tanzu Application Platform values:

1. Create the file `cluster-config/values/tap-values.yaml` by using the [Full Profile sample](#) as a guide:

The Tanzu Application Platform values are input configurations to the Tanzu Application Platform installation and are placed under the `tap_install.values` path.

```
tap_install:
  values:
    # Tanzu Application Platform values go here.
  shared:
    ingress_domain: "INGRESS-DOMAIN"
    ceip_policy_disclosed: true
  ...
```

To install Tanzu Application Platform in an offline environment, you must configure [Tanzu Build Service](#) and [Grype](#) to work in an air-gapped environment:

```
---
tap_install:
  values:
    ...
    buildservice:
      exclude_dependencies: true
    grype:
      db:
        dbUpdateUrl: INTERNAL-VULN-DB-URL
```

Where `INTERNAL-VULN-DB-URL` is the URL that points to the internal file server.

For more information, see [Components and installation profiles](#).

- Review the contents of `tap-values.yaml` and move all the sensitive values into the Vault secret created in the [Review and store Tanzu Application Platform installation config](#) section.

For example, if the `iterate-green` cluster is configured with the basic Out of the Box Supply Chain, this might include a passphrase for that supply chain's GitOps flow:

```
---
tap_install:
  values:
    ...
    ootb_supply_chain_basic:
      registry:
        server: "SERVER-NAME"
        repository: "REPO-NAME"
      gitops:
        ssh_secret: "SSH-SECRET-KEY"
    ...
```

To maintain the secrecy of `ootb_supply_chain_basic.gitops.ssh_secret`, move this value from the `tap-values.yaml` file:

```
---
tap_install:
  values:
    ...
    ootb_supply_chain_basic:
      registry:
        server: "SERVER-NAME"
        repository: "REPO-NAME"
    ...
```

Add it to the Vault secret named `secret/dev/iterate-green/tap/sensitive-values.yaml`, by default, without the `tap_install.values` root:

```
---
...
ootb_supply_chain_basic:
  gitops:
    ssh_secret: "SSH-SECRET-KEY"
...

```

When moving values, you must omit the `tap_install.values` root, but keep the remaining structure. All of the parent keys, such as `ootb_supply_chain_basic.gitops` and `ssh_secret`, must be copied to the sensitive value YAML.

- Commit and push the Tanzu Application Platform values:

```
git add cluster-config/
git commit -m "Configure initial values for TAP 1.6.1"
git push
```

Tanzu Sync fetches configuration from the hosted clone of the Git repository. For changes to take effect on the cluster, they must be pushed to that clone of the Git repository.

Deploy Tanzu Sync

Deploying Tanzu Sync starts the GitOps workflow that initiates the Tanzu Application Platform installation.

After deployed, Tanzu Sync periodically polls the Git repository for changes. The following deployment process is only required once per cluster:

1. Install the Carvel tools `kapp` and `ytt` onto your `$PATH`:

```
sudo cp $HOME/tanzu-cluster-essentials/kapp /usr/local/bin/kapp
sudo cp $HOME/tanzu-cluster-essentials/ytt /usr/local/bin/ytt
```

This step is required to ensure the successful deployment of the `tanzu-sync` app.

2. Ensure the Kubernetes cluster context is set to the correct cluster.
 1. List the existing contexts:

```
kubectl config get-contexts
```

2. Set the context to the cluster that you want to deploy:

```
kubectl config use-context CONTEXT-NAME
```

Where `CONTEXT-NAME` can be retrieved from the outputs of the previous step.

3. Bootstrap the deployment.

External Secrets Operator is installed from the package included in the Tanzu Application Platform package repository. That repository must be fetched from the OCI registry initially.

1. Set the following environment variables:

```
export INSTALL_REGISTRY_HOSTNAME=MY-REGISTRY
export INSTALL_REGISTRY_USERNAME=MY-REGISTRY-USER
export INSTALL_REGISTRY_PASSWORD=MY-REGISTRY-PASSWORD
```

Where:

- `MY-REGISTRY` is your container registry.
- `MY-REGISTRY-USER` is the user with read access to `MY-REGISTRY`.
- `MY-REGISTRY-PASSWORD` is the password for `MY-REGISTRY-USER`.

2. Create a secret containing credentials to fetch from that OCI registry by using the provided script:

```
tanzu-sync/scripts/bootstrap.sh
```

These credentials are used exactly once to install the External Secrets Operator (ESO) package.

4. Install Tanzu Sync and start the GitOps workflow by deploying it to the cluster using `kapp` and `ytt`.

```
tanzu-sync/scripts/deploy.sh
```

Depending on the profile and components included, it may take 5-10 minutes for the Tanzu Application Platform to install. During this time, `kapp` waits for the deployment of Tanzu Sync to reconcile successfully. This is normal.

You can track the progress of the installation by watching the installation of those packages in a separate terminal window:

```
watch kubectl get pkgi -n tap-install
```

Install Tanzu Application Platform through Gitops with Secrets OPerationS (SOPS)

This topic tells you how to install Tanzu Application Platform (commonly known as TAP) through GitOps with secrets managed in a Git repository.



Caution

Tanzu Application Platform (GitOps) is currently in beta and is intended for evaluation and test purposes only. Do not use in a production environment.

Tanzu GitOps Reference Implementation (RI) does not support changing the secrets management strategy for a cluster.

Prerequisites

Before installing Tanzu Application Platform, you need:

- **SOPS CLI** to view and edit SOPS encrypted files. To install the SOPS CLI, see [SOPS documentation](#) in GitHub.
- **Age CLI** to create an encryption key used to encrypt and decrypt sensitive data. To install the Age CLI, see [age documentation](#) in GitHub.
- Completed the [Prerequisites](#).
- Installed [Tanzu CLI](#) with any required plug-ins.
- Installed [Cluster Essentials for Tanzu](#).

Relocate images to a registry



Before installation, you must relocate the Tanzu Application Platform images from [tanzu.packages.broadcom.com](#) to your own container image registry.

The supported registries are Harbor, Azure Container Registry, Google Container Registry, and Quay.io. See the following documentation to learn how to set up your container image registry:

- [Harbor documentation](#)
- [Google Container Registry documentation](#)
- [Quay.io documentation](#)

To relocate images from [tanzu.packages.broadcom.com](#) to your registry:

1. Retrieve your Broadcom registry API token:
 1. Sign in to the [Broadcom Support Portal](#).
 2. Go to [Tanzu Application Platform \(TAP\)](#) and expand the **VMware Tanzu Application Platform** dropdown.
 3. Click the Token Download icon next to the Tanzu Application Platform version you want to download.

Release	Release Level Info	Language	
1.10.1	521283	English	
1.10.0	360181	English	
1.9.1	360147	English	

- Follow the instructions in the dialog box. Save the token as a variable named `MY_BROADCOM_SUPPORT_ACCESS_TOKEN`. For example:

```
export MY_BROADCOM_SUPPORT_ACCESS_TOKEN=API-TOKEN
```

Where `API-TOKEN` is your token from the Broadcom Support Portal.

- Set up environment variables for installation use by running:

```
# Set tanzu.packages.broadcom.com as the source registry to copy the Tanzu Appl
# ication Platform packages from.
export IMGPKG_REGISTRY_HOSTNAME_0=tanzu.packages.broadcom.com
export IMGPKG_REGISTRY_USERNAME_0=MY-BROADCOM-SUPPORT-USERNAME
export IMGPKG_REGISTRY_PASSWORD_0=${MY_BROADCOM_SUPPORT_ACCESS_TOKEN}

# The user's registry for copying the Tanzu Application Platform package to.
export IMGPKG_REGISTRY_HOSTNAME_1=MY-REGISTRY
export IMGPKG_REGISTRY_USERNAME_1=MY-REGISTRY-USER
export IMGPKG_REGISTRY_PASSWORD_1=MY-REGISTRY-PASSWORD
# These environment variables starting with IMGPKG_* are used by the imgpkg com
# mand only.

# The registry from which the Tanzu Application Platform package is retrieved.
export INSTALL_REGISTRY_USERNAME="${IMGPKG_REGISTRY_USERNAME_1}"
export INSTALL_REGISTRY_PASSWORD="${IMGPKG_REGISTRY_PASSWORD_1}"
export INSTALL_REGISTRY_HOSTNAME="${IMGPKG_REGISTRY_HOSTNAME_1}"
export TAP_VERSION=VERSION-NUMBER
export INSTALL_REPO=TARGET-REPOSITORY
```

Where:

- `MY-BROADCOM-SUPPORT-USERNAME` is the user with access to the images in `tanzu.packages.broadcom.com`.
- `MY-REGISTRY` is your own container registry.
- `MY-REGISTRY-USER` is the user with write access to `MY-REGISTRY`.
- `MY-REGISTRY-PASSWORD` is the password for `MY-REGISTRY-USER`.
- `VERSION-NUMBER` is your Tanzu Application Platform version. For example, `1.6.13`.
- `TARGET-REPOSITORY` is your target repository. This is a folder or repository on `MY-REGISTRY` that serves as the location for the Tanzu Application Platform installation files.

VMware recommends using a JSON key file to authenticate with Google Container Registry. In this case, the value of `INSTALL_REGISTRY_USERNAME` is `_json_key` and the value of `INSTALL_REGISTRY_PASSWORD` is the content of the JSON key file. For more information about how to generate the JSON key file, see [Google Container Registry documentation](#).

- Install the Carvel tool `imgpkg` CLI.

To query for the available versions of Tanzu Application Platform on `tanzu.packages.broadcom.com`, run:

```
imgpkg tag list -i tanzu.packages.broadcom.com/tanzu-application-platform/tap-p
ackages | sort -V
```

4. Relocate the images with the `imgpkg` CLI by running:

```
imgpkg copy -b tanzu.packages.broadcom.com/tanzu-application-platform/tap-packa
ges:${TAP_VERSION} --to-repo ${INSTALL_REGISTRY_HOSTNAME}/${INSTALL_REPO}/tap-p
ackages
```

(Optional) Install Tanzu Application Platform in an air-gapped environment

Complete the following steps if you install Tanzu Application Platform in an air-gapped environment:

1. Retrieve the Tanzu Build Service version by running:

```
kubectl get package -n tap-install | grep buildservice
```

2. Relocate the Tanzu Build Service images to your registry by running:

```
imgpkg copy -b tanzu.packages.broadcom.com/tanzu-application-platform/full-tbs-
deps-package-repo:TBS-VERSION --to-repo ${INSTALL_REGISTRY_HOSTNAME}/${INSTALL_
REPO}/full-tbs-deps-package-repo
```

Where `TBS-VERSION` is the version of Tanzu Build Service you retrieved.

3. Host a `grype` database in the air-gapped environment. For more information, see [Use Grype in offline and air-gapped environments](#).

Create a new Git repository

Follow these steps to create a new Git repository and set up the authentication:

1. In a hosted Git service, for example, GitHub or GitLab, create a new repository.

This version of Tanzu GitOps RI supports authenticating to a hosted Git repository by using SSH and Basic Authentication.

2. Initialize a new Git repository:

```
mkdir -p $HOME/tap-gitops
cd $HOME/tap-gitops

git init
git remote add origin git@github.com:my-organization/tap-gitops.git
```

3. Set up the authentication method.

SSH

Create a read-only deploy key for this new repository (recommended) or SSH key for an account with read access to this repository. The private portion of this key is called `GIT_SSH_PRIVATE_KEY`.

Basic Authentication

Have a user name with read access to the Git repository and password or personal access token for the same user.

**Important**

Only use one of `ssh` or `Basic Authentication`, not both.

Download and unpack Tanzu GitOps Reference Implementation (RI)

1. Download **Tanzu GitOps Reference Implementation** for Tanzu Application Platform v1.6.13 from the [Broadcom Support Portal](#).
2. Unpack the downloaded TGZ file into the `$HOME/tap-gitops` directory by running:

```
tar xvf tanzu-gitops-ri-*.tgz -C $HOME/tap-gitops
```

3. Commit the initial state:

```
cd $HOME/tap-gitops

git add . && git commit -m "Initialize Tanzu GitOps RI"
git push -u origin
```

Create cluster configuration

1. Seed configuration for a cluster using SOPS:

```
cd $HOME/tap-gitops

./setup-repo.sh CLUSTER-NAME sops
```

Where:

- `CLUSTER-NAME` the name of your cluster.
- `sops` selects the Secrets OPerationS-based secrets management variant.

Example:

```
cd $HOME/tap-gitops

./setup-repo.sh full-tap-cluster sops
Created cluster configuration in ./clusters/full-tap-cluster.
...
```

This script creates the directory `clusters/full-tap-cluster/` and copies in the configuration required to sync this Git repository with the cluster and installing Tanzu Application Platform.

2. Commit and push:

```
git add . && git commit -m "Add full-tap-cluster"
git push
```

Configure Tanzu Application Platform

Tanzu Sync Reference Implementation (RI) splits the values configuration of Tanzu Application Platform into two categories:

- Sensitive TAP values, for example, credentials, encryptions keys and so on.

- Non-sensitive TAP values, for example, packages to exclude, namespace configuration and so on.

The following sections describe how to create these values files.

Prepare the sensitive Tanzu Application Platform values

Follow these steps to prepare the sensitive Tanzu Application Platform values:

1. Generate Age public or secrets keys:



Note

Skip this step if you already have an Age key to encrypt or decrypt secrets.

```
mkdir -p $HOME/tmp-enc
chmod 700 $HOME/tmp-enc
cd $HOME/tmp-enc

age-keygen -o key.txt

cat key.txt
# created: 2023-02-08T10:55:35-07:00
# public key: age1q13z7hjy54pw3hyww5ayyf7zqgvc7w3j2elw8zmrj2kg5sfn9aqmcac8p
AGE-SECRET-KEY-my-secret-key
```

2. Create a plain YAML file `tap-sensitive-values.yaml` outside of your Git repository that contains a placeholder for the sensitive portion of the Tanzu Application Platform values:

```
---
tap_install:
  sensitive_values:
```

3. Encrypt `tap-sensitive-values.yaml` with Age using SOPS:

```
export SOPS_AGE_RECIPIENTS=$(cat key.txt | grep "# public key: " | sed 's/# public key: //' )
sops --encrypt tap-sensitive-values.yaml > tap-sensitive-values.sops.yaml
```

Where:

- `grep` is used to find the line containing the public key portion of the generated secret.
- `sed` is used to extract the public key from the line found by `grep`.

4. (Optional) Verify the encrypted file can be decrypted:

```
export SOPS_AGE_KEY_FILE=key.txt
sops --decrypt tap-sensitive-values.sops.yaml
```

(Optional) Verify the encrypted file can be edited directly by using SOPS:

```
sops tap-sensitive-values.sops.yaml
```

5. Move the sensitive Tanzu Application Platform values into the cluster config:

```
mv tap-sensitive-values.sops.yaml GIT-REPO-ROOT/clusters/CLUSTER-NAME/cluster-config/values/
```

Example:

```
mv tap-sensitive-values.sops.yaml $HOME/tap-gitops/clusters/full-tap-cluster/cluster-config/values/
```

- (Optional) Retain the Age identity key file in a safe and secure place such as a password manager, and purge the scratch space:

```
mv key.txt SAFE-LOCATION/
export SOPS_AGE_KEY_FILE=SAFE-LOCATION/key.txt
rm -rf $HOME/tmp-enc
```

Prepare the non-sensitive Tanzu Application Platform values

Create a plain YAML file `GIT-REPO-ROOT/clusters/CLUSTER-NAME/cluster-config/values/tap-non-sensitive-values.yaml` by using the [Full Profile sample](#) as a guide:

Example:

```
---
tap_install:
  values:
    ceip_policy_disclosed: true
    excluded_packages:
      - policy.apps.tanzu.vmware.com
    ...
```

To install Tanzu Application Platform in an offline environment, you must configure [Tanzu Build Service](#) and [Grype](#) to work in an air-gapped environment:

```
---
tap_install:
  values:
    ...
    buildservice:
      exclude_dependencies: true
    grype:
      db:
        dbUpdateUrl: INTERNAL-VULN-DB-URL
```

Where `INTERNAL-VULN-DB-URL` is the URL that points to the internal file server.

For more information, see [Components and installation profiles](#).

Update the sensitive Tanzu Application Platform values

After filling in the non-sensitive values, follow these steps to extract the sensitive values into `tap-sensitive-values.sops.yaml` that you prepared earlier:

- Open an editor through SOPS to edit the encrypted sensitive values file:

```
sops GIT-REPO-ROOT/clusters/CLUSTER-NAME/cluster-config/values/tap-sensitive-values.sops.yaml
```

Example:

```
sops $HOME/tap-gitops/clusters/full-tap-cluster/cluster-config/values/tap-sensitive-values.sops.yaml
```

2. Add the sensitive values:

Example of the container registry credentials using basic authentication:

```
---
tap_install:
  sensitive_values:
    shared:
      image_registry:
        project_path: "example.com/my-project/tap"
        username: "my_username"
        password: "my_password"
```

Example of the container registry credentials using Google Container Registry:

```
---
tap_install:
  sensitive_values:
    shared:
      image_registry:
        project_path: "gcr.io/my-project/tap"
        username: "_json_key"
        password: |
          {
            "type": "service_account",
            "project_id": "my-project",
            "private_key_id": "my-private-key-id",
            "private_key": "-----BEGIN PRIVATE KEY-----\n.....\n-----END PR
PRIVATE KEY-----\n",
            ...
          }
```

Prepare the sensitive Tanzu Sync values

Follow these steps to prepare the sensitive Tanzu Sync values:

1. Create a plain YAML file `tanzu-sync-values.yaml` outside of your Git repository that contains a placeholder for the sensitive portion of Tanzu Sync values:

```
---
secrets:
  sops:
```

2. Encrypt `tanzu-sync-values.yaml` with Age using SOPS:

```
export SOPS_AGE_RECIPIENTS=$(cat key.txt | grep "# public key: " | sed 's/# pub
lic key: //' )
sops --encrypt tanzu-sync-values.yaml > tanzu-sync-values.sops.yaml
```

Where:

- o `grep` is used to find the line containing the public key portion of the generated secret.
 - o `sed` is used to extract the public key from the line found by `grep`.
3. Move the encrypted sensitive Tanzu Application Platform values into the Tanzu Sync config:

```
mv tanzu-sync-values.sops.yaml GIT-REPO-ROOT/clusters/CLUSTER-NAME/tanzu-sync/a
pp/sensitive-values/tanzu-sync-values.sops.yaml
```

Example:

```
mv tanzu-sync-values.sops.yaml $HOME/tap-gitops/clusters/full-tap-cluster/tanzu-sync/app/sensitive-values/tanzu-sync-values.sops.yaml
```

Update the sensitive Tanzu Sync values

Follow these steps to populate `tap-sensitive-values.sops.yaml` with credentials:

1. Open an editor and use SOPS to edit the encrypted sensitive values file:

```
sops GIT-REPO-ROOT/clusters/CLUSTER-NAME/tanzu-sync/app/sensitive-values/tanzu-sync-values.sops.yaml
```

Example:

```
sops $HOME/tap-gitops/clusters/full-tap-cluster/tanzu-sync/app/sensitive-values/tanzu-sync-values.sops.yaml
```

2. Add the sensitive values:

Configuration example for the Git SSH authentication:

```
---
secrets:
  sops:
    age_key: |
      AGE-KEY
    registry:
      hostname: MY-REGISTRY
      username: MY-REGISTRY-USER
      password: MY-REGISTRY-PASSWORD
    git:
      ssh:
        private_key: |
          PRIVATE-KEY
        known_hosts: |
          HOST-LIST
```

Configuration example for the Git basic authentication:

```
---
secrets:
  sops:
    age_key: |
      AGE-KEY
    registry:
      hostname: MY-REGISTRY
      username: MY-REGISTRY-USER
      password: MY-REGISTRY-PASSWORD
    git:
      basic_auth:
        username: MY-GIT-USERNAME
        password: MY-GIT-PASSWORD
```

Where:

- o `AGE-KEY` is the contents of the Age key generated earlier.
- o `MY-REGISTRY` is your container image registry.
- o `MY-REGISTRY-USER` is the user with read access to `MY-REGISTRY`.
- o `MY-REGISTRY-PASSWORD` is the password for `MY-REGISTRY-USER`.

- `PRIVATE-KEY` is the contents of an SSH private key file with read access to your Git repository. Only applies when you use `ssh`.
- `HOST-LIST` is the list of known hosts for Git host service. Only applies when you use `ssh`.
- `MY-GIT-USERNAME` is the user with read access to your Git repository. Only applies when you use `basic authentication`.
- `MY-GIT-PASSWORD` is the password for `MY-GIT-USERNAME`. Only applies when you use `basic authentication`.

You can find the schema for Tanzu Sync credentials in `GIT-REPO-ROOT/clusters/CLUSTER-NAME/tanzu-sync/app/config/.tanzu-managed/schema--sops.yaml`

Generate Tanzu Application Platform installation and Tanzu Sync configuration

Follow these steps to generate the Tanzu Application Platform installation and Tanzu Sync configuration:

1. Set up environment variables by running:

```
export TAP_PKGR_REPO=TAP-PACKAGE-OCI-REPOSITORY
export SOPS_AGE_KEY=AGE-KEY
```

Where:

- `TAP-PACKAGE-OCI-REPOSITORY` is the fully-qualified path to the OCI repository hosting the Tanzu Application Platform images. If the images are relocated as described in [Relocate images to a registry](#), this value is `${INSTALL_REGISTRY_HOSTNAME}/${INSTALL_REPO}/tap-packages`.
- `AGE-KEY` is the contents of the Age key generated earlier.

Example of the Git repo hosted on GitHub:

```
export TAP_PKGR_REPO=tanzu.packages.broadcom.com/tanzu-application-platform/tap-packages
export SOPS_AGE_KEY=$(cat $HOME/tmp-enc/key.txt)
```

2. Generate the Tanzu Application Platform install and the Tanzu Sync configuration files by using the provided script:

```
cd GIT-REPO-ROOT/clusters/CLUSTER-NAME

./tanzu-sync/scripts/configure.sh
```

Example:

```
cd $HOME/tap-gitops/clusters/full-tap-cluster

./tanzu-sync/scripts/configure.sh
```

3. (Optional) Update Tanzu Application Platform to use the latest patch:

Update the Tanzu Application Platform version in `GIT-REPO-ROOT/clusters/CLUSTER-NAME/cluster-config/values/tap-install-values.yaml`:

```
tap_install:
  ...
```

```

version:
  package_repo_bundle_tag: "1.6.13" # Populate these values with the late
st patch version.
  package_version: "1.6.13"

```

Where:

- `package_repo_bundle_tag` is the version of Tanzu Application Platform you want to upgrade to.
- `package_version` is the version of Tanzu Application Platform you want to upgrade to. This version must match `package_repo_bundle_tag`.



Note

Tanzu GitOps RI does not provide a separate artifact for each patch version within a minor line. For example, Tanzu Application Platform v1.6.x only contains the v1.6.1 GitOps artifact.

4. Commit the generated configured to Git repository:

```

git add cluster-config/ tanzu-sync/
git commit -m "Configure install of TAP 1.6.1"
git push

```

Deploy Tanzu Sync

Follow these steps to deploy Tanzu Sync:

1. Install the Carvel tools `kapp` and `ytt` onto your `$PATH`:

```

sudo cp $HOME/tanzu-cluster-essentials/kapp /usr/local/bin/kapp
sudo cp $HOME/tanzu-cluster-essentials/ytt /usr/local/bin/ytt

```

2. Set the Kubernetes cluster context.

1. List the existing contexts:

```
kubectl config get-contexts
```

2. Set the context to the cluster that you want to deploy:

```
kubectl config use-context CONTEXT-NAME
```

Where `CONTEXT-NAME` can be retrieved from the outputs of the previous step.

3. Deploy the Tanzu Sync component:

```

cd GIT-REPO-ROOT/clusters/CLUSTER-NAME
./tanzu-sync/scripts/deploy.sh

```

Example:

```

cd $HOME/tap-gitops/clusters/full-tap-cluster
./tanzu-sync/scripts/deploy.sh

```



Note

Depending on the profile and components included, it may take 5-10 minutes for Tanzu Application Platform to install. During this time, `kapp` waits for the deployment of Tanzu Sync to reconcile successfully. This is normal.

Install individual packages

You can install Tanzu Application Platform (commonly known as TAP) through predefined profiles or through individual packages. Use this topic to learn how to install each individual package. For more information about installing through profiles, see [Components and installation profiles](#).

Installing individual Tanzu Application Platform packages is useful if you do not want to use a profile to install packages or if you want to install additional packages after installing a profile. Before installing the packages, be sure to complete the prerequisites, configure and verify the cluster, and install the Tanzu CLI with any required plug-ins. For more information, see [Prerequisites](#).

Install pages for individual Tanzu Application Platform packages

- [Install API Auto Registration](#)
- [Install API portal](#)
- [Install Application Accelerator](#)
- [Install Application Configuration Service](#)
- [Install Application Live View](#)
- [Install Application Single Sign-On](#)
- [Install Bitnami Services](#)
- [Install cert-manager](#)
- [Install Cloud Native Runtimes](#)
- [Install Contour](#)
- [Install Crossplane](#)
- [Install default roles for Tanzu Application Platform](#)
- [Install Developer Conventions](#)
- [Install Eventing](#)
- [Install Flux CD Source Controller](#)
- [Install Learning Center for Tanzu Application Platform](#)
- [Install Out of the Box Templates](#)
- [Install Out of the Box Supply Chain with Testing](#)
- [Install Out of the Box Supply Chain with Testing and Scanning](#)
- [Install Service Bindings](#)
- [Install Services Toolkit](#)
- [Install Source Controller](#)
- [Install Spring Boot conventions](#)
- [Install Supply Chain Choreographer](#)
- [Install Supply Chain Security Tools - Store](#)

- [Install Supply Chain Security Tools - Policy Controller](#)
- [Install Supply Chain Security Tools - Scan](#)
- [Install Tanzu Developer Portal](#)
- [Install Tanzu Build Service](#)
- [Install Tekton](#)
- [Install Telemetry](#)

Verify the installed packages

Use the following procedure to verify that the packages are installed.

1. List the installed packages by running:

```
tanzu package installed list --namespace tap-install
```

For example:

```
$ tanzu package installed list --namespace tap-install
\ Retrieving installed packages...
NAME                                PACKAGE-NAME                                PAC
KAGE-VERSION  STATUS
api-portal                api-portal.tanzu.vmware.com                1.
0.3                      Reconcile succeeded
app-accelerator           accelerator.apps.tanzu.vmware.com           1.
0.0                      Reconcile succeeded
app-live-view             appliveview.tanzu.vmware.com               1.
0.2                      Reconcile succeeded
appliveview-conventions  build.appliveview.tanzu.vmware.com         1.
0.2                      Reconcile succeeded
cartographer              cartographer.tanzu.vmware.com              0.
1.0                      Reconcile succeeded
cloud-native-runtimes    cnrs.tanzu.vmware.com                      1.
0.3                      Reconcile succeeded
convention-controller    controller.conventions.apps.tanzu.vmware.com 0.
7.0                      Reconcile succeeded
developer-conventions    developer-conventions.tanzu.vmware.com      0.
3.0-build.1             Reconcile succeeded
grype-scanner            grype.scanning.apps.tanzu.vmware.com       1.
0.0                      Reconcile succeeded
image-policy-webhook     image-policy-webhook.signing.apps.tanzu.vmware.com 1.
1.2                      Reconcile succeeded
metadata-store           metadata-store.apps.tanzu.vmware.com        1.
0.2                      Reconcile succeeded
ootb-supply-chain-basic  ootb-supply-chain-basic.tanzu.vmware.com    0.
5.1                      Reconcile succeeded
ootb-templates           ootb-templates.tanzu.vmware.com           0.
5.1                      Reconcile succeeded
scan-controller          scanning.apps.tanzu.vmware.com             1.
0.0                      Reconcile succeeded
service-bindings         service-bindings.labs.vmware.com           0.
5.0                      Reconcile succeeded
services-toolkit         services-toolkit.tanzu.vmware.com           0.
8.0                      Reconcile succeeded
source-controller        controller.source.apps.tanzu.vmware.com     0.
2.0                      Reconcile succeeded
sso4k8s-install          sso.apps.tanzu.vmware.com                  1.
0.0-beta.2-31           Reconcile succeeded
tap-gui                   tap-gui.tanzu.vmware.com                   0.
3.0-rc.4                 Reconcile succeeded
tekton-pipelines         tekton.tanzu.vmware.com                    0.3
0.0                      Reconcile succeeded
```

```
tbs                               buildservice.tanzu.vmware.com      1.
5.0                               Reconcile succeeded
```

Next steps

- [Set up developer namespaces to use your installed packages](#)

Set up developer namespaces to use your installed packages

For details about how to automatically set up your developer namespaces, see [Provision developer namespaces in Namespace Provisioner](#).

Additional configuration for testing and scanning

If you plan to install or have already installed Out of the Box Supply Chains with Testing and Scanning, you can use Namespace Provisioner to set up the required resources. For more information, see [Customize installation](#) in the Namespace Provisioner documentation for configuration steps.

Legacy namespace setup

To use the legacy manual process for setting up developer namespaces, see [Legacy namespace setup](#).

Next steps

- [Install Tanzu Developer Tools for your VS Code](#)

Install Tanzu Developer Tools for your VS Code

This topic tells you how to install VMware Tanzu Developer Tools for Visual Studio Code (VS Code).

Prerequisites

Before installing the extension, you must have:

- [VS Code](#)
- [kubectl](#)
- [Tilt v0.30.12 or later](#)
- [Tanzu CLI and plug-ins](#)
- [A cluster with the Tanzu Application Platform Full profile or Iterate profile](#)

If you are an app developer, someone else in your organization might have already set up the Tanzu Application Platform environment.

Docker Desktop and local Kubernetes are not prerequisites for using Tanzu Developer Tools for VS Code.

Install

To install the extension:

1. Download Tanzu Developer Tools for Visual Studio Code from the [Broadcom Support Portal](#).
2. Open VS Code.
3. Press cmd+shift+P to open the Command Palette and run `Extensions: Install from VSIX...`



4. Select the extension file `tanzu-vscode-extension.vsix`.
5. If you do not have the following extensions, and they do not automatically install, install them from VS Code Marketplace:
 - o [Debugger for Java](#)
 - o [Language Support for Java\(™\) by Red Hat](#)
 - o [YAML](#)
6. Ensure Language Support for Java is running in [Standard Mode](#). You can configure it in the **Settings** menu by going to **Code > Preferences > Settings** under **Java > Server: Launch Mode**.

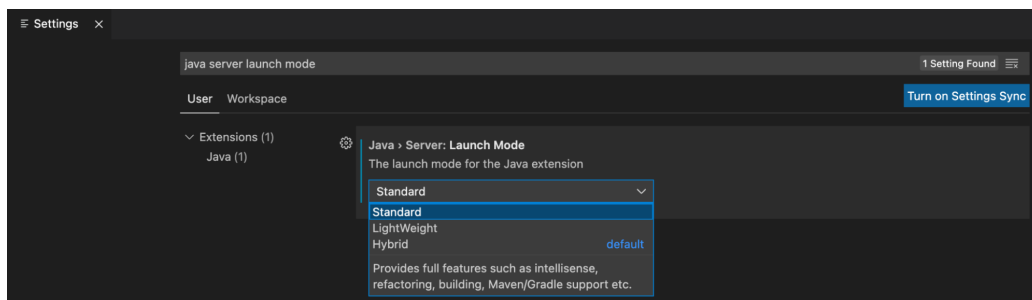

When the JDK and Language Support for Java are configured correctly, you see that the integrated development environment creates a directory target where the code is compiled.

Configure

To configure VMware Tanzu Developer Tools for VS Code:

1. Ensure that you are targeting the correct cluster. For more information, see the [Kubernetes documentation](#).
2. Go to **Code > Preferences > Settings > Extensions > Tanzu Developer Tools** and set the following:
 - o **Confirm Delete:** This controls whether the extension asks for confirmation when deleting a workload.
 - o **Enable Live Hover:** For more information, see [Integrating Live Hover by using Spring Boot Tools](#). Reload VS Code for this change to take effect.
 - o **Source Image:** The registry location for publishing local source code. For example, `registry.io/yourapp-source`. This must include both a registry and a project name. A source image registry location is optional when Local Source Proxy is configured.
 - o **Local Path:** (Optional) The path on the local file system to a directory of source code to build. This is the current directory by default.

- **Namespace:** (Optional) This is the namespace that workloads are deployed into. The namespace set in `kubeconfig` is the default.

Uninstall

To uninstall VMware Tanzu Developer Tools for VS Code:

1. Go to **Code > Preferences > Settings > Extensions**.
2. Right-click the extension and select **Uninstall**.

Next steps

Proceed to [Getting started with Tanzu Developer Tools for Visual Studio Code](#).

Tanzu GitOps RI Reference Documentation

The following diagrams shows you the components that are installed as part of Tanzu GitOps Reference Implementation (RI) and how they work together to automate the installation of Tanzu Application Platform (commonly known as TAP):

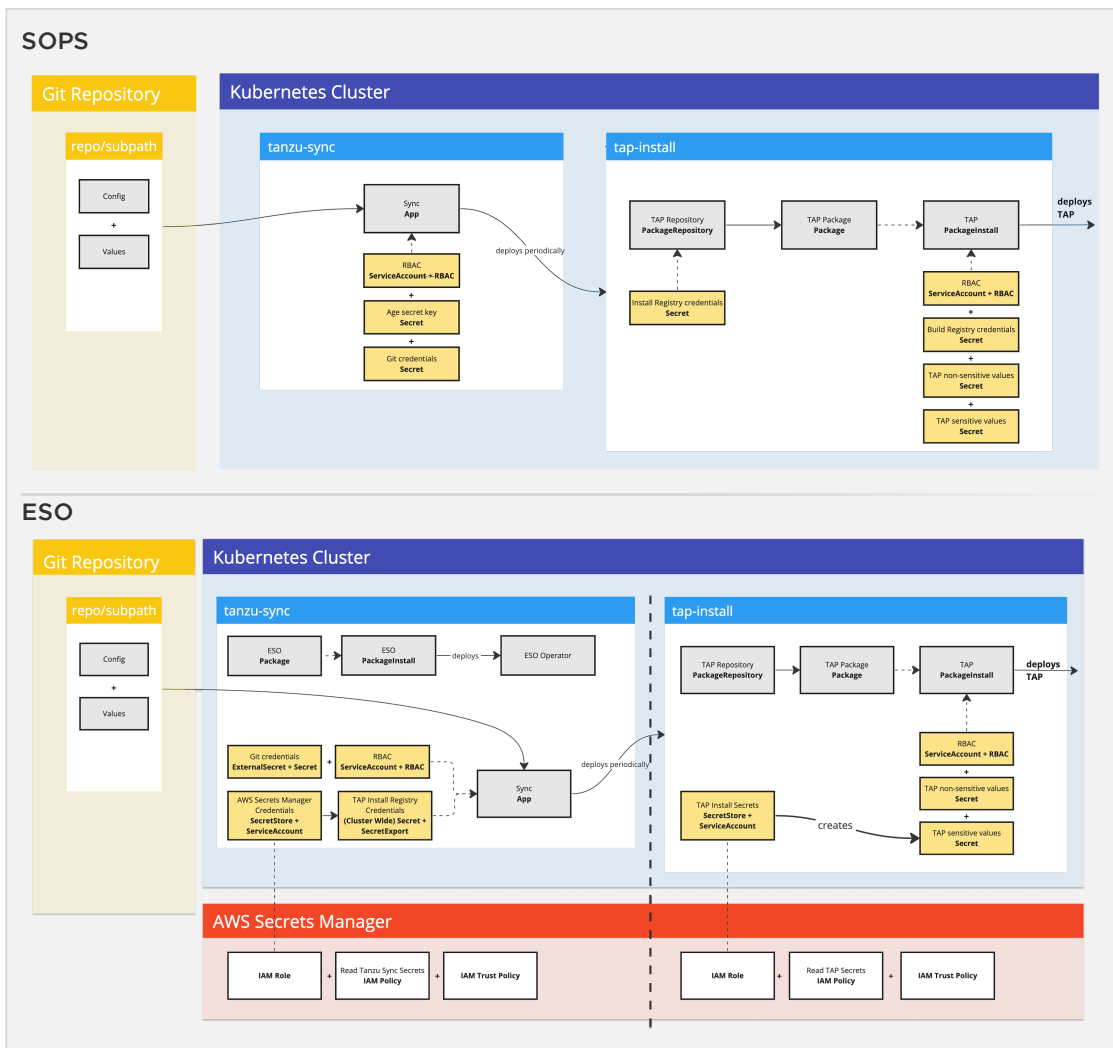

Caution

Tanzu Application Platform (GitOps) is currently in beta and is intended for evaluation and test purposes only. Do not use in a production environment.

Tanzu Sync Carvel Application

Tanzu Sync consists of a [Carvel](#) application named `sync` that is installed in the `tanzu-sync` namespace. The sync application:

1. Fetches a Git repository that contains configuration for Tanzu Application Platform.
2. Templates with `ytt` a set of resources and data values.
3. Deploys with `kapp` a set of resources to install Tanzu Application Platform, with any other user specified configuration in the Git Repository.

Choosing Secrets OPERations (SOPS) or External Secrets Operator (ESO)

The following table outlines the Kubernetes distributions and secret management solutions that SOPS and ESO support:

Choose	IaaS	Secrets Manager
SOPS	Any IaaS supported by Tanzu Application Platform	N/A
ESO	AWS EKS	AWS Secrets Manager
ESO	Azure, GKE and AWS EKS are supported by Tanzu Application Platform	Vault



Note

Future release will include additional Secrets Managers for ESO.

The following table describes a few common use cases and scenarios for SOPS and ESO:

I want ...	SOPS	ESO
Sensitive data encrypted inside the Git repository.		
Sensitive data to be stored outside the Git repository.		
Minimal setup. No external secret storage system		
To manage sensitive data myself. For example, storing keys, rotation and usage auditing.)		
To utilize sensitive data management. For example, storage, rotation and usage auditing by a third-party solution.		

Git Repository structure

Tanzu Sync Application fetches our deployable content from a Git repository that must match the following structure:

Git repository for a cluster named `full-tap-cluster`:

```

|-- .catalog
|   |-- tanzu-sync
|   |   |-- 0.0.3
|   |-- tap-install

```

```

├── 1.5.0
├── README.md
├── clusters
│   ├── full-tap-cluster
│   │   ├── README.md
│   │   ├── cluster-config
│   │   │   ├── config
│   │   │   │   ├── tap-install
│   │   │   │   │   └── .tanzu-managed
│   │   │   └── values
│   │   └── tanzu-sync
│   │       ├── app
│   │       │   ├── config
│   │       │   │   └── .tanzu-managed
│   │       │   └── values
│   │       ├── bootstrap
│   │       └── scripts
└── setup-repo.sh

```

Where:

- `.catalog`: VMware supplied directory of resources and configuration to install Tanzu Sync and Tanzu Application Platform.
 - `tanzu-sync`: Contains the Carvel Packaging App which supports a GitOps workflow for fetching, templating and deploying the `clusters/full-tap-cluster/cluster-config` directory of this repository.
 - `tap-install`: Contains the configuration to install Tanzu Application Platform.
- `clusters/full-tap-cluster`
 - `cluster-config`
 - `config`: Contains the Tanzu Application Platform installation configuration. This directory can be extended to include any desired resources managed through GitOps to your cluster.
 - `.tanzu-managed`: Contains VMware managed Kubernetes resource files to install Tanzu Application Platform. Do not alter this value.
 - `values`: Contains the plain YAML data files which configure the application.
 - `tanzu-sync`
 - `app`: Contains the main Carvel Packaging App that runs on the cluster. It fetches, templates and deploys your Tanzu Application Platform installation from `clusters/full-tap-cluster/cluster-config`.
 - `bootstrap`: Contains secret provider specific bootstrapping if required.
 - `scripts`: Contains helper scripts to assist with the configuration and deployment of Tanzu GitOps RI.

Configuration of Tanzu Sync without helper scripts

1. The following plain YAML values files are required to run Tanzu Sync:

- Tanzu Sync App:

`clusters/full-tap-cluster/tanzu-sync/app/values/values.yaml` adhering to the following schema:

```

#@data/values-schema
#@overlay/match-child-defaults missing_ok=True
---
git:

```

```

url: ""
ref: ""
sub_path: ""

tap_package_repository:
  oci_repository: ""

```

Example:

```

---
git:
  url: git@github.com:my-org/gitops-tap.git
  ref: origin/main
  sub_path: clusters/full-tap-cluster/cluster-config

tap_package_repository:
  oci_repository: registry.example.com/tanzu-application-platform/tap-pac
kages

```

- o Tanzu Application Platform Install:

[clusters/full-tap-cluster/cluster-config/config/values/install-values.yaml](#) adhering to the following schema:

```

#@data/values-schema
#@overlay/match-child-defaults missing_ok=True
---
tap_install:
  package_repository:
    oci_repository: ""
  #@schema/type any=True
  values: {}

```

Example:

```

tap_install:
  package_repository:
    oci_repository: registry.example.com/tanzu-application-platform/tap-p
ackages
  values:
    shared:
      ingress_domain: example.vmware.com
      ceip_policy_disclosed: true

```

[clusters/full-tap-cluster/cluster-config/config/values/sensitive-values.sops.yaml](#) adhering to the following schema:

```

#@data/values-schema
#@overlay/match-child-defaults missing_ok=True
---
tap_install:
  #@schema/nullable
  #@schema/validation not_null=True
  #@schema/type any=True
  sensitive_values: {}

```

Example:

```

tap_install:
  sensitive_values:
    shared:
      image_registry:
        project_path: example.registry.com/my-project/my-user/tap

```

```
username: my-username
password: my-password
```

- The following is used to deploy the application by using `kapp`:

```
kapp deploy --app tanzu-sync --file <(ytt \
  --file tanzu-sync/app/config \
  --file cluster-config/config/tap-install/.tanzu-managed/version.yaml \
  --data-values-file tanzu-sync/app/values/ \
  --data-value secrets.sops.age_key=$(cat $HOME/key.txt) \
  --data-value secrets.sops.registry.hostname="hostname" \
  --data-value secrets.sops.registry.username="foo@example.com" \
  --data-value secrets.sops.registry.password="password" \
  --data-value secrets.sops.git.ssh.private_key=$(cat $HOME/.ssh/my_private_key) \
  --data-value secrets.sops.git.ssh.known_hosts=$(ssh-keyscan github.com) \
)
```

Tanzu Sync Scripts



Caution

The provided scripts are intended to help set up your Git repository to work with a GitOps approach, they are subject to change or removal between releases.

VMware provides a set of convenience bash scripts in `clusters/MY-CLUSTER/tanzu-sync/scripts` to help you set up your Git repository and configure the values as described in the previous section:

- `setup-repo.sh`: Populates a Git repository with the structure described in the [Git Repository structure](#) section.
- `configure.sh`: Generates the values files described in the [Configuration of values without helper scripts](#) section.
- `deploy.sh`: A light wrapper around a simple `kapp deploy` given the data values from the previous section and sensitive values which must not be stored on disk.

Customize your package installation

You can customize your package configuration that is not exposed through data values by using annotations and ytt overlays.

You can customize a package that was [installed manually](#) or that was [installed by using a Tanzu Application Platform profile](#).

Customize a package that was manually installed

To customize a package that was installed manually:

- Create a `secret.yml` file with a `Secret` that contains your ytt overlay. For example:

```
apiVersion: v1
kind: Secret
metadata:
  name: tap-overlay
  namespace: tap-install
stringData:
  custom-package-overlay.yml: |
    CUSTOM-OVERLAY
```

For more information about ytt overlays, see the [Carvel documentation](#).

2. Apply the `Secret` to your cluster by running:

```
kubectl apply -f secret.yml
```

3. Update your `PackageInstall` to include the `ext.packaging.carvel.dev/ytt-paths-from-secret-name.x` annotation to reference your new overlay `Secret`. For example:

```
apiVersion: packaging.carvel.dev/v1alpha1
kind: PackageInstall
metadata:
  name: PACKAGE-NAME
  namespace: tap-install
  annotations:
    ext.packaging.carvel.dev/ytt-paths-from-secret-name: tap-overlay
  ...
```



Note

You can suffix the extension annotation with `.x`, where `x` is a number, to apply multiple overlays. For more information, see the [Carvel documentation](#).

Customize a package that was installed by using a profile

To add an overlay to a package that was installed by using a Tanzu Application Platform profile:

1. Create a `Secret` with your ytt overlay. For more information about ytt overlays, see the [Carvel documentation](#).
2. Update your values file to include a `package_overlays` field:

```
package_overlays:
- name: PACKAGE-NAME
  secrets:
  - name: SECRET-NAME
```

Where `PACKAGE-NAME` is the target package for the overlay. For example, `tap-gui`.

3. Update Tanzu Application Platform by running:

```
tanzu package installed update tap -p tap.tanzu.vmware.com -v 1.6.13 --values-file tap-values.yaml -n tap-install
```

For information about Tanzu Application Platform profiles, see [Installing Tanzu Application Platform package and profiles](#).

Opt out of telemetry collection

This topic tells you how to opt out of the VMware Customer Experience Improvement Program (CEIP) and out of Pendo telemetry on an organizational level.

There are two components for telemetry collection in Tanzu Application Platform (commonly known as TAP) under the VMware Customer Experience Improvement Program (CEIP):

1. The standard CEIP telemetry collection

2. Pendo telemetry from Tanzu Developer Portal (formerly named Tanzu Application Platform GUI)

Each telemetry component has its own opt-in and opt-out process. The CEIP telemetry opt-out decision can be made at an organizational level, whereas the decision regarding the Pendo telemetry is available both on an organizational level and at an individual user level.

When you install Tanzu Application Platform, both standard CEIP and Pendo telemetry are turned on by default. If you opt out of standard CEIP telemetry collection, VMware cannot offer you proactive support and the other benefits that accompany participation in the CEIP.

Turn off standard CEIP telemetry collection

To deactivate Pendo telemetry collection, see [Enable or deactivate the Pendo telemetry for the organization](#) later in the topic.



Note

If you decide to opt in to Pendo telemetry collection, each user is given the option to opt in or opt out. For more information, see [Opt in or opt out of Pendo telemetry for Tanzu Developer Portal](#).

To turn off CEIP telemetry collection, follow these instructions:

kubectl

To turn off telemetry collection on Tanzu Application Platform by using kubectl:

1. Ensure that your Kubernetes context is pointing to the cluster where Tanzu Application Platform is installed.
2. Run:

```
kubectl apply -f - <<EOF
apiVersion: v1
kind: Namespace
metadata:
  name: vmware-system-telemetry
---
apiVersion: v1
kind: ConfigMap
metadata:
  namespace: vmware-system-telemetry
  name: vmware-telemetry-cluster-ceip
data:
  level: disabled
EOF
```

3. If you already have Tanzu Application Platform installed, restart the telemetry collector to apply the change:

```
kubectl delete pods --namespace tap-telemetry --all
```

Your Tanzu Application Platform deployment now no longer emits telemetry, and you have opted out of the CEIP.

Tanzu CLI

The Tanzu CLI provides a telemetry plug-in enabled by the Tanzu Framework v0.25.0, which is included in Tanzu Application Platform v1.3 and later.

To turn off telemetry collection on your Tanzu Application Platform by using the Tanzu CLI, run:

```
tanzu telemetry update --CEIP-opt-out
```

To learn more about how to update the telemetry settings, run:

```
tanzu telemetry update --help
```

Your Tanzu Application Platform deployment now no longer emits telemetry, and you have opted out of the CEIP.

Turn off Pendo telemetry collection

To deactivate the program for the entire organization, add the following parameters to your `tap-values.yaml` file:

```
tap_gui:
  app_config:
    pendoAnalytics:
      enabled: false
```

To enable Pendo telemetry for the organization, add the following parameters to your `tap-values.yaml` file:

```
tap_gui:
  app_config:
    pendoAnalytics:
      enabled: true
```

Opt in or opt out of Pendo telemetry for Tanzu Developer Portal

Tanzu Developer Portal (formerly called Tanzu Application Platform GUI) uses Pendo.io to better understand the way users interact with it to provide a better user experience for VMware customers and to improve VMware products and services.

Pendo.io collects data based on your interaction with the software, such as clickstream data and page loads, hashed user ID, and limited browser and device information.

By default, each instance of Tanzu Developer Portal is assigned to a random organization ID to ensure that your sensitive information is not revealed.

However, you can choose to customize your organization ID and self-identify. Doing so allows VMware to observe account-level telemetry, such as frequency of portal use, most popular function, and so on. All personally identifiable information remains anonymized in any case. The organization name is hashed to prevent VMware from identifying you by the value.

To customize your organization ID, see [Customize the Tanzu Developer Portal telemetry collection](#).

To enable or deactivate Pendo telemetry for the organization, see [Enable or deactivate the Pendo telemetry for the organization](#).



Note

Pendo telemetry is separate from the VMware CEIP telemetry. There is a separate process for opting in or out of the VMware CEIP. For more information, see [Opt out of telemetry collection](#).

Opt in or opt out of Pendo telemetry from Tanzu Developer Portal

After the Pendo telemetry is enabled for the organization, in accordance with VMware policy each user is prompted to agree to participate in the program or decline.

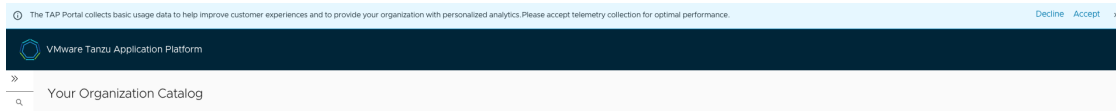

Each individual's preference is stored in Tanzu Developer Portal and can be modified at any time. To change your preferences, go to **Settings > Preferences**.

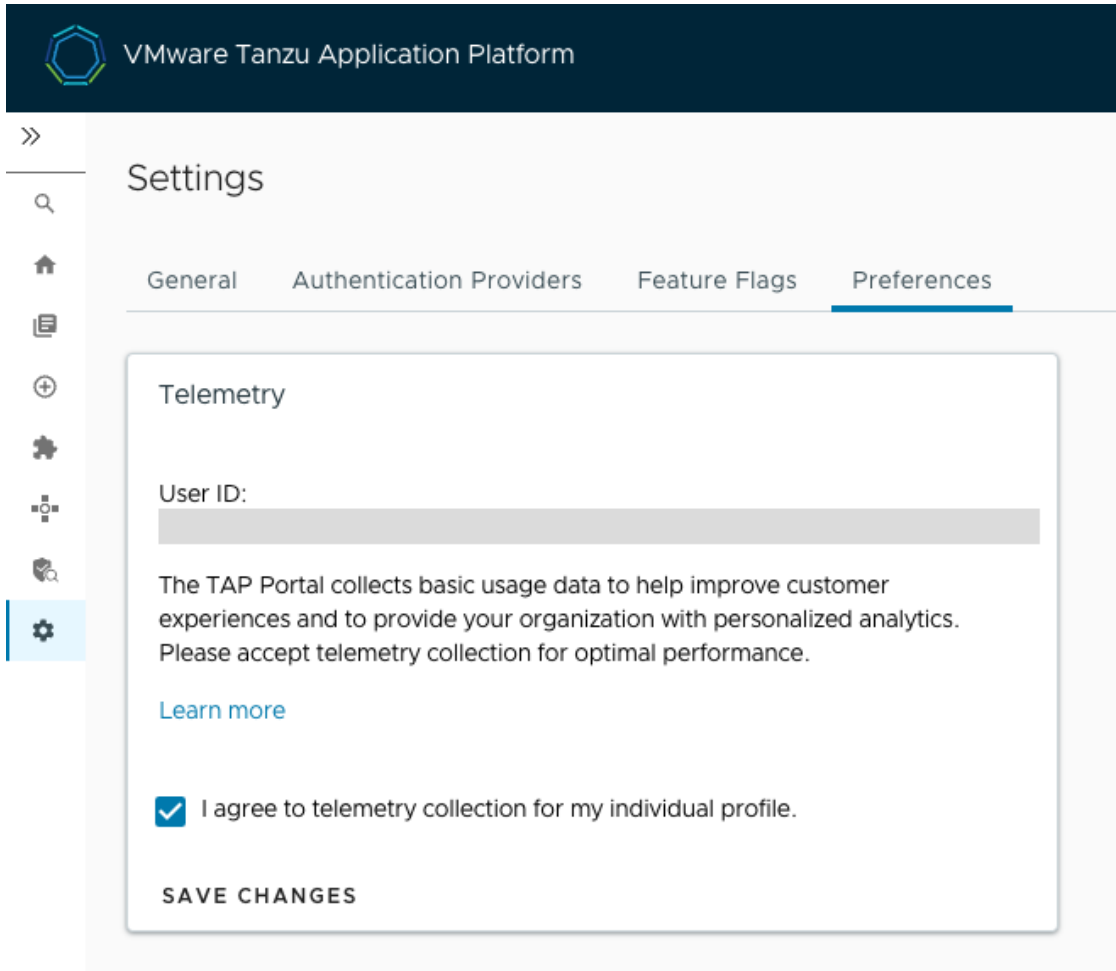

Request to delete your anonymized data

If you no longer want to participate in the program and you want VMware to delete all your anonymized data, please send an email requesting deletion, with your hashed User ID, to tap-pendo@groups.vmware.com.

This enables VMware to identify your anonymized data and delete it in accordance with the applicable regulations.

To find your hashed User ID, go to **Settings > Preferences** in Tanzu Developer Portal.

Upgrade compatibility and recommendations for Tanzu Application Platform

This topic gives you general information to help you with upgrading Tanzu Application Platform (commonly known as TAP).

Supported upgrade paths

Tanzu Application Platform v1.6 supports upgrading from v1.5.x.

Compatibility

This section describes the compatibility considerations for Tanzu Application Platform v1.6.

Kubernetes compatibility

For supported Kubernetes versions, see [Kubernetes version support for Tanzu Application Platform](#).

You must use a kubectl version that is within one minor version difference of your cluster. For example, a v1.30 client can communicate with v1.29, v1.30, and v1.31 control planes. Using the latest compatible version of kubectl helps avoid unforeseen issues.

Tanzu CLI compatibility

Tanzu Application Platform v1.6 is compatible with Tanzu CLI v1.0.0 and later and Tanzu CLI plug-ins for Tanzu Application Platform v1.6.x. The Tanzu CLI core v1.2 that is distributed with Tanzu Application Platform is forward and backward compatible with all supported Tanzu Application Platform versions.

There is a group of Tanzu CLI plug-ins that extend the Tanzu CLI core with Tanzu Application Platform specific features. You can install the plug-ins as a group with a single command. Versioned releases of the Tanzu Application Platform specific plug-in group align to each supported Tanzu Application Platform version. This makes it easy to switch between different versions of Tanzu Application Platforms environments.

Recommendations

- **Test the upgrade in a staging or development environment:** Use an environment that mirrors your production setup. This allows you to identify any potential issues or compatibility issues with your workloads before performing the upgrade in production.
- **Consider your tolerance for downtime per environment:** For example, sandbox might not need to scale out replicas of workloads or Tanzu Application Platform components. Use PodDisruptionBudgets only in environments that require high availability, such as production or higher level test environments. Only configure PodDisruptionBudgets if `minScale` or `replicas` are greater than 1.

- **Consider your tolerance for downtime per Tanzu Application Platform profile:** You might have different downtime tolerances for each Tanzu Application Platform profile. Take time to understand these as one size does not fit all.
- **Consider the resource requirements for the upgraded Kubernetes cluster:** This includes CPU, memory, and storage. Ensure that your underlying infrastructure can support the new version and accommodate any changes in resource use from your workloads. You might want to preemptively scale out your nodes instead of letting autoscaling start.
- **Perform health checks on your cluster and workloads before starting the upgrade:** This helps to identify any issues that might impact the upgrade or the stability of your workloads post-upgrade. For more information, see:
 - [View cluster: Pre-Upgrade Cluster Health Check](#)
 - [Build cluster: Pre-Upgrade Cluster Health Check](#)
 - [Run cluster: Pre-Upgrade Cluster Health Check](#)
- **Implement robust monitoring and observability tools:** Use these tools to track the health and performance of your Kubernetes cluster and workloads before, during, and after the upgrade. This helps you to detect any anomalies or performance degradation post-upgrade.
- **Consider the availability needs for workloads:** Tune them with the proper number of replicas and corresponding PodDisruptionBudget. Consider customizing the Tanzu Application Platform `SupplyChain` to stamp out a `PodDisruptionBudget` for workloads if needed. Knative workloads come with their own `PodDisruptionBudget` components. Production workloads running a server workload type must have a replica count of 2 or more to avoid downtime during scheduling of resources. Knative resources must have `minScale` set to 2 or more to avoid downtime.
- **Review compatibility of custom components:** Review any custom components you've added to the cluster for compatibility with Kubernetes.
- **Review the upgrade preparation checklist:** During your upgrade, follow the [Upgrade preparation checklist](#).

Recommendations for apps

- **Ensure that all apps have a readiness or liveness probes:** This helps to avoid disruption during upgrades of Kubernetes and Tanzu Application Platform.
- **Consider using pod affinity rules:** This helps to spread out workloads across nodes and availability zones.
- **Use a pod disruption budget for workloads:** This helps to avoid downtime during upgrades, especially during Kubernetes upgrades.
- **Ensure that your app is protected against failure:** For example, the app uses a 12 factor app design and it can handle graceful shutdown.
- **Ensure that you have copies of business critical apps in a non-production cluster:** This cluster is where the upgrade can be tested before upgrading the cluster that contains the production instance of the app.

Upgrade preparation checklist

Complete the tasks in the following table before you upgrade Tanzu Application Platform.

Component	Description
Upgrade Tanzu CLI	Upgrade to the latest Tanzu CLI and plug-in group by following the instructions in Install the Tanzu CLI .
Upgrade Cluster Essentials	Upgrade Cluster Essentials . If your cluster is maintained by Tanzu Mission Control, you do not need to install or update Cluster Essentials.
Relocate the Tanzu Application Platform package images	Relocate images from tanzu.packages.broadcom.com to your internal registry by following the instructions in Relocate images to a registry .
Relocate the full Tanzu Build Service dependencies	(Optional) Relocate the full Tanzu Build Service dependencies to your internal registry by following the instructions in Install the Tanzu Build Service dependencies . This is not required if you only want the lite dependencies.
Review Kubernetes cluster capacity	Verify that you have enough spare CPU and memory capacity on your Run and Build cluster nodes for the upgrade. You need to schedule capacity for the new pods that are created during an upgrade.
Review any custom overlays	Check if there were any changes between versions for your custom overlays. For example, for the Supply Chain components. To pull a package after upgrading to view its contents and run a comparison, run: <div style="border: 1px solid #ccc; padding: 10px; margin: 10px 0;"> <pre>imgpkg pull -b \$(kubectl get \$PACKAGE_NAME < -n tap-install \ -ojson jq -r '.spec.fetch[0].imgpkgBundle.image') \ -o /tmp/\$PACKAGE_NAME && code /tmp/\$PACKAGE_NAME</pre> </div> <p>If you're using an overlay for Tanzu Developer Portal to surface additional Backstage plug-ins, re-run the steps to rebuild your customized Tanzu Developer Portal image by following the instructions in Build your customized Tanzu Developer Portal with Configurator. The re-built image will be referenced in the Tanzu Developer Portal overlay secret. Rebuilding the image is necessary because Tanzu Developer Portal includes a pinned version of Backstage and versions of node.</p> <p>Take into account updates to Backstage versions. Review overlays, especially updates to API versions of Kubernetes resources targeted by each overlay.</p>
Review breaking changes for the Tanzu Application Platform release	See v1.6 Breaking changes in the release notes.
Plan your order of upgrade by cluster and then environment	Recommended order to upgrade clusters: <ol style="list-style-type: none"> 1. View cluster 2. Build clusters 3. Run clusters <p>Upgrade a sandbox or test environment first before upgrading subsequent environments.</p> <p>You cannot jump upgrade versions n+2 until Tanzu Application Platform v1.7.x. For the list of versions you can upgrade to Tanzu Application Platform v1.6, see Supported upgrade paths earlier in this topic.</p>
Check the storage capacity of your container registry, such as Harbor or Artifactory, for sufficient storage	New containers are created during an upgrade. This can increase the need for storage capacity.

Component	Description
If you are using GitOps RI, tag your GitOps repository to maintain a point in time of your Tanzu Application Platform configuration	<p>Example tag commands:</p> <pre>git tag -a v1.x.x git push origin v1.x.x</pre>

View cluster checklists

Pre-upgrade cluster health check - View cluster

Complete the tasks in the following table before you upgrade the Tanzu Application Platform View cluster.

Item	Description
Platform health monitoring	Ensure that you have some form of monitoring in place to allow observability into your cluster during an upgrade.
Check the health of each <code>packageRepository</code> and <code>PackageInstall</code> on the cluster	<p>Run:</p> <pre>tanzu package repository list -A tanzu package installed list -A</pre>
Check the health of all kapp apps on the cluster	<p>Run:</p> <pre>kapp list -A</pre>
Check capacity of nodes on the cluster. You might want to preemptively scale out your nodes if they are at a higher capacity instead of letting autoscaling start during an upgrade.	<p>Run:</p> <pre>kubectl top nodes</pre>
Verify basic Tanzu Application Platform features on the cluster	<ul style="list-style-type: none"> • Test that Tanzu Developer Portal is working. • Test that you can generate code from Accelerators.
Check the health of pods on the cluster	<p>Run:</p> <pre>kubectl get pods -A --field-selector=status.phase!=Running,status.phase!=Succeeded</pre>

Upgrade considerations for Kubernetes - View Cluster

The following table lists information about upgrading Kubernetes specific to the View cluster.

Item	Description
Scale out Metadata Store pods for high availability	<p>Consider scaling out Metadata Store to have more than one replica to limit downtime. For example:</p> <pre data-bbox="683 338 1267 454"> metadata_store: app_replicas: 3 </pre>
Create a <code>PodDisruptionBudget</code> for the Metadata Store app for high availability	<p>For example:</p> <pre data-bbox="683 566 1267 907"> apiVersion: policy/v1 kind: PodDisruptionBudget metadata: name: metadata-store-pdb namespace: metadata-store spec: minAvailable: 60% selector: matchLabels: app: metadata-store-app </pre>
<p>Configure Contour to be a DaemonSet to avoid downtime. If downtime is acceptable set to type deployment.</p> <p>This is only applicable if you are upgrading from Tanzu Application Platform v1.6 or earlier. Contour is a deployment by default as of Tanzu Application Platform v1.7.</p>	<p>For example:</p> <pre data-bbox="683 1025 1267 1202"> contour: envoy: workload: type: daemonset </pre>

Item	Description
Scale out Tanzu Developer Portal pods for high availability	For example:

```
tap_gui:
  deployment:
    replicas: 3
```

When Tanzu Developer Portal pods are scaled out, there is a known issue with generating Accelerators. You must apply the following overlay to the Tanzu Developer Portal package:

```
apiVersion: v1
kind: Secret
metadata:
  name: tap-gui-session-mgmt-affinity-secret
  namespace: tap-install
stringData:
  tap-gui-session-mgmt-affinity.yml: |
    #@ load("@ytt:overlay", "overlay")

    #@overlay/match by=overlay.subset({"kind": "HTTPProxy", "metadata":{"name": "tap-gui"})
    ---
    spec:
      routes:
        #@overlay/match by=overlay.subset({"services": [{"name": "server"}]})
        - services: []
          #@overlay/match missing_ok=True
          loadBalancerPolicy:
            strategy: Cookie
```

And add the following to the `tap-values.yaml` file:

```
package_overlays:
  - name: "tap-gui"
    secrets:
      - name: "tap-gui-session-mgmt-affinity-secret"
```

Item	Description
Create a <code>PodDisruptionBudget</code> for Tanzu Developer Portal for high availability	<p>For example:</p> <pre> apiVersion: policy/v1 kind: PodDisruptionBudget metadata: name: tap-gui-pdb namespace: tap-gui spec: minAvailable: 60% selector: matchLabels: app: backstage </pre>

Upgrade considerations for Tanzu Application Platform - View Cluster

The following table lists information about upgrading Tanzu Application Platform specific to the View cluster.

Item	Description
If upgrading from Tanzu Application Platform v1.6 or earlier, set up Artifact Metadata Repository (AMR)	<p>There are two new endpoints created on the view cluster with AMR. You might need to add them to your allowlist or have custom certificates configured with Tanzu Application Platform v1.7 and later.</p> <ul style="list-style-type: none"> <code>amr-cloudevent-handler.DOMAIN</code> <code>amr-graphql.DOMAIN</code>
What to expect during the upgrade on the View cluster	<ul style="list-style-type: none"> Tanzu Developer Portal might show a gray or missing status on the Supply Chain page. You might have issues with viewing pages. Consider doing a hard fresh for browsers.
If using GitOps RI, update the <code>version.yaml</code> file with the new Tanzu Application Platform version	<p>You can find the file at the following location:</p> <pre> /clusters/CLUSTER-NAME/cluster-config/config/tap-install/.tanzu-managed/version.yaml </pre>
If using GitOps RI, run the <code>deploy.sh</code> script to pull in latest External Secret Operator version with Tanzu Application Platform	<p>You can find the script at the following location:</p> <pre> /clusters/CLUSTER-NAME/tanzu-sync/scripts/deploy.sh </pre>
If using GitOps RI, make adjustments to your <code>tap-values.yaml</code> file if needed, and push the updated <code>version.yaml</code> and <code>tap-values.yaml</code> files to the Git repository	<p>After pushing the changes to Git, run these commands to sync the changes to the cluster and start the upgrade:</p> <pre> kctrl app kick -a sync -n tanzu-sync kctrl app kick -a tap -n tap-install </pre>

Post upgrade checks - View cluster

Complete the tasks in the following table after you upgrade the Tanzu Application Platform View cluster.

Item	Description
<p>Check the health of each <code>packageRepository</code> and <code>PackageInstall</code> on the cluster.</p> <p>They must now display the newest version of Tanzu Application Platform.</p>	<p>Run:</p> <pre>tanzu package repository list -A tanzu package installed list -A</pre>
<p>Check the health of all kapp apps on the cluster</p>	<p>Run:</p> <pre>kapp list -A</pre>
<p>Check the health of pods on the cluster</p>	<p>Run:</p> <pre>kubect1 get pods -A --field-selector=status.phase!=Running,status.phase!=Succeeded</pre>
<p>Verify that Tanzu Developer Portal starts</p>	<p>Log into Tanzu Developer Portal and verify that the basic functionality still works as expected.</p>

Build cluster checklists

Pre-upgrade cluster health check - Build cluster

Complete the tasks in the following table before you upgrade the Tanzu Application Platform Build cluster.

Item	Description
<p>Platform health monitoring</p>	<p>Ensure that you have some form of monitoring in place to allow observability into your cluster during an upgrade.</p>
<p>Check the health of each <code>packageRepository</code> and <code>PackageInstall</code> on the cluster.</p> <p>Fix any broken packages or repositories.</p>	<p>Run:</p> <pre>tanzu package repository list -A tanzu package installed list -A</pre>
<p>Check the health of all kapp apps on the cluster.</p> <p>Fix any kapp apps that are in a bad state before upgrading.</p>	<p>Run:</p> <pre>kapp list -A</pre>
<p>Check capacity of nodes on the cluster.</p> <p>You might want to preemptively scale out your nodes if they are at a higher capacity instead of letting autoscaling start during an upgrade.</p>	<p>Run:</p> <pre>kubect1 top nodes</pre>
<p>Check the health of workloads on the cluster.</p> <p>Consider fixing any workloads that are in a bad state before upgrading.</p>	<p>Run:</p> <pre>tanzu apps workload list -A</pre>
<p>Check the health of pods on the cluster.</p> <p>Consider fixing any pods that are in a bad state before upgrading.</p>	<p>Run:</p> <pre>kubect1 get pods -A --field-selector=status.phase!=Running,status.phase!=Succeeded</pre>

Upgrade considerations for Kubernetes - Build Cluster

The following table lists information about upgrading Kubernetes specific to the Build cluster.

Item	Description
Image cache on nodes will be reset	As new nodes are spun up on a cluster, it might take longer to pull images as the cache has not been filled. This is only noticeable on the first pull of images.
Consider pre-scaling the number of nodes	Upgrading Kubernetes can trigger new pods, which take resources on the node. Node autoscaling will start up, which can take time and impact the window of the upgrade. Consider scaling capacity before an upgrade.
Expect to lose logs on completed pods for workloads	Expect to lose pod logs for the tests, builds and scans for a workload. Tanzu Developer Portal will continue to show the build history, but logs will be missing.

Upgrade considerations for Tanzu Application Platform - Build Cluster

The following table lists information about upgrading Tanzu Application Platform specific to the Build cluster.

Item	Description
Contour package is removed as of Tanzu Application Platform v1.7	The contour package is deleted from the Build Cluster as of Tanzu Application Platform v1.7.
New versions of Buildpacks from the Tanzu Application Platform upgrade triggers new Tanzu Build Service builds for all workloads	When upgrading Tanzu Application Platform, new buildpacks will be introduced. This triggers new Tanzu Build Service builds. Expect workloads affected by updated buildpacks to rebuild. Node autoscaling will happen. Your container image registry might have bursts of traffic and activity with new builds. Plan accordingly.
Set an overlay for resource limits on Kpack to optimize resources used by builds	When new buildpacks are applied during an upgrade, expect all workloads to trigger a new build. This might flood your cluster with build requests. Ensure that you have scaled out enough nodes and the appropriate processors to avoid being starved for CPU or memory.

Item	Description
If upgrading from TAP 1.6 or earlier, set up Artifact Metadata Repository (AMR) Observer on the Build cluster	Set up the AMR Observer on the Build cluster by following the instructions in Multicluster setup for Supply Chain Security Tools - Store . This communicates with the AMR EventHandler on the View cluster. For example:

Add the following to the Build cluster `tap-values.yaml` file:

```

amr:
  observer:
    auth:
      kubernetes_service_accounts:
        autoconfigure: false
        enable: true
      cloudevent_handler:
        endpoint: https://amr-cloudevent-handler.DOMAIN
IN
      ca_cert_data: |
        -----BEGIN CERT-----

```

Run the following commands on the View cluster to retrieve the AMR CA certificate and access token. Apply the CA certificate and access token on the Build cluster. The CA Cert goes into the `tap-values.yaml` file. Add the edit token as a Kubernetes secret on the Build cluster.

```

CEH_CA_CERT_DATA=$(kubectl get secret amr-cloudevent-handler-ingress-cert \
  -n metadata-store -o json | jq -r ".data.\"tls.crt\" | base64 -d)

CEH_EDIT_TOKEN=$(kubectl get secrets amr-cloudevent-handler-edit-token \
  -n metadata-store -o jsonpath="{.data.token}" | base64 -d)

```

Example external secret setup:

```

---
apiVersion: external-secrets.io/v1beta1
kind: ExternalSecret
metadata:
  name: amr-observer-edit-token
  namespace: tap-install
spec:
  secretStoreRef:
    name: tap-install-secrets
    kind: SecretStore
  refreshInterval: "1m"
  target:
    template:
      data:
        token: "{{ .amr_token }}"
  data:
    - secretKey: amr_token
      remoteRef:
        key: PATH-TO-EXTERNAL-SECRET-STORE
        property: amr_token
---
apiVersion: secretgen.carvel.dev/v1alpha1

```

Item	Description
	<pre> kind: SecretExport metadata: name: amr-observer-edit-token namespace: tap-install spec: toNamespaces: - amr-observer-system --- apiVersion: secretgen.carvel.dev/v1alpha1 kind: SecretImport metadata: name: amr-observer-edit-token namespace: amr-observer-system spec: fromNamespace: tap-install </pre>

Update `SupplyChain` customizations for any changes

`ClusterTasks` were removed as of Tanzu Application Platform v1.7. For example, if you wrote your own `ClusterTemplate` that uses the `git-writer` task, you must reference it as follows:

```

taskRef:
  resolver: cluster
  params:
    - name: kind
      value: task
    - name: namespace
      value: tap-tasks
    - name: name
      value: git-writer

```

If you've customized the `config-writer-template` in the `ClusterTemplate`, Ensure that the `configPath` property refers to `.spec.params` instead of `.spec.input.params`.

Item	Description
<p>Upgrading to Supply Chain Security Tools (SCST) - Scan 2.0 (SCST - Scan 1.0 is deprecated as of Tanzu Application Platform v1.10).</p>	<p>Upgrading from SCST - Scan 1.0 to SCST - Scan 2.0 in Tanzu Application Platform requires you to coordinate multiple steps across the Build and View clusters. There will be new token or certificate values to pull from the View cluster and configuration on the supply chain to move to Scan 2.0.</p>
<p>Trivy is the new default scanner.</p>	<p>The scanning section on the Build cluster now needs the CA and Auth Token from the View cluster for Metadata store. If using GitOps RI, consider storing these in an external secret for sensitive values.</p>
	<pre data-bbox="563 506 1262 790"> scanning: metadataStore: exports: ca: pem: CONTENTS-OF-MDS-CA-CERT auth: token: CONTENTS-OF-MDS-AUTH-TOKEN </pre> <p data-bbox="563 813 1262 869">Where <code>CONTENTS-OF-MDS-CA-CERT</code> is the contents of <code>\$MDS_CA_CERT</code> and <code>CONTENTS-OF-MDS-AUTH-TOKEN</code> is the content of <code>\$MDS_AUTH_TOKEN</code>.</p> <p data-bbox="563 898 1262 976">You can remove the Grype section from your <code>tap-values.yaml</code> file for the Build cluster. Trivy is now the default scanner for Tanzu Application Platform.</p> <p data-bbox="563 1014 1262 1122">Ensure that you delete any configured secrets in the <code>metadata-store-secrets</code> namespace on the build cluster. These are configured automatically, so removing them helps to avoid issues like kapp ownership conflicts.</p> <p data-bbox="563 1155 1262 1178">Configure Trivy Scanner in your <code>tap-values.yaml</code> file on the Build cluster.</p> <pre data-bbox="563 1227 1262 1429"> ootb_supply_chain_testing_scanning: image_scanner_template_name: image-vulnerability-scan-trivy image_scanning_cli: image: PATH-TO-RELOCATED-IMAGE </pre> <p data-bbox="563 1451 1262 1529">After applying the changes to the Build cluster and the reconciliation is successful, run the Namespace Provisioner on the Build cluster to reconcile any changes to each namespace.</p> <p data-bbox="563 1563 1262 1619">Note: If you are moving away from Grype, set the following flag to deactivate Grype for all namespaces:</p> <pre data-bbox="563 1664 1262 1809"> namespace_provisioner: default_parameters: skip_grype: true </pre> <p data-bbox="563 1832 1262 1910">Note: If you use or you switch between different scanners in Tanzu Application Platform v1.9 and earlier, Metadata Store will show duplicate results in the Tanzu Developer Portal Security Analysis UI.</p>
<p>If using GitOps RI, update the <code>version.yaml</code> file with the new Tanzu Application Platform version</p>	<p>You can find the file at the following location: <code>/clusters/CLUSTER-NAME/cluster-config/config/tap-install/.tanzu-managed/version.yaml</code></p>

Item	Description
If using GitOps RI, run the <code>deploy.sh</code> script to pull in latest External Secret Operator version with Tanzu Application Platform	You can find the script at the following location: <code>/clusters/CLUSTER-NAME/tanzu-sync/scripts/deploy.sh</code>
If using GitOps RI, make adjustments to your <code>tap-values.yaml</code> file if needed, and push the updated <code>version.yaml</code> and <code>tap-values.yaml</code> files to the Git repository	After pushing the changes to Git, run the these commands to sync changes to the cluster and start the upgrade: <div style="border: 1px solid #ccc; padding: 5px; margin-top: 10px;"> <pre>kctrl app kick -a sync -n tanzu-sync kctrl app kick -a tap -n tap-install</pre> </div>

Post upgrade checks - Build cluster

Complete the tasks in the following table after you upgrade the Tanzu Application Platform Build cluster.

Item	Description
Check the health of each <code>packageRepository</code> and <code>PackageInstall</code> on the cluster. They must now display the newest version of Tanzu Application Platform.	Run: <div style="border: 1px solid #ccc; padding: 5px; margin-top: 10px;"> <pre>tanzu package repository list -A tanzu package installed list -A</pre> </div>
Check the health of all kapp apps on the cluster	Run: <div style="border: 1px solid #ccc; padding: 5px; margin-top: 10px;"> <pre>kapp list -A</pre> </div>
Check the health of pods on the cluster	Run: <div style="border: 1px solid #ccc; padding: 5px; margin-top: 10px;"> <pre>kubectl get pods -A --field-selector=status.phase!=Running,status.phase!=Succeeded</pre> </div>
Check the health of workloads on the cluster. Consider fixing any workloads that are in a bad state before upgrading.	Run: <div style="border: 1px solid #ccc; padding: 5px; margin-top: 10px;"> <pre>tanzu apps workload list -A</pre> </div>
Check for workload scan results in Tanzu Developer Portal and that you can download the workload SBOM in supported formats	<i>n/a</i>

Run cluster checklists

Pre-upgrade cluster health check - Run cluster

Complete the tasks in the following table before you upgrade the Tanzu Application Platform Run cluster.

Item	Description
Platform health monitoring	Ensure that you have some form of monitoring in place to allow observability into your cluster during an upgrade.

Item	Description
Check the health of each <code>packageRepository</code> and <code>PackageInstall</code> on the cluster	Run: <pre>tanzu package repository list -A tanzu package installed list -A</pre>
Check the health of all kapp apps on the cluster	Run: <pre>kapp list -A</pre>
Check capacity of nodes on the cluster	Run: <pre>kubectl top nodes</pre>
Check the health of pods on the cluster	Run: <pre>kubectl get pods -A --field-selector=status.phase!=Running,status.phase!=Succeeded</pre>

Upgrade considerations for Kubernetes - Run Cluster

The following table lists information about upgrading Kubernetes specific to the Run cluster.

Item	Description
<p>Configure Contour to be a DaemonSet to avoid downtime. If downtime is acceptable set to type deployment.</p> <p>This is only applicable if you are upgrading from Tanzu Application Platform v1.6 or earlier. Contour is a deployment by default as of Tanzu Application Platform v1.7.</p>	<p>For example:</p> <pre>contour: envoy: workload: type: daemonset</pre>

Item	Description
Scale out your <code>AuthServer</code> and use a <code>PodDisruptionBudget</code> to ensure uptime	<p>Consider scaling out your <code>AuthServer</code> to multiple replicas and using a <code>PodDisruptionBudget</code> to ensure uptime.</p> <p>Example <code>AuthServer</code>:</p> <pre>apiVersion: sso.apps.tanzu.vmware.com/v1alpha1 kind: AuthServer ... spec: replicas: 3</pre> <p>Example <code>PodDisruptionBudget</code>:</p> <pre>apiVersion: policy/v1 kind: PodDisruptionBudget metadata: name: auth0-authserver namespace: shared-services spec: minAvailable: 50% selector: matchLabels: app.kubernetes.io/part-of: auth0-authserver</pre>

Item	Description
Scale out Application Configuration Service and use a <code>PodDisruptionBudget</code> to ensure uptime	<p>Add replicas to the <code>PackageInstall</code> of Application Configuration Service and a <code>PodDisruptionBudget</code>.</p> <p>Example <code>PackageInstall</code>:</p> <pre data-bbox="539 394 1260 1193"> apiVersion: packaging.carvel.dev/v1alpha1 kind: PackageInstall metadata: name: acs namespace: tap-install spec: packageRef: refName: application-configuration-service.tanzu. vmware.com versionSelection: constraints: ">=2.1.4" prereleases: {} serviceAccountName: tap-installer-sa values: - secretRef: name: acs-values --- apiVersion: v1 kind: Secret metadata: name: acs-values namespace: tap-install stringData: values.yaml: reconciler: replicas: 3 </pre> <p>Example <code>PodDisruptionBudget</code>:</p> <pre data-bbox="539 1290 1260 1630"> apiVersion: policy/v1 kind: PodDisruptionBudget metadata: name: acs namespace: application-configuration-service spec: minAvailable: 60% selector: matchLabels: app: application-configuration-service </pre>
Consider Bitnami Charts replicas and pod disruption budgets for when running services inside the same cluster	While Bitnami Charts are not intended for production, if you are using them in that manner then consider replicas and pod disruption budgets for each component.

Item	Description
Consider replicas and pod disruption budgets for workloads.	Every workload on Tanzu Application Platform must take replica and disruption budgets into consideration. Consider adding logic to the supply chain to create them
You can use an overlay to create them as part of the SupplyChain by default.	for each component. Example overlay on ootb-templates package install:

```

apiVersion: v1
kind: Secret
metadata:
  name: ootb-templates-overlay-pdb
  namespace: tap-install
  annotations:
    kapp.k14s.io/change-group: "tap-overlays"
type: Opaque
stringData:
  overlay-pdb.yml: |
    #@ load("@ytt:overlay", "overlay")
    #@ load("@ytt:data", "data")
    #@overlay/match by=overlay.subset({"kind":"ClusterConfigTemplate", "metadata": {"name": "config-template"}})
    ---
    spec:
      #@overlay/replace via=lambda left, right: "{}\n{}".format(left, '\n'.join([' {}'.format(x) for x in right.split('\n')]))
      ytt: |
        #@yaml/text-templated-strings
        pdb.yaml: |
          (@ if hasattr(data.values.params, "annotations") and hasattr(data.values.params.annotations, "autoscaling.knative.dev/minScale") and int(getattr(data.values.params.annotations, "autoscaling.knative.dev/minScale")) > 1 : @)
          ---
          apiVersion: policy/v1
          kind: PodDisruptionBudget
          metadata:
            name: (@= data.values.workload.metadata.name @)
          spec:
            maxUnavailable: 1
            selector:
              matchLabels:
                app.kubernetes.io/part-of: (@= data.values.workload.metadata.name @)
                app.kubernetes.io/component: run
            (@ end @)

```

Upgrade considerations for Tanzu Application Platform - Run Cluster

The following table lists information about upgrading Tanzu Application Platform specific to the Run cluster.

Item	Description
Update replicas of the Application Live View connector and add a <code>PodDisruptionBudget</code> to ensure high availability.	<p data-bbox="579 230 1267 286">Update the Run cluster Application Live View connector to have more replicas:</p> <pre data-bbox="579 336 1267 537">appliveview_connector: connector: deployment: enabled: true replicas: 3</pre> <p data-bbox="579 555 1267 611">Add a <code>PodDisruptionBudget</code> for the Application Live View Connector onto the cluster:</p> <pre data-bbox="579 660 1267 996">apiVersion: policy/v1 kind: PodDisruptionBudget metadata: name: alv-connector namespace: app-live-view-connector spec: minAvailable: 60% selector: matchLabels: name: application-live-view-connector</pre>

Item	Description
Set up Artifact Metadata Repository (AMR) Observer on the Run cluster	<p>Set up the AMR Observer on the Run cluster by following the instructions in Multicluster setup for Supply Chain Security Tools - Store. This communicates with the AMR EventHandler on the View cluster. For example:</p> <p>Add the following to the Run cluster <code>tap-values.yaml</code> file:</p> <pre> amr: observer: auth: kubernetes_service_accounts: autoconfigure: false enable: true cloudevent_handler: endpoint: https://amr-cloudevent-handler.DOMAIN MAIN ca_cert_data: -----BEGIN CERT----- </pre> <p>Run the following commands on the View cluster to retrieve the AMR CA certificate and access token. Apply the CA certificate and access token on the Run cluster. The CA Cert goes into the <code>tap-values.yaml</code> file. Add the edit token as a Kubernetes secret on the Run cluster.</p> <pre> CEH_CA_CERT_DATA=\$(kubectl get secret amr-cloudevent-handler-ingress-cert \ -n metadata-store -o json jq -r ".data.\"tls.crt\" base64 -d) CEH_EDIT_TOKEN=\$(kubectl get secrets amr-cloudevent-handler-edit-token \ -n metadata-store -o jsonpath="{.data.token}" base64 -d) </pre>
Review any customizations to the <code>ClusterDelivery</code> or OOTB Templates	<i>n/a</i>
If using GitOps RI, update the <code>version.yaml</code> file with the new Tanzu Application Platform version	You can find the file at the following location: <code>/clusters/CLUSTER-NAME/cluster-config/config/tap-install/.tanzu-managed/version.yaml</code>
If using GitOps RI, run the <code>deploy.sh</code> script to pull in latest External Secret Operator version with Tanzu Application Platform	You can find the script at the following location: <code>/clusters/CLUSTER-NAME/tanzu-sync/scripts/deploy.sh</code>
If using GitOps RI, make adjustments to your <code>tap-values.yaml</code> file if needed, and push the updated <code>version.yaml</code> and <code>tap-values.yaml</code> files to the Git repository.	<p>After pushing the changes to Git, run these commands to sync changes to the cluster and start the upgrade:</p> <pre> kctrl app kick -a sync -n tanzu-sync kctrl app kick -a tap -n tap-install </pre>

Post upgrade checks - Run cluster

Complete the tasks in the following table after you upgrade the Tanzu Application Platform Run cluster.

Item	Description
Check the health of each <code>packageRepository</code> and <code>PackageInstall</code> on the cluster. They must now display the newest version of Tanzu Application Platform.	Run: <pre>tanzu package repository list -A tanzu package installed list -A</pre>
Check the health of all kapp apps on the cluster	Run: <pre>kapp list -A</pre>
Check the health of pods on the cluster	Run: <pre>kubectl get pods -A --field-selector=status.phase!=Running,status.phase!=Succeeded</pre>
Check the health of exposed workload endpoints (knative routes and/or ingresses)	<i>n/a</i>
If applicable, confirm the status of: <ul style="list-style-type: none"> <code>APIDescriptors</code> Service claims: <code>ClassClaim</code> and <code>ResourceClaim</code> 	<i>n/a</i>

Upgrade compatibility and recommendations for Tanzu Application Platform

This topic gives you general information to help you with upgrading Tanzu Application Platform (commonly known as TAP).

Supported upgrade paths

Tanzu Application Platform v1.6 supports upgrading from v1.5.x.

Compatibility

This section describes the compatibility considerations for Tanzu Application Platform v1.6.

Kubernetes compatibility

For supported Kubernetes versions, see [Kubernetes version support for Tanzu Application Platform](#).

You must use a kubectl version that is within one minor version difference of your cluster. For example, a v1.30 client can communicate with v1.29, v1.30, and v1.31 control planes. Using the latest compatible version of kubectl helps avoid unforeseen issues.

Tanzu CLI compatibility

Tanzu Application Platform v1.6 is compatible with Tanzu CLI v1.0.0 and later and Tanzu CLI plugins for Tanzu Application Platform v1.6.x. The Tanzu CLI core v1.2 that is distributed with Tanzu Application Platform is forward and backward compatible with all supported Tanzu Application Platform versions.

There is a group of Tanzu CLI plug-ins that extend the Tanzu CLI core with Tanzu Application Platform specific features. You can install the plug-ins as a group with a single command. Versioned releases of the Tanzu Application Platform specific plug-in group align to each supported Tanzu Application Platform version. This makes it easy to switch between different versions of Tanzu Application Platforms environments.

Recommendations

- **Test the upgrade in a staging or development environment:** Use an environment that mirrors your production setup. This allows you to identify any potential issues or compatibility issues with your workloads before performing the upgrade in production.
- **Consider your tolerance for downtime per environment:** For example, sandbox might not need to scale out replicas of workloads or Tanzu Application Platform components. Use PodDisruptionBudgets only in environments that require high availability, such as production or higher level test environments. Only configure PodDisruptionBudgets if `minScale` or `replicas` are greater than 1.
- **Consider your tolerance for downtime per Tanzu Application Platform profile:** You might have different downtime tolerances for each Tanzu Application Platform profile. Take time to understand these as one size does not fit all.
- **Consider the resource requirements for the upgraded Kubernetes cluster:** This includes CPU, memory, and storage. Ensure that your underlying infrastructure can support the new version and accommodate any changes in resource use from your workloads. You might want to preemptively scale out your nodes instead of letting autoscaling start.
- **Perform health checks on your cluster and workloads before starting the upgrade:** This helps to identify any issues that might impact the upgrade or the stability of your workloads post-upgrade. For more information, see:
 - [View cluster: Pre-Upgrade Cluster Health Check](#)
 - [Build cluster: Pre-Upgrade Cluster Health Check](#)
 - [Run cluster: Pre-Upgrade Cluster Health Check](#)
- **Implement robust monitoring and observability tools:** Use these tools to track the health and performance of your Kubernetes cluster and workloads before, during, and after the upgrade. This helps you to detect any anomalies or performance degradation post-upgrade.
- **Consider the availability needs for workloads:** Tune them with the proper number of replicas and corresponding PodDisruptionBudget. Consider customizing the Tanzu Application Platform `SupplyChain` to stamp out a `PodDisruptionBudget` for workloads if needed. Knative workloads come with their own `PodDisruptionBudget` components. Production workloads running a server workload type must have a replica count of 2 or more to avoid downtime during scheduling of resources. Knative resources must have `minScale` set to 2 or more to avoid downtime.
- **Review compatibility of custom components:** Review any custom components you've added to the cluster for compatibility with Kubernetes.
- **Review the upgrade preparation checklist:** During your upgrade, follow the [Upgrade preparation checklist](#).

Recommendations for apps

- **Ensure that all apps have a readiness or liveness probes:** This helps to avoid disruption during upgrades of Kubernetes and Tanzu Application Platform.

- **Consider using pod affinity rules:** This helps to spread out workloads across nodes and availability zones.
- **Use a pod disruption budget for workloads:** This helps to avoid downtime during upgrades, especially during Kubernetes upgrades.
- **Ensure that your app is protected against failure:** For example, the app uses a 12 factor app design and it can handle graceful shutdown.
- **Ensure that you have copies of business critical apps in a non-production cluster:** This cluster is where the upgrade can be tested before upgrading the cluster that contains the production instance of the app.

Upgrade preparation checklist

Complete the tasks in the following table before you upgrade Tanzu Application Platform.

Component	Description
Upgrade Tanzu CLI	Upgrade to the latest Tanzu CLI and plug-in group by following the instructions in Install the Tanzu CLI .
Upgrade Cluster Essentials	Upgrade Cluster Essentials . If your cluster is maintained by Tanzu Mission Control, you do not need to install or update Cluster Essentials.
Relocate the Tanzu Application Platform package images	Relocate images from tanzu.packages.broadcom.com to your internal registry by following the instructions in Relocate images to a registry .
Relocate the full Tanzu Build Service dependencies	(Optional) Relocate the full Tanzu Build Service dependencies to your internal registry by following the instructions in Install the Tanzu Build Service dependencies . This is not required if you only want the lite dependencies.
Review Kubernetes cluster capacity	Verify that you have enough spare CPU and memory capacity on your Run and Build cluster nodes for the upgrade. You need to schedule capacity for the new pods that are created during an upgrade.
Review any custom overlays	Check if there were any changes between versions for your custom overlays. For example, for the Supply Chain components. To pull a package after upgrading to view its contents and run a comparison, run: <div data-bbox="475 1370 1265 1516" data-label="Code-Block"> <pre>imgpkg pull -b \$(kubectl get \$PACKAGE_NAME < -n tap-install \ -ojson jq -r '.spec.fetch[0].imgpkgBundle.image') \ -o /tmp/\$PACKAGE_NAME && code /tmp/\$PACKAGE_NAME</pre> </div> <p>If you're using an overlay for Tanzu Developer Portal to surface additional Backstage plug-ins, re-run the steps to rebuild your customized Tanzu Developer Portal image by following the instructions in Build your customized Tanzu Developer Portal with Configurator. The re-built image will be referenced in the Tanzu Developer Portal overlay secret. Rebuilding the image is necessary because Tanzu Developer Portal includes a pinned version of Backstage and versions of node.</p> <p>Take into account updates to Backstage versions. Review overlays, especially updates to API versions of Kubernetes resources targeted by each overlay.</p>
Review breaking changes for the Tanzu Application Platform release	See v1.6 Breaking changes in the release notes.

Component	Description
Plan your order of upgrade by cluster and then environment	<p>Recommended order to upgrade clusters:</p> <ol style="list-style-type: none"> 1. View cluster 2. Build clusters 3. Run clusters <p>Upgrade a sandbox or test environment first before upgrading subsequent environments.</p> <p>You cannot jump upgrade versions n+2 until Tanzu Application Platform v1.7.x. For the list of versions you can upgrade to Tanzu Application Platform v1.6, see Supported upgrade paths earlier in this topic.</p>
Check the storage capacity of your container registry, such as Harbor or Artifactory, for sufficient storage	New containers are created during an upgrade. This can increase the need for storage capacity.
If you are using GitOps RI, tag your GitOps repository to maintain a point in time of your Tanzu Application Platform configuration	<p>Example tag commands:</p> <pre>git tag -a v1.x.x git push origin v1.x.x</pre>

View cluster checklists

Pre-upgrade cluster health check - View cluster

Complete the tasks in the following table before you upgrade the Tanzu Application Platform View cluster.

Item	Description
Platform health monitoring	Ensure that you have some form of monitoring in place to allow observability into your cluster during an upgrade.
Check the health of each <code>packageRepository</code> and <code>PackageInstall</code> on the cluster	<p>Run:</p> <pre>tanzu package repository list -A tanzu package installed list -A</pre>
Check the health of all kapp apps on the cluster	<p>Run:</p> <pre>kapp list -A</pre>
Check capacity of nodes on the cluster.	<p>Run:</p> <pre>kubectl top nodes</pre> <p>You might want to preemptively scale out your nodes if they are at a higher capacity instead of letting autoscaling start during an upgrade.</p>
Verify basic Tanzu Application Platform features on the cluster	<ul style="list-style-type: none"> • Test that Tanzu Developer Portal is working. • Test that you can generate code from Accelerators.

Item	Description
Check the health of pods on the cluster	Run: <div style="border: 1px solid #ccc; padding: 5px; margin-top: 10px;"> <pre>kubectl get pods -A --field-selector=status.phase!=Running,status.phase!=Succeeded</pre> </div>

Upgrade considerations for Kubernetes - View Cluster

The following table lists information about upgrading Kubernetes specific to the View cluster.

Item	Description
Scale out Metadata Store pods for high availability	Consider scaling out Metadata Store to have more than one replica to limit downtime. For example: <div style="border: 1px solid #ccc; padding: 5px; margin-top: 10px;"> <pre>metadata_store: app_replicas: 3</pre> </div>
Create a PodDisruptionBudget for the Metadata Store app for high availability	For example: <div style="border: 1px solid #ccc; padding: 5px; margin-top: 10px;"> <pre>apiVersion: policy/v1 kind: PodDisruptionBudget metadata: name: metadata-store-pdb namespace: metadata-store spec: minAvailable: 60% selector: matchLabels: app: metadata-store-app</pre> </div>
Configure Contour to be a DaemonSet to avoid downtime. If downtime is acceptable set to type deployment. This is only applicable if you are upgrading from Tanzu Application Platform v1.6 or earlier. Contour is a deployment by default as of Tanzu Application Platform v1.7.	For example: <div style="border: 1px solid #ccc; padding: 5px; margin-top: 10px;"> <pre>contour: envoy: workload: type: daemonset</pre> </div>

Item	Description
Scale out Tanzu Developer Portal pods for high availability	For example:

```
tap_gui:
  deployment:
    replicas: 3
```

When Tanzu Developer Portal pods are scaled out, there is a known issue with generating Accelerators. You must apply the following overlay to the Tanzu Developer Portal package:

```
apiVersion: v1
kind: Secret
metadata:
  name: tap-gui-session-mgmt-affinity-secret
namespace: tap-install
stringData:
  tap-gui-session-mgmt-affinity.yml: |
    #@ load("@ytt:overlay", "overlay")

    #@overlay/match by=overlay.subset({"kind": "HTTPProxy", "metadata":{"name": "tap-gui"})
    ---
    spec:
      routes:
        #@overlay/match by=overlay.subset({"services": [{"name": "server"}]})
        - services: []
          #@overlay/match missing_ok=True
          loadBalancerPolicy:
            strategy: Cookie
```

And add the following to the `tap-values.yaml` file:

```
package_overlays:
  - name: "tap-gui"
    secrets:
      - name: "tap-gui-session-mgmt-affinity-secret"
```

Item	Description
Create a <code>PodDisruptionBudget</code> for Tanzu Developer Portal for high availability	<p>For example:</p> <pre> apiVersion: policy/v1 kind: PodDisruptionBudget metadata: name: tap-gui-pdb namespace: tap-gui spec: minAvailable: 60% selector: matchLabels: app: backstage </pre>

Upgrade considerations for Tanzu Application Platform - View Cluster

The following table lists information about upgrading Tanzu Application Platform specific to the View cluster.

Item	Description
If upgrading from Tanzu Application Platform v1.6 or earlier, set up Artifact Metadata Repository (AMR)	<p>There are two new endpoints created on the view cluster with AMR. You might need to add them to your allowlist or have custom certificates configured with Tanzu Application Platform v1.7 and later.</p> <ul style="list-style-type: none"> <code>amr-cloudevent-handler.DOMAIN</code> <code>amr-graphql.DOMAIN</code>
What to expect during the upgrade on the View cluster	<ul style="list-style-type: none"> Tanzu Developer Portal might show a gray or missing status on the Supply Chain page. You might have issues with viewing pages. Consider doing a hard fresh for browsers.
If using GitOps RI, update the <code>version.yaml</code> file with the new Tanzu Application Platform version	<p>You can find the file at the following location:</p> <pre> /clusters/CLUSTER-NAME/cluster-config/config/tap-install/.tanzu-managed/version.yaml </pre>
If using GitOps RI, run the <code>deploy.sh</code> script to pull in latest External Secret Operator version with Tanzu Application Platform	<p>You can find the script at the following location:</p> <pre> /clusters/CLUSTER-NAME/tanzu-sync/scripts/deploy.sh </pre>
If using GitOps RI, make adjustments to your <code>tap-values.yaml</code> file if needed, and push the updated <code>version.yaml</code> and <code>tap-values.yaml</code> files to the Git repository	<p>After pushing the changes to Git, run these commands to sync the changes to the cluster and start the upgrade:</p> <pre> kctrl app kick -a sync -n tanzu-sync kctrl app kick -a tap -n tap-install </pre>

Post upgrade checks - View cluster

Complete the tasks in the following table after you upgrade the Tanzu Application Platform View cluster.

Item	Description
<p>Check the health of each <code>packageRepository</code> and <code>PackageInstall</code> on the cluster.</p> <p>They must now display the newest version of Tanzu Application Platform.</p>	<p>Run:</p> <pre>tanzu package repository list -A tanzu package installed list -A</pre>
<p>Check the health of all kapp apps on the cluster</p>	<p>Run:</p> <pre>kapp list -A</pre>
<p>Check the health of pods on the cluster</p>	<p>Run:</p> <pre>kubectl get pods -A --field-selector=status.phase!=Running,status.phase!=Succeeded</pre>
<p>Verify that Tanzu Developer Portal starts</p>	<p>Log into Tanzu Developer Portal and verify that the basic functionality still works as expected.</p>

Build cluster checklists

Pre-upgrade cluster health check - Build cluster

Complete the tasks in the following table before you upgrade the Tanzu Application Platform Build cluster.

Item	Description
<p>Platform health monitoring</p>	<p>Ensure that you have some form of monitoring in place to allow observability into your cluster during an upgrade.</p>
<p>Check the health of each <code>packageRepository</code> and <code>PackageInstall</code> on the cluster.</p> <p>Fix any broken packages or repositories.</p>	<p>Run:</p> <pre>tanzu package repository list -A tanzu package installed list -A</pre>
<p>Check the health of all kapp apps on the cluster.</p> <p>Fix any kapp apps that are in a bad state before upgrading.</p>	<p>Run:</p> <pre>kapp list -A</pre>
<p>Check capacity of nodes on the cluster.</p> <p>You might want to preemptively scale out your nodes if they are at a higher capacity instead of letting autoscaling start during an upgrade.</p>	<p>Run:</p> <pre>kubectl top nodes</pre>
<p>Check the health of workloads on the cluster.</p> <p>Consider fixing any workloads that are in a bad state before upgrading.</p>	<p>Run:</p> <pre>tanzu apps workload list -A</pre>
<p>Check the health of pods on the cluster.</p> <p>Consider fixing any pods that are in a bad state before upgrading.</p>	<p>Run:</p> <pre>kubectl get pods -A --field-selector=status.phase!=Running,status.phase!=Succeeded</pre>

Upgrade considerations for Kubernetes - Build Cluster

The following table lists information about upgrading Kubernetes specific to the Build cluster.

Item	Description
Image cache on nodes will be reset	As new nodes are spun up on a cluster, it might take longer to pull images as the cache has not been filled. This is only noticeable on the first pull of images.
Consider pre-scaling the number of nodes	Upgrading Kubernetes can trigger new pods, which take resources on the node. Node autoscaling will start up, which can take time and impact the window of the upgrade. Consider scaling capacity before an upgrade.
Expect to lose logs on completed pods for workloads	Expect to lose pod logs for the tests, builds and scans for a workload. Tanzu Developer Portal will continue to show the build history, but logs will be missing.

Upgrade considerations for Tanzu Application Platform - Build Cluster

The following table lists information about upgrading Tanzu Application Platform specific to the Build cluster.

Item	Description
Contour package is removed as of Tanzu Application Platform v1.7	The contour package is deleted from the Build Cluster as of Tanzu Application Platform v1.7.
New versions of Buildpacks from the Tanzu Application Platform upgrade triggers new Tanzu Build Service builds for all workloads	When upgrading Tanzu Application Platform, new buildpacks will be introduced. This triggers new Tanzu Build Service builds. Expect workloads affected by updated buildpacks to rebuild. Node autoscaling will happen. Your container image registry might have bursts of traffic and activity with new builds. Plan accordingly.
Set an overlay for resource limits on Kpack to optimize resources used by builds	When new buildpacks are applied during an upgrade, expect all workloads to trigger a new build. This might flood your cluster with build requests. Ensure that you have scaled out enough nodes and the appropriate processors to avoid being starved for CPU or memory.

Item	Description
If upgrading from TAP 1.6 or earlier, set up Artifact Metadata Repository (AMR) Observer on the Build cluster	Set up the AMR Observer on the Build cluster by following the instructions in Multicluster setup for Supply Chain Security Tools - Store . This communicates with the AMR EventHandler on the View cluster. For example:

Add the following to the Build cluster `tap-values.yaml` file:

```

amr:
  observer:
    auth:
      kubernetes_service_accounts:
        autoconfigure: false
        enable: true
      cloudevent_handler:
        endpoint: https://amr-cloudevent-handler.DOMA
IN
      ca_cert_data: |
        -----BEGIN CERT-----

```

Run the following commands on the View cluster to retrieve the AMR CA certificate and access token. Apply the CA certificate and access token on the Build cluster. The CA Cert goes into the `tap-values.yaml` file. Add the edit token as a Kubernetes secret on the Build cluster.

```

CEH_CA_CERT_DATA=$(kubectl get secret amr-cloudevent-
handler-ingress-cert \
  -n metadata-store -o json | jq -r ".data.\"tls.crt\"
\" | base64 -d)

CEH_EDIT_TOKEN=$(kubectl get secrets amr-cloudevent-h
andler-edit-token \
  -n metadata-store -o jsonpath="{.data.token}" | bas
e64 -d)

```

Example external secret setup:

```

---
apiVersion: external-secrets.io/v1beta1
kind: ExternalSecret
metadata:
  name: amr-observer-edit-token
  namespace: tap-install
spec:
  secretStoreRef:
    name: tap-install-secrets
    kind: SecretStore
  refreshInterval: "1m"
  target:
    template:
      data:
        token: "{{ .amr_token }}"
  data:
    - secretKey: amr_token
      remoteRef:
        key: PATH-TO-EXTERNAL-SECRET-STORE
        property: amr_token
---
apiVersion: secretgen.carvel.dev/v1alpha1

```

Item	Description
	<pre> kind: SecretExport metadata: name: amr-observer-edit-token namespace: tap-install spec: toNamespaces: - amr-observer-system --- apiVersion: secretgen.carvel.dev/v1alpha1 kind: SecretImport metadata: name: amr-observer-edit-token namespace: amr-observer-system spec: fromNamespace: tap-install </pre>

Update `SupplyChain` customizations for any changes

`ClusterTasks` were removed as of Tanzu Application Platform v1.7. For example, if you wrote your own `ClusterTemplate` that uses the `git-writer` task, you must reference it as follows:

```

taskRef:
  resolver: cluster
  params:
    - name: kind
      value: task
    - name: namespace
      value: tap-tasks
    - name: name
      value: git-writer

```

If you've customized the `config-writer-template` in the `ClusterTemplate`, Ensure that the `configPath` property refers to `.spec.params` instead of `.spec.input.params`.

Item	Description
<p>Upgrading to Supply Chain Security Tools (SCST) - Scan 2.0 (SCST - Scan 1.0 is deprecated as of Tanzu Application Platform v1.10).</p>	<p>Upgrading from SCST - Scan 1.0 to SCST - Scan 2.0 in Tanzu Application Platform requires you to coordinate multiple steps across the Build and View clusters. There will be new token or certificate values to pull from the View cluster and configuration on the supply chain to move to Scan 2.0.</p>
<p>Trivy is the new default scanner.</p>	<p>The scanning section on the Build cluster now needs the CA and Auth Token from the View cluster for Metadata store. If using GitOps RI, consider storing these in an external secret for sensitive values.</p>
	<pre data-bbox="563 510 1268 790"> scanning: metadataStore: exports: ca: pem: CONTENTS-OF-MDS-CA-CERT auth: token: CONTENTS-OF-MDS-AUTH-TOKEN </pre>
	<p>Where <code>CONTENTS-OF-MDS-CA-CERT</code> is the contents of <code>\$MDS_CA_CERT</code> and <code>CONTENTS-OF-MDS-AUTH-TOKEN</code> is the content of <code>\$MDS_AUTH_TOKEN</code>.</p>
	<p>You can remove the Grype section from your <code>tap-values.yaml</code> file for the Build cluster. Trivy is now the default scanner for Tanzu Application Platform.</p>
	<p>Ensure that you delete any configured secrets in the <code>metadata-store-secrets</code> namespace on the build cluster. These are configured automatically, so removing them helps to avoid issues like kapp ownership conflicts.</p>
	<p>Configure Trivy Scanner in your <code>tap-values.yaml</code> file on the Build cluster.</p>
	<pre data-bbox="563 1227 1268 1429"> ootb_supply_chain_testing_scanning: image_scanner_template_name: image-vulnerability-scan-trivy image_scanning_cli: image: PATH-TO-RELOCATED-IMAGE </pre>
	<p>After applying the changes to the Build cluster and the reconciliation is successful, run the Namespace Provisioner on the Build cluster to reconcile any changes to each namespace.</p>
	<p>Note: If you are moving away from Grype, set the following flag to deactivate Grype for all namespaces:</p>
	<pre data-bbox="563 1664 1268 1809"> namespace_provisioner: default_parameters: skip_grype: true </pre>
	<p>Note: If you use or you switch between different scanners in Tanzu Application Platform v1.9 and earlier, Metadata Store will show duplicate results in the Tanzu Developer Portal Security Analysis UI.</p>
<p>If using GitOps RI, update the <code>version.yaml</code> file with the new Tanzu Application Platform version</p>	<p>You can find the file at the following location: <code>/clusters/CLUSTER-NAME/cluster-config/config/tap-install/.tanzu-managed/version.yaml</code></p>

Item	Description
If using GitOps RI, run the <code>deploy.sh</code> script to pull in latest External Secret Operator version with Tanzu Application Platform	You can find the script at the following location: <code>/clusters/CLUSTER-NAME/tanzu-sync/scripts/deploy.sh</code>
If using GitOps RI, make adjustments to your <code>tap-values.yaml</code> file if needed, and push the updated <code>version.yaml</code> and <code>tap-values.yaml</code> files to the Git repository	After pushing the changes to Git, run the these commands to sync changes to the cluster and start the upgrade: <div style="border: 1px solid #ccc; padding: 5px; margin-top: 10px;"> <pre>kctrl app kick -a sync -n tanzu-sync kctrl app kick -a tap -n tap-install</pre> </div>

Post upgrade checks - Build cluster

Complete the tasks in the following table after you upgrade the Tanzu Application Platform Build cluster.

Item	Description
Check the health of each <code>packageRepository</code> and <code>PackageInstall</code> on the cluster. They must now display the newest version of Tanzu Application Platform.	Run: <div style="border: 1px solid #ccc; padding: 5px; margin-top: 10px;"> <pre>tanzu package repository list -A tanzu package installed list -A</pre> </div>
Check the health of all kapp apps on the cluster	Run: <div style="border: 1px solid #ccc; padding: 5px; margin-top: 10px;"> <pre>kapp list -A</pre> </div>
Check the health of pods on the cluster	Run: <div style="border: 1px solid #ccc; padding: 5px; margin-top: 10px;"> <pre>kubectl get pods -A --field-selector=status.phase!=Running,status.phase!=Succeeded</pre> </div>
Check the health of workloads on the cluster. Consider fixing any workloads that are in a bad state before upgrading.	Run: <div style="border: 1px solid #ccc; padding: 5px; margin-top: 10px;"> <pre>tanzu apps workload list -A</pre> </div>
Check for workload scan results in Tanzu Developer Portal and that you can download the workload SBOM in supported formats	<i>n/a</i>

Run cluster checklists

Pre-upgrade cluster health check - Run cluster

Complete the tasks in the following table before you upgrade the Tanzu Application Platform Run cluster.

Item	Description
Platform health monitoring	Ensure that you have some form of monitoring in place to allow observability into your cluster during an upgrade.

Item	Description
Check the health of each <code>packageRepository</code> and <code>PackageInstall</code> on the cluster	Run: <pre>tanzu package repository list -A tanzu package installed list -A</pre>
Check the health of all kapp apps on the cluster	Run: <pre>kapp list -A</pre>
Check capacity of nodes on the cluster	Run: <pre>kubectl top nodes</pre>
Check the health of pods on the cluster	Run: <pre>kubectl get pods -A --field-selector=status.phase!=Running,status.phase!=Succeeded</pre>

Upgrade considerations for Kubernetes - Run Cluster

The following table lists information about upgrading Kubernetes specific to the Run cluster.

Item	Description
<p>Configure Contour to be a DaemonSet to avoid downtime. If downtime is acceptable set to type deployment.</p> <p>This is only applicable if you are upgrading from Tanzu Application Platform v1.6 or earlier. Contour is a deployment by default as of Tanzu Application Platform v1.7.</p>	<p>For example:</p> <pre>contour: envoy: workload: type: daemonset</pre>

Item	Description
Scale out your <code>AuthServer</code> and use a <code>PodDisruptionBudget</code> to ensure uptime	<p>Consider scaling out your <code>AuthServer</code> to multiple replicas and using a <code>PodDisruptionBudget</code> to ensure uptime.</p> <p>Example <code>AuthServer</code>:</p> <pre data-bbox="536 394 1262 595">apiVersion: sso.apps.tanzu.vmware.com/v1alpha1 kind: AuthServer ... spec: replicas: 3</pre> <p>Example <code>PodDisruptionBudget</code>:</p> <pre data-bbox="536 685 1262 1032">apiVersion: policy/v1 kind: PodDisruptionBudget metadata: name: auth0-authserver namespace: shared-services spec: minAvailable: 50% selector: matchLabels: app.kubernetes.io/part-of: auth0-authserver</pre>

Item	Description
Scale out Application Configuration Service and use a <code>PodDisruptionBudget</code> to ensure uptime	<p data-bbox="531 230 1268 286">Add replicas to the <code>PackageInstall</code> of Application Configuration Service and a <code>PodDisruptionBudget</code>.</p> <p data-bbox="531 320 774 342">Example <code>PackageInstall</code>:</p> <pre data-bbox="531 394 1268 1193"> apiVersion: packaging.carvel.dev/v1alpha1 kind: PackageInstall metadata: name: acs namespace: tap-install spec: packageRef: refName: application-configuration-service.tanzu. vmware.com versionSelection: constraints: ">=2.1.4" prereleases: {} serviceAccountName: tap-installer-sa values: - secretRef: name: acs-values --- apiVersion: v1 kind: Secret metadata: name: acs-values namespace: tap-install stringData: values.yaml: reconciler: replicas: 3 </pre> <p data-bbox="531 1216 829 1238">Example <code>PodDisruptionBudget</code>:</p> <pre data-bbox="531 1290 1268 1630"> apiVersion: policy/v1 kind: PodDisruptionBudget metadata: name: acs namespace: application-configuration-service spec: minAvailable: 60% selector: matchLabels: app: application-configuration-service </pre>
Consider Bitnami Charts replicas and pod disruption budgets for when running services inside the same cluster	While Bitnami Charts are not intended for production, if you are using them in that manner then consider replicas and pod disruption budgets for each component.

Item	Description
Consider replicas and pod disruption budgets for workloads.	Every workload on Tanzu Application Platform must take replica and disruption budgets into consideration. Consider adding logic to the supply chain to create them
You can use an overlay to create them as part of the SupplyChain by default.	for each component. Example overlay on ootb-templates package install:

```

apiVersion: v1
kind: Secret
metadata:
  name: ootb-templates-overlay-pdb
  namespace: tap-install
  annotations:
    kapp.k14s.io/change-group: "tap-overlays"
type: Opaque
stringData:
  overlay-pdb.yml: |
    #@ load("@ytt:overlay", "overlay")
    #@ load("@ytt:data", "data")
    #@overlay/match by=overlay.subset({"kind":"ClusterConfigTemplate", "metadata": {"name": "config-template"}})
    ---
    spec:
      #@overlay/replace via=lambda left, right: "{}\n{}".format(left, '\n'.join([' {}'.format(x) for x in right.split('\n')]))
      ytt: |
        #@yaml/text-templated-strings
        pdb.yaml: |
          (@ if hasattr(data.values.params, "annotations") and hasattr(data.values.params.annotations, "autoscaling.knative.dev/minScale") and int(getattr(data.values.params.annotations, "autoscaling.knative.dev/minScale")) > 1 : @)
          ---
          apiVersion: policy/v1
          kind: PodDisruptionBudget
          metadata:
            name: (@= data.values.workload.metadata.name @)
          spec:
            maxUnavailable: 1
            selector:
              matchLabels:
                app.kubernetes.io/part-of: (@= data.values.workload.metadata.name @)
                app.kubernetes.io/component: run
            (@ end @)

```

Upgrade considerations for Tanzu Application Platform - Run Cluster

The following table lists information about upgrading Tanzu Application Platform specific to the Run cluster.

Item	Description
Update replicas of the Application Live View connector and add a <code>PodDisruptionBudget</code> to ensure high availability.	<p data-bbox="579 230 1267 286">Update the Run cluster Application Live View connector to have more replicas:</p> <pre data-bbox="579 331 1267 539">appliveview_connector: connector: deployment: enabled: true replicas: 3</pre> <p data-bbox="579 555 1267 611">Add a <code>PodDisruptionBudget</code> for the Application Live View Connector onto the cluster:</p> <pre data-bbox="579 656 1267 1003">apiVersion: policy/v1 kind: PodDisruptionBudget metadata: name: alv-connector namespace: app-live-view-connector spec: minAvailable: 60% selector: matchLabels: name: application-live-view-connector</pre>

Item	Description
Set up Artifact Metadata Repository (AMR) Observer on the Run cluster	<p>Set up the AMR Observer on the Run cluster by following the instructions in Multicluster setup for Supply Chain Security Tools - Store. This communicates with the AMR EventHandler on the View cluster. For example:</p> <p>Add the following to the Run cluster <code>tap-values.yaml</code> file:</p> <pre> amr: observer: auth: kubernetes_service_accounts: autoconfigure: false enable: true cloudevent_handler: endpoint: https://amr-cloudevent-handler.DOMAIN MAIN ca_cert_data: -----BEGIN CERT----- </pre> <p>Run the following commands on the View cluster to retrieve the AMR CA certificate and access token. Apply the CA certificate and access token on the Run cluster. The CA Cert goes into the <code>tap-values.yaml</code> file. Add the edit token as a Kubernetes secret on the Run cluster.</p> <pre> CEH_CA_CERT_DATA=\$(kubectl get secret amr-cloudevent-handler-ingress-cert \ -n metadata-store -o json jq -r ".data.\"tls.crt\"" base64 -d) CEH_EDIT_TOKEN=\$(kubectl get secrets amr-cloudevent-handler-edit-token \ -n metadata-store -o jsonpath="{.data.token}" base64 -d) </pre>
Review any customizations to the <code>ClusterDelivery</code> or OOTB Templates	<i>n/a</i>
If using GitOps RI, update the <code>version.yaml</code> file with the new Tanzu Application Platform version	You can find the file at the following location: <code>/clusters/CLUSTER-NAME/cluster-config/config/tap-install/.tanzu-managed/version.yaml</code>
If using GitOps RI, run the <code>deploy.sh</code> script to pull in latest External Secret Operator version with Tanzu Application Platform	You can find the script at the following location: <code>/clusters/CLUSTER-NAME/tanzu-sync/scripts/deploy.sh</code>
If using GitOps RI, make adjustments to your <code>tap-values.yaml</code> file if needed, and push the updated <code>version.yaml</code> and <code>tap-values.yaml</code> files to the Git repository.	<p>After pushing the changes to Git, run these commands to sync changes to the cluster and start the upgrade:</p> <pre> kctrl app kick -a sync -n tanzu-sync kctrl app kick -a tap -n tap-install </pre>

Post upgrade checks - Run cluster

Complete the tasks in the following table after you upgrade the Tanzu Application Platform Run cluster.

Item	Description
Check the health of each <code>packageRepository</code> and <code>PackageInstall</code> on the cluster.	Run:
They must now display the newest version of Tanzu Application Platform.	<pre>tanzu package repository list -A tanzu package installed list -A</pre>
Check the health of all kapp apps on the cluster	Run:
	<pre>kapp list -A</pre>
Check the health of pods on the cluster	Run:
	<pre>kubectl get pods -A --field-selector=status.phase!=Running,status.phase!=Succeeded</pre>
Check the health of exposed workload endpoints (knative routes and/or ingresses)	<i>n/a</i>
If applicable, confirm the status of:	<i>n/a</i>
<ul style="list-style-type: none"> • <code>APIDescriptors</code> • Service claims: <code>ClassClaim</code> and <code>ResourceClaim</code> 	

Upgrade Tanzu Application Platform

This topic tells you how to upgrade your Tanzu Application Platform (commonly known as TAP) installation.

You can perform a fresh install of Tanzu Application Platform by following the instructions in [Installing Tanzu Application Platform](#).

Prerequisites

Before you upgrade Tanzu Application Platform:

- Verify that you meet all the [prerequisites and resource requirements](#) of the target Tanzu Application Platform version. If the target Tanzu Application Platform version does not support your existing Kubernetes version, VMware recommends upgrading to a supported version before proceeding with the upgrade.
- Review the [Upgrade compatibility and recommendations](#).
- For information about Tanzu Developer Portal (formerly named Tanzu Application Platform GUI) upgrade considerations, see [Tanzu Developer Portal Considerations](#).
- Ensure that Tanzu CLI is updated to the version recommended by the target Tanzu Application Platform version. For information about installing or updating the Tanzu CLI and plug-ins, see [Install or update the Tanzu CLI and plug-ins](#).
- Verify all packages are reconciled by running `tanzu package installed list -A`.
- To avoid the temporary warning state that is described in [Update the new package repository](#), upgrade to Cluster Essentials v1.6. For more information about the upgrade procedures, see the [Cluster Essentials documentation](#).

Update the package repository

Follow these steps to update to the new package repository:

1. Relocate the latest version of Tanzu Application Platform images by following step 1 through step 6 in [Relocate images to a registry](#).



Important

Make sure to update the `TAP_VERSION` to the target version of Tanzu Application Platform you are migrating to. For example, `1.6.13`.

2. Add the target version of the Tanzu Application Platform package repository by running:

```
tanzu package repository update tanzu-tap-repository \
--url ${INSTALL_REGISTRY_HOSTNAME}/TARGET-REPOSITORY/tap-packages:${TAP_VERSION} \
--namespace tap-install
```

Expect to see the installed Tanzu Application Platform packages in a temporary `Reconcile Failed` state, following a `Package not found` warning. These warnings will disappear after you upgrade the installed Tanzu Application Platform packages.

3. Verify you have added the new package repository by running:

```
tanzu package repository get TAP-REPO-NAME --namespace tap-install
```

Where `TAP-REPO-NAME` is the package repository name. It must match with either `NEW-TANZU-TAP-REPOSITORY` or `tanzu-tap-repository` in the previous step.

Perform the upgrade of Tanzu Application Platform

The following sections describe how to upgrade in different scenarios.

Upgrade instructions for Profile-based installation

The following changes affect the upgrade procedures:

- **Keyless support deactivated by default**

In Tanzu Application Platform v1.5.0, keyless support is deactivated by default. For more information, see [Install Supply Chain Security Tools - Policy Controller](#).

To support the keyless authorities in `ClusterImagePolicy`, Policy Controller no longer initializes TUF by default. To continue using keyless authorities, you must set the `policy.tuf_enabled` field to `true` in the `tap-values.yaml` file during the upgrade process.

By default, the public official Sigstore “The Update Framework (TUF) server” is used. You can use an alternative Sigstore Stack by setting `policy.tuf_mirror` and `policy.tuf_root`.

- **Image Policy Webhook no longer in use**

Tanzu Application Platform v1.5.0 removes Image Policy Webhook. If you use Image Policy Webhook in the previous version of Tanzu Application Platform, you must migrate the `ClusterImagePolicy` resource from Image Policy Webhook to Policy Controller. For more information, see [Migration From Supply Chain Security Tools - Sign](#).

- **CVE results require a read-write service account**

Tanzu Application Platform v1.3.0 uses a read-only service account. In Tanzu Application Platform v1.4.0 and later, enabling CVE results for the Supply Chain Choreographer and

Security Analysis GUI plug-ins requires a read-write service account. For more information, see [Enable CVE scan results](#).

If you installed Tanzu Application Platform by using a profile, you can perform the upgrade by running the following command in the directory where the `tap-values.yaml` file resides:

```
tanzu package installed update tap -p tap.tanzu.vmware.com -v ${TAP_VERSION} --values
-file tap-values.yaml -n tap-install
```

Upgrade the full dependencies package

If you installed the [full dependencies package](#), you can upgrade the package by following these steps:

1. (Optional) If you have an existing installation of the full dependencies from a version earlier than TAP v1.6.1, you must uninstall the full dependencies package and remove the package repository. Subsequent upgrades will not require a removal:

- o Uninstall the package by running:

```
tanzu package installed delete full-tbs-deps -n tap-install
```

- o Remove the package repository by running:

```
tanzu package repository delete tbs-full-deps-repository -n tap-install
```

2. After upgrading Tanzu Application Platform, retrieve the latest version of the Tanzu Application Platform package by running:

```
tanzu package available list tap.tanzu.vmware.com --namespace tap-install
```

3. Relocate the Tanzu Build Service `full` dependencies package repository by running:

```
imgpkg copy -b tanzu.packages.broadcom.com/tanzu-application-platform/full-deps
-package-repo:VERSION \
--to-repo ${INSTALL_REGISTRY_HOSTNAME}/${INSTALL_REPO}/full-deps-package-repo
```

Where `VERSION` is the version of the Tanzu Application Platform package you retrieved in the previous step.

4. Update the Tanzu Build Service `full` dependencies package repository by running:

```
tanzu package repository add full-deps-package-repo \
--url ${INSTALL_REGISTRY_HOSTNAME}/${INSTALL_REPO}/full-deps-package-repo:VER
SION \
--namespace tap-install
```

5. Update the `full` dependencies package by running:

```
tanzu package install full-deps -p full-deps.buildservice.tanzu.vmware.com -v
"> 0.0.0" -n tap-install --values-file PATH-TO-TAP-VALUES-FILE
```



Important

The values file is only required for this command if you install this package for the first time or if the values have changed.

Multicluster upgrade order

Upgrading a [multicluster deployment](#) requires updating multiple clusters with different profiles. If upgrades are not performed at the exact same time, different clusters have different versions of profiles installed temporarily. This might cause a temporary API mismatch that leads to errors. Those errors eventually disappear when the versions are consistent across all clusters.

To reduce the likelihood of temporary failures, follow these steps to upgrade your multicluster deployment:

1. Upgrade the view-profile cluster.
2. Upgrade the remaining clusters in any order.

Upgrade instructions for component-specific installation

For information about upgrading Tanzu Developer Portal, see [Upgrade Tanzu Developer Portal](#). For information about upgrading Supply Chain Security Tools - Scan, see [Upgrade Supply Chain Security Tools - Scan](#).

Verify the upgrade

Verify the versions of packages after the upgrade by running:

```
tanzu package installed list --namespace tap-install
```

Your output is similar, but probably not identical, to the following example output:

```
- Retrieving installed packages...
NAME                                PACKAGE-NAME
PACKAGE-VERSION  STATUS
accelerator                                accelerator.apps.tanzu.vmware.com
1.3.0              Reconcile succeeded
api-auto-registration                       apis.apps.tanzu.vmware.com
0.1.1              Reconcile succeeded
api-portal                                api-portal.tanzu.vmware.com
1.2.2              Reconcile succeeded
appliveview                                backend.appliveview.tanzu.vmware.com
1.3.0              Reconcile succeeded
appliveview-connector                      connector.appliveview.tanzu.vmware.com
1.3.0              Reconcile succeeded
appliveview-conventions                   conventions.appliveview.tanzu.vmware.com
1.3.0              Reconcile succeeded
appsso                                    sso.apps.tanzu.vmware.com
2.0.0              Reconcile succeeded
buildservice                              buildservice.tanzu.vmware.com
1.7.1              Reconcile succeeded
cartographer                              cartographer.tanzu.vmware.com
0.5.3              Reconcile succeeded
cert-manager                              cert-manager.tanzu.vmware.com
1.7.2+tap.1       Reconcile succeeded
cnrs                                       cnrs.tanzu.vmware.com
2.0.1              Reconcile succeeded
contour                                    contour.tanzu.vmware.com
1.22.0+tap.3     Reconcile succeeded
conventions-controller                    controller.conventions.apps.tanzu.vmware.com
0.7.1              Reconcile succeeded
developer-conventions                     developer-conventions.tanzu.vmware.com
0.8.0              Reconcile succeeded
eventing                                   eventing.tanzu.vmware.com
2.0.1              Reconcile succeeded
fluxcd-source-controller                  fluxcd.source.controller.tanzu.vmware.com
0.27.0+tap.1     Reconcile succeeded
grype                                     grype.scanning.apps.tanzu.vmware.com
1.3.0              Reconcile succeeded
```

image-policy-webhook	image-policy-webhook.signing.apps.tanzu.vmware.com
1.1.7	Reconcile succeeded
learningcenter	learningcenter.tanzu.vmware.com
0.2.3	Reconcile succeeded
learningcenter-workshops	workshops.learningcenter.tanzu.vmware.com
0.2.2	Reconcile succeeded
metadata-store	metadata-store.apps.tanzu.vmware.com
1.3.3	Reconcile succeeded
ootb-delivery-basic	ootb-delivery-basic.tanzu.vmware.com
0.10.2	Reconcile succeeded
ootb-supply-chain-testing-scanning	ootb-supply-chain-testing-scanning.tanzu.vmware.com
0.10.2	Reconcile succeeded
ootb-templates	ootb-templates.tanzu.vmware.com
0.10.2	Reconcile succeeded
policy-controller	policy.apps.tanzu.vmware.com
1.1.1	Reconcile succeeded
scanning	scanning.apps.tanzu.vmware.com
1.3.0	Reconcile succeeded
service-bindings	service-bindings.labs.vmware.com
0.8.0	Reconcile succeeded
services-toolkit	services-toolkit.tanzu.vmware.com
0.8.0	Reconcile succeeded
source-controller	controller.source.apps.tanzu.vmware.com
0.5.0	Reconcile succeeded
spring-boot-conventions	spring-boot-conventions.tanzu.vmware.com
0.5.0	Reconcile succeeded
tap	tap.tanzu.vmware.com
1.3.0	Reconcile succeeded
tap-auth	tap-auth.tanzu.vmware.com
1.1.0	Reconcile succeeded
tap-gui	tap-gui.tanzu.vmware.com
1.3.0	Reconcile succeeded
tap-telemetry	tap-telemetry.tanzu.vmware.com
0.3.1	Reconcile succeeded
tekton-pipelines	tekton.tanzu.vmware.com
0.39.0+tap.2	Reconcile succeeded

Upgrade Tanzu Application Platform by using GitOps

This document tells you how to upgrade your Tanzu Application Platform installation (commonly known as TAP) by using GitOps.



Caution

Tanzu Application Platform (GitOps) is currently in beta and is intended for evaluation and test purposes only. Do not use in a production environment.

You can perform a fresh install of Tanzu Application Platform by following the instructions in [Installing Tanzu Application Platform](#).

Prerequisites

Before you upgrade your Tanzu Application Platform:

- Verify that you meet all the [prerequisites](#) of the target Tanzu Application Platform version. If the target Tanzu Application Platform version does not support your existing Kubernetes version, VMware recommends upgrading to a supported version before proceeding with the upgrade.
- Review the [Upgrade compatibility and recommendations](#).

- For information about installing your Tanzu Application Platform, see [Install Tanzu Application Platform through GitOps with Secrets OPerationS \(SOPS\)](#) or [Install Tanzu Application Platform through GitOps with External Secrets Operator \(ESO\)](#).
- For information about Tanzu Developer Portal (formerly named Tanzu Application Platform GUI) considerations, see [Tanzu Developer Portal Considerations](#).
- Verify all packages are reconciled by running `kubectl get packageinstall --namespace tap-install`.

Relocate Tanzu Application Platform images to a registry

Before installation, you must relocate the Tanzu Application Platform images from `tanzu.packages.broadcom.com` to your own container image registry.

The supported registries are Harbor, Azure Container Registry, Google Container Registry, and Quay.io. See the following documentation to learn how to set up your container image registry:

- [Harbor documentation](#)
- [Google Container Registry documentation](#)
- [Quay.io documentation](#)

To relocate images from `tanzu.packages.broadcom.com` to your registry:

1. Set up environment variables for installation use by running:

```
export IMGPKG_REGISTRY_HOSTNAME_0=tanzu.packages.broadcom.com
export IMGPKG_REGISTRY_USERNAME_0=MY-BROADCOM-SUPPORT-USERNAME
export IMGPKG_REGISTRY_PASSWORD_0=${MY_BROADCOM_SUPPORT_ACCESS_TOKEN}
export IMGPKG_REGISTRY_HOSTNAME_1=MY-REGISTRY
export IMGPKG_REGISTRY_USERNAME_1=MY-REGISTRY-USER
export IMGPKG_REGISTRY_PASSWORD_1=MY-REGISTRY-PASSWORD
export INSTALL_REGISTRY_USERNAME=MY-REGISTRY-USER
export INSTALL_REGISTRY_PASSWORD=MY-REGISTRY-PASSWORD
export INSTALL_REGISTRY_HOSTNAME=MY-REGISTRY
export TAP_VERSION=VERSION-NUMBER
export INSTALL_REPO=TARGET-REPOSITORY
```

Where:

- `MY-BROADCOM-SUPPORT-USERNAME` is the user with access to the images in `tanzu.packages.broadcom.com`.
- `MY-REGISTRY` is your own container registry.
- `MY-REGISTRY-USER` is the user with write access to `MY-REGISTRY`.
- `MY-REGISTRY-PASSWORD` is the password for `MY-REGISTRY-USER`.
- `VERSION-NUMBER` is your Tanzu Application Platform version. For example, `1.6.13`.
- `TARGET-REPOSITORY` is your target repository, a folder or repository on `MY-REGISTRY` that serves as the location for the installation files of Tanzu Application Platform.

VMware recommends using a JSON key file to authenticate with Google Container Registry. In this case, the value of `INSTALL_REGISTRY_USERNAME` is `_json_key` and the value of `INSTALL_REGISTRY_PASSWORD` is the content of the JSON key file. For more information about how to generate the JSON key file, see [Google Container Registry documentation](#).

2. Install the Carvel tool `imgpkg` CLI.

To query for the available versions of Tanzu Application Platform on `tanzu.packages.broadcom.com`, run:

```
imgpkg tag list -i tanzu.packages.broadcom.com/tanzu-application-platform/tap-p
ackages | sort -V
```

3. Relocate the images with the `imgpkg` CLI by running:

```
imgpkg copy -b tanzu.packages.broadcom.com/tanzu-application-platform/tap-packa
ges:${TAP_VERSION} --to-repo ${INSTALL_REGISTRY_HOSTNAME}/${INSTALL_REPO}/tap-p
ackages
```

Upgrade to a patch version



Caution

Tanzu Application Platform (GitOps) does not provide a separate artifact for each patch version within a minor line. For example, Tanzu Application Platform v1.6.x only contains the v1.6.1 GitOps artifact.

Follow these steps to upgrade to the latest patch:

1. [Download and unpack the latest version of Tanzu GitOps RI.](#)
2. Update the Tanzu Application Platform version in `GIT-REPO-ROOT/clusters/CLUSTER-NAME/cluster-config/values/tap-install-values.yaml`:

```
tap_install:
  ...
  version:
    package_repo_bundle_tag: "1.6.13"
    package_version: "1.6.13"
```

Where:

- `package_repo_bundle_tag` is the version of Tanzu Application Platform you want to upgrade to.
 - `package_version` is the version of Tanzu Application Platform you want to upgrade to. This version must match `package_repo_bundle_tag`.
3. Commit the upgrade configurations:

```
git add . && git commit -m "Upgrade TAP to 1.6.13"
git push
```

Upgrade the existing SOPs based installation

In previous versions of Tanzu GitOps RI, sensitive values were provided to Tanzu Sync by using the command line and environment variables. This is replaced by a SOPs encrypted file that is committed to the repository.

Follow these steps to upgrade the existing SOPs based installation:

1. [Download and unpack the new version of Tanzu GitOps RI.](#)
2. Overwrite the configuration for TAP installation and Tanzu Sync from the catalog:

```
cd $HOME/tap-gitops
./setup-repo.sh CLUSTER-NAME sops
```

Where:

- `CLUSTER-NAME` the name of your cluster you want to upgrade.
- `sops` selects the Secrets OPerationS-based secrets management variant. Changing between SOPs and any other secret management variant is not supported!

Example:

```
cd $HOME/tap-gitops
./setup-repo.sh full-tap-cluster sops
Created cluster configuration in ./clusters/full-tap-cluster.
...
```

3. [Prepare sensitive Tanzu Sync values.](#)

Upgrade the existing ESO based installation

Follow these steps to upgrade the existing ESO based installation with secrets managed externally in AWS Secrets Manager:

1. [Download and unpack the new version of Tanzu GitOps RI.](#)
2. Overwrite the configuration for Tanzu Application Platform installation and Tanzu Sync from the catalog:

```
cd $HOME/tap-gitops
./setup-repo.sh CLUSTER-NAME aws-secrets-manager
```

Where:

- `CLUSTER-NAME` the name of your cluster you want to upgrade.
- `aws-secrets-manager` selects the AWS Secrets Manager external Secret Store.

Example:

```
cd $HOME/tap-gitops
./setup-repo.sh full-tap-cluster aws-secrets-manager
Created cluster configuration in ./clusters/full-tap-cluster.
...
```

3. [Generate the default configuration.](#)

Verify the upgrade

Verify the versions of packages after the upgrade by running:

```
kubectl get packageinstall --namespace tap-install
```

Your output is similar, but probably not identical, to the following example output:

```
- Retrieving installed packages...
NAME                                     PACKAGE-NAME
PACKAGE-VERSION DESCRIPTION
accelerator                             accelerator.apps.tanzu.vmware.com
1.3.0 Reconcile succeeded
api-auto-registration                   apis.apps.tanzu.vmware.com
0.1.1 Reconcile succeeded
api-portal                             api-portal.tanzu.vmware.com
```

1.2.2	Reconcile	succeeded	appliveview	backend.appliveview.tanzu.vmware.com
1.3.0	Reconcile	succeeded	appliveview-connector	connector.appliveview.tanzu.vmware.com
1.3.0	Reconcile	succeeded	appliveview-conventions	conventions.appliveview.tanzu.vmware.com
1.3.0	Reconcile	succeeded	appsso	sso.apps.tanzu.vmware.com
2.0.0	Reconcile	succeeded	buildservice	buildservice.tanzu.vmware.com
1.7.1	Reconcile	succeeded	cartographer	cartographer.tanzu.vmware.com
0.5.3	Reconcile	succeeded	cert-manager	cert-manager.tanzu.vmware.com
1.7.2+tap.1	Reconcile	succeeded	cnrs	cnrs.tanzu.vmware.com
2.0.1	Reconcile	succeeded	contour	contour.tanzu.vmware.com
1.22.0+tap.3	Reconcile	succeeded	conventions-controller	controller.conventions.apps.tanzu.vmware.com
0.7.1	Reconcile	succeeded	developer-conventions	developer-conventions.tanzu.vmware.com
0.8.0	Reconcile	succeeded	eventing	eventing.tanzu.vmware.com
2.0.1	Reconcile	succeeded	fluxcd-source-controller	fluxcd.source.controller.tanzu.vmware.com
0.27.0+tap.1	Reconcile	succeeded	grype	grype.scanning.apps.tanzu.vmware.com
1.3.0	Reconcile	succeeded	image-policy-webhook	image-policy-webhook.signing.apps.tanzu.vmware.com
1.1.7	Reconcile	succeeded	learningcenter	learningcenter.tanzu.vmware.com
0.2.3	Reconcile	succeeded	learningcenter-workshops	workshops.learningcenter.tanzu.vmware.com
0.2.2	Reconcile	succeeded	metadata-store	metadata-store.apps.tanzu.vmware.com
1.3.3	Reconcile	succeeded	ootb-delivery-basic	ootb-delivery-basic.tanzu.vmware.com
0.10.2	Reconcile	succeeded	ootb-supply-chain-testing-scanning	ootb-supply-chain-testing-scanning.tanzu.vmware.com
0.10.2	Reconcile	succeeded	ootb-templates	ootb-templates.tanzu.vmware.com
0.10.2	Reconcile	succeeded	policy-controller	policy.apps.tanzu.vmware.com
1.1.1	Reconcile	succeeded	scanning	scanning.apps.tanzu.vmware.com
1.3.0	Reconcile	succeeded	service-bindings	service-bindings.labs.vmware.com
0.8.0	Reconcile	succeeded	services-toolkit	services-toolkit.tanzu.vmware.com
0.8.0	Reconcile	succeeded	source-controller	controller.source.apps.tanzu.vmware.com
0.5.0	Reconcile	succeeded	spring-boot-conventions	spring-boot-conventions.tanzu.vmware.com
0.5.0	Reconcile	succeeded	tap	tap.tanzu.vmware.com
1.6.1	Reconcile	succeeded	tap-auth	tap-auth.tanzu.vmware.com
1.1.0	Reconcile	succeeded	tap-gui	tap-gui.tanzu.vmware.com
1.3.0	Reconcile	succeeded	tap-telemetry	tap-telemetry.tanzu.vmware.com
0.3.1	Reconcile	succeeded	tekton-pipelines	tekton.tanzu.vmware.com
0.39.0+tap.2	Reconcile	succeeded		

Migrate Tanzu Application Platform images from VMware Tanzu Network

This topic tells you how to update your Tanzu Application Platform installation to use images located in your own registry instead of VMware Tanzu Network registry.

Tanzu Application Platform releases have migrated from VMware Tanzu Network to the Broadcom Support Portal and Broadcom registry. Using VMware Tanzu Network to install or upgrade Tanzu Application Platform is no longer supported. It is now mandatory to relocate the Tanzu Application Platform images from `tanzu.packages.broadcom.com` to your own container image registry.

Who must follow these steps

You must follow the procedures in this topic if both of the following conditions apply:

- The Tanzu Application Platform images for your installation are located in `registry.tanzu.vmware.com` instead of in your own registry because you skipped the install step [Relocate images to a registry](#).
- You are not upgrading your Tanzu Application Platform installation. If you are upgrading, you can relocate the Tanzu Application Platform images as part of the steps in [Upgrade Tanzu Application Platform](#).

Migrate Tanzu Application Platform images

To update your Tanzu Application Platform installation to use images located in your own registry instead of VMware Tanzu Network registry, you must:

- [Update the package repository](#)
- [Restart the kapp controller](#)

Update the package repository

Follow these steps to update the package repository:

1. Relocate the Tanzu Application Platform images by following step 1 through step 6 in [Relocate images to a registry](#).



Important

You must set the `TAP_VERSION` environment variable to the same version of Tanzu Application Platform that you have already installed, for example, `1.6.13`.

2. Update the source URL of the package repository to the container image registry where you relocated the Tanzu Application Platform images to by running:

```
tanzu package repository update tanzu-tap-repository \
--url ${INSTALL_REGISTRY_HOSTNAME}/TARGET-REPOSITORY/tap-packages:${TAP_VERSION}
```

```
N} \  
--namespace tap-install
```

Where `TARGET-REPOSITORY` is your target repository. This is a folder or repository on in your registry that serves as the location for the Tanzu Application Platform installation files.

3. Verify that you added the new package repository by running:

```
tanzu package repository get TAP-REPO-NAME --namespace tap-install
```

Where `TAP-REPO-NAME` is the package repository name. It must match with `tanzu-tap-repository` in the previous step.

Restart the kapp controller

Restart the kapp controller so that installed applications can pull the images from your container image registry. Run:

```
kubectl rollout restart deployment kapp-controller -n kapp-controller
```

Wait for 10 to 15 mins for the installed apps to start pulling images from your container image registry.

Scale workloads

This topic describes the best practices required to build and deploy workloads at scale.

Sample application reference

The following sections describe the configuration of the different-size applications used to derive scalability best practices.

Small

This is the simplest configuration and consists of the following services and workloads:

- API Gateway workload
- Search workload with in-memory database
- Search processor workload
- Availability workload with in-memory database
- UI workload
- 3 Node RabbitMQ cluster

Medium

This includes all of the services of the small-size application and the following services and workloads:

- Notify workload
- Persistent Database, MySQL or Postgres
- RabbitMQ Event Source
- KNative Eventing broker
- KNative triggers

Large

This includes all of the services of the medium size application and the following services and workloads:

- Crawler Service
- Redis
- RabbitMQ-backed eventing broker
- RabbitMQ-backed triggers

Application Configuration

The following section describes the application configuration used to derive the scalability best practices.

Supply chains used:

- Out of the Box Supply Chain with Testing and Scanning (Build+Run)
- Out of the Box Supply Chain Basic + Out of the Box Supply Chain with Testing (Iterate)

Workload type: `web, server + worker`

Kubernetes Distribution: Azure Kubernetes Service

Number of applications deployed concurrently: 50–55

	CPU	Memory Range	Workload CRs in Iterate	Workload CRs in Build+Run	Workload Transactions per second
Small	500m - 700m	3-5 GB	4	5	4
Medium	700m - 1000m	4-6 GB	NA	6	4
Large	1000m - 1500m	6-8 GB	NA	7	4

Scale configuration for workload deployments

This section describes cluster sizes for deploying a 1K workload.

Node configuration: 4 vCPUs, 16 GB RAM, 120 GB Disk size

Cluster Type / Workload Details	Shared Iterate Cluster	Build Cluster	Run Cluster 1	Run Cluster 2	Run Cluster 3
No. of Namespaces	300	333	333	333	333
Small	300	233	233	233	233
Medium		83	83	83	83
Large		17	17	17	17
No. of Nodes	90	60	135	135	135

Best Practices

The following table describes the resource limit changes that are required for components to support the scale configuration described in the previous table.

Controller/Pod	CPU Requests/Limits	Memory Requests/Limits	Other changes	Build	Run	Iterate	Changes made in
Build Service/kpack controller	20 m/100 m	1 Gi/2 Gi	n/a	Yes	No	Yes	<code>tap-values.yaml</code>
Scanning/scanlink	200 m/500 m	1 Gi/3 Gi	“SCAN_JOB_TTL_SECONDS_AFTER_FINISHED” - 10800*	Yes	No	No	<code>tap-values.yaml</code>
Cartographer	3000 m/4000 m	10 Gi/10 Gi	In <code>tap-values.yaml</code> , change <code>concurrency</code> to 25.	Yes	Partial (only CPU)	Yes	<code>tap-values.yaml</code>

Controller/Pod	CPU Requests/Limits	Memory Requests/Limits	Other changes	Build	Run	Iterate	Changes made in
Cartographer conventions	100 m/100 m	20 Mi/ 1.8 Gi	n/a	Yes	Yes	Yes	tap-values.yaml
Namespace Provisioner	100 m/500 m	500 Mi/2 Gi	n/a	Yes	Yes	Yes	tap-values.yaml
Cnrs/knative-controller	100 m/1000 m	512 Mi/2 Gi	n/a	No	Yes	Yes	overlay
Cnrs/net-contour	40 m/400 m	512 Mi/2 Gi	In tap-values.yaml, change Contour envoy workload type from Daemonset to Deployment.	No	Yes	Yes	overlay
Cnrs/activator	300 m/1000 m	5 Gi/5 Gi	n/a	No	Yes	No	overlay
Cnrs/autoscaler	100 m/1000 m	2 Gi/2 Gi	n/a	No	Yes	No	overlay
Eventing/triggersh	50 m/200 m	100 Mi - 800 Mi	n/a	No	Yes	Yes	overlay
tap-telemetry/tap-telemetry-informer	100 m/1000 m	100 m/ 2 Gi	n/a	Yes	No	Yes	tap-values.yaml

- CPU is measured in millicores. m = millicore. 1000 millicores = 1 vCPU.
- Memory is measured in Mebibyte and Gibibyte. Mi = Mebibyte. Gi = Gibibyte
- In the CPU Requests/Limits column and the Memory Requests/Limits, the changed values are bolded. Non-bolded values are the default ones set during a Tanzu Application Platform installation.
- In the CPU Requests/Limits column, some of the request and limits values are set equally so that the pod is allocated in a node where the requested limit is available.

* Only when there is an issue with scan pods getting deleted before Cartographer can process it

Example resource limit changes

The following section provides examples of the changes required to the default limits to achieve scalability:

Cartographer

The default Cartographer concurrency limits are:

```

cartographer:
  cartographer:
    concurrency:
      max_workloads: 2
      max_deliveries: 2
      max_runnables: 2

```

Edit `values.yaml` to scale Cartographer concurrency limits. Configure the node with 4 vCPUs, 16 GB RAM, and 120 GB disk size:

```

cartographer:
  cartographer:
    concurrency:
      max_workloads: 25
      max_deliveries: 25
      max_runnables: 25

```

The default resource limits are:

```

resources:
  limits:
    cpu: 1
    memory: 1Gi
  requests:
    cpu: 500m
    memory: 512Mi

```

Edit `values.yaml` to scale resource limit:

```

# build-cluster
cartographer:
  cartographer:
    resources:
      limits:
        cpu: 4
        memory: 10Gi
      requests:
        cpu: 3
        memory: 10Gi

# run-cluster
cartographer:
  cartographer:
    resources:
      limits:
        cpu: 4
        memory: 2Gi
      requests:
        cpu: 3
        memory: 1G

```

Cartographer Conventions

The default resource limits are:

```

resources:
  limits:
    cpu: 100m
    memory: 256Mi
  requests:
    cpu: 100m
    memory: 20Mi

```

Edit `values.yaml` to scale resource limit:

```

cartographer:
  conventions:
    resources:
      limits:
        memory: 1.8Gi

```

Scan-link-controller

The default resource limits are:

```
resources:
  limits:
    cpu: 250m
    memory: 256Mi
  requests:
    cpu: 100m
    memory: 128Mi
```

Edit `values.yaml` to scale resource limit:

```
scanning:
  resources:
    limits:
      cpu: 500m
      memory: 3Gi
    requests:
      cpu: 200m
      memory: 1Gi
```

kpac-controller in build service

The default resource limits are:

```
resources:
  limits:
    memory: 1Gi
  requests:
    cpu: 20m
    memory: 1Gi
```

Edit `values.yaml` to scale resource limits:

```
buildservice:
  controller:
    resources:
      limits:
        memory: 2Gi
        cpu: 100m
      requests:
        memory: 1Gi
        cpu: 20m
```

Namespace Provisioner

The default resource limits are:

```
resources:
  limits:
    cpu: 500m
    memory: 100Mi
  requests:
    cpu: 100m
    memory: 20Mi
```

Edit `values.yaml` to scale resource limits:

```
namespace_provisioner:
  controller_resources:
    resources:
      limits:
```

```

    cpu: 500m
    memory: 2Gi
  requests:
    cpu: 100m
    memory: 500Mi

```

Cloud Native Runtimes Knative Serving

The default resource limits are:

```

resources:
  limits:
    cpu: 1
    memory: 1000Mi
  requests:
    cpu: 100m
    memory: 100Mi

```

Use an overlay to make the following resource limit changes:

```

apiVersion: v1
kind: Secret
metadata:
  name: cnrs-patch-knative-controller
  namespace: tap-install
stringData:
  cnrs-patch-knative-controller.yaml: |
    #@ load("@ytt:overlay", "overlay")
    #@overlay/match by=overlay.subset({"kind":"Deployment", "metadata":{"name":"control
    ler", "namespace": "knative-serving"}})
    ---
    spec:
      template:
        spec:
          containers:
            #@overlay/match by="name"
            - name: controller
              resources:
                limits:
                  cpu: 1
                  memory: 2Gi
                requests:
                  cpu: 100m
                  memory: 512Mi

```

net-contour controller

Change deployment type from Daemonset to Deployment.

```

contour:
  envoy:
    workload:
      type: Deployment
      replicas: 3

```

The default resource limits are:

```

resources:
  limits:
    cpu: 400m
    memory: 400Mi
  requests:

```

```
cpu: 40m
memory: 40Mi
```

Use an overlay to make the following resource limit changes:

```
apiVersion: v1
kind: Secret
metadata:
  name: cnrs-patch-net-contour
  namespace: tap-install
stringData:
  cnrs-patch-net-contour.yaml: |
    #@ load("@ytt:overlay", "overlay")
    #@overlay/match by=overlay.subset({"kind":"Deployment", "metadata":{"name":"net-con
    tour-controller", "namespace": "knative-serving"})
    ---
    spec:
      template:
        spec:
          containers:
            #@overlay/match by="name"
            - name: controller
              resources:
                limits:
                  cpu: 400m
                  memory: 2Gi
                requests:
                  cpu: 40m
                  memory: 512Mi
```

Autoscaler

The default resource limits are:

```
resources:
  limits:
    cpu: 1
    memory: 1000Mi
  requests:
    cpu: 100m
    memory: 100Mi
```

Use an overlay to make the following resource limit changes:

```
apiVersion: v1
kind: Secret
metadata:
  name: cnrs-patch-autoscaler
  namespace: tap-install
stringData:
  cnrs-patch-autoscaler.yaml: |
    #@ load("@ytt:overlay", "overlay")
    #@overlay/match by=overlay.subset({"kind":"Deployment", "metadata":{"name":"autosca
    ler", "namespace": "knative-serving"})
    ---
    spec:
      template:
        spec:
          containers:
            #@overlay/match by="name"
            - name: autoscaler
              resources:
                limits:
                  cpu: 1000m
```

```

    memory: 2Gi
  requests:
    cpu: 100m
    memory: 2Gi

```

Activator

The default resource limits are:

```

resources:
  limits:
    cpu: 1
    memory: 600Mi
  requests:
    cpu: 300m
    memory: 60Mi

```

Use an overlay to make the following resource limit changes:

```

apiVersion: v1
kind: Secret
metadata:
  name: cnrs-patch-activator
  namespace: tap-install
stringData:
  cnrs-patch-activator.yaml: |
    #@ load("@ytt:overlay", "overlay")
    #@overlay/match by=overlay.subset({"kind":"Deployment", "metadata":{"name":"activator", "namespace": "knative-serving"}})
    ---
    spec:
      template:
        spec:
          containers:
            #@overlay/match by="name"
            - name: activator
              resources:
                limits:
                  cpu: 1000m
                  memory: 5Gi
                requests:
                  cpu: 300m
                  memory: 5Gi

```

Triggermesh

The default resource limits are:

```

resources:
  limits:
    cpu: 200m
    memory: 300Mi
  requests:
    cpu: 50m
    memory: 100Mi

```

Use an overlay to make the following resource limit changes:

```

apiVersion: v1
kind: Secret
metadata:
  name: triggermesh-patch-triggermesh-controller
  namespace: tap-install

```

```

stringData:
  triggermesh-patch-triggermesh-controller.yaml: |
    #@ load("@ytt:overlay", "overlay")
    #@overlay/match by=overlay.subset({"kind":"Deployment", "metadata":{"name":"trigger
    mesh-controller", "namespace": "triggermesh"}})
    ---
    spec:
      template:
        spec:
          containers:
            #@overlay/match by="name"
            - name: controller
              resources:
                limits:
                  cpu: 200m
                  memory: 800Mi
                requests:
                  cpu: 50m
                  memory: 100Mi

```

Tanzu Application Platform Telemetry

The default resource limits are:

```

resources:
  limits:
    cpu: 1
    memory: 1000Mi
  requests:
    cpu: 100m
    memory: 100Mi

```

Edit `values.yaml` to scale resource limits:

```

tap_telemetry:
  limit_memory: 2Gi

```

kube-dns resource limit changes for GKE clusters

The default memory limit for kube-dns pods is set to 210 Mi. VMware recommends that you set it to 1 Gi. For instructions, see the [GKE documentation](#).

Overview of security and compliance in Tanzu Application Platform

Security is a primary focus for Tanzu Application Platform (commonly known as TAP).

This section describes:

[Overview of TLS and certificates in Tanzu Application Platform](#)

[Use custom CA certificates in Tanzu Application Platform](#)

[Use External Secrets Operator in Tanzu Application Platform \(beta\)](#)

[Assess Tanzu Application Platform against the NIST 800-53 Moderate Assessment](#)

[Harden Tanzu Application Platform](#)

Overview of TLS and certificates in Tanzu Application Platform

This topic provides you with information about certificate requirements for ingress and egress communication in Tanzu Application Platform (commonly known as TAP).

Ingress communication uses TLS by default. Platform operators can control certificates and how they are used by components. For more information, see [Ingress certificates](#).

For egress communication, you can establish trust for custom CA certificates. For more information, see [Custom CA certificates](#).

Secure Ingress certificates in Tanzu Application Platform

This topic tells you how to secure exposed ingress endpoints with TLS in Tanzu Application Platform (commonly known as TAP).

Tanzu Application Platform exposes ingress endpoints so that:

- Platform operators and application developers can interact with the platform.
- End users can interact with applications running on the platform.

For information about ingress endpoints and their certificates, see [Ingress certificates inventory](#).

To secure these endpoints with TLS, such as `https://`, Tanzu Application Platform has two ways of configuring ingress certificates:

A shared ingress issuer

VMware recommends a shared ingress issuer as the best practice for issuing ingress certificates on Tanzu Application Platform.

The ingress issuer is an on-platform representation of a certificate authority. All participating components get their certificates issued by it. It is designated by the single Tanzu Application Platform configuration value `shared.ingress_issuer`. Unless customized, all components obtain their ingress certificates from this issuer.

By default, the ingress issuer is self-signed.

For more information about prerequisites, default values, and how to bring your own issuer, see [Shared ingress issuer](#).

Component-level configuration

In some situations, depending on [prerequisites](#), the shared ingress issuer is not the right choice. You can override configuration of TLS and certificates per component. A component's ingress and TLS configuration takes precedence over the shared ingress issuer.

For a list of components with ingress and how to customize them, see [Inventory](#).

Tanzu Application Platform also has limited support for [wildcard certificates](#).



Note

The approaches can be mixed, for example, you can use a shared ingress issuer, but override TLS configuration for select components.

Shared Ingress issuer in Tanzu Application Platform

This topic tells you about the Tanzu Application Platform (commonly known as TAP) shared ingress issuer.

The shared ingress issuer is an on-platform representation of a certificate authority. It provides a method to set up TLS for the entire platform. All participating components get their ingress certificates issued by it.

This is the recommended best practice for issuing ingress certificates on Tanzu Application Platform. Learn about its [prerequisites](#).

The ingress issuer is designated by the single Tanzu Application Platform configuration value `shared.ingress_issuer`. It refers to a `cert-manager.io/v1/ClusterIssuer`.

By default, a self-signed issuer is used. It's called `tap-ingress-selfsigned` and has limitations. For more information, see [Limitations of the default, self-signed issuer](#).

VMware recommends that you replace the default self-signed issuer with your own issuer. For more information, see [Replacing the default ingress issuer](#).

Component-level configuration of TLS takes precedence and can be mixed with the ingress issuer. For more information, see [Overriding TLS for components](#).

You can deactivate the ingress issuer. For more information, see [Deactivating TLS for ingress](#).

Prerequisites

To use the Tanzu Application Platform ingress issuer, your *certificate authority* must be representable by a cert-manager `ClusterIssuer`. In particular, you need one of the following:

- Your own CA certificate
- Your CA is an ACME, Venafi, or Vault-based issuer, for example, *LetsEncrypt*
- Your CA can be represented by an [external](#) cert-manager `ClusterIssuer`.

Without one of the above, you cannot use the issuer ingress, but you can still configure TLS for components. For more information, see [Ingress certificates inventory](#).

Default

By default, Tanzu Application Platform installs and uses a self-signed CA as its ingress issuer for all components.

This default ingress issuer is a self-signed `cert-manager.io/v1/ClusterIssuer` and is provided by Tanzu Application Platform's `cert-manager` package. Its default name is `tap-ingress-selfsigned`.

The default ingress issuer is appropriate for testing and evaluation, but VMware recommends that you replace it with your own issuer.



Important

If `cert-manager.tanzu.vmware.com` is excluded from the installation, then `tap-ingress-selfsigned` is not installed either. In this case, bring your own ingress issuer.

Limitations of the default, self-signed issuer

The default ingress issuer represents a self-signed *certificate authority*. This is not problematic as far as security is concerned, however, it is not included in any trust chain configured.

As a result, nothing trusts the default ingress issuer implicitly, not even Tanzu Application Platform components. While the issued certificates are valid in principal, they are rejected, for example, by your browser. Furthermore, some interactions between components are not functional by default.

Trusting the default, self-signed issuer

You can trust the default ingress issuer by including `tap-ingress-selfsigned`'s certificate in the Tanzu Application Platform trusted CA certificates and your device's certificate chain.



Caution

This approach is discouraged. Instead, replace the default ingress issuer.

1. Obtain `tap-ingress-selfsigned`'s PEM-encoded certificate

```
kubectl get secret \
  tap-ingress-selfsigned-root-ca \
  --namespace cert-manager \
  --output go-template='{{ index .data "tls.crt" | base64decode }}'
```

2. Add the certificate to [custom CA certificates](#) by appending it to `shared.ca_cert_data` and applying Tanzu Application Platform's installation values
3. Add the certificate to your device's trust chain. The trust chain will vary depending on your operating system and privileges.

Replacing the default ingress issuer

Tanzu Application Platform's default ingress issuer can be replaced by any other [cert-manager-compliant ClusterIssuer](#).

To replace the default ingress issuer:

Custom CA

Complete the following steps:

Prerequisites

You need your own CA certificates and private key for this.

1. Create your `ClusterIssuer`

Create a `Secret` and `ClusterIssuer` which represent your CA on the platform:

```
---
apiVersion: v1
kind: Secret
type: kubernetes.io/tls
metadata:
  name: my-company-ca
  namespace: cert-manager
stringData:
  tls.crt: #! your CA's PEM-encoded certificate
  tls.key: #! your CA's PEM-encoded private key
---
apiVersion: cert-manager.io/v1
kind: ClusterIssuer
metadata:
  name: my-company
spec:
  ca:
    secretName: my-company-ca
```

2. Set `shared.ingress_issuer` to the name of your issuer:

```
#! my-tap-values.yaml
#! ...
shared:
  ingress_issuer: my-company-ca
#! ...
```

3. Apply the Tanzu Application Platform installation values file.

When the configuration is applied, components obtain certificates from the new issuer and serve them.

LetsEncrypt production

Complete the following steps

Prerequisites

- Public CAs, like LetsEncrypt, record signed certificates in publicly-available certificate logs for the purpose of [certificate transparency](#). Ensure that you are OK with this before using LetsEncrypt.
- LetsEncrypt's production API has [rate limits](#).
- LetsEncrypt requires your `shared.ingress_domain` to be accessible from the Internet.
- Depending on your setup, you might need to adjust `.spec.acme.solvers`
- Replace `.spec.acme.email` with the email which should receive notices for certificates from LetsEncrypt.



Caution

ACME HTTP01 challenges can fail under certain conditions. For more information, see [ACME challenges](#).

1. Create a `ClusterIssuer` for Let's Encrypts production API:

```
---
apiVersion: cert-manager.io/v1
kind: ClusterIssuer
metadata:
  name: letsencrypt-production
spec:
  acme:
    email: certificate-notices@my-company.com
    privateKeySecretRef:
      name: letsencrypt-production
    server: https://acme-v02.api.letsencrypt.org/directory
    solvers:
      - http01:
          ingress:
            class: contour
```

2. Set `shared.ingress_issuer` to the name of your issuer

```
#! my-tap-values.yaml
#! ...
shared:
  ingress_issuer: letsencrypt-production
#! ...
```

3. Apply Tanzu Application Platform installation values

When the configuration is applied, components obtain certificates from the new issuer and serve them.

LetsEncrypt staging

Complete the following steps

Prerequisites

- Public CAs - like LetsEncrypt - record signed certificates in publicly-available certificate logs for the purpose of [certificate transparency](#). Ensure that you are OK with this before using LetsEncrypt.
- LetsEncrypt's staging API is not a publicly-trusted CA. You have to add its certificate to your devices trust chain and [Tanzu Application Platform's custom CA certificates](#).
- LetsEncrypt requires your `shared.ingress_domain` to be accessible from the Internet.
- Depending on your setup you might need to adjust `.spec.acme.solvers`.
- Replace `.spec.acme.email` with the email which should receive notices for certificates from LetsEncrypt.



Caution

ACME HTTP01 challenges can fail under certain conditions. For more information, see [ACME challenges](#).

1. Create a `ClusterIssuer` for Let's Encrypts staging API:

```

---
apiVersion: cert-manager.io/v1
kind: ClusterIssuer
metadata:
  name: letsencrypt-staging
spec:
  acme:
    email: certificate-notices@my-company.com
    privateKeySecretRef:
      name: letsencrypt-production
    server: https://acme-staging-v02.api.letsencrypt.org/directory
    solvers:
      - http01:
          ingress:
            class: contour

```

2. Set `shared.ingress_issuer` to the name of your issuer

```

#! my-tap-values.yaml
#! ...
shared:
  ingress_issuer: letsencrypt-staging
#! ...

```

3. Apply Tanzu Application Platform installation values

After the configuration is applied, components obtain certificates from the new issuer and serve them.

Other

Complete the following steps

You can use any other cert-manager-supported `ClusterIssuer` as an ingress issuer for Tanzu Application Platform.

cert-manager supports a host of in-tree and out-of-tree issuers. See cert-manager's [documentation of issuers](#).

1. Set `shared.ingress_issuer` to the name of your issuer

```

#! my-tap-values.yaml
#! ...
shared:
  ingress_issuer: my-company-ca
#! ...

```

2. Apply Tanzu Application Platform's installation values

After the configuration is applied, components obtain certificates from the new issuer and serve them.

There are many ways and tools to assert that new certificates are issued and served. It is best to connect to one of the ingress endpoints and inspect the certificate it serves.

The `openssl` command-line utility is available on most operating systems. The following command retrieves the certificate from an ingress endpoint and shows its text representation:

```

# replace tap.example.com with your Tanzu Application Platform installation's ingress
domain
openssl s_client -showcerts -servername tap-gui.tap.example.com -connect tap-gui.tap.e
xample.com:443 <<< Q | openssl x509 -text -noout

```

Alternatively, use a browser to navigate to the ingress endpoint and click the lock icon in the navigation bar to inspect the certificate.

Deactivating TLS for ingress

While VMware does not recommend it, you can deactivate the ingress issuer by setting `shared.ingress_issuer: ""`.

Overriding TLS for components

You can override TLS settings for each component. In your Tanzu Application Platform values file a component's configuration takes precedence over `shared` values. For more information about which components have ingress and how to configure them, see [components](#)



Note

The approaches can be mixed. Use a shared ingress issuer, but override TLS configuration for select components.

Use wildcard certificates in Tanzu Application Platform

This topic tells you about using wildcard certificates in Tanzu Application Platform (commonly known as TAP) for components with a fixed or variable set of ingress endpoints.

You can use wildcard certificates, but Tanzu Application Platform does not offer support.

Wildcard certificates require component-level configuration. For more information about which components support wildcards, see [Inventory](#).

When using wildcard certificates the approach differs between components that have a fixed set of ingress endpoints and those that have a variable set of ingress endpoints:

- Components with a fixed set of ingress endpoints can receive a reference to the wildcard certificate's `Secret` and an ingress domain, for example, Tanzu Application Platform GUI.
- Components with a variable set of ingress endpoints usually offer Kubernetes APIs that create ingress resources. These components allow configuration of domain templating so that wildcard certificates can be used, for example, Cloud Native Runtimes and Application Single Sign-On.



Note

You can use a mixed approach for configuring TLS for components. For example, use a shared ingress issuer, but override TLS configuration for select components while using wildcard certificates for some.

Plan Ingress certificates inventory in Tanzu Application Platform

This topic tells you how to plan for TLS certificates in Tanzu Application Platform (commonly known as TAP).

The effective number of ingress endpoints can vary widely, depending on the installation profile, excluded packages, and end-user-facing resources such as `Workload`, and `AuthServer`. As a result,

the number of TLS certificates is not fixed but is a function of the platform's configuration and tenancy.

Components are categorized into those which don't have ingress endpoints and those which do. The latter further breaks down into those which have a fixed number of ingress endpoints and those which offer Kubernetes APIs with ingress.



Note

The lowercase ingress refers to any resource which facilitates ingress, for example, core `Ingress` and Contour's `HTTPProxy`.

Use the following table to help with the planning and accounting of TLS certificates. For a full list of components and the profiles supported for each component, see [About Tanzu Application Platform components and profiles](#).

Package name	Ingress purpose	Supports ingress issuer	Supports wildcards	Number of ingress	SANs*
api-portal.tanzu.vmware.com	Serves the API portal	No	Yes	1	<code>api-portal.INGRESS-DOMAIN</code>
cnrs.tanzu.vmware.com	Instances of Knative's <code>Service</code> have ingress	Yes	Yes	Number of <code>Services</code>	SANs depend on the component's <code>domain_template</code>
learningcenter.tanzu.vmware.com	Instances of <code>TrainingPortal</code> have ingress	No	Yes**	Number of <code>TrainingPortals</code>	<code>TRAINING-PORTAL.learningcenter.INGRESS-DOMAIN</code>
metadata-store.apps.tanzu.vmware.com	Serves the Supply Chain Security Tools store	Yes	Yes	1	<code>metadata-store.INGRESS-DOMAIN</code>
spring-cloud-gateway.tanzu.vmware.com	Instances of <code>SpringCloudGateway</code> have ingress	No	Yes	Number of <code>SpringCloudGateways</code>	See Using an Ingress Resource in the Spring Cloud Gateway documentation
sso.apps.tanzu.vmware.com	Instances of <code>AuthServer</code> have ingress	Yes	Yes	Number of <code>AuthServers</code>	Depends on the component's <code>domain_template</code>
tap-gui.tanzu.vmware.com	Serves the platform-internal developer and service portal	Yes	Yes	1	<code>tap-gui.INGRESS-DOMAIN</code>

*The SANs is configurable for components in the following two ways:

- components that install a single ingress resource in the form of `COMPONENT.DOMAIN-NAME`, for example, Tanzu Developer Portal (formerly named Tanzu Application Platform GUI)
- components that install an ingress resource per API instance that gets templated from a `domain_template` feeding `DOMAIN-NAME`, for example, [cnrs.tanzu.vmware.com](#) and [sso.apps.tanzu.vmware.com](#)

** Only supports wildcards

Use custom CA certificates in Tanzu Application Platform

This topic tells you about configuring custom CA certificates in Tanzu Application Platform (commonly known as TAP).

You configure trust for custom CAs. This is helpful if any Tanzu Application Platforms components are connecting to services that serve certificates issued by private certificate authorities.

The `shared.ca_cert_data` installation value can contain a PEM-encoded CA bundle. Each component then trusts the CAs contained in the bundle.

You can also configure trust per component by providing a CA bundle in the component's installation values. The component then trusts those CAs and the CAs configured in `shared.ca_cert_data`. For more information, see [components](#).

For example:

```
#!/ my-tap-values.yaml

shared:
  ca_cert_data: |
    Corporate CA 1
    -----BEGIN CERTIFICATE-----
    MIIFmDCCA4...
    -----END CERTIFICATE-----
    Corporate CA 2
    -----BEGIN CERTIFICATE-----
    MIIFkzCCA3...
    -----END CERTIFICATE-----
```

Some Tanzu Application Platform components do not support the `shared.ca_cert_data` feature, such as Flux CD, Tekton, and the External Secrets operator. Any custom CA certificates must be configured directly by those components.

For information about using Git with a custom CA in supply chains and configuring the `caFile` parameter, see [Git Authentication](#).

Use External Secrets Operator in Tanzu Application Platform (beta)

The [External Secrets Operator](#) is a Kubernetes operator that integrates with external secret management systems, for example, Google Secrets Manager and Hashicorp Vault. It reads information from external APIs and automatically injects the values into a Kubernetes secret.

Tanzu Application Platform (commonly known as TAP) uses the [External Secrets Operator](#) to simplify Kubernetes secret life cycle management. The `external-secrets` plug-in, which is available in the Tanzu CLI, interacts with the [External Secrets Operator](#) API. Users can use this CLI plug-in to create and view External Secrets Operator resources on a Kubernetes cluster.

External Secrets Operator is available in Tanzu Application Platform packages with a Carvel Package named `external-secrets.apps.tanzu.vmware.com`. It is not part of any installation profile.



Caution

The External Secrets plug-in is in beta and is intended for evaluation and test purposes only. Do not use it in a production environment.

Where to start

To learn more about managing secrets with External Secrets in general, see the official [External Secrets Operator documentation](#). For installing the External Secrets Operator and the CLI plug-in see the following documentation. Also, see the example integration of External-Secrets with Hashicorp Vault.

- [Installing External Secrets Operator in TAP](#)
- [Installing Tanzu CLI](#)
- [External-Secrets with Hashicorp Vault](#)

Install External Secrets Operator in Tanzu Application Platform

This topic tells you how to install the External Secrets Operator from the Tanzu Application Platform (commonly known as TAP) package repository.



Important

External Secrets Operator is not included or installed with any Tanzu Application Platform profile.

Prerequisites

Before installing External Secrets Operator:

- Complete all prerequisites to install the Tanzu Application Platform. For more information, see [Prerequisites](#).

Install

To install External Secrets Operator:

1. List version information for the package by running:

```
tanzu package available list external-secrets.apps.tanzu.vmware.com -n tap-inst
all
```

For example:

NAME	VERSION	RELEASED-AT
external-secrets.apps.tanzu.vmware.com	0.6.1+tap.6	2023-03-08 14:00:00 -0500 EST

2. Install the package:

```
tanzu package install external-secrets \
--package external-secrets.apps.tanzu.vmware.com \
--version VERSION-NUMBER \
--namespace tap-install
```

Where `VERSION-NUMBER` is the version of the package listed in step 1.

For example:

```
$ tanzu package install external-secrets \
--package external-secrets.apps.tanzu.vmware.com \
--version 0.6.1+tap.6 \
```



```

--namespace tap-install

\ Installing package 'external-secrets.apps.tanzu.vmware.com'
| Getting package metadata for 'external-secrets.apps.tanzu.vmware.com'
| Creating service account 'external-secrets-tap-install-sa'
/ Creating cluster admin role 'external-secrets-tap-install-cluster-role'
| Creating cluster role binding 'external-secrets-tap-install-cluster-rolebindi
n
/ Creating cluster role binding 'external-secrets-tap-install-cluster-rolebindi
n
\ Creating cluster role binding 'external-secrets-tap-install-cluster-rolebindi
n
| Creating cluster role binding 'external-secrets-tap-install-cluster-rolebindi
ng'
\ Creating package resource
Waiting for 'PackageInstall' reconciliation for 'external-secrets'
'PackageInstall' resource install status: Reconciling
'PackageInstall' resource install status: ReconcileSucceeded

Added installed package 'external-secrets'

```

3. Verify the package installation by running:

```

tanzu package installed get external-secrets \
--namespace tap-install

```

For example:

```

tanzu package installed get external-secrets -n tap-install

NAME:                external-secrets
PACKAGE-NAME:        external-secrets.apps.tanzu.vmware.com
PACKAGE-VERSION:     0.6.1+tap.6
STATUS:              Reconcile succeeded
CONDITIONS:          [{ReconcileSucceeded True  }]
USEFUL-ERROR-MESSAGE:

```

Integrate External Secrets Operator with HashiCorp Vault in Tanzu Application Platform

This topic shows you how to integrate External Secrets Operator with [HashiCorp Vault](#) in Tanzu Application Platform.

The operator synchronizes secret data from external APIs to a Kubernetes secret resource. For more information about Kubernetes secret resources, see the [Kubernetes documentation](#).



Important

This example integration is constructed to showcase the features available and must not be considered in a production environment.

Prerequisites

Before proceeding with this example, you must:

- Install External Secrets Operator. For more information, see [Install External Secrets Operator](#).

- Install the Tanzu CLI. The Tanzu CLI includes the plug-in `external-secrets`. For Tanzu CLI installation, see [Tanzu CLI](#).
- Have a running instance of HashiCorp Vault. In this instance, there is a secret defined with the key `eso-demo/reg-cred`.

Set up the integration

To set up the External Secrets Operator integration with HashiCorp Vault:

1. Create a `Secret` with the vault token. For example:

```
VAULT_TOKEN="vault-token-value"

cat <<EOF | kubectl apply -f -
apiVersion: v1
kind: Secret
metadata:
  name: vault-token
stringData:
  token: $VAULT_TOKEN
EOF
```

2. Create a `SecretStore` resource referencing the `vault-token` secret. For example:



Caution

When creating the `SecretStore`, ensure that you match the Vault KV secret engine version. This is either `v1` or `v2`. The default is `v2`. For more information, see [Vault KV Secrets Engine documentation](#).

```
VAULT_SERVER="http://my.vault.server:8200"
VAULT_PATH="eso-demo"

cat <<EOF | tanzu external-secrets store create -y -f -
---
apiVersion: external-secrets.io/v1beta1
kind: SecretStore
metadata:
  name: vault-secret-store
spec:
  provider:
    vault:
      server: $VAULT_SERVER
      path: $VAULT_PATH
      version: v2
      auth:
        tokenSecretRef:
          name: "vault-token" # vault-token created in the previous step
          key: "token"
EOF
```



Important

If you are using a secret store service with a custom CA certificate then you must provide this certificate to External Secret Operator directly by including the CA `SecretStore` or `ClusterSecretStore` resource.

The Tanzu Application Platform distribution of External Secret Operator does not support the Tanzu Application Platform field `shared.ca_cert_data`. For more information about setting the CA in the ESO configuration, see the [ESO documentation](#).

- Verify that the status of the `SecretStore` resource is `Valid` by running:

```
tanzu external-secrets store list
```

Example output:

NAMESPACE	NAME	PROVIDER	STATUS
default	vault-secret-store	Hashicorp Vault	Valid

- Create an `ExternalSecret` resource that uses the `SecretStore` you just created by running:

```
cat <<EOF | tanzu external-secrets secret create -y -f -
---
apiVersion: external-secrets.io/v1beta1
kind: ExternalSecret
metadata:
  name: vault-secret-example
spec:
  refreshInterval: 15m
  secretStoreRef:
    name: vault-secret-store
    kind: SecretStore
  target:
    name: registry-secret
    template:
      type: kubernetes.io/dockerconfigjson
      data:
        .dockerconfigjson: "{{ .registryCred | toString }}"
    creationPolicy: Owner
  data:
  - secretKey: registryCred
    remoteRef:
      key: $VAULT_PATH/eso-demo
      property: reg-cred
EOF
```

- Verify that the status of the `ExternalSecret` resource is `Valid` by running:

```
tanzu external-secrets secret list
```

Example output:

NAMESPACE	NAME	SECRET NAME	STORE	REFRESH I
INTERVAL	STATUS	LAST UPDATED	LAST REFRESH	
default	vault-secret-example	registry-secret	vault-secret-store	15m
SecretSynced	21s	10m		

- After the resource has reconciled, a Kubernetes `secret` resource is created. Look for a secret named `registry-secret` created by the referenced `ExternalSecret`. For example:

```
kubectl get secrets registry-secret -o="jsonpath={.data.\.dockerconfigjson}" |
base64 -D
{"auths":{"my-registry.example:8200":{"username":"foo","password":"bar4","email":"foo@bar.example","auth":"Zm9vOmJhcjQ="}}}
```

Assess Tanzu Application Platform against the NIST 800-53 Moderate Assessment

This topic provides you with an assessment of Tanzu Application Platform (commonly known as TAP) against the NIST SP 800-53 Revision 4 Moderate baseline controls. This translates to FISMA Moderate and CNSSI 1253 Mod/Mod/Mod for use in US Federal systems accreditation.

The Moderate baseline applies to only technical controls. Organizational policy controls, physical security, media policies, and similar are excluded as they are not applicable to Tanzu Application Platform. These excluded controls are still relevant to the system at large and must be inherited from existing accreditations or otherwise addressed.

The initial iteration of this assessment delineates responsible parties. Incremental updates will add more details about implementation and updates to 800-53 Revision 5.

Name	Title	Responsible Party	Notes
AC-2(1)	Automated System Account Management	Customer	Implemented on customer identity store. The customer must employ automated mechanisms to support the management of information system accounts used to access their Tanzu Application Platform installation.
AC-2(2)	Removal of Temporary / Emergency Accounts	Customer	Implemented on customer identity store. If the customer chooses to use temporary or emergency accounts, they must ensure that the system automatically deactivates or removes the account following an organization-defined time period.
AC-2(3)	Deactivate Inactive Accounts	Customer	Implemented on customer identity store. The customer must automatically deactivate inactive accounts used to access their Tanzu Application Platform installation following an organization-defined time period of inactivity.
AC-2(4)	Automated Audit Actions	Customer	Implemented on customer identity store. The customer must automatically audit account creation, modification, enabling, deactivating, and removal actions associated with accounts used to access their Tanzu Application Platform installation and must notify an organization-defined personnel or role.
AC-3	Access Enforcement	Customer	The customer must federate their IdP with Tanzu Application Platform to enforce approved access authorizations to their Tanzu Application Platform installation.
AC-4	Information Flow Enforcement	Customer	The customer is responsible for enforcing approved authorizations for controlling the flow of information between Tanzu Application Platform and interconnected systems, based on organization-defined information flow control policies, for example, a SIEM. Tanzu Application Platform does not restrict intra-service or inter-system communication. Future versions of Tanzu Application Platform will include this feature using service mesh architecture or similar methods.
AC-6	Least Privilege	Shared	The customer is responsible for enforcing least privilege by ensuring Tanzu Application Platform users have the minimum permissions necessary to perform their job function. Tanzu Application Platform is responsible for providing RBAC functionality to enforce least privilege.
AC-6(1)	Authorize Access to Security Functions	Shared	The customer is responsible for explicitly authorizing access to organization-defined security functions and security-relevant information as it relates to their Tanzu Application Platform installation. Tanzu Application Platform is responsible for providing the RBAC functionality necessary to restrict which users can access security functions and security-related information.

Name	Title	Responsible Party	Notes
AC-6(5)	Privileged Accounts	Shared	The customer must restrict privileged Tanzu Application Platform accounts to organization-defined personnel or roles. Tanzu Application Platform is responsible for providing the RBAC functionality for customers to restrict privileged Tanzu Application Platform accounts to organization-defined personnel or roles.
AC-6(9)	Auditing Use of Privileged Functions	Shared	The customer is responsible for configuring Tanzu Application Platform and underlying Kubernetes to send log streams to their SIEM tool for log analysis to be capable of auditing the execution of privileged functions. Tanzu Application Platform is responsible for generating logs pertaining to the execution of privileged functions that can be ingested by the customer SIEM tool for analysis.
AC-6(10)	Prohibit Non-Privileged Users from Executing Privileged Functions	Tanzu Application Platform	This functionality is inherent to Tanzu Application Platform/Kubernetes RBAC and can't be configured otherwise.
AC-7 AC-7a AC-7b	Unsuccessful Logon Attempts	Customer	Implemented on customer identity provider. The customer is responsible for configuring their IdP to enforce a limit of consecutive invalid logon attempts by a user during an organization-defined time period which locks the user's account for an organization-defined time period, or until released by an administrator.
AC-8 AC-8a AC-8a.1 AC-8a.2 AC-8a.3 AC-8a.4 AC-8b AC-8c AC-8c.1 AC-8c.2 AC-8c.3	System Use Notification	Customer	Implemented on customer identity provider. Customer must configure their IdP to display the system use notification banner before login.
AC-11 AC-11a AC-11b	Session Lock	Customer	The customer must configure sessions locks on user workstations used to access their Tanzu Application Platform installation. Tanzu Application Platform does not have a concept of session locks and relies on sessions locks applied by the user's workstation. Tanzu Application Platform provides logout functionality in place of session locking.
AC-11(1)	Pattern-Hiding Displays	Customer	The customer must configure sessions locks on user workstations used to access their Tanzu Application Platform installation. This includes hiding the user's private session with a publicly available image. Tanzu Application Platform does not have a concept of session locks and relies on sessions locks applied by the user's workstation. Tanzu Application Platform provides logout functionality in place of session locking.
AC-12	Session Termination	Shared	Implemented on customer identity provider. The customer is responsible for configuring IdP token TTL and refresh policies that apply to Tanzu Application Platform sessions. Tanzu Application Platform enforces token policies and cannot be configured otherwise.
AC-14 AC-14a	Permitted Actions Without Identification or Authentication	Shared	The customer is responsible for identifying organization-defined user actions that can be performed on the information system without identification or authentication consistent with organizational missions/business functions. For production installations, Tanzu Developer Portal must be configured with OIDC authentication and guest access deactivated.

Name	Title	Responsible Party	Notes
AC-17(1)	Automated Monitoring / Control	Customer	“Remote Access” is defined as outside-the-org endpoints like remote workers over VPN. This is outside the scope of Tanzu Application Platform. The customer is responsible for all aspects regarding “remote access” to Tanzu Application Platform.
AC-17(2)	Protection of Confidentiality / Integrity Using Encryption	Customer	“Remote Access” is defined as outside-the-org endpoints like remote workers over VPN. This is outside the scope of Tanzu Application Platform. The customer is responsible for implementing cryptographic mechanisms to protect the confidentiality and integrity of “remote access” sessions to Tanzu Application Platform.
AC-17(3)	Managed Access Control Points	Customer	“Remote Access” is defined as outside-the-org endpoints like remote workers over VPN. This is outside the scope of Tanzu Application Platform. The customer is responsible for routing all “remote accesses” to Tanzu Application Platform through an organization-defined number of managed network access control points.
AC-19 AC-19 AC-19b	Access Control for Mobile Devices	Customer	The customer is responsible for all aspects regarding mobile devices which grant access to Tanzu Application Platform.
AU-3	Content of Audit Records	Tanzu Application Platform	The Tanzu Application Platform application must be capable of generating audit logs that contain the minimum content required by the customer consuming the application.
AU-3(1)	Additional Audit Information	Customer	Implemented on customer SIEM. The customer is responsible for parsing Tanzu Application Platform logs on their SIEM to extract organization-defined extra information.
AU-4	Audit Storage Capacity	Customer	Implemented on customer Kubernetes. Tanzu Application Platform logs are all captured by Kubernetes logging. The customer is responsible for configuring their Kubernetes hosts with record storage capacity to ensure that there is adequate storage of logs generated by Tanzu Application Platform clusters.
AU-5 AU-5a AU-5b	Response to Audit Processing Failures	Customer	Implemented on customer Kubernetes. Tanzu Application Platform audit records are collected and managed by Kubernetes and are out of Tanzu Application Platform scope. The customer is responsible for configuring their Kubernetes hosts to account for audit processing failures and to alert the appropriate personnel responsible to take appropriate action.
AU-7 AU-7a AU-7b	Audit Reduction and Report Generation	Customer	Implemented on customer Kubernetes and SIEM Tanzu Application Platform audit records are collected and managed by Kubernetes. The customer is responsible for ensuring that Kubernetes ships Tanzu Application Platform audit records to a central SIEM for review and analysis.
AU-7(1)	Automatic Processing	Customer	Implemented on customer Kubernetes and SIEM Tanzu Application Platform audit records are collected and managed by Kubernetes. The customer is responsible for ensuring that Kubernetes ships Tanzu Application Platform audit records to a central SIEM for review and analysis.
AU-8 AU-8a AU-8b	Time Stamps	Tanzu Application Platform	Tanzu Application Platform components pull their system time from the container OS and the Kubernetes host and cannot be configured otherwise. Tanzu Application Platform components log statements include UTC timestamps and cannot be configured otherwise.
AU-8(1) AU-8(1) (a) AU-8(1) (b)	Synchronization With Authoritative Time Source	Customer	The customer is responsible for configuring authoritative time sources on K8 clusters.

Name	Title	Responsible Party	Notes
AU-9	Protection of Audit Information	Customer	Tanzu Application Platform audit records are collected and managed by Kubernetes. The customer is responsible for protecting Kubernetes and Kubernetes logging configurations from unauthorized access, modification, and deletion.
AU-12 AU-12a AU-12b AU-12c	Audit Generation	Shared	Tanzu Application Platform audit records are collected and managed by Kubernetes. The customer is responsible for ensuring that Kubernetes ships Tanzu Application Platform audit records to a central SIEM for review and analysis. Tanzu Application Platform cannot be configured to audit specific information. Tanzu Application Platform logs verbosely and lets the customer filter out what is relevant to them using their SIEM. Tanzu Application Platform logging cannot be deactivated.
CM-7 CM-7a CM-7b	Least Functionality	Shared	The customer is responsible for configuring Tanzu Application Platform to provide only essential capabilities. Tanzu Application Platform is responsible for providing customers with the capability to deactivate non-essential features not required by the customer. The customer must restrict the use of functions, ports, protocols, and services for the Tanzu Application Platform installation. Tanzu Application Platform is responsible for ensuring that functions, ports, protocols, and services are limited to those explicitly required for the application to operate.
CM-7(2)	Prevent Program Execution	Tanzu Application Platform	As an extension of CM-7, Least Functionality, this control is a responsibility of Tanzu Application Platform. Tanzu Application Platform only consists of containers with purposeful services with no extra programs running or bloat. This cannot be configured by the customer.
CM-7(4)(b)	Unauthorized Software/De nylisting	Tanzu Application Platform	Tanzu Application Platform service containers do not implement a deny-by-exception policy to prohibit the execution of unauthorized software programs. Tanzu Application Platform service containers are built to provide stripped-down services and do not include extra programs or bloat. Tanzu Application Platform can provide a SBOM to compare against customer organization policies on disallowed software.
IA-2	Identification and Authentication (Organizational Users)	Shared	The customer is responsible for configuring Tanzu Application Platform to use their IdP which is capable of uniquely identifying and authenticating organizational users. Tanzu Application Platform is responsible for providing customers with the capability to integrate their IdP to allow Tanzu Application Platform to uniquely identify organizational users.
IA-2(1)	Network Access to Privileged Accounts	Customer	Implemented on customer identity provider. The customer is responsible for implementing multifactor authentication on their IdP for network access to privileged accounts.
IA-2(2)	Network Access to Non-Privileged Accounts	Customer	Implemented on customer identity provider. The customer is responsible for implementing multifactor authentication on their IdP for network access to non-privileged accounts.
IA-2(3)	Local Access to Privileged Accounts	N/A	Tanzu Application Platform does not use local accounts. All access occurs over a network connection.
IA-2(8)	Network Access to Privileged Accounts - Replay Resistant	Tanzu Application Platform	Tanzu Application Platform is responsible for ensuring that all connections to the customer IdP are over TLS 1.2+.

Name	Title	Responsible Party	Notes
IA-2(11)	Remote Access - Separate Device	Customer	The customer is responsible for all aspects of MFA and MFA devices used to authenticate to their Tanzu Application Platform installation, including using remote access.
IA-2(12)	Acceptance of Piv Credentials	Customer	Implemented on customer identity provider. The customer is responsible for implementing CAC/PIV credentials with their IdP.
IA-3	Device Identification and Authentication	Customer	The customer is responsible for uniquely identifying and authenticating organization-defined specific and/or types of devices before establishing a local, remote, or network connection.
IA-4e	Identifier Management	Customer	Implemented on customer identity provider. The customer is responsible for configuring IdP token TTL and refresh policies that apply to Tanzu Application Platform sessions. Tanzu Application Platform enforces token policies and cannot be configured otherwise.
IA-5(1) IA-5(1)(a) IA-5(1)(b) IA-5(1)(c) IA-5(1)(d) IA-5(1)(e) IA-5(1)(f)	Password-Based Authentication	Customer	Implemented on customer identity store. The customer is responsible for all aspects of password-based authentication to their IdP, using their identity store. Tanzu Application Platform does not employ password-based authentication itself.
IA-5(2) IA-5(2)(a) IA-5(2)(b) IA-5(2)(c) IA-5(2)(d)	PKI-Based Authentication	Customer	Implemented on customer identity provider. The customer is responsible for all aspects of PKI-based authentication on the IdP used to access their Tanzu Application Platform installation.
IA-5(11)	Hardware Token-Based Authentication	Customer	The customer is responsible for ensuring hardware token-based authentication employs mechanisms that satisfy organization-defined token quality requirements.
IA-6	Authenticator Feedback	Customer	Implemented on customer identity provider. The customer is responsible for ensuring their IdP obscures feedback of authentication information during the authentication process.
IA-7	Cryptographic Module Authentication	Customer	Implemented on customer identity provider. The customer is responsible for ensuring their IdP implements FIPS 140-2 validated cryptographic modules.
IA-8	Identification and Authentication(Non-Organizational Users)	Customer	Implemented on customer identity provider. The customer is responsible for ensuring that their IdP uniquely identifies and authenticates non-organizational Tanzu Application Platform users, or processes acting on behalf of non-organizational users.
IA-8(1)	Acceptance of Piv Credentials from Other Agencies	Customer	Implemented on customer identity provider. The customer is responsible for configuring their IdP to accept and electronically verify Personal Identity Verification(PIV) credentials from other federal agencies.
IA-8(2)	Acceptance of Third-Party Credentials	Customer	Implemented on customer identity provider. The customer is responsible for configuring their IdP to accept only FICAM-approved third-party credentials.

Name	Title	Responsible Party	Notes
IA-8(3)	Use of FICAM-Approved Products	Customer	Implemented on customer identity provider. The customer is responsible for employing only FICAM-approved information system components on their IdP to accept third-party credentials.
IA-8(4)	Use of FICAM-Issued Profiles	Customer	Implemented on customer identity provider. The customer is responsible for ensuring their IdP conforms to FICAM-issued profiles.
SC-2	Application Partitioning	Tanzu Application Platform	Tanzu Application Platform does not isolate user and management functionality on separate network interfaces, instances, CPUs, or similar. Tanzu Application Platform relies on different roles and Kubernetes RBAC to keep user and management functionality distinct.
SC-4	Information in Shared Resources	Tanzu Application Platform	Tanzu Application Platform creates dedicated Kubernetes namespaces upon deployment. Kubernetes namespaces prevent unauthorized and unintended information transfer using shared system resources.
SC-5	Denial of Service Protection	Customer	The customer is responsible for ensuring that organizational DoS protections at the network layer include the Tanzu Application Platform installation.
SC-7 SC-7a SC-7b SC-7c	Boundary Protection	Customer	The customer is responsible for the configuration and management of boundary protection devices.
SC-7(4)(c)	External Telecommunications Services	Customer	The customer is responsible for external telecommunication services used to establish connections to their Tanzu Application Platform installation.
SC-7(5)	Deny by Default / Allow by Exception	Shared	Tanzu Application Platform does not implement “deny by default” network policies. This might be mitigated by network-level access controls configured by the customer.
SC-7(7)	Prevent Split Tunneling for Remote Devices	Customer	The customer is responsible for all configuration of remote devices used to access Tanzu Application Platform.
SC-8	Transmission Confidentiality and Integrity	Tanzu Application Platform	Tanzu Application Platform is responsible for ensuring all communications occur over TLS 1.2+.
SC-8(1)	Cryptographic or Alternate Physical Protection	Tanzu Application Platform	Tanzu Application Platform is responsible for ensuring all communications occur over TLS 1.2+.
SC-10	Network Disconnect	Tanzu Application Platform	Tanzu Application Platform tears down TCP connections and deallocates system resources following the expiration of a session token and cannot be configured otherwise.
SC-12	Cryptographic Key Establishment and Management	Tanzu Application Platform	Tanzu Application Platform is responsible for providing customers with the ability to manage trust stores.

Name	Title	Responsible Party	Notes
SC-13	Cryptographic Protection	Tanzu Application Platform	Tanzu Application Platform is responsible for implementing FIPS 140 validated cryptographic modules and providing the customer with a means to enable "FIPS Mode".
SC-21	Secure Name / Address Resolution Service (Recursive or Caching Resolver)	Customer	Tanzu Application Platform inherits the DNSSEC capabilities of the organization resolvers it is configured to use. The customer is responsible for configuring the Tanzu Application Platform and Kubernetes infrastructure to use DNSSEC-capable resolvers.
SC-23	Session Authenticity	Tanzu Application Platform	Tanzu Application Platform is responsible for ensuring all communications occur over TLS 1.2+.
SC-28	Protection of Information at Rest	Customer	Tanzu Application Platform does not natively provide encryption for data at rest, but instead relies on the underlying Kubernetes persistent volumes for appropriate cryptographic protections. The customer is responsible for deploying Tanzu Application Platform to Kubernetes with persistent volumes for appropriate cryptographic protections.
SC-39	Process Isolation	Tanzu Application Platform	Tanzu Application Platform container OS enforces the use of separate execution domains for each executing process and cannot be configured otherwise. The underlying Kubernetes host isolates each container from the other.
SI-2c	Flaw Remediation	Tanzu Application Platform	The customer is responsible for keeping the Tanzu Application Platform installation up to date, to within org-defined standards. Tanzu Application Platform does not automatically update itself.
SI-3(2)	Automatic Updates	N/A	Tanzu Application Platform does not include malicious code protection mechanisms therefore automatic update to such mechanisms does not apply.
SI-7(1)	Integrity Checks	Tanzu Application Platform	Tanzu Application Platform performs a hash check when images are downloaded, and a cryptographic signature validation at runtime. This cannot be configured otherwise.
SI-10	Information Input Validation	Tanzu Application Platform	Tanzu Application Platform is responsible for performing input validation of user-supplied input to Tanzu Application Platform.
SI-11 SI-11a SI-11b	Error Handling	Tanzu Application Platform	Tanzu Application Platform limits error message verbosity but does display errors to users. Given the development/coding nature of Tanzu Application Platform, deployment errors and similar must be raised to the user so they can be corrected.
SI-16	Memory Protection	Tanzu Application Platform	Tanzu Application Platform container OS protects its memory from unauthorized code execution and cannot be configured otherwise. The underlying Kubernetes host also isolates container memory pages.

Harden Tanzu Application Platform

This topic provides you with installation and configuration guidance for Tanzu Application Platform (commonly known as TAP) to comply with the NIST 800-53 Security and Privacy Controls for Information Systems and Organizations.

Objective

This is not a comprehensive security guide, but rather, an abbreviated Tanzu Application Platform readiness outline with considerations for hardening Tanzu Application Platform with [800-53](#) controls as a guide.

Configuring your Tanzu Application Platform installation to this standard does not guarantee approval given there are multiple organizational requirements and deviations that a platform team may make during installation and configuration.

Scope

The document will focus on the hardening on the Tanzu Application Platform. This platform is deployed to Kubernetes and as such, relies on the Kubernetes platform being hardened in a shared responsibility model with the Tanzu Application Platform. This guide will provide instruction on Kubernetes based hardening configurations that are required for the Tanzu Application Platform, however, it should not be viewed as a hardening guide for Kubernetes as well.

For hardening Kubernetes, refer to Kubernetes specific hardening guides such as:

- [NSA/CISA Kubernetes Hardening Guide](#): Published in Aug 2022, this is a prescriptive document that covers many areas related to Kubernetes security.
- [NIST Kubernetes STIG Checklist](#): Published in April 2021, provides a prescriptive a list of technical requirements for securing a basic Kubernetes platform.
- [CIS Kubernetes Benchmark](#): Widely used as a secure configuration guide, last updated in June 2021.

Identity and Access Management

In order to provide an audit trail of what a user does in a system, it is important to configure the Tanzu Application Platform so that the identity for a given user is known. When installing and configuring the Tanzu Application Platform, there are several areas where user identity configuration should be considered. Currently the Tanzu Application Platform has three different areas where users have identities.

1. Tanzu Developer Portal (formerly named Tanzu Application Platform GUI)
2. Tanzu Developer Portal Authentication to Remote Clusters
3. The Kubernetes cluster that the Tanzu Application Platform components are installed on

It is recommended to use the same identity provider for each of these components so that a common identity is shared across the entire Tanzu Application Platform. To facilitate this, components are able to use common OIDC providers. Below is the configuration for each component:

Tanzu Developer Portal

The Tanzu Developer Portal is based on the Backstage open source project and has a variety of OIDC providers that you are able to configure as an identity provider.

In order to configure authentication for the Tanzu Developer Portal, VMware suggests the following:

1. Enable user authentication using one of the [supported providers](#). Note that due to the limitations with the backstage authentication implementation, simply having authentication does **not guarantee full end-to-end security** as Backstage doesn't currently support per-API authentication. VMware recommends implementing additional security either via an inbound proxy or via networking (firewall / VPN).

2. It is recommended to disable guest access via the `tap_gui` section in the `tap-values.yaml`.

```
tap_gui:
  app_config:
    auth:
      allowGuestAccess: false
```

Tanzu Developer Portal to Remote Kubernetes Cluster Authentication

Several plugins within the Tanzu Developer Portal, such as the Runtime Resource Viewer, Supply Chain Visualization, and Security Analysis GUI require authentication to remote Kubernetes clusters to query Kubernetes resources.

To do so, the plugins must authenticate to the Kubernetes API on remote clusters. This authentication can be configured in two ways: a shared Kubernetes service account that all users will use to authenticate to remote clusters, and by setting up an authentication provider for the remote cluster. As best security practice, VMware recommends setting up a remote authentication provider for the Kubernetes cluster.

For more information, see [Update Tanzu Developer Portal to view resources on multiple clusters](#).

As best practice, the users on the Kubernetes clusters that are used for remote authentication should be assigned to Kubernetes roles that limit access in a least privilege model. More information about Kubernetes roles provider out of box can be found in the next section.

Kubernetes Cluster Authentication and Authorization

Although not a Tanzu Application Platform configuration, VMware recommends enabling authentication to the Kubernetes clusters where the Tanzu Application Platform components are installed, using the same identity provider that other components are using.

While there are many options on how to enable OIDC providers for authentication with the Kubernetes API, VMware supports the [Pinniped project](#) and has [documented](#) the process of setting it up as part of the Tanzu Application Platform documentation.

By configuring this to use the same identify provider as the Tanzu Developer Portal, users can have a common identity across the Kubernetes clusters and the Tanzu Developer Portal. Because the Tanzu CLI is making Kubernetes API calls, this configuration will also be enabled for the Tanzu CLI.

Using Pinniped will provide authentication for Kubernetes clusters but still requires the users to be bound to Kubernetes roles. To provide a starting point, the Tanzu Application Platform provides six Kubernetes Roles as part of the installation that users can be bound to. For more information around the roles used for authorization, see [Default roles for Tanzu Application Platform](#).

Cryptographic Protections

Encryption of data is leveraged to prevent unauthorized access to data. With the Tanzu Application Platform, this protection focuses on the two primary states of data that should be encrypted:

1. Encryption of Data in Transit
2. Encryption of Data at Rest

Encryption of Data in Transit

Internal Communication of Data in Transit Configuration

Communication between services that originate and terminate within the cluster is referred to as internal communication. Tanzu Application Platform is in the process of enabling TLS on internal communication for components.

If you require encrypted internal communication, there are three remediating options:

1. Enable Tanzu Service Mesh, which provides mutual TLS between components. For more information, see [Set up Tanzu Service Mesh](#).
2. Configure Kubernetes to encrypt all communication with a Container Networking Interface (CNI) that supports traffic encryption, for example, [Antrea](#).
3. Use the underlying network infrastructure running Kubernetes which has encryption on all network traffic.

External Communication of Data in Transit Configuration

Based upon OSS doc: <https://projectcontour.io/docs/v1.22.1/configuration/#tls-configuration>

TLS enables encryption of communication from end-users to the cluster. Since Contour is the edge gateway for all the traffic ingressing into the cluster, it is an easy spot to set up TLS and ensure that all communications between users and the cluster are encrypted.

It also allows cluster owners to satisfy compliance requirements like NIST 800-53 Control [SC-8](#) where it is required to protect the confidentiality of transmitted information.

Moreover, it may be required that certain cipher suites and/or TLS versions are used when encrypting communications. [NIST 800-52r2](#) requires all government-only applications shall use TLS 1.2 and should be configured to use TLS 1.3 as well.

Configuring TLS for Contour

In order to configure Contour to use TLS according to the NIST 800-52r2 requirements you need to create a new section in your `tap-values.yaml` file like:

```
...
contour:
  * existing stuff, probably already there if you're following tap docs
  envoy:
    service:
      type: LoadBalancer # This is set by default, but can be overridden by setting a
different value.
  * new stuff
  contour:
    configFileContents:
      tls:
        minimum-protocol-version: "1.2"
        cipher-suites:
          - '[ECDHE-ECDSA-AES128-GCM-SHA256|ECDHE-ECDSA-CHACHA20-POLY1305]'
          - '[ECDHE-RSA-AES128-GCM-SHA256|ECDHE-RSA-CHACHA20-POLY1305]'
          - 'ECDHE-ECDSA-AES256-GCM-SHA384'
          - 'ECDHE-RSA-AES256-GCM-SHA384'
```

After adding this section, apply the tap-values file and that will change the configuration of TLS to match the requirements.

For more settings in the Contour component, you can reference the [open source documentation](#).

Ingress Certificates

For information about to configure TLS for a Tanzu Application Platform installation's ingress endpoints, see [Ingress certificates](#).

Encryption of Data At Rest

All data should be encrypted at rest. The Tanzu Application Platform runs on Kubernetes and verifies the default storage class configured on the Kubernetes cluster. If you require Encryption of Data at Rest (DARE), you must provide a Persistent Volume Provisioner that supports encryption to the Kubernetes infrastructure.

- Persistent Volume claim encryption
- Data at rest should be encrypted.

Ports and Protocols

Ports are used in TCP and UDP protocols for identification of applications. While some applications use common port numbers, such as 80 for HTTP, or 443 for HTTPS, some applications use dynamic ports. An *open port* refers to a port on which a system is accepting communication. An open port does not always mean that there is a security issue, but it can provide a pathway for attackers listening on that port. To help understand the traffic flows in Tanzu Application Platform, VMware provides a list of Tanzu Application Platform ports and protocols on request.

See the [TAP Architecture Overview](#).

Networking

Ensure that workloads only expose internal-only routes.

All traffic should go through Contour and LoadBalancer without utilizing NodePort [services](#).

Tanzu Application Platform is supported by [Tanzu Service Mesh](#).

You must configure proper [affinity rules](#) on Knative deployed services. For more information, see [Install Tanzu Application Platform in an air-gapped environment](#).

Key Management

Key management is the foundation of all data security. Data is encrypted and decrypted with encryption keys or secrets that must be safely stored to prevent the loss or compromise of infrastructure, systems, and applications. Tanzu Application Platform values are secrets and must be protected to ensure that the security and integrity of the platform is maintained.

- Tanzu Application Platform stores all sensitive values as [Kubernetes Secrets](#)
- Encryption of secrets at rest are Kubernetes Distribution Dependent.
- If customers desire to store secrets in a Secret Management service (e.g. [Hashicorp Vault](#), [Google Secrets Manager](#), [Amazon Secrets Manager](#), [Microsoft Azure Key Vault](#)) they can make use of the [External Secrets Operator](#) to automate the lifecycle management (ALPHA).
- 800-53 [Section AC-23](#) related to safeguarding of sensitive information from exploitation, for example, Tanzu Application Platform values.

Logging

Log files provide an audit trail to monitor activity within infrastructure. Use log files to identify policy violations, unusual activity, and security incidents. It is vital that logs are captured and retained according to the policies set forth by your organization's security team or governing body. Tanzu Application Platform components run as pods on the Kubernetes infrastructure and all components output is captured as part of the pod logs.

All Tanzu Application Platform components follow [Kubernetes Logging](#) best practices. Log aggregation should be implemented following the best practices of the organization log retention process.

- 800-53 Section [AU-4 Audit Log Storage Capacity](#)

Deployment Architecture

Tanzu Application Platform provides a [reference architecture](#) that depicts separate components based on function. VMware recommends multiple Kubernetes clusters for the iterate, build, view, and run functions. This separation enables Kubernetes administrators to manage each function independently and therefore, protect the availability and performance of the platform during high usage periods, for example, building or scanning.

Overview of multicluster Tanzu Application Platform

You can install Tanzu Application Platform (commonly known as TAP) in various topologies to reflect your existing landscape. VMware has tested and recommends a multicluster topology for production use. Because flexibility and choice are core to Tanzu Application Platform’s design, none of the implementation recommendations are set in stone.

The multicluster topology uses the [profile capabilities](#) supported by Tanzu Application Platform. Each cluster adopts one of following multicluster-aligned profiles:

- **Iterate:** Intended for inner-loop iterative application development.
- **Build:** Transforms source revisions to workload revisions; specifically, hosting workloads and supply chains.
- **Run:** Transforms workload revisions to running pods; specifically, hosting deliveries and deliverables.
- **View:** For applications related to centralized developer experiences; specifically, Tanzu Developer Portal (formerly named Tanzu Application Platform GUI) and metadata store.

The following diagram illustrates this topology.

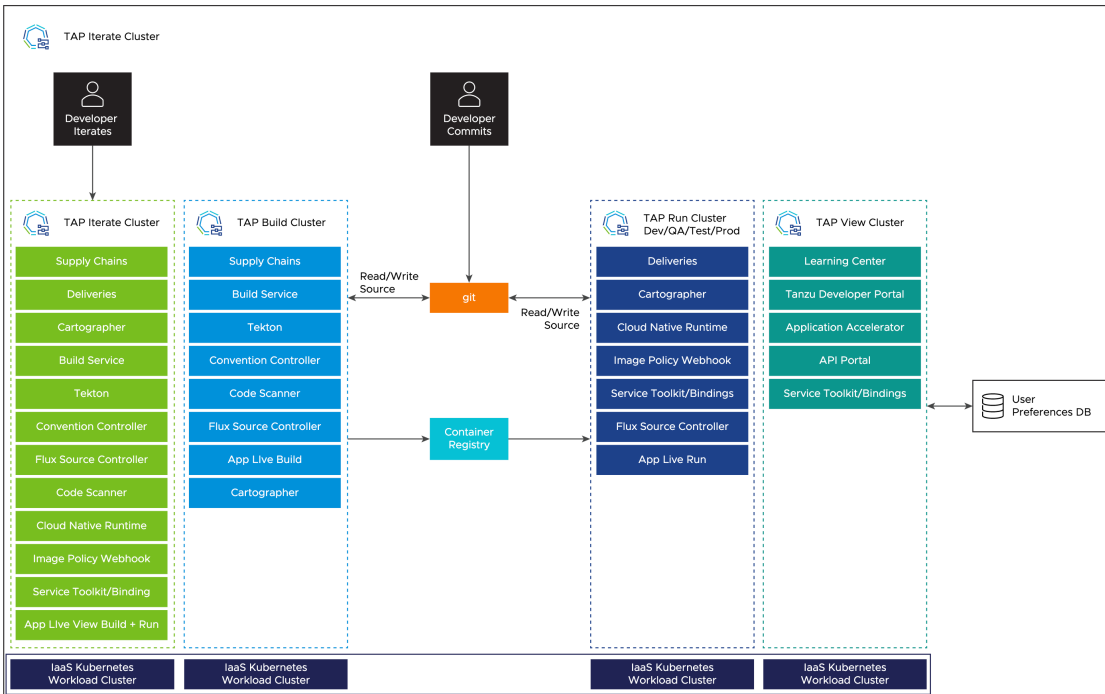

Next steps

To get started with installing a multicluster topology, see [Install multicluster Tanzu Application Platform profiles](#).

Overview of multicluster Tanzu Application Platform

You can install Tanzu Application Platform (commonly known as TAP) in various topologies to reflect your existing landscape. VMware has tested and recommends a multicluster topology for production use. Because flexibility and choice are core to Tanzu Application Platform’s design, none of the implementation recommendations are set in stone.

The multicluster topology uses the [profile capabilities](#) supported by Tanzu Application Platform. Each cluster adopts one of following multicluster-aligned profiles:

- **Iterate:** Intended for inner-loop iterative application development.
- **Build:** Transforms source revisions to workload revisions; specifically, hosting workloads and supply chains.
- **Run:** Transforms workload revisions to running pods; specifically, hosting deliveries and deliverables.
- **View:** For applications related to centralized developer experiences; specifically, Tanzu Developer Portal (formerly named Tanzu Application Platform GUI) and metadata store.

The following diagram illustrates this topology.

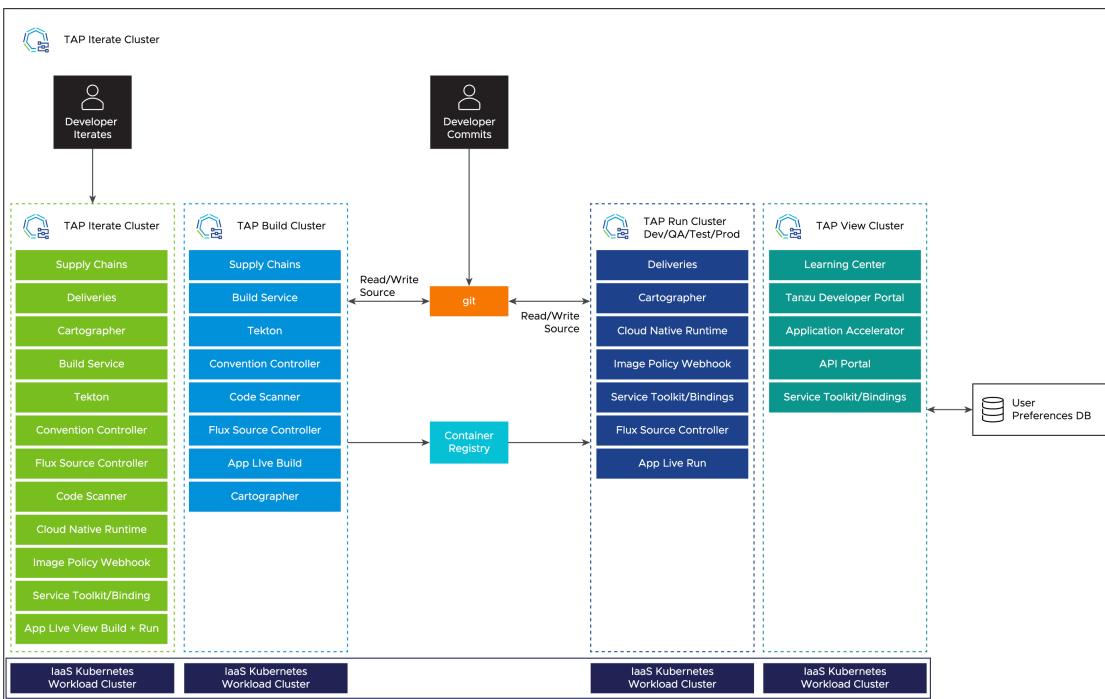

Next steps

To get started with installing a multicluster topology, see [Install multicluster Tanzu Application Platform profiles](#).

Install multicluster Tanzu Application Platform profiles

This topic tells you how to install a multicluster topology for your Tanzu Application Platform (commonly known as TAP).

Prerequisites

Before installing multicluster Tanzu Application Platform profiles, you must meet the following prerequisites:

- All clusters must satisfy all the requirements to install Tanzu Application Platform. See [Prerequisites](#).
- [Install the Tanzu CLI](#) with any required plug-ins.
- [Install Cluster Essentials](#) on all clusters.

Multicluster Installation Order of Operations

The installation order is flexible given the ability to update the installation with a modified values file using the `tanzu package installed update` command. The following is an example of the order of operations to be used:

1. [Install View profile cluster](#).
2. [Install Build profile cluster](#).
3. [Install Run profile cluster](#).
4. [Install Iterate profile cluster](#).
5. [Add Build, Run and Iterate clusters to Tanzu Developer Portal](#).
6. Update the View cluster's installation values file with the previous information and run the following command to pass the updated config values to Tanzu Developer Portal (formerly named Tanzu Application Platform GUI):

```
tanzu package installed update tap -p tap.tanzu.vmware.com -v TAP-VERSION --values-file tap-values.yaml -n tap-install
```

Where `TAP-VERSION` is the Tanzu Application Platform version you've installed.

Install View cluster

Install the View profile cluster first, because some components must exist before installing the Run clusters. For example, the Application Live View back end must be present before installing the Run clusters. For more information about profiles, see [About Tanzu Application Platform package profiles](#).

To install the View cluster:

1. Follow the steps described in [Installing the Tanzu Application Platform package and profiles](#) by using a reduced values file as shown in [View profile](#).
2. Verify that you can access Tanzu Developer Portal by using the ingress that you set up. The address must follow this format: `https://tap-gui.INGRESS-DOMAIN`, where `INGRESS-DOMAIN` is the DNS domain you set in `shared.ingress_domain` which points to the shared Contour installation in the `tanzu-system-ingress` namespace with the service `envoy`.
3. Deploy Supply Chain Security Tools (SCST) - Store. See [Multicluster setup](#) for more information.

Install Build clusters

To install the Build profile cluster, follow the steps described in [Installing the Tanzu Application Platform package and profiles](#) by using a reduced values file as shown in [Build profile](#).

Install Run clusters

To install the Run profile cluster:

1. Follow the steps described in [Install the Tanzu Application Platform package and profiles](#) by using a reduced values file as shown in [Run profile](#).
2. To use Application Live View, set the `INGRESS-DOMAIN` for `appliveview_connector` to match the value you set on the View profile for the `appliveview` in the values file.



Note

The default configuration of `shared.ingress_domain` points to the local Run cluster, rather than the View cluster, as a result, `shared.ingress_domain` must be set explicitly.

Install Iterate clusters

To install the Iterate profile cluster, follow the steps described in [Install the Tanzu Application Platform package and profiles](#) by using a reduced values file as shown in [Iterate profile](#).

Add Build, Run and Iterate clusters to Tanzu Developer Portal

After installing the Build, Run and Iterate clusters, follow the steps in [View resources on multiple clusters in Tanzu Developer Portal](#) to:

1. Create the `Service Accounts` that Tanzu Developer Portal uses to read objects from the clusters.
2. Add a remote cluster.

These steps create the necessary RBAC elements allowing you to pull the URL and token from the Build, Run and Iterate clusters that allows them come back and add to the View cluster's values file.

You must add the Build, Run and Iterate clusters to the View cluster for all plug-ins to function as expected.

Next steps

After setting up the four profiles, you're ready to run a workload by using the supply chain. See [Get started with multicluster Tanzu Application Platform](#).

Get started with multicluster Tanzu Application Platform

This topic tells you how to validate the implementation of a multicluster topology by taking a sample workload and passing it by using the supply chains on the Build and Run clusters.

Use this topic to build an application on the Build profile clusters and run the application on the Run profile clusters.

You can view the workload and associated objects from Tanzu Developer Portal (formerly named Tanzu Application Platform GUI) interface on the View profile cluster.

You can take various approaches to configuring the supply chain in this topology, but the following procedures validate the most basic capabilities.

Prerequisites

Before implementing a multicluster topology, complete the following:

1. Complete all [installation steps for the four profiles](#): Build, Run, View and Iterate.
2. For the sample workload, VMware uses the same Application Accelerator - Tanzu Java Web App in the non-multicluster [Get Started](#) guide. You can download this accelerator to your own Git infrastructure of choice. You might need to configure additional permissions. Alternatively, you can also use the [application-accelerator-samples GitHub repository](#).
3. The two supply chains are `ootb-supply-chain-basic` on the Build/Iterate profile and `ootb-delivery-basic` on the Run profile. For the Build/Iterate and Run profiled clusters, perform the steps described in [Setup Developer Namespace](#). This guide assumes that you use the `default` namespace.
4. To set the value of `DEVELOPER_NAMESPACE` to the namespace you setup in the previous step, run:

```
export DEVELOPER_NAMESPACE=YOUR-DEVELOPER-NAMESPACE
```

Where:

- o `YOUR-DEVELOPER-NAMESPACE` is the namespace you set up in [Set up developer namespaces to use your installed packages](#). `default` is used in this example.

Start the workload on the Build profile cluster

The Build cluster starts by building the necessary bundle for the workload that is delivered to the Run cluster.

1. Use the Tanzu CLI to start the workload down the first supply chain:

```
tanzu apps workload create tanzu-java-web-app \
--git-repo https://github.com/vmware-tanzu/application-accelerator-samples \
--sub-path tanzu-java-web-app \
--git-branch main \
--type web \
--label app.kubernetes.io/part-of=tanzu-java-web-app \
--yes \
--namespace ${DEVELOPER_NAMESPACE}
```

2. To monitor the progress of this process, run:

```
tanzu apps workload tail tanzu-java-web-app --since 10m --timestamp --namespace
${DEVELOPER_NAMESPACE}
```

3. To exit the monitoring session, press **CTRL + C**.
4. Verify that your supply chain has produced the necessary `ConfigMap` containing `Deliverable` content produced by the `Workload`:

```
kubectl get configmap tanzu-java-web-app-deliverable --namespace ${DEVELOPER_NAMESPACE} -o go-template='{{.data.deliverable}}'
```

The output resembles the following:

```
apiVersion: carto.run/v1alpha1
kind: Deliverable
metadata:
  name: tanzu-java-web-app-deliverable
  labels:
    apis.apps.tanzu.vmware.com/register-api: "true"
    app.kubernetes.io/part-of: tanzu-java-web-app
    apps.tanzu.vmware.com/workload-type: web
```

```

app.kubernetes.io/component: deliverable
app.tanzu.vmware.com/deliverable-type: web
spec:
  params:
  - name: gitops_ssh_secret
    value: ""
  source:
    git:
      url: http://git-server.default.svc.cluster.local/app-namespace/tanzu-java
- web-app
  ref:
    branch: main

```

5. Store the `Deliverable` content, which you can take to the Run profile clusters from the `ConfigMap` by running:

```

kubectl get configmap tanzu-java-web-app-deliverable -n ${DEVELOPER_NAMESPACE}
-o go-template='{{.data.deliverable}}' > deliverable.yaml

```

6. Take this `Deliverable` file to the Run profile clusters by running:

```

kubectl apply -f deliverable.yaml --namespace ${DEVELOPER_NAMESPACE}

```

7. Verify that this `Deliverable` is started and `Ready` by running:

```

kubectl get deliverables --namespace ${DEVELOPER_NAMESPACE}

```

The output resembles the following:

```

kubectl get deliverables --namespace default
NAME                SOURCE
DELIVERY            READY  REASON  AGE
tanzu-java-web-app  tapmulticloud.azurecr.io/tap-multi-build-dev/tanzu-java-we
b-app-default-bundle:xxxx-xxxx-xxxx-xxxx-1a7beafd6389  delivery-basic  True
Ready              7m2s

```

8. To test the application, query the URL for the application. Look for the `httpProxy` by running:

```

kubectl get httpproxy --namespace ${DEVELOPER_NAMESPACE}

```

The output resembles the following:

```

kubectl get httpproxy --namespace default
NAME                STATUS  STATUS DESCRIPTION  FQDN
tanzu-java-web-app-contour-a98df54e3629c5ae9c82a395501ee1fdtanz  tanzu-java-we
b-app.default.svc.cluster.local  valid  Valid HTTP
proxy
tanzu-java-web-app-contour-e1d997a9ff9e7dfb6c22087e0ce6fd7ftanz  tanzu-java-we
b-app.default.apps.run.multi.kaplegate.com  valid  Valid HTTP
proxy
tanzu-java-web-app-contour-tanzu-java-web-app.default  tanzu-java-we
b-app.default  valid  Valid HTTP
proxy
tanzu-java-web-app-contour-tanzu-java-web-app.default.svc  tanzu-java-we
b-app.default.svc  valid  Valid HTTP
proxy

```

Select the URL that corresponds to the domain you specified in your Run cluster's profile and enter it into a browser. Expect to see the message "Greetings from Spring Boot + Tanzu!".

- View the component in Tanzu Developer Portal, by following [these steps](#) and using the [catalog file](#) from the sample accelerator in GitHub.

Install Tanzu Application Platform Build profile

This topic tells you how to install Build profile cluster by using a reduced values file.

Prerequisites

Before installing the Build profile, follow all the steps in [Install View cluster](#).

Example values.yaml

The following is the YAML file sample for the build-profile:

```
profile: build
ceip_policy_disclosed: FALSE-OR-TRUE-VALUE # Installation fails if this is not set to
true. Not a string.

shared:
  ingress_domain: "INGRESS-DOMAIN"
  kubernetes_distribution: "openshift" # To be passed only for Openshift. Defaults to
  "".
  kubernetes_version: "K8S-VERSION"
  image_registry:
    project_path: "SERVER-NAME/REPO-NAME" # To be used by Build Service by appending
  "/buildservice" and used by Supply chain by appending "/workloads".
  secret:
    name: "KP-DEFAULT-REPO-SECRET"
    namespace: "KP-DEFAULT-REPO-SECRET-NAMESPACE"
  ca_cert_data: | # To be passed if using custom certificates.
  -----BEGIN CERTIFICATE-----
  MIIFXzCCA0egAwIBAgIJAJYm37SFocjlMA0GCSqGSIb3DQEBDQUAMEY...
  -----END CERTIFICATE-----

# The above shared keys can be overridden in the below section.

buildservice:
# Takes the value from the shared section by default, but can be overridden by setting
a different value.
  kp_default_repository: "KP-DEFAULT-REPO"
  kp_default_repository_secret:
    name: "KP-DEFAULT-REPO-SECRET"
    namespace: "KP-DEFAULT-REPO-SECRET-NAMESPACE"
  supply_chain: testing_scanning
  ootb_supply_chain_testing_scanning: # Optional if the corresponding shared keys are pr
  ovided.
  registry:
    server: "SERVER-NAME"
    repository: "REPO-NAME"
  gitops:
    ssh_secret: "SSH-SECRET-KEY" # (Optional) Defaults to "".
  scanning:
    metadataStore:
      url: "" # Configuration is moved, so set this string to empty.
  tap_telemetry:
    customer_entitlement_account_number: "CUSTOMER-ENTITLEMENT-ACCOUNT-NUMBER" # (Option
  al) Identify data for creating Tanzu Application Platform usage reports.
```



Important

Installing Grype by using `tap-values.yaml` as follows is deprecated in v1.6 and will be removed in v1.8:

```
grype:
  namespace: "MY-DEV-NAMESPACE"
  targetImagePullSecret: "TARGET-REGISTRY-CREDENTIALS-SECRET"
```

You can install Grype by using Namespace Provisioner instead.

Where:

- `K8S-VERSION` is the Kubernetes version used by your OpenShift cluster. It must be in the form of `1.23.x` or `1.24.x`, where `x` stands for the patch version. Examples:
 - Red Hat OpenShift Container Platform v4.10 uses the Kubernetes version `1.23.3`.
 - Red Hat OpenShift Container Platform v4.11 uses the Kubernetes version `1.24.1`.
- `KP-DEFAULT-REPO` is a writable repository in your registry. The Tanzu Build Service dependencies are written to this location. Examples:
 - Harbor has the form `kp_default_repository: "my-harbor.io/my-project/build-service"`
 - Docker Hub has the form `kp_default_repository: "my-dockerhub-user/build-service"` or `kp_default_repository: "index.docker.io/my-user/build-service"`
 - Google Cloud Registry has the form `kp_default_repository: "gcr.io/my-project/build-service"`
 - For Google Cloud Registry, use the contents of the service account JSON file.
- `KP-DEFAULT-REPO-SECRET` is the secret with user credentials that can write to `KP-DEFAULT-REPO`. You can `docker push` to this location with this credential.
 - For Google Cloud Registry, use `kp_default_repository_username: _json_key`.
 - You must create the secret before the installation. For example, you can use the `registry-credentials` secret created earlier.
- `KP-DEFAULT-REPO-SECRET-NAMESPACE` is the namespace where `KP-DEFAULT-REPO-SECRET` is created.
- `SERVER-NAME` is the host name of the registry server. Examples:
 - Harbor has the form `server: "my-harbor.io"`.
 - Docker Hub has the form `server: "index.docker.io"`.
 - Google Cloud Registry has the form `server: "gcr.io"`.
- `REPO-NAME` is where workload images are stored in the registry. Images are written to `SERVER-NAME/REPO-NAME/workload-name`. Examples:
 - Harbor has the form `repository: "my-project/supply-chain"`.
 - Docker Hub has the form `repository: "my-dockerhub-user"`.
 - Google Cloud Registry has the form `repository: "my-project/supply-chain"`.
- `SSH-SECRET-KEY` is the SSH secret key in the developer namespace for the supply chain to fetch source code from and push configuration to. See [Git authentication](#) for more information.
- `METADATA-STORE-URL-ON-VIEW-CLUSTER` is the URL of the Supply Chain Security Tools (SCST) - Store deployed on the View cluster. For example, `https://metadata-store.example.com`. For information about `caSecret` and `store-auth-token`, see [Multicluster setup](#).

- `MY-DEV-NAMESPACE` is the name of the developer namespace. SCST - Scan deploys the `ScanTemplates` there. This allows the scanning feature to run in this namespace.
- `TARGET-REGISTRY-CREDENTIALS-SECRET` is the name of the Secret that contains the credentials to pull an image from the registry for scanning.
- `CUSTOMER-ENTITLEMENT-ACCOUNT-NUMBER` (optional) refers to the Entitlement Account Number (EAN), which is a unique identifier VMware assigns to its customers. Tanzu Application Platform telemetry uses this number to identify data that belongs to a particular customer and prepare usage reports.

When you install Tanzu Application Platform, it is bootstrapped with the `lite` set of dependencies, including buildpacks and stacks, for application builds. For more information about buildpacks, see the [VMware Tanzu Buildpacks Documentation](#). You can find the buildpack and stack artifacts installed with Tanzu Application Platform on the [Broadcom Support Portal](#) under **VMware Tanzu Build Service Dependencies**. You can update the dependencies by [upgrading Tanzu Application Platform](#) to the latest patch.

See [Multicluster setup](#) for more information about the value settings of `grype.metadataStore`.

You must set the `scanning.metadatastore.url` to an empty string if you're installing Grype Scanner v1.2.0 and later or Snyk Scanner to deactivate the embedded SCST - Store integration.

If you use custom CA certificates, you must provide one or more PEM-encoded CA certificates under the `ca_cert_data` key. If you configured `shared.ca_cert_data`, Tanzu Application Platform component packages inherit that value by default.

Install Tanzu Application Platform Run profile

This topic tells you how to install Run profile cluster by using a reduced values file.

The following is the YAML file sample for the run-profile:

```
profile: run
ceip_policy_disclosed: FALSE-OR-TRUE-VALUE # Installation fails if this is not set to
true. Not a string.

shared:
  ingress_domain: INGRESS-DOMAIN
  kubernetes_distribution: "openshift" # To be passed only for Openshift. Defaults to
  "".
  kubernetes_version: "K8S-VERSION"
  ca_cert_data: | # To be passed if using custom certificates.
    -----BEGIN CERTIFICATE-----
    MIIFXzCCA0egAwIBAgIJAjYm37SFocjlMA0GCSqGSIb3DQEBDQUAMEY...
    -----END CERTIFICATE-----
supply_chain: basic

contour:
  envoy:
    service:
      type: LoadBalancer # NodePort can be used if your Kubernetes cluster doesn't sup
port LoadBalancing.

appliveview_connector:
  backend:
    sslDeactivated: TRUE-OR-FALSE-VALUE
    ingressEnabled: true
    host: appliveview.VIEW-CLUSTER-INGRESS-DOMAIN

tap_telemetry:
  customer_entitlement_account_number: "CUSTOMER-ENTITLEMENT-ACCOUNT-NUMBER" # (Option
al) Identify data for creating Tanzu Application Platform usage reports.
```

Where:

- `INGRESS-DOMAIN` is the subdomain for the host name that you point at the `tanzu-shared-ingress` service's external IP address.
- `K8S-VERSION` is the Kubernetes version used by your OpenShift cluster. It must be in the form of `1.23.x` or `1.24.x`, where `x` stands for the patch version. Examples:
 - Red Hat OpenShift Container Platform v4.10 uses the Kubernetes version `1.23.3`.
 - Red Hat OpenShift Container Platform v4.11 uses the Kubernetes version `1.24.1`.
- `VIEW-CLUSTER-INGRESS-DOMAIN` is the subdomain you setup on the View profile cluster. This matches the value key `appliveview.ingressDomain` or `shared.ingress_domain` on the view cluster. Include the default host name `appliveview.` ahead of the domain.
- `CUSTOMER-ENTITLEMENT-ACCOUNT-NUMBER` (optional) refers to the Entitlement Account Number (EAN), which is a unique identifier VMware assigns to its customers. Tanzu Application Platform telemetry uses this number to identify data that belongs to a particular customer and prepare usage reports.

If you use custom CA certificates, you must provide one or more PEM-encoded CA certificates under the `ca_cert_data` key. If you configured `shared.ca_cert_data`, Tanzu Application Platform component packages inherit that value by default.

If you set `shared.ingress_domain` in run profile, the `appliveview_connector.backend.host` is automatically configured as `host: appliveview.INGRESS-DOMAIN`. To override the shared ingress for Application Live View to connect to the view cluster, set the `appliveview_connector.backend.host` key to `appliveview.VIEW-CLUSTER-INGRESS-DOMAIN`.

Install Tanzu Application Platform View profile

This topic tells you how to install View profile cluster by using a reduced values file.

The following is the YAML file sample for the view-profile:

```
profile: view
ceip_policy_disclosed: FALSE-OR-TRUE-VALUE # Installation fails if this is not set to
true. Not a string.

shared:
  ingress_domain: "INGRESS-DOMAIN"
  kubernetes_distribution: "openshift" # To be passed only for Openshift. Defaults to
  "".
  kubernetes_version: "K8S-VERSION"
  ca_cert_data: | # To be passed if using custom certificates.
  -----BEGIN CERTIFICATE-----
  MIIFXzCCA0egAwIBAgIJAjYm37SFocj1MA0GCSqGSIb3DQEBAQUAMEY...
  -----END CERTIFICATE-----

contour:
  envoy:
    service:
      type: LoadBalancer # NodePort can be used if your Kubernetes cluster doesn't sup
port LoadBalancing.

tap_gui:
  app_config:
    auth:
      allowGuestAccess: true # This allows unauthenticated users to log in to your po
rtal. If you want to deactivate it, make sure you configure an alternative auth provid
er.
  catalog:
    locations:
```

```

- type: url
  target: https://GIT-CATALOG-URL/catalog-info.yaml
kubernetes:
  serviceLocatorMethod:
    type: 'multiTenant'
  clusterLocatorMethods:
    - type: 'config'
      clusters:
        - url: CLUSTER-URL
          name: CLUSTER-NAME # Build profile cluster can go here.
          authProvider: serviceAccount
          serviceAccountToken: CLUSTER-TOKEN
          skipTLSVerify: TRUE-OR-FALSE-VALUE
        - url: CLUSTER-URL
          name: CLUSTER-NAME # Run profile cluster can go here.
          authProvider: serviceAccount
          serviceAccountToken: CLUSTER-TOKEN
          skipTLSVerify: TRUE-OR-FALSE-VALUE

appliveview:
  ingressEnabled: true

tap_telemetry:
  customer_entitlement_account_number: "CUSTOMER-ENTITLEMENT-ACCOUNT-NUMBER" # (Optional) Identify data for creating Tanzu Application Platform usage reports.

```

Where:

- `INGRESS-DOMAIN` is the subdomain for the host name that you point at the `tanzu-shared-ingress` service's external IP address.
- `K8S-VERSION` is the Kubernetes version used by your OpenShift cluster. It must be in the form of `1.23.x` or `1.24.x`, where `x` stands for the patch version. Examples:
 - Red Hat OpenShift Container Platform v4.10 uses the Kubernetes version `1.23.3`.
 - Red Hat OpenShift Container Platform v4.11 uses the Kubernetes version `1.24.1`.
- `GIT-CATALOG-URL` is the path to the `catalog-info.yaml` catalog definition file. You can download either a blank or populated catalog file from the [Broadcom Support Portal](#) (file name **Tanzu Application Platform Developer Portal Blank Catalog** or **Tanzu Application Platform Developer Portal Yelb Catalog**). Otherwise, you can use a Backstage-compliant catalog you've already built and posted on the Git infrastructure.
- `CLUSTER-URL`, `CLUSTER-NAME` and `CLUSTER-TOKEN` are described in the [View resources on multiple clusters in Tanzu Developer Portal](#). Observe the [order of operations](#) laid out in the previous steps.
- `CUSTOMER-ENTITLEMENT-ACCOUNT-NUMBER` (optional) refers to the Entitlement Account Number (EAN), which is a unique identifier VMware assigns to its customers. Tanzu Application Platform telemetry uses this number to identify data that belongs to a particular customer and prepare usage reports.

If you use custom CA certificates, you must provide one or more PEM-encoded CA certificates under the `ca_cert_data` key. If you configured `shared.ca_cert_data`, Tanzu Application Platform component packages inherit that value by default.

The `appliveview.ingressEnabled` key is set to `false` by default. In a multicluster setup, `ingressEnabled` key must be set to `true`. If the `shared.ingress_domain` key is set, the Application Live View back end is automatically exposed through the shared ingress.

Install Tanzu Application Platform Iterate profile

This topic tells you how to install Iterate profile cluster by using a reduced values file.

The following is the YAML file sample for the iterate-profile:

```

profile: iterate

shared:
  ingress_domain: "INGRESS-DOMAIN"
  kubernetes_distribution: "openshift" # To be passed only for OpenShift. Defaults to ""
  kubernetes_version: "K8S-VERSION"
  image_registry:
    project_path: "SERVER-NAME/REPO-NAME" # To be used by Build Service by appending
    "/buildservice" and used by Supply chain by appending "/workloads"
    username: "KP-DEFAULT-REPO-USERNAME"
    password: "KP-DEFAULT-REPO-PASSWORD"
  ca_cert_data: | # To be passed if using custom certificates
  -----BEGIN CERTIFICATE-----
  MIIFXzCCA0egAwIBAgIJAJYm37SFocjlMA0GCSqGSIb3DQEjBQUAMEY...
  -----END CERTIFICATE-----

ceip_policy_disclosed: FALSE-OR-TRUE-VALUE # Installation fails if this is not set to
true. Not a string.

# The above shared keys may be overridden in the below section.

buildservice: # Optional if the corresponding shared keys are provided.
  kp_default_repository: "KP-DEFAULT-REPO"
  kp_default_repository_username: "KP-DEFAULT-REPO-USERNAME"
  kp_default_repository_password: "KP-DEFAULT-REPO-PASSWORD"

supply_chain: basic
ootb_supply_chain_basic: # Optional if the shared above mentioned shared keys are prov
ided.
  registry:
    server: "SERVER-NAME"
    repository: "REPO-NAME"
  gitops:
    ssh_secret: "SSH-SECRET-KEY" # (Optional) Defaults to "".

image_policy_webhook:
  allow_unmatched_tags: true

contour:
  envoy:
    service:
      type: LoadBalancer # (Optional) Defaults to LoadBalancer.

cnrs:
  domain_name: "TAP-ITERATE-CNR-DOMAIN" # Optional if the shared.ingress_domain is pro
vided.

appliveview_connector:
  backend:
    sslDeactivated: TRUE-OR-FALSE-VALUE
    ingressEnabled: true
    host: appliveview.VIEW-CLUSTER-INGRESS-DOMAIN

tap_telemetry:
  customer_entitlement_account_number: "CUSTOMER-ENTITLEMENT-ACCOUNT-NUMBER" # (Option
al) Identify data for creating Tanzu Application Platform usage reports.

```

Where:

- `K8S-VERSION` is the Kubernetes version used by your OpenShift cluster. It must be in the form of `1.23.x` or `1.24.x`, where `x` stands for the patch version. Examples:

- o Red Hat OpenShift Container Platform v4.10 uses the Kubernetes version 1.23.3.
 - o Red Hat OpenShift Container Platform v4.11 uses the Kubernetes version 1.24.1.
- `KP-DEFAULT-REPO` is a writable repository in your registry. Tanzu Build Service dependencies are written to this location. Examples:
 - o Harbor has the form `kp_default_repository: "my-harbor.io/my-project/build-service"`.
 - o Docker Hub has the form `kp_default_repository: "my-dockerhub-user/build-service"` Or `kp_default_repository: "index.docker.io/my-user/build-service"`.
 - o Google Cloud Registry has the form `kp_default_repository: "gcr.io/my-project/build-service"`.
- `KP-DEFAULT-REPO-USERNAME` is the user name that can write to `KP-DEFAULT-REPO`. You can `docker push` to this location with this credential.
 - o For Google Cloud Registry, use `kp_default_repository_username: _json_key`.
- `KP-DEFAULT-REPO-PASSWORD` is the password for the user that can write to `KP-DEFAULT-REPO`. You can `docker push` to this location with this credential. This credential can also be configured by using a Secret reference. For more information, see [Install Tanzu Build Service](#) for details.
 - o For Google Cloud Registry, use the contents of the service account JSON file.
- `SERVER-NAME` is the host name of the registry server. Examples:
 - o Harbor has the form `server: "my-harbor.io"`.
 - o Docker Hub has the form `server: "index.docker.io"`.
 - o Google Cloud Registry has the form `server: "gcr.io"`.
- `REPO-NAME` is where workload images are stored in the registry. Images are written to `SERVER-NAME/REPO-NAME/workload-name`. Examples:
 - o Harbor has the form `repository: "my-project/supply-chain"`.
 - o Docker Hub has the form `repository: "my-dockerhub-user"`.
 - o Google Cloud Registry has the form `repository: "my-project/supply-chain"`.
- `SSH-SECRET-KEY` is the SSH secret key in the developer namespace for the supply chain to fetch source code from and push configuration to. See [Git authentication](#) for more information.
- `TAP-ITERATE-CNR-DOMAIN` is the iterate cluster Cloud Native Runtimes domain.
- `VIEW-CLUSTER-INGRESS-DOMAIN` is the subdomain you setup on the View profile cluster. This matches the value key `appliveview.ingressDomain` Or `shared.ingress_domain` on the view cluster. Include the default host name `appliveview.` ahead of the domain.
- `CUSTOMER-ENTITLEMENT-ACCOUNT-NUMBER` (optional) refers to the Entitlement Account Number (EAN), which is a unique identifier VMware assigns to its customers. Tanzu Application Platform telemetry uses this number to identify data that belongs to a particular customers and prepare usage reports.

If you use custom CA certificates, you must provide one or more PEM-encoded CA certificates under the `ca_cert_data` key. If you configured `shared.ca_cert_data`, Tanzu Application Platform component packages inherit that value by default.

If you set `shared.ingress_domain` in the iterate profile, the `appliveview_connector.backend.host` is automatically configured as `host: appliveview.INGRESS-DOMAIN`. To override the shared ingress for Application Live View to connect to the view cluster, set the `appliveview_connector.backend.host` key to `appliveview.VIEW-CLUSTER-INGRESS-DOMAIN`.

Get started with Tanzu Application Platform

Welcome to Tanzu Application Platform (commonly known as TAP). The guides in this section provide hands-on instructions for developers and operators to help you get started on Tanzu Application Platform.

Prerequisites

Before you start, verify you have successfully:

- **Installed Tanzu Application Platform**
See [Installing Tanzu Application Platform](#).
- **Installed Tanzu Application Platform on the target Kubernetes cluster**
See [Installing the Tanzu CLI](#) and [Installing the Tanzu Application Platform Package and Profiles](#).
- **Set the default kubeconfig context to the target Kubernetes cluster**
See [Changing clusters](#).
- **Installed Out of The Box (OOTB) Supply Chain Basic**
See [Install Out of The Box Supply Chain Basic](#). If you used the default profiles provided in [Installing the Tanzu Application Platform Package and Profiles](#), you have already installed the Out of The Box (OOTB) Supply Chain Basic.
- **Installed Tekton Pipelines**
See [Install Tekton Pipelines](#). If you used the default profiles provided in [Installing the Tanzu Application Platform Package and Profiles](#), you have already installed Tekton Pipelines.
- **Set up a developer namespace to accommodate the developer workload**
See [Set up developer namespaces to use your installed packages](#).
- **Installed Tanzu Developer Portal**
See [Install Tanzu Developer Portal](#). If you used the Full or View profiles provided in [Installing the Tanzu Application Platform Package and Profiles](#), you have already installed Tanzu Developer Portal.
- **Installed the VS Code Tanzu Extension**
See [Install the Visual Studio Code Tanzu Extension](#) for instructions.

When you have completed these prerequisites, you are ready to get started.

Next steps

For developers:

- [Create an application accelerator](#)
- [Deploy an app on Tanzu Application Platform](#)
- [Deploy Spring Cloud Applications to Tanzu Application Platform](#)

For operators:

- [Add testing and scanning to your application](#)
- [Configure image signing](#)

Get started with Tanzu Application Platform

Welcome to Tanzu Application Platform (commonly known as TAP). The guides in this section provide hands-on instructions for developers and operators to help you get started on Tanzu Application Platform.

Prerequisites

Before you start, verify you have successfully:

- **Installed Tanzu Application Platform**
See [Installing Tanzu Application Platform](#).
- **Installed Tanzu Application Platform on the target Kubernetes cluster**
See [Installing the Tanzu CLI](#) and [Installing the Tanzu Application Platform Package and Profiles](#).
- **Set the default kubeconfig context to the target Kubernetes cluster**
See [Changing clusters](#).
- **Installed Out of The Box (OOTB) Supply Chain Basic**
See [Install Out of The Box Supply Chain Basic](#). If you used the default profiles provided in [Installing the Tanzu Application Platform Package and Profiles](#), you have already installed the Out of The Box (OOTB) Supply Chain Basic.
- **Installed Tekton Pipelines**
See [Install Tekton Pipelines](#). If you used the default profiles provided in [Installing the Tanzu Application Platform Package and Profiles](#), you have already installed Tekton Pipelines.
- **Set up a developer namespace to accommodate the developer workload**
See [Set up developer namespaces to use your installed packages](#).
- **Installed Tanzu Developer Portal**
See [Install Tanzu Developer Portal](#). If you used the Full or View profiles provided in [Installing the Tanzu Application Platform Package and Profiles](#), you have already installed Tanzu Developer Portal.
- **Installed the VS Code Tanzu Extension**
See [Install the Visual Studio Code Tanzu Extension](#) for instructions.

When you have completed these prerequisites, you are ready to get started.

Next steps

For developers:

- [Create an application accelerator](#)
- [Deploy an app on Tanzu Application Platform](#)
- [Deploy Spring Cloud Applications to Tanzu Application Platform](#)

For operators:

- [Add testing and scanning to your application](#)
- [Configure image signing](#)

Add testing and scanning to your application

This topic guides you through installing the optional OOTB Supply Chain with Testing and the optional OOTB Supply Chain with Testing and Scanning.

For more information about available supply chains, see [Supply chains on Tanzu Application Platform](#).

What you will do

- Install OOTB Supply Chain with Testing.
- Add a Tekton pipeline to the cluster and update the workload to point to the pipeline and resolve errors.
- Install OOTB Supply Chain with Testing and Scanning.
- Update the workload to point to the Tekton pipeline and resolve errors.
- Query for vulnerabilities and dependencies.

Overview

The default Out of the Box (OOTB) Supply Chain Basic and its dependencies were installed on your cluster during the Tanzu Application Platform install. As demonstrated in this guide, you can add testing and security scanning to your application. When you activate OOTB Supply Chain with Testing, it deactivates OOTB Supply Chain Basic.

The following installations also provide a sample Tekton pipeline that tests your sample application. The pipeline is configurable. Therefore, you can customize the steps to perform either additional testing or other tasks with Tekton Pipelines.

Install OOTB Supply Chain with Testing

To install OOTB Supply Chain with Testing:

1. You can activate the OOTB Supply Chain with Testing by updating your profile to use `testing` rather than `basic` as the selected supply chain for workloads in this cluster. The `tap-values.yaml` is the file used to customize the profile in `Tanzu package install tap --values-file=...`. Update `tap-values.yaml` with the following changes:

```
- supply_chain: basic
+ supply_chain: testing

- ootb_supply_chain_basic:
+ ootb_supply_chain_testing:
  registry:
    server: "SERVER-NAME"
    repository: "REPO-NAME"
```

Where:

- `SERVER-NAME` is the name of your server.
 - `REPO-NAME` is the name of the image repository that hosts the container images.
2. Update the installed profile by running:

```
tanzu package installed update tap -p tap.tanzu.vmware.com -v VERSION-NUMBER --
values-file tap-values.yaml -n tap-install
```

Where `VERSION-NUMBER` is your Tanzu Application Platform version. For example, `1.6.13`.

Tekton pipeline config example

In this section, a Tekton pipeline is added to the cluster. In the next section, the workload is updated to point to the pipeline and resolve any current errors.



Note

Developers can perform this step because they know how their application must be tested. The operator can also add the Tekton pipeline to a cluster before the developer gets access.

To add the Tekton pipeline to the cluster, apply the following YAML to the cluster:

```
apiVersion: tekton.dev/v1beta1
kind: Pipeline
metadata:
  name: developer-defined-tekton-pipeline
  namespace: DEVELOPER-NAMESPACE
  labels:
    apps.tanzu.vmware.com/pipeline: test      # (!) required
spec:
  params:
    - name: source-url                        # (!) required
    - name: source-revision                  # (!) required
  tasks:
    - name: test
      params:
        - name: source-url
          value: $(params.source-url)
        - name: source-revision
          value: $(params.source-revision)
      taskSpec:
        params:
          - name: source-url
          - name: source-revision
        steps:
          - name: test
            image: gradle
            script: |-
              cd `mktemp -d`

              wget -qO- $(params.source-url) | tar xvz -m
              ./mvnw test
```

Where `DEVELOPER-NAMESPACE` is the name of your developer namespace.

The preceding YAML puts a Tekton pipeline in the developer namespace you specify. It defines the Tekton pipeline with a single step. The step contained in the `steps` pulls the code from the repository indicated in the developers `workload` and runs the tests within the repository. The steps of the Tekton pipeline are configurable and allow the developer to add additional items needed to test their code.

There are many steps in the supply chain. In this case, the next step is an image build. Any additional steps the developer adds to the Tekton pipeline to test their code are independent of the image being built and of any subsequent steps executed in the supply chain. This independence gives the developer freedom to focus on testing their code.

The `params` are templated by Supply Chain Choreographer. Additionally, Tekton pipelines require a Tekton `pipelineRun` to execute on the cluster. Supply Chain Choreographer handles creating the

`pipelineRun` dynamically each time that step of the supply chain requires execution.

Workload update

To connect the new supply chain to the workload, the workload must be updated to point at your Tekton pipeline.

1. Update the workload by running the following with the Tanzu CLI:

```
tanzu apps workload apply tanzu-java-web-app \
  --git-repo https://github.com/vmware-tanzu/application-accelerator-samples \
  --sub-path tanzu-java-web-app \
  --git-branch main \
  --type web \
  --label apps.tanzu.vmware.com/has-tests=true \
  --label app.kubernetes.io/part-of=tanzu-java-web-app \
  --yes
```

2. After accepting the workload creation, monitor the creation of new resources by the workload by running:

```
kubectl get workload,gitrepository,pipelinerun,images.kpack,podintent,app,services.serving
```

The result is output similar to the following example that shows the objects created by Supply Chain Choreographer:

```
NAME                                     AGE
workload.carto.run/tanzu-java-web-app    109s

NAME                                     URL                                     AGE
READY   STATUS
gitrepository.source.toolkit.fluxcd.io/tanzu-java-web-app  https://github.com/vmware-tanzu/application-accelerator-samples  True   Fetched revision: main/872ff44c8866b7805fb2425130edb69a9853bdfd  109s

NAME                                     SUCCEEDED REASON   START
TIME   COMPLETIONTIME
pipelinerun.tekton.dev/tanzu-java-web-app-4ft1b  True       Succeeded  104s77s

NAME                                     LATESTIMAGE
READY
image.kpack.io/tanzu-java-web-app  10.188.0.3:5000/foo/tanzu-java-web-app@sha256:1d5bc4d3d1ffeb8629fbb721fcd1c4d28b896546e005f1efd98fbc4e79b7552c  True

NAME                                     READY   REASON
AGE
podintent.conventions.carto.run/tanzu-java-web-app  True       7s

NAME                                     DESCRIPTION   SINCE-DEPLOY
AGE
app.kappctrl.k14s.io/tanzu-java-web-app  Reconcile succeeded  1s2s

NAME                                     URL
LATESTCREATED   LATESTREADY   READY   REASON
service.serving.knative.dev/tanzu-java-web-app  http://tanzu-java-web-app.developer.example.com  tanzu-java-web-app-00001  tanzu-java-web-app-00001  Unknown  IngressNotConfigured
```

Install OOTB Supply Chain with Testing and Scanning

To install OOTB Supply Chain with Testing and Scanning, you must install the Scan Controller and the Grype scanner.

Leveraging both Grype and Tanzu Build Service in your Tanzu Application Platform supply chain enables enhanced scanning coverage for languages and frameworks. For the languages and frameworks supported, see the *Extended Scanning Coverage using Anchore Grype* column in the [Language and Framework Support Table](#).

To install OOTB Supply Chain with Testing and Scanning:



Note

The OOTB Supply Chain with Testing and Scanning capability has been changed to opt-in and is skipped by default starting in Tanzu Application Platform v1.6. For more information, see [Scan Types](#).

1. Supply Chain Security Tools (SCST) - Scan is installed as part of the Tanzu Application Platform profiles. Verify that both Scan Controller and Grype Scanner are installed by running:

```
tanzu package installed get scanning -n tap-install
tanzu package installed get grype -n tap-install
```

If the packages are not already installed, follow the steps in [Supply Chain Security Tools - Scan](#) to install the required scanning components.

During installation of the Grype Scanner, sample ScanTemplates are installed into the `default` namespace. If the workload is deployed into another namespace, you must also install these sample ScanTemplates in the other namespace. One way to accomplish this is to install Grype Scanner again and provide the namespace in the values file.

2. Apply a ScanPolicy in the required namespace. The sample ScanPolicy provided in this step is configured with `notAllowedSeverities := ["Critical", "High", "UnknownSeverity"]`. This blocks a supply chain when the scanner finds CVEs with critical, high, and unknown ratings.

You can also configure the supply chain to use your own custom policies and apply exceptions when you want to ignore certain CVEs. See [Out of the Box Supply Chain with Testing and Scanning](#). To apply the sample ScanPolicy, you can either add the namespace flag to the kubectl command or add the namespace field to the template by running:

```
kubectl apply -f - -o yaml << EOF
---
apiVersion: scanning.apps.tanzu.vmware.com/v1beta1
kind: ScanPolicy
metadata:
  name: scan-policy
  labels:
    'app.kubernetes.io/part-of': 'enable-in-gui'
spec:
  regoFile: |
    package main

    # Accepted Values: "Critical", "High", "Medium", "Low", "Negligible", "Unkn
ownSeverity"
    notAllowedSeverities := ["Critical", "High", "UnknownSeverity"]
    ignoreCves := []

    contains(array, elem) = true {
      array[_] = elem
    } else = false { true }
```

```

    isSafe(match) {
      severities := { e | e := match.ratings.rating.severity } | { e | e := mat
ch.ratings.rating[_].severity }
      some i
      fails := contains(notAllowedSeverities, severities[i])
      not fails
    }

    isSafe(match) {
      ignore := contains(ignoreCves, match.id)
      ignore
    }

    deny[msg] {
      comps := { e | e := input.bom.components.component } | { e | e := input.b
om.components.component[_] }
      some i
      comp := comps[i]
      vulns := { e | e := comp.vulnerabilities.vulnerability } | { e | e := com
p.vulnerabilities.vulnerability[_] }
      some j
      vuln := vulns[j]
      ratings := { e | e := vuln.ratings.rating.severity } | { e | e := vuln.ra
tings.rating[_].severity }
      not isSafe(vuln)
      msg = sprintf("CVE %s %s %s", [comp.name, vuln.id, ratings])
    }
  EOF

```

- (optional) The Tanzu Application Platform profiles install the [Supply Chain Security Tools - Store](#) package by default. To persist and query the vulnerability results post-scan, confirm it is installed by running:

```
tanzu package installed get metadata-store -n tap-install
```

If the package is not installed, follow the installation instructions at [Install Supply Chain Security Tools - Store independent from Tanzu Application Platform profiles](#).

- Update the profile to use the supply chain with testing and scanning by updating `tap-values.yaml` (the file used to customize the profile in `tanzu package install tap --values-file=...`) with the following changes:

```

- supply_chain: testing
+ supply_chain: testing_scanning

- ootb_supply_chain_testing:
+ ootb_supply_chain_testing_scanning:
  registry:
    server: "<SERVER-NAME>"
    repository: "<REPO-NAME>"

```

- Update the `tap` package:

```
tanzu package installed update tap -p tap.tanzu.vmware.com -v VERSION-NUMBER --values-file tap-values.yaml -n tap-install
```

Where `VERSION-NUMBER` is your Tanzu Application Platform version. For example, `1.6.13`.

Workload update

To connect the new supply chain to the workload, update the workload to point to your Tekton pipeline:

1. Update the workload by running the following using the Tanzu CLI:

```
tanzu apps workload apply tanzu-java-web-app \
  --git-repo https://github.com/vmware-tanzu/application-accelerator-samples \
  --sub-path tanzu-java-web-app \
  --git-branch main \
  --type web \
  --label apps.tanzu.vmware.com/has-tests=true \
  --label app.kubernetes.io/part-of=tanzu-java-web-app \
  --yes
```

2. After accepting the workload creation, view the new resources that the workload created by running:

```
kubectl get workload,gitrepository,sourcecan,pipelinerun,images.kpack,imagescan,podintents,app,services.serving
```

The following is an example output, which shows the objects that Supply Chain Choreographer created:

```
NAME                                         AGE
workload.carto.run/tanzu-java-web-app      109s

NAME                                         URL
READY STATUS
gitrepository.source.toolkit.fluxcd.io/tanzu-java-web-app https://github.com/vmware-tanzu/application-accelerator-samples True Fetched revision: main/872ff44c8866b7805fb2425130edb69a9853bfdf 109s

NAME                                         PHASE    SCAN
NEDREVISION                                SCANNEDREPOSITORY
AGE CRITICAL HIGH MEDIUM LOW UNKNOWN CVETOTAL
sourcecan.scanning.apps.tanzu.vmware.com/tanzu-java-web-app Completed 1878
50b39b754e425621340787932759a0838795 https://github.com/vmware-tanzu/application-accelerator-samples 90s

NAME                                         SUCCEEDED REASON    START
TIME COMPLETIONTIME
pipelinerun.tekton.dev/tanzu-java-web-app-4ftlb True       Succeeded 104s
77s

NAME                                         LATESTIMAGE
READY
image.kpack.io/tanzu-java-web-app 10.188.0.3:5000/foo/tanzu-java-web-app@sha256:1d5bc4d3d1ffeb8629fbb721fcd1c4d28b896546e005f1efd98fbc4e79b7552c True

NAME                                         PHASE    SCANN
EDIMAGE
AGE CRITICAL HIGH MEDIUM LOW UNKNOWN CVETOTAL
imagescan.scanning.apps.tanzu.vmware.com/tanzu-java-web-app Completed 10.18
8.0.3:5000/foo/tanzu-java-web-app@sha256:1d5bc4d3d1ffeb8629fbb721fcd1c4d28b896546e005f1efd98fbc4e79b7552c 14s

NAME                                         READY REASON
AGE
podintents.conventions.carto.run/tanzu-java-web-app True 7s

NAME                                         DESCRIPTION SINCE-DEPLOY
AGE
app.kappctrl.k14s.io/tanzu-java-web-app Reconcile succeeded 1s
2s

NAME                                         URL
LATESTCREATED                                LATESTREADY READY REASON
```

```
service.serving.knative.dev/tanzu-java-web-app http://tanzu-java-web-app.deve
loper.example.com tanzu-java-web-app-00001 tanzu-java-web-app-00001 Unkno
wn IngressNotConfigured
```



Important

If the source or image scan has a “Failed” phase this means that the scan failed due to a scan policy violation and the supply chain stops. For information about the CVE triage workflow, see [Out of the Box Supply Chain with Testing and Scanning](#).

Query for vulnerabilities

Scan reports are automatically saved to the [Supply Chain Security Tools - Store](#), and you can query them for vulnerabilities and dependencies. For example, related to open-source software (OSS) or third-party packages.

Query the tanzu-java-web-app image dependencies and vulnerabilities by running:

```
tanzu insight image get --digest DIGEST
tanzu insight image vulnerabilities --digest DIGEST
```

Where `DIGEST` is the component version or image digest printed in the `KUBECTL GET` command.

For additional information and examples, see [Tanzu Insight plug-in overview](#).

Congratulations! You have successfully added testing and security scanning to your application on the Tanzu Application Platform.

Take the next steps to learn about recommended supply chain security best practices and gain a powerful services journey experience on the Tanzu Application Platform by enabling several advanced use cases.

Next steps

- [Configure image signing and verification in your supply chain](#)

Add testing and scanning to your application

This topic guides you through installing the optional OOTB Supply Chain with Testing and the optional OOTB Supply Chain with Testing and Scanning.

For more information about available supply chains, see [Supply chains on Tanzu Application Platform](#).

What you will do

- Install OOTB Supply Chain with Testing.
- Add a Tekton pipeline to the cluster and update the workload to point to the pipeline and resolve errors.
- Install OOTB Supply Chain with Testing and Scanning.
- Update the workload to point to the Tekton pipeline and resolve errors.
- Query for vulnerabilities and dependencies.

Overview

The default Out of the Box (OOTB) Supply Chain Basic and its dependencies were installed on your cluster during the Tanzu Application Platform install. As demonstrated in this guide, you can add testing and security scanning to your application. When you activate OOTB Supply Chain with Testing, it deactivates OOTB Supply Chain Basic.

The following installations also provide a sample Tekton pipeline that tests your sample application. The pipeline is configurable. Therefore, you can customize the steps to perform either additional testing or other tasks with Tekton Pipelines.

Install OOTB Supply Chain with Testing

To install OOTB Supply Chain with Testing:

1. You can activate the OOTB Supply Chain with Testing by updating your profile to use `testing` rather than `basic` as the selected supply chain for workloads in this cluster. The `tap-values.yaml` is the file used to customize the profile in `Tanzu package install tap --values-file=...`. Update `tap-values.yaml` with the following changes:

```
- supply_chain: basic
+ supply_chain: testing

- ootb_supply_chain_basic:
+ ootb_supply_chain_testing:
  registry:
    server: "SERVER-NAME"
    repository: "REPO-NAME"
```

Where:

- `SERVER-NAME` is the name of your server.
- `REPO-NAME` is the name of the image repository that hosts the container images.

2. Update the installed profile by running:

```
tanzu package installed update tap -p tap.tanzu.vmware.com -v VERSION-NUMBER --
values-file tap-values.yaml -n tap-install
```

Where `VERSION-NUMBER` is your Tanzu Application Platform version. For example, `1.6.13`.

Tekton pipeline config example

In this section, a Tekton pipeline is added to the cluster. In the next section, the workload is updated to point to the pipeline and resolve any current errors.



Note

Developers can perform this step because they know how their application must be tested. The operator can also add the Tekton pipeline to a cluster before the developer gets access.

To add the Tekton pipeline to the cluster, apply the following YAML to the cluster:

```
apiVersion: tekton.dev/v1beta1
kind: Pipeline
metadata:
  name: developer-defined-tekton-pipeline
```

```

namespace: DEVELOPER-NAMESPACE
labels:
  apps.tanzu.vmware.com/pipeline: test      # (!) required
spec:
  params:
    - name: source-url                      # (!) required
    - name: source-revision                 # (!) required
  tasks:
    - name: test
      params:
        - name: source-url
          value: $(params.source-url)
        - name: source-revision
          value: $(params.source-revision)
      taskSpec:
        params:
          - name: source-url
          - name: source-revision
        steps:
          - name: test
            image: gradle
            script: |-
              cd `mktemp -d`

              wget -qO- $(params.source-url) | tar xvz -m
              ./mvnw test

```

Where `DEVELOPER-NAMESPACE` is the name of your developer namespace.

The preceding YAML puts a Tekton pipeline in the developer namespace you specify. It defines the Tekton pipeline with a single step. The step contained in the `steps` pulls the code from the repository indicated in the developers `workload` and runs the tests within the repository. The steps of the Tekton pipeline are configurable and allow the developer to add additional items needed to test their code.

There are many steps in the supply chain. In this case, the next step is an image build. Any additional steps the developer adds to the Tekton pipeline to test their code are independent of the image being built and of any subsequent steps executed in the supply chain. This independence gives the developer freedom to focus on testing their code.

The `params` are templated by Supply Chain Choreographer. Additionally, Tekton pipelines require a Tekton `pipelineRun` to execute on the cluster. Supply Chain Choreographer handles creating the `pipelineRun` dynamically each time that step of the supply chain requires execution.

Workload update

To connect the new supply chain to the workload, the workload must be updated to point at your Tekton pipeline.

1. Update the workload by running the following with the Tanzu CLI:

```

tanzu apps workload apply tanzu-java-web-app \
  --git-repo https://github.com/vmware-tanzu/application-accelerator-samples \
  --sub-path tanzu-java-web-app \
  --git-branch main \
  --type web \
  --label apps.tanzu.vmware.com/has-tests=true \
  --label app.kubernetes.io/part-of=tanzu-java-web-app \
  --yes

```

2. After accepting the workload creation, monitor the creation of new resources by the workload by running:

```
kubectl get workload,gitrepository,pipelinerun,images.kpack,podintent,app,services.serving
```

The result is output similar to the following example that shows the objects created by Supply Chain Choreographer:

```
NAME                                AGE
workload.carto.run/tanzu-java-web-app 109s

NAME                                URL
READY STATUS                        AGE
gitrepository.source.toolkit.fluxcd.io/tanzu-java-web-app https://github.com/vmware-tanzu/application-accelerator-samples
vmware-tanzu/application-accelerator-samples True Fetched revision: main/872ff44c8866b7805fb2425130edb69a9853bdfd 109s

NAME                                SUCCEEDED REASON START TIME COMPLETIONTIME
pipelinerun.tekton.dev/tanzu-java-web-app-4ftlb True Succeeded 104s 77s

NAME                                LATESTIMAGE
READY
image.kpack.io/tanzu-java-web-app 10.188.0.3:5000/foo/tanzu-java-web-app@sha256:1d5bc4d3d1ffeb8629fbb721fcd1c4d28b896546e005f1efd98fbc4e79b7552c True

NAME                                READY REASON
AGE
podintent.conventions.carto.run/tanzu-java-web-app True 7s

NAME                                DESCRIPTION SINCE-DEPLOY
AGE
app.kappctrl.k14s.io/tanzu-java-web-app Reconcile succeeded 1s 2s

NAME                                URL
LATESTCREATED LATESTREADY READY REASON
service.serving.knative.dev/tanzu-java-web-app http://tanzu-java-web-app.developer.example.com tanzu-java-web-app-00001 tanzu-java-web-app-00001 Unknown IngressNotConfigured
```

Install OOTB Supply Chain with Testing and Scanning

To install OOTB Supply Chain with Testing and Scanning, you must install the Scan Controller and the Grype scanner.

Leveraging both Grype and Tanzu Build Service in your Tanzu Application Platform supply chain enables enhanced scanning coverage for languages and frameworks. For the languages and frameworks supported, see the *Extended Scanning Coverage using Anchore Grype* column in the [Language and Framework Support Table](#).

To install OOTB Supply Chain with Testing and Scanning:



Note

The OOTB Supply Chain with Testing and Scanning capability has been changed to opt-in and is skipped by default starting in Tanzu Application Platform v1.6. For more information, see [Scan Types](#).

1. Supply Chain Security Tools (SCST) - Scan is installed as part of the Tanzu Application Platform profiles. Verify that both Scan Controller and Grype Scanner are installed by

running:

```
tanzu package installed get scanning -n tap-install
tanzu package installed get grype -n tap-install
```

If the packages are not already installed, follow the steps in [Supply Chain Security Tools - Scan](#) to install the required scanning components.

During installation of the Grype Scanner, sample ScanTemplates are installed into the `default` namespace. If the workload is deployed into another namespace, you must also install these sample ScanTemplates in the other namespace. One way to accomplish this is to install Grype Scanner again and provide the namespace in the values file.

2. Apply a ScanPolicy in the required namespace. The sample ScanPolicy provided in this step is configured with `notAllowedSeverities := ["Critical","High","UnknownSeverity"]`. This blocks a supply chain when the scanner finds CVEs with critical, high, and unknown ratings.

You can also configure the supply chain to use your own custom policies and apply exceptions when you want to ignore certain CVEs. See [Out of the Box Supply Chain with Testing and Scanning](#). To apply the sample ScanPolicy, you can either add the namespace flag to the kubectl command or add the namespace field to the template by running:

```
kubectl apply -f - -o yaml << EOF
---
apiVersion: scanning.apps.tanzu.vmware.com/v1beta1
kind: ScanPolicy
metadata:
  name: scan-policy
  labels:
    'app.kubernetes.io/part-of': 'enable-in-gui'
spec:
  regoFile: |
    package main

    # Accepted Values: "Critical", "High", "Medium", "Low", "Negligible", "Unkn
ownSeverity"
    notAllowedSeverities := ["Critical", "High", "UnknownSeverity"]
    ignoreCves := []

    contains(array, elem) = true {
      array[_] = elem
    } else = false { true }

    isSafe(match) {
      severities := { e | e := match.ratings.rating.severity } | { e | e := mat
ch.ratings.rating[_].severity }
      some i
      fails := contains(notAllowedSeverities, severities[i])
      not fails
    }

    isSafe(match) {
      ignore := contains(ignoreCves, match.id)
      ignore
    }

    deny[msg] {
      comps := { e | e := input.bom.components.component } | { e | e := input.b
om.components.component[_] }
      some i
      comp := comps[i]
      vulns := { e | e := comp.vulnerabilities.vulnerability } | { e | e := com
p.vulnerabilities.vulnerability[_] }
      some j
```

```

    vuln := vulns[j]
    ratings := { e | e := vuln.ratings.rating.severity } | { e | e := vuln.ra
ratings.rating[_].severity }
    not isSafe(vuln)
    msg = sprintf("CVE %s %s %s", [comp.name, vuln.id, ratings])
  }
EOF

```

- (optional) The Tanzu Application Platform profiles install the [Supply Chain Security Tools - Store](#) package by default. To persist and query the vulnerability results post-scan, confirm it is installed by running:

```
tanzu package installed get metadata-store -n tap-install
```

If the package is not installed, follow the installation instructions at [Install Supply Chain Security Tools - Store independent from Tanzu Application Platform profiles](#).

- Update the profile to use the supply chain with testing and scanning by updating `tap-values.yaml` (the file used to customize the profile in `tanzu package install tap --values-file=...`) with the following changes:

```

- supply_chain: testing
+ supply_chain: testing_scanning

- ootb_supply_chain_testing:
+ ootb_supply_chain_testing_scanning:
  registry:
    server: "<SERVER-NAME>"
    repository: "<REPO-NAME>"

```

- Update the `tap` package:

```
tanzu package installed update tap -p tap.tanzu.vmware.com -v VERSION-NUMBER --values-file tap-values.yaml -n tap-install
```

Where `VERSION-NUMBER` is your Tanzu Application Platform version. For example, `1.6.13`.

Workload update

To connect the new supply chain to the workload, update the workload to point to your Tekton pipeline:

- Update the workload by running the following using the Tanzu CLI:

```

tanzu apps workload apply tanzu-java-web-app \
  --git-repo https://github.com/vmware-tanzu/application-accelerator-samples \
  --sub-path tanzu-java-web-app \
  --git-branch main \
  --type web \
  --label apps.tanzu.vmware.com/has-tests=true \
  --label app.kubernetes.io/part-of=tanzu-java-web-app \
  --yes

```

- After accepting the workload creation, view the new resources that the workload created by running:

```
kubectl get workload,gitrepository,sourcescan,pipelinerun,images.kpack,imagescan,podintert,app,services.serving
```

The following is an example output, which shows the objects that Supply Chain Choreographer created:

```

NAME                                AGE
workload.carto.run/tanzu-java-web-app 109s

NAME                                URL                                AGE
READY  STATUS
gitrepository.source.toolkit.fluxcd.io/tanzu-java-web-app  https://github.com/
vmware-tanzu/application-accelerator-samples  True  Fetched revision: main/8
72ff44c8866b7805fb2425130edb69a9853bdfd  109s

NAME                                PHASE  SCAN
NEDREVISION                          SCANNEDREPOSITORY
AGE  CRITICAL  HIGH  MEDIUM  LOW  UNKNOWN  CVETOTAL
sourcescan.scanning.apps.tanzu.vmware.com/tanzu-java-web-app  Completed  1878
50b39b754e425621340787932759a0838795  https://github.com/vmware-tanzu/applicat
ion-accelerator-samples  90s

NAME                                SUCCEEDED  REASON  START
TIME  COMPLETIONTIME
pipelinerun.tekton.dev/tanzu-java-web-app-4ftlb  True  Succeeded  104s
77s

NAME                                LATESTIMAGE
READY
image.kpack.io/tanzu-java-web-app  10.188.0.3:5000/foo/tanzu-java-web-app@sha2
56:1d5bc4d3d1ffeb8629fbb721fcd1c4d28b896546e005f1efd98fbc4e79b7552c  True

NAME                                PHASE  SCANN
EDIMAGE
AGE  CRITICAL  HIGH  MEDIUM  LOW  UNKNOWN  CVETOTAL
imagescan.scanning.apps.tanzu.vmware.com/tanzu-java-web-app  Completed  10.18
8.0.3:5000/foo/tanzu-java-web-app@sha256:1d5bc4d3d1ffeb8629fbb721fcd1c4d28b8965
46e005f1efd98fbc4e79b7552c  14s

NAME                                READY  REASON
AGE
podintent.conventions.carto.run/tanzu-java-web-app  True  7s

NAME                                DESCRIPTION  SINCE-DEPLOY
AGE
app.kappctrl.k14s.io/tanzu-java-web-app  Reconcile succeeded  1s
2s

NAME                                URL
LATESTCREATED                          LATESTREADY  READY  REASON
service.serving.knative.dev/tanzu-java-web-app  http://tanzu-java-web-app.deve
loper.example.com  tanzu-java-web-app-00001  tanzu-java-web-app-00001  Unkno
wn  IngressNotConfigured
    
```

 **Important**

If the source or image scan has a “Failed” phase this means that the scan failed due to a scan policy violation and the supply chain stops. For information about the CVE triage workflow, see [Out of the Box Supply Chain with Testing and Scanning](#).

Query for vulnerabilities

Scan reports are automatically saved to the [Supply Chain Security Tools - Store](#), and you can query them for vulnerabilities and dependencies. For example, related to open-source software (OSS) or third-party packages.

Query the tanzu-java-web-app image dependencies and vulnerabilities by running:

```
tanzu insight image get --digest DIGEST
tanzu insight image vulnerabilities --digest DIGEST
```

Where `DIGEST` is the component version or image digest printed in the `KUBECTL GET` command.

For additional information and examples, see [Tanzu Insight plug-in overview](#).

Congratulations! You have successfully added testing and security scanning to your application on the Tanzu Application Platform.

Take the next steps to learn about recommended supply chain security best practices and gain a powerful services journey experience on the Tanzu Application Platform by enabling several advanced use cases.

Next steps

- [Configure image signing and verification in your supply chain](#)

Configure image signing and verification in your supply chain

This topic guides you through configuring your Tanzu Application Platform (commonly known as TAP) supply chain to sign and verify your image builds.

What you will do

- Configure your supply chain to sign your image builds.
- Configure an admission control policy to verify image signatures before admitting pods to the cluster.

Configure your supply chain to sign and verify your image builds

1. Use Cosign to configure Tanzu Build Service to sign your container image builds. For instructions, see [Configure Tanzu Build Service to sign your image builds](#).
2. Create a `values.yaml` file, and install the Supply Chain Security Tools - Policy Controller. For instructions, see [Install Supply Chain Security Tools - Policy Controller](#).
3. Create a `ClusterImagePolicy` that passes Tanzu Application Platform images. It is planned for a future release for these to be signed and verifiable, but currently we recommend creating a policy to pass them:

For example:

```
kubectl apply -f - -o yaml << EOF
---
apiVersion: policy.sigstore.dev/v1beta1
kind: ClusterImagePolicy
metadata:
  name: image-policy-exceptions
spec:
  images:
  - glob: registry.example.org/myproject/*
  - glob: REPO-NAME*
  authorities:
  - static:
```

```

    action: pass
EOF

```

Where:

- o `REPO-NAME` is the repository in your registry where Tanzu Build Service dependencies are stored. This is the exact same value configured in the `kp_default_repository` inside your `tap-values.yaml` or `tbs-values.yaml` files. Examples:
 - Harbor has the form `"my-harbor.io/my-project/build-service"`.
 - Docker Hub has the form `"my-dockerhub-user/build-service"` or `"index.docker.io/my-user/build-service"`.
 - Google Cloud Registry has the form `"gcr.io/my-project/build-service"`.
 - o Add any unsigned image that must run in your namespace to the previous policy. For example, if you add a Tekton pipeline that runs a Gradle image for testing, you need to add `glob: index.docker.io/library/gradle*` to `spec.images.glob` in the preceding code.
 - o Replace `registry.example.org/myproject/*` with your target registry for your Tanzu Application Platform images.
4. Configure and apply a `ClusterImagePolicy` resource to the cluster to verify image signatures when deploying resources. For instructions, see [Create a ClusterImagePolicy resource](#).

For example:

```

kubectl apply -f - -o yaml << EOF
---
apiVersion: policy.sigstore.dev/v1beta1
kind: ClusterImagePolicy
metadata:
  name: example-policy
spec:
  images:
  - glob: registry.example.org/myproject/*
  authorities:
  - key:
      data: |
        -----BEGIN PUBLIC KEY-----
        <content ...>
        -----END PUBLIC KEY-----
EOF

```

5. Enable the policy controller verification in your namespace by adding the label `policy.sigstore.dev/include: "true"` to the namespace resource.

For example:

```

kubectl label namespace YOUR-NAMESPACE policy.sigstore.dev/include=true

```

Where `YOUR-NAMESPACE` is the name of your secure namespace.



Note

Supply Chain Security Tools - Policy Controller only validates resources in namespaces that have chosen to opt in.

When you apply the `ClusterImagePolicy` resource, your cluster requires valid signatures for all images that match the `spec.images.glob[]` you define in the configuration. For more information about configuring an image policy, see [Configuring Supply Chain Security Tools - Policy](#).

Next steps

- [Consume services on Tanzu Application Platform](#)

Or learn more about Supply Chain Security Tools:

- [Overview for Supply Chain Security Tools - Policy](#)
- [Configuring Supply Chain Security Tools - Policy](#)
- [Supply Chain Security Tools - Policy known issues](#)

Integrate a plug-in into your Tanzu Developer Portal

This topic guides you through integrating the hello-world plug-in into your Tanzu Developer Portal by using the Configurator tool. The hello-world plug-in is a demonstration of the Configurator tool's capabilities.

For general information about the Tanzu Developer Portal Configurator and its basic concepts, see [Overview of Configurator \(beta\)](#).

What you will do

- Create a customized Tanzu Developer Portal containing the hello-world plug-in
- Observe the customized Tanzu Developer Portal instance

Prerequisites

Before you start, you must have:

- All the [Prerequisites for the getting started guide](#).
- The Tanzu Developer Portal Configurator bundle available (tpb.tanzu.vmware.com).

To verify it's present, run:

```
tanzu package available list --namespace tap-install | grep tpb.tanzu.vmware.com
```

- An instance of the canonical Tanzu Developer Portal.

To get the fully-qualified domain name for the portal, run:

```
kubectl get httpproxy tap-gui -n tap-gui
```



Note

By default, Tanzu Developer Portal uses a self-signed certificate and might cause a security error in the browser. To address this error, see [Configure a TLS certificate by using an existing certificate](#).

Customize your Tanzu Developer Portal by adding the hello-world plug-in

To integrate the hello-world plug-in into your Tanzu Developer Portal:

1. Create the **tpb-config.yaml** file specifying the list of additional plug-ins that you want to integrate. In this example, you only specify the hello-world plug-in that has both front end and back end parts:

```
app:
  plugins:
    - name: '@tpb/plugin-hello-world'
      version: '^1.6.0-release-1.6.x.1'
  backend:
    plugins:
      - name: '@tpb/plugin-hello-world-backend'
        version: '^1.6.0-release-1.6.x.1'
```



Note

If the version of the plug-in is not specified, the workload that uses the config file as input is likely to fail.

2. Encode the file in base64, to later embed **tpb-config.yaml** in the workload definition file, by running:

```
base64 -i tdp-config.yaml
```

Example output:

```
YXBwOgogIHBsdWdpbnM6CiAgICAtIG5hbWU6ICdAdHBiL3BsdWdpbi1oZWxsby13b3JsZCcKICAgICAgdmVyc2l1b21vbjogJ14xLjYuMCIyZWxlYXN1LTEuNi54LjEnIApiYWNRZW5kOgogIHBsdWdpbnM6CiAgICAtIG5hbWU6ICdAdHBiL3BsdWdpbi1oZWxsby13b3JsZC1iYWNRZW5kOgogICAgICB2ZXJzaW9uOjAnXjEuNi4wLXJ1bGVhc2UtMS42LnguMScK
```

You use this value later as **ENCODED-TDP-CONFIG-VALUE**.

3. Identify the location of the Configurator's image by running these commands:

```
export OUTPUT_IMAGE=$(kubectl -n tap-install get package tpb.tanzu.vmware.com.0.1.2 -o "jsonpath={.spec.template.spec.fetch[0].imgpkgBundle.image}")
```

```
imgpkg pull -b ${OUTPUT_IMAGE} -o tpb-package
```

```
yq -r ".images[0].image" <tpb-package/.imgpkg/images.yml
```

You use this value later as **TDP-IMAGE-LOCATION**.

4. Prepare your workload definition file. Create a file called **tdp-workload.yaml** with the following content:

```
apiVersion: carto.run/v1alpha1
kind: Workload
metadata:
  name: tdp-configurator
  namespace: DEVELOPER-NAMESPACE
  labels:
    apps.tanzu.vmware.com/workload-type: web
    app.kubernetes.io/part-of: tdp-configurator
spec:
  build:
  env:
```

```

- name: BP_NODE_RUN_SCRIPTS
  value: 'set-tpb-config,portal:pack'
- name: TPB_CONFIG
  value: /tmp/tpb-config.yaml
- name: TPB_CONFIG_STRING
  value: ENCODED-TDP-CONFIG-VALUE

source:
  image: TDP-IMAGE-LOCATION
  subPath: builder
    
```

Where:

- o **DEVELOPER-NAMESPACE** is the developer namespace configured on the cluster.
- o **ENCODED-TDP-CONFIG-VALUE** is the base64-encoded **tpb-config.yaml** that you encoded earlier.
- o **TDP-IMAGE-LOCATION** is the location of the Configurator image that you identified earlier.



Important

Depending on which supply chain you're using and how you configured it, you might have to add extra sections to your workload definition file to accommodate activities such as testing.

5. Deploy your workload on your Tanzu Application Platform cluster by running:

```
tanzu apps workload create -f tdp-workload.yaml -n DEVELOPER-NAMESPACE
```

Where **DEVELOPER-NAMESPACE** is the developer namespace configured on the cluster.

6. After the workload has deployed, view it in the **Supply Chains** tab of the Tanzu Developer Portal.

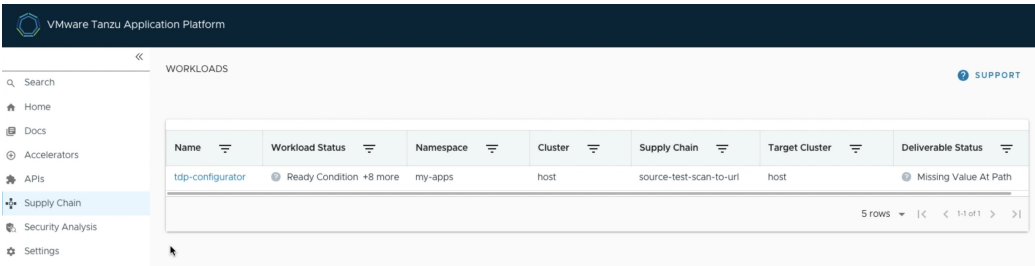

Wait for the **Image Provider** step of the supply chain to complete.

7. From the **Supply Chains** tab of the Tanzu Developer Portal, click the box that follows the **Image Provider** step and copy the address to the customized Tanzu Developer Portal's image from the **Artifact Detail: Image Provider** section.

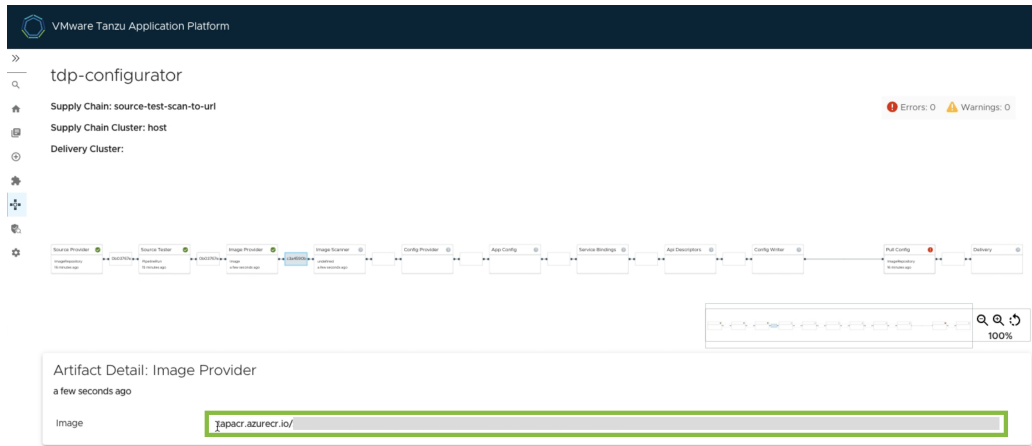

You use this value as **IMAGE-REFERENCE** in the next step.

8. Create the **tdp-overlay-secret.yaml** to insert the new image into the Tanzu Developer Portal instance.

```

apiVersion: v1
kind: Secret
metadata:
  name: tpb-app-image-overlay-secret
  namespace: tap-install
stringData:
  tpb-app-image-overlay.yaml: |
    #@ load("@ytt:overlay", "overlay")

    #! makes an assumption that tap-gui is deployed in the namespace: "tap-gui"
    #@overlay/match by=overlay.subset({"kind": "Deployment", "metadata": {"name": "server", "namespace": "tap-gui"}}), expects="1+"
    ---
    spec:
      template:
        spec:
          containers:
            #@overlay/match by=overlay.subset({"name": "backstage"}), expects="1+"
            +
            #@overlay/match-child-defaults missing_ok=True
            - image: IMAGE-REFERENCE
            #@overlay/replace
            args:
              - -c
              - |
                export KUBERNETES_SERVICE_ACCOUNT_TOKEN="$(cat /var/run/secrets/kubernetes.io/serviceaccount/token)"
                exec /layers/tanzu-buildpacks_node-engine-lite/node/bin/node portal/dist/packages/backend \
                  --config=portal/app-config.yaml \
                  --config=portal/runtime-config.yaml \
                  --config=/etc/app-config/app-config.yaml
    
```

Where **IMAGE-REFERENCE** is address of the customized Tanzu Developer Portal image identified in the previous step.

Important

Any changes in the overlay of the YAML file will cause an error.

9. Deploy the secret to the Tanzu Application Platform cluster by running:

```
kubectl apply -f tdp-overlay-secret.yaml
```

- Amend the `tap-values.yaml` file to include the overlay secret by adding the following lines:

```
profile: full
tap_gui:
  ...
package_overlays:
- name: tap-gui
  secrets:
    - name: tpb-app-image-overlay-secret
```

- Apply the new `tap-values.yaml` to your cluster. The exact steps vary depending on your installation method such as GitOps, online install, or offline install.

For how to do so for an online installation, see [Install your Tanzu Application Platform package](#).

For example, you can use the following Tanzu CLI command:

```
tanzu package installed update tap -f tap-values.yaml -n tap-install
```

- After all packages have reconciled, the Tanzu Developer Portal pod restarts and your customized portal takes the place of the default one.



Note

You might have to clear your browser cache or hard refresh to see the updated Tanzu Developer Portal.

If the old Tanzu Developer Portal pod does not automatically delete, manually delete it by running:

```
kubectl delete pod POD-NAME -n tap-gui
```

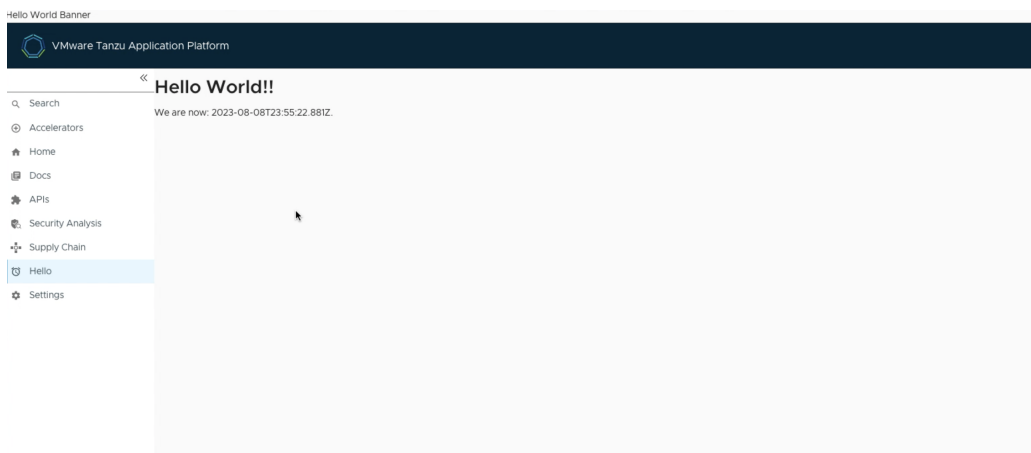

Next steps

Now that you have your hello-world plug-in integrated into your Tanzu Developer Portal, explore how to [Add external plug-ins to Tanzu Developer Portal](#).

Generate an application with Application Accelerator

This topic guides you through how to generate a new project using Application Accelerator and how to deploy the project onto a Tanzu Application Platform (commonly known as TAP) cluster. For background information, see [Application Accelerator](#).

Prerequisites

Before you start, complete all [Getting Started prerequisites](#).

Generate a project using an Application Accelerator

There are multiple interfaces that you can use to generate a new project. The options are:

- Application Accelerator extension for VS Code
- Application Accelerator plug-in for IntelliJ
- Tanzu Developer Portal (formerly named Tanzu Application Platform GUI)

Choose one of the following tabs for how to generate and deploy applications using your selected interface. If you have already generated a project and want to skip this step, you can go to [Deploying your application with Tanzu Application Platform](#).

VS Code

What you will do:

- Install the Application Accelerator extension for VS Code.
- (Optional) Provision a new GitHub repository and upload the project to the repository.
- Generate a project using an Application Accelerator.

To generate a new project using an Application Accelerator:

1. Install and configure the Application Accelerator extension for VS Code, see [Application Accelerator Visual Studio Code extension](#).
2. Select an accelerator from the catalog. This example uses [Tanzu Java Web App](#).

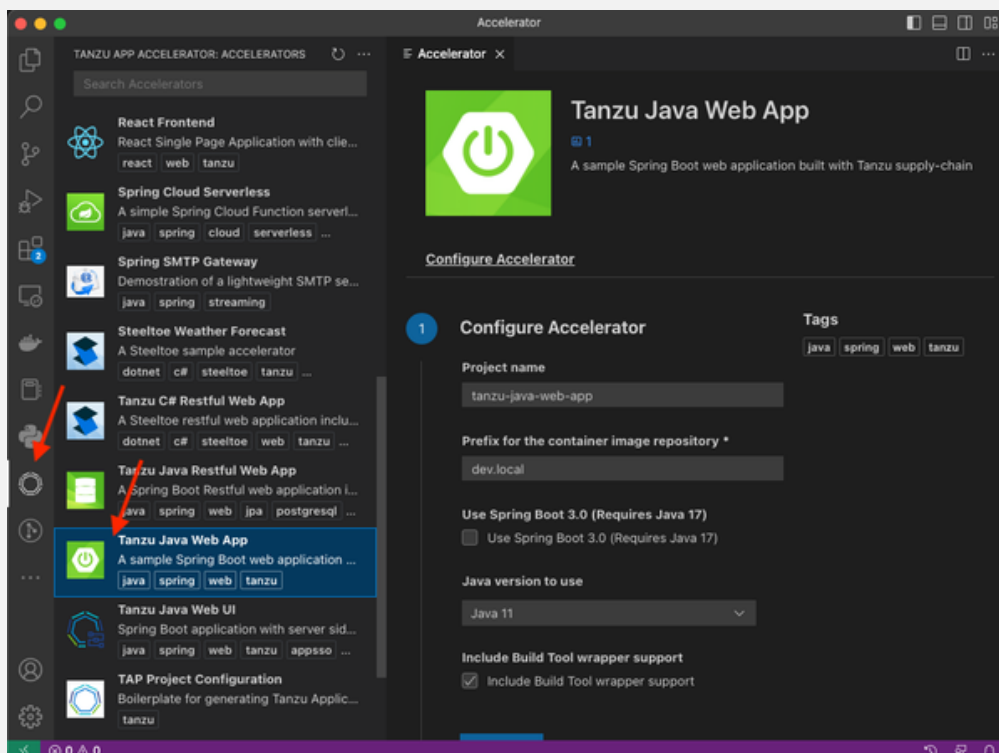

- In **Configure Accelerator**, configure the accelerator as defined by your project's requirements. This example configures the project to use Spring Boot v3.0 and Java v17.

Configure Accelerator

1 **Configure Accelerator** Tags

Prefix for the container image repository *

Use Spring Boot 3.0 (Requires Java 17)

Use Spring Boot 3.0 (Requires Java 17)

Java version to use

Include Build Tool wrapper support

Include Build Tool wrapper support

2 **Setup Repository**

- Click **Next Step**.
- If your organization's Tanzu Application Platform is configured for Git repository creation, configure the **Setup Repository** step using the following sub-steps. If not, click **Skip** and go to step 5.



Note

For information about configuring optional Git repository creation and supported repositories, see [Create an Application Accelerator Git repository during project creation](#).

- Using the **Providers** drop-down menu, select your Git provider. For example, [github.com](#).
- After you select the provider, a dialog box appears for you to enter an API token for your Git provider. Populate the text box with your provider's API token and press Enter.

This API key must be able to create new repositories for an organization or user. For information about how to create an API token for Git repository creation, see [Creating a personal access token](#) in the GitHub documentation.

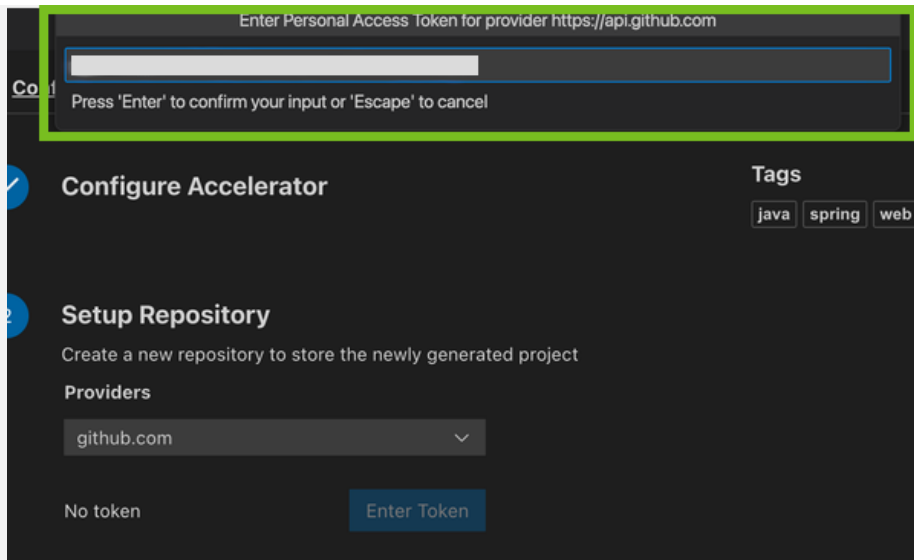

3. In the **Owner** text box, enter the name of either the GitHub organization or user name to create the repository under.
4. In the **Repository Name** text box, enter the name of the project repository.
5. In the **Repository Branch** text box, enter the name of the default branch for the project repository. Typically, this is set to `main`.
6. Click **Next Step**.
6. In the **Review and Generate** step, verify that all the information you provided is accurate, then click **Generate Project**.
7. A dialog box appears for you to choose a location for the project to be stored on the local file system. Choose a directory or create a new one.
8. After the project has generated, a second dialog box appears for you to open the new project in a new window. Click **Yes**.
9. When opened, the project is ready for development.

IntelliJ

What you will do:

- Install the Application Accelerator plug-in for IntelliJ.
- Generate a project using an Application Accelerator.

To generate a new project using an Application Accelerator:

1. Install and configure the Application Accelerator plug-in for IntelliJ, see [Application Accelerator plugin for IntelliJ](#).
2. On the Welcome to IntelliJ IDEA page, click **New Project**.

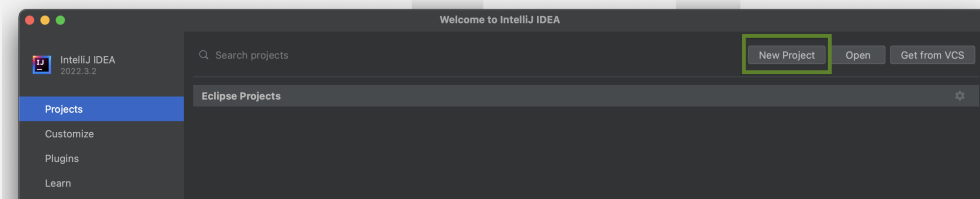

3. Click **Tanzu Application Accelerator** in the left side panel.

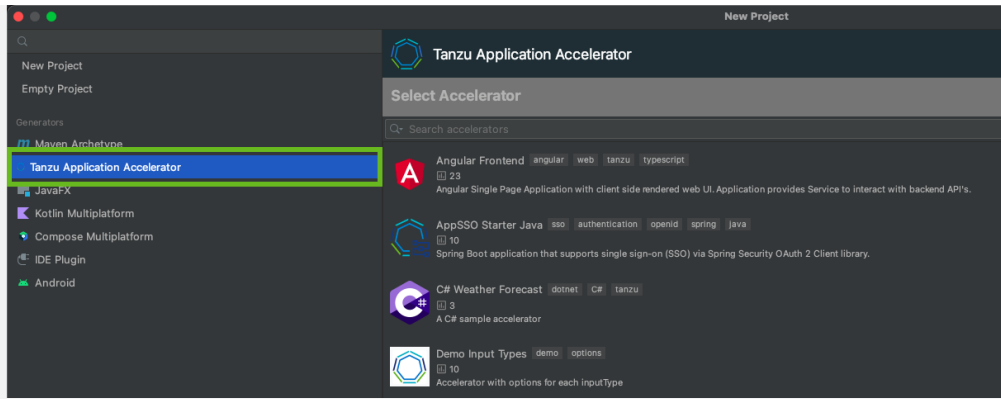

4. Select an accelerator from the catalog. This example uses **Tanzu Java Web App**.
5. Click **Next**.
6. In the **Configure Options** step, configure the accelerator as defined by your project's requirements.

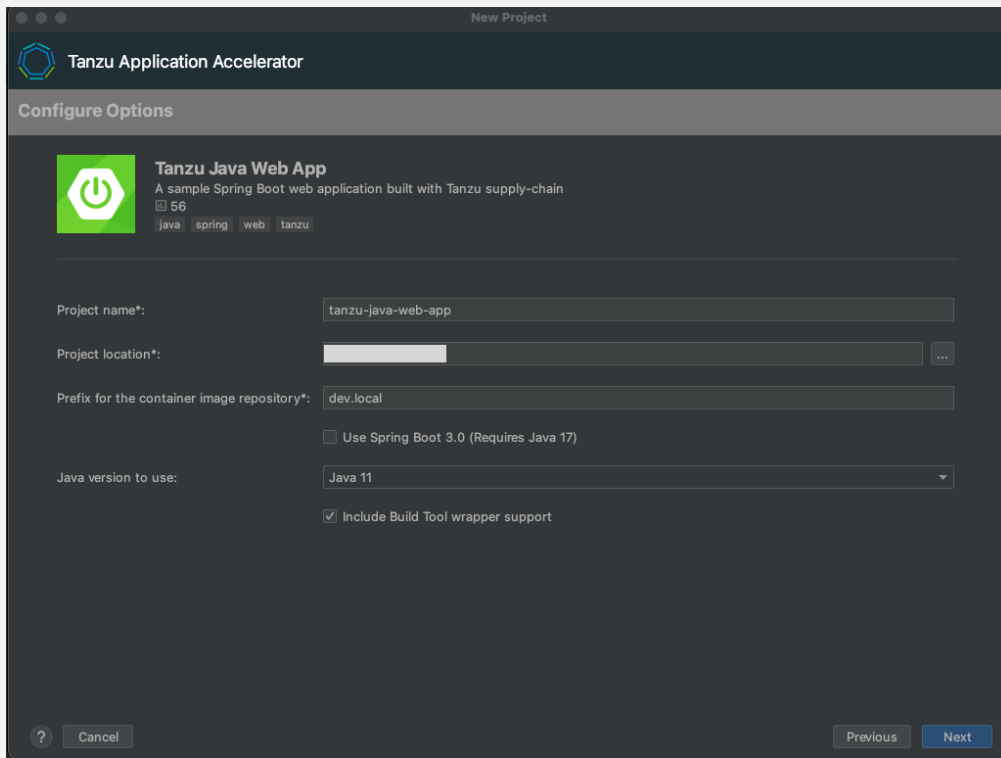

7. Click **Next**.
8. In the **Review and Generate** step, verify that all the information provided is accurate then click **Next**.
9. After the project has generated, click **Create** to open the new project in IntelliJ.
10. When opened, the project is ready for development.

Tanzu Developer Portal

In this example, you use the **Tanzu-Java-Web-App** accelerator. You also use Tanzu Developer Portal. For information about connecting to Tanzu Developer Portal, see [Access Tanzu Developer Portal](#).

What you will do:

- Generate a project from an Application Accelerator.
- (Optional) Provision a new Git repository for the project.

- Upload it to your Git repository of choice.

To generate a new project using an Application Accelerator:

1. From Tanzu Developer Portal portal, click **Create** located on the left side of the navigation pane to see the list of available accelerators.

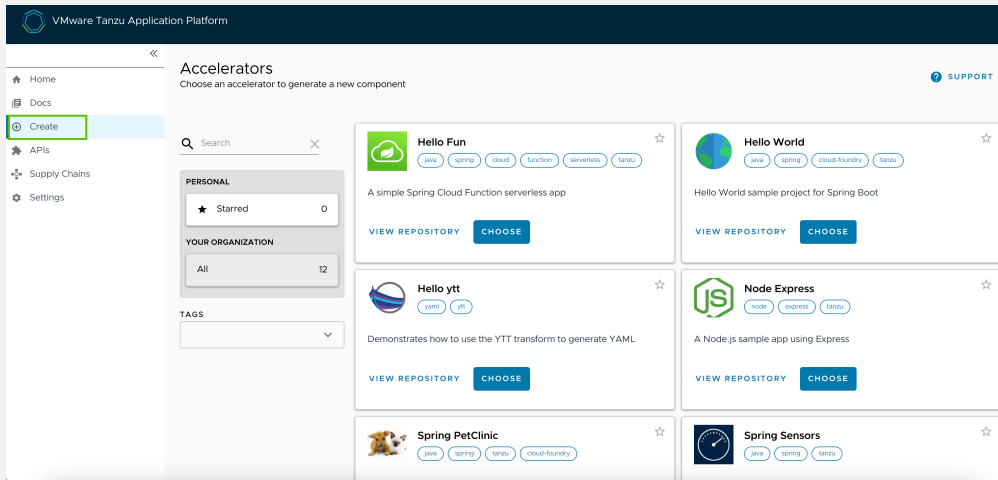

2. Locate the Tanzu Java Web App accelerator and click **CHOOSE**.
3. In the **Generate Accelerators** dialog box, replace the default value `dev.local` in the **prefix for container image registry** text box with the registry in the form of `SERVER-NAME/REPO-NAME`. The `SERVER-NAME/REPO-NAME` must match what was specified for `registry` as part of the installation values for `ootb_supply_chain_basic`. See the Full Profile section on [Installing Tanzu Application Platform package and ./install-online/install.hbs.md profiles](#).

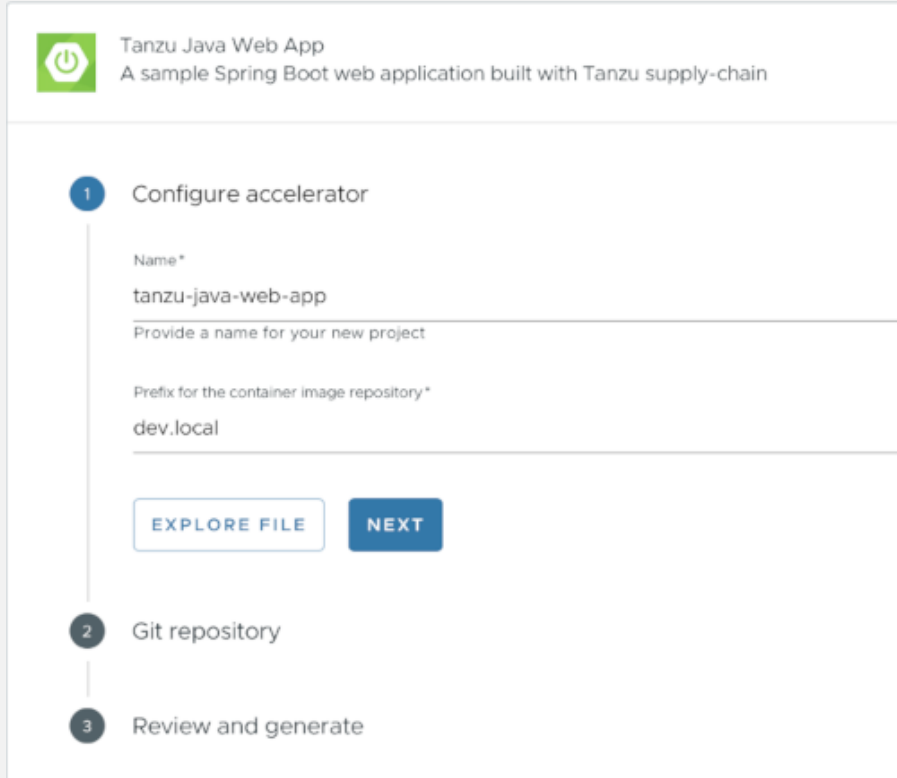

4. Click **NEXT**.
5. If your instance has optional Git repository support enabled, continue with the following sub-steps. If your instance does not support this, skip to step 5.

**Note**

For information about configuring optional Git repository creation and supported repositories, see [Create an Application Accelerator Git repository during project creation](#).

1. Select the **Create Git repo?** check box.
2. Select the host Git repository provider from the **Host** drop-down menu. For example, [github.com](#).
3. Populate the **Owner** and **Repository** text boxes.

2 Git repository

Create Git repo?

Host

github.com

The host where the repository will be created

Owner*

my-org

The organization, user or project that this repo will belong to

Repository*

my-new-repo

The name of the repository

Default Branch

main

BACK **NEXT**

4. While you are populating the form, a dialog box appears asking for permission to provision Git repositories. Follow the prompts and continue.
5. Click **NEXT**.
6. Verify the provided information, and click **GENERATE ACCELERATOR**.
7. After the Task Activity processes complete, click **DOWNLOAD ZIP FILE**.
8. After downloading the ZIP file, expand it in a workspace directory. If you did not create a Git repository in the preceding steps, follow your preferred procedure for uploading the generated project files to a Git repository for your new project.

Learn more about Application Accelerator

- For information about how to configure optional Git repository creation, see [Configure](#) in *Create an Application Accelerator Git repository during project creation*.
- For information about Application Accelerator configurations, see [Configure Application Accelerator](#).
- For information about installing the Application Accelerator extension for Visual Studio Code, see [Application Accelerator Visual Studio Code extension](#).
- For general accelerator troubleshooting, see [Troubleshooting Application Accelerator for VMware Tanzu](#).

Next Steps

Now that you have generated a project that is ready for Tanzu Application Platform, learn how to quickly deploy the application on a Tanzu Application Platform cluster in [Deploy an app on Tanzu Application Platform](#).

Generate an application with Application Accelerator

This topic guides you through how to generate a new project using Application Accelerator and how to deploy the project onto a Tanzu Application Platform (commonly known as TAP) cluster. For background information, see [Application Accelerator](#).

Prerequisites

Before you start, complete all [Getting Started prerequisites](#).

Generate a project using an Application Accelerator

There are multiple interfaces that you can use to generate a new project. The options are:

- Application Accelerator extension for VS Code
- Application Accelerator plug-in for IntelliJ
- Tanzu Developer Portal (formerly named Tanzu Application Platform GUI)

Choose one of the following tabs for how to generate and deploy applications using your selected interface. If you have already generated a project and want to skip this step, you can go to [Deploying your application with Tanzu Application Platform](#).

VS Code

What you will do:

- Install the Application Accelerator extension for VS Code.
- (Optional) Provision a new GitHub repository and upload the project to the repository.
- Generate a project using an Application Accelerator.

To generate a new project using an Application Accelerator:

1. Install and configure the Application Accelerator extension for VS Code, see [Application Accelerator Visual Studio Code extension](#).
2. Select an accelerator from the catalog. This example uses [Tanzu Java Web App](#).

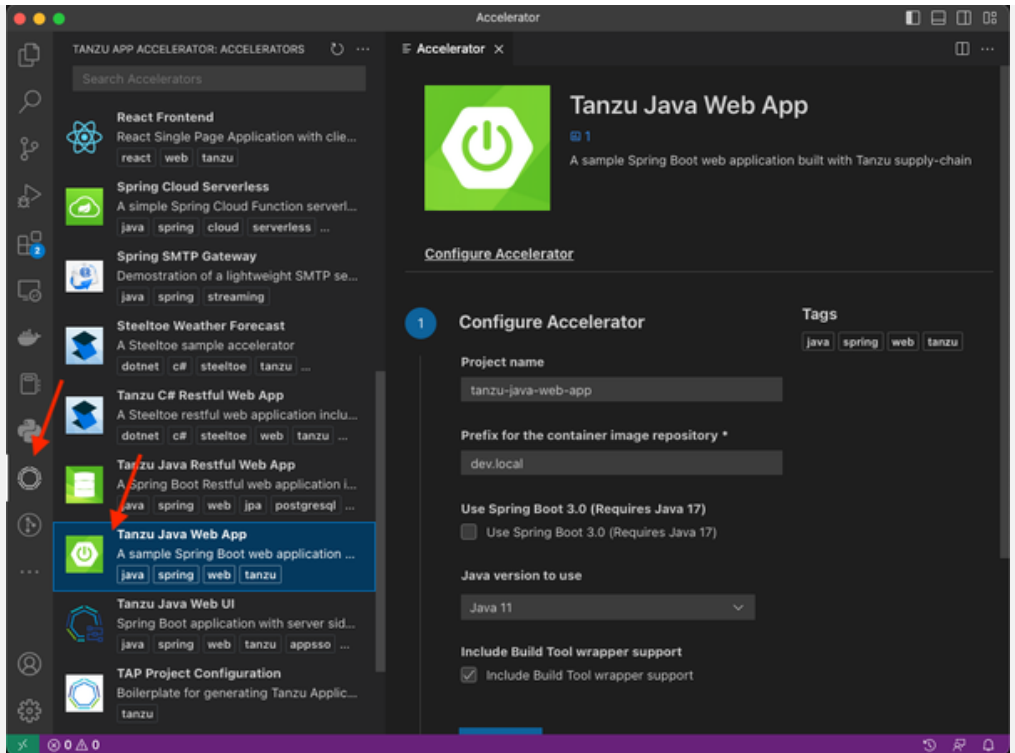

3. In **Configure Accelerator**, configure the accelerator as defined by your project's requirements. This example configures the project to use Spring Boot v3.0 and Java v17.

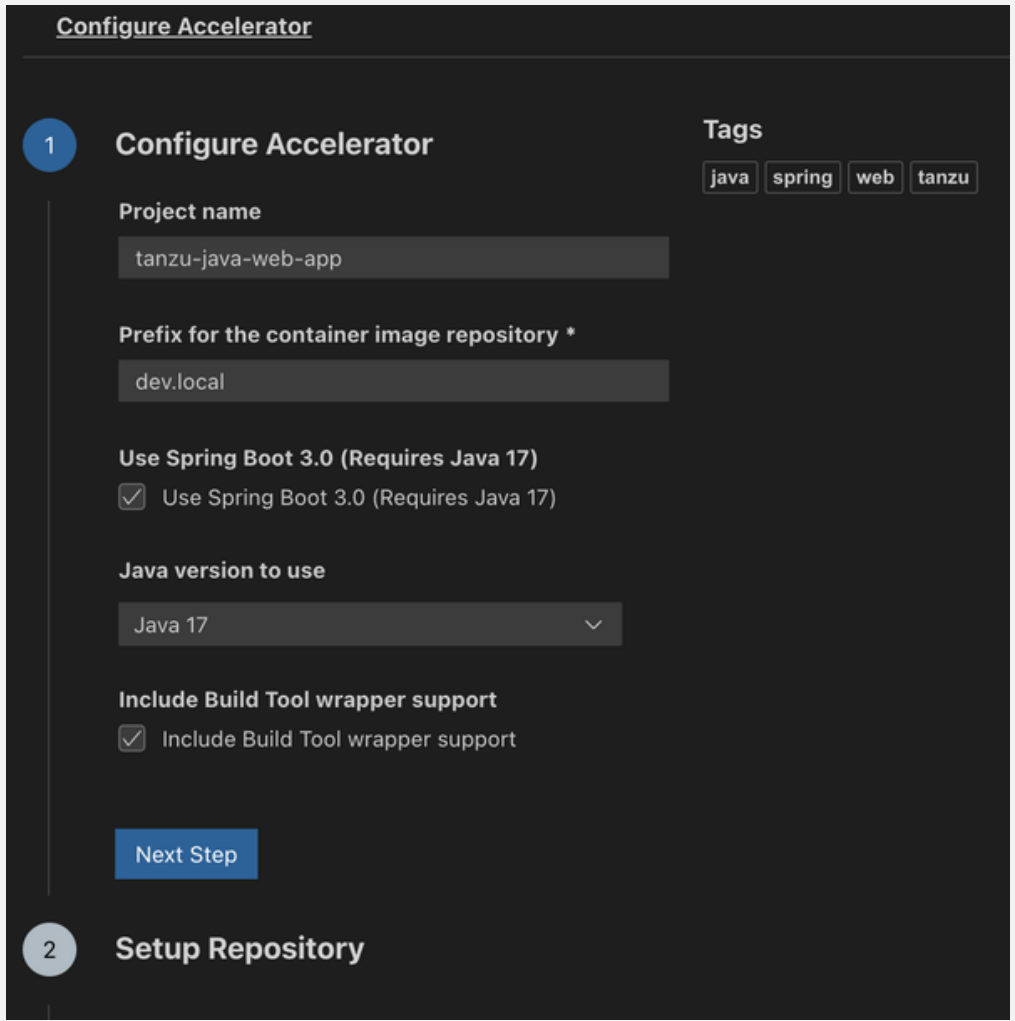

4. Click **Next Step**.
5. If your organization's Tanzu Application Platform is configured for Git repository creation, configure the **Setup Repository** step using the following sub-steps. If not, click **Skip** and go to step 5.

 **Note**

For information about configuring optional Git repository creation and supported repositories, see [Create an Application Accelerator Git repository during project creation](#).

1. Using the **Providers** drop-down menu, select your Git provider. For example, `github.com`.
2. After you select the provider, a dialog box appears for you to enter an API token for your Git provider. Populate the text box with your provider's API token and press Enter.

This API key must be able to create new repositories for an organization or user. For information about how to create an API token for Git repository creation, see [Creating a personal access token](#) in the GitHub documentation.

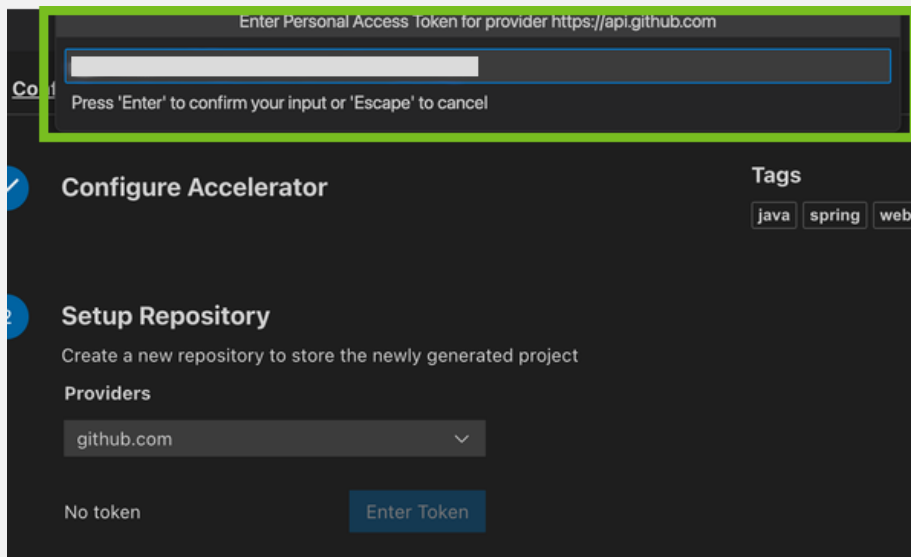

3. In the **Owner** text box, enter the name of either the GitHub organization or user name to create the repository under.
4. In the **Repository Name** text box, enter the name of the project repository.
5. In the **Repository Branch** text box, enter the name of the default branch for the project repository. Typically, this is set to `main`.
6. Click **Next Step**.
6. In the **Review and Generate** step, verify that all the information you provided is accurate, then click **Generate Project**.
7. A dialog box appears for you to choose a location for the project to be stored on the local file system. Choose a directory or create a new one.
8. After the project has generated, a second dialog box appears for you to open the new project in a new window. Click **Yes**.
9. When opened, the project is ready for development.

IntelliJ

What you will do:

- Install the Application Accelerator plug-in for IntelliJ.
- Generate a project using an Application Accelerator.

To generate a new project using an Application Accelerator:

1. Install and configure the Application Accelerator plug-in for IntelliJ, see [Application Accelerator plugin for IntelliJ](#).
2. On the Welcome to IntelliJ IDEA page, click **New Project**.

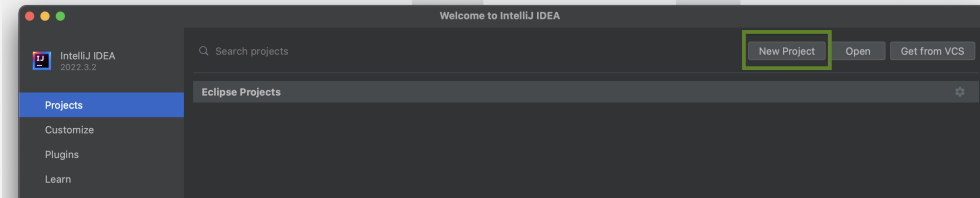

3. Click **Tanzu Application Accelerator** in the left side panel.

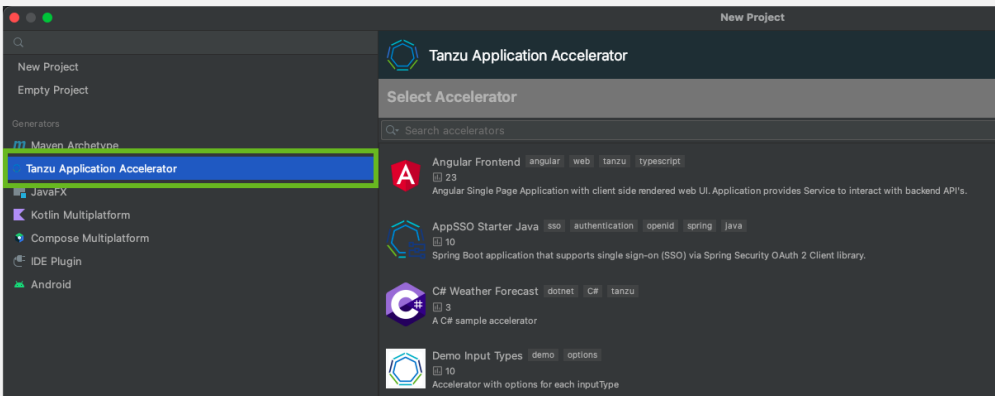

4. Select an accelerator from the catalog. This example uses **Tanzu Java Web App**.
5. Click **Next**.
6. In the **Configure Options** step, configure the accelerator as defined by your project's requirements.

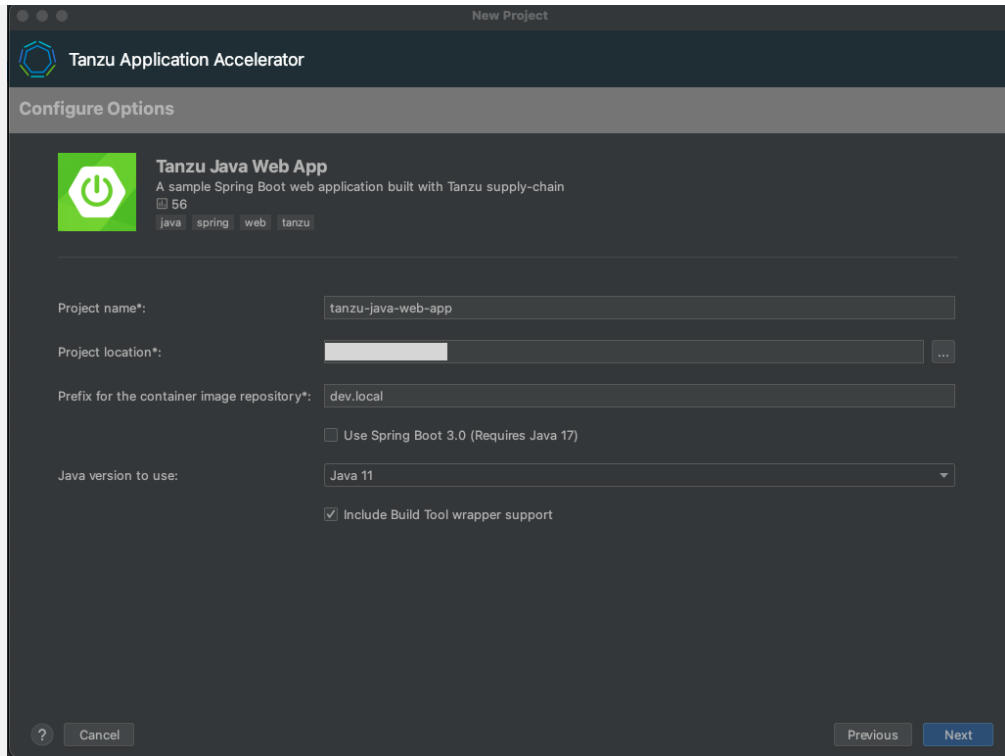

7. Click **Next**.
8. In the **Review and Generate** step, verify that all the information provided is accurate then click **Next**.
9. After the project has generated, click **Create** to open the new project in IntelliJ.
10. When opened, the project is ready for development.

Tanzu Developer Portal

In this example, you use the [Tanzu-Java-Web-App](#) accelerator. You also use Tanzu Developer Portal. For information about connecting to Tanzu Developer Portal, see [Access Tanzu Developer Portal](#).

What you will do:

- Generate a project from an Application Accelerator.
- (Optional) Provision a new Git repository for the project.
- Upload it to your Git repository of choice.

To generate a new project using an Application Accelerator:

1. From Tanzu Developer Portal portal, click **Create** located on the left side of the navigation pane to see the list of available accelerators.

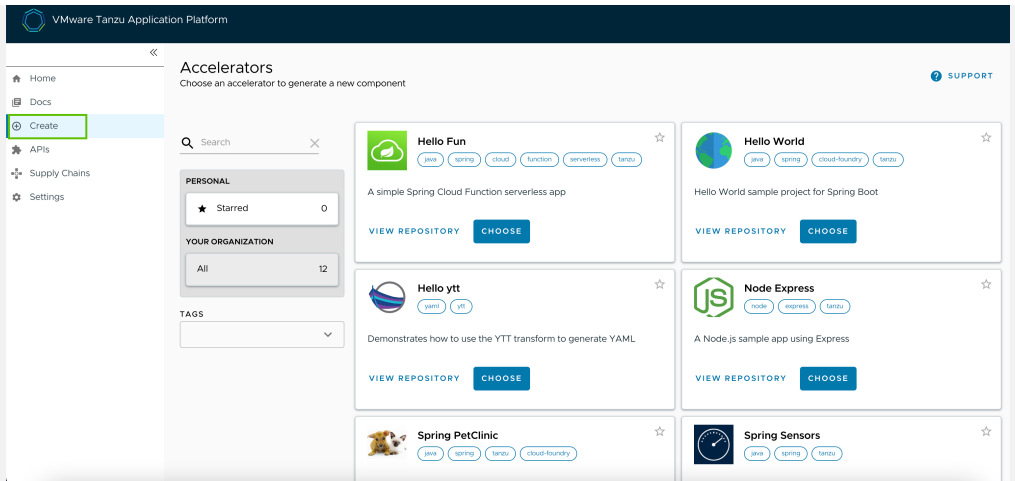

2. Locate the Tanzu Java Web App accelerator and click **CHOOSE**.
3. In the **Generate Accelerators** dialog box, replace the default value `dev.local` in the **prefix for container image registry** text box with the registry in the form of `SERVER-NAME/REPO-NAME`. The `SERVER-NAME/REPO-NAME` must match what was specified for `registry` as part of the installation values for `ootb_supply_chain_basic`. See the Full Profile section on [Installing Tanzu Application Platform package and `./install-online/install.hbs.md` profiles.](#)

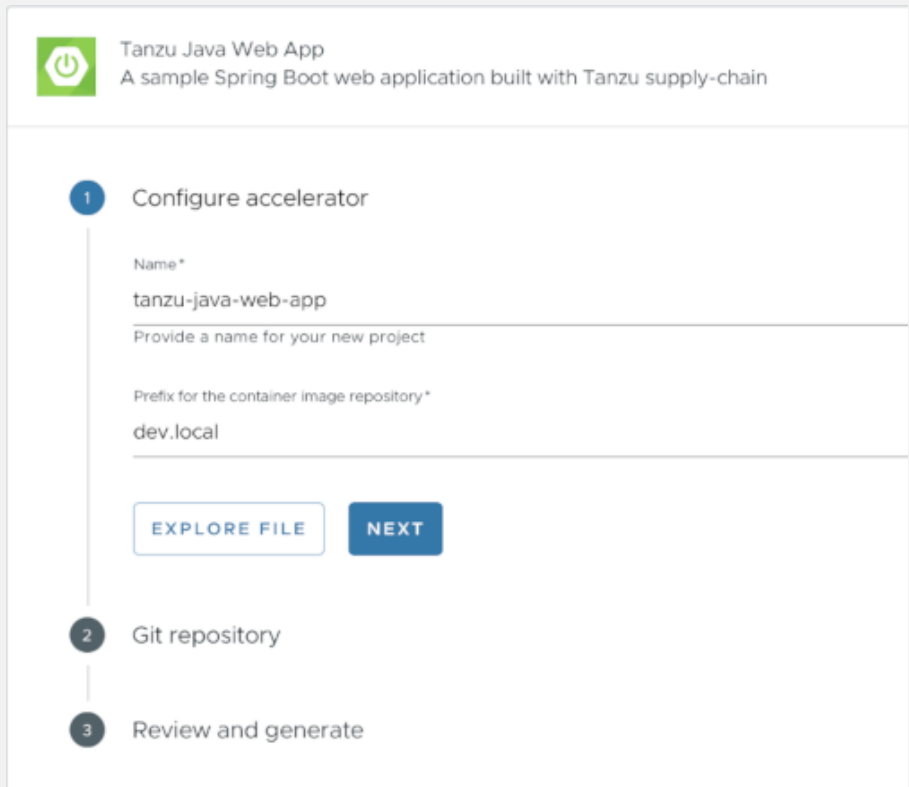

4. Click **NEXT**.
5. If your instance has optional Git repository support enabled, continue with the following sub-steps. If your instance does not support this, skip to step 5.

Note

For information about configuring optional Git repository creation and supported repositories, see [Create an Application Accelerator Git repository during project creation](#).

1. Select the **Create Git repo?** check box.
2. Select the host Git repository provider from the **Host** drop-down menu. For example, `github.com`.
3. Populate the **Owner** and **Repository** text boxes.

2 Git repository

Create Git repo?

Host

github.com

The host where the repository will be created

Owner*

my-org

The organization, user or project that this repo will belong to

Repository*

my-new-repo

The name of the repository

Default Branch

main

BACK **NEXT**

4. While you are populating the form, a dialog box appears asking for permission to provision Git repositories. Follow the prompts and continue.
5. Click **NEXT**.
6. Verify the provided information, and click **GENERATE ACCELERATOR**.
7. After the Task Activity processes complete, click **DOWNLOAD ZIP FILE**.
8. After downloading the ZIP file, expand it in a workspace directory. If you did not create a Git repository in the preceding steps, follow your preferred procedure for uploading the generated project files to a Git repository for your new project.

Learn more about Application Accelerator

- For information about how to configure optional Git repository creation, see [Configure in Create an Application Accelerator Git repository during project creation](#).
- For information about Application Accelerator configurations, see [Configure Application Accelerator](#).
- For information about installing the Application Accelerator extension for Visual Studio Code, see [Application Accelerator Visual Studio Code extension](#).
- For general accelerator troubleshooting, see [Troubleshooting Application Accelerator for VMware Tanzu](#).

Next Steps

Now that you have generated a project that is ready for Tanzu Application Platform, learn how to quickly deploy the application on a Tanzu Application Platform cluster in [Deploy an app on Tanzu Application Platform](#).

Deploy an app on Tanzu Application Platform

This topic guides you through deploying your first application on Tanzu Application Platform (commonly known as TAP) by using the Tanzu CLI, and optionally adding your application to the Tanzu Developer Portal (formerly named Tanzu Application Platform GUI) software catalog.

This guide is a continuation from the previous step, [Generate an application with Application Accelerator](#).

What you will do

- Deploy an app using the Tanzu CLI.
- View the build and runtime logs for your app.
- View the web app in your browser.
- (Optional) Add your application to Tanzu Developer Portal software catalog.

Prerequisites

Before you start, you must have:

- Completed all [Getting Started prerequisites](#).
- Created a project. To do so, you can follow the steps in [Generate an application with Application Accelerator](#).
- Created a Git repository during the project creation stage. If the project does not have an associated Git repository, create a repository and update the `workload.yaml` the repository URL and branch.

Deploy your application using the Tanzu CLI

Complete the following steps to deploy your application using the Tanzu CLI.

Prerequisites

Ensure that you meet the following prerequisites:

- Before you deploy your application using the Tanzu CLI, ensure that you have created a Git repository during the project creation stage.

- If the project does not have an associated Git repository, you must create one, and then update the `workload.yaml` with the repository URL and branch.

Procedure

1. Deploy the Tanzu Java Web App project that you generated in [Generate an application with Application Accelerator](#) by running the `tanzu apps workload create` command:

```
tanzu apps workload create --file config/workload.yaml --namespace YOUR-NAMESPA
CE
```

Alternatively, you can create a workload using the command line:

```
tanzu apps workload create tanzu-java-web-app \
--git-repo GIT-REPO-URL \
--git-branch main \
--type web \
--label app.kubernetes.io/part-of=tanzu-java-web-app \
--label apps.tanzu.vmware.com/has-tests="true" \
--yes \
--namespace YOUR-NAMESPACE
```

Where:

- `GIT-REPO-URL` is the Git repository URL for where your project is stored. For example, `https://github.com/vmware-tanzu/my-tanzu-java-web-app-project`.
- `YOUR-NAMESPACE` is the namespace where workloads are deployed. For example, `my-app-dev-namespace`. This depends on your organization's Tanzu Application Platform configuration. For more information, consult with your Tanzu Application Platform administrators.

For more information, see [Tanzu Apps Workload Apply](#).

2. View the build and runtime logs for your app by running the `get` command:

```
tanzu apps workload get tanzu-java-web-app --namespace YOUR-DEVELOPER-NAMESPACE
```

Where `YOUR-DEVELOPER-NAMESPACE` is the namespace configured earlier.



Note

To watch updates in real time, prepend `watch -n1` to the `tanzu apps workload get` command to see the result update every second.

An example of the output from an early-stage deployment looks like the following:

```
Overview
  name:      tanzu-java-web-app
  type:      web
  namespace: dev-namespace

Source
  type:      git
  url:       https://github.com/my-organization/tanzu-java-web-app
  branch:    main

Supply Chain
  name:      source-to-url

NAME          READY    HEALTHY    UPDATED    RESOURCE
```

```

    source-provider      True      True      5s      gitrepositories.source.toolkit.fluxcd.io/tanzu-java-web-app
    image-provider      Unknown  Unknown  5s      images.kpack.io/tanzu-java-web-app
    config-provider     False   Unknown  8s      not found
    app-config          False   Unknown  8s      not found
    service-bindings   False   Unknown  8s      not found
    api-descriptors    False   Unknown  8s      not found
    config-writer       False   Unknown  8s      not found

Delivery
  name:  delivery-basic

NAME          READY  HEALTHY  UPDATED  RESOURCE
source-provider  False  False    2s      imagerepositories.source.apps.tanzu.vmware.com/tanzu-java-web-app-delivery
  deployer      False  Unknown  5s      not found

Messages
  Workload [MissingValueAtPath]:  waiting to read value [.status.latestImage] from resource [images.kpack.io/tanzu-java-web-app] in namespace [dev-namespace]
  Deliverable [HealthyConditionRule]:  Unable to resolve image with tag "my-instance.azurecr.io/tap/tanzu-java-web-app-dev-namespace-bundle:0da415bc-5d79-4d80-8ff1-0d27f42f871c" to a digest: HEAD https://my-instance.azurecr.io/v2/tap/tanzu-java-web-app-dev-namespace-bundle/manifests/0da415bc-5d79-4d80-8ff1-0d27f42f871c: unexpected status code 404 Not Found (HEAD responses have no body, use GET for details)

Pods
NAME          READY  STATUS    RESTARTS  AGE
tanzu-java-web-app-build-1-build-pod  0/1    Init:0/6  0          5s

```

After the workload is deployed, text similar to the following is displayed:

```

Overview
  name:      tanzu-java-web-app
  type:      web
  namespace: dev-namespace

Source
  type:      git
  url:       https://github.com/my-organization/tanzu-java-web-app
  branch:    main

Supply Chain
  name:      source-to-url

NAME          READY  HEALTHY  UPDATED  RESOURCE
source-provider  True   True     5m26s    gitrepositories.source.toolkit.fluxcd.io/tanzu-java-web-app
image-provider  True   True     4m30s    images.kpack.io/tanzu-java-web-app
config-provider  True   True     4m24s    podintents.conventions.carto.run/tanzu-java-web-app
app-config      True   True     4m24s    configmaps/tanzu-java-web-app
service-bindings  True   True     4m24s    configmaps/tanzu-java-web-app-with-claims
api-descriptors  True   True     4m24s    configmaps/tanzu-java-web-app-with-api-descriptors
config-writer    True   True     4m12s    runnables.carto.run/tanzu-java-web-app-config-writer

Delivery
  name:      delivery-basic

```

```

NAME                READY   HEALTHY   UPDATED   RESOURCE
source-provider     True    True      3m23s    imagerepositories.source.app
s.tanzu.vmware.com/tanzu-java-web-app-delivery
deployer            True    True      3m17s    apps.kappctrl.k14s.io/tanzu-j
ava-web-app

Messages
No messages found.

Pods
NAME                READY   STATUS    RESTARTS
AGE
tanzu-java-web-app-build-1-build-pod    0/1    Completed  0
5m25s
tanzu-java-web-app-config-writer-p47cg-pod 0/1    Completed  0
4m24s

Knative Services
NAME                READY   URL
tanzu-java-web-app  Ready   https://tanzu-java-web-app.dev-namespace.apps.
my-organization.com

```

3. After the workload is built and deployed, fetch the URL of the deployed app. The URL of the web app is in the **Knative Services** section at the bottom of the output of the `tanzu apps workload get` command:

```
tanzu apps workload get tanzu-java-web-app --namespace YOUR-DEVELOPER-NAMESPACE
```

Where `YOUR-DEVELOPER-NAMESPACE` is the namespace configured earlier.

The output looks similar to the following:

```

Knative Services
NAME                READY   URL
tanzu-java-web-app  Ready   https://tanzu-java-web-app.dev-namespace.apps.
my-organization.com

```

4. View the web app in your browser.

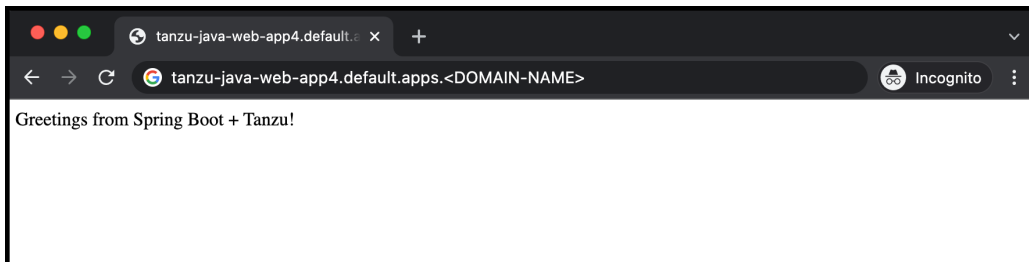

Add your application to Tanzu Developer Portal software catalog

1. Navigate to the home page of Tanzu Developer Portal and click **Home**, located on the left navigation pane.
2. Click **REGISTER ENTITY**.

Alternatively, you can add a link for the `catalog-info.yaml` to the `tap-values.yaml` configuration file in the `tap_gui.app_config.catalog.locations` section. For more information, see [Installing the Tanzu Application Platform Package and Profiles](#).

3. **Register an existing component** prompts you to type a repository URL. Type the link to the `catalog-info.yaml` file of the `tanzu-java-web-app` in the Git repository text box. For example, `https://github.com/USERNAME/PROJECTNAME/blob/main/catalog-info.yaml`.

Register an existing component

Start tracking your component in Tanzu Application Platform

The screenshot shows a wizard interface for registering an existing component. It consists of four steps in a vertical sequence:

- 1 Select URL**: This step is currently active. It features a text input field labeled "Repository URL *" with a placeholder text: "Enter the full path to your entity file to start tracking your component". Below the input field is a button labeled "ANALYZE".
- 2 Import Actions**: Labeled as "Optional".
- 3 Review**
- 4 Finish**

4. Click **ANALYZE**.
5. Review the catalog entities to be added and click **IMPORT**.
6. Navigate back to the home page. The catalog changes and entries are visible for further inspection.



Note

If your Tanzu Developer Portal instance does not have a [PostgreSQL](#) database configured, you must re-register the `catalog-info.yaml` location after the instance is restarted or upgraded.

Next steps

Now that you have your application deployed on your Tanzu Application Platform cluster, the next step is to iterate on your application.

- If you are an IntelliJ user, see the [Iterate on your new app using IntelliJ](#) guide.
- If you are a Visual Studio user, see the [Iterate on your new app using Visual Studio](#) guide.
- If you are a VS Code user, see the [Iterate on your new app using VS Code](#) guide.

Iterate on your new app using Tanzu Developer Tools for IntelliJ

This topic guides you through starting to iterate on your first application on Tanzu Application Platform (commonly known as TAP). You deployed the app in the previous how-to [Deploy your first application](#).

What you will do

- Prepare to iterate on your application.
 - Prepare your project to support Live Update.
 - Prepare your IDE to iterate on your application.
- Apply your application to the cluster.
- Live update your application to view code changes updating live on the cluster.
- Debug your application.
- Delete your application from the cluster.

Prepare to iterate on your application

In the previous Getting started how-to topic, [Deploy your first application](#), you deployed your first application on Tanzu Application Platform. Now that you have developed a skeleton workload, you are ready to begin to iterate on your new application and test code changes on the cluster.

Tanzu Developer Tools for IntelliJ is VMware Tanzu's official IDE extension for IntelliJ. It helps you develop and receive fast feedback on your workloads running on the Tanzu Application Platform.

The IntelliJ extension enables live updates of your application while running on the cluster and allows you to debug your application directly on the cluster.

For information about installing the prerequisites and the Tanzu Developer Tools for IntelliJ extension, see [Install Tanzu Developer Tools for IntelliJ](#).



Important

Use Tilt v0.30.12 or later for the sample application.

To prepare to iterate on your application, you must:

1. [Prepare your project to support Live Update](#)
2. [Set up the IDE](#)

Prepare your project to support Live Update

Tanzu Live Update uses [Tilt](#). This requires a suitable [Tiltfile](#) to exist at the root of your project. Both Gradle and Maven projects are supported, but each requires a [Tiltfile](#) specific to that type of project.

The Tanzu Java Web App accelerator allows you to choose between Maven and Gradle and includes a [Tiltfile](#). If you used the accelerator, your project is already set up correctly.

To verify your project is set up correctly, review the following requirements depending on your chosen build system.

Maven Spring Boot project requirements

If you are using Maven, your `Tiltfile` must be similar to the following:

```
SOURCE_IMAGE = os.getenv("SOURCE_IMAGE", default='your-registry.io/project/tanzu-java-
web-app-source')
LOCAL_PATH = os.getenv("LOCAL_PATH", default='.')
NAMESPACE = os.getenv("NAMESPACE", default='default')

k8s_custom_deploy(
  'tanzu-java-web-app',
  apply_cmd="tanzu apps workload apply -f config/workload.yaml --update-strategy rep
lace --debug --live-update" +
    " --local-path " + LOCAL_PATH +
    " --source-image " + SOURCE_IMAGE +
    " --namespace " + NAMESPACE +
    " --yes --output yaml",
  delete_cmd="tanzu apps workload delete -f config/workload.yaml --namespace " + NAM
ESPACE + " --yes",
  container_selector='workload',
  deps=['pom.xml', './target/classes'],
  live_update=[
    sync('./target/classes', '/workspace/BOOT-INF/classes')
  ]
)

k8s_resource('tanzu-java-web-app', port_forwards=["8080:8080"],
  extra_pod_selectors=[{'carto.run/workload-name': 'tanzu-java-web-app', 'ap
p.kubernetes.io/component': 'run'}])
```

Gradle Spring Boot project requirements

If you are using Gradle, review the following requirements:

- The `Tiltfile` looks like a [Maven Tiltfile](#) except for some key differences in the `deps=` and `live-update=` sections:

```
...
  deps=['build.gradle.kts', './build/classes/java/main', './build/resources/m
ain'],
  live_update=[
    sync('./build/classes/java/main', '/workspace/BOOT-INF/classes'),
    sync('./build/resources/main', '/workspace/BOOT-INF/classes')
  ]
  ...
```

- The project must be built as an exploded JAR. This is not the default behavior for a Gradle-based build. For a typical Spring Boot Gradle project, you must deactivate the `jar` task in the `build.gradle.kts` file as follows:

```
...
tasks.named<Jar>("jar") {
  enabled = false
}
```

Set up the IDE

After verifying your project has the required `Tiltfile` and Maven or Gradle build support, you are ready to set up your development environment.

1. Open the Tanzu Java Web App as a project within your IntelliJ IDE by selecting **File** > **Open**, then selecting the Tanzu Java Web App folder and clicking **Open**. If you don't have the Tanzu Java Web App you can obtain it by following the instructions in [Generate a new](#)

project using an [Application Accelerator](#), or from the [Application Accelerator Samples GitHub](#) page.

2. Confirm that your current Kubernetes context contains a default namespace. The Tanzu Panel, found by clicking **Tanzu Panel** at the bottom-left of the IntelliJ window, uses the default namespace associated with your current Kubernetes context to populate the workloads from the cluster.
 1. Open the Terminal by clicking **View > Terminal**.
 2. Ensure that your current context has a default namespace by running:

```
kubectl config get-contexts
```

This command returns a list of all of your Kubernetes contexts with an asterisk (*) in front of your current context. Verify that your current context has a namespace in the namespace column.

3. If your current context does not have a namespace in the namespace column, run:

```
kubectl config set-context --current --namespace=YOUR-DEVELOPER-NAMESPACE
```

Where `YOUR-DEVELOPER-NAMESPACE` is the namespace value you want to assign to your current Kubernetes context.

You are now ready to iterate on your application.

Apply your application to the cluster

Apply the workload to see your application running on the cluster:

1. In the **Project** tab in IntelliJ, right-click any file under the application name `tanzu-java-web-app` and click **Tanzu > Apply Workload**.
2. In the dialog box enter your **Source Image**, **Local Path**, and optionally a **Namespace**.
 1. [Customize the installation](#) of Local Source Proxy.

If you don't have Local Source Proxy configured, you can use the source image parameter instead. The source image value tells the Tanzu Developer Tools for IntelliJ extension where to publish the container image with your non-compiled source code, and what to name that image. The image must be published to a container image registry where you have write access. For example, `gcr.io/myteam/tanzu-java-web-app-source`.



Note

See the documentation for the registry you're using to find out which steps are necessary to authenticate and gain push access.

For example, if you use Docker, see the [Docker documentation](#), or if you use Harbor, see the [Harbor documentation](#).

2. In the **Local Path** text box, provide the path to the directory containing the Tanzu Java Web App. The current directory is the default.

The local path value tells the Tanzu Developer Tools for IntelliJ extension which directory on your local file system to bring into the source image. For example, dot (.) uses the working directory, or you can specify a full file path.

3. (Optional) In the **Namespace** text box, provide the namespace to be associated with the workload on the cluster. If you followed the steps to [Prepare your IDE to iterate on your application](#) earlier, you do not need to enter a namespace because IntelliJ uses the namespace you associated with your context.
4. Click the **OK** button.

The `apply workload` command runs, which opens a terminal and shows you the output of the command. The `apply workload` command can take a few minutes to deploy your application onto the cluster.

You can also use the **Tanzu Panel** to monitor your application as it's being deployed to the cluster. The **Tanzu Panel** shows information about the workloads in the namespace associated with your current Kubernetes context. On the left side, it shows the workloads in the namespace. In the center, it shows the details of the Kubernetes resources for the running workloads.

Enable Live Update for your application

Live Update allows you to save changes to your code and see those changes reflected within seconds in the workload running on the cluster.

To enable Live Update for your application:

1. Create a Run Configuration.
 1. In IntelliJ, select the **Edit Run/Debug configurations** drop-down menu at the top-right corner. Alternatively, navigate to **Run > Edit Configurations**.
 2. Select **Tanzu Live Update**.
 3. Select **Add new run configuration**, or click the plus icon at the top of the list.
 4. Give your new run configuration a name, for example, `Tanzu Live Update - tanzu-java-web-app`.
 5. In the **Tiltfile Path** text box, provide the path to the `Tiltfile` in the Tanzu Java Web App project directory.
 6. Select the folder icon on the right-side of the text box, go to the `Tanzu Java Web App` directory, select the `Tiltfile`, and click **Open**. The `Tiltfile` facilitates Live Update using Tilt.
 7. In the **Local Path** text box, provide the path to the directory containing the Tanzu Java Web App.

The local path value tells the Tanzu Developer Tools for IntelliJ extension which directory on your local file system to bring into the source image.

For example, `/Users/developer/Documents/tanzu-java-web-app`.

8. [Customize the installation](#) of Local Source Proxy.

If you don't have Local Source Proxy configured, you can use the source image parameter instead. The source image value tells the Tanzu Developer Tools for IntelliJ extension where to publish the container image with your non-compiled source code, and what to name that image. The image must be published to a container image registry where you have write access. For example, `gcr.io/myteam/tanzu-java-web-app-source`.



Note

See the documentation for the registry you're using to find out which steps are necessary to authenticate and gain push access.

For example, if you use Docker, see the [Docker documentation](#), or if you use Harbor, see the [Harbor documentation](#).

9. Click **Apply**, and then click the **OK** button.
2. Begin Live Updating the application on the cluster by doing one of the following:
 - o In the Project tab of IntelliJ, right-click the `Tiltfile` file under the application name `tanzu-java-web-app` and click **Run 'Tanzu Live Update - tanzu-java-web-app'**.
 - o Alternatively, click the **Edit Run/Debug configurations** drop-down menu in the top-right corner, select **Tanzu Live Update - tanzu-java-web-app**, and then click the green play button to the right of the **Edit Run/Debug configurations** drop-down menu.

The **Run** tab opens and displays the output from Tanzu Application Platform and from Tilt indicating that the container is being built and deployed.

On the **Tanzu Panel** tab, the status of Live Update is reflected under the `tanzu-java-web-app` workload entry. Live update can take up to three minutes while the workload deploys and the Knative service becomes available.



Note

Depending on the type of cluster you use, you might see an error similar to the following:

```
ERROR: Stop! cluster-name might be production. If you're sure you
want to deploy there, add: allow_k8s_contexts('cluster-name') to
your Tiltfile. Otherwise, switch k8scontexts and restart Tilt.
```

Follow the instructions and add the line, `allow_k8s_contexts('cluster-name')` to your `Tiltfile`.

3. When the Live Update task in the **Run** tab is successful, it resolves to `Live Update Started`. Use the hyperlink at the top of the Run output following the words **Tilt started on** to view your application in your browser.
4. In the IDE, make a change to the source code. For example, in `HelloController.java`, edit the string returned to say `Hello!` and save.
5. (Optional) Build your project by clicking **Build > Build Project** if you do not have **Build project automatically** activated under **Preferences > Build, Execution, Deployment > Compiler**.
6. The container is updated when the logs stop streaming. Navigate to your browser and refresh the page.
7. View the changes to your workload running on the cluster.
8. Either continue making changes, or stop the Live Update process when finished. To stop Live Update navigate to the **Run** tab at the bottom left of the IntelliJ window and click the red stop icon on the left side of the screen.

Debug your application

Debug the cluster either on the application or in your local environment.

To debug the cluster:

1. Set a breakpoint in your code. For example, in `HelloController.java`, set a breakpoint on the line returning text.
2. Create a Run Configuration.

1. In IntelliJ, select the **Edit Run/Debug configurations** drop-down menu at the top-right corner. Alternatively, navigate to **Run > Edit Configurations**.
2. Select **Tanzu Debug Workload**.
3. Select **Add new run configuration**, or click the plus icon at the top of the list.
4. Give your new run configuration a name, for example, `Tanzu Debug Workload - tanzu-java-web-app`.
5. In the **Workload File Path** text box, provide the path to the `workload.yaml` file in the Tanzu Java Web App project directory located at **Config > workload.yaml**.
6. Select the folder icon on the right-side of the text box, navigate to the Tanzu Java Web App directory, select the `workload.yaml` file and click the **Open** button. The `workload.yaml` provides configuration instructions about your application to the Tanzu Application Platform.
7. In the **Local Path** text box, provide the path to the directory containing the Tanzu Java Web App.

The local path value tells the Tanzu Developer Tools for IntelliJ extension which directory on your local file system to bring into the source image. For example, `/Users/developer/Documents/tanzu-java-web-app`.

8. [Customize the installation](#) of Local Source Proxy.

If you don't have Local Source Proxy configured, you can use the source image parameter instead. The source image value tells the Tanzu Developer Tools for IntelliJ extension where to publish the container image with your non-compiled source code, and what to name that image. The image must be published to a container image registry where you have write access. For example, `gcr.io/myteam/tanzu-java-web-app-source`.



Note

See the documentation for the registry you're using to find out which steps are necessary to authenticate and gain push access.

For example, if you use Docker, see the [Docker documentation](#), or if you use Harbor, see the [Harbor documentation](#).

9. (Optional) In the **Namespace** text box, provide the namespace to be associated with the workload on the cluster. If you followed the steps to [Prepare your IDE to iterate on your application](#), you do not need to enter a namespace because IntelliJ uses the namespace you associated with your context.
 10. Click **Apply**, and then click **OK**.
3. [Apply your application to the cluster](#).
 4. Obtain the URL for your workload:
 1. In the center panel of the **Tanzu Panel** go to **Workload/tanzu-java-web-app > Running Application > Service/tanzu-java-web-app**.
 2. Right-click the `Service/tanzu-java-web-app` entry and select **Describe**.

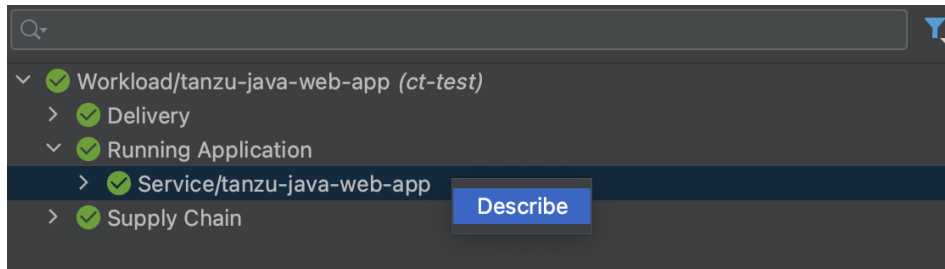

3. In the resulting output, copy the value after **Status > URL:** that begins with `https://tanzu-java-web-app...`. Make sure you copy the value from **Status > URL:** and *not* the value under **Status > Address > URL.**

```
Status:
Address:
  URL: http://tanzu-java-web-app.ct-test.svc.cluster.local
Conditions:
  Last Transition Time: 2023-03-30T23:56:50Z
  Status: True
  Type: ConfigurationsReady
  Last Transition Time: 2023-03-30T23:56:52Z
  Status: True
  Type: Ready
  Last Transition Time: 2023-03-30T23:56:52Z
  Status: True
  Type: RoutesReady
Latest Created Revision Name: tanzu-java-web-app-00001
Latest Ready Revision Name: tanzu-java-web-app-00001
Observed Generation: 1
Traffic:
  Latest Revision: true
  Percent: 100
  Revision Name: tanzu-java-web-app-00001
URL: https://tanzu-java-web-app.ct-test.desktop-dev-15-build-38.tlc.dev
Events: <none>
```

4. Open your web browser and paste the URL you copied to access your workload.
5. In the Project tab of IntelliJ, right-click the `workload.yaml` file under the application name `tanzu-java-web-app` and select **Run 'Tanzu Debug Workload - tanzu-java-web-app'** to begin debugging the application on the cluster.
 1. Alternatively, select the **Edit Run/Debug configurations** drop-down menu in the top-right corner, select **Tanzu Debug Workload - tanzu-java-web-app**, and then click the green debug button to the right of the **Edit Run/Debug configurations** drop-down menu.
6. The Debug tab opens and displays a message that it has connected.
7. In your web browser, reload your workload. IntelliJ opens to show your breakpoint.
8. You can now use the resume program action, or stop debugging, in the **Debug** tab.

Delete your application from the cluster

You can use the delete action to remove your application from the cluster as follows:

1. In the **Project** tab, right-click any file under the application name `tanzu-java-web-app` and select **Tanzu > Delete Workload**.
2. Alternatively, right-click `tanzu-java-web-app` in the **TANZU WORKLOADS** panel and select **Delete Workload**.

3. In the confirmation dialog box that appears, click **OK** to delete the application from the cluster.

Next steps

- [Consume services on Tanzu Application Platform](#)

Iterate on your new app using Tanzu Developer Tools for Visual Studio

This topic guides you through starting to iterate on your first application on Tanzu Application Platform (commonly known as TAP). You deployed the app in the previous how-to [Deploy your first application](#).

What you will do

- Prepare to iterate on your application.
 - Prepare your project to support Live Update.
 - Prepare your IDE to iterate on your application.
- Apply your application to the cluster.
- Live update your application to view code changes updating live on the cluster.
- Debug your application.
- Monitor your running application on the Application Live View UI.
- Delete your application from the cluster.

Prepare to iterate on your application

In the previous Getting started how-to topic, [Deploy your first application](#), you deployed your first application on Tanzu Application Platform. Now that you have developed a skeleton workload, you are ready to begin to iterate on your new application and test code changes on the cluster.

Tanzu Developer Tools for Visual Studio is VMware Tanzu's official IDE extension for Visual Studio. It helps you develop and receive fast feedback on your workloads running on the Tanzu Application Platform.

The Visual Studio extension enables live updates of your application while running on the cluster and allows you to debug your application directly on the cluster.

For information about installing the prerequisites and the Tanzu Developer Tools for Visual Studio extension, see [Install Tanzu Developer Tools for Visual Studio](#).



Important

Use Tilt v0.30.12 or later for the sample application.

To prepare to iterate on your application, you must:

1. [Prepare your project to support Live Update](#)
2. [Set up the IDE](#)

Prepare your project to support Live Update

Tanzu Live Update uses [Tilt](#). This requires a suitable [Tiltfile](#) to exist at the root of your project.

Your [Tiltfile](#) must be similar to the following:

```
SOURCE_IMAGE = os.getenv("SOURCE_IMAGE", default='your-registry.io/project/csharp-weatherforecast-source')
LOCAL_PATH = os.getenv("LOCAL_PATH", default='.')
NAMESPACE = os.getenv("NAMESPACE", default='default')
NAME = os.getenv("NAME", default='sample-app')

k8s_custom_deploy(
    NAME,
    apply_cmd="tanzu apps workload apply -f config/workload.yaml --update-strategy replace --debug --live-update" +
        " --local-path " + LOCAL_PATH +
        " --namespace " + NAMESPACE +
        " --yes --output yaml",
    delete_cmd="tanzu apps workload delete " + NAME + " --namespace " + NAMESPACE + " --yes",
    deps=['./bin'],
    container_selector='workload',
    live_update=[
        sync('./bin/Debug/net6.0', '/workspace')
    ]
)

k8s_resource('tanzu-java-web-app', port_forwards=["8080:8080"],
    extra_pod_selectors=[{'carto.run/workload-name': 'sample-app', 'app.kubernetes.io/component': 'run'}])
```

Set up the IDE

After verifying your project has the required [Tiltfile](#), you are ready to set up your development environment.

1. Open the Weather Forecast solution in Visual Studio by selecting **File > Open > Project/Solution....** If you don't have the Weather Forecast app you can obtain it by following the instructions in [Generate an application with Application Accelerator](#), or from the [Application Accelerator Samples GitHub](#) page.

You are now ready to iterate on your application.

Apply your application to the cluster

Apply the workload to see your application running on the cluster:

1. In **Solution Explorer**, right-click any file under the application name and click **Tanzu > Apply Workload**.
2. In the dialog box, enter the following:
 1. In the **Local Path** text box, provide the path to the directory containing the Weather Forecast app. The current directory is the default.

The local path value tells the Tanzu Developer Tools for Visual Studio extension which directory on your local file system to bring into the source image. For example, dot (.) uses the working directory, or you can specify a full file path.
 2. In the **Namespace** text box, provide the namespace to be associated with the workload on the cluster.
 3. (Optional) In the **Source Image** text box, provide the destination image repository to publish the image containing your workload source code.

The source image value tells the Tanzu Developer Tools for Visual Studio extension where to publish the container image with your uncompiled source code, and what to name that image. The image must be published to a container image registry where you have write (push) access. For example, `gcr.io/myteam/weather-forecast-source`.



Note

See the documentation for the registry you're using to find out which steps are necessary to authenticate and gain push access.

For example, if you use Docker, see the [Docker documentation](#), or if you use Harbor, see the [Harbor documentation](#).

4. Click the **OK** button.

The `apply workload` command runs and opens an output window in which you can monitor the output of the command. The `apply workload` command can take a few minutes to deploy your application onto the cluster.

Enable Live Update for your application

Live Update allows you to save changes to your code and see those changes reflected within seconds in the workload running on the cluster.

To enable Live Update for your application:

1. In **Solution Explorer**, right-click any file under the application name and click **Tanzu > Start Live Update**.
2. Live update can take up to three minutes while the workload deploys and the Knative service becomes available.



Note

Depending on the type of cluster you use, you might see an error similar to the following:

```
ERROR: Stop! cluster-name might be production. If you're sure you
want to deploy there, add: allow_k8s_contexts('cluster-name') to
your Tiltfile. Otherwise, switch k8scontexts and restart Tilt.
```

Follow the instructions and add the line, `allow_k8s_contexts('cluster-name')` to your `Tiltfile`.

3. In the IDE, make a change to the source code.
4. Build your project.
5. The container is updated when the logs stop streaming. Go to your browser and refresh the page.
6. View the changes to your workload running on the cluster.
7. Either continue making changes, or stop the Live Update process when finished. To stop Live Update, in **Solution Explorer**, right-click any file under the application name and click **Tanzu > Stop Live Update**.

Debug your application

Debug the cluster either on the application or in your local environment.

To start debugging the cluster:

1. Set a breakpoint in your code.
2. [Apply your application to the cluster](#).
3. In **Solution Explorer**, right-click any file under the application name and click **Tanzu > Debug Workload**.

To stop debugging the cluster:

1. In main, click **Debug > Detach All**

Delete your application from the cluster

You can use the delete action to remove your application from the cluster as follows:

1. In **Solution Explorer**, right-click any file under the application name and click **Tanzu > Delete Workload**.
2. In the confirmation dialog box that appears, click **OK** to delete the application from the cluster.

Next steps

- [Consume services on Tanzu Application Platform](#)

Iterate on your new app using Tanzu Developer Tools for VS Code

This topic guides you through starting to iterate on your first application on Tanzu Application Platform (commonly known as TAP). You deployed the app in the previous how-to [Deploy your first application](#).

What you will do

- Prepare to iterate on your application.
 - Prepare your project to support Live Update.
 - Prepare your IDE to iterate on your application.
- Apply your application to the cluster.
- Live update your application to view code changes updating live on the cluster.
- Debug your application.
- Monitor your running application on the Application Live View UI.
- Delete your application from the cluster.

Prepare to iterate on your application

In the previous Getting started how-to topic, [Deploy your first application](#), you deployed your first application on Tanzu Application Platform. Now that you have developed a skeleton workload, you are ready to begin to iterate on your new application and test code changes on the cluster.

Tanzu Developer Tools for VS Code is VMware Tanzu's official IDE extension for VS Code. It helps you develop and receive fast feedback on your workloads running on the Tanzu Application Platform.

The VS Code extension enables live updates of your application while running on the cluster and allows you to debug your application directly on the cluster. For information about installing the prerequisites and the Tanzu Developer Tools for VS Code extension, see [Install Tanzu Developer Tools for your VS Code](#).



Important

Use Tilt v0.30.12 or a later version for the sample application.

To prepare to iterate on your application, you must:

1. [Prepare your project to support Live Update](#)
2. [Set up the IDE](#)

Prepare your project to support Live Update

Tanzu Live Update uses [Tilt](#). This requires a suitable [Tiltfile](#) to exist at the root of your project. Both Gradle and Maven projects are supported, but each requires a [Tiltfile](#) specific to that type of project.

The Tanzu Java Web App accelerator allows you to choose between Maven and Gradle and includes a [Tiltfile](#). If you used the accelerator, your project is already set up correctly.

To verify your project is set up correctly, review the following requirements depending on your chosen build system.

Maven Spring Boot project requirements

If you are using Maven, your [Tiltfile](#) must be similar to the following:

```
SOURCE_IMAGE = os.getenv("SOURCE_IMAGE", default='your-registry.io/project/tanzu-java-web-app-source')
LOCAL_PATH = os.getenv("LOCAL_PATH", default='.')
NAMESPACE = os.getenv("NAMESPACE", default='default')

k8s_custom_deploy(
  'tanzu-java-web-app',
  apply_cmd="tanzu apps workload apply -f config/workload.yaml --update-strategy replace --debug --live-update" +
    " --local-path " + LOCAL_PATH +
    " --source-image " + SOURCE_IMAGE +
    " --namespace " + NAMESPACE +
    " --yes --output yaml",
  delete_cmd="tanzu apps workload delete -f config/workload.yaml --namespace " + NAMESPACE + " --yes",
  container_selector='workload',
  deps=['pom.xml', './target/classes'],
  live_update=[
    sync('./target/classes', '/workspace/BOOT-INF/classes')
  ]
)

k8s_resource('tanzu-java-web-app', port_forwards=["8080:8080"],
  extra_pod_selectors=[{'carto.run/workload-name': 'tanzu-java-web-app', 'app.p.kubernetes.io/component': 'run'}])
```

Gradle Spring Boot project requirements

If you are using Gradle, review the following requirements:

- The `Tiltfile` looks like a [Maven Tiltfile](#) except for some key differences in the `deps=` and `live-update=` sections:

```
...
deps=['build.gradle.kts', './bin/main'],
live_update=[
    sync('./bin/main', '/workspace/BOOT-INF/classes')
]
...
```

- The project must be built as an exploded JAR. This is not the default behavior for a Gradle-based build. For a typical Spring Boot Gradle project, you must deactivate the `jar` task in the `build.gradle.kts` file as follows:

```
...
tasks.named<Jar>("jar") {
    enabled = false
}
```

Set up the IDE

After verifying your project has the required `Tiltfile` and Maven or Gradle build support, you are ready to set up your development environment.

1. Open the Tanzu Java Web App as a project within your VS Code IDE by clicking **File** > **Open Folder**, select the Tanzu Java Web App folder and click **Open**.

If you don't have the Tanzu Java Web App you can obtain it by following the instructions in [Generate a new project using an Application Accelerator](#), or from the [Application Accelerator Samples GitHub](#) page.

2. To ensure that your extension assists you with iterating on the correct project, configure its settings as follows:

1. In Visual Studio Code, navigate to **Preferences** > **Settings** > **Extensions** > **Tanzu Developer Tools**.

2. In the **Local Path** text box, provide the path to the directory containing the Tanzu Java Web App. The current directory is the default.

The local path value tells the Tanzu Developer Tools for VS Code extension which directory on your local file system to bring into the source image. For example, dot (.) uses the working directory, or you can specify a full file path.

3. [Customize the installation](#) of Local Source Proxy.

If you don't have Local Source Proxy configured, you can use the source image parameter instead. The source image value tells the Tanzu Developer Tools for VS Code extension where to publish the container image with your non-compiled source code, and what to name that image. The image must be published to a container image registry where you have write access. For example, `gcr.io/myteam/tanzu-java-web-app-source`.



Note

See the documentation for the registry you're using to find out which steps are necessary to authenticate and gain push access.

For example, if you use Docker, see the [Docker documentation](#), or if you use Harbor, see the [Harbor documentation](#).

For troubleshooting failed registry authentication, see [Troubleshoot using Tanzu Application Platform](#)

3. Confirm that your current Kubernetes context has a namespace associated with it. The **TANZU WORKLOADS** section of the **Explorer** view in the left Side Bar uses the namespace associated with your current Kubernetes context to populate the workloads from the cluster.
 1. Open the Terminal by clicking **View > Terminal**.
 2. Ensure your current context has a default namespace by running:

```
kubectl config get-contexts
```

This command returns a list of all of your Kubernetes contexts with an asterisk (*) in front of your current context. Verify that your current context has a namespace in the namespace column.

3. If your current context does not have a namespace in the namespace column, run:

```
kubectl config set-context --current --namespace=YOUR-DEVELOPER-NAMESPACE
```

Where **YOUR-DEVELOPER-NAMESPACE** is the namespace value you want to assign to your current Kubernetes context.

You are now ready to iterate on your application.

Apply your application to the cluster

Apply the workload to see your application running on the cluster by doing one of the following:

- In the **Explorer** view in the left Side Bar, right-click any file under the application name `tanzu-java-web-app` and click **Tanzu: Apply Workload** to begin applying the workload to the cluster.
- Alternatively, use the Command Palette, ⌘P on Mac and Ctrl+Shift+P on Windows or **View > Command Palette**, to run the `Tanzu: Apply Workload` command.

The `apply workload` command runs, which opens a terminal and shows you the output of the workload apply.

You can also monitor your application as it's being deployed to the cluster using the **TANZU ACTIVITY** tab in the Panel at the bottom of VS Code. The **TANZU ACTIVITY** tab shows the details of the Kubernetes resources for the workloads running in the namespace associated with your current Kubernetes context.

To view the **TANZU ACTIVITY** tab, open the Panel at the bottom of VS Code (**View > Appearance > Panel**) and then click the **TANZU ACTIVITY** tab. The apply workload command can take a few minutes to deploy your application onto the cluster. After complete, you can see the workload running in the **TANZU WORKLOADS** section of the **Explorer** view in the left Side Bar.

Enable Live Update for your application

Live Update allows you to save changes to your code and see those changes reflected within seconds in the workload running on the cluster.

To enable Live Update for your application:

1. To begin Live Updating the workload on the cluster, do one of the following:
 - o In the **Explorer** view in the left Side Bar, right-click any file under the application name `tanzu-java-web-app` and click `Tanzu: Live Update Start`.
 - o Right-click the `tanzu-java-web-app` in the **TANZU WORKLOADS** section of the **Explorer** view and click `Tanzu: Live Update Start`.
 - o From the Command Palette, ⌘P on Mac and Ctrl+Shift+P on Windows, type in and select `Tanzu: Live Update Start`.

You can view output from Tanzu Application Platform indicating that the container is being built and deployed.

The status of Live Update is reflected in the **TANZU WORKLOADS** view under the `tanzu-java-web-app` workload entry. You can also see `Live Update starting...` in the status bar at the bottom right. Live update can take up to three minutes while the workload deploys and the Knative service becomes available.



Note

Depending on the type of cluster you use, you might see an error similar to the following:

```
ERROR: Stop! cluster-name might be production. If you're sure you
want to deploy there, add: allow_k8s_contexts('cluster-name') to
your Tiltfile. Otherwise, switch k8scontexts and restart Tilt.
```

Follow the instructions and add the line, `allow_k8s_contexts('cluster-name')` to your `Tiltfile`.

2. When the Live Update status in the **TANZU WORKLOADS** view changes from `Live Update Stopped` to `Live Update Running`, navigate to `http://localhost:8080` in your browser to view your running application.
3. In the IDE, make a change to the source code. For example, in `HelloController.java`, edit the string returned to say `Hello!`, and save.
4. The container is updated when the logs stop streaming. Go to your browser and refresh the page.
5. View the changes to the workload running on the cluster.
6. Either continue making changes, or stop the Live Update process when finished. To stop Live Update, open the Terminal by navigating to **View > Terminal**, and click the trash can icon that appears when you place your hover over the `tilt: up - tanzu-java-web-app` process, or select the process and use hot key ⌘+Backspace.

Debug your application

Debug your application in a production-like environment by debugging on your Kubernetes cluster.

To debug the cluster:

1. Set a breakpoint in your code. For example, in `HelloController.java`, set a breakpoint on the line returning text.
2. [Apply your application to the cluster](#).
3. Open the Panel at the bottom of VS Code by clicking **View > Appearance > Panel**.
4. In the Panel, click the **TANZU ACTIVITY** tab.

- In the **TANZU ACTIVITY** tab, go to **Workload/tanzu-java-web-app > Running Application > Service/tanzu-java-web-app**.
- Right-click the **Pod...** entry and select **Describe**.

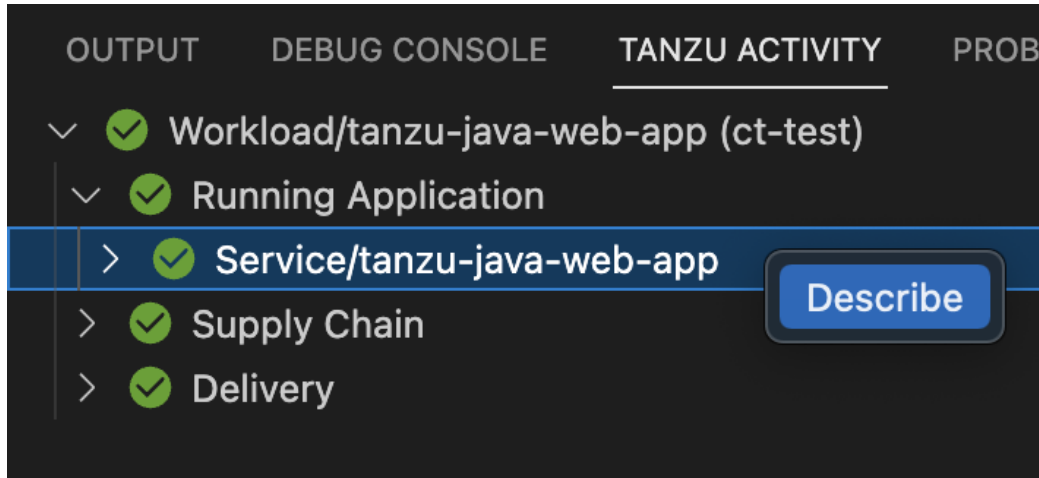

- In resulting output, copy the value after **Status > URL:** that begins with `https://tanzu-java-web-app...`. Make sure you copy the value from **Status > URL:** and *not* the value under **Status > Address > URL**.

```

Status:
Address:
  URL: http://tanzu-java-web-app.ct-test.svc.cluster.local
Conditions:
  Last Transition Time:      2023-03-30T23:56:50Z
  Status:                   True
  Type:                     ConfigurationsReady
  Last Transition Time:      2023-03-30T23:56:52Z
  Status:                   True
  Type:                     Ready
  Last Transition Time:      2023-03-30T23:56:52Z
  Status:                   True
  Type:                     RoutesReady
Latest Created Revision Name: tanzu-java-web-app-00001
Latest Ready Revision Name:  tanzu-java-web-app-00001
Observed Generation:        1
Traffic:
  Latest Revision: true
  Percent:         100
  Revision Name:   tanzu-java-web-app-00001
  URL:             https://tanzu-java-web-app.ct-test.desktop-dev-15-build-38.tlc.dev
Events:           <none>

```

- Open your web browser and paste the URL you copied to access your workload.
- Begin debugging the workload on the cluster by doing one of the following:
 - In the **Explorer** view in the left Side Bar, right-click any file under the application name `tanzu-java-web-app` and click **Tanzu: Java Debug Start**.
 - Alternatively, right-click the `tanzu-java-web-app` in the **TANZU WORKLOADS** view and click **Tanzu: Java Debug Start**.
- In a few moments, debugging is enabled on the workload. The **Deploy and Connect** task completes and the debug actions are made available to you in the debug overlay, indicating that the debugger has attached.

The **TANZU WORKLOADS** view shows **Debug Running** under the `tanzu-java-web-app` workload.
- In your web browser, reload your workload. VS Code opens to show your breakpoint.
- You can now continue the program, or stop debugging, using the debug controls overlay.

Monitor your running application

Inspect the runtime characteristics of your running application using the Application Live View UI to monitor:

- Resource consumption
- Java Virtual Machine (JVM) status
- Incoming traffic
- Change log level

You can also troubleshoot environment variables and fine-tune the running application.

Use the following steps to diagnose Spring Boot-based applications by using Application Live View:

1. Confirm that the Application Live View components are installed. For instructions, see [Install Application Live View](#).
2. Access the Application Live View UI plug-in in Tanzu Developer Portal (formerly named Tanzu Application Platform GUI). For instructions, see [Entry point to Application Live View plug-in](#).
3. Select your running application to view the diagnostic options and inside the application. For more information, see [Application Live View features](#).

Delete your application from the cluster

You can use the delete action to remove your application from the cluster by doing one of the following:

- In the **Explorer** view in the left Side Bar, right-click any file under the application name `tanzu-java-web-app` and click **Tanzu: Delete Workload** to delete the workload from the cluster.
- Alternatively, right-click the `tanzu-java-web-app` in the **TANZU WORKLOADS** view and click **Tanzu: Delete Workload**.

Next steps

- [Consume services on Tanzu Application Platform](#)

Claim services on Tanzu Application Platform

This topic for application operators guides you through claiming a service instance and therefore making credentials available to workloads within your namespace. The topic uses RabbitMQ as an example, but the process is the same regardless of the service you want to consume.

You will use the `tanzu service` CLI plug-in and will learn about classes, claims, and bindings.

What you will do

- Discover the range of services available to you
- Create a claim for an instance of one of the services

Overview

The following diagram depicts a summary of what this tutorial covers.

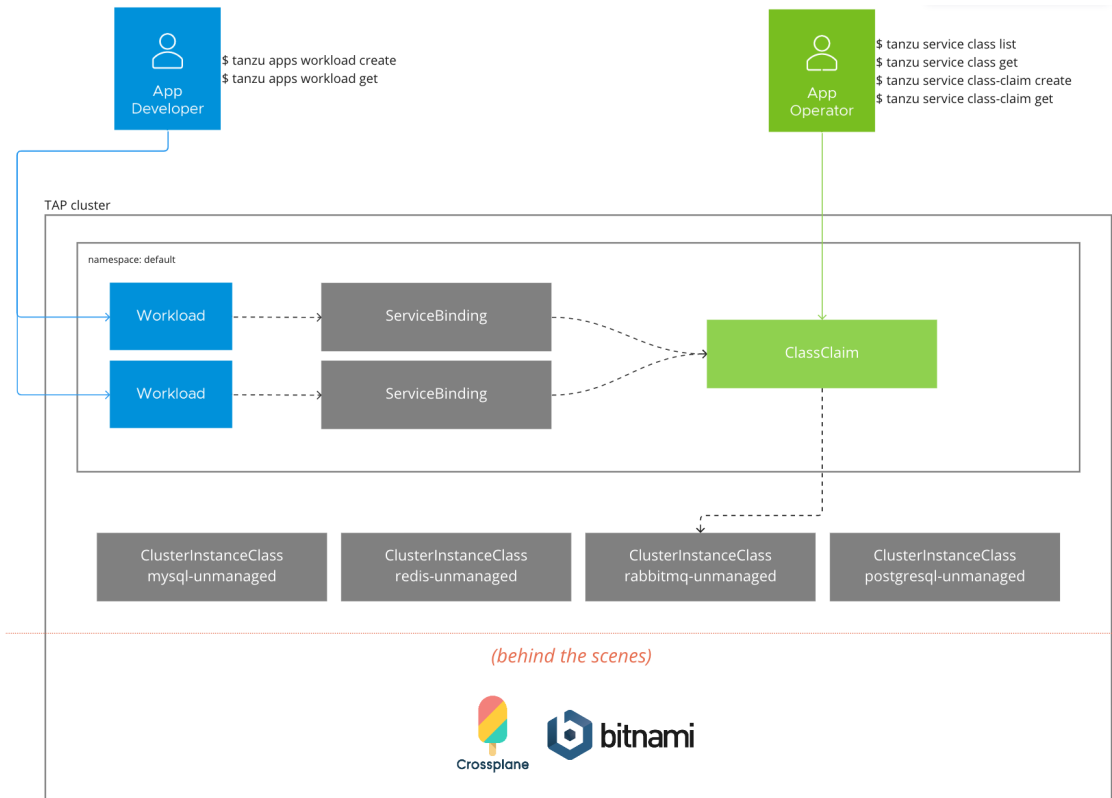

Bear the following observations in mind as you work through this guide:

1. There are a set of four service classes preinstalled on the cluster.
2. Service operators do not need to configure or setup these four services.
3. The life cycle of a service binding is implicitly tied to the life cycle of a workload, and is managed by the application developer.
4. The life cycles of claims are explicitly managed by the application operator.
5. The diagram and tutorial in this guide are predominantly focused on the application operator, therefore the inner workings of how service instances are provisioned are not in the diagram and are labeled as “behind the scenes”.

Prerequisites

Before following this tutorial, an application operator must:

1. Have access to a cluster with Tanzu Application Platform installed.
2. Have the Tanzu CLI and the corresponding plug-ins.
3. Have access to the `default` namespace which has been set up to use installed packages. For more information, see [Set up developer namespaces to use your installed packages](#).

Discover available services

This section covers using `tanzu service class list` and `tanzu service class get` to find information about the classes of services.

- To discover the range of available services, run the `tanzu service class list` command:

```
tanzu service class list
```

Expected output:

NAME	DESCRIPTION
mysql-unmanaged	MySQL by Bitnami
postgresql-unmanaged	PostgreSQL by Bitnami
rabbitmq-unmanaged	RabbitMQ by Bitnami
redis-unmanaged	Redis by Bitnami

The output lists four classes that cover a range of services: MySQL, PostgreSQL, RabbitMQ and Redis. This is the default set of services that come preconfigured with Tanzu Application Platform. They are backed by Bitnami Helm charts that run on the Tanzu Application Platform cluster. You can consider these to be unmanaged services with no guarantees of service provided.

- To see more detailed information for a class, run the `tanzu service class get` command:

```
tanzu service class get rabbitmq-unmanaged
```

Expected output:

```
NAME:          rabbitmq-unmanaged
DESCRIPTION:   RabbitMQ by Bitnami
READY:        true

PARAMETERS:
  KEY          DESCRIPTION
TYPE          DEFAULT  REQUIRED
replicas      The desired number of replicas forming the cluster
integer 1      false
storageGB     The desired storage capacity of a single replica, in Gigabytes.
integer 1      false
```

The `PARAMETERS` section is of particular interest because it lists the range of configuration options available to you when creating a claim for the given class.

Create a claim for a service instance

This section covers using `tanzu service class-claim create` to create a claim for an instance of a class and using `tanzu service class-claim get` to get detailed information about the status of the claim.

- To create a claim for an instance of a class, run the `tanzu service class-claim create` command:

```
tanzu service class-claim create rabbitmq-1 --class rabbitmq-unmanaged --parameter storageGB=3
```

In this example, you create a claim for the `rabbitmq-unmanaged` class and pass a parameter to the command to set the storage capacity of the resulting instance to 3 Gigabytes, rather than using the default 1 Gigabyte.

Expected output:

```
Creating claim 'rabbitmq-1' in namespace 'default'.
```

- To get detailed information about the claim, run the `tanzu service class-claim get` command:

```
tanzu service class-claim get rabbitmq-1
```

Expected output:

```

Name: rabbitmq-1
Namespace: default
Claim Reference: services.apps.tanzu.vmware.com/v1alpha1:ClassClaim:rabbitmq-1
Class Reference:
  Name: rabbitmq-unmanaged
Parameters:
  storageGB: 3
Status:
  Ready: True
  Claimed Resource:
    Name: b5982046-ale9-40cf-8282-00fe67a2f868
    Namespace: default
    Group:
    Version: v1
    Kind: Secret

```

It might take a moment or two for the claim to report `Ready: True`.

In the background, the creation of the claim triggers the on-demand creation of a Helm release of the Bitnami RabbitMQ Helm chart. Credentials and connectivity information required to connect to the RabbitMQ cluster are formatted according to the [Service Binding Specification for Kubernetes](#) and stored in a `Secret` in your namespace.

As an application operator you don't need to know what's happening in the background. Tanzu Application Platform promotes a strong separation of concerns between service operators, who are responsible for managing service instances for the platform, and application operators, who want to use those service instances with their application workloads. The class and claims abstractions enable that separation of concerns. Application operators create claims and service operators help to fulfil them.

Now that you have a claim for a RabbitMQ service instance, you can now follow instructions to [Consume services on Tanzu Application Platform](#).

Learn more

To learn more about working with services on Tanzu Application Platform, see the [Services Toolkit component documentation](#):

- [Tutorials](#)
- [How-to guides](#)
- [Explanations](#)
- [Reference material](#)

Next steps

Now that you completed the Getting started guides, learn about:

- [Multicluster Tanzu Application Platform](#)

Consume services on Tanzu Application Platform

This topic for application developers guides you through deploying two application workloads and configuring them to communicate using a service instance. The topic uses RabbitMQ as an example, but the process is the same regardless of the service you want to consume.

You will use the Tanzu Service CLI plug-in and will learn about classes, claims, and bindings.

What you will do

- Discover existing claims on service instances within your namespace
- Create two application workloads and bind them to an existing claim so that the workloads use the service instance.

Overview

The following diagram depicts a summary of what this tutorial covers.

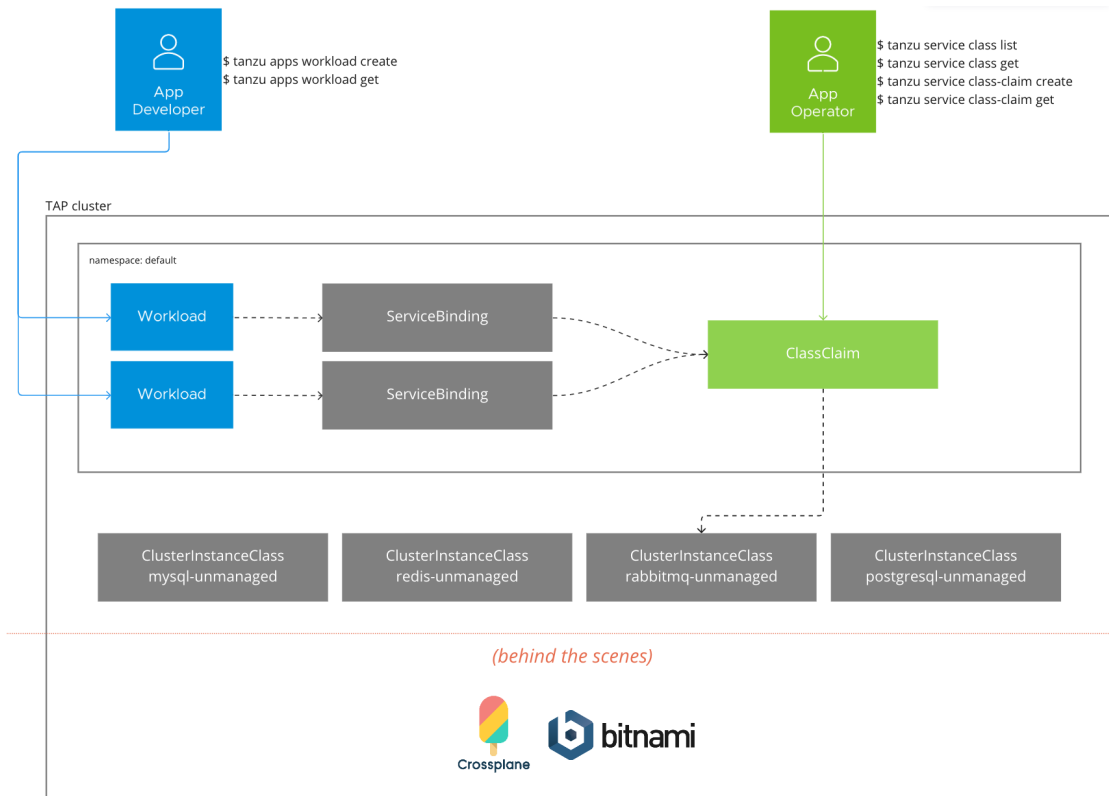

Bear the following observations in mind as you work through this guide:

1. There is a set of four service classes preinstalled on the cluster.
2. Service operators do not need to configure or setup these four services.
3. The life cycle of a service binding is implicitly tied to the life cycle of a workload, and is managed by the application developer.
4. The life cycles of claims are explicitly managed by the application operator.
5. The diagram and tutorial in this guide are predominantly focused on the application operator and developer user roles, as such the inner workings of how service instances are provisioned are not in the diagram and are labeled as “behind the scenes”.

Prerequisites

Before following this tutorial, an application developer must:

1. Have access to a cluster with Tanzu Application Platform installed.
2. Have the Tanzu CLI and the corresponding plug-ins.
3. Have access to the `default` namespace which has been set up to use installed packages. For more information, see [Set up developer namespaces to use your installed packages](#).

4. Have a Tanzu Application Platform cluster that can pull source code from GitHub.

Discovering existing claims

This section covers using `tanzu service class-claim list` and `tanzu service class-claim get` to discover existing claims within your namespace and obtaining information needed to bind your workload to them.

1. To get the list of claims within your namespace, run:

```
tanzu service class-claim list
```

Expected output:

NAME	CLASS	READY	REASON
rabbitmq-1	rabbitmq-unmanaged	True	Ready

2. To get detailed information about the claim, run:

```
tanzu service class-claim get rabbitmq-1
```

Expected output:

```
Name: rabbitmq-1
Namespace: default
Claim Reference: services.apps.tanzu.vmware.com/v1alpha1:ClassClaim:rabbitmq-1
Class Reference:
  Name: rabbitmq-unmanaged
Parameters:
  storageGB: 3
Status:
  Ready: True
  Claimed Resource:
    Name: b5982046-a1e9-40cf-8282-00fe67a2f868
    Namespace: default
    Group:
    Version: v1
    Kind: Secret
```

Binding application workloads to the service instance

This section covers using `tanzu apps workload create` with the `--service-ref` flag to create workloads and to bind them to the service instance through the claim.

In Tanzu Application Platform, service bindings are created when you create application workloads using the `--service-ref` flag of the `tanzu apps workload create` command.

To create an application workload:

1. Review the output of the `tanzu service class-claim get` command you ran in [Discovering existing claims](#) earlier, and note the value of the `Claim Reference`. This is the value to pass to `--service-ref` when creating the application workloads.
2. Create the application workload by running:

```
tanzu apps workload create spring-sensors-consumer-web \
  --git-repo https://github.com/tanzu-end-to-end/spring-sensors \
  --git-branch rabbit \
  --type web \
  --label app.kubernetes.io/part-of=spring-sensors \
```

```

--annotation autoscaling.knative.dev/minScale=1 \
--service-ref="rmq=services.apps.tanzu.vmware.com/v1alpha1:ClassClaim:rabbitmq-1"

tanzu apps workload create \
  spring-sensors-producer \
  --git-repo https://github.com/tanzu-end-to-end/spring-sensors-sensor \
  --git-branch main \
  --type web \
  --label app.kubernetes.io/part-of=spring-sensors \
  --annotation autoscaling.knative.dev/minScale=1 \
  --service-ref="rmq=services.apps.tanzu.vmware.com/v1alpha1:ClassClaim:rabbitmq-1"

```

3. After the workloads are ready, visit the URL of the `spring-sensors-consumer-web` app. Confirm that sensor data is passing from the `spring-sensors-producer` workload to the `spring-sensors-consumer-web` workload using the `RabbitmqCluster` service instance.

Learn more

To learn more about working with services on Tanzu Application Platform, see the [Services Toolkit component documentation](#):

- [Tutorials](#)
- [How-to guides](#)
- [Concepts](#)
- [Reference material](#)

Next steps

Now that you completed the Getting started guides, learn about:

- [Multicluster Tanzu Application Platform](#)

Deploy an air-gapped workload on Tanzu Application Platform

This topic for developers guides you through deploying your first workload on Tanzu Application Platform (commonly known as TAP) in an air-gapped environment.

For information about installing Tanzu Application Platform in an air-gapped environment, see [Install Tanzu Application Platform in an air-gapped environment](#).

What you will do

- Create a workload from Git.
- Create a basic supply chain workload.
- Create a testing supply chain workload.
- Create a testing scanning supply chain workload.

Prerequisites

Before you begin, a Platform operator must configure the air-gapped environment using Namespace Provisioner. For instructions, see [Work with Git repositories in air-gapped environments with Namespace Provisioner](#).

Create a workload from Git

To create a workload from Git through HTTPS, follow these steps:

1. (Optional) To pass in login credentials for a Git repository with the certificate authority (CA) certificate, create a file called `git-credentials.yaml`. For example:

```
apiVersion: v1
kind: Secret
metadata:
  name: git-ca
  # namespace: default
type: Opaque
stringData:
  username: USERNAME
  password: PASSWORD
  caFile: |
    CADATA
```

Where:

- `USERNAME` is the user name.
 - `PASSWORD` is the password.
 - `CADATA` is the PEM-encoded CA certificate for the Git repository.
2. To pass in a custom `settings.xml` for Java, create a file called `settings-xml.yaml`. For example:

```
apiVersion: v1
kind: Secret
metadata:
  name: settings-xml
type: service.binding/maven
stringData:
  type: maven
  provider: sample
  settings.xml: |
    <settings xmlns="http://maven.apache.org/SETTINGS/1.0.0" xmlns:xsi="http://
www.w3.org/2001/XMLSchema-instance"
      xsi:schemaLocation="http://maven.apache.org/SETTINGS/1.0.0 http://maven.
apache.org/xsd/settings-1.0.0.xsd">
      <mirrors>
        <mirror>
          <id>repsilite</id>
          <name>Tanzu seal Internal Repo</name>
          <url>https://repsilite.tap-trust.cf-app.com/releases</url>
          <mirrorOf>*</mirrorOf>
        </mirror>
      </mirrors>
      <servers>
        <server>
          <id>repsilite</id>
          <username>USERNAME</username>
          <password>PASSWORD</password>
        </server>
      </servers>
    </settings>
```

3. Apply the file:

```
kubect1 create -f settings-xml.yaml -n DEVELOPER-NAMESPACE
```

Create a basic supply chain workload

Next, create your basic supply chain workload.

To pass the CA certificate in when you create the workload, run:

```
tanzu apps workload create APP-NAME --git-repo https://GITREPO --git-branch BRANCH --
type web --label app.kubernetes.io/part-of=CATALOGNAME --yes --param-yaml buildService
Bindings='[{"name": "settings-xml", "kind": "Secret"}]' --param "gitops_ssh_secret=git
-ca"
```

Create a testing supply chain workload

For instructions about creating a workload with the testing supply chain, see [Install OOTB Supply Chain with Testing](#).

To add the Tekton supply chain to the cluster, apply the following YAML to the cluster:

```
apiVersion: tekton.dev/v1beta1
kind: Pipeline
metadata:
  name: developer-defined-tekton-pipeline
  labels:
    apps.tanzu.vmware.com/pipeline: test      # (!) required
spec:
  params:
    - name: source-url                        # (!) required
    - name: source-revision                  # (!) required
  tasks:
    - name: test
      params:
        - name: source-url
          value: $(params.source-url)
        - name: source-revision
          value: $(params.source-revision)
      taskSpec:
        params:
          - name: source-url
          - name: source-revision
        steps:
          - name: test
            image: MY-REGISTRY/gradle
            script: |-
              cd `mktemp -d`
```

Where **MY-REGISTRY** is your container image registry. Relocate all the images given in the pipeline YAML to your private container registry.

Create the workload by running:

```
tanzu apps workload create APP-NAME --git-repo https://GITURL --git-branch BRANCH --t
ype web --label app.kubernetes.io/part-of=CATALOGNAME --yes --param-yaml --label apps.
tanzu.vmware.com/has-tests=true buildServiceBindings='[{"name": "settings-xml", "kin
d": "Secret"}]'
```

To instead pass the CA certificate when you create the workload, run:

```
tanzu apps workload create APP-NAME --git-repo https://GITREPO --git-branch BRANCH --
type web --label app.kubernetes.io/part-of=CATALOGNAME --yes --param-yaml --label app
s.tanzu.vmware.com/has-tests=true buildServiceBindings='[{"name": "settings-xml", "kin
d": "Secret"}]' --param "gitops_ssh_secret=git-ca"
```

Create a testing scanning supply chain workload

For instructions about creating a workload with the testing and scanning supply chain, see [Install OOTB Supply Chain with Testing and Scanning](#).

In addition to the prerequisites given at [Prerequisites](#), follow [Using Grype in offline and air-gapped environments](#) before workload creation.

Create workload by running:

```
tanzu apps workload create APP-NAME --git-repo https://GITURL --git-branch BRANCH --type web --label app.kubernetes.io/part-of=CATALOGNAME --yes --param-yaml --label apps.tanzu.vmware.com/has-tests=true buildServiceBindings='[{"name": "settings-xml", "kind": "Secret"}]'
```

To instead pass the CA certificate when you create the workload, run:

```
tanzu apps workload create APP-NAME --git-repo https://GITREPO --git-branch BRANCH --type web --label app.kubernetes.io/part-of=CATALOGNAME --yes --param-yaml --label apps.tanzu.vmware.com/has-tests=true buildServiceBindings='[{"name": "settings-xml", "kind": "Secret"}]'
```

Deploy Spring Cloud applications to Tanzu Application Platform

This sub-section tells you how to run Spring applications that rely on various Spring Cloud services as workloads on Tanzu Application Platform (commonly known as TAP).

In this sub-section:

- [Deploy Spring Cloud Config applications](#)
- [Deploy Spring Cloud DiscoveryClient applications](#)
- [Use Spring Cloud Gateway for Kubernetes](#)

Deploy Spring Cloud applications to Tanzu Application Platform

This sub-section tells you how to run Spring applications that rely on various Spring Cloud services as workloads on Tanzu Application Platform (commonly known as TAP).

In this sub-section:

- [Deploy Spring Cloud Config applications](#)
- [Deploy Spring Cloud DiscoveryClient applications](#)
- [Use Spring Cloud Gateway for Kubernetes](#)

Deploy Spring Cloud Config applications to Tanzu Application Platform

This topic tells you how to run Spring applications that depend on Spring Cloud Config Server as workloads on Tanzu Application Platform (commonly known as TAP).

Identify Spring Cloud Config applications

The [Spring Cloud Config project](#) is used within many common configuration services for Spring applications, including the following:

- The [Config Server](#) in the managed service tile Spring Cloud Services for VMware Tanzu that is supported by VMware Tanzu Application Service for VMs.
- [Application Configuration Service for Tanzu](#) in Azure Spring Apps. For more information about Azure Spring Apps, see the [Microsoft Azure documentation](#).

Spring applications that use these configuration services often include a client dependency that interacts with the Spring Cloud Config Server:

- Applications that use the Spring Cloud Services Config Server on Tanzu Application Service typically include the `spring-cloud-services-starter-config-client` dependency from the `io.pivotal.spring.cloud` group. For more information, see the [Config Server](#) in the Spring Cloud Services documentation.
- Applications that use the open-source Spring Cloud Config Server typically include the `spring-cloud-starter-config` dependency from the `org.springframework.cloud` group. For more information, see the [Spring Cloud Config documentation](#).

Prerequisites

Before you can deploy Spring Cloud Config applications, you must [Install Application Configuration Service for VMware Tanzu](#).

The Application Configuration Service for VMware Tanzu component in Tanzu Application Platform distributes configuration information to applications through Kubernetes Secrets that contain Spring properties.

Configure workloads

For instructions for how to run existing Spring applications that rely on the Spring Cloud Config Server as workloads in Tanzu Application Platform, see [Configuring Workloads in Tanzu Application Platform using Application Configuration Service](#) in the Application Configuration Service for VMware Tanzu documentation.

Deploy Spring Cloud DiscoveryClient applications to Tanzu Application Platform

This topic tells you how to run Spring applications that use the Spring Cloud DiscoveryClient as workloads on Tanzu Application Platform (commonly known as TAP).

Identify Spring Cloud DiscoveryClient applications

The Spring Cloud DiscoveryClient abstraction underlies several common libraries and services for Spring applications to register themselves as services for other applications and to look up connection details of registered applications. These services include the following:

- The [Service Registry](#) in the managed service tile Spring Cloud Services for VMware Tanzu supported by VMware Tanzu Application Service for VMs.
- The [Tanzu Service Registry](#) in Azure Spring Apps. For more information about Azure Spring Apps, see the [Microsoft Azure documentation](#).
- The [Spring Cloud Netflix](#) project, which includes the Eureka client library and the Eureka server.

Spring applications that use these discovery services include a client dependency that implements the Spring Cloud DiscoveryClient:

- Applications that use the Spring Cloud Services Service Registry on Tanzu Application Service typically include the `spring-cloud-services-starter-service-registry` dependency from the `io.pivotal.spring.cloud` group. For more information, see [Service Registry](#) in the Spring Cloud Services documentation.
- Applications that use the Tanzu Service Registry in Azure Spring Apps or that use the Spring Cloud Netflix libraries typically include the `spring-cloud-starter-netflix-eureka-client` dependency from the `org.springframework.cloud` group. For more information about how to use the Tanzu Service Registry, see the [Microsoft Azure documentation](#). For more information about how to include Eureka Client, see the [Spring documentation](#).

Each of these client dependencies includes the [Spring Cloud SimpleDiscoveryClient](#) from the Spring Cloud Commons project as a base dependency. The approach in this topic uses this common dependency to configure service resolution for client applications.

Prerequisites

Before you can continue with the example in this topic, you must [Install Application Configuration Service for VMware Tanzu](#).

In this example, the Application Configuration Service for VMware Tanzu component in Tanzu Application Platform distributes service discovery information to client applications as Spring properties.

Example: The Greeting application

The following sections show how to run the [Greeting](#) sample application as a pair of workloads on Tanzu Application Platform.

Create a properties file in your configuration repository

In a Git repository that is reachable from your Run cluster, create a `greeter-dev.yaml` file as follows:

```
eureka:
  client:
    # this disables the Eureka Spring Cloud discovery client
    enabled: false
spring:
  cloud:
    discovery:
      client:
        simple:
          instances:
            greeter-messages:
              - uri: http://greeter-messages.my-apps.svc.cluster.local
```

The values under `spring.cloud.discovery.client.simple.instances` list all the services that your application requires. The example `greeter-dev.yaml` file shows how to connect to another workload running on the same cluster.

In the example in [Create application workload resources](#), the `greeter-messages` microservice is deployed as a workload of type `web`, so the discovery client configuration must use the fully qualified domain name for the service within the Kubernetes cluster. If you instead choose to run the `greeter-messages` microservice as a workload of type `server`, this address still works, but the `greeter` microservice can also connect using the shorter URI `http://greeter-messages`.

Create Application Configuration Service resources

On your Run cluster, create the `ConfigurationSource` and `ConfigurationSlice` resources that tell Application Configuration Service (ACS) how to fetch the discovery configuration from the Git repository you are using.

The following example uses a public repository and no encryption. For more information about how to connect to private repositories, encrypt configuration, and load properties in other formats, see the [ACS documentation](#).

```
---
apiVersion: "config.apps.tanzu.vmware.com/v1alpha4"
kind: ConfigurationSource
metadata:
  name: greeter-config-source
  namespace: my-apps
spec:
  backends:
    - type: git
      uri: https://github.com/your-org/your-config-repo
---
apiVersion: config.apps.tanzu.vmware.com/v1alpha4
kind: ConfigurationSlice
metadata:
  name: greeter-config
  namespace: my-apps
spec:
  configurationSource: greeter-config-source
  content:
    - greeter/dev
  secretStrategy: applicationProperties
  interval: 10m
```

A Kubernetes secret is created in the `my-apps` namespace with a name starting with `greeter-config-`.

Create application workload resources

The `ConfigurationSlice` object you created in the previous section is a [Provisioned Service](#). You can use a `ResourceClaim` to claim it within the `my-apps` namespace. You then supply the resource claim in the `serviceClaims` list in the `Workload` object to provide the configuration inside the runtime environment of the workload.

The `SPRING_CONFIG_IMPORT` variable passes this configuration to Spring. If your application already uses that variable to apply other Spring configuration, use the `SPRING_CONFIG_ADDITIONAL_LOCATION` variable instead.

In the following example, one workload is created for the `greeter-messages` microservice, and a second workload is created for the `greeter` microservice. Both apps bind to the `ConfigurationSlice` to add Spring configuration:

```
---
apiVersion: carto.run/v1alpha1
kind: Workload
metadata:
  name: greeter-messages
  namespace: my-apps
labels:
  apps.tanzu.vmware.com/workload-type: web
  apps.tanzu.vmware.com/has-tests: "true"
  app.kubernetes.io/part-of: greeter
spec:
```

```

build:
  env:
    - name: BP_JVM_VERSION
      value: "17"
    # this tells the Gradle buildpack which module to build
    - name: BP_GRADLE_BUILT_MODULE
      value: "greeter-messages"
  env:
    # the Greeting app enables basic authentication unless the
    # development profile is used
    - name: SPRING_PROFILES_ACTIVE
      value: "development"
    - name: SPRING_CONFIG_IMPORT
      value: "${SERVICE_BINDING_ROOT}/spring-properties/"
  serviceClaims:
    - name: spring-properties
      ref:
        apiVersion: services.apps.tanzu.vmware.com/v1alpha1
        kind: ResourceClaim
        name: greeter-config-claim
  source:
    git:
      url: https://github.com/spring-cloud-services-samples/greeting
      ref:
        branch: main
---
apiVersion: carto.run/v1alpha1
kind: Workload
metadata:
  name: greeter
  namespace: my-apps
  labels:
    apps.tanzu.vmware.com/workload-type: web
    apps.tanzu.vmware.com/has-tests: "true"
    app.kubernetes.io/part-of: greeter
spec:
  build:
    env:
      - name: BP_JVM_VERSION
        value: "17"
      - name: BP_GRADLE_BUILT_MODULE
        value: "greeter"
    env:
      - name: SPRING_PROFILES_ACTIVE
        value: "development"
      - name: SPRING_CONFIG_IMPORT
        value: "${SERVICE_BINDING_ROOT}/spring-properties/"
    serviceClaims:
      - name: spring-properties
        ref:
          apiVersion: services.apps.tanzu.vmware.com/v1alpha1
          kind: ResourceClaim
          name: greeter-config-claim
    source:
      git:
        url: https://github.com/spring-cloud-services-samples/greeting
        ref:
          branch: main
---
apiVersion: services.apps.tanzu.vmware.com/v1alpha1
kind: ResourceClaim
metadata:
  name: greeter-config-claim
  namespace: my-apps
spec:
  ref:

```

```

apiVersion: config.apps.tanzu.vmware.com/v1alpha4
kind: ConfigurationSlice
name: greeter-config

```

The greeter application builds, starts up, and finds the `greeter-messages` URI using the `SimpleDiscoveryClient`.

Using Spring Cloud Gateway for Kubernetes with Tanzu Application Platform

This topic tells you how to use Spring Cloud Gateway for Kubernetes as an API gateway for workloads running on Tanzu Application Platform (commonly known as TAP).

Spring Cloud Gateway is a popular project library for creating an API Gateway that is built on top of the Spring ecosystem. The open source library is a foundational component of VMware Spring Cloud Gateway for Kubernetes and Spring Cloud Gateway for VMware Tanzu Application Service commercial offerings with commercial-only capabilities and platform-integrated operator experiences. You can use the open source and commercial offerings as a reverse proxy with extra API Gateway functions to handle request and response to upstream application services.

Spring Cloud Gateway for Kubernetes is included with Tanzu Application Platform v1.5 and later. You can migrate upstream applications that expose API routes on Spring Cloud Gateway from Tanzu Application Service and custom open source implementations to Tanzu Application Platform. For how to do so, see the [VMware Spring Cloud Gateway for Kubernetes documentation](#).

Create a new application accelerator

This topic guides you through creating an accelerator and registering it in a Tanzu Application Platform (commonly known as TAP) instance.

Tanzu Application Platform offers a selection of built-in accelerators to streamline your development process. However, if these accelerators don't meet your needs, you can create a new accelerator. By creating an accelerator, you can ensure that your technology stacks and organizational best practices are adhered to.



Note

This guide follows a quick start format. See the [Application Accelerator documentation](#) for advanced features.

What you will do

- Create a new accelerator project that contains an `accelerator.yaml` file and `README.md` file.
- Configure the `accelerator.yaml` file to alter the project's `README.md`.
- Test your accelerator locally using the Tanzu CLI `generate-from-local` command.
- Create a new Git repository for the project and push the project to it.
- Register the accelerator in a Tanzu Application Platform instance.
- Verify project generation with the new accelerator by using Tanzu Developer Portal (formerly named Tanzu Application Platform GUI).

Set up Visual Studio Code

1. To simplify accelerator authoring, code assist capabilities are available. To install the extension, navigate to the [Marketplace page for the YAML plug-in](#) and click **Install**.



Note

Code assist for authoring accelerators is also available in the IntelliJ IDE. You can enable this by selecting **Application Accelerator** in the schema mapping drop-down menu. For more information about how to enable this, see the IntelliJ [Using schemas from JSON Schema Store](#) documentation.

2. After you install the plug-in, editing files entitled `accelerator.yaml` automatically uses the code assist capabilities.

Create a simple project

To create your project, follow these instructions to set up the project directory, prepare the `README.md` and `accelerator.yaml`, and test your accelerator.

Set up the project directory

1. Create a new directory for the project named `myProject` and change to the newly created directory.

```
mkdir myProject
cd myProject
```

2. Create two new files in the `myProject` directory named `README.md` and `accelerator.yaml`.

```
touch README.MD accelerator.yaml
```

Prepare the `README.md` and `accelerator.yaml`

The following instructions require using Visual Studio Code to edit the files.

1. Using Visual Studio Code, open the `README.md`, copy and paste the following code block into it, and save the file. `CONFIGURABLE_PARAMETER_#` is targeted to be transformed during project generation in the upcoming `accelerator.yaml` definition.

```
## Tanzu Application Accelerator Sample Project

This is some very important placeholder text that should describe what this project can do and how to use it.

Here are some configurable parameters:

* CONFIGURABLE_PARAMETER_1
* CONFIGURABLE_PARAMETER_2
```

2. Open `accelerator.yaml` and begin populating the file section using the snippet below. This section contains important information, such as the accelerator's display name, description, tags, and more.

For all possible parameters available in this section, see [Creating accelerator.yaml](#).

```
accelerator:
  displayName: Simple Accelerator
  description: Contains just a README
```

```

imageUrl: https://blogs.vmware.com/wp-content/uploads/2022/02/tap.png
tags:
  - simple
  - getting-started

```

3. Add the configuration parameters using the following code snippet. This configures what parameters are displayed in the accelerator form during project creation.

In this example snippet, the field `firstConfigurableParameter` takes in text the user provides. The `secondConfigurableParameter` does the same, except it is only displayed if the user checks `secondConfigurableParameterCheckbox` because of the `dependsOn` parameter.

For more information about possible options, see [Creating accelerator.yaml](#).

```

# Place this after the 'tags' section from the previous step
options:
  - name: firstConfigurableParameter
    inputType: text
    label: The text used to replace the first placeholder text in the README.
    md. Converted to lowercase.
    defaultValue: Configurable Parameter 1
    required: true
  - name: secondConfigurableParameterCheckbox
    inputType: checkbox
    dataType: boolean
    label: Enable to configure the second configurable parameter, otherwise use
    the default value.
  - name: secondConfigurableParameter
    inputType: text
    label: The text used to replace the second placeholder text in the README.
    md. Converted to lowercase.
    defaultValue: Configurable Parameter 2
    dependsOn:
      name: secondConfigurableParameterCheckbox

```

4. Add the `engine` configuration by using the following code snippet and save the file.

The `engine` configuration tells the `accelerator engine` behind the scenes what must be done to the project files during project creation. In this example, this instructs the engine to replace `CONFIGURABLE_PARAMETER_1` and, if the check box is checked, `CONFIGURABLE_PARAMETER_2` with the parameters that the user passes in during project creation.

This also leverages [Spring Expression Language \(SpEL\)](#) syntax to convert the text input to all lowercase.

For more information about the possible parameters for use within the `engine` section, see [Creating accelerator.yaml](#).

```

# Place this after the `options` section from the previous step
engine:
  merge:
    - include: [ "README.md" ]
      chain:
        - type: ReplaceText
          substitutions:
            - text: "CONFIGURABLE_PARAMETER_1"
              with: "#firstConfigurableParameter.toLowerCase()"
        - condition: "#secondConfigurableParameterCheckbox"
          chain:
            - type: ReplaceText
              substitutions:

```

```
- text: "CONFIGURABLE_PARAMETER_2"
  with: "#secondConfigurableParameter.toLowerCase()"
```

Test the accelerator

It is important to quickly test and iterate on accelerators as they are being developed to ensure that the resulting project is generated as expected.

1. Using the terminal of your choice with access to the `tanzu` command, run the following command to test the accelerator created earlier.

This step takes the local `accelerator.yaml` and project files, configures the project using the parameters passed in through the `--options` field, and outputs the project to a specified directory.



Important

This step requires that the `TANZU-APPLICATION-ACCELERATOR-URL` endpoint is exposed and accessible. For more information, see [Server API connections for operators and developers](#).

```
tanzu accelerator generate-from-local \
  --accelerator-path simple-accelerator="$(pwd)" `# The path to new accelerator` \
  --server-url TANZU-APPLICATION-ACCELERATOR-URL `# Example: https://accelerator.mytapcluster.myorg.com` \
  --options '{"firstConfigurableParameter": "Parameter 1", "secondConfigurableParameterCheckbox": true, "secondConfigurableParameter": "Parameter 2"}' \
  -o "${HOME}/simple-accelerator/" `# Change this path to change where the project folder gets generated`
```

2. After the project is generated, a status message is displayed.

```
generated project simple-accelerator
```

3. Navigate to the output directory and verify that the `README.md` is updated based on the `--options` specified in the preceding `generate-from-local` command.

```
## Tanzu Application Accelerator Sample Project

This is some very important placeholder text that should describe what this project can do and how to use it.

Here are some configurable parameters:

- parameter 1
- parameter 2
```

Upload the project to a Git repository

The Application Accelerator system and Tanzu Developer Portal depend on an accelerator project residing inside a Git repository. For this example, [GitHub](#) is used.

1. [Create a new repository in GitHub](#) and ensure that **Visibility** is set to **Public**. Click **Create Repository**.
2. To push your accelerator project (**not** the generated project from `generate-from-local`) to GitHub, follow the instructions that GitHub provides for the *...or create a new repository on*

the command line that is shown after clicking **Create Repository**. Instructions can also be found in the [GitHub documentation](#).

3. Verify that the project is pushed to the target repository.

Register the accelerator to the Tanzu Application Platform and verify project generation output

Now that the accelerator is committed to its own repository, you can register the accelerator to Tanzu Developer Portal for developers to generate projects from the newly created accelerator.

To do so, use the URL of the Git repository and branch name created earlier and run the following command using the Tanzu CLI to register the accelerator to Tanzu Developer Portal.



Note

`tanzu accelerator create` works with monorepos as well. Add the `--git-sub-path` parameter with the desired subpath to fetch the accelerator project in that directory. For more information, see [tanzu accelerator create](#).

```
tanzu accelerator create simple-accelerator --git-repository https://github.com/myuser  
name/myprojectrepository --git-branch main
```

The accelerator can take time to reconcile. After it has reconciled, it is available for use in Tanzu Developer Portal and the Application Accelerator extension for Visual Studio Code.

Verify project generation output by using Tanzu Developer Portal

1. Navigate to your organization's instance of Tanzu Developer Portal.
2. On the left navigation pane, click **Create**.
3. Using the search bar near the left side of the page, search for `simple accelerator`. After you've found it, click **Choose** on the accelerator card.

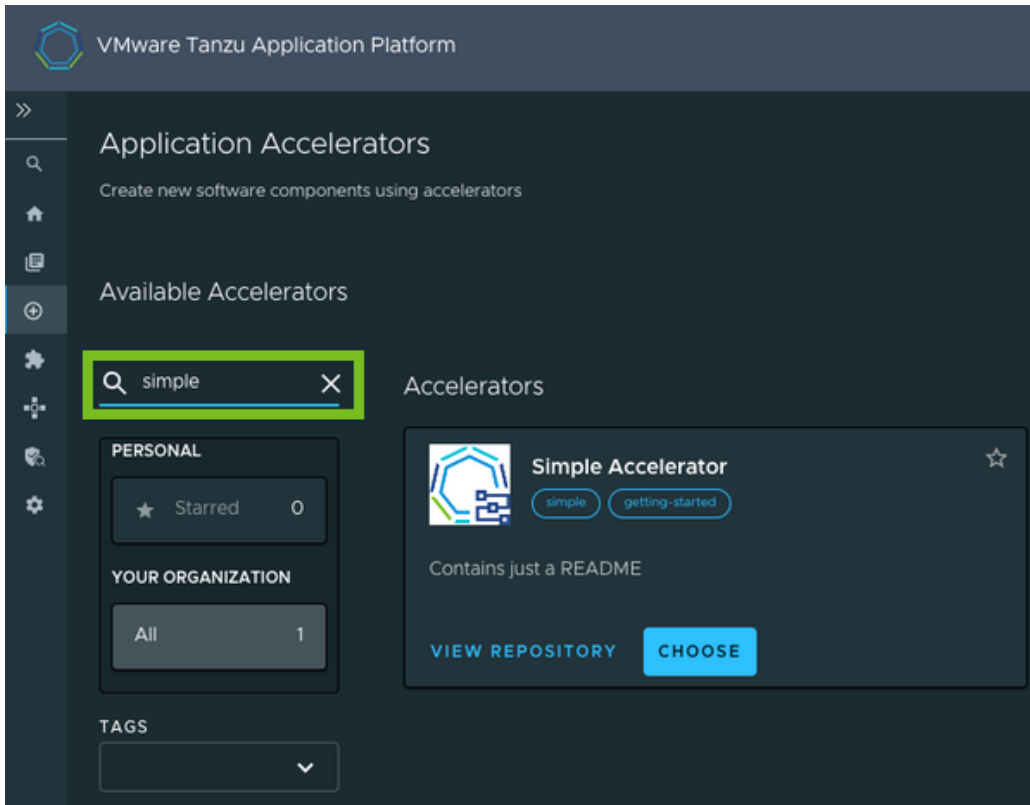

4. Configure the project by filling in the parameters in the form.

The options you defined in `accelerator.yaml` are now displayed for you to configure. The `secondConfigurableParameter dependsOn secondConfigurableParameterCheckbox` might be hidden depending on whether the check box is selected.

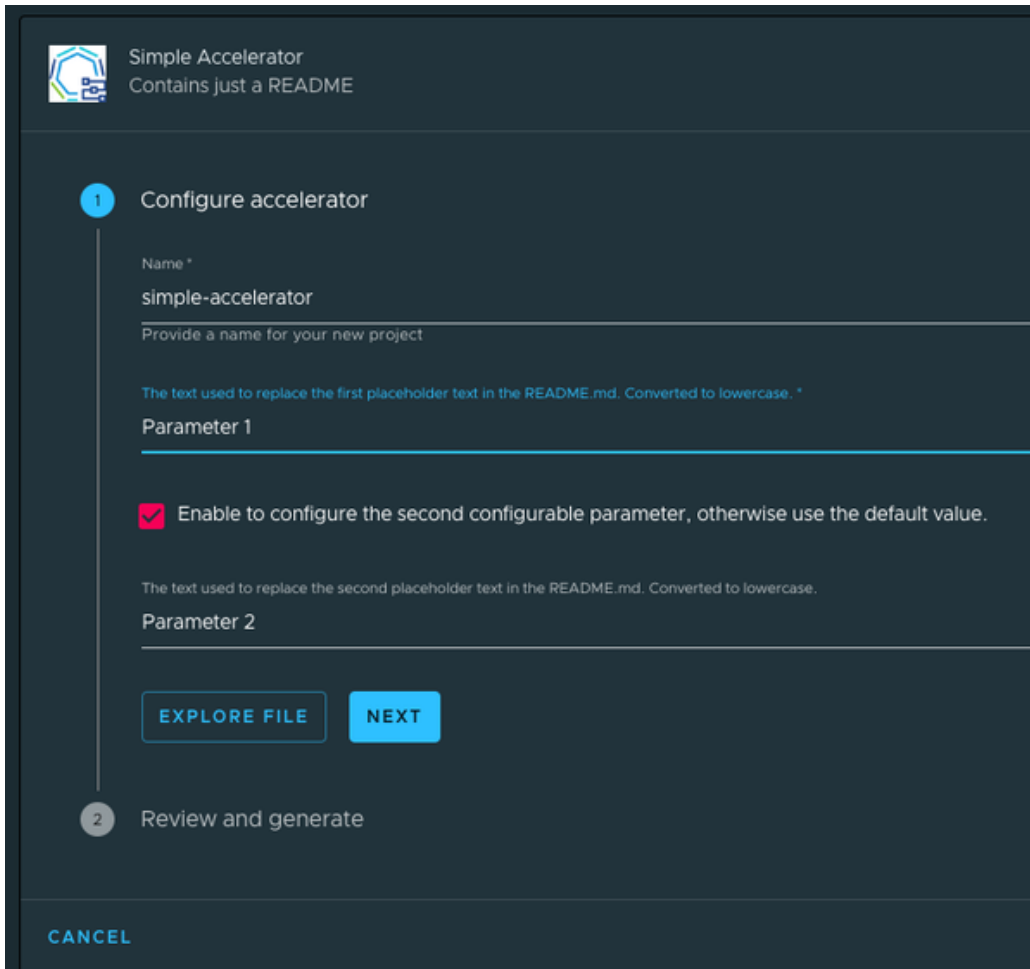

5. After configuration is complete, click **Next**.

 **Note**

Depending on your organization's Tanzu Application Platform configuration, you might be presented with an option to create a Git repository. In this guide, this is skipped and is covered in [Deploy an app on Tanzu Application Platform](#).

6. On the **Review and generate** step, review the parameters and click **Generate Accelerator**.
7. Explore the ZIP file of the configured project and verify that the project is generated with the parameters you provided during configuration.

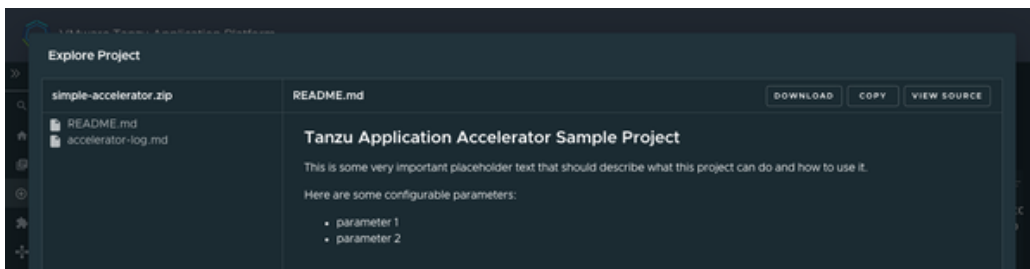

Learn more about Application Accelerator

- For advanced functionality when creating accelerators, such as accelerator best practices, accelerator fragments, engine transforms, and more, see the [Application Accelerator documentation](#).
- For more information about Application Accelerator configurations, see the [Configure Application Accelerator documentation](#).
- For information about installing the Application Accelerator extension for Visual Studio Code, see the [Application Accelerator Visual Studio Code extension documentation](#).
- For general accelerator troubleshooting, see [Troubleshooting Application Accelerator for VMware Tanzu](#).

Learn about Tanzu Application Platform

The topics in this section explain concepts important to getting started with Tanzu Application Platform (commonly known as TAP).

In this section:

- [Application Accelerator](#)
- [Supply chains on Tanzu Application Platform](#)
- [Vulnerability scanning and metadata storage for your supply chain](#)
- [Consume services on Tanzu Application Platform](#)

Application accelerators on Tanzu Application Platform

This topic describes the key concepts you need to know about application accelerators on Tanzu Application Platform (commonly known as TAP).

What are application accelerators

Application accelerators are templates that not only codify best practices but also provide important configuration and structures ready and available for use. Developers can create applications and get started with feature development immediately with the help of application accelerators.

Enterprise Architects use Application Accelerator to create application accelerators, which provide developers and admins in their organization with ready-made, enterprise-conforming code and configurations. Accelerators contain complete and runnable application code and deployment configurations. They also contain metadata for altering the code and deployment configurations based on input values provided for specific options defined in the accelerator metadata.

Working with accelerators

The Application Accelerator plug-in for Tanzu Developer Portal helps you to discover accelerators and to enter extra information used for processing the files before downloading. As of Tanzu Application Platform v1.2, developers can also discover and work on accelerators right in Visual Studio Code with the Tanzu Application Accelerator for VS Code extension. Developers can use the `list`, `get`, and `generate` commands to use accelerators available in an Application Accelerator server.

Admins use the `create`, `update`, and `delete` commands for managing accelerators in a Kubernetes context. When admins want to use the `get` and `list` commands, they can specify the `--from-context` flag to access accelerators in a Kubernetes context.

Next steps

Apply what you have learned:

Developers:

- [Deploy an app on Tanzu Application Platform](#)

Operators:

- [Create an application accelerator](#)

Supply chains on Tanzu Application Platform

This topic describes the key concepts you need to know about supply chains and Continuous Integration/Continuous Delivery (CI/CD) on Tanzu Application Platform (commonly known as TAP).

What are supply chains

Supply chains provide a way of codifying all of the steps of your path to production, more commonly known as CI/CD. CI/CD is a method to frequently deliver applications by introducing automation into the stages of application development. The main concepts attributed to CI/CD are continuous integration, continuous delivery, and continuous deployment.

CI/CD is the method used by supply chains to deliver applications through automation. Tanzu Application Platform supply chains allow you to use CI/CD and add any other steps necessary for an application to reach production or a different environment, such as staging.



A path to production

A path to production allows you to create a unified access point for all of the tools required for your applications to reach a customer-facing environment. Instead of having four tools that are loosely coupled to each other, a path to production defines all four tools in a single, unified layer of abstraction. The path to production can be automated and repeatable between teams for applications at scale.

Typically tools cannot integrate with one another without scripting or webhooks. Whereas with a path to production, there is a unified automation tool to codify all the interactions between each of the tools. Supply chains that are used to codify the path to production for an organization are configurable. This allows their authors to add all of the steps of the path to production for their applications.

Available supply chains

Tanzu Application Platform provides three out of the box (OOTB) supply chains to work with the Tanzu Application Platform components. They include:

- [OOTB Supply Chain Basic](#) (default)
- [OOTB Supply Chain with Testing](#) (optional)
- [OOTB Supply Chain with Testing+Scanning](#) (optional)

1: OOTB Basic (default)

The default **OOTB Basic** supply chain and its dependencies were installed on your cluster during the Tanzu Application Platform install. The following diagram and table provide a description of the supply chain and dependencies provided with Tanzu Application Platform.

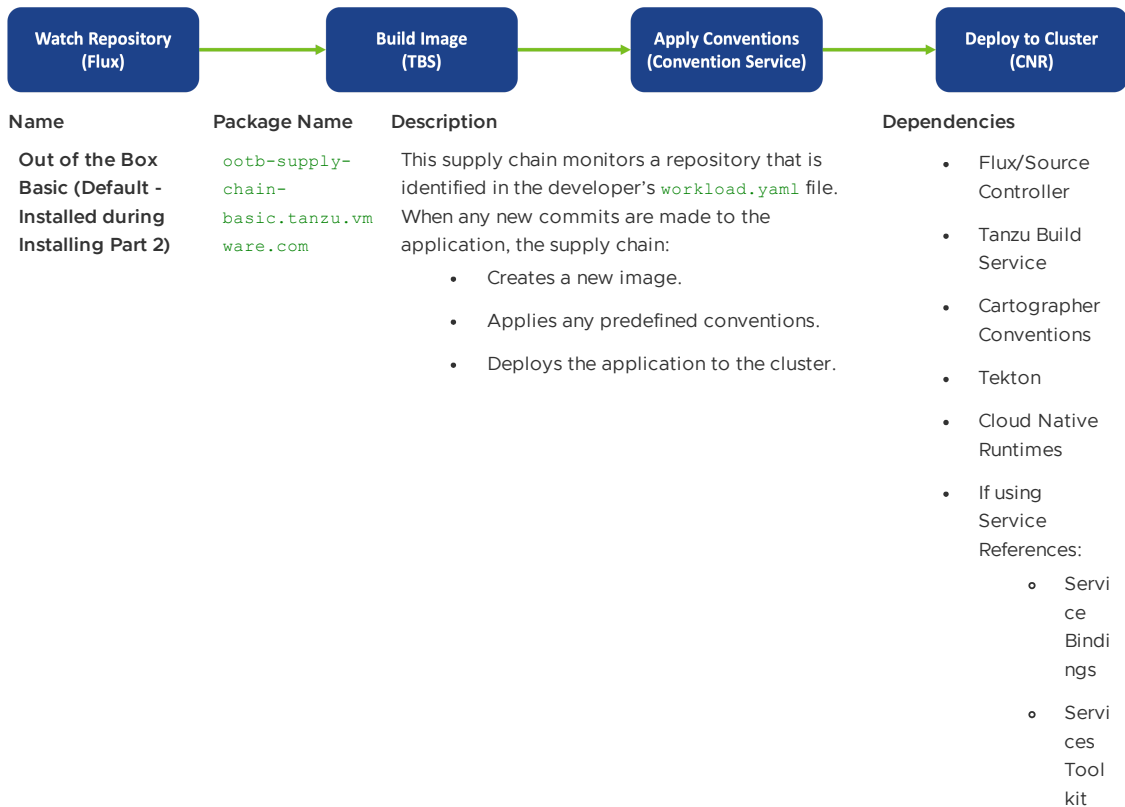

2: OOTB Testing

OOTB Testing supply chain runs a Tekton pipeline within the supply chain. The following diagram and table provide a description of the supply chain and dependencies provided with Tanzu Application Platform.

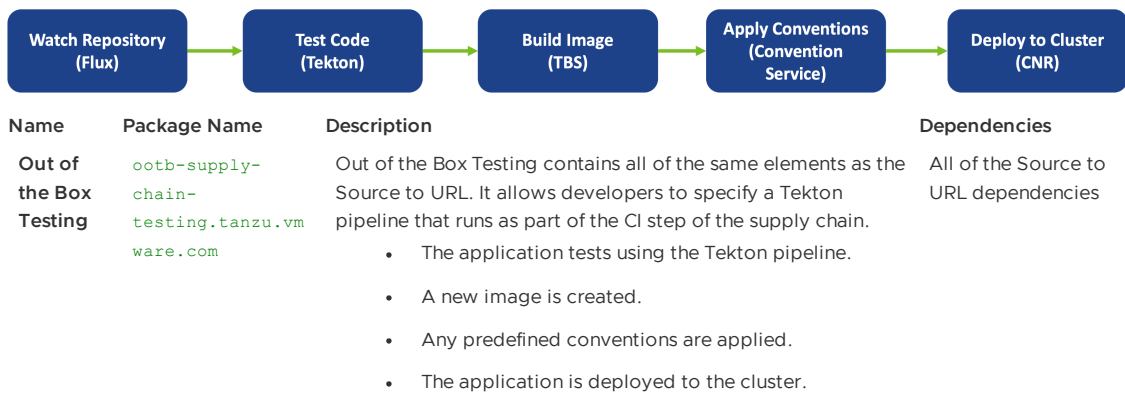

3: OOTB Testing+Scanning

OOTB Testing+Scanning supply chain includes integrations for secure scanning tools. The following diagram and table provide a description of the supply chain and dependencies provided with Tanzu Application Platform.



Name	Package Name	Description	Dependencies
Out of the Box Testing and Scanning	<code>ootb-supply-chain-testing-scanning.tanzu.vmware.com</code>	<p>Out of the Box Testing and Scanning contains all of the same elements as the Out of the Box Testing supply chain, and it also includes integrations with the secure scanning components of Tanzu Application Platform.</p> <ul style="list-style-type: none"> The application is tested using the provided Tekton pipeline. (Optional) The application source code is scanned for vulnerabilities. For how to opt in, see Adding Source Scan to the Test and Scan Supply Chain. A new image is created. The image is scanned for vulnerabilities. Any predefined conventions are applied. The application deploys to the cluster. 	<p>All of the Source to URL dependencies, and:</p> <ul style="list-style-type: none"> The secure scanning components included with Tanzu Application Platform

Next steps

Apply what you have learned:

- [Add testing and scanning to your application](#)

Or learn about:

- [Vulnerability scanning and metadata storage for your supply chain](#)

Vulnerability scanning, storing, and viewing for your supply chain

This topic describes the vulnerability scanning features you can use with Tanzu Application Platform (commonly known as TAP).

This feature set allows an application operator to introduce source code and image vulnerability scanning, storing, and viewing to their Tanzu Application Platform supply chain. It also allows for the creation of scan-time rules that prevent critical vulnerabilities from flowing to the supply chain unresolved.

Features

Features include:

- Scan source code repositories and images for known common vulnerabilities and exposures (CVEs) before deploying to a cluster.
- Identify CVEs by scanning continuously on each new code commit or each new image built.
- Analyze scan results against user-defined policies by using Open Policy Agent. Create scan policy to prevent vulnerable components from going into production.
- Produce vulnerability scan results and post them to the SCST - Store where they can be queried.
- Query the store for such use cases as:
 - What images and packages are affected by a specific vulnerability?
 - What source code repositories are affected by a specific vulnerability?
 - What packages and vulnerabilities does a particular image have?

- [Visualize the supply chain and its packages and vulnerabilities of your supply chain.](#)

Components

- [Supply Chain Security Tools \(SCST\) - Scan](#) scans source code and images for their packages and vulnerabilities.
- [SCST - Store](#) takes the vulnerability scanning results and stores them.
- [Tanzu Insight plug-in](#) provides a CLI to query for packages and vulnerabilities.
- [Supply Chain Choreographer in Tanzu Developer Portal](#) visualizes the supply chain, including scans, packages, and vulnerabilities.

Next steps

Apply what you have learned:

- [Add testing and scanning to your application](#)

Or learn about:

- [Supply chains on Tanzu Application Platform](#)

Or go deeper into scanning on Tanzu Application Platform:

- [Scan samples](#) to try the scan and store features as individual one-off scans
- [Configure Code Repositories and Image Artifacts to be Scanned](#)
- [Code and Image Compliance Policy Enforcement Using Open Policy Agent \(OPA\)](#)
- [How to Create a ScanTemplate](#)
- [Viewing and Understanding Scan Status Conditions](#)
- [Observing and Troubleshooting](#)
- [Tanzu Insight plug-in overview](#)

Troubleshooting

- [SCST Scan - Observing and Troubleshooting](#)
- [SCST Store - Troubleshooting](#)
- [Tanzu Developer Portal - Troubleshooting](#)

About consuming services on Tanzu Application Platform

This topic describes the key concepts and terms you need to know about consuming services on Tanzu Application Platform (commonly known as TAP).

As part of Tanzu Application Platform, you can work with backing services such as RabbitMQ, PostgreSQL, and MySQL among others. The most common use of services is binding an application workload to a service instance.

Key concepts

When working with services on Tanzu Application Platform, you must be familiar with service instances, service bindings, and resource claims. This section provides a brief overview of each of these key concepts.

Service instances

A **service instance** is a logical grouping of one or more Kubernetes resources that together expose a known capability through a well-defined interface. For example, a theoretical MySQL service instance might consist of a `MySQLDatabase` and a `MySQLUser` resource. When considering compatibility of service instances for Tanzu Application Platform, one of the resources of a service instance must adhere to the [Service Binding for Kubernetes](#) specification.

Service bindings

Service binding refers to a mechanism in which connectivity information, such as service instance credentials, and connectivity information, such as host and port, are automatically communicated to application workloads. Tanzu Application Platform uses a standard named [Service Binding for Kubernetes](#) to implement this mechanism. See this standard to fully understand the services aspect of Tanzu Application Platform.

Resource claims

Resource claims are inspired in part by Persistent Volume Claims. For more information, see the [Kubernetes documentation](#). Resource claims provide a mechanism for users to claim service instances on a cluster, while also decoupling the life cycle of application workloads and service instances.

Services you can use with Tanzu Application Platform

The following list of Kubernetes operators expose APIs that integrate well with Tanzu Application Platform:

1. [VMware RabbitMQ for Kubernetes](#).
2. [VMware SQL with Postgres for Kubernetes](#).
3. [VMware SQL with MySQL for Kubernetes](#).

Compatibility of a service with Tanzu Application Platform ranges on a scale between fully compatible and incompatible. The minimum requirement for compatibility is that there must be a declarative, Kubernetes-based API on which at least one API resource type adheres to the [Provisioned Service](#) duck type defined by the [Service Binding Specification for Kubernetes](#) in GitHub. This duck type includes any resource type with the following schema:

```
status:
  binding:
    name: # string
```

The value of `.status.binding.name` must point to a `Secret` in the same namespace. The `Secret` contains required credentials and connectivity information for the resource.

Typically, APIs that include these resource types are installed onto the Tanzu Application Platform cluster as Kubernetes operators. These Kubernetes operators provide custom resource definitions (CRDs) and corresponding controllers to reconcile the resources of the CRDs, as is the case with the three Kubernetes operators listed earlier.

For services that do not provide a resource adhering to the Service Binding Specification for Kubernetes, you might still be able to provide configurations allowing such services to integrate with Tanzu Application Platform. For an example of how to do this for Amazon AWS RDS, see the tutorial [Integrating cloud services into Tanzu Application Platform](#).

User roles and responsibilities

It is important to understand the user roles for services on Tanzu Application Platform and the responsibilities assumed by each. The following table describes each user role.

User role	Exists as a default role in Tanzu Application Platform?	Responsibilities
Service operator	Yes - service-operator	<ul style="list-style-type: none"> Life cycle management (CRUD) of service instances Life cycle management (CRUD) of service instance classes Life cycle management (CRUD) of resource claim policies View and query for resource claims across namespaces
Application operator	Yes - app-operator	Life cycle management (CRUD) of resource claims
Application developer	Yes - app-editor and app-viewer	Binding service instances to application workloads

Next steps

Apply what you've learned:

- [Claim services on Tanzu Application Platform](#)
- [Consume services on Tanzu Application Platform](#)

Set up Tanzu Service Mesh

This topic tells you how to set up a Tanzu Application Platform application deployed on Kubernetes with Tanzu Service Mesh (commonly called TSM).

Sample applications are used to demonstrate how a global namespace can provide a network for Kubernetes workloads that are connected and secured within and across clusters, and across clouds.



Note

You can also use Tanzu Mission Control (commonly called TMC) to install Tanzu Application Platform (commonly called TAP) on a managed cluster. For more information, see the [Tanzu Mission Control documentation](#).

Prerequisites

Meet the [prerequisites](#), which includes having

- A supported Kubernetes platform
- The correct resource configuration (number of nodes, CPUs, RAM, and so on)
- The required connectivity requirements

Connectivity is only required from your local clusters out to Tanzu Service Mesh and not inwards. This can traverse a corporate proxy as well. In addition, connectivity in the data plane is required between the clusters that must communicate, specifically egress to ingress gateways. No data plane traffic needs to reach the Tanzu Service Mesh software as a service (SaaS) management plane.

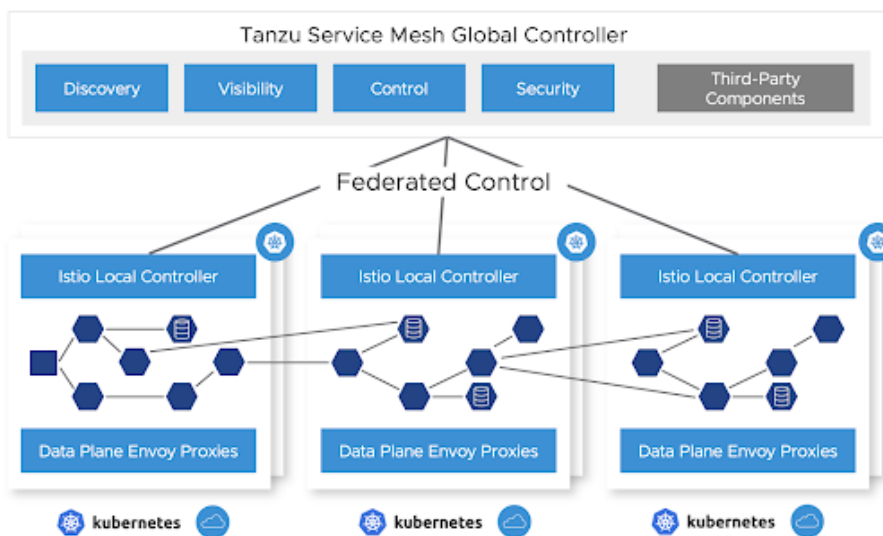

Activate your Tanzu Service Mesh subscription

Activate your Tanzu Service Mesh subscription at cloud.vmware.com. After purchasing your Tanzu Service Mesh subscription, the VMware Cloud team sends you instructions. If you don't receive them, you can follow [these instructions](#).

Onboard your clusters to Tanzu Service Mesh as described later in this topic. This deploys the Tanzu Service Mesh local control plane and OSS Istio on your Kubernetes cluster and connects the local control plane to your Tanzu Service Mesh tenant.

Set up Tanzu Application Platform

To enable Tanzu Service Mesh support in Tanzu Application Platform Build clusters:

1. Add the following key to `tap-values.yaml` under the `buildservice` top-level key:

```
buildservice:
  injected_sidecar_support: true
```

2. [Install Tanzu Application Platform](#) on the run cluster.

End-to-end workload build and deployment scenario

The following sections describe how to build and deploy a workload.

Apply a workload resource to a build cluster

Workloads can be built by using a Tanzu Application Platform supply chain by applying a workload resource to a build cluster. At this time, Tanzu Service Mesh and Tanzu Application Platform cannot use the Knative resources that are the default runtime target when using the `web` resource type.

In Tanzu Application Platform v1.4 and later, two workload types support a Tanzu Service Mesh and Tanzu Application Platform integration: **server** and **worker**.

To work with Tanzu Service Mesh, web workloads must be converted to the `server` or `worker` workload type. Server workloads cause a Kubernetes `Deployment` resource to be created with a `Service` resource that uses port 8080 by default.

1. If the service port that you want is 80 or some other port, add port information to `workload.yaml`. The following example YAML snippets show the changes to make from the `web` to `server` workload type. This is an example before applying the changes:

```
apiVersion: carto.run/v1alpha1
kind: Workload
metadata:
  name: where-for-dinner
  labels:
    apps.tanzu.vmware.com/workload-type: web
    app.kubernetes.io/part-of: where-for-dinner-api-gateway
spec:
  params:
    - name: annotations
value:
  autoscaling.knative.dev/minScale: "1"
  source:
    git:
      url: https://github.com/vmware-tanzu/application-accelerator-samples.git
      ref:
        branch: tap-1.6.x
        subPath: where-for-dinner/where-for-dinner-api-gateway
```

This is an example modified for Tanzu Service Mesh, which includes the removal of the autoscaling annotation:

```

apiVersion: carto.run/v1alpha1
kind: Workload
metadata:
  name: where-for-dinner
  labels:
    apps.tanzu.vmware.com/workload-type: server # modification
    app.kubernetes.io/part-of: where-for-dinner-api-gateway
spec:
  params:
    - name: ports # modification
      value:
        - port: 80 # modification
          containerPort: 8080 # modification
          name: http # modification
  source:
    git:
      url: https://github.com/vmware-tanzu/application-accelerator-samples.git
      ref:
        branch: tap-1.6.x
      subPath: where-for-dinner/where-for-dinner-api-gateway

```

This results in a deployment and a service that listens on port 80 and forwards traffic to port 8080 on the pod's workload container.

2. Submit the modified YAML to your build cluster by running:

```
tanzu apps NAMESPACE apply --file WORKLOAD-YAML-FILE
```

Where:

- o `NAMESPACE` is the namespace that the build cluster uses for building.
- o `WORKLOAD-YAML-FILE` is the name of your workload YAML file, such as `workload.yaml`.

After your workload is built a `Deliverable` resource is created.

Configure egress for Tanzu Build Service

For Tanzu Build Service to properly work, provide egress to access the registry where Tanzu Build Service writes application images, and define the registry in the `kp_default_repository` key and the Tanzu Application Platform install registry.

Additionally, configure egress for buildpack builds to download any required dependencies. This configuration varies with different buildpacks and language environments. For example, Java builds might need to download dependencies from Maven central.

Create a global namespace

Using the Tanzu Service Mesh portal or API, create a global namespace (GNS) that includes the namespaces where your application components are deployed. For more information, see [Global Namespaces](#)

Whether in a single cluster or multiple clusters, or within the same site or across clouds, after you add a namespace selection to the GNS, the services that Tanzu Application Platform deploys are connected based on the GNS configuration for service discovery and connectivity policies.

If a service must be accessible through the ingress from the outside, it can be configured through the public service option in Tanzu Service Mesh or directly through Istio on the clusters where that service resides. It's best practice to configure the service's accessibility through the GNS.

Run cluster deployment

Before deploying a workload to a run cluster, ensure that any prerequisite resources have already been created on the run cluster. This includes concepts such as data, messaging, routing, security services, RBAC, ResourceClaims, and so on.

After a successful build in a build cluster, workloads can be deployed to the run cluster by applying resulting deliverable resources to the run cluster as described in [Getting Started with Multicluster Tanzu Application Platform](#).

Another option is to create a kapp application that references a GitOps repository to include all deliverable resources for a given cluster. See the following example of a kapp definition that points to a GitOps repository:

```
apiVersion: kappctrl.k14s.io/v1alpha1
kind: App
metadata:
  name: deliverable-gitops
  namespace: where-for-dinner
spec:
  serviceAccountName: default
  fetch:
  - git:
    url: https://github.com/gm2552/tap-play-gitops
    ref: origin/deliverables-tap-east01
    subPath: config
  template:
  - ytt: {}
  deploy:
  - kapp: {}
```

The advantage of this model is that applications can be deployed or uninstalled from a cluster by managing the contents of the deliverable resources from within the GitOps repository and enabling a GitOps workflow for application and service change control.

Deployment use case: Where For Dinner

The following instructions describe an end-to-end process for configuring, building, and deploying the Where For Dinner application into a Tanzu Service Mesh global namespace.

These instructions use the default configuration of Where For Dinner, which consists of only needing a single-node RabbitMQ cluster, an in-memory database, and no security. The application is deployed across two Tanzu Application Platform run clusters. It requires the `ytt` command to execute the build and deployment commands.

The configuration resources referenced in this scenario are located in the [where-for-dinner-tap-tsm](#) GitHub repository.

Create an initial set of configuration files from the accelerator

This use case deployment includes a pre-built set of configuration files in a Git repository. However, they were created from a set of configuration files by using a bootstrapped process that uses the Where For Dinner accelerator, and were later modified.

For reference, you can create an initial set of configuration files from the Where For Dinner accelerator, which is available in Tanzu Application Platform v1.3 and later.

This section does not include instructions for modifying the configuration files from the accelerator into configuration files used in a later section.

From the accelerator, accept all of the default options with the following exceptions:

- **Workload namespace:** Update this field with the name of the namespace you will use to build the application in your build cluster
- **Service namespace:** Update this field with the name of the namespace you will use to deploy a RabbitMQ cluster on your Tanzu Application Platform run cluster

Apply the workload resources to your build cluster

To build the application services, run the following command to apply the workload resources to your build cluster. You can also clone or fork the repository in this command to either use the YAML files locally or point to your own Git repository.

```
ytt -f workloads.yaml -v workloadNamespace=WORKLOAD-NAMESPACE | kubectl apply -f-
```

Where `WORKLOAD-NAMESPACE` is the name of your build namespace

For example:

```
ytt -f https://raw.githubusercontent.com/gm2552/where-for-dinner-tap-tsm/main/workloads.yaml \
-v workloadNamespace=workloads | kubectl apply -f-
```

If you are using a GitOps workflow with your build cluster, after the workloads are built the deployment information is pushed to your GitOps repository.

If you follow these instructions without pull requests in the GitOps workflow, the config-writer pods that commit deployment information to the GitOps repository might fail because of concurrency conflicts. A workaround for this is to delete the failed workloads from the build cluster and re-run the command provided in the instructions.

Install service claim resources on the cluster

Where For Dinner requires a RabbitMQ cluster installed on your run cluster. You must install RabbitMQ on the same run cluster that is named `RunCluster01` in the following deployment section. Additionally, you must install service claim resources on this cluster.

1. If you haven't already done so, install the RabbitMQ Cluster Operator on the run cluster by running:

```
kubectl apply -f "https://github.com/rabbitmq/cluster-operator/releases/download/v1.13.1/cluster-operator.yml"
```

2. Spin up an instance of a RabbitMQ cluster by running:

```
kubectl create ns SERVICE-NAMESPACE

ytt -f rmqCluster.yaml -v serviceNamespace=SERVICE-NAMESPACE | kubectl apply -f-
```

Where `SERVICE-NAMESPACE` is the namespace of where you want to deploy your RabbitMQ cluster

For example:

```
kubectl create ns service-instances

ytt -f https://raw.githubusercontent.com/gm2552/where-for-dinner-tap-tsm/main/rmqCluster.yaml -v \
serviceNamespace=service-instances | kubectl apply -f-
```

3. Create service toolkit resources for the RabbitMQ class and resource claim by running:

```
ytt -f rmqResourceClaim.yaml -v serviceNamespace=SERVICE-NAMESPACE -v \
workloadNamespace=WORKLOAD-NAMESPACE | kubectl apply -f-
```

Where `SERVICE-NAMESPACE` and `WORKLOAD-NAMESPACE` are the namespaces where you deployed your RabbitMQ cluster and the namespace where the application service will run.

For example:

```
ytt -f https://raw.githubusercontent.com/gm2552/where-for-dinner-tap-tsm/main/rmqResourceClaim.yaml \
-v serviceNamespace=service-instances -v workloadNamespace=where-for-dinner | kubectl apply -f-
```

Run cluster deployment

Workloads are deployed to the run cluster using deliverable resources. This section applies the deliverable resources directly to the run clusters instead of using a kapp application.

This deployment assumes that two clusters are part of the Tanzu Service Mesh GNS Where For Dinner. These example clusters are named `RunCluster01` and `RunCluster02`. The majority of the workload is deployed to `RunCluster01` while the crawler workload is deployed to `RunCluster02`.

The deliverable objects reference the GitOps repository, where the build cluster has written deployment information, and needs to reference this repository in the following commands.

Deploy the workloads to the run clusters by running these commands against their respective clusters:

```
ytt -f cluster01Deliverables.yaml -v workloadNamespace=WORKLOAD-NAMESPACE -v \
gitOpsSecret=GIT-OPS-SECRET -v gitOpsRepo=GIT-OPS-REPO | kubectl apply -f-
```

Where:

- `WORKLOAD-NAMESPACE` is the namespace where the workloads are deployed
- `GIT-OPS-SECRET` is the GitOps secret used to access the GitOps repository
- `GIT-OPS-REPO` is the URL of the GitOps repository where the build cluster wrote out deployment configuration information

```
ytt -f cluster02Deliverables.yaml -v workloadNamespace=WORKLOAD-NAMESPACE -v \
gitOpsSecret=GIT-OPS-SECRET -v gitOpsRepo=GIT-OPS-REPO | kubectl apply -f-
```

Where:

- `WORKLOAD-NAMESPACE` is the namespace where the workloads are deployed
- `GIT-OPS-SECRET` is the GitOps secret used to access the GitOps repository
- `GIT-OPS-REPO` is the URL of the GitOps repository where the build cluster wrote out deployment configuration information

To run this deployment on cluster `RunCluster01`, for example, you run:

```
ytt -f https://raw.githubusercontent.com/gm2552/where-for-dinner-tap-tsm/main/cluster01Deliverables.yaml -v \
workloadNamespace=where-for-dinner -v gitOpsSecret=tap-play-gitops-secret -v \
gitOpsRepo=https://github.com/gm2552/tap-play-gitops.git | kubectl apply -f-
```

To run this deployment on cluster `RunCluster02`, for example, you run:

```
ytt -f https://raw.githubusercontent.com/gm2552/where-for-dinner-tap-tsm/main/cluster02Deliverables.yaml -v \
```

```
workloadNamespace=where-for-dinner -v gitOpsSecret=tap-play-gitops-secret -v \
gitOpsRepo=https://github.com/gm2552/tap-play-gitops.git | kubectl apply -f-
```

You can create an Istio ingress resource on `RunCluster01` if you do not plan on using the GNS capabilities to expose the application to external networks.

You must create a domain name system address (DNS A) record in your DNS provider's configuration tool to point to the Istio load-balanced IP address of `RunCluster01`. The DNS configuration is out of the scope of this topic.

Create the ingress by running:

```
ytt -f ingress.yaml -v workloadNamespace=WORKLOAD-NAMESPACE -v domainName=DOMAIN-NAME
| kubectl apply -f-
```

Where:

- `WORKLOAD-NAMESPACE` is the namespace where the workload is deployed
- `DOMAIN-NAME` is the public domain that will host your application

For example:

```
ytt -f https://raw.githubusercontent.com/gm2552/where-for-dinner-tap-tsm/main/ingress.
yaml -v \
workloadNamespace=where-for-dinner -v domainName=tsmdemo.perfect300rock.com | kubectl
apply -f-
```

Create a global namespace

The example clusters have the names `RunCluster01` and `RunCluster02`, and they assume the workload and service namespaces of `where-for-dinner` and `service-instances`, respectively.

1. Open the Tanzu Service Mesh console and create a new GNS.
2. Configure the following settings in each step:
 1. General details
 - **GNS Name:** `where-for-dinner`
 - **Domain:** `where-for-dinner.lab`
 2. Namespace mapping
 - Namespace mapping Rule 1
 - **Cluster name:** `RunCluster01`
 - **Namespace:** `where-for-dinner`
 - Namespace Mapping Rule 2
 - **Cluster name:** `RunCluster02`
 - **Namespace:** `where-for-dinner`
 - Namespace Mapping Rule 3
 - **Cluster name:** `RunCluster01`
 - **Namespace:** `service-instances`
 3. Autodiscovery. Use the default settings.
 4. Public services
 - **Service name:** `where-for-dinner`
 - **Service port:** 80

- **Public URL:** http where-for-dinner . Select a domain.

5. Global server load balancing and resiliency. Use the default settings.

You can now access the Where For Dinner application with the URL configured earlier.

Deployment use case: ACME Fitness Store

The following instructions describe an end-to-end process for configuring, building, and deploying the ACME Fitness Store application into a Tanzu Service Mesh GNS. In this use case, the application is deployed across two Tanzu Application Platform run clusters. ytt is used to run the build and deployment commands.

The configuration resources referenced in this scenario are in the [acme-fitness-tap-tsm](#) Git repository.

Deploy AppSSO

ACME requires the use of an AppSSO authorization server and client registration resource. Install these resources on the same run cluster that is named `RunCluster01` in the deployment section.

1. Deploy the authorization server instance by running:

```
ytt -f appSSOInstance.yaml -v workloadNamespace=WORKLOAD-NAMESPACE \
-v devDefaultAccountUsername=DEV-DEFAULT-ACCOUNT-USERNAME -v \
devDefaultAccountPassword=DEV-DEFAULT-ACCOUNT-PASSWORD | kubectl apply -f-
```

Where:

- `WORKLOAD-NAMESPACE` is the namespace where the workloads will be deployed
- `DEV-DEFAULT-ACCOUNT-USERNAME` is the user name for the ACME application authentication
- `DEV-DEFAULT-ACCOUNT-PASSWORD` is the password for the ACME application authentication

For example:

```
ytt -f https://raw.githubusercontent.com/gm2552/acme-fitness-tap-tsm/main/appSSOInstance.yaml -v \
workloadNamespace=acme -v devDefaultAccountUsername=acme -v \
devDefaultAccountPassword=fitness | kubectl apply -f-
```

2. Create a `ClientRegistration` resource by running:

```
ytt -f appSSOInstance.yaml -v workloadNamespace=WORKLOAD-NAMESPACE -v \
appSSORedirectURI=APP-SSO-REDIRECT-URI | kubectl apply -f-
```

Where:

- `WORKLOAD-NAMESPACE` is the namespace where the workloads will be deployed.
- `APP-SSO-REDIRECT-URI` is the public URI that the authorization server redirects to after a login

For example:

```
ytt -f https://raw.githubusercontent.com/gm2552/acme-fitness-tap-tsm/main/clientRegistrationResourceClaim.yaml \
-v workloadNamespace=acme -v \
appSSORedirectURI=http://acme-fitness.tsmdemo.perfect300rock.com/login/oauth2/code/sso | kubectl apply -f-
```

3. Obtain the appSSO Issuer URI by running:

```
kubectl get authserver -n WORKLOAD-NAMESPACE
```

Where `WORKLOAD-NAMESPACE` is the name of the namespace where the workloads will be deployed.

4. Record the Issuer URI because you need it for the next section.

Apply the workload resources to your build cluster

To build the application services, run the following command to apply the workload resources to your build cluster. You can also clone or fork the repository in the following command to either use the YAML files locally or point to your own Git repository.

```
ytt -f workloads.yaml -v workloadNamespace=WORKLOAD-NAMESPACE -v \
appSSOIssuerURI=APP-SSO-ISSUER-URL | kubectl apply -f-
```

Where:

- `WORKLOAD-NAMESPACE` is the name of your build namespace
- `APP-SSO-ISSUER-URL` is the URL of the AppSSO authorization server that you deployed earlier

For example:

```
ytt -f https://raw.githubusercontent.com/gm2552/acme-fitness-tap-tsm/main/workloads.yaml -v \
workloadNamespace=workloads -v \
appSSOIssuerURI=http://appssso-acme-fitness.acme.tsmdemo.perfect300rock.com | kubectl apply -f-
```

If you are using a GitOps workflow with your build cluster then, after building the workloads, the deployment information is pushed to your GitOps repository.

If you follow these instructions without pull requests in the GitOps workflow, the `config-writer` pods that commit deployment information to the GitOps repository might fail because of concurrency conflicts. A workaround for this is to delete the failed workloads from the build cluster and re-run the command provided in these instructions.

Create the Istio ingress resources

The authorization server requires a publicly accessible URL and must be available before the Spring Cloud Gateway can deploy properly. The authorization server is deployed at the URI `authserver` app domain.

You must create a domain name system address (DNS A) record in your DNS provider's configuration tool to point to the Istio load-balanced IP address of `RunCluster01`. The DNS configuration is out of the scope of this topic.

Create the Istio ingress resources by running:

```
ytt -f istioGateway.yaml -v workloadNamespace=WORKLOAD-NAMESPACE -v \
appDomainName=APP-DOMAIN | kubectl apply -f-
```

Where:

- `WORKLOAD-NAMESPACE` is the name of your build namespace
- `APP-DOMAIN` is the application's DNS domain

For example:

```
ytt -f https://raw.githubusercontent.com/gm2552/acme-fitness-tap-tsm/main/istioGateway.yaml -v \
workloadNamespace=acme -v appDomainName=tsmdemo.perfect300rock.com | kubectl apply -f-
```

Deploy Redis

A Redis instance is needed for caching the ACME fitness store cart service. Deploy the Redis instance by running:

```
ytt -f https://raw.githubusercontent.com/gm2552/acme-fitness-tap-tsm/main/redis.yaml -v \
workloadNamespace=WORKLOAD-NAMESPACE -v redisPassword=REDIS-PASSWORD | kb apply -f-
```

Where:

- `WORKLOAD-NAMESPACE` is the namespace where the workloads will be deployed
- `REDIS-PASSWORD` is your password

For example:

```
ytt -f https://raw.githubusercontent.com/gm2552/acme-fitness-tap-tsm/main/redis.yaml -v \
workloadNamespace=acme -v redisPassword=fitness | kubectl apply -f-
```

Run cluster deployment

Workloads are deployed to the run cluster by using deliverable resources. In this section you apply the deliverable resources directly to the run clusters, instead of using a kapp application. This deployment assumes that two clusters are part of the Tanzu Service Mesh GNS ACME. In this example these clusters are named `RunCluster01` and `RunCluster02`.

The deliverable objects reference the GitOps repository, where the build cluster has written deployment information, and need to reference this repository in the following commands.

To deploy the workloads to the run clusters, run these commands against their respective clusters:

```
ytt -f cluster01Deliverables.yaml -v workloadNamespace=WORKLOAD-NAMESPACE -v \
gitOpsSecret=GIT-OPS-SECRET -v gitOpsRepo=GIT-OPS-REPO | kubectl apply -f-
```

Where:

- `WORKLOAD-NAMESPACE` is the namespace where the workloads will be deployed
- `GIT-OPS-SECRET` is the GitOps secret used to access the GitOps repository
- `GIT-OPS-REPO` is the URL of the GitOps repository where the build cluster wrote out deployment configuration information

```
ytt -f cluster02Deliverables.yaml -v workloadNamespace=WORKLOAD-NAMESPACE -v \
gitOpsSecret=GIT-OPS-SECRET -v gitOpsRepo=GIT-OPS-REPO | kubectl apply -f-
```

Where:

- `WORKLOAD-NAMESPACE` is the namespace where the workloads will be deployed
- `GIT-OPS-SECRET` is the GitOps secret used to access the GitOps repository
- `GIT-OPS-REPO` is the URL of the GitOps repository where the build cluster wrote out deployment configuration information

For the `RunCluster01` example, run:

```
ytt -f https://raw.githubusercontent.com/gm2552/acme-fitness-tap-tsm/main/cluster01Deliverables.yaml \
-v workloadNamespace=acme -v gitOpsSecret=tap-play-gitops-secret -v \
gitOpsRepo=https://github.com/gm2552/tap-play-gitops.git | kubectl apply -f-
```

For the `RunCluster02` example, run:

```
ytt -f https://raw.githubusercontent.com/gm2552/acme-fitness-tap-tsm/main/cluster02Deliverables.yaml \
-v workloadNamespace=acme -v gitOpsSecret=tap-play-gitops-secret -v \
gitOpsRepo=https://github.com/gm2552/tap-play-gitops.git | kubectl apply -f-
```

Deploy Spring Cloud Gateway

The following sections describe how to deploy Spring Cloud Gateway.

Install the Spring Cloud Gateway package

The section requires the Spring Cloud Gateway for Kubernetes package to be installed on `RunCluster01`. If Spring Cloud Gateway is already installed on the run cluster, skip these install steps.

In Tanzu Application Platform v1.5 and later, Spring Cloud Gateway is included as an optional package in the Tanzu Application Platform Carvel bundle. Install the Spring Cloud Gateway package with the default settings by using this Tanzu CLI template:

```
tanzu package install scg --package spring-cloud-gateway.tanzu.vmware.com \
--version VERSION-NUMBER -n TAP-INSTALL-NAMESPACE
```

For example:

```
tanzu package install scg --package spring-cloud-gateway.tanzu.vmware.com \
--version 2.0.0-tap.3 -n tap-install
```

Configure the Spring Cloud Gateway instance and route

The Tanzu Application Platform fork of the ACME fitness store uses Spring Cloud Gateway for routing API classes from the web front end to the microservices.



Caution

The Spring Cloud Gateway `spec.service.name` configuration was not built with multicluster or cross-cluster support. The configuration for the gateway routes currently implements a workaround, which is brittle in terms of where certain services are deployed. Future releases of the gateway might have better support for this use case.

Deploy the gateway and applicable routes by running:

```
ytt -f scgInstance.yaml -v workloadNamespace=WORKLOAD-NAMESPACE
```

Where `WORKLOAD-NAMESPACE` is the namespace where the workload is deployed.

```
ytt -f scgRoutes.yaml -v workloadNamespace=WORKLOAD-NAMESPACE
```

Where `WORKLOAD-NAMESPACE` is the namespace where the workload is deployed.

For example:

```
ytt -f https://raw.githubusercontent.com/gm2552/acme-fitness-tap-tsm/main/scgInstance.
yaml -v \
workloadNamespace=acme | kubectl apply -f-
```

```
ytt -f https://raw.githubusercontent.com/gm2552/acme-fitness-tap-tsm/main/scgRoutes.ya
ml -v \
workloadNamespace=acme | kubectl apply -f-
```

Create a global namespace

The example clusters are named `RunCluster01` and `RunCluster02`, and they assume a workload namespace of ACME.

1. Open the Tanzu Service Mesh console and create a new global namespace.
2. Configure the following settings in each step:
 1. General details
 - **GNS name:** acme-tap
 - **Domain:** acme-tap.lab
 2. Namespace mapping
 - Namespace mapping Rule 1
 - **Cluster name:** RunCluster01
 - **Namespace:** acme
 - Namespace Mapping Rule 2
 - **Cluster name:** RunCluster02
 - **Namespace:** acme
 3. Autodiscovery. Use the default settings.
 4. Public Services
 - No Public service
 5. Global server load-balancing and resiliency. Use the default settings.

You can access the application by going to the URL <http://acme-fitness>.

Set up Tanzu Service Mesh

This topic tells you how to set up a Tanzu Application Platform application deployed on Kubernetes with Tanzu Service Mesh (commonly called TSM).

Sample applications are used to demonstrate how a global namespace can provide a network for Kubernetes workloads that are connected and secured within and across clusters, and across clouds.



Note

You can also use Tanzu Mission Control (commonly called TMC) to install Tanzu Application Platform (commonly called TAP) on a managed cluster. For more information, see the [Tanzu Mission Control documentation](#).

Prerequisites

Meet the [prerequisites](#), which includes having

- A supported Kubernetes platform
- The correct resource configuration (number of nodes, CPUs, RAM, and so on)
- The required connectivity requirements

Connectivity is only required from your local clusters out to Tanzu Service Mesh and not inwards. This can traverse a corporate proxy as well. In addition, connectivity in the data plane is required between the clusters that must communicate, specifically egress to ingress gateways. No data plane traffic needs to reach the Tanzu Service Mesh software as a service (SaaS) management plane.

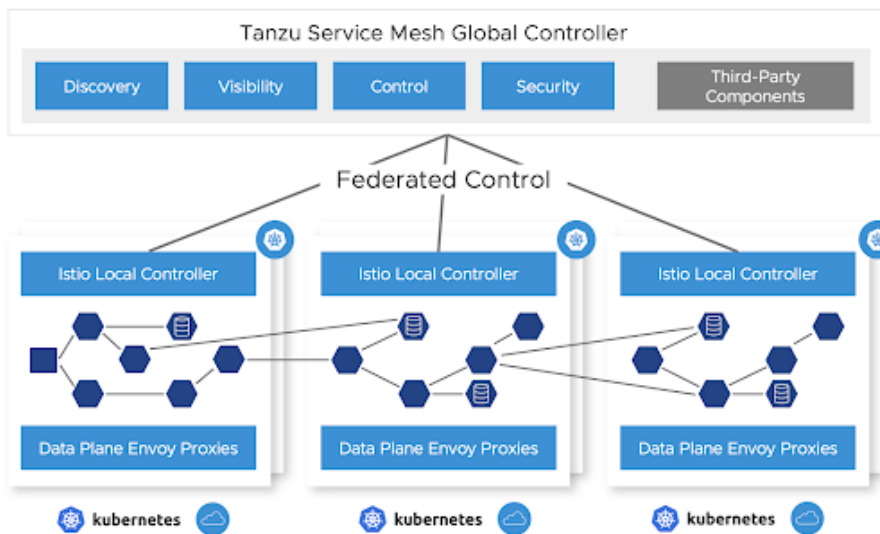

Activate your Tanzu Service Mesh subscription

Activate your Tanzu Service Mesh subscription at cloud.vmware.com. After purchasing your Tanzu Service Mesh subscription, the VMware Cloud team sends you instructions. If you don't receive them, you can follow [these instructions](#).

Onboard your clusters to Tanzu Service Mesh as described later in this topic. This deploys the Tanzu Service Mesh local control plane and OSS Istio on your Kubernetes cluster and connects the local control plane to your Tanzu Service Mesh tenant.

Set up Tanzu Application Platform

To enable Tanzu Service Mesh support in Tanzu Application Platform Build clusters:

1. Add the following key to `tap-values.yaml` under the `buildservice` top-level key:

```
buildservice:
  injected_sidecar_support: true
```

2. [Install Tanzu Application Platform](#) on the run cluster.

End-to-end workload build and deployment scenario

The following sections describe how to build and deploy a workload.

Apply a workload resource to a build cluster

Workloads can be built by using a Tanzu Application Platform supply chain by applying a workload resource to a build cluster. At this time, Tanzu Service Mesh and Tanzu Application Platform cannot use the Knative resources that are the default runtime target when using the `web` resource type.

In Tanzu Application Platform v1.4 and later, two workload types support a Tanzu Service Mesh and Tanzu Application Platform integration: **server** and **worker**.

To work with Tanzu Service Mesh, web workloads must be converted to the `server` or `worker` workload type. Server workloads cause a Kubernetes `Deployment` resource to be created with a `Service` resource that uses port 8080 by default.

1. If the service port that you want is 80 or some other port, add port information to `workload.yaml`. The following example YAML snippets show the changes to make from the `web` to `server` workload type. This is an example before applying the changes:

```
apiVersion: carto.run/v1alpha1
kind: Workload
metadata:
  name: where-for-dinner
  labels:
    apps.tanzu.vmware.com/workload-type: web
    app.kubernetes.io/part-of: where-for-dinner-api-gateway
spec:
  params:
    - name: annotations
value:
  autoscaling.knative.dev/minScale: "1"
  source:
    git:
      url: https://github.com/vmware-tanzu/application-accelerator-samples.git
      ref:
        branch: tap-1.6.x
        subPath: where-for-dinner/where-for-dinner-api-gateway
```

This is an example modified for Tanzu Service Mesh, which includes the removal of the autoscaling annotation:

```
apiVersion: carto.run/v1alpha1
kind: Workload
metadata:
  name: where-for-dinner
  labels:
    apps.tanzu.vmware.com/workload-type: server # modification
    app.kubernetes.io/part-of: where-for-dinner-api-gateway
spec:
  params:
    - name: ports # modification
value:
  - port: 80 # modification
    containerPort: 8080 # modification
    name: http # modification
  source:
    git:
      url: https://github.com/vmware-tanzu/application-accelerator-samples.git
      ref:
        branch: tap-1.6.x
        subPath: where-for-dinner/where-for-dinner-api-gateway
```

This results in a deployment and a service that listens on port 80 and forwards traffic to port 8080 on the pod's workload container.

2. Submit the modified YAML to your build cluster by running:

```
tanzu apps NAMESPACE apply --file WORKLOAD-YAML-FILE
```

Where:

- `NAMESPACE` is the namespace that the build cluster uses for building.
- `WORKLOAD-YAML-FILE` is the name of your workload YAML file, such as `workload.yaml`.

After your workload is built a `Deliverable` resource is created.

Configure egress for Tanzu Build Service

For Tanzu Build Service to properly work, provide egress to access the registry where Tanzu Build Service writes application images, and define the registry in the `kp_default_repository` key and the Tanzu Application Platform install registry.

Additionally, configure egress for buildpack builds to download any required dependencies. This configuration varies with different buildpacks and language environments. For example, Java builds might need to download dependencies from Maven central.

Create a global namespace

Using the Tanzu Service Mesh portal or API, create a global namespace (GNS) that includes the namespaces where your application components are deployed. For more information, see [Global Namespaces](#)

Whether in a single cluster or multiple clusters, or within the same site or across clouds, after you add a namespace selection to the GNS, the services that Tanzu Application Platform deploys are connected based on the GNS configuration for service discovery and connectivity policies.

If a service must be accessible through the ingress from the outside, it can be configured through the public service option in Tanzu Service Mesh or directly through Istio on the clusters where that service resides. It's best practice to configure the service's accessibility through the GNS.

Run cluster deployment

Before deploying a workload to a run cluster, ensure that any prerequisite resources have already been created on the run cluster. This includes concepts such as data, messaging, routing, security services, RBAC, ResourceClaims, and so on.

After a successful build in a build cluster, workloads can be deployed to the run cluster by applying resulting deliverable resources to the run cluster as described in [Getting Started with Multicloud Tanzu Application Platform](#).

Another option is to create a kapp application that references a GitOps repository to include all deliverable resources for a given cluster. See the following example of a kapp definition that points to a GitOps repository:

```
apiVersion: kappctrl.k14s.io/v1alpha1
kind: App
metadata:
  name: deliverable-gitops
  namespace: where-for-dinner
spec:
  serviceAccountName: default
  fetch:
  - git:
    url: https://github.com/gm2552/tap-play-gitops
    ref: origin/deliverables-tap-east01
    subPath: config
  template:
```

```
- ytt: {}
deploy:
- kapp: {}
```

The advantage of this model is that applications can be deployed or uninstalled from a cluster by managing the contents of the deliverable resources from within the GitOps repository and enabling a GitOps workflow for application and service change control.

Deployment use case: Where For Dinner

The following instructions describe an end-to-end process for configuring, building, and deploying the Where For Dinner application into a Tanzu Service Mesh global namespace.

These instructions use the default configuration of Where For Dinner, which consists of only needing a single-node RabbitMQ cluster, an in-memory database, and no security. The application is deployed across two Tanzu Application Platform run clusters. It requires the `ytt` command to execute the build and deployment commands.

The configuration resources referenced in this scenario are located in the [where-for-dinner-tap-tsm](#) GitHub repository.

Create an initial set of configuration files from the accelerator

This use case deployment includes a pre-built set of configuration files in a Git repository. However, they were created from a set of configuration files by using a bootstrapped process that uses the Where For Dinner accelerator, and were later modified.

For reference, you can create an initial set of configuration files from the Where For Dinner accelerator, which is available in Tanzu Application Platform v1.3 and later.

This section does not include instructions for modifying the configuration files from the accelerator into configuration files used in a later section.

From the accelerator, accept all of the default options with the following exceptions:

- **Workload namespace:** Update this field with the name of the namespace you will use to build the application in your build cluster
- **Service namespace:** Update this field with the name of the namespace you will use to deploy a RabbitMQ cluster on your Tanzu Application Platform run cluster

Apply the workload resources to your build cluster

To build the application services, run the following command to apply the workload resources to your build cluster. You can also clone or fork the repository in this command to either use the YAML files locally or point to your own Git repository.

```
ytt -f workloads.yaml -v workloadNamespace=WORKLOAD-NAMESPACE | kubectl apply -f-
```

Where `WORKLOAD-NAMESPACE` is the name of your build namespace

For example:

```
ytt -f https://raw.githubusercontent.com/gm2552/where-for-dinner-tap-tsm/main/workloads.yaml \
-v workloadNamespace=workloads | kubectl apply -f-
```

If you are using a GitOps workflow with your build cluster, after the workloads are built the deployment information is pushed to your GitOps repository.

If you follow these instructions without pull requests in the GitOps workflow, the config-writer pods that commit deployment information to the GitOps repository might fail because of concurrency conflicts. A workaround for this is to delete the failed workloads from the build cluster and re-run the command provided in the instructions.

Install service claim resources on the cluster

Where For Dinner requires a RabbitMQ cluster installed on your run cluster. You must install RabbitMQ on the same run cluster that is named `RunCluster01` in the following deployment section. Additionally, you must install service claim resources on this cluster.

1. If you haven't already done so, install the RabbitMQ Cluster Operator on the run cluster by running:

```
kubectl apply -f "https://github.com/rabbitmq/cluster-operator/releases/download/v1.13.1/cluster-operator.yml"
```

2. Spin up an instance of a RabbitMQ cluster by running:

```
kubectl create ns SERVICE-NAMESPACE

ytt -f rmqCluster.yaml -v serviceNamespace=SERVICE-NAMESPACE | kubectl apply -f -
```

Where `SERVICE-NAMESPACE` is the namespace of where you want to deploy your RabbitMQ cluster

For example:

```
kubectl create ns service-instances

ytt -f https://raw.githubusercontent.com/gm2552/where-for-dinner-tap-tsm/main/rmqCluster.yaml -v \
serviceNamespace=service-instances | kubectl apply -f-
```

3. Create service toolkit resources for the RabbitMQ class and resource claim by running:

```
ytt -f rmqResourceClaim.yaml -v serviceNamespace=SERVICE-NAMESPACE -v \
workloadNamespace=WORKLOAD-NAMESPACE | kubectl apply -f-
```

Where `SERVICE-NAMESPACE` and `WORKLOAD-NAMESPACE` are the namespaces where you deployed your RabbitMQ cluster and the namespace where the application service will run.

For example:

```
ytt -f https://raw.githubusercontent.com/gm2552/where-for-dinner-tap-tsm/main/rmqResourceClaim.yaml \
-v serviceNamespace=service-instances -v workloadNamespace=where-for-dinner | k
ubectl apply -f-
```

Run cluster deployment

Workloads are deployed to the run cluster using deliverable resources. This section applies the deliverable resources directly to the run clusters instead of using a kapp application.

This deployment assumes that two clusters are part of the Tanzu Service Mesh GNS Where For Dinner. These example clusters are named `RunCluster01` and `RunCluster02`. The majority of the workload is deployed to `RunCluster01` while the crawler workload is deployed to `RunCluster02`.

The deliverable objects reference the GitOps repository, where the build cluster has written deployment information, and needs to reference this repository in the following commands.

Deploy the workloads to the run clusters by running these commands against their respective clusters:

```
ytt -f cluster01Deliverables.yaml -v workloadNamespace=WORKLOAD-NAMESPACE -v \
gitOpsSecret=GIT-OPS-SECRET -v gitOpsRepo=GIT-OPS-REPO | kubectl apply -f-
```

Where:

- `WORKLOAD-NAMESPACE` is the namespace where the workloads are deployed
- `GIT-OPS-SECRET` is the GitOps secret used to access the GitOps repository
- `GIT-OPS-REPO` is the URL of the GitOps repository where the build cluster wrote out deployment configuration information

```
ytt -f cluster02Deliverables.yaml -v workloadNamespace=WORKLOAD-NAMESPACE -v \
gitOpsSecret=GIT-OPS-SECRET -v gitOpsRepo=GIT-OPS-REPO | kubectl apply -f-
```

Where:

- `WORKLOAD-NAMESPACE` is the namespace where the workloads are deployed
- `GIT-OPS-SECRET` is the GitOps secret used to access the GitOps repository
- `GIT-OPS-REPO` is the URL of the GitOps repository where the build cluster wrote out deployment configuration information

To run this deployment on cluster `RunCluster01`, for example, you run:

```
ytt -f https://raw.githubusercontent.com/gm2552/where-for-dinner-tap-tsm/main/cluster0
1Deliverables.yaml -v \
workloadNamespace=where-for-dinner -v gitOpsSecret=tap-play-gitops-secret -v \
gitOpsRepo=https://github.com/gm2552/tap-play-gitops.git | kubectl apply -f-
```

To run this deployment on cluster `RunCluster02`, for example, you run:

```
ytt -f https://raw.githubusercontent.com/gm2552/where-for-dinner-tap-tsm/main/cluster0
2Deliverables.yaml -v \
workloadNamespace=where-for-dinner -v gitOpsSecret=tap-play-gitops-secret -v \
gitOpsRepo=https://github.com/gm2552/tap-play-gitops.git | kubectl apply -f-
```

You can create an Istio ingress resource on `RunCluster01` if you do not plan on using the GNS capabilities to expose the application to external networks.

You must create a domain name system address (DNS A) record in your DNS provider's configuration tool to point to the Istio load-balanced IP address of `RunCluster01`. The DNS configuration is out of the scope of this topic.

Create the ingress by running:

```
ytt -f ingress.yaml -v workloadNamespace=WORKLOAD-NAMESPACE -v domainName=DOMAIN-NAME
| kubectl apply -f-
```

Where:

- `WORKLOAD-NAMESPACE` is the namespace where the workload is deployed
- `DOMAIN-NAME` is the public domain that will host your application

For example:

```
ytt -f https://raw.githubusercontent.com/gm2552/where-for-dinner-tap-tsm/main/ingress.
yaml -v \
workloadNamespace=where-for-dinner -v domainName=tsmdemo.perfect300rock.com | kubectl
apply -f-
```

Create a global namespace

The example clusters have the names `RunCluster01` and `RunCluster02`, and they assume the workload and service namespaces of `where-for-dinner` and `service-instances`, respectively.

1. Open the Tanzu Service Mesh console and create a new GNS.
2. Configure the following settings in each step:
 1. General details
 - **GNS Name:** where-for-dinner
 - **Domain:** where-for-dinner.lab
 2. Namespace mapping
 - Namespace mapping Rule 1
 - **Cluster name:** RunCluster01
 - **Namespace:** where-for-dinner
 - Namespace Mapping Rule 2
 - **Cluster name:** RunCluster02
 - **Namespace:** where-for-dinner
 - Namespace Mapping Rule 3
 - **Cluster name:** RunCluster01
 - **Namespace:** service-instances
 3. Autodiscovery. Use the default settings.
 4. Public services
 - **Service name:** where-for-dinner
 - **Service port:** 80
 - **Public URL:** http where-for-dinner . Select a domain.
 5. Global server load balancing and resiliency. Use the default settings.

You can now access the Where For Dinner application with the URL configured earlier.

Deployment use case: ACME Fitness Store

The following instructions describe an end-to-end process for configuring, building, and deploying the ACME Fitness Store application into a Tanzu Service Mesh GNS. In this use case, the application is deployed across two Tanzu Application Platform run clusters. `ytt` is used to run the build and deployment commands.

The configuration resources referenced in this scenario are in the [acme-fitness-tap-tsm](#) Git repository.

Deploy AppSSO

ACME requires the use of an AppSSO authorization server and client registration resource. Install these resources on the same run cluster that is named `RunCluster01` in the deployment section.

1. Deploy the authorization server instance by running:

```
ytt -f appSSOInstance.yaml -v workloadNamespace=WORKLOAD-NAMESPACE \
-v devDefaultAccountUsername=DEV-DEFAULT-ACCOUNT-USERNAME -v \
devDefaultAccountPassword=DEV-DEFAULT-ACCOUNT-PASSWORD | kubectl apply -f-
```

Where:

- `WORKLOAD-NAMESPACE` is the namespace where the workloads will be deployed
- `DEV-DEFAULT-ACCOUNT-USERNAME` is the user name for the ACME application authentication
- `DEV-DEFAULT-ACCOUNT-PASSWORD` is the password for the ACME application authentication

For example:

```
ytt -f https://raw.githubusercontent.com/gm2552/acme-fitness-tap-tsm/main/appSSOInstance.yaml -v \
workloadNamespace=acme -v devDefaultAccountUsername=acme -v \
devDefaultAccountPassword=fitness | kubectl apply -f-
```

2. Create a `ClientRegistration` resource by running:

```
ytt -f appSSOInstance.yaml -v workloadNamespace=WORKLOAD-NAMESPACE -v \
appSSORedirectURI=APP-SSO-REDIRECT-URI | kubectl apply -f-
```

Where:

- `WORKLOAD-NAMESPACE` is the namespace where the workloads will be deployed.
- `APP-SSO-REDIRECT-URI` is the public URI that the authorization server redirects to after a login

For example:

```
ytt -f https://raw.githubusercontent.com/gm2552/acme-fitness-tap-tsm/main/clientRegistrationResourceClaim.yaml \
-v workloadNamespace=acme -v \
appSSORedirectURI=http://acme-fitness.tsmdemo.perfect300rock.com/login/oauth2/code/sso | kubectl apply -f-
```

3. Obtain the appSSO Issuer URI by running:

```
kubectl get authserver -n WORKLOAD-NAMESPACE
```

Where `WORKLOAD-NAMESPACE` is the name of the namespace where the workloads will be deployed.

4. Record the Issuer URI because you need it for the next section.

Apply the workload resources to your build cluster

To build the application services, run the following command to apply the workload resources to your build cluster. You can also clone or fork the repository in the following command to either use the YAML files locally or point to your own Git repository.

```
ytt -f workloads.yaml -v workloadNamespace=WORKLOAD-NAMESPACE -v \
appSSOIssuerURI=APP-SSO-ISSUER-URL | kubectl apply -f-
```

Where:

- `WORKLOAD-NAMESPACE` is the name of your build namespace

- `APP-SSO-ISSUER-URL` is the URL of the AppSSO authorization server that you deployed earlier

For example:

```
ytt -f https://raw.githubusercontent.com/gm2552/acme-fitness-tap-tsm/main/workloads.yaml -v \
workloadNamespace=workloads -v \
appSSOIssuerURI=http://appssso-acme-fitness.acme.tsmdemo.perfect300rock.com | kubectl apply -f-
```

If you are using a GitOps workflow with your build cluster then, after building the workloads, the deployment information is pushed to your GitOps repository.

If you follow these instructions without pull requests in the GitOps workflow, the `config-writer` pods that commit deployment information to the GitOps repository might fail because of concurrency conflicts. A workaround for this is to delete the failed workloads from the build cluster and re-run the command provided in these instructions.

Create the Istio ingress resources

The authorization server requires a publicly accessible URL and must be available before the Spring Cloud Gateway can deploy properly. The authorization server is deployed at the URI `authserver` app domain.

You must create a domain name system address (DNS A) record in your DNS provider's configuration tool to point to the Istio load-balanced IP address of `RunCluster01`. The DNS configuration is out of the scope of this topic.

Create the Istio ingress resources by running:

```
ytt -f istioGateway.yaml -v workloadNamespace=WORKLOAD-NAMESPACE -v \
appDomainName=APP-DOMAIN | kubectl apply -f-
```

Where:

- `WORKLOAD-NAMESPACE` is the name of your build namespace
- `APP-DOMAIN` is the application's DNS domain

For example:

```
ytt -f https://raw.githubusercontent.com/gm2552/acme-fitness-tap-tsm/main/istioGateway.yaml -v \
workloadNamespace=acme -v appDomainName=tsmdemo.perfect300rock.com | kubectl apply -f-
```

Deploy Redis

A Redis instance is needed for caching the ACME fitness store cart service. Deploy the Redis instance by running:

```
ytt -f https://raw.githubusercontent.com/gm2552/acme-fitness-tap-tsm/main/redis.yaml -v \
workloadNamespace=WORKLOAD-NAMESPACE -v redisPassword=REDIS-PASSWORD | kb apply -f-
```

Where:

- `WORKLOAD-NAMESPACE` is the namespace where the workloads will be deployed
- `REDIS-PASSWORD` is your password

For example:

```
ytt -f https://raw.githubusercontent.com/gm2552/acme-fitness-tap-tsm/main/redis.yaml -v \
workloadNamespace=acme -v redisPassword=fitness | kubectl apply -f-
```

Run cluster deployment

Workloads are deployed to the run cluster by using deliverable resources. In this section you apply the deliverable resources directly to the run clusters, instead of using a kapp application. This deployment assumes that two clusters are part of the Tanzu Service Mesh GNS ACME. In this example these clusters are named `RunCluster01` and `RunCluster02`.

The deliverable objects reference the GitOps repository, where the build cluster has written deployment information, and need to reference this repository in the following commands.

To deploy the workloads to the run clusters, run these commands against their respective clusters:

```
ytt -f cluster01Deliverables.yaml -v workloadNamespace=WORKLOAD-NAMESPACE -v \
gitOpsSecret=GIT-OPS-SECRET -v gitOpsRepo=GIT-OPS-REPO | kubectl apply -f-
```

Where:

- `WORKLOAD-NAMESPACE` is the namespace where the workloads will be deployed
- `GIT-OPS-SECRET` is the GitOps secret used to access the GitOps repository
- `GIT-OPS-REPO` is the URL of the GitOps repository where the build cluster wrote out deployment configuration information

```
ytt -f cluster02Deliverables.yaml -v workloadNamespace=WORKLOAD-NAMESPACE -v \
gitOpsSecret=GIT-OPS-SECRET -v gitOpsRepo=GIT-OPS-REPO | kubectl apply -f-
```

Where:

- `WORKLOAD-NAMESPACE` is the namespace where the workloads will be deployed
- `GIT-OPS-SECRET` is the GitOps secret used to access the GitOps repository
- `GIT-OPS-REPO` is the URL of the GitOps repository where the build cluster wrote out deployment configuration information

For the `RunCluster01` example, run:

```
ytt -f https://raw.githubusercontent.com/gm2552/acme-fitness-tap-tsm/main/cluster01Deliverables.yaml \
-v workloadNamespace=acme -v gitOpsSecret=tap-play-gitops-secret -v \
gitOpsRepo=https://github.com/gm2552/tap-play-gitops.git | kubectl apply -f-
```

For the `RunCluster02` example, run:

```
ytt -f https://raw.githubusercontent.com/gm2552/acme-fitness-tap-tsm/main/cluster02Deliverables.yaml \
-v workloadNamespace=acme -v gitOpsSecret=tap-play-gitops-secret -v \
gitOpsRepo=https://github.com/gm2552/tap-play-gitops.git | kubectl apply -f-
```

Deploy Spring Cloud Gateway

The following sections describe how to deploy Spring Cloud Gateway.

Install the Spring Cloud Gateway package

The section requires the Spring Cloud Gateway for Kubernetes package to be installed on `RunCluster01`. If Spring Cloud Gateway is already installed on the run cluster, skip these install

steps.

In Tanzu Application Platform v1.5 and later, Spring Cloud Gateway is included as an optional package in the Tanzu Application Platform Carvel bundle. Install the Spring Cloud Gateway package with the default settings by using this Tanzu CLI template:

```
tanzu package install scg --package spring-cloud-gateway.tanzu.vmware.com \
--version VERSION-NUMBER -n TAP-INSTALL-NAMESPACE
```

For example:

```
tanzu package install scg --package spring-cloud-gateway.tanzu.vmware.com \
--version 2.0.0-tap.3 -n tap-install
```

Configure the Spring Cloud Gateway instance and route

The Tanzu Application Platform fork of the ACME fitness store uses Spring Cloud Gateway for routing API classes from the web front end to the microservices.



Caution

The Spring Cloud Gateway `spec.service.name` configuration was not built with multicluster or cross-cluster support. The configuration for the gateway routes currently implements a workaround, which is brittle in terms of where certain services are deployed. Future releases of the gateway might have better support for this use case.

Deploy the gateway and applicable routes by running:

```
ytt -f scgInstance.yaml -v workloadNamespace=WORKLOAD-NAMESPACE
```

Where `WORKLOAD-NAMESPACE` is the namespace where the workload is deployed.

```
ytt -f scgRoutes.yaml -v workloadNamespace=WORKLOAD-NAMESPACE
```

Where `WORKLOAD-NAMESPACE` is the namespace where the workload is deployed.

For example:

```
ytt -f https://raw.githubusercontent.com/gm2552/acme-fitness-tap-tsm/main/scgInstance.
yaml -v \
workloadNamespace=acme | kubectl apply -f-
```

```
ytt -f https://raw.githubusercontent.com/gm2552/acme-fitness-tap-tsm/main/scgRoutes.ya
ml -v \
workloadNamespace=acme | kubectl apply -f-
```

Create a global namespace

The example clusters are named `RunCluster01` and `RunCluster02`, and they assume a workload namespace of ACME.

1. Open the Tanzu Service Mesh console and create a new global namespace.
2. Configure the following settings in each step:
 1. General details

- **GNS name:** acme-tap
 - **Domain:** acme-tap.lab
2. Namespace mapping
 - Namespace mapping Rule 1
 - **Cluster name:** RunCluster01
 - **Namespace:** acme
 - Namespace Mapping Rule 2
 - **Cluster name:** RunCluster02
 - **Namespace:** acme
 3. Autodiscovery. Use the default settings.
 4. Public Services
 - No Public service
 5. Global server load-balancing and resiliency. Use the default settings.

You can access the application by going to the URL <http://acme-fitness>.

Overview of workloads

This topic provides you with an overview of workload types in Tanzu Application Platform (commonly known as TAP).

Workload features

Tanzu Application Platform allows you to quickly build and test applications regardless of your familiarity with Kubernetes.

You can turn source code into a workload that runs in a container with a URL. You can also use supply chains to build applications that process work from a message queue, or provide arbitrary network services.

A workload allows you to choose application specifications, such as repository location, environment variables, service binding, and so on. For more information about workload creation and management, see [Commands Details](#).

The Out of the Box supply chains support a range of workload types, including

- Scalable web applications ([web](#))
- Traditional application servers ([server](#))
- Background applications ([worker](#))
- Serverless functions

You can use a collection of workloads of different types to deploy microservices that function as a logical application. Alternatively, you can deploy your entire application as a single monolith.

If you build your own supply chains, you can define additional deployment methods beyond those in the Out of the Box supply-chain templates.

Available workload types

When using the Out of the Box supply chain, the apps.tanzu.vmware.com/workload-type annotation selects which style of deployment is suitable for your application. The valid values are:

Type	Description	Indicators
web	Scalable web applications	<ul style="list-style-type: none"> • Scales based on request load • Automatically exposed by HTTP Ingress • Does not perform background work • Works with Service Bindings • Stateless • Quick startup time

Type	Description	Indicators
<code>server</code>	Traditional applications	<ul style="list-style-type: none"> Provides HTTP or TCP services on the network Exposed by external Ingress or LoadBalancer settings Might perform background work from a queue Works with Service Bindings Fixed scaling, no disk persistence Startup time not an issue
<code>worker</code>	Background applications	<ul style="list-style-type: none"> Does not provide network services Not exposed externally as a network service Performs background work from a queue Works with Service Bindings Fixed scaling, no disk persistence Startup time not an issue

Overview of workloads

This topic provides you with an overview of workload types in Tanzu Application Platform (commonly known as TAP).

Workload features

Tanzu Application Platform allows you to quickly build and test applications regardless of your familiarity with Kubernetes.

You can turn source code into a workload that runs in a container with a URL. You can also use supply chains to build applications that process work from a message queue, or provide arbitrary network services.

A workload allows you to choose application specifications, such as repository location, environment variables, service binding, and so on. For more information about workload creation and management, see [Commands Details](#).

The Out of the Box supply chains support a range of workload types, including

- Scalable web applications (`web`)
- Traditional application servers (`server`)
- Background applications (`worker`)
- Serverless functions

You can use a collection of workloads of different types to deploy microservices that function as a logical application. Alternatively, you can deploy your entire application as a single monolith.

If you build your own supply chains, you can define additional deployment methods beyond those in the Out of the Box supply-chain templates.

Available workload types

When using the Out of the Box supply chain, the `apps.tanzu.vmware.com/workload-type` annotation selects which style of deployment is suitable for your application. The valid values are:

Type	Description	Indicators
<code>web</code>	Scalable web applications	<ul style="list-style-type: none"> • Scales based on request load • Automatically exposed by HTTP Ingress • Does not perform background work • Works with Service Bindings • Stateless • Quick startup time
<code>server</code>	Traditional applications	<ul style="list-style-type: none"> • Provides HTTP or TCP services on the network • Exposed by external Ingress or LoadBalancer settings • Might perform background work from a queue • Works with Service Bindings • Fixed scaling, no disk persistence • Startup time not an issue
<code>worker</code>	Background applications	<ul style="list-style-type: none"> • Does not provide network services • Not exposed externally as a network service • Performs background work from a queue • Works with Service Bindings • Fixed scaling, no disk persistence • Startup time not an issue

Use web workloads

This topic tells you how to use the `web` workload type in Tanzu Application Platform (commonly known as TAP).

Overview

The `web` workload type allows you to deploy web applications on Tanzu Application Platform. Using an application workload specification, you can turn source code into a scalable, stateless application that runs in a container with an automatically-assigned URL. This type of application is often called serverless, and is deployed using Knative.

The `web` workload type is suitable for modern stateless web applications that follow [the twelve-factor app](#) methodology and have the following characteristics:

- Perform all work through HTTP requests, including gRPC and WebSocket
- Do not perform work except when processing a request
- Start up quickly
- Store state in external databases instead of storing state locally

Applications using the `web` workload type have the following features:

- Automatic request-based scaling, including scale-to-zero
- Automatic URL provisioning and optional certificate provisioning
- Automatic health-check definitions, if not provided by a convention
- Blue-green application rollouts

When creating a workload with the `tanzu apps workload create` command, you can use the `--type=web` argument to select the `web` workload type. For more information, see [Use the web Workload Type](#) later in this topic.

You can also use the `apps.tanzu.vmware.com/workload-type:web` label in the YAML workload description to support this deployment type.

Use the `web` workload type

The `tanzu-java-web-app` workload mentioned in [Deploy an app on Tanzu Application Platform](#) is a good match for the `web` workload type. It is a good match because it serves HTTP requests and does not perform any background processing.

You can experiment with the differences between the `web` and `server` workload types by changing the workload type. To change the workload type run:

```
tanzu apps workload apply tanzu-java-web-app --type=server
```

After changing the workload type to `server`, the application does not auto-scale or expose an external URL. For more information about the server workload type, see [Use Server workloads](#).

Switch back to the `web` workload by running:

```
tanzu apps workload apply tanzu-java-web-app --type=web
```

Use this to test which applications can function well as serverless web applications, and which are more suited to the `server` application style.

Use server workloads

This topic tells you how to use the `server` workload type in Tanzu Application Platform (commonly known as TAP).

Overview

The `server` workload type allows you to deploy traditional network applications on Tanzu Application Platform.

Using an application workload specification, you can build and deploy application source code to a manually-scaled Kubernetes deployment which exposes an in-cluster Service endpoint. If required, you can use environment-specific LoadBalancer Services or Ingress resources to expose these applications outside the cluster.

The `server` workload is suitable for traditional applications, including HTTP applications, which have the following characteristics:

- Store state locally
- Run background tasks outside of requests
- Provide multiple network ports or non-HTTP protocols
- Are not a good match for the `web` workload type

An application using the `server` workload type has the following features:

- Does not natively autoscale, but you can use these applications with the Kubernetes Horizontal Pod Autoscaler.
- By default, is exposed only within the cluster using a `ClusterIP` service.

- Uses health checks if defined by a convention.
- Uses a rolling update pattern by default.

When creating a workload with the `tanzu apps workload create` command, you can use the `--type=server` argument to select the `server` workload type. For more information, see [Use the server Workload Type](#) later in this topic. You can also use the `apps.tanzu.vmware.com/workload-type:server` annotation in the YAML workload description to support this deployment type.

Use the `server` workload type

The `spring-sensors-consumer-web` workload in [Bind an application workload to the service instance](#) in the Get started guide is a good match for the `server` workload type.

This is because it runs continuously to extract information from a RabbitMQ queue, and stores the resulting data locally in memory and presents it through a web UI.

In the Services Toolkit example in [Bind an application workload to the service instance](#), you can update the `spring-sensors-consumer-web` workload to use the `server` supply chain by changing the workload:

```
tanzu apps workload apply spring-sensors-consumer-web --type=server
```

This shows the change in the workload label and prompts you to accept the change. After the workload finishes the new deployment, there are a few differences:

- The workload no longer exposes a URL. It's available within the cluster as `spring-sensors-consumer-web` within the namespace, but you must use `kubectl port-forward service/spring-sensors-consumer-web 8080` to access the web service on port 8080.

You can set up a Kubernetes Ingress rule to direct traffic from outside the cluster to the workload. Use an Ingress rule to specify that specific host names or paths must be routed to the application. For more information about Ingress rules, see the [Kubernetes documentation](#)

- The workload no longer autoscales based on request traffic. For the `spring-sensors-consumer-web` workload, this means that it never spawns a second instance that consumes part of the request queue. Also, it does not scale down to zero instances.

`server`-specific workload parameters

In addition to the common supply chain parameters, `server` workloads can expose one or more network ports from the application to the Kubernetes cluster by using the `ports` parameter. This parameter is a list of port objects, similar to a Kubernetes service specification.

If you do not configure the `ports` parameter, the applied container conventions in the cluster establishes the set of exposed ports.

The following configuration exposes two ports on the Kubernetes cluster under the `my-app` host name:

```
apiVersion: carto.run/v1alpha1
kind: Workload
metadata:
  name: my-app
  labels:
    apps.tanzu.vmware.com/workload-type: server
spec:
  params:
  - name: ports
```

```

value:
- containerPort: 2025
  name: smtp
  port: 25
- port: 8080
...

```

This snippet configures:

- One service on port 25, which is redirected to port 2025 on the application
- One service on port 8080, which is routed to port 8080 on the application

You can set the `ports` parameter from the `tanzu apps workload create` command as `--param-yaml 'ports=[{"port": 8080}]'`.

The following values are valid within the `ports` argument:

Field	Value
<code>port</code>	The port on which the application is exposed to the rest of the cluster
<code>containerPort</code>	The port on which the application listens for requests. Defaults to <code>port</code> if not set.
<code>name</code>	A human-readable name for the port. Defaults to <code>port</code> if not set.

Expose `server` workloads outside the cluster

You have several options for exposing `server` workloads outside the cluster:

- [Expose server workloads outside the cluster automatically](#)
- [Expose HTTP server workloads outside the cluster manually](#)
- [Define a workload type that exposes server workloads outside the cluster](#)
- [Expose workloads outside the cluster using AVI L4/L7](#)

Use server workloads

This topic tells you how to use the `server` workload type in Tanzu Application Platform (commonly known as TAP).

Overview

The `server` workload type allows you to deploy traditional network applications on Tanzu Application Platform.

Using an application workload specification, you can build and deploy application source code to a manually-scaled Kubernetes deployment which exposes an in-cluster Service endpoint. If required, you can use environment-specific LoadBalancer Services or Ingress resources to expose these applications outside the cluster.

The `server` workload is suitable for traditional applications, including HTTP applications, which have the following characteristics:

- Store state locally
- Run background tasks outside of requests
- Provide multiple network ports or non-HTTP protocols
- Are not a good match for the `web` workload type

An application using the `server` workload type has the following features:

- Does not natively autoscale, but you can use these applications with the Kubernetes Horizontal Pod Autoscaler.
- By default, is exposed only within the cluster using a `ClusterIP` service.
- Uses health checks if defined by a convention.
- Uses a rolling update pattern by default.

When creating a workload with the `tanzu apps workload create` command, you can use the `--type=server` argument to select the `server` workload type. For more information, see [Use the server Workload Type](#) later in this topic. You can also use the `apps.tanzu.vmware.com/workload-type:server` annotation in the YAML workload description to support this deployment type.

Use the `server` workload type

The `spring-sensors-consumer-web` workload in [Bind an application workload to the service instance](#) in the Get started guide is a good match for the `server` workload type.

This is because it runs continuously to extract information from a RabbitMQ queue, and stores the resulting data locally in memory and presents it through a web UI.

In the Services Toolkit example in [Bind an application workload to the service instance](#), you can update the `spring-sensors-consumer-web` workload to use the `server` supply chain by changing the workload:

```
tanzu apps workload apply spring-sensors-consumer-web --type=server
```

This shows the change in the workload label and prompts you to accept the change. After the workload finishes the new deployment, there are a few differences:

- The workload no longer exposes a URL. It's available within the cluster as `spring-sensors-consumer-web` within the namespace, but you must use `kubectl port-forward service/spring-sensors-consumer-web 8080` to access the web service on port 8080.

You can set up a Kubernetes Ingress rule to direct traffic from outside the cluster to the workload. Use an Ingress rule to specify that specific host names or paths must be routed to the application. For more information about Ingress rules, see the [Kubernetes documentation](#)

- The workload no longer autoscales based on request traffic. For the `spring-sensors-consumer-web` workload, this means that it never spawns a second instance that consumes part of the request queue. Also, it does not scale down to zero instances.

`server`-specific workload parameters

In addition to the common supply chain parameters, `server` workloads can expose one or more network ports from the application to the Kubernetes cluster by using the `ports` parameter. This parameter is a list of port objects, similar to a Kubernetes service specification.

If you do not configure the `ports` parameter, the applied container conventions in the cluster establishes the set of exposed ports.

The following configuration exposes two ports on the Kubernetes cluster under the `my-app` host name:

```
apiVersion: carto.run/v1alpha1
kind: Workload
metadata:
  name: my-app
  labels:
```

```

  apps.tanzu.vmware.com/workload-type: server
spec:
  params:
  - name: ports
    value:
    - containerPort: 2025
      name: smtp
      port: 25
    - port: 8080
  ...

```

This snippet configures:

- One service on port 25, which is redirected to port 2025 on the application
- One service on port 8080, which is routed to port 8080 on the application

You can set the `ports` parameter from the `tanzu apps workload create` command as `--param-yaml 'ports=[{"port": 8080}]'`.

The following values are valid within the `ports` argument:

Field	Value
<code>port</code>	The port on which the application is exposed to the rest of the cluster
<code>containerPort</code>	The port on which the application listens for requests. Defaults to <code>port</code> if not set.
<code>name</code>	A human-readable name for the port. Defaults to <code>port</code> if not set.

Expose `server` workloads outside the cluster

You have several options for exposing `server` workloads outside the cluster:

- [Expose server workloads outside the cluster automatically](#)
- [Expose HTTP server workloads outside the cluster manually](#)
- [Define a workload type that exposes server workloads outside the cluster](#)
- [Expose workloads outside the cluster using AVI L4/L7](#)

Expose server workloads outside the cluster automatically

In Tanzu Application Platform (commonly known as TAP) v1.6 and later, Carvel Package Supply Chains produce server workloads that have Ingress by default. For more information, see [Overview of the Carvel Package Supply Chains](#).

Expose HTTP server workloads outside the cluster manually

You can expose HTTP `server` workloads outside the cluster by creating an Ingress resource and using cert-manager to provision TLS-signed certificates. To do so:

1. Using the `spring-sensors-consumer-web` workload from [Bind an application workload to the service instance](#) as an example, create the following `Ingress`:

```

apiVersion: networking.k8s.io/v1
kind: Ingress
metadata:
  name: spring-sensors-consumer-web
  namespace: DEVELOPER-NAMESPACE
  annotations:

```



```

cert-manager.io/cluster-issuer: tap-ingress-selfsigned
ingress.kubernetes.io/force-ssl-redirect: "true"
kubernetes.io/ingress.class: contour
kubernetes.io/tls-acme: "true"
spec:
  tls:
    - secretName: spring-sensors-consumer-web
      hosts:
        - "spring-sensors-consumer-web.INGRESS-DOMAIN"
  rules:
    - host: "spring-sensors-consumer-web.INGRESS-DOMAIN"
      http:
        paths:
          - pathType: Prefix
            path: /
            backend:
              service:
                name: spring-sensors-consumer-web
                port:
                  number: 8080

```

- o Replace `DEVELOPER-NAMESPACE` with your developer namespace.
- o Replace `INGRESS-DOMAIN` with the domain name defined in `tap-values.yaml` during the installation.
- o Set the annotation `cert-manager.io/cluster-issuer` to the `shared.ingress_issuer` value configured during installation or leave it as `tap-ingress-selfsigned` to use the default value.
- o Update the port exposed by your `Service` resource, which is set as `8080` in the example.

2. Access the `server` workload with HTTPS:

```
curl -k https://spring-sensors-consumer-web.INGRESS-DOMAIN
```

Define a workload type that exposes server workloads outside the cluster

Tanzu Application Platform (commonly known as TAP) allows you to create new workload types. You start by adding an `Ingress` resource to the `server-template ClusterConfigTemplate` when this new type of workload is created.

1. Delete the `Ingress` resource previously created.
2. Install the `yq` CLI on your local machine.
3. Save the existing `server-template` in a local file by running:

```
kubectl get ClusterConfigTemplate server-template -o yaml > secure-server-template.yaml
```

4. Extract the `.spec.ytt` field from this file and create another file by running:

```
yq eval '.spec.ytt' secure-server-template.yaml > spec-ytt.yaml
```

5. In the next step, you add the `Ingress` resource snippet to `spec-ytt.yaml`. This step provides a sample `Ingress` resource snippet. Make the following edits before adding the `Ingress` resource snippet to `spec-ytt.yaml`:
 - o Replace `INGRESS-DOMAIN` with the Ingress domain you set during the installation.

- o Set the annotation `cert-manager.io/cluster-issuer` to the `shared.ingress_issuer` value configured during installation or leave it as `tap-ingress-selfsigned` to use the default one.
- o This configuration is based on your workload service running on port `8080`.

The `Ingress` resource snippet looks like this:

```
---
apiVersion: networking.k8s.io/v1
kind: Ingress
metadata:
  name: #@ data.values.workload.metadata.name
  annotations:
    cert-manager.io/cluster-issuer: tap-ingress-selfsigned
    ingress.kubernetes.io/force-ssl-redirect: "true"
    kubernetes.io/ingress.class: contour
    kubernetes.io/tls-acme: "true"
    kapp.k14s.io/change-rule: "upsert after upserting Services"
  labels: #@ merge_labels({ "app.kubernetes.io/component": "run", "carto.run/workload-name": data.values.workload.metadata.name })
spec:
  tls:
    - secretName: #@ data.values.workload.metadata.name
      hosts:
        - #@ data.values.workload.metadata.name + ".INGRESS-DOMAIN"
  rules:
    - host: #@ data.values.workload.metadata.name + ".INGRESS-DOMAIN"
      http:
        paths:
          - pathType: Prefix
            path: /
            backend:
              service:
                name: #@ data.values.workload.metadata.name
                port:
                  number: 8080
```

6. Add the `Ingress` resource snippet to the `spec-ytt.yaml` file and save. Look for the `Service` resource, and insert the snippet before the last `#@ end`. For example:

```
# THE TOP OF THE FILE IS NOT SHOWN

---
apiVersion: v1
kind: Service
metadata:
  name: #@ data.values.workload.metadata.name
  labels: #@ merge_labels({ "app.kubernetes.io/component": "run", "carto.run/workload-name": data.values.workload.metadata.name })
spec:
  selector: #@ data.values.config.metadata.labels
  ports:
    #@ hasattr(data.values.params, "ports") and len(data.values.params.ports) or
    assert.fail("one or more ports param must be provided.")
    #@ declared_ports = {}
    #@ if "ports" in data.values.params:
    #@   declared_ports = data.values.params.ports
    #@ else:
    #@   declared_ports = struct.encode([{"containerPort": 8080, "port": 8080,
    "name": "http"}])
    #@ end
    #@ for p in merge_ports(declared_ports, data.values.config.spec.containers):
    - #@ p
```

```

#@ end

# NEW INGRESS RESOURCE
---
apiVersion: networking.k8s.io/v1
kind: Ingress
metadata:
  name: #@ data.values.workload.metadata.name
  annotations:
    cert-manager.io/cluster-issuer: tap-ingress-selfsigned
    ingress.kubernetes.io/force-ssl-redirect: "true"
    kubernetes.io/ingress.class: contour
    kubernetes.io/tls-acme: "true"
    kapp.k14s.io/change-rule: "upsert after upserting Services"
  labels: #@ merge_labels({ "app.kubernetes.io/component": "run", "carto.run/workload-name": data.values.workload.metadata.name })
spec:
  tls:
    - secretName: #@ data.values.workload.metadata.name
      hosts:
        - #@ data.values.workload.metadata.name + ".INGRESS-DOMAIN"
  rules:
    - host: #@ data.values.workload.metadata.name + ".INGRESS-DOMAIN"
      http:
        paths:
          - pathType: Prefix
            path: /
            backend:
              service:
                name: #@ data.values.workload.metadata.name
                port:
                  number: 8080
# END NEW INGRESS RESOURCE

#@ end

---
apiVersion: v1
kind: ConfigMap
metadata:
  name: #@ data.values.workload.metadata.name + "-server"
  labels: #@ merge_labels({ "app.kubernetes.io/component": "config" })
data:
  delivery.yml: #@ yaml.encode(delivery())

```

7. Add the snippet to the `.spec.ytt` property in `secure-server-template.yaml`:

```
SPEC_YTT=$(cat spec-ytt.yaml) yq eval -i '.spec.ytt |= strenv(SPEC_YTT)' secure-server-template.yaml
```

8. Change the name of the `ClusterConfigTemplate` to `secure-server-template` by running:

```
yq eval -i '.metadata.name = "secure-server-template"' secure-server-template.yaml
```

9. Create the new `ClusterConfigTemplate` by running:

```
kubectl apply -f secure-server-template.yaml
```

10. Verify the new `ClusterConfigTemplate` is in the cluster by running:

```
kubectl get ClusterConfigTemplate
```

Expected output:

```
kubectl get ClusterConfigTemplate
NAME                AGE
api-descriptors    82m
config-template    82m
convention-template 82m
secure-server-template 22s
server-template    82m
service-bindings   82m
worker-template    82m
```

11. Add the new workload type to the `tap-values.yaml`. The new workload type is named `secure-server` and the `cluster_config_template_name` is `secure-server-template`.

```
ootb_supply_chain_basic:
  supported_workloads:
    - type: web
      cluster_config_template_name: config-template
    - type: server
      cluster_config_template_name: server-template
    - type: worker
      cluster_config_template_name: worker-template
    - type: secure-server
      cluster_config_template_name: secure-server-template
```

12. Update your Tanzu Application Platform installation as follows:

```
tanzu package installed update tap -p tap.tanzu.vmware.com --values-file \
"/path/to/your/config/tap-values.yaml" -n tap-install
```

13. Give privileges to the `deliverable` role to manage `Ingress` resources:

```
cat <<EOF | kubectl apply -f -
apiVersion: rbac.authorization.k8s.io/v1
kind: ClusterRole
metadata:
  name: deliverable-with-ingress
  labels:
    apps.tanzu.vmware.com/aggregate-to-deliverable: "true"
rules:
- apiGroups:
  - networking.k8s.io
  resources:
  - ingresses
  verbs:
  - get
  - list
  - watch
  - create
  - patch
  - update
  - delete
  - deletecollection
EOF
```

14. Update the workload type to `secure-server`:



Note

If you created the `Ingress` resource manually in the previous section, delete it before this.

```
tanzu apps workload apply spring-sensors-consumer-web --type=secure-server
```

15. After the process finishes, verify that the resources Deployment, Service, and Ingress appear by running:

```
kubectl get ingress,svc,deploy -l carto.run/workload-name=spring-sensors-consumer-web
```

Expected output:

```
kubectl get ingress,svc,deploy -l carto.run/workload-name=tanzu-java-web-app-js
```

NAME	ADDRESS	PORTS	AGE	CLASS	HOSTS
ingress.networking.k8s.io/spring-sensors-consumer-web	-consumer-web.INGRESS-DOMAIN	34.111.111.111	80, 443	<none>	spring-sensors
			37s		

NAME	PORT(S)	AGE	TYPE	CLUSTER-IP	EXTERNAL-IP
service/spring-sensors-consumer-web	8080/TCP	36m	ClusterIP	10.32.15.194	<none>

NAME	AGE	READY	UP-TO-DATE	AVAILABLE
deployment.apps/spring-sensors-consumer-web	37s	1/1	1	1

16. Access your `secure-server` workload with HTTPS by running:

```
curl -k https://spring-sensors-consumer-web.INGRESS-DOMAIN
```

Expose workloads outside the cluster using AVI L4/L7

To expose workloads outside the cluster by using AVI L4/L7, see the [Tanzu Reference Architecture](#) documentation.

Use worker workloads

This topic tells you how to create and install a supply chain for the `worker` workload type in Tanzu Application Platform (commonly known as TAP).

Overview

The `worker` workload type allows you to deploy applications that run continuously without network input on Tanzu Application Platform. Using an application workload specification, you can build and deploy application source code to a manually scaled Kubernetes deployment with no network exposure.

The `worker` workload is a good match for applications that manage their own work by reading from a worker or a background scheduled time source, and don't expose any network interfaces.

An application using the `worker` workload type has the following features:

- Does not natively auto-scale but you can use it with the Kubernetes Horizontal Pod Autoscaler
- Does not expose any network services
- Uses health checks if defined by a convention

- Uses a rolling update pattern by default

When creating a workload with `tanzu apps workload create`, you can use the `--type=worker` argument to select the `worker` workload type. For more information, see the [Use the worker Workload Type](#) section. You can also use the `apps.tanzu.vmware.com/workload-type:worker` annotation in the YAML workload description to support this deployment type.

Use the `worker` workload type

The `spring-sensors-producer` workload in the example in [Consume services on Tanzu Application Platform](#) is a good match for the `worker` workload type. This is because it runs continuously without a UI to report sensor information to a RabbitMQ topic.

If you followed the Services Toolkit example, you can update the `spring-sensors-producer` to use the `worker` supply chain by changing the workload type. To do so, run:

```
tanzu apps workload apply spring-sensors-producer --type=worker
```

This shows a difference in the workload label, and prompts you to accept the change. After the workload finishes the new deployment, there are a few differences:

- The workload no longer has a URL. Because the workload does not present a web UI, this more closely matches the original application intent.
- The workload no longer auto-scales based on request traffic. For the `spring-sensors-producer` workload, this means that it does not scale down to zero instances when there is no request traffic.

Service-to-Service communication

This topic tells you about service-to-service communication for `web` and `server` workloads.

Calling `web` workloads within a cluster

When a `web` workload type is created, a Knative service is deployed to the cluster. To access your application, you need the URL for the route created by the Knative Service.

Obtain the URL by running one of these commands:

- To use the `tanzu apps` command, run:

```
tanzu apps workload get WORKLOAD-NAME --namespace DEVELOPER-NAMESPACE
```

- To use the `kubectl get` command, run:

```
kubectl get ksvc WORKLOAD-NAME -n YOUR-DEVELOPER-NAMESPACE -ojsonpath="{status.address.url}"
```



Note

When calling a Knative service, both the Service name and namespace are required. This behavior is distinct from `server` type workloads, which do not rely on the namespace name to establish service-to-service communication between applications within the same namespace.

Example of service-to-service communication for `web` and `server` workloads

You have three applications deployed to the namespace called `dev-namespace`:

- A `server` type workload named `server-workload`
- A `web` type workload named `web-workload`
- A pod running the `busybox` image with `curl` that is named `busybox`

Open a shell to the running container of the `busybox` pod and send requests to the `server` and `web` workloads using `curl`. Specify the namespace for both, as follows:

```
kubectl exec busybox -n dev-namespace -- curl server-workload.dev-namespace.svc.cluster.local -v
kubectl exec busybox -n dev-namespace -- curl web-workload.dev-namespace.svc.cluster.local -v
```

You can alternatively reference a web service as `workload-name.namespace` or `web-workload.dev-namespace` in this example. You can also reference a `server` workload that exists in the same namespace as `workload-name`, or `server-workload`.

Parameter reference

This topic tells you about the default supply chains and templates provided by Tanzu Application Platform (commonly known as TAP). This topic describes the `workload.spec.params` parameters that are configured in workload objects, and the `deliverable.spec.params` parameters that are configured in the deliverable object.

Workload Parameter Reference

The supply chains and templates provided by the Out of the Box packages contain a series of parameters that customize supply chain behavior. This section describes the `workload.spec.params` parameters that can be configured in workload objects.

The following table provides a list of supply chain resources organized by the resource in the supply chain where they are used. Some of these resources might not be applicable depending on the supply chain in use.

List of Supply Chain Resources for Workload Object

Supply Chain Resource	Output Type	Purpose	Basic	Testing	Scanning
source-provider	Source	Fetches source code	Yes	Yes	Yes
source-tester	Source	Tests source code	No	Yes	Yes
source-scanner	Source	Scans source code	No	No	Yes
image-provider	Image	Builds application container image	Yes	Yes	Yes
image-scanner	Image	Scans application container image	No	No	Yes
config-provider	Podtemplate spec	Tailors a pod spec based on the application image and conventions set up in the cluster	Yes	Yes	Yes
app-config	Kubernetes configuration	Creates Kubernetes config files (knative service/deployment - depending on workload type)	Yes	Yes	Yes

Supply Chain Resource	Output Type	Purpose	Basic	Testing	Scanning
service-bindings	Kubernetes configuration	Adds service bindings to the set of config files	Yes	Yes	Yes
api-descriptors	Kubernetes configuration	Adds api descriptors to the set of config files	Yes	Yes	Yes
config-writer	Kubernetes configuration	Writes configuration to a destination (git or registry) for further deployment to a run cluster	Yes	Yes	Yes
deliverable	Kubernetes configuration	Writes deliverable content to be extracted for use in a run cluster	Yes	Yes	Yes

For information about supply chains, see:

- [Out of the Box Supply Chain Basic](#)
- [Out of the Box Supply Chain Testing](#)
- [Out of the Box Supply Chain Testing Scanning](#)

source-provider

The `source-provider` resource in the supply chain creates objects that fetch either source code or pre-compiled Java applications depending on how the workload is configured. For more information, see [Building from Source](#).

GitRepository

Use `gitrepository` when fetching source code from Git repositories. This resource makes further resources available in the supply chain, such as the contents of the Git repository as a tarball available in the cluster.

Parameters:

Parameter name	Meaning	Example
<code>gitImplementation</code>	VMware recommends that you use the underlying library for fetching the source code.	<pre> - name: gitImplementation value: go-git </pre>
<code>gitops_ssh_secret</code>	The name of the secret in the same namespace as the 'Workload' used for providing credentials for fetching source code from the Git repository. For more information, see Git authentication .	<pre> - name: gitops_ssh_secret value: git-credentials </pre>

For information about the features supported by each implementation, see [Git implementation](#) in the Flux documentation.

For information about how to create a workload that uses a GitHub repository as the provider of source code, see [Create a workload from GitHub repository](#).

For more information about GitRepository objects, see [Git Repository](#) in the Flux documentation.

ImageRepository

Use the ImageRepository when fetching source code from container images. It makes the contents of the container image available as a tarball to further resources in the supply chain. The contents of the container image are fetched by using Git or Maven. For more information, see [Create a workload from local source code](#).

Parameters:

Parameter Name	Meaning	Example
<code>serviceAccount</code>	The name of the service account (in the same namespace as the workload) to use to provide the credentials to 'ImageRepository' for fetching the container images.	<pre>- name: serviceAccount value: default</pre>

The `--service-account` flag sets the `spec.serviceAccountName` key in the workload object. To configure the `serviceAccount` parameter, use `--param serviceAccount=SERVICE-ACCOUNT`.

For information about custom resource details, see the [ImageRepository](#) reference topic.

For information about how to use ImageRepository with the Tanzu CLI, see [Create a workload](#).

MavenArtifact

When carrying pre-built Java artifacts, `MavenArtifact` makes the artifact available to further resources in the supply chain as a tarball. You can wrap the tarball as a container image for further deployment. Differently from `git` and `image`, its configuration is solely driven by parameters in the workload.

Parameters:

Parameter Name	Meaning	Example
<code>maven</code>	Points to the maven artifact to fetch and the polling interval.	<pre>- name: maven value: artifactId: springboot-initial groupId: com.example version: RELEASE classifier: sources # optional type: # optional artifactRetryTimeout: 1m0s # optional</pre>

For information about the custom resource, see the [MavenArtifact reference documentation](#).

For information about how to use the custom resource with the `tanzu apps workload` CLI plug-in, see [Create a workload from Maven repository artifact](#).

source-tester

The `source-tester` resource is in `ootb-supply-chain-testing` and `ootb-supply-chain-testing-scanning`. This resource is responsible for instantiating a Tekton `PipelineRun` object that calls the

execution of a Tekton Pipeline, in the same namespace as the workload, whenever its inputs change. For example, the source code revision that you want to test changes.

A [Runnable](#) object is instantiated to ensure that there's always a run for a particular set of inputs. The parameters are passed from the workload down to Runnable's Pipeline selection mechanism through `testing_pipeline_matching_labels` and the execution of the PipelineRuns through `testing_pipeline_params`.

Parameters:

Parameter name	Meaning	Example
<code>testing_pipeline_matching_labels</code>	The set of labels to use when searching for Tekton Pipeline objects in the same namespace as the workload. By default, a Pipeline labeled as <code>apps.tanzu.vmware.com/pipeline: test</code> is selected, but when using this parameter, it's possible to override the behavior.	<pre> - name: testing_pipeline_matching_labels value: app: s.tanzu.com/pipeline: test my.company/language: golang </pre>
<code>testing_pipeline_params</code>	The set of extra parameters, aside from <code>source-url</code> and <code>source-revision</code> , to pass to the Tekton Pipeline. The Tekton Pipeline must declare both the required parameters <code>source-url</code> and <code>source-revision</code> and the extra ones declared in this table.	<pre> - name: testing_pipeline_params value: verbose: true </pre>

For information about how to set up the Workload namespace for testing with Tekton, see [Out of the Box Supply Chain with Testing](#).

For information about how to use the parameters to customize this resource to test using a Jenkins cluster, see [Out of the Box Supply Chain with Testing on Jenkins](#).

source-scanner

The `source-scanner` resource is available in `ootb-supply-chain-testing-scanning`. It scans the source code that is tested by pointing a `SourceScan` object at the same source code as the tests.

You can customize behavior for both [CVEs evaluation](#) with parameters.

Parameters:

Parameter name	Meaning	Example
<code>scanning_source_template</code>	The name of the ScanTemplate object (in the same namespace as the workload) to use for running the scans against the source code.	<pre> - name: scanning_source_template value: private-source-scan-template </pre>

Parameter name	Meaning	Example
<code>scanning_source_policy</code>	The name of the ScanPolicy object (in the same namespace as the workload) to use when evaluating the scan results of a source scan.	<pre> - name: scanning_source_policy value: allowlist-policy </pre>

For more information, see [Out of the Box Supply Chain with Testing and Scanning](#) for details about how to set up the workload namespace with the ScanPolicy and ScanTemplate required for this resource, and [SourceScan reference](#) for details about the SourceScan custom resource.

For information about how the artifacts found during scanning are catalogued, see [Supply Chain Security Tools for Tanzu – Store](#).

image-provider

The `image-provider` in the supply chains provides a container image carrying the application already built to further resources.

Different semantics apply, depending on how the workload is configured, for example, if using [pre-built images](#) or [building from source](#):

- pre-built: an `ImageRepository` object is created aiming at providing a reference to the latest image found matching the name as specified in `workload.spec.image`
- building from source: an image builder object is created (either Kpack's `Image` or a `Runnable` for creating Tekton TaskRuns for building images from Dockerfiles)

Kpack Image

Use the Kpack Image object to build a container image out of source code or pre-built Java artifact.

This makes the container image available to further resources in the supply chain through a content addressable image reference that's carried to the final deployment objects unchanged. For more information, see [Tanzu Build Service](#).

Parameters:

Parameter name	Meaning	Example
<code>serviceAccount</code>	The name of the serviceaccount (in the same namespace as the workload) to use for providing credentials to 'Image' for pushing the container images it builds to the configured registry.	<pre> - name: serviceAccount value: default </pre>
<code>clusterBuilder</code>	The name of the Kpack cluster builder to use in the Kpack Image object created.	<pre> - name: clusterBuilder value: nodejs-cluster-builder </pre>

Parameter name	Meaning	Example
<code>buildService Bindings</code>	The definition of a list of service bindings to use at build time. For example, providing credentials for fetching dependencies from repositories that require credentials.	<pre> - name: buildServiceBindings value: - name: settings-xml kind: Secret apiVersion: v1 </pre>
<code>live-update</code>	Enables the use of Tilt's live-update function.	<pre> - name: live-update value: "true" </pre>

The `--service-account` flag sets the `spec.serviceAccountName` key in the workload object. To configure the `serviceAccount` parameter, use `--param serviceAccount=SERVICE-ACCOUNT`.

For information about the integration with Tanzu Build Service, see [Tanzu Build Service Integration](#).

For information about `live-update`, see [Developer Conventions](#) and [Overview of Tanzu Developer Tools for IntelliJ](#).

For information about using Kpack builders with `clusterBuilder`, see [Builders](#).

For information about `buildServiceBindings`, see [Service Bindings](#).

Runnable (TaskRuns for Dockerfile-based builds)

To perform Dockerfile-based builds, all the supply chains instantiate a Runnable object that instantiates Tekton TaskRun objects to call the execution of [kaniko](#) builds.

Parameters:

Parameter name	Meaning	Example
<code>dockerfile</code>	The relative path to the Dockerfile file in the build context.	<code>./Dockerfile</code>
<code>docker_build_context</code>	The relative path to the directory where the build context is.	<code>.</code>
<code>docker_build_extra_args</code>	List of flags to pass directly to Kaniko, such as providing arguments to a build.	<code>--build-arg=FOO=BAR</code>

For information about how to use Dockerfile-based builds and limitations associated with the function, see [Dockerfile-based builds](#).

Pre-built image (ImageRepository)

For applications that already have their container images built outside the supply chains, such as providing an image reference under `workload.spec.image`, an `ImageRepository` object is created to keep track of any images pushed under that name.

This makes the content-addressable name, such as the image name containing the digest, available for further resources in the supply chain.

Parameters:

Parameter name	Meaning	Example
<code>serviceAccount</code>	The name of the serviceaccount (in the same namespace as the workload) to use for providing the credentials to `ImageRepository` for fetching the container images.	<pre>- name: serviceAccount value: default</pre>

The `--service-account` flag sets the `spec.serviceAccountName` key in the workload object. To configure the `serviceAccount` parameter, use `--param serviceAccount=...`

For information about the ImageRepository resource, see the [ImageRepository reference documentation](#). For information about the prebuild image function, see [Using a prebuilt image](#).

image-scanner

The `image-scanner` resource is included only in `ootb-supply-chain-testing-scanning`.

This resource scans a container image (either built by using the supply chain or prebuilt), persisting the results in the store, and gating the image from moving forward in case the CVEs found are not compliant with the ScanPolicy referenced by the ImageScan object create for doing so.

Parameters:

Parameter name	Meaning	Example
<code>scanning_image_template</code>	The name of the ScanTemplate object (in the same namespace as the workload) to use for running the scans against a container image.	<pre>- name: scanning_image_template value: private-image-scan-template</pre>
<code>scanning_image_policy</code>	The name of the ScanPolicy object (in the same namespace as the workload) to use when evaluating the scan results of an image scan.	<pre>- name: scanning_image_policy value: allow-list-policy</pre>

For information about the ImageScan custom resource, see [ImageScan reference](#).

For information about how the artifacts found during scanning are catalogued, see [Supply Chain Security Tools for Tanzu – Store](#).

config-provider

The `config-provider` resource in the supply chains generates a PodTemplateSpec to use in application configs, such as Knative services and deployments, to represent the desired pod configuration to instantiate to run the application in containers. For more information, see [PodTemplateSpec](#) in the Kubernetes documentation.

The `config-provider` resource manages a [PodIntent](#) object that represents the intention of having PodTemplateSpec enhanced with conventions installed in the cluster whose final representation is

then passed forward to other resources to form the final deployment configuration.

Parameters:

Parameter name	Meaning	Example
<code>serviceAccount</code>	The name of the serviceaccount (in the same namespace as the workload) to use for providing the necessary credentials to `PodIntent` for fetching the container image to inspect the metadata to pass to convention servers and the <code>serviceAccountName</code> set in the <code>podtemplatespec</code> .	<pre>- name: serviceAccount value: default</pre>
<code>annotations</code>	An extra set of annotations to pass down to the <code>PodTemplateSpec</code> .	<pre>- name: annotations value: name: my-application version: v1.2.3 team: store</pre>
<code>debug</code>	Put the workload in debug mode.	<pre>- name: debug value: "true"</pre>
<code>live-update</code>	Enable live-updating of the code (for innerloop development).	<pre>- name: live-update value: "true"</pre>

The `--service-account` flag sets the `spec.serviceAccountName` key in the workload object. To configure the `serviceAccount` parameter, use `--param serviceAccount=SERVICE-ACCOUNT`.

For more information about the controller behind `PodIntent`, see [Cartographer Conventions](#).

For more details about the two convention servers enabled by default in Tanzu Application Platform installations, see [Developer Conventions](#) and [Spring Boot conventions](#).

app-config

The `app-config` resource prepares a `ConfigMap` with the Kubernetes configuration that is used for instantiating an application in the form of a particular workload type in a cluster.

The resource is configured in the supply chain to allow, by default, three types of workloads with the selection of which workload type to apply based on the labels set in the workload object created by the developer:

- `apps.tanzu.vmware.com/workload-type: web`

- `apps.tanzu.vmware.com/workload-type: worker`
- `apps.tanzu.vmware.com/workload-type: server`

Only the `server` workload type has the following configurable parameters:

Parameter name	Meaning	example
<code>ports</code>	The set of network ports to expose from the application to the Kubernetes cluster.	<pre> - name: ports value: - containerPort: 2025 name: smtp port: 25 </pre>

For more information about the three different types of workloads, see [workload types](#). For a more detailed overview of the ports parameter, see [server-specific Workload parameters](#).

service-bindings

The `service-bindings` resource adds [ServiceBindings](#) to the set of Kubernetes configuration files to promote for deployment.

Parameters:

Parameter name	Meaning	Example
<code>annotations</code>	The extra set of annotations to pass down to the ServiceBinding and ResourceClaim objects.	<pre> - name: annotations value: name: my-application version: v1.2.3 team: store </pre>

For an example, see `--service-ref` in Tanzu CLI documentation.

For an overview of the function, see [Consume services on Tanzu Application Platform](#).

api-descriptors

The `api-descriptor` resource adds an [APIDescriptor](#) to the set of Kubernetes objects to deploy. This enables API auto registration.

Parameters:

Parameter name	Meaning	Example
<code>annotations</code>	An extra set of annotations to pass down to the APIDescriptor object.	<pre> - name: annotations value: name: my-application version: v1.2.3 team: store </pre>

Parameter name	Meaning	Example
<code>api_descriptor</code>	Information used to fill the state that you want of the APIDescriptor object (its spec).	<pre> - name: api_descriptor value: type: openapi location: baseURL: http://petclinic- hard-coded.my-apps.tapdemo.vmware.com/ path: "/v3/api" owner: team-petclinic system: pet-clinics description: "example" </pre>

The workload must include the `apis.apps.tanzu.vmware.com/register-api: "true"` label to activate this function.

For more details about API auto registration, see [Use API Auto Registration](#).

config-writer (git or registry)

The `config-writer` resource is responsible for performing the last mile of the supply chain: persisting in an external system (registry or Git repository) the Kubernetes configuration generated throughout the supply chain.

There are three methods:

- Publishing the configuration to a container image registry
- Publishing the configuration to a Git repository by using the push of a commit
- Publishing the configuration to a Git repository by pushing a commit and opening a pull request

For more information about the different modes of operation, see [Gitops vs RegistryOps](#).

deliverable

The `deliverable` resource creates a `deliverable` object that represents the intention of delivering to the cluster the configurations that are produced by the supply chain.

Parameters:

Parameter name	Meaning	Example
<code>serviceAccount</code>	The name of the serviceaccount (in the same namespace as the deliverable) to use for providing the necessary permissions to create the children objects for deploying the objects created by the supply chain to the cluster.	<pre> - name: serviceAccount value: default </pre>

The `--service-account` flag sets the `spec.serviceAccountName` key in the workload object. To configure the `serviceAccount` parameter, use `--param serviceAccount=SERVICE-ACCOUNT`.

On build clusters where a corresponding `ClusterDelivery` doesn't exist, the deliverable takes no effect (similarly to a workload without a SupplyChain, no action is taken).

Deliverable Parameters Reference

The deliverable object applies the configuration produced by the resources defined by a ClusterSupplyChain to a Kubernetes cluster.

This section describes the `deliverable.spec.params` parameters that can be configured in the deliverable object. The following section describes the two resources defined in the ClusterDelivery resources section. These are part of the `ootb-delivery-basic` package:

List of Cluster Delivery Resources for Deliverable Object

Cluster Delivery Resource	Output Type	Purpose
source provider	Source	Fetches the Kubernetes configuration file from Git repository or image registry
app deployer	Source	Applies configuration produced by a supply chain to the cluster

For information about the ClusterDelivery shipped with `ootb-delivery-basic`, and the templates used by it, see:

- [Out of the Box Delivery Basic](#)
- [Out of the Templates](#)

For information about the use of the deliverable object in a multicluster environment, see [Getting started with multicluster Tanzu Application Platform](#).

For reference information about deliverable, see [Deliverable and Delivery custom resources](#) in the Cartographer documentation.

source-provider

The `source-provider` resource in the basic ClusterDelivery creates objects that continuously fetch Kubernetes configuration files from a Git repository or container image registry so that it can apply those to the cluster.

Regardless of where it fetches that Kubernetes configuration from (Git repository or image registry), it exposes those files to further resources along the ClusterDelivery as a tarball.

GitRepository

A GitRepository object is instantiated when `deliverable.spec.source.git` is configured to continuously look for a Kubernetes configuration pushed to a Git repository, making it available for resources in the ClusterDelivery.

Parameters:

Parameter name	Meaning	Example
<code>gitImplementation</code>	VMware recommends that you use the underlying library for fetching the source code. <code>go-git</code> .	<pre>- name: gitImplementation value: e: go-git</pre>

Parameter name	Meaning	Example
<code>gitops_ssh_secret</code>	The name of the secret in the same namespace as the `deliverable` used for providing credentials for fetching Kubernetes configuration files from the Git repository pointed at. See [Git authentication](../scc/git-auth.md).	<pre> - name: gitops_ssh_secret value: e: git-credentials </pre>

For information about the features supported by each implementation, see [git implementation](#) in the Flux documentation.

For information about how to create a workload that uses a GitHub repository as the provider of source code, see [Create a workload from GitHub repository](#).

For information about GitRepository objects, see [GitRepository](#).

ImageRepository

An ImageRepository object is instantiated when `deliverable.spec.source.image` is configured to continuously look for Kubernetes configuration files pushed to a container image registry as opposed to a Git repository.

Parameters:

Parameter name	Meaning	Example
<code>serviceAccount</code>	The name of the service account, in the same namespace as the deliverable, you want to use to provide the necessary permissions for `kapp-controller` to deploy the objects to the cluster.	<pre> - name: serviceAccount value: e: default </pre>

The `--service-account` flag sets the `spec.serviceAccountName` key in the deliverable object. To configure the `serviceAccount` parameter, use `--param serviceAccount=SERVICE-ACCOUNT`.

For information about custom resource details, see the [ImageRepository reference documentation](#).

app deployer

The `app-deploy` resource in the ClusterDelivery applies the Kubernetes configuration that is built by the supply chain, pushed to either a Git repository or image repository, and applied to the cluster.

App

Regardless of where the configuration comes from, an `App` object is instantiated to deploy the set of Kubernetes configuration files to the cluster.

Parameters:

Parameter name	Meaning	Example
<code>serviceAccount</code>	The name of the service account, in the same namespace as the deliverable, you want to use to provide the necessary privileges for `App` to apply the Kubernetes objects to the cluster.	<pre> - name: serviceAccount value: e: default </pre>
<code>gitops_sub_path</code> (deprecated)	The subdirectory within the configuration bundle used for looking up the files to apply to the Kubernetes cluster.	<pre> - name: gitops_sub_path value: e: ./config </pre>

The `gitops_sub_path` parameter is deprecated. Use `deliverable.spec.source.subPath` instead.

The `--service-account` flag sets the `spec.serviceAccountName` key in the deliverable object.

To configure the `serviceAccount` parameter, use `--param serviceAccount=SERVICE-ACCOUNT`.

For details about RBAC and how `kapp-controller` uses the ServiceAccount provided to it using the `serviceAccount` parameter in the `deliverable` object, see [kapp-controller's Security Model](#) in the Carvel documentation.

Use functions (Beta)

This topic tells you how to create and deploy a HTTP or CloudEvent function from an Application Accelerator starter template in an online or air-gapped environment on Tanzu Application Platform (commonly known as TAP).



Important

Function Buildpacks for Knative and the corresponding Application Accelerator starter templates for Python and Java are deprecated and will be removed in Tanzu Application Platform v1.7. This beta product will not receive any future updates or patches.

Overview

The function experience on Tanzu Application Platform enables you to deploy functions, use starter templates to bootstrap your function, and write only the code that matters to your business. You can run a single CLI command to deploy your functions to an auto-scaled cluster.

Functions provide a quick way to get started writing an application. Compared with a traditional application:

- Functions have a single entry-point and perform a single task. This means that functions can be easier to understand and monitor.
- The function buildpack manages the webserver. This means that you can focus on your business logic.
- A traditional webserver application might be a better fit if you want to implement an entire website or API in a single container

**Important**

Beta features have been tested for functionality, but not performance. Features enter the beta stage so that customers can gain early access, and give feedback on the design and behavior.

Beta features might undergo changes based on this feedback before the end of the beta stage. VMware discourages running beta features in production. VMware cannot guarantee that you can upgrade any beta feature in the future.

Supported languages and frameworks

For HTTP and CloudEvents:

Language/framework	HTTP	CloudEvents
Java	✓	✓
Python	✓	✓
NodeJS	✓	N/A

For REST API:

Language/framework	GET	POST
Java	N/A	✓
Python	✓	✓
NodeJS	✓	✓

Prerequisites

Before using function workloads, follow all instructions to install Tanzu Application Platform for your environment:

- [Installing Tanzu Application Platform online](#)
- [Installing Tanzu Application Platform in an air-gapped environment](#)

Create a function project from an accelerator

To create a function project from an accelerator:

1. From the Tanzu Developer Portal (formerly named Tanzu Application Platform GUI) portal, click **Create** on the left navigation bar to see the list of available accelerators.

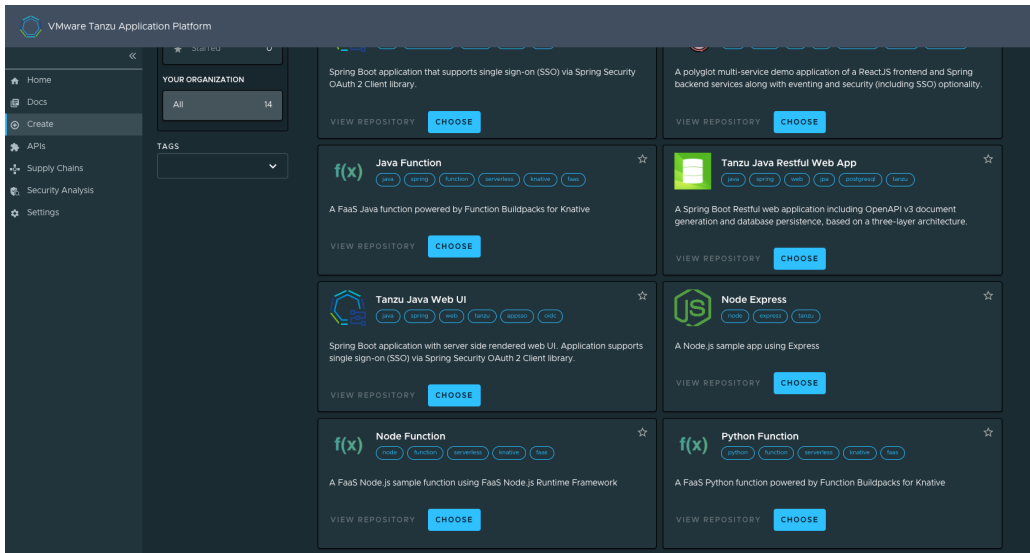

2. Locate the function accelerator in the language or framework of your choice and click **CHOOSE**.
3. Provide a name for your function project and your function.
4. If you are creating a Java function, select a project type.
5. Provide a Git repository to store the files for the accelerator.
6. Click **NEXT STEP**, verify the provided information, and then click **CREATE**.

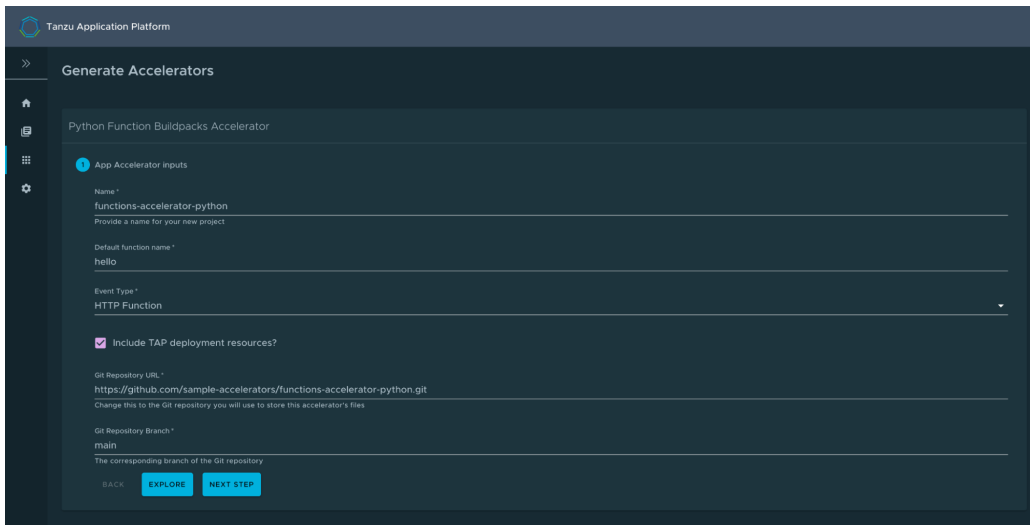

7. After the Task Activity processes complete, click **DOWNLOAD ZIP FILE**.
8. After downloading the ZIP file, expand it in a workspace directory and follow your preferred procedure for uploading the generated project files to a Git repository for your new project.

Create a function project using the Tanzu CLI

From the CLI, to generate a function project using an accelerator template and then download the project artifacts as a ZIP file:

1. Verify that you have added the function accelerator template to the application accelerator server by running:

```
tanzu accelerator list
```

2. Get the `server-url` for the Application Accelerator server. The URL depends on the configuration settings for Application Accelerator:

- o For installations configured with a shared ingress, use `https://accelerator.DOMAIN` where `DOMAIN` is provided in the values file for the accelerator configuration.
- o For installations using a LoadBalancer, look up the External IP address by running:

```
kubectl get -n accelerator-system service/acc-server
```

Use `http://EXTERNAL-IP` as the URL.

- o For any other configuration, you can use port forwarding by running:

```
kubectl port-forward service/acc-server -n accelerator-system 8877:80
```

Use `http://localhost:8877` as the URL.

3. Generate a function project from an accelerator template by running:

```
tanzu accelerator generate ACCELERATOR-NAME \
--options '{"projectName": "FUNCTION-NAME", "interfaceType": "TYPE"}' \
--server-url APPLICATION-ACCELERATOR-URL
```

Where:

- o `ACCELERATOR-NAME` is the name of the function accelerator template you want to use.
- o `FUNCTION-NAME` is the name of your function project.
- o `TYPE` is the interface you want to use for your function. Available options are `http` or `cloudevents`. CloudEvents is experimental.
- o `APPLICATION-ACCELERATOR-URL` is the URL for the Application Accelerator server that you retrieved in the previous step.

For example:

```
tanzu accelerator generate java-function \
--options '{"projectName": "my-func", "interfaceType": "http"}' \
--server-url http://localhost:8877
```

4. After generating the ZIP file, expand it in your directory and follow your preferred procedure for uploading the generated project files to a Git repository for your new project.

Deploy your function

To deploy and verify your function:

1. Deploy the function accelerator by running the `tanzu apps workload create` command:

```
tanzu apps workload create functions-accelerator-python \
--local-path . \
--source-image SOURCE-IMAGE \
--type web \
--yes
--namespace YOUR-DEVELOPER-NAMESPACE
--build-env 'BP_FUNCTION=func.hello'
```

Where:

- o `SOURCE-IMAGE` is a writable repository in your registry in the form `REGISTRY/IMAGE:TAG`.

- Harbor has the form: “my-harbor.io/my-project/functions-accelerator-python”.
 - Docker Hub has the form: “my-dockerhub-user/functions-accelerator-python”.
 - Google Cloud Registry has the form: “gcr.io/my-project/functions-accelerator-python”.
- `YOUR-DEVELOPER-NAMESPACE` is the namespace you configured earlier.
2. View the build and runtime logs for your application by running the `tail` command:

```
tanzu apps workload tail functions-accelerator-python --since 10m --timestamp -
-namespace YOUR-DEVELOPER-NAMESPACE
```

Where `YOUR-DEVELOPER-NAMESPACE` is the namespace configured earlier.

3. After the workload is built and running, you can view the web application in your browser. To view the URL of the web application, run the following command and then **ctrl-click** the Workload Knative Services URL at the bottom of the command output.

```
tanzu apps workload get functions-accelerator-python --namespace YOUR-DEVELOPER
-NAMESPACE
```

Where `YOUR-DEVELOPER-NAMESPACE` is the namespace configured earlier.

4. (Optional) You can test your function using a curl command. To do so, you must have curl installed on your computer. Java function POST example:

```
curl -w'\n' URL-FROM-YOUR-WORKLOAD-KNATIVE-SERVICES-SECTION \
-H "Content-Type: application/json" \
-d '{"firstName":"John", "lastName":"Doe"}'
```

For language support for the REST API, see [Supported languages and frameworks](#) earlier in this topic.

Use functions (Beta)

This topic tells you how to create and deploy a HTTP or CloudEvent function from an Application Accelerator starter template in an online or air-gapped environment on Tanzu Application Platform (commonly known as TAP).



Important

Function Buildpacks for Knative and the corresponding Application Accelerator starter templates for Python and Java are deprecated and will be removed in Tanzu Application Platform v1.7. This beta product will not receive any future updates or patches.

Overview

The function experience on Tanzu Application Platform enables you to deploy functions, use starter templates to bootstrap your function, and write only the code that matters to your business. You can run a single CLI command to deploy your functions to an auto-scaled cluster.

Functions provide a quick way to get started writing an application. Compared with a traditional application:

- Functions have a single entry-point and perform a single task. This means that functions can be easier to understand and monitor.
- The function buildpack manages the webserver. This means that you can focus on your business logic.
- A traditional webserver application might be a better fit if you want to implement an entire website or API in a single container



Important

Beta features have been tested for functionality, but not performance. Features enter the beta stage so that customers can gain early access, and give feedback on the design and behavior.

Beta features might undergo changes based on this feedback before the end of the beta stage. VMware discourages running beta features in production. VMware cannot guarantee that you can upgrade any beta feature in the future.

Supported languages and frameworks

For HTTP and CloudEvents:

Language/framework	HTTP	CloudEvents
Java	✓	✓
Python	✓	✓
NodeJS	✓	N/A

For REST API:

Language/framework	GET	POST
Java	N/A	✓
Python	✓	✓
NodeJS	✓	✓

Prerequisites

Before using function workloads, follow all instructions to install Tanzu Application Platform for your environment:

- [Installing Tanzu Application Platform online](#)
- [Installing Tanzu Application Platform in an air-gapped environment](#)

Create a function project from an accelerator

To create a function project from an accelerator:

1. From the Tanzu Developer Portal (formerly named Tanzu Application Platform GUI) portal, click **Create** on the left navigation bar to see the list of available accelerators.

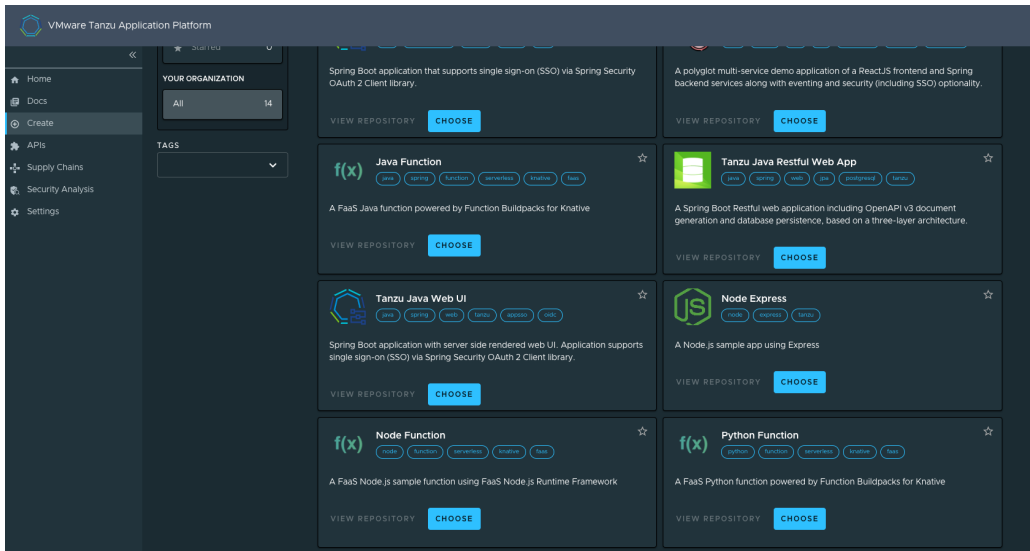

2. Locate the function accelerator in the language or framework of your choice and click **CHOOSE**.
3. Provide a name for your function project and your function.
4. If you are creating a Java function, select a project type.
5. Provide a Git repository to store the files for the accelerator.
6. Click **NEXT STEP**, verify the provided information, and then click **CREATE**.

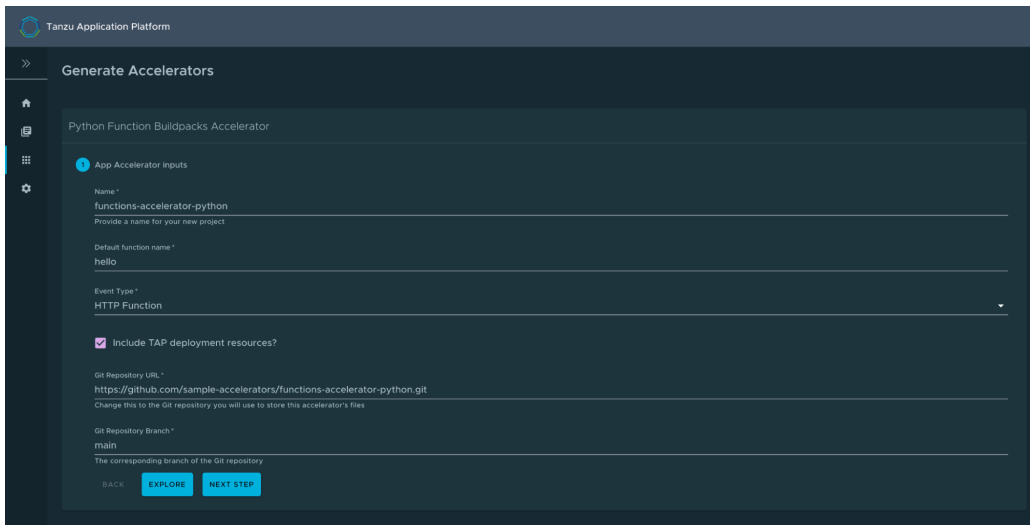

7. After the Task Activity processes complete, click **DOWNLOAD ZIP FILE**.
8. After downloading the ZIP file, expand it in a workspace directory and follow your preferred procedure for uploading the generated project files to a Git repository for your new project.

Create a function project using the Tanzu CLI

From the CLI, to generate a function project using an accelerator template and then download the project artifacts as a ZIP file:

1. Verify that you have added the function accelerator template to the application accelerator server by running:

```
tanzu accelerator list
```

2. Get the `server-url` for the Application Accelerator server. The URL depends on the configuration settings for Application Accelerator:

- o For installations configured with a shared ingress, use `https://accelerator.DOMAIN` where `DOMAIN` is provided in the values file for the accelerator configuration.
- o For installations using a LoadBalancer, look up the External IP address by running:

```
kubectl get -n accelerator-system service/acc-server
```

Use `http://EXTERNAL-IP` as the URL.

- o For any other configuration, you can use port forwarding by running:

```
kubectl port-forward service/acc-server -n accelerator-system 8877:80
```

Use `http://localhost:8877` as the URL.

3. Generate a function project from an accelerator template by running:

```
tanzu accelerator generate ACCELERATOR-NAME \
--options '{"projectName": "FUNCTION-NAME", "interfaceType": "TYPE"}' \
--server-url APPLICATION-ACCELERATOR-URL
```

Where:

- o `ACCELERATOR-NAME` is the name of the function accelerator template you want to use.
- o `FUNCTION-NAME` is the name of your function project.
- o `TYPE` is the interface you want to use for your function. Available options are `http` or `cloudevents`. CloudEvents is experimental.
- o `APPLICATION-ACCELERATOR-URL` is the URL for the Application Accelerator server that you retrieved in the previous step.

For example:

```
tanzu accelerator generate java-function \
--options '{"projectName": "my-func", "interfaceType": "http"}' \
--server-url http://localhost:8877
```

4. After generating the ZIP file, expand it in your directory and follow your preferred procedure for uploading the generated project files to a Git repository for your new project.

Deploy your function

To deploy and verify your function:

1. Deploy the function accelerator by running the `tanzu apps workload create` command:

```
tanzu apps workload create functions-accelerator-python \
--local-path . \
--source-image SOURCE-IMAGE \
--type web \
--yes
--namespace YOUR-DEVELOPER-NAMESPACE
--build-env 'BP_FUNCTION=func.hello'
```

Where:

- o `SOURCE-IMAGE` is a writable repository in your registry in the form `REGISTRY/IMAGE:TAG`.

- Harbor has the form: “my-harbor.io/my-project/functions-accelerator-python”.
 - Docker Hub has the form: “my-dockerhub-user/functions-accelerator-python”.
 - Google Cloud Registry has the form: “gcr.io/my-project/functions-accelerator-python”.
- `YOUR-DEVELOPER-NAMESPACE` is the namespace you configured earlier.
2. View the build and runtime logs for your application by running the `tail` command:

```
tanzu apps workload tail functions-accelerator-python --since 10m --timestamp -
-namespace YOUR-DEVELOPER-NAMESPACE
```

Where `YOUR-DEVELOPER-NAMESPACE` is the namespace configured earlier.

3. After the workload is built and running, you can view the web application in your browser. To view the URL of the web application, run the following command and then **ctrl-click** the Workload Knative Services URL at the bottom of the command output.

```
tanzu apps workload get functions-accelerator-python --namespace YOUR-DEVELOPER
-NAMESPACE
```

Where `YOUR-DEVELOPER-NAMESPACE` is the namespace configured earlier.

4. (Optional) You can test your function using a curl command. To do so, you must have curl installed on your computer. Java function POST example:

```
curl -w'\n' URL-FROM-YOUR-WORKLOAD-KNATIVE-SERVICES-SECTION \
-H "Content-Type: application/json" \
-d '{"firstName":"John", "lastName":"Doe"}'
```

For language support for the REST API, see [Supported languages and frameworks](#) earlier in this topic.

Troubleshoot Tanzu Application Platform

These topics provide you with troubleshooting information to help resolve issues with your Tanzu Application Platform (commonly known as TAP):

- [Troubleshoot installing Tanzu Application Platform](#)
- [Troubleshoot using Tanzu Application Platform](#)
- [Troubleshoot Tanzu Application Platform components](#)
- [Troubleshoot Tanzu GitOps Reference Implementation \(RI\)](#)

Troubleshoot Tanzu Application Platform

These topics provide you with troubleshooting information to help resolve issues with your Tanzu Application Platform (commonly known as TAP):

- [Troubleshoot installing Tanzu Application Platform](#)
- [Troubleshoot using Tanzu Application Platform](#)
- [Troubleshoot Tanzu Application Platform components](#)
- [Troubleshoot Tanzu GitOps Reference Implementation \(RI\)](#)

Troubleshoot installing Tanzu Application Platform

This topic tells you how to troubleshoot installing Tanzu Application Platform (commonly known as TAP).

Developer cannot be verified when installing Tanzu CLI on macOS

You see the following error when you run Tanzu CLI commands, for example `tanzu version`, on macOS:

```
"tanzu" cannot be opened because the developer cannot be verified
```

Explanation

Security settings are preventing installation.

Solution

To resolve this issue:

1. Click **Cancel** in the macOS prompt window.
2. Open **System Preferences > Security & Privacy**.
3. Click **General**.
4. Next to the warning message for the Tanzu binary, click **Allow Anyway**.

5. Enter your system username and password in the macOS prompt window to confirm the changes.
6. In the terminal window, run:

```
tanzu version
```

7. In the macOS prompt window, click **Open**.

Access `.status.usefulErrorMessage` details

When installing Tanzu Application Platform, you receive an error message that includes the following:

```
(message: Error (see .status.usefulErrorMessage for details))
```

Explanation

A package fails to reconcile and you must access the details in `.status.usefulErrorMessage`.

Solution

Access the details in `.status.usefulErrorMessage` by running:

```
kubectl get packageinstall PACKAGE-NAME -n tap-install -o yaml
```

Where `PACKAGE-NAME` is the name of the package to target.

“Unauthorized to access” error

When running the `tanzu package install` command, you receive an error message that includes the error:

```
UNAUTHORIZED: unauthorized to access repository
```

For example:

```
$ tanzu package install app-live-view -p appliveview.tanzu.vmware.com -v 0.1.0 -n tap-install --values-file ./app-live-view.yaml
```

```
Error: package reconciliation failed: vendir: Error: Syncing directory '0':
  Syncing directory '.' with imgpkgBundle contents:
    Imgpkg: exit status 1 (stderr: Error: Checking if image is bundle: Collecting images: Working with registry.example.com/app-live-view/application-live-view-install-bundle@sha256:b13b9ba81bcc985d76607cfc04bcbb8829b4cc2820e64a99e0af840681da12aa: GET https://registry.example.com/v2/app-live-view/application-live-view-install-bundle/manifests/sha256:b13b9ba81bcc985d76607cfc04bcbb8829b4cc2820e64a99e0af840681da12aa: UNAUTHORIZED: unauthorized to access repository: app-live-view/application-live-view-install-bundle, action: pull: unauthorized to access repository: app-live-view/application-live-view-install-bundle, action: pull
```



Note

This example shows an error received when with Application Live View as the package. This error can also occur with other packages.

Explanation

The credentials needed to access the package may be missing or incorrect.

Solution

To resolve this issue:

1. Repeat the step to create a secret for the namespace. For instructions, see [Add the Tanzu Application Platform Package Repository](#) in *Installing the Tanzu Application Platform Package and Profiles*. Ensure that you provide the correct credentials.

When the secret has the correct credentials, the authentication error should resolve itself and the reconciliation succeed. Do not reinstall the package.

2. List the status of the installed packages to confirm that the reconcile has succeeded. For instructions, see [Verify the Installed Packages](#) in *Installing Individual Packages*.

“Serviceaccounts already exists” error

When running the `tanzu package install` command, you receive the following error:

```
failed to create ServiceAccount resource: serviceaccounts already exists
```

For example:

```
$ tanzu package install app-accelerator -p accelerator.apps.tanzu.vmware.com -v 0.2.0
-n tap-install --values-file app-accelerator-values.yaml

Error: failed to create ServiceAccount resource: serviceaccounts "app-accelerator-tap-
install-sa" already exists
```



Note

This example shows an error received with App Accelerator as the package. This error can also occur with other packages.

Explanation

The `tanzu package install` command may be executed again after failing.

Solution

To update the package, run the following command after the first use of the `tanzu package install` command

```
tanzu package installed update
```

After package installation, one or more packages fails to reconcile

You run the `tanzu package install` command and one or more packages fails to install.

For example:

```
tanzu package install tap -p tap.tanzu.vmware.com -v 0.4.0 -n tap-install --values-fil
e tap-values.yaml
- Installing package 'tap.tanzu.vmware.com'
\ Getting package metadata for 'tap.tanzu.vmware.com'
| Creating service account 'tap-tap-install-sa'
/ Creating cluster admin role 'tap-tap-install-cluster-role'
| Creating cluster role binding 'tap-tap-install-cluster-rolebinding'
| Creating secret 'tap-tap-install-values'
```

```

| Creating package resource
- Waiting for 'PackageInstall' reconciliation for 'tap'
/ 'PackageInstall' resource install status: Reconciling
| 'PackageInstall' resource install status: ReconcileFailed

Please consider using 'tanzu package installed update' to update the installed package
with correct settings

Error: resource reconciliation failed: kapp: Error: waiting on reconcile packageinstal
l/tap-gui (packaging.carvel.dev/v1alpha1) namespace: tap-install:
  Finished unsuccessfully (Reconcile failed: (message: Error (see .status.usefulError
Message for details))). Reconcile failed: Error (see .status.usefulErrorMessage for de
tails)
Error: exit status 1

```

Explanation

Often, the cause is one of the following:

- Your infrastructure provider takes longer to perform tasks than the timeout value allows.
- A race-condition between components exists. For example, a package that uses [Ingress](#) completes before the shared Tanzu ingress controller becomes available.

The VMware Carvel tools kapp-controller continues to try in a reconciliation loop in these cases. However, if the reconciliation status is [failed](#) then there might be a configuration issue in the provided [tap-config.yaml](#) file.

Solution

1. Verify if the installation is still in progress by running:

```
tanzu package installed list -A
```

If the installation is still in progress, the command produces output similar to the following example, and the installation is likely to finish successfully.

```

\ Retrieving installed packages...
  NAME                                PACKAGE-NAME
PACKAGE-VERSION  STATUS      NAMESPACE
accelerator      1.0.0       Reconcile succeeded  accelerator.apps.tanzu.vmware.com
api-portal       1.0.6       Reconcile succeeded  api-portal.tanzu.vmware.com
appliveview     1.0.0-build.3  Reconciling         run.appliveview.tanzu.vmware.com
appliveview-conventions  1.0.0-build.3  Reconcile succeeded  build.appliveview.tanzu.vmware.com
buildservice    1.4.0-build.1  Reconciling         buildservice.tanzu.vmware.com
cartographer    0.1.0        Reconcile succeeded  cartographer.tanzu.vmware.com
cert-manager    1.5.3+tap.1   Reconcile succeeded  cert-manager.tanzu.vmware.com
cnrs            1.1.0        Reconcile succeeded  cnrs.tanzu.vmware.com
contour         1.18.2+tap.1  Reconcile succeeded  contour.tanzu.vmware.com
conventions-controller  0.4.2         Reconcile succeeded  controller.conventions.apps.tanzu.vmware.com
developer-conventions  0.4.0-build1  Reconcile succeeded  developer-conventions.tanzu.vmware.com
fluxcd-source-controller  0.16.0       Reconcile succeeded  fluxcd.source.controller.tanzu.vmware.com
grype          0.4.2         Reconcile succeeded  grype.scanning.apps.tanzu.vmware.com

```

1.0.0	Reconcile	succeeded	tap-install
image-policy-webhook			image-policy-webhook.signing.apps.tanzu.vmware.com
1.0.0-beta.3	Reconcile	succeeded	tap-install
learningcenter			learningcenter.tanzu.vmware.com
0.1.0-build.6	Reconcile	succeeded	tap-install
learningcenter-workshops			workshops.learningcenter.tanzu.vmware.com
0.1.0-build.7	Reconcile	succeeded	tap-install
ootb-delivery-basic			ootb-delivery-basic.tanzu.vmware.com
0.5.1	Reconcile	succeeded	tap-install
ootb-supply-chain-basic			ootb-supply-chain-basic.tanzu.vmware.com
0.5.1	Reconcile	succeeded	tap-install
ootb-templates			ootb-templates.tanzu.vmware.com
0.5.1	Reconcile	succeeded	tap-install
scanning			scanning.apps.tanzu.vmware.com
1.0.0	Reconcile	succeeded	tap-install
metadata-store			metadata-store.apps.tanzu.vmware.com
1.0.2	Reconcile	succeeded	tap-install
service-bindings			service-bindings.labs.vmware.com
0.6.0	Reconcile	succeeded	tap-install
services-toolkit			services-toolkit.tanzu.vmware.com
0.7.1	Reconcile	succeeded	tap-install
source-controller			controller.source.apps.tanzu.vmware.com
0.2.0	Reconcile	succeeded	tap-install
spring-boot-conventions			spring-boot-conventions.tanzu.vmware.com
0.2.0	Reconcile	succeeded	tap-install
tap			tap.tanzu.vmware.com
0.4.0-build.12	Reconciling		tap-install
tap-gui			tap-gui.tanzu.vmware.com
1.0.0-rc.72	Reconcile	succeeded	tap-install
tap-telemetry			tap-telemetry.tanzu.vmware.com
0.1.0	Reconcile	succeeded	tap-install
tekton-pipelines			tekton.tanzu.vmware.com
0.30.0	Reconcile	succeeded	tap-install

If the installation has stopped running, one or more reconciliations have likely failed, as seen in the following example:

NAME	PACKAGE NAME
PACKAGE VERSION	DESCRIPTION
AGE	
accelerator	accelerator.apps.tanzu.vmware.com
1.0.1	Reconcile succeeded
109m	
api-portal	api-portal.tanzu.vmware.com
1.0.9	Reconcile succeeded
119m	
appliveview	run.appliveview.tanzu.vmware.com
1.0.2-build.2	Reconcile succeeded
109m	
appliveview-conventions	build.appliveview.tanzu.vmware.com
1.0.2-build.2	Reconcile succeeded
109m	
buildservice	buildservice.tanzu.vmware.com
1.5.0	Reconcile succeeded
119m	
cartographer	cartographer.tanzu.vmware.com
0.2.1	Reconcile succeeded
117m	
cert-manager	cert-manager.tanzu.vmware.com
1.5.3+tap.1	Reconcile succeeded
119m	
cnrs	cnrs.tanzu.vmware.com
1.1.0	Reconcile succeeded
109m	
contour	contour.tanzu.vmware.com

```

1.18.2+tap.1      Reconcile succeeded
117m
conventions-controller controller.conventions.apps.tanzu.vmware.com
0.5.0            Reconcile succeeded
117m
developer-conventions developer-conventions.tanzu.vmware.com
0.5.0            Reconcile succeeded
109m
fluxcd-source-controller fluxcd.source.controller.tanzu.vmware.com
0.16.1           Reconcile succeeded
119m
grype              grype.scanning.apps.tanzu.vmware.com
1.0.0            Reconcile failed: Error (see .status.usefulErrorMessage for details) 109m
image-policy-webhook image-policy-webhook.signing.apps.tanzu.vmware.com
1.0.1            Reconcile succeeded
117m
learningcenter     learningcenter.tanzu.vmware.com
0.1.0            Reconcile succeeded
109m
learningcenter-workshops workshops.learningcenter.tanzu.vmware.com
0.1.0            Reconcile succeeded
103m
metadata-store     metadata-store.apps.tanzu.vmware.com
1.0.2            Reconcile succeeded
117m
ootb-delivery-basic ootb-delivery-basic.tanzu.vmware.com
0.6.1            Reconcile succeeded
103m
ootb-supply-chain-basic ootb-supply-chain-basic.tanzu.vmware.com
0.6.1            Reconcile succeeded
103m
ootb-templates     ootb-templates.tanzu.vmware.com
0.6.1            Reconcile succeeded
109m
scanning           scanning.apps.tanzu.vmware.com
1.0.0            Reconcile succeeded
119m
service-bindings   service-bindings.labs.vmware.com
0.6.0            Reconcile succeeded
119m
services-toolkit   services-toolkit.tanzu.vmware.com
0.7.1            Reconcile succeeded
119m
source-controller  controller.source.apps.tanzu.vmware.com
0.2.0            Reconcile succeeded
119m
spring-boot-conventions spring-boot-conventions.tanzu.vmware.com
0.3.0            Reconcile succeeded
109m
tap                tap.tanzu.vmware.com
1.0.1            Reconcile failed: Error (see .status.usefulErrorMessage for details) 119m
tap-gui            tap-gui.tanzu.vmware.com
1.0.2            Reconcile succeeded
109m
tap-telemetry      tap-telemetry.tanzu.vmware.com
0.1.3            Reconcile succeeded
119m
tekton-pipelines   tekton.tanzu.vmware.com
0.30.0           Reconcile succeeded
119m

```

In this example, `packageinstall/grype` and `packageinstall/tap` have reconciliation errors.

2. To get more details on the possible cause of a reconciliation failure, run:

```
kubectl describe packageinstall/NAME -n tap-install
```

Where `NAME` is the name of the failing package. For this example it would be `grype`.

3. Use the displayed information to search for a relevant troubleshooting issue in this topic. If none exists, and you are unable to fix the described issue yourself, please contact [support](#).
4. Repeat these diagnosis steps for any other packages that failed to reconcile.

Ingress is broken on Kind cluster

Your Contour installation cannot provide ingress to workloads when installed on a Kind cluster without a LoadBalancer solution. Your Kind cluster was created with port mappings, as described in the [Kind install guide](#).

Explanation

In Tanzu Application Platform v1.6.13, the default configuration for `contour.envoy.service.type` is `LoadBalancer`. However, for the Envoy pods to be accessed by using the port mappings on your Kind cluster, the service must be of type `NodePort`.

Solution

Configure `contour.envoy.service.type` to be `NodePort`. Then, configure `envoy.service.nodePorts.http` and `envoy.service.nodePorts.https` to the corresponding port mappings on your Kind node. Otherwise, the NodePort service is assigned random ports, which are not accessible through your Kind cluster.

Troubleshoot using Tanzu Application Platform

This topic tells you how to troubleshoot using Tanzu Application Platform (commonly known as TAP).

Installed packages are failing

Symptom:

You skipped relocating images from VMware Tanzu Network during installation, and now your installed packages are failing.

Explanation:

If you did not relocate the Tanzu Application Platform images during installation or upgrade, Tanzu Application Platform depends on VMware Tanzu Network for continued operation.

The Tanzu Application Platform releases have migrated from VMware Tanzu Network to the Broadcom Support Portal and Broadcom registry. Relying on VMware Tanzu Network for the Tanzu Application Platform images is no longer supported.

Solution:

Relocate the Tanzu Application Platform images by following the instructions in [Migrate Tanzu Application Platform images from VMware Tanzu Network](#).

Use events to find possible causes

Events can highlight issues with components in a supply chain. For example, high occurrences of `StampedObjectApplied` or `ResourceOutputChanged` can indicate problems with trashing on a component.

To view the recent events for a workload, run:

```
kubectl describe workload.carto.run <workload-name> -n <workload-ns>
```

Missing build logs after creating a workload

You create a workload, but no logs appear when you run:

```
tanzu apps workload tail workload-name --since 10m --timestamp
```

Explanation

Common causes include:

- Misconfigured repository
- Misconfigured service account
- Misconfigured registry credentials

Solution

To resolve this issue, run:

```
kubectl get clusterbuilder.kpack.io -o yaml
```

```
kubectl get image.kpack.io <workload-name> -o yaml
```

```
kubectl get build.kpack.io -o yaml
```

Workload creation stops responding with “Builder default is not ready” message

You can see the “Builder default is not ready” message in two places:

1. The “Messages” section of the `tanzu apps workload get my-app` command.
2. The Supply Chain section of Tanzu Developer Portal (formerly named Tanzu Application Platform GUI).

This message indicates there is something wrong with the Builder (the component that builds the container image for your workload).

Explanation

This message is typically encountered when the core component of the Builder (`kpack`) transitions into a bad state.

Although this isn’t the only scenario where this can happen, `kpack` can transition into a bad state when Tanzu Application Platform is deployed to a local `minikube` or `kind` cluster, and especially when that `minikube` or `kind` cluster is restarted.

Solution

1. Restart `kpack` by deleting the `kpack-controller` and `kpack-webhook` pods in the `kpack` namespace. Deleting these resources triggers their recreation:
 - `kubectl delete pods --all --namespace kpack`

2. Verify status of the replacement pods:
 - `kubectl get pods --namespace kpack`
3. Verify the workload status after the new kpack pods `STATUS` are `Running`:
 - `tanzu apps workload get YOUR-WORKLOAD-NAME`

“Workload already exists” error after updating the workload

When you update the workload, you receive the following error:

```
Error: workload "default/APP-NAME" already exists
Error: exit status 1
```

Where `APP-NAME` is the name of the app.

For example, when you run:

```
tanzu apps workload create tanzu-java-web-app \
--git-repo https://github.com/dbuchko/tanzu-java-web-app \
--git-branch main \
--type web \
--label apps.tanzu.vmware.com/has-tests=true \
--yes
```

You receive the following error

```
Error: workload "default/tanzu-java-web-app" already exists
Error: exit status 1
```

Explanation

The app is running before performing a Live Update using the same app name.

Solution

To resolve this issue, either delete the app or use a different name for the app.

Workload creation fails due to authentication failure in Docker Registry

You might encounter an error message similar to the following when creating or updating a workload by using IDE or `apps` CLI plug-in:

```
Error: Writing 'index.docker.io/shaileshp2922/build-service/tanzu-java-web-app:lates
t': Error while preparing a transport to talk with the registry: Unable to create roun
d tripper: GET https://auth.ipv6.docker.com/token?scope=repository%3Ashaileshp2922%2Fb
uild-service%2Ftanzu-java-web-app%3Apush%2Cpull&service=registry.docker.io: unexpected
status code 401 Unauthorized: {"details":"incorrect username or password"}
```

Explanation

This type of error frequently occurs when the URL set for `source image` (IDE) or `--source-image` flag (`apps` CLI plug-in) is not Docker registry compliant.

Solution

1. Verify that you can authenticate directly against the Docker registry and resolve any failures by running:

```
docker login -u USER-NAME
```

2. Verify your `--source-image` URL is compliant with Docker.

The URL in this example `index.docker.io/shaileshp2922/build-service/tanzu-java-web-app` includes nesting. Docker registry, unlike many other registry solutions, does not support nesting.

3. To resolve this issue, you must provide an unnested URL. For example, `index.docker.io/shaileshp2922/tanzu-java-web-app`

Telemetry component logs show errors fetching the “reg-creds” secret

When you view the logs of the `tap-telemetry` controller by running `kubectl logs -n tap-telemetry <tap-telemetry-controller-<hash>> -f`, you see the following error:

```
"Error retrieving secret reg-creds on namespace tap-telemetry", "error": "secrets \"reg-creds\" is forbidden: User \"system:serviceaccount:tap-telemetry:controller\" cannot get resource \"secrets\" in API group \"\" in the namespace \"tap-telemetry\""
```

Explanation

The `tap-telemetry` namespace misses a role that allows the controller to list secrets in the `tap-telemetry` namespace. For more information about roles, see [Role and ClusterRole Kubernetes documentation](#).

Solution

To resolve this issue, run:

```
kubectl patch roles -n tap-telemetry tap-telemetry-controller --type='json' -p='[{"op": "add", "path": "/rules/-", "value": {"apiGroups": [""], "resources": ["secrets"], "verbs": ["get", "list", "watch"]}]'
```

Debug convention might not apply

If you upgrade from Tanzu Application Platform v0.4, the debug convention can not apply to the app run image.

Explanation

The Tanzu Application Platform v0.4 lacks SBOM data.

Solution

Delete existing app images that were built using Tanzu Application Platform v0.4.

Execute bit not set for App Accelerator build scripts

You cannot execute a build script provided as part of an accelerator.

Explanation

Build scripts provided as part of an accelerator do not have the execute bit set when a new project is generated from the accelerator.

Solution

Explicitly set the execute bit by running the `chmod` command:

```
chmod +x BUILD-SCRIPT-NAME
```

Where `BUILD-SCRIPT-NAME` is the name of the build script.

For example, for a project generated from the “Spring PetClinic” accelerator, run:

```
chmod +x ./mvnw
```

“No live information for pod with ID” error

After deploying Tanzu Application Platform workloads, Tanzu Developer Portal shows a “No live information for pod with ID” error.

Explanation

The connector must discover the application instances and render the details in Tanzu Application Platform GUI.

Solution

Recreate the Application Live View connector pod by running:

```
kubectl -n app-live-view delete pods -l=name=application-live-view-connector
```

This allows the connector to discover the application instances and render the details in Tanzu Application Platform GUI.

“image-policy-webhook-service not found” error

When installing a Tanzu Application Platform profile, you receive the following error:

```
Internal error occurred: failed calling webhook "image-policy-webhook.signing.apps.tanzu.vmware.com": failed to call webhook: Post "https://image-policy-webhook-service.image-policy-system.svc:443/signing-policy-check?timeout=10s": service "image-policy-webhook-service" not found
```

Explanation

The “image-policy-webhook-service” service cannot be found.

Solution

Redeploy the `trainingPortal` resource.

“Increase your cluster resources” error

You receive an “Increase your cluster’s resources” error.

Explanation

Node pressure can be caused by an insufficient number of nodes or a lack of resources on nodes necessary to deploy the workloads.

Solution

Follow instructions from your cloud provider to scale out or scale up your cluster.

MutatingWebhookConfiguration prevents pod admission

Admission of all pods is prevented when the `image-policy-controller-manager` deployment pods do not start before the `MutatingWebhookConfiguration` is applied to the cluster.

Explanation

Pods are prevented from starting if nodes in a cluster are scaled to zero and the webhook is forced to restart at the same time as other system components. A deadlock can occur when some components expect the webhook to verify their image signatures and the webhook is not currently running.

A known rare condition during Tanzu Application Platform profiles installation can cause this. If so, you can see a message similar to one of the following in component statuses:

```
Events:
  Type            Reason          Age           From                    Message
  ----            -
  Warning         FailedCreate    4m28s        replicaset-controller  Error creating: Internal error occurred: failed calling webhook "image-policy-webhook.signing.apps.tanzu.vmware.com": Post "https://image-policy-webhook-service.image-policy-system.svc:443/signing-policy-check?timeout=10s": no endpoints available for service "image-policy-webhook-service"
```

```
Events:
  Type            Reason          Age           From                    Message
  ----            -
  Warning         FailedCreate    10m          replicaset-controller  Error creating: Internal error occurred: failed calling webhook "image-policy-webhook.signing.apps.tanzu.vmware.com": Post "https://image-policy-webhook-service.image-policy-system.svc:443/signing-policy-check?timeout=10s": service "image-policy-webhook-service" not found
```

Solution

Delete the `MutatingWebhookConfiguration` resource to resolve the deadlock and enable the system to restart. After the system is stable, restore the `MutatingWebhookConfiguration` resource to re-enable image signing enforcement.



Important

These steps temporarily deactivate signature verification in your cluster.

1. Back up `MutatingWebhookConfiguration` to a file by running:

```
kubectl get MutatingWebhookConfiguration image-policy-mutating-webhook-configuration -o yaml > image-policy-mutating-webhook-configuration.yaml
```

2. Delete `MutatingWebhookConfiguration` by running:

```
kubectl delete MutatingWebhookConfiguration image-policy-mutating-webhook-configuration
```

3. Wait until all components are up and running in your cluster, including the `image-policy-controller-manager` pods (namespace `image-policy-system`).
4. Re-apply `MutatingWebhookConfiguration` by running:

```
kubectl apply -f image-policy-mutating-webhook-configuration.yaml
```

Priority class of webhook's pods preempts less privileged pods

When viewing the output of `kubectl get events`, you see events similar to:

```
$ kubectl get events
LAST SEEN   TYPE      REASON      OBJECT          MESSAGE
28s         Normal    Preempted    pod/testpod     Preempted by image-policy-system/image-policy-controller-manager-59dc669d99-frwcp on node test-node
```

Explanation

The Supply Chain Security Tools (SCST) - Sign component uses a privileged `PriorityClass` to start its pods to prevent node pressure from preempting its pods. This can cause less privileged components to have their pods preempted or evicted instead.

Solution

- **Solution 1: Reduce the number of pods deployed by the Sign component:** If your deployment of the Sign component runs more pods than necessary, scale the deployment down as follows:

1. Create a values file named `scst-sign-values.yaml` with the following contents:

```
---
replicas: N
```

Where `N` is an integer indicating the lowest number of pods you necessary for your current cluster configuration.

2. Apply the new configuration by running:

```
tanzu package installed update image-policy-webhook \
  --package image-policy-webhook.signing.apps.tanzu.vmware.com \
  --version 1.0.0-beta.3 \
  --namespace tap-install \
  --values-file scst-sign-values.yaml
```

3. Wait a few minutes for your configuration to take effect in the cluster.

- **Solution 2: Increase your cluster's resources:** Node pressure can be caused by an insufficient number of nodes or a lack of resources on nodes necessary to deploy the workloads. Follow instructions from your cloud provider to scale out or scale up your cluster.

CrashLoopBackOff from password authentication fails

SCST - Store does not start. You see the following error in the `metadata-store-app` Pod logs:

```
$ kubectl logs pod/metadata-store-app-* -n metadata-store -c metadata-store-app
...
[error] failed to initialize database, got error failed to connect to `host=metadata-store-db user=metadata-store-user database=metadata-store`: server error (FATAL: password authentication failed for user "metadata-store-user" (SQLSTATE 28P01))
```

Explanation

The database password has changed between deployments. This is not supported.

Solution

Redeploy the app either with the original database password or follow the latter steps to erase the data on the volume:

1. Deploy `metadata-store` app with kapp.
2. Verify that the `metadata-store-db-*` pod fails.
3. Run:

```
kubectl exec -it metadata-store-db-KUBERNETES-ID -n metadata-store /bin/bash
```

Where `KUBERNETES-ID` is the ID generated by Kubernetes and appended to the pod name.

4. To delete all database data, run:

```
rm -rf /var/lib/postgresql/data/*
```

This is the path found in `postgres-db-deployment.yaml`.

5. Delete the `metadata-store` app with kapp.
6. Deploy the `metadata-store` app with kapp.

Password authentication fails

SCST - Store does not start. You see the following error in the `metadata-store-app` pod logs:

```
$ kubectl logs pod/metadata-store-app-* -n metadata-store -c metadata-store-app
...
[error] failed to initialize database, got error failed to connect to `host=metadata-store-db user=metadata-store-user database=metadata-store`: server error (FATAL: password authentication failed for user "metadata-store-user" (SQLSTATE 28P01))
```

Explanation

The database password has changed between deployments. This is not supported.

Solution

Redeploy the app either with the original database password or follow the latter steps to erase the data on the volume:

1. Deploy `metadata-store` app with kapp.

2. Verify that the `metadata-store-db-*` pod fails.
3. Run:

```
kubectl exec -it metadata-store-db-KUBERNETES-ID -n metadata-store /bin/bash
```

Where `KUBERNETES-ID` is the ID generated by Kubernetes and appended to the pod name.

4. To delete all database data, run:

```
rm -rf /var/lib/postgresql/data/*
```

This is the path found in `postgres-db-deployment.yaml`.

5. Delete the `metadata-store` app with kapp.
 6. Deploy the `metadata-store` app with kapp.
-

metadata-store-db pod fails to start

When SCST - Store is deployed, deleted, and then redeployed, the `metadata-store-db` pod fails to start if the database password changed during redeployment.

Explanation

The persistent volume used by `PostgreSQL` retains old data, even though the retention policy is set to `DELETE`.

Solution

Redeploy the app either with the original database password or follow the later steps to erase the data on the volume:

1. Deploy `metadata-store` app with kapp.
2. Verify that the `metadata-store-db-*` pod fails.
3. Run:

```
kubectl exec -it metadata-store-db-KUBERNETES-ID -n metadata-store /bin/bash
```

Where `KUBERNETES-ID` is the ID generated by Kubernetes and appended to the pod name.

4. To delete all database data, run:

```
rm -rf /var/lib/postgresql/data/*
```

This is the path found in `postgres-db-deployment.yaml`.

5. Delete the `metadata-store` app with kapp.
 6. Deploy the `metadata-store` app with kapp.
-

Missing persistent volume

After SCST - Store is deployed, `metadata-store-db` pod fails for missing volume while `postgres-db-pv-claim` pvc is in the `PENDING` state.

Explanation

The cluster where SCST - Store is deployed does not have `storageclass` defined. The provisioner of `storageclass` is responsible for creating the persistent volume after `metadata-store-db` attaches `postgres-db-pv-claim`.

Solution

1. Verify that your cluster has `storageclass` by running:

```
kubectl get storageclass
```

2. Create a `storageclass` in your cluster before deploying SCST - Store. For example:

```
# This is the storageclass that Kind uses
kubectl apply -f https://raw.githubusercontent.com/rancher/local-path-provisioner/master/deploy/local-path-storage.yaml

# set the storage class as default
kubectl patch storageclass local-path -p '{"metadata": {"annotations":{"storageclass.kubernetes.io/is-default-class":"true"}}}'
```

Failure to connect Tanzu CLI to AWS EKS clusters

When using the Tanzu CLI to connect to AWS EKS clusters, you might see one of the following errors:

- `Error: Unable to connect: connection refused. Confirm kubeconfig details and try again`
- `invalid apiVersion "client.authentication.k8s.io/v1alpha1"`

Explanation

The cause is [Kubernetes v1.24](#) dropping support for `client.authentication.k8s.io/v1alpha1`. For more information, see [aws/aws-cli/issues/6920](#) in GitHub.

Solution

Follow these steps to update your `aws-cli` to a supported v2.7.35 or later, and update the `kubeconfig` entry for your EKS clusters:

1. Update `aws-cli` to the latest version. For more information see [AWS documentation](#).
2. Update the `kubeconfig` entry for your EKS clusters:

```
aws eks update-kubeconfig --name ${EKS_CLUSTER_NAME} --region ${REGION}
```

3. In a new terminal window, run a Tanzu CLI command to verify the connection issue is resolved. For example:

```
tanzu apps workload list
```

Expect the command to execute without error.

Invalid repository paths are propagated

When inputting `shared.image_registry.project_path`, invalid repository paths are propagated.

Explanation

The key `shared.image_registry.project_path`, which takes input as `SERVER-NAME/REPO-NAME`, cannot take “/” at the end of the string.

Solution

Do not append “/” to the end of the string.

x509: certificate signed by unknown authority

Explanation

Tanzu Application Platform v1.4 introduces [Shared Ingress Issuer](#) to secure ingress communication by default. The Certificate Authority for Shared Ingress Issuer is generated as self-signed. As a result, you might see one of the following errors:

- `connection refused`
- `x509: certificate signed by unknown authority`

Solution

You can choose one of the following options to mitigate the issue:

Option 1: Configure the Shared Ingress Issuer’s Certificate Authority as a trusted Certificate Authority



Important

This is the recommended option for a secure instance.

Follow these steps to trust the Shared Ingress Issuer’s Certificate Authority in Tanzu Application Platform:

1. Extract the ClusterIssuer’s Certificate Authority.

For default installations where `ingress_issuer` is not set in `tap_values.yml`, you can extract the ClusterIssuer’s Certificate Authority from cert-manager:

```
kubectl get secret tap-ingress-selfsigned-root-ca -n cert-manager -o yaml | yq
.data | cut -d' ' -f2 | head -1 | base64 -d
```

If you override the default `ingress_issuer` while installing Tanzu Application Platform, you must refer to your issuer’s documentation to extract your ClusterIssuer’s Certificate Authority instead of using the command above.

2. Add the certificate to the list of trusted certificate authorities by appending the certificate authority to the `shared.ca_cert_data` field in your `tap-values.yml`.
3. Reapply your configuration:

```
tanzu package install tap -p tap.tanzu.vmware.com -v ${TAP_VERSION} --values-fi
le tap-values.yml -n tap-install
```

Option 2: Deactivate the shared ingress issuer



Important

This option is recommended for testing purposes only.

Follow these steps to deactivate TLS for Cloud Native Runtimes, AppSSO and Tanzu Developer Portal:

1. Set `shared.ingress_issuer` to `""` in your `tap-values.yml`:

```
shared:
  ingress_issuer: ""
```

2. Reapply your configuration:

```
tanzu package install tap -p tap.tanzu.vmware.com -v ${TAP_VERSION} --values-file tap-values.yml -n tap-install
```

Troubleshoot Tanzu Application Platform components

For component-level troubleshooting, see these topics:

- [Troubleshoot Application Live View](#)
- [Troubleshoot Bitnami Services](#)
- [Troubleshoot Cloud Native Runtimes for Tanzu](#)
- [Troubleshoot Crossplane](#)
- [Troubleshoot Learning Center](#)
- [Troubleshoot Service Bindings](#)
- [Troubleshoot Services Toolkit](#)
- [Troubleshoot Source Controller](#)
- [Troubleshoot Spring Boot conventions](#)
- [Troubleshoot Supply Chain Security Tools - Scan](#)
- [Troubleshoot Supply Chain Security Tools - Store](#)
- [Troubleshoot Tanzu Build Service](#)
- [Tanzu Build Service FAQ](#)
- [Troubleshoot Tanzu Developer Portal](#)

Troubleshoot Tanzu GitOps Reference Implementation (RI)

This topic tells you how to troubleshoot Tanzu GitOps Reference Implementation (commonly known as RI).

Tanzu Sync application error

After the Tanzu Sync application is installed in the cluster, the main resource to check is the sync app in the `tanzu-sync` namespace:

```
kubectl -n tanzu-sync get app/sync --template='{{.status.usefulErrorMessage}}'
```

Example error:

```
kapp: Error: waiting on reconcile packageinstall/tap (packaging.carvel.dev/v1alpha1) namespace: tap-install:
```

```
Finished unsuccessfully (Reconcile failed: (message: Error (see .status.usefulErrorMessage for details)))
```

This indicates that the resource `packageinstall/tap` in the namespace `tap-install` failed. See the following section for the solution details.

Tanzu Application Platform install error

After the Tanzu Sync application is installed in the cluster, the Tanzu Application Platform starts to install. The resource to check is the Tanzu Application Platform package install in the `tap-install` namespace:

```
kubectl -n tap-install get packageinstall/tap --template='{{.status.usefulErrorMessage}}'
```

Common errors

You might encounter one of the following errors:

Given data value is not declared in schema

Error: Reconciliation fails with `Given data value is not declared in schema`

```
^ Reconcile failed: (message: ytt: Error: Overlaying data values (in following order: tap-install/.tanzu-managed/version.yaml, additional data values): One or more data values were invalid
=====

Given data value is not declared in schema
tap-values.yaml:
  |
  1 | shared:
    |

    = found: shared
    = expected: a map item with the key named "tap_install" (from tap-install/.tanzu-managed/schema--tap-sensitive-values.yaml:3)
```

Problem: The values files were not generated according to the expected schema.

Solution: Ensure both non-sensitive and sensitive Tanzu Application Platform values files to adhere to the schema described in [configure values](#).

Incorrect values example:

```
shared:
  ingress_domain: example.vmware.com
```

Correct values example:

```
tap_install:
  values:
    ingress_domain: example.vmware.com
```

ExternalSecret not found

Error: Reconciliation of `ExternalSecret` fails with `secret not found`

Example:

```
kubectl describe ExternalSecret install-registry-dockerconfig -n tanzu-sync

Status:
Conditions:
  Last Transition Time: 2023-07-20T08:14:04Z
  Message:             could not get secret data from provider
  Reason:              SecretSyncedError
  Status:              False
  Type:               Ready
Events:
  Type    Reason          Age          From          Message
  ----    -
Warning  UpdateFailed   12s (x15 over 6m14s)  external-secrets  secret not found
```

- **Problem 1:** Incorrect secret reference

Solution 1: Ensure the references in `tanzu-sync/app/values/tanzu-sync-vault-values.yaml` and `cluster-config/values/tap-install-vault-values.yaml` are correct.

- **Problem 2:** Incorrect configuration of the secret engine for Vault

Solution 2: Validate and update the version of the Vault secrets engine configuration to `v1` or `v2`. By default, `v2` is chosen.

Update `tanzu-sync/app/values/tanzu-sync-vault-values.yaml`:

```
---
secrets:
  eso:
    vault:
      ...
      version: "v1" # v1 or v2
```

Update `cluster-config/values/tap-install-vault-values.yaml`:

```
---
tap_install:
  secrets:
    eso:
      vault:
        ...
        version: "v1" # v1 or v2
```

Error occurs when deleting Kubernetes authentication

Problem: The following error occurs when deleting Kubernetes authentication:

```
./tanzu-sync/vault/scripts/setup/delete-kubernetes-auth.sh
Error deleting auth/tap-gitops-vault/config: Error making API request.
Namespace: admin/URL: DELETE https://vault-cluster-public-vault-5593a539.8ae01486.z1.h
ashicorp.cloud:8200/v1/auth/tap-gitops-vault/configCode: 405. Errors:
* 1 error occurred:
* unsupported operation
```

Solution: Update the command `vault delete auth/$CLUSTER_NAME/config` to `vault auth disable $CLUSTER_NAME` in the file `./tanzu-sync/vault/scripts/setup/delete-kubernetes-auth.sh`

Uninstall your Tanzu Application Platform by using Tanzu CLI

This document tells you how to uninstall Tanzu Application Platform (commonly known as TAP) packages from your Tanzu Application Platform package repository by using Tanzu CLI.

To uninstall Tanzu Application Platform:

- [Delete the Packages](#)
- [Delete the Tanzu Application Platform Package Repository](#)
- [Remove Tanzu CLI, plug-ins, and associated files](#)
- [Remove Cluster Essentials](#)

Delete the packages

- If you installed Tanzu Application Platform through predefined profiles, delete the `tap` metadata package by running:

```
tanzu package installed delete tap --namespace tap-install
```

- If you installed any additional packages that were not in the predefined profiles, delete the individual packages by running:

1. List the installed packages by running:

```
tanzu package installed list --namespace tap-install
```

2. Remove a package by running:

```
tanzu package installed delete PACKAGE-NAME --namespace tap-install
```

For example:

```
$ tanzu package installed delete cloud-native-runtimes --namespace tap-install
| Uninstalling package 'cloud-native-runtimes' from namespace 'tap-install'
/ Getting package install for 'cloud-native-runtimes'
\ Deleting package install 'cloud-native-runtimes' from namespace 'tap-install'
\ Package uninstall status: Reconciling
/ Package uninstall status: Deleting
| Deleting admin role 'cloud-native-runtimes-tap-install-cluster-role'
| Deleting role binding 'cloud-native-runtimes-tap-install-cluster-rolebinding'
| Deleting secret 'cloud-native-runtimes-tap-install-values'
/ Deleting service account 'cloud-native-runtimes-tap-install-sa'

Uninstalled package 'cloud-native-runtimes' from namespace 'tap-install'
```

Where `PACKAGE-NAME` is the name of a package listed in step 1.

- Repeat step 2 for each individual package installed.

Delete the Tanzu Application Platform package repository

To delete the Tanzu Application Platform package repository:

- Retrieve the name of the Tanzu Application Platform package repository by running:

```
tanzu package repository list --namespace tap-install
```

For example:

```
$ tanzu package repository list --namespace tap-install
- Retrieving repositories...
  NAME                                REPOSITORY
STATUS                                DETAILS
  tanzu-tap-repository  tanzu.packages.broadcom.com/tanzu-application-platform/
tap-packages:0.2.0  Reconcile succeeded
```

- Remove the Tanzu Application Platform package repository by running:

```
tanzu package repository delete PACKAGE-REPO-NAME --namespace tap-install
```

Where `PACKAGE-REPO-NAME` is the name of the packageRepository from the earlier step.

For example:

```
$ tanzu package repository delete tanzu-tap-repository --namespace tap-install
- Deleting package repository 'tanzu-tap-repository'...
Deleted package repository 'tanzu-tap-repository' in namespace 'tap-install'
```

Remove Tanzu CLI, plug-ins, and associated files

To completely remove the Tanzu CLI, plug-ins, and associated files, run the script for your OS:

- For Linux or MacOS, run:

```
#!/bin/zsh
rm -rf $HOME/tanzu/cli          # Remove previously downloaded cli files
sudo rm /usr/local/bin/tanzu   # Remove CLI binary (executable)
rm -rf ~/.config/tanzu/       # current location # Remove config directory
rm -rf ~/.tanzu/              # old location # Remove config directory
rm -rf ~/.cache/tanzu         # remove cached catalog.yaml
rm -rf ~/Library/Application\ Support/tanzu-cli/* # Remove plug-ins
```

- Uninstall tanzu cli installed using package manager:

- On mac:

```
brew uninstall vmware-tanzu/tanzu/tanzu-cli
```

- On Linux:

```
sudo apt remove tanzu-cli
```

```
sudo yum remove tanzu-cli
```

- On Windows:

```
choco uninstall tanzu-cli
```

Remove Cluster Essentials

To completely remove Cluster Essentials, see [Cluster Essentials documentation](#).

Remove Crossplane resources

To remove Crossplane resources, see [Delete Crossplane resources when you uninstall Tanzu Application Platform](#).

Uninstall your Tanzu Application Platform by using Tanzu CLI

This document tells you how to uninstall Tanzu Application Platform (commonly known as TAP) packages from your Tanzu Application Platform package repository by using Tanzu CLI.

To uninstall Tanzu Application Platform:

- [Delete the Packages](#)
- [Delete the Tanzu Application Platform Package Repository](#)
- [Remove Tanzu CLI, plug-ins, and associated files](#)
- [Remove Cluster Essentials](#)

Delete the packages

- If you installed Tanzu Application Platform through predefined profiles, delete the `tap` metadata package by running:

```
tanzu package installed delete tap --namespace tap-install
```

- If you installed any additional packages that were not in the predefined profiles, delete the individual packages by running:

1. List the installed packages by running:

```
tanzu package installed list --namespace tap-install
```

2. Remove a package by running:

```
tanzu package installed delete PACKAGE-NAME --namespace tap-install
```

For example:

```
$ tanzu package installed delete cloud-native-runtimes --namespace tap-in
stall
| Uninstalling package 'cloud-native-runtimes' from namespace 'tap-instal
l'
/ Getting package install for 'cloud-native-runtimes'
\ Deleting package install 'cloud-native-runtimes' from namespace 'tap-in
stall'
\ Package uninstall status: Reconciling
/ Package uninstall status: Deleting
| Deleting admin role 'cloud-native-runtimes-tap-install-cluster-role'
| Deleting role binding 'cloud-native-runtimes-tap-install-cluster-rolebi
nding'
```

```
| Deleting secret 'cloud-native-runtimes-tap-install-values'
/ Deleting service account 'cloud-native-runtimes-tap-install-sa'

Uninstalled package 'cloud-native-runtimes' from namespace 'tap-install'
```

Where `PACKAGE-NAME` is the name of a package listed in step 1.

- Repeat step 2 for each individual package installed.

Delete the Tanzu Application Platform package repository

To delete the Tanzu Application Platform package repository:

- Retrieve the name of the Tanzu Application Platform package repository by running:

```
tanzu package repository list --namespace tap-install
```

For example:

```
$ tanzu package repository list --namespace tap-install
- Retrieving repositories...
  NAME                                REPOSITORY
STATUS                                DETAILS
tanzu-tap-repository tanzu.packages.broadcom.com/tanzu-application-platform/
tap-packages:0.2.0 Reconcile succeeded
```

- Remove the Tanzu Application Platform package repository by running:

```
tanzu package repository delete PACKAGE-REPO-NAME --namespace tap-install
```

Where `PACKAGE-REPO-NAME` is the name of the packageRepository from the earlier step.

For example:

```
$ tanzu package repository delete tanzu-tap-repository --namespace tap-install
- Deleting package repository 'tanzu-tap-repository'...
Deleted package repository 'tanzu-tap-repository' in namespace 'tap-install'
```

Remove Tanzu CLI, plug-ins, and associated files

To completely remove the Tanzu CLI, plug-ins, and associated files, run the script for your OS:

- For Linux or MacOS, run:

```
#!/bin/zsh
rm -rf $HOME/tanzu/cli # Remove previously downloaded cli files
sudo rm /usr/local/bin/tanzu # Remove CLI binary (executable)
rm -rf ~/.config/tanzu/ # current location # Remove config directory
rm -rf ~/.tanzu/ # old location # Remove config directory
rm -rf ~/.cache/tanzu # remove cached catalog.yaml
rm -rf ~/Library/Application\ Support/tanzu-cli/* # Remove plug-ins
```

- Uninstall tanzu cli installed using package manager:

- On mac:

```
brew uninstall vmware-tanzu/tanzu/tanzu-cli
```

- On Linux:

```
sudo apt remove tanzu-cli
```

```
sudo yum remove tanzu-cli
```

- o On Windows:

```
choco uninstall tanzu-cli
```

Remove Cluster Essentials

To completely remove Cluster Essentials, see [Cluster Essentials documentation](#).

Remove Crossplane resources

To remove Crossplane resources, see [Delete Crossplane resources when you uninstall Tanzu Application Platform](#).

Uninstall Tanzu Application Platform by using GitOps

This document tells you how to uninstall Tanzu Application Platform (commonly known as TAP) when installed by using GitOps.



Caution

Tanzu Application Platform (GitOps) is currently in beta and is intended for evaluation and test purposes only. Do not use in a production environment.

To uninstall your Tanzu Application Platform:

- [Delete Tanzu Sync Application](#)
- [Delete external resources \(ESO installation only\)](#)
- [Remove the Tanzu CLI, plug-ins, and associated files](#)
- [Remove Cluster Essentials](#)

Delete Tanzu Sync Application



Caution

- Deleting Tanzu Sync application removes all associated resources of Tanzu Application Platform on the cluster.
- You must delete any applications that were installed manually into the `tap-install` namespace, because they might interfere with the deletion of Tanzu Application Platform.

To delete Tanzu Sync Application, run:

```
kapp delete -a tanzu-sync
```

Delete external resources from AWS Secrets Manager

To delete external resources from AWS, run:

```
cd $HOME/REPO-NAME/clusters/CLUSTER-NAME
./tanzu-sync/aws/scripts/setup/delete-irsa.sh
./tanzu-sync/aws/scripts/setup/delete-policies.sh
```

Delete external resources from Hashicorp Vault

To delete external resources from AWS, run:

```
cd $HOME/REPO-NAME/clusters/CLUSTER-NAME
./tanzu-sync/vault/scripts/setup/delete-roles.sh
./tanzu-sync/vault/scripts/setup/delete-policies.sh
./tanzu-sync/vault/scripts/setup/delete-kubernetes-auth.sh
```

Remove the Tanzu CLI, plug-ins, and associated files

To completely remove the Tanzu CLI, plug-ins, and associated files, run the following scrips for Linux or MacOS:

```
#!/bin/zsh
rm -rf $HOME/tanzu/cli          # Remove previously downloaded cli files
sudo rm /usr/local/bin/tanzu  # Remove CLI binary (executable)
rm -rf ~/.config/tanzu/       # current location # Remove config directory
rm -rf ~/.tanzu/              # old location # Remove config directory
rm -rf ~/.cache/tanzu        # remove cached catalog.yaml
rm -rf ~/Library/Application\ Support/tanzu-cli/* # Remove plug-ins
```

Remove Cluster Essentials

To completely remove Cluster Essentials, see [Cluster Essentials documentation](#).

Component documentation for Tanzu Application Platform

Tanzu Application Platform (commonly known as TAP) is a modular platform that you can enhance by installing components. Most of the Tanzu Application Platform components are documented in this section. In some cases, a component's documentation is hosted on a separate site, and you'll find a link to it in this section.

Component documentation for Tanzu Application Platform

Tanzu Application Platform (commonly known as TAP) is a modular platform that you can enhance by installing components. Most of the Tanzu Application Platform components are documented in this section. In some cases, a component's documentation is hosted on a separate site, and you'll find a link to it in this section.

Overview of Tanzu CLI

This topic tells you about the Tanzu command-line interface (commonly known as Tanzu CLI).

Tanzu CLI

The Tanzu CLI is a command-line interface that connects you to Tanzu. For example, some functions of Tanzu CLI include:

- Configure the Tanzu CLI itself
- Install and manage packages
- Run Tanzu services and components
- Create and manage application workloads

For more information about Tanzu CLI, see the [VMware Tanzu CLI documentation](#).

Tanzu CLI architecture

The Tanzu CLI has a pluggable architecture. Plug-ins extend the Tanzu CLI core with additional CLI commands.

The following CLI plug-ins are required to install and use Tanzu Application Platform:

- `accelerator`: Manage accelerators in a Kubernetes cluster
- `apps`: Manage application workloads running on workload clusters
- `build-service`: Plug-in to interact with Tanzu Build Service (TBS) crds
- `external-secrets`: Interact with external-secrets.io resources
- `insight`: Post and query image, package, source, and vulnerability data
- `package`: Package management
- `secret`: Secret management

- `services`: Discover service types, service instances, and manage resource claims

You can also develop your own plug-ins to add custom commands to the Tanzu CLI.

Tanzu CLI installation

You install and initialize the Tanzu CLI on a computer. The computer can be a laptop, host, or server. To install the CLI see [Install Tanzu CLI](#).

Tanzu CLI command groups

Tanzu CLI commands are organized into command groups. View a list of available command groups by running:

```
tanzu
```

The list of command groups that you see depends on which CLI plug-ins are installed on your local machine.

Install new plug-ins

Install the CLI plug-ins required for Tanzu Application Platform v1.6.13 by running:

```
tanzu plugin install --group vmware-tap/default:v{{ vars.tap_version }}
```

Plug-ins for the Tanzu CLI are distributed by using a centralized plug-in repository.

The centralized plug-in repository contains:

- CLI plug-ins, which you can install individually
- Plug-in groups, which are a collection of plug-ins that you can install by using a single command

To discover and install plug-ins and plug-in groups:

1. Discover which plug-ins or plug-in groups are available for installation by running:

```
tanzu plugin search
```

```
tanzu plugin group search
```



Note

Include the `--show-details` flag to see all plug-in or group versions available for installation.

2. Install the latest version of a plug-in or plug-in group by running:

```
tanzu plugin install PLUG-IN-NAME
```

```
tanzu plugin install --group GROUP-NAME
```

3. Install a specific version of a plug-in or plug-in group by running:

```
tanzu plugin install PLUG-IN-NAME --version VERSION
```

```
tanzu plugin install --group GROUP-NAME:VERSION
```

Overview of Tanzu CLI

This topic tells you about the Tanzu command-line interface (commonly known as Tanzu CLI).

Tanzu CLI

The Tanzu CLI is a command-line interface that connects you to Tanzu. For example, some functions of Tanzu CLI include:

- Configure the Tanzu CLI itself
- Install and manage packages
- Run Tanzu services and components
- Create and manage application workloads

For more information about Tanzu CLI, see the [VMware Tanzu CLI documentation](#).

Tanzu CLI architecture

The Tanzu CLI has a pluggable architecture. Plug-ins extend the Tanzu CLI core with additional CLI commands.

The following CLI plug-ins are required to install and use Tanzu Application Platform:

- `accelerator`: Manage accelerators in a Kubernetes cluster
- `apps`: Manage application workloads running on workload clusters
- `build-service`: Plug-in to interact with Tanzu Build Service (TBS) crds
- `external-secrets`: Interact with external-secrets.io resources
- `insight`: Post and query image, package, source, and vulnerability data
- `package`: Package management
- `secret`: Secret management
- `services`: Discover service types, service instances, and manage resource claims

You can also develop your own plug-ins to add custom commands to the Tanzu CLI.

Tanzu CLI installation

You install and initialize the Tanzu CLI on a computer. The computer can be a laptop, host, or server. To install the CLI see [Install Tanzu CLI](#).

Tanzu CLI command groups

Tanzu CLI commands are organized into command groups. View a list of available command groups by running:

```
tanzu
```

The list of command groups that you see depends on which CLI plug-ins are installed on your local machine.

Install new plug-ins

Install the CLI plug-ins required for Tanzu Application Platform v1.6.13 by running:

```
tanzu plugin install --group vmware-tap/default:v{{ vars.tap_version }}
```

Plug-ins for the Tanzu CLI are distributed by using a centralized plug-in repository.

The centralized plug-in repository contains:

- CLI plug-ins, which you can install individually
- Plug-in groups, which are a collection of plug-ins that you can install by using a single command

To discover and install plug-ins and plug-in groups:

1. Discover which plug-ins or plug-in groups are available for installation by running:

```
tanzu plugin search
```

```
tanzu plugin group search
```



Note

Include the `--show-details` flag to see all plug-in or group versions available for installation.

2. Install the latest version of a plug-in or plug-in group by running:

```
tanzu plugin install PLUG-IN-NAME
```

```
tanzu plugin install --group GROUP-NAME
```

3. Install a specific version of a plug-in or plug-in group by running:

```
tanzu plugin install PLUG-IN-NAME --version VERSION
```

```
tanzu plugin install --group GROUP-NAME:VERSION
```

Overview of Tanzu CLI plug-ins

The topics in this section tell you about the following Tanzu CLI plug-ins in Tanzu Application Platform (commonly known as TAP).

- [accelerator](#) - The Application Accelerator Tanzu CLI plug-in includes commands for developers and operators to create and use accelerators.
- [apps](#) - This Tanzu Apps CLI plug-in provides the ability to create, view, update, and delete application workloads on any Kubernetes cluster that has the Tanzu Application Platform components installed.
- [build-service](#) - The Tanzu Build Service CLI plug-in provides the ability to view all the Tanzu Build Service resources on any Kubernetes cluster.
- [insight](#) - The Tanzu Insight CLI plug-in enables querying vulnerability, image, and package data.

Overview of Tanzu CLI plug-ins

The topics in this section tell you about the following Tanzu CLI plug-ins in Tanzu Application Platform (commonly known as TAP).

- [accelerator](#) - The Application Accelerator Tanzu CLI plug-in includes commands for developers and operators to create and use accelerators.
- [apps](#) - This Tanzu Apps CLI plug-in provides the ability to create, view, update, and delete application workloads on any Kubernetes cluster that has the Tanzu Application Platform components installed.
- [build-service](#) - The Tanzu Build Service CLI plug-in provides the ability to view all the Tanzu Build Service resources on any Kubernetes cluster.
- [insight](#) - The Tanzu Insight CLI plug-in enables querying vulnerability, image, and package data.

Tanzu Apps CLI overview

This topic gives you an overview of the Tanzu Apps CLI. Use the Tanzu Apps CLI to create, view, update, and delete application workloads on any Kubernetes cluster that has the Tanzu Application Platform (commonly known as TAP) components installed.

About workloads

Tanzu Application Platform enables you to quickly build and test applications regardless of your familiarity with Kubernetes. You can turn source code into a workload that runs in a container with a URL. A workload enables you to choose application specifications, such as repository location, environment variables, and service binding.

Tanzu Application Platform can support a range of workloads, including a serverless process that starts on demand, a constellation of microservices that functions as a logical application, or a small hello-world test application.

For information about installing the Tanzu Apps CLI, see [Install Tanzu Apps CLI](#).

Tanzu Apps CLI overview

This topic gives you an overview of the Tanzu Apps CLI. Use the Tanzu Apps CLI to create, view, update, and delete application workloads on any Kubernetes cluster that has the Tanzu Application Platform (commonly known as TAP) components installed.

About workloads

Tanzu Application Platform enables you to quickly build and test applications regardless of your familiarity with Kubernetes. You can turn source code into a workload that runs in a container with a URL. A workload enables you to choose application specifications, such as repository location, environment variables, and service binding.

Tanzu Application Platform can support a range of workloads, including a serverless process that starts on demand, a constellation of microservices that functions as a logical application, or a small hello-world test application.

For information about installing the Tanzu Apps CLI, see [Install Tanzu Apps CLI](#).

Get started with Apps CLI plug-in

The Getting Started section contains the following topics:

- [Install the Apps CLI plug-in](#)
- [Configure the Apps CLI plug-in](#)

Install Tanzu Apps CLI

This topic tells you how to install the Tanzu Apps CLI on Tanzu Application Platform (commonly known as TAP).

Prerequisites

Ensure that you installed or updated the core Tanzu CLI. For more information, see [Install Tanzu CLI](#).

Install Tanzu Apps CLI plug-in

Run:

```
tanzu plugin install apps --group vmware-tap/default:v1.6
```

Verify that the plug-in is installed correctly:

```
tanzu apps version
# sample output
v0.12.1
```

Uninstall Tanzu Apps CLI

Run:

```
tanzu plugin delete apps
```

Configure the Tanzu Apps CLI

This topic tells you how to configure the Tanzu Apps CLI on Tanzu Application Platform (commonly known as TAP).

Changing clusters with `-context`

The Tanzu Apps CLI references the default kubeconfig file to access a Kubernetes cluster. When you run a `tanzu apps` command, the Tanzu Apps CLI uses the default context. The default context is defined in the kubeconfig file located by default in: `HOME/.kube/config`.

There are two ways to change the target cluster:

1. Use `kubectl config use-context CONTEXT-NAME` to change the default context. All subsequent `tanzu apps` commands target the cluster defined in the new default kubeconfig context.
2. Include the `--context CONTEXT-NAME` flag when running any `tanzu apps` command.



Note

Any subsequent `tanzu apps` commands that do not include the `--context CONTENT-NAME` flag continue to use the default context set in the kubeconfig.

Overriding the default kubeconfig

There are two approaches to overriding the default kubeconfig:

1. To change the kubeconfig the Tanzu Apps CLI will reference, set the environment variable `KUBECONFIG=PATH`. All subsequent `tanzu apps` commands reference the non-default kubeconfig assigned to the environment variable.
2. Include the `--kubeconfig path` flag when running any `tanzu apps` command.



Note

Any subsequent `tanzu apps` commands that do not include the `--context CONTEXT-NAME` flag continue to use the default context set in the kubeconfig.

For more information about kubeconfig, see the [Kubernetes documentation](#).

Suppressing color with `--no-color` flag

Most Apps Plug-in commands have emojis and colored output. In some cases, color, emojis, and other characters are not needed, such as for automated scripting, or where the misinterpretation of these features by a terminal could result in a poor user experience. Use the `--no-color` flag to suppress color, emojis, and animation.

The following example creates a workload with code from `--local-path`. The `--no-color` flag suppresses the emojis and animated upload progress bar:

```
tanzu apps workload apply my-workload --local-path path/to/my/source --type web --no-color
The files and/or directories listed in the .tanzuignore file are being excluded from the uploaded source code.
Publishing source in "path/to/my/source" to "local-source-proxy.tap-local-source-system.svc.cluster.local/source:default-my-workload"...
Published source

Create workload:
 1 + |---
 2 + |apiVersion: carto.run/v1alpha1
 3 + |kind: Workload
 4 + |metadata:
 5 + |  annotations:
 6 + |    local-source-proxy.apps.tanzu.vmware.com: registry.io/project/source:default-my-workload@sha256:447db92e289dbe3a6969521917496ff2b6b0a1d6fbff1beec3af726430ce8493
 7 + |  labels:
 8 + |    apps.tanzu.vmware.com/workload-type: web
 9 + |  name: my-workload
10 + |  namespace: default
11 + |spec:
12 + |  source:
13 + |    image: registry.io/project/source:default-my-workload@sha256:447db92e289dbe3a6969521917496ff2b6b0a1d6fbff1beec3af726430ce8493
? Do you want to create this workload? [yN]:
```

Persist the suppression of color, emojis, and animation across commands by setting the `NO_COLOR` environment variable.

```
export NO_COLOR=true
```

tanzuignore file

Use the optional `.tanzuignore` file at the root of your project directory to indicate which files or directories in your project are not required to build or run your application such as `README.md`, `.git`, or docs. Including these files in your `.tanzuignore` provides the following benefits:

1. Items included in the `.tanzuignore` file are not uploaded when you upload your source code. This helps to avoid unnecessary consumption of resources.
2. When iterating on code with the `--live-update` flag enabled, changes to directories or files listed in the `.tanzuignore` file do not trigger the automatic re-deployment of source code.

The following are some guidelines for the `.tanzuignore` file:

- The `.tanzuignore` file should include a reference to itself, as it provides no value when deployed.
- Directories must not end with the system separator `/`, or `\`.
- Add comments using hashtag `#`.
- If the `.tanzuignore` file contains files or directories that are not found in the source code, they are ignored.

Example of a .tanzuignore file

```
.tanzuignore # must contain itself in order to be ignored
# This is a comment
this/is/a/folder/to/exclude

this-is-a-file.ext
```

Registry flags and environment variables

You can either trust a custom certificate on a system or pass the path to the certificate via flags. Environment variables can also be set to avoid having to pass the flags and values for every command incantation.

Below is a list of each of the flags with the corresponding environment variable equivalent in parenthesis:

- `--registry-ca-cert`: This is the path of the self-signed certificate needed for the custom or private registry (`TANZU_APPS_REGISTRY_CA_CERT`).
- `--registry-password`: Use this when the registry requires credentials to push (`TANZU_APPS_REGISTRY_PASSWORD`).
- `--registry-username`: Use with `--registry-password` to set the registry credentials (`TANZU_APPS_REGISTRY_USERNAME`).
- `--registry-token`: Set when the registry authentication is done through a token (`TANZU_APPS_REGISTRY_TOKEN`).

For example:

```
tanzu apps workload apply WORKLOAD \
--local-path PATH-TO-REPO --source-image registry.url.nip.io/PACKAGE/IMAGE \
--type web --registry-ca-cert path/to/ca/cert.nip.io.crt \
```

```
--registry-username USERNAME \
--registry-password PASSWORD
```

Alternatively, run as:

```
export TANZU_APPS_REGISTRY_CA_CERT=path/to/ca/cert.nip.io.crt
export TANZU_APPS_REGISTRY_PASSWORD=USERNAME
export TANZU_APPS_REGISTRY_USERNAME=PASSWORD

tanzu apps workload apply WORKLOAD \
--local-path PATH-TO-REPO \
--source-image registry.url.nip.io/PACKAGE/IMAGE
```

Use the `--type` flag to specify the type of workload. Persist the workload type value across commands by setting the `TANZU_APPS_TYPE` environment variable. The default value of `web` is set automatically if no `--type` flag or `TANZU_APPS_TYPE` value is provided.

```
export TANZU_APPS_TYPE=server
```

Autocompletion

The Tanzu Apps CLI provides auto-completion support for commands, positional arguments, flags, and flag values.

Add one of the following commands to the shell config file according to your setup:

Bash

```
tanzu completion bash > HOME/.tanzu/completion.bash.inc
```

Zsh

```
echo "autoload -U compinit; compinit" >> ~/.zshrc
tanzu completion zsh > "${fpath[1]}/_tanzu"
```

Tanzu Apps CLI tutorials

This section contains the following topics:

- [Create/Update a Workload](#)
- [Get Workload Status](#)
- [Delete a workload](#)

Create or update a workload

This topic tells you how to create a workload in Tanzu Application Platform (commonly known as TAP) from a `workload.yaml` file, a URL, a Git source, a local source, and a pre-built image.

For more information about the different types of workload creation, see [Supply Chain How-to-guides](#).

Create a workload from a `workload.yaml` file or from a URL

You can create a workload from a `workload.yaml` file or from a URL.

Create a workload from a YAML file

In many cases, workload life cycles are managed through CLI commands. However, there might be cases where managing the workload through direct interactions and edits of a `yaml` file is preferred. The Apps CLI plug-in supports using `yaml` files to meet the requirements.

When a workload is managed using a `yaml` file, that file must contain a single workload definition.

For example, a valid file looks similar to the following example:

```
---
apiVersion: carto.run/v1alpha1
kind: Workload
metadata:
  name: tanzu-java-web-app
  labels:
    app.kubernetes.io/part-of: tanzu-java-web-app
    apps.tanzu.vmware.com/workload-type: web
spec:
  source:
    git:
      url: https://github.com/vmware-tanzu/application-accelerator-samples
      ref:
        tag: tap-1.6.0
      subPath: tanzu-java-web-app
```

To create a workload from a file like the earlier example:

```
tanzu apps workload create --file my-workload-file.yaml
```



Note

When flags are passed in combination with `--file my-workload-file.yaml` the flag values take precedence over the associated property or values in the YAML.

Create a workload from stdin

The workload `yaml` definition can also be passed in through stdin as follows:

```
tanzu apps workload create --file - --yes
```

The console waits for input, and the content with valid `yaml` definitions for a workload can either be written or pasted. Then click `Ctrl-D` three times to start the workload creation. This can also be done with the `workload apply` command.

To pass a workload through `stdin`, the `--yes` flag is required. If not provided, the command fails.

```
tanzu apps workload create -f -y
WARNING: Configuration file update strategy is changing. By default, provided configuration files will replace rather than merge existing configuration. The change will take place in the January 2024 TAP release (use "--update-strategy" to control strategy explicitly).

---
apiVersion: carto.run/v1alpha1
kind: Workload
metadata:
  name: tanzu-java-web-app
  labels:
    app.kubernetes.io/part-of: tanzu-java-web-app
    apps.tanzu.vmware.com/workload-type: web
```

```

spec:
  source:
    git:
      url: https://github.com/vmware-tanzu/application-accelerator-samples
      ref:
        tag: tap-1.6.0
      subPath: tanzu-java-web-app
  Create workload:
    1 + |---
    2 + |apiVersion: carto.run/v1alpha1
    3 + |kind: Workload
    4 + |metadata:
    5 + |  labels:
    6 + |    app.kubernetes.io/part-of: tanzu-java-web-app
    7 + |    apps.tanzu.vmware.com/workload-type: server
    8 + |  name: tanzu-java-web-app
    9 + |  namespace: default
    10 + |spec:
    11 + |  source:
    12 + |    git:
    13 + |      ref:
    14 + |        tag: tap-1.6.0
    15 + |        url: https://github.com/vmware-tanzu/application-accelerator-samples
    16 + |        subPath: tanzu-java-web-app
  Created workload "tanzu-java-web-app"

To see logs:  "tanzu apps workload tail tanzu-java-web-app --timestamp --since 1h"
To get status: "tanzu apps workload get tanzu-java-web-app"

```

Create a workload from URL

Another way to pass a workload with the `--file` flag is using a URL, which must contain a raw file with the workload definition.

For example:

```
tanzu apps workload create --file https://raw.githubusercontent.com/vmware-tanzu/apps-
cli-plugin/main/pkg/commands/testdata/workload.yaml
```

Create workload from Git source

Use the `--git-repo`, `--git-branch`, `--git-tag`, and `--git-commit` flags to create a workload from an existing Git repository. This allows the [supply chain](#) to get the source from the given repository to deploy the application.

To create a named workload and specify a Git source code location, run:

```
tanzu apps workload apply tanzu-java-web-app --git-repo https://github.com/vmware-tanzu/
application-accelerator-samples --sub-path tanzu-java-web-app --git-tag tap-1.6.0 --
type web
```

Respond `y` to prompts to complete process.

Where:

- `tanzu-java-web-app` is the name of the workload.
- `--git-repo` is the location of the code to build the workload from.
- `--sub-path` (optional) is the relative path inside the repository to treat as application root.
- `--git-tag` (optional) specifies which tag in the repository to pull the code from.
- `--git-branch` (optional) specifies which branch in the repository to pull the code from.

- `--type` distinguishes the workload type.

This process can also be done with non-publicly accessible repositories. These require authentication using credentials stored in a Kubernetes secret. The supply chain is in charge of managing these credentials.

View the full list of supported workload configuration options by running `tanzu apps workload apply --help`.

Unset Git fields

There are various ways to update a workload. Use flags to change workload fields. Use a YAML file with the required changes, and run the `tanzu apps workload apply` with the `--update-strategy` set as `replace`. For more information, see [Control Workload Merge Behavior](#).

To delete fields, set the `--git-*` flags as empty strings within the command. This removes the `workload.spec.source.git` fields.

For example, for a workload that includes specifications such as `--git-tag`, `--git-commit` or `--git-branch`, remove these by setting them as empty strings in the command as shown in the following example:

```
# existing workload definition
---
apiVersion: carto.run/v1alpha1
kind: Workload
metadata:
  labels:
    apps.tanzu.vmware.com/workload-type: web
  name: tanzu-java-web-app
  namespace: default
spec:
  source:
    git:
      ref:
        branch: main
        tag: tap-1.6.0
      url: https://github.com/vmware-tanzu/application-accelerator-samples
      subPath: tanzu-java-web-app
```

```
# Update the workload to remove one of its git fields
tanzu apps workload apply tanzu-java-web-app --git-branch ""
Update workload:
...
 9,  9  |spec:
10, 10  | source:
11, 11  |   git:
12, 12  |     ref:
13     - |       branch: main
14, 13  |       tag: tap-1.6.0
15, 14  |       url: https://github.com/vmware-tanzu/application-accelerator-samples
16, 15  |       subPath: tanzu-java-web-app
Really update the workload "tanzu-java-web-app"? [yN]: y
Updated workload "tanzu-java-web-app"

To see logs:  "tanzu apps workload tail tanzu-java-web-app --timestamp --since 1h"
To get status: "tanzu apps workload get tanzu-java-web-app"

# Export the workload to see that `spec.source.git.ref.tag` is not part of the definition
tanzu apps workload get tanzu-java-web-app --export
---
apiVersion: carto.run/v1alpha1
```

```

kind: Workload
metadata:
  labels:
    apps.tanzu.vmware.com/workload-type: web
  name: tanzu-java-web-app
  namespace: default
spec:
  source:
    git:
      ref:
        tag: tap-1.6.0
      url: https://github.com/vmware-tanzu/application-accelerator-samples
      subPath: tanzu-java-web-app

```



Note

If `--git-repo` is set to empty, then the whole Git section is removed from the workload definition.

```

tanzu apps workload apply tanzu-java-web-app --git-repo ""
Update workload:
...
 5, 5  | labels:
 6, 6  |   apps.tanzu.vmware.com/workload-type: web
 7, 7  |   name: tanzu-java-web-app
 8, 8  |   namespace: default
 9     - |spec:
10     - | source:
11     - |   git:
12     - |     ref:
13     - |       tag: tap-1.6.0
14     - |       url: https://github.com/vmware-tanzu/application-accelerator-samples
15     - |       subPath: tanzu-java-web-app
      9 + |spec: {}
NOTICE: no source code or image has been specified for this workload.
Really update the workload "tanzu-java-web-app"? [yN]: y
Updated workload "tanzu-java-web-app"

To see logs: "tanzu apps workload tail tanzu-java-web-app --timestamp --since 1h"
To get status: "tanzu apps workload get tanzu-java-web-app"

# Export the workload and check that the git source section does not exist
tanzu apps workload get tanzu-java-web-app --export
---
apiVersion: carto.run/v1alpha1
kind: Workload
metadata:
  labels:
    apps.tanzu.vmware.com/workload-type: web
  name: tanzu-java-web-app
  namespace: default
spec: {}

```

Subpath

Use the `--subpath` flag to create workloads within a repository, where the repository, such as a monorepo, consists of multiple folders or projects.

```

# The Git repository for this sample contains several applications, each on its own fo
lder
tanzu apps workload apply tanzu-where-for-dinner --git-repo https://github.com/vmware-

```

```
tanzu/application-accelerator-samples --git-branch main --sub-path where-for-dinner
Create workload:
 1 + |---
 2 + |apiVersion: carto.run/v1alpha1
 3 + |kind: Workload
 4 + |metadata:
 5 + |  labels:
 6 + |    apps.tanzu.vmware.com/workload-type: web
 7 + |    name: tanzu-where-for-dinner
 8 + |    namespace: default
 9 + |spec:
10 + |  source:
11 + |    git:
12 + |      ref:
13 + |        branch: main
14 + |      url: https://github.com/vmware-tanzu/application-accelerator-samples
15 + |      subPath: where-for-dinner
Do you want to create this workload? [yN]: y
Created workload "tanzu-where-for-dinner"

To see logs: "tanzu apps workload tail tanzu-where-for-dinner --timestamp --since 1
h"
To get status: "tanzu apps workload get tanzu-where-for-dinner"
```

Create a workload from Local Source

There are multiple ways to upload local source code to a Tanzu Application Platform cluster.

Using Local Source Proxy

Use Local Source Proxy to push local source code to the registry configured during Tanzu Application Platform installation.

For more information, see [Install Local Source Proxy](#). To create a workload that pushes to an already configured registry through Local Source Proxy, use `--local-path` flag without `--source-image`, like the following example:

```
# Point the local path flag to the folder containing the source code
tanzu apps workload create tanzu-java-web-app --local-path /path/to/java/app

The files and/ directories listed in the .tanzuignore file are being excluded from t
he uploaded source code.
Publishing source in "/path/to/java/app" to "local-source-proxy.tap-local-source-sys
tem.svc.cluster.local/source:default-tanzu-java-web-app"...
Published source

Create workload:
 1 + |---
 2 + |apiVersion: carto.run/v1alpha1
 3 + |kind: Workload
 4 + |metadata:
 5 + |  annotations:
 6 + |    local-source-proxy.apps.tanzu.vmware.com: registry.io/project/source:
default-tanzu-java-web-app@sha256:447db92e289dbe3a6969521917496ff2b6b0a1d6fbff1beec3
af726430ce8493
 7 + |  labels:
 8 + |    apps.tanzu.vmware.com/workload-type: web
 9 + |    name: tanzu-java-web-app
10 + |    namespace: default
11 + |spec:
12 + |  source:
13 + |    image: registry.io/project/source:default-tanzu-java-web-app@sha256:4
```

```
47db92e289dbe3a6969521917496ff2b6b0a1d6fbff1beec3af726430ce8493
```

```
Do you want to create this workload? [yN]:
```

A workload created using Local Source Proxy is easily recognizable because it has the `local-source-proxy.apps.tanzu.vmware.com` annotation with a value the same as the `spec.source.image` field.

Using Source Image

If the Local Source Proxy component is not installed, upload your local source code to a registry of your choice by passing in the `--source-image` flag. Use this flag to specify the registry path where the local source code is uploaded as an image.

Both the cluster and the developer's machine must be configured to properly provide credentials for accessing the container image registry where the local source code is published to. For more information about authentication requirements, see [Building from Local Source](#).

To create a workload using a source image, use `--local-path` flag with `--source-image`, like the following example:

```
tanzu apps workload create tanzu-java-web-app --local-path /path/to/java/app --source-image registry.io/path/to/project/image-name
```

The files and directories listed in the `.tanziignore` file are being excluded from the uploaded source code.

```
Publishing source in "." to "registry.io/path/to/project/image-name"...
```

```
Published source
```

```
Create workload:
```

```
1 + |---
2 + |apiVersion: carto.run/v1alpha1
3 + |kind: Workload
4 + |metadata:
5 + |  labels:
6 + |    apps.tanzu.vmware.com/workload-type: web
7 + |  name: tanzu-java-web-app
8 + |  namespace: default
9 + |spec:
10 + |  source:
11 + |    image: registry.io/path/to/project/image-name:latest@sha256:447db92e289dbe3a6969521917496ff2b6b0a1d6fbff1beec3af726430ce8493
Do you want to create this workload? [yN]:
```

--live-update

Use the `--live-update` flag to ensure that local source code changes are reflected quickly on the running workload. This is particularly valuable when iterating on features that require the workload to be deployed and running to validate.

Live update is ideally situated for running from within one of our supported IDE extensions, but it can also be utilized independently as shown in the following Spring Boot application example:

Spring Boot application example

Prerequisites: [Tilt](#) must be installed on the client.

1. Clone the repository by running:

```
git clone https://github.com/vmware-tanzu/application-accelerator-samples
```

2. Change into the `tanzu-java-web-app` directory.

3. In `Tiltfile`, first, change the `SOURCE_IMAGE` variable to use your registry and project.
4. At the very end of the file add:

```
allow_k8s_contexts('your-cluster-name')
```

5. Inside the directory, run:

```
tanzu apps workload apply tanzu-java-web-app --live-update --local-path . -s
gcr.io/PROJECT/tanzu-java-web-app-live-update -y
```

Expected output:

```
The files and directories listed in the .tanzuignore file are being excluded fr
om the uploaded source code.
Publishing source in "." to "gcr.io/PROJECT/tanzu-java-web-app-live-update"...
  Published source

Create workload:
 1 + |---
 2 + |apiVersion: carto.run/v1alpha1
 3 + |kind: Workload
 4 + |metadata:
 5 + |  name: tanzu-java-web-app
 6 + |  namespace: default
 7 + |spec:
 8 + |  params:
 9 + |    - name: live-update
10 + |      value: "true"
11 + |  source:
12 + |    image: gcr.io/PROJECT/tanzu-java-web-app-live-update:latest@sha256:
3c9fd738492a23ac532a709301fcf0c9aa2a8761b2b9347bdbab52ce9404264b
  Created workload "tanzu-java-web-app"

To see logs:  "tanzu apps workload tail tanzu-java-web-app --timestamp --since
1h"
To get status: "tanzu apps workload get tanzu-java-web-app"
```

6. Run Tilt to deploy the workload.

```
tilt up

Tilt started on http://localhost:10350/
v0.23.6, built 2022-01-14

(space) to open the browser
(s) to stream logs (--stream=true)
(t) to open legacy terminal mode (--legacy=true)
(ctrl-c) to exit
Tilt started on http://localhost:10350/
v0.23.6, built 2022-01-14

Initial Build • (Tiltfile)
Loading Tiltfile at: /path/to/repo/tanzu-java-web-app/Tiltfile
Successfully loaded Tiltfile (1.500809ms)
tanzu-java-w... |
tanzu-java-w... | Initial Build • tanzu-java-web-app
tanzu-java-w... | WARNING: Live Update failed with unexpected error:
tanzu-java-w... |   Cannot extract live updates on this build graph structure
tanzu-java-w... | Falling back to a full image build + deploy
tanzu-java-w... | STEP 1/1 - Deploying
tanzu-java-w... |   Objects applied to cluster:
tanzu-java-w... |     → tanzu-java-web-app:workload
```

```

tanzu-java-w... |
tanzu-java-w... |      Step 1 - 8.87s (Deploying)
tanzu-java-w... |      DONE IN: 8.87s
tanzu-java-w... |
tanzu-java-w... |
tanzu-java-w... | Tracking new pod rollout (tanzu-java-web-app-build-1-build-po
d):
tanzu-java-w... |      | Scheduled      - (...) Pending
tanzu-java-w... |      | Initialized    - (...) Pending
tanzu-java-w... |      | Ready          - (...) Pending
...

```

Subpath

For local source workloads, specify a subpath. A subpath points to a specific subfolder within the root folder.

```

# After cloning repo in https://github.com/vmware-tanzu/application-accelerator-sample
s and install Local Source Proxy

cd application-accelerator-samples
tanzu apps workload apply tanzu-java-web-app --local-path . --sub-path tanzu-java-web-
app
Publishing source in "." to "local-source-proxy.tap-local-source-system.svc.cluster.lo
cal/source:default-tanzu-java-web-app"...
  Published source

Create workload:
  1 + |---
  2 + |apiVersion: carto.run/v1alpha1
  3 + |kind: Workload
  4 + |metadata:
  5 + |  annotations:
  6 + |    local-source-proxy.apps.tanzu.vmware.com: gcr.io/tanzu-framework-playgr
ound/source:default-tanzu-java-web-app@sha256:e6ee774bc427273afb6dcf6388aca8edd83b83c7
2e4de00bf0cf8dfce72f8446
  7 + |  labels:
  8 + |    apps.tanzu.vmware.com/workload-type: web
  9 + |  name: tanzu-java-web-app
 10 + |  namespace: default
 11 + |spec:
 12 + |  source:
 13 + |    image: gcr.io/tanzu-framework-playground/source:default-tanzu-java-web-
app@sha256:e6ee774bc427273afb6dcf6388aca8edd83b83c72e4de00bf0cf8dfce72f8446
 14 + |    subPath: tanzu-java-web-app
Do you want to create this workload? [yN]: y
Created workload "tanzu-java-web-app"

To see logs:  "tanzu apps workload tail tanzu-java-web-app --timestamp --since 1h"
To get status: "tanzu apps workload get tanzu-java-web-app"

```

Create a workload from a pre-built image

Create a workload from an existing registry image by providing the reference to that image through the `--image` flag. The `supply chain` references the provided registry image when the workload is deployed.

For example:

```

tanzu apps workload create petclinic-image --image springcommunity/spring-framework-pe
tclinic
Create workload:
  1 + |---

```

```

2 + |apiVersion: carto.run/v1alpha1
3 + |kind: Workload
4 + |metadata:
5 + |  labels:
6 + |    apps.tanzu.vmware.com/workload-type: web
7 + |  name: petclinic-image
8 + |  namespace: default
9 + |spec:
10 + |  image: springcommunity/spring-framework-petclinic
Do you want to create this workload? [yN]:

```

For information about requirements for prebuilt images and how to configure prebuilt images in a supply chains, see [Use an existing image with Supply Chain Choreographer](#).

Create a workload from a Maven repository artifact

Create a workload from a Maven repository artifact by setting its properties through the `--maven-*` flags when using the [supply chain](#). For more information about the Maven repository artifact, see [Source-Controller](#).

The Maven repository URL is set when the supply chain is created.

To create a Maven workload using the CLI provided flags, run:

```

tanzu apps workload apply my-workload \
  --maven-artifact hello-world \
  --maven-type jar
  --maven-version 0.0.1 \
  --maven-group carto.run \
  --type web -y

```

For more information about the Maven flags, see the [Maven flags command reference information](#).

For information about how to configure the Maven artifact authentication credentials, see [Maven Repository Secret](#).

Create a workload from a Dockerfile

For any source-based supply chains, when you specify the new `dockerfile` parameter in a workload, the builds switch from using Kpack to using kaniko. Source-based supply chains are supply chains that don't take a pre-built image. kaniko is an open-source tool for building container images from a Dockerfile without running Docker inside a container. For more information, see [Dockerfile-based builds](#).

Get workload status

This topic tells you about the Tanzu Apps CLI commands you can use to get information about the status of a workload.

tanzu apps workload list

The `tanzu apps workload list` command gets a list of the workloads present in the cluster, either in the current namespace, in another namespace, or all namespaces.

Filter the list result by the `--namespace`, `--type` or `--app` flags. The `--output` flag supports the `yaml` and `json` formats.

-all-namespaces, -A flag

Show workloads in all namespaces in the cluster.

```
tanzu apps workload list -A
```

NAMESPACE	TYPE	NAME	APP	READY
AGE				
default	web	nginx4	<empty>	Ready
7d9h				
default	web	rmq-sample-app	<empty>	Ready
179m				
default	web	spring-pet-clinic	<empty>	Unknown
3h1m				
default	web	tanzu-java-web-app	tanzu-java-web-app	Ready
40m				
nginx-ns	web	nginx2	<empty>	TemplateRejectedByAPISer
ver	8d			

-app flag

Filter workloads by application. Shows workloads for the application specified in the command.

```
tanzu apps workload list --app spring-petclinic
```

NAME	TYPE	READY	AGE
spring-petclinic2	web	Unknown	29d
spring-petclinic3	web	Ready	29d

-namespace, -n flag

Filter workloads by namespace. Lists all the workloads present in the specified namespace.

```
tanzu apps workload list --namespace my-namespace
```

NAME	TYPE	APP	READY	AGE
app1	web	<empty>	TemplateRejectedByAPIServer	8d
app2	web	<empty>	Ready	8d
app3	web	<empty>	Unknown	8d

-output, -o flag

List all workloads in the specified namespace in [yaml](#), [yml](#) or [json](#) format.

- [yaml/yaml](#)

```
# shorthand for --output is -o
# alternatives are
# tanzu apps workload list -o yaml / -o json
# tanzu apps workload list -oyaml / -ojson
tanzu apps workload list --output yaml
```

```
---
- apiVersion: carto.run/v1alpha1
  kind: Workload
  metadata:
    creationTimestamp: "2022-05-17T22:06:49Z"
    generation: 1
    labels:
      app.kubernetes.io/part-of: tanzu-java-web-app
      apps.tanzu.vmware.com/workload-type: web
    managedFields:
      ...
      ...
    manager: cartographer
```



```

    operation: Update
    time: "2022-05-17T22:06:52Z"
name: tanzu-java-web-app2
namespace: default
resourceVersion: "6071972"
uid: 7fbcd40d-4eb3-41dc-a1db-657b64148708
spec:
  source:
    git:
      ref:
        tag: tap-1.3
        url: https://github.com/vmware-tanzu/application-accelerator-sample
s
      subPath: tanzu-java-web-app
...
...
---
- apiVersion: carto.run/v1alpha1
kind: Workload
metadata:
  creationTimestamp: "2022-05-17T22:06:49Z"
  generation: 1
  labels:
    app.kubernetes.io/part-of: tanzu-java-web-app
    apps.tanzu.vmware.com/workload-type: web
  managedFields:
    ...
    ...
  manager: cartographer
  operation: Update
  time: "2022-05-17T22:06:52Z"
name: tanzu-java-web-app
namespace: default
resourceVersion: "6071972"
uid: 7fbcd40d-4eb3-41dc-a1db-657b64148708
spec:
  source:
    git:
      ref:
        tag: tap-1.3
        url: https://github.com/vmware-tanzu/application-accelerator-sample
s
      subPath: tanzu-java-web-app
...
...

```

- json

```
tanzu apps workload list --output json
```

```
[
  {
    "kind": "Workload",
    "apiVersion": "carto.run/v1alpha1",
    "metadata": {
      "name": "tanzu-java-web-app2",
      "namespace": "default",
      "uid": "7fbcd40d-4eb3-41dc-a1db-657b64148708",
      "resourceVersion": "6071972",
      "generation": 1,
      "creationTimestamp": "2022-05-17T22:06:49Z",
      "labels": {
        "app.kubernetes.io/part-of": "tanzu-java-web-app",
        "apps.tanzu.vmware.com/workload-type": "web"
      }
    },

```

```

...
}
...
},
{
  "kind": "Workload",
  "apiVersion": "carto.run/v1alpha1",
  "metadata": {
    "name": "tanzu-java-web-app",
    "namespace": "default",
    "uid": "7fbcd40d-4eb3-41dc-a1db-657b64148708",
    "resourceVersion": "6071972",
    "generation": 1,
    "creationTimestamp": "2022-05-17T22:06:49Z",
    "labels": {
      "app.kubernetes.io/part-of": "tanzu-java-web-app",
      "apps.tanzu.vmware.com/workload-type": "web"
    },
    ...
  }
  ...
},
...
]

```

tanzu apps workload get

The `tanzu apps workload get` command provides detailed information and status about a workload. Filter workloads with the `--namespace` flag, which specifies the namespace where the workload is deployed.

There are multiple sections in the workload get command output. The following data is displayed:

- Name of the workload and its status.
- Displays source information of workload.
- If the workload was matched with a supply chain, the name of the supply chain is provided.
- A table providing the name, status, health, and resulting resource for each step defined in the supply chain or delivery for the workload.
- If there are any issues, such as errors or status messages associated with any of the steps defined by the supply chain or delivery for the workload, the name and corresponding message are included in the `Messages` section.
- Workload related resource information and status like services claims, related pods, and Knative services.

At the very end of the command output, a hint to follow up commands is also displayed.



Note

The `Supply Chain` and `Delivery` sections are included in the command output depending on whether those resources are present on the target cluster, for example, if the target includes only build components, there is no `Delivery` resources available and therefore the `Delivery` section is not included in the command output.

```

# --namespace flag shorthand is -n
# An alternative way to use this command is

```

```
# tanzu apps workload get tanzu-java-web-app -n development
tanzu apps workload get tanzu-java-web-app --namespace development

Overview
  name:      tanzu-java-web-app
  type:      web
  namespace: development

Source
  type:      git
  url:       https://github.com/vmware-tanzu/application-accelerator-samples
  tag:       tap-1.6.0
  sub-path:  tanzu-java-web-app
  revision:  tap-1.6.0/bb9e655b33e39b242b6e5d9e218578e75c1d833c

Supply Chain
  name:      source-to-url

NAME          READY   HEALTHY   UPDATED   RESOURCE
source-provider   True    True      31m       gitrepositories.source.toolkit.fluxcd.io/tanzu-java-web-app
image-provider   True    True      30m       images.kpack.io/tanzu-java-web-app
config-provider   True    True      30m       podintents.conventions.carto.run/tanzu-java-web-app
app-config       True    True      30m       configmaps/tanzu-java-web-app
service-bindings True    True      30m       configmaps/tanzu-java-web-app-with-claims
api-descriptors  True    True      30m       configmaps/tanzu-java-web-app-with-api-descriptors
config-writer     True    True      30m       runnables.carto.run/tanzu-java-web-app-config-writer

Delivery
  name:      delivery-basic

NAME          READY   HEALTHY   UPDATED   RESOURCE
source-provider   True    True      30m       imagerepositories.source.apps.tanzu.vmware.com/tanzu-java-web-app-delivery
deployer         True    True      30m       apps.kappctrl.k14s.io/tanzu-java-web-app

Messages
  No messages found.

Pods
NAME          READY   STATUS      RESTARTS   AGE
tanzu-java-web-app-build-11-build-pod  0/1     Completed   0           6d12h
tanzu-java-web-app-build-12-build-pod  0/1     Completed   0           22h
tanzu-java-web-app-build-3-build-pod   0/1     Completed   0           60d
tanzu-java-web-app-config-writer-655rb-pod  0/1     Completed   0           21d
tanzu-java-web-app-config-writer-7h8bn-pod  0/1     Completed   0           6d12h
tanzu-java-web-app-config-writer-7xr6m-pod  0/1     Completed   0           60d
tanzu-java-web-app-config-writer-g9gp8-pod  0/1     Completed   0           45d

Knative Services
NAME          READY   URL
tanzu-java-web-app  Ready   http://tanzu-java-web-app.default.127.0.0.1.nip.io

To see logs: "tanzu apps workload tail tanzu-java-web-app --namespace development --timestamp --since 1h"
```

tanzu apps workload tail

`tanzu apps workload tail` checks the runtime logs of a workload. The workload can be filtered by the namespace it was created on by using the `--namespace` flag, and the workload logs can also be filtered by a specific `--component`.

Use the `--since` flag to retrieve logs within a specific time-frame and display them with their `--timestamp`.

```
tanzu apps workload tail tanzu-java-web-app -n development --since 1h --component build --timestamp

tanzu-java-web-app-build-1-build-pod[prepare] 2023-06-15T10:45:13.236584161-05:00 Build reason(s): CONFIG
tanzu-java-web-app-build-1-build-pod[prepare] 2023-06-15T10:45:13.237805020-05:00 CONFIG:
tanzu-java-web-app-build-1-build-pod[prepare] 2023-06-15T10:45:13.237847016-05:00 + env:
tanzu-java-web-app-build-1-build-pod[prepare] 2023-06-15T10:45:13.237853995-05:00 + - name: BP_OCI_SOURCE
tanzu-java-web-app-build-1-build-pod[prepare] 2023-06-15T10:45:13.237857982-05:00 + value: tap-1.6.0/bb9e655b33e39b242b6e5d9e218578e75c1d833c
tanzu-java-web-app-build-1-build-pod[prepare] 2023-06-15T10:45:13.237861706-05:00 resources: {}
tanzu-java-web-app-build-1-build-pod[prepare] 2023-06-15T10:45:13.237864954-05:00 - source: {}
tanzu-java-web-app-build-1-build-pod[prepare] 2023-06-15T10:45:13.237868502-05:00 + source:
tanzu-java-web-app-build-1-build-pod[prepare] 2023-06-15T10:45:13.237871941-05:00 + blob:
tanzu-java-web-app-build-1-build-pod[prepare] 2023-06-15T10:45:13.237875932-05:00 + url: http://fluxcd-source-controller.flux-system.svc.cluster.local./gitrepository/default/tanzu-java-web-app/bb9e655b33e39b242b6e5d9e218578e75c1d833c.tar.gz
tanzu-java-web-app-build-1-build-pod[prepare] 2023-06-15T10:45:13.237880878-05:00 + subPath: tanzu-java-web-app
tanzu-java-web-app-build-1-build-pod[prepare] 2023-06-15T10:45:13.237884317-05:00 Loading registry credentials from service account secrets
tanzu-java-web-app-build-1-build-pod[prepare] 2023-06-15T10:45:13.238417749-05:00 Loading secret for "gcr.io" from secret "registry-credentials" at location "/var/build-secrets/registry-credentials"
tanzu-java-web-app-build-1-build-pod[prepare] 2023-06-15T10:45:13.238437378-05:00 Loading secret for "https://gcr.io/" from secret "registry-credentials" at location "/var/build-secrets/registry-credentials"
...
```

tail a workload while creating or applying a workload

You can tail a workload directly as part of the `tanzu apps workload create` or `tanzu apps workload apply` commands by providing the `--tail` flag and you can display timestamps for each log entry by including the `--tail-timestamp` flag.

```
tanzu apps workload apply tanzu-java-web-app --git-repo https://github.com/vmware-tanzu/application-accelerator-samples --git-tag tap-1.6.0 --sub-path tanzu-java-web-app --tail --tail-timestamp

Create workload:
 1 + |---
 2 + |apiVersion: carto.run/v1alpha1
 3 + |kind: Workload
 4 + |metadata:
 5 + |  labels:
 6 + |    apps.tanzu.vmware.com/workload-type: web
 7 + |  name: tanzu-java-web-app
 8 + |  namespace: default
 9 + |spec:
10 + |  source:
```

```

11 + |   git:
12 + |     ref:
13 + |       tag: tap-1.6.0
14 + |     url: https://github.com/vmware-tanzu/application-accelerator-samples
15 + |     subPath: tanzu-java-web-app
Do you want to create this workload? [yN]: y
Created workload "tanzu-java-web-app"

To see logs:   "tanzu apps workload tail tanzu-java-web-app --timestamp --since 1h"
To get status: "tanzu apps workload get tanzu-java-web-app"

Waiting for workload "tanzu-java-web-app" to become ready...
+ tanzu-java-web-app-build-1-build-pod > prepare
tanzu-java-web-app-build-1-build-pod[prepare] 2023-06-15T11:28:12.746812119-05:00 Build
d reason(s): CONFIG
tanzu-java-web-app-build-1-build-pod[prepare] 2023-06-15T11:28:12.747149910-05:00 CONF
IG:
tanzu-java-web-app-build-1-build-pod[prepare] 2023-06-15T11:28:12.747186215-05:00
+ env:
tanzu-java-web-app-build-1-build-pod[prepare] 2023-06-15T11:28:12.747194864-05:00
+ - name: BP_OCI_SOURCE
tanzu-java-web-app-build-1-build-pod[prepare] 2023-06-15T11:28:12.747201214-05:00
+   value: tap-1.6.0/bb9e655b33e39b242b6e5d9e218578e75c1d833c
tanzu-java-web-app-build-1-build-pod[prepare] 2023-06-15T11:28:12.747206421-05:00
resources: {}
tanzu-java-web-app-build-1-build-pod[prepare] 2023-06-15T11:28:12.747211761-05:00
- source: {}
tanzu-java-web-app-build-1-build-pod[prepare] 2023-06-15T11:28:12.747217114-05:00
+ source:
tanzu-java-web-app-build-1-build-pod[prepare] 2023-06-15T11:28:12.747222613-05:00
+   blob:
tanzu-java-web-app-build-1-build-pod[prepare] 2023-06-15T11:28:12.747228733-05:00
+     url: http://fluxcd-source-controller.flux-system.svc.cluster.local./gitrepositor
y/default/tanzu-java-web-app/bb9e655b33e39b242b6e5d9e218578e75c1d833c.tar.gz
tanzu-java-web-app-build-1-build-pod[prepare] 2023-06-15T11:28:12.747235497-05:00
+     subPath: tanzu-java-web-app
tanzu-java-web-app-build-1-build-pod[prepare] 2023-06-15T11:28:12.747240321-05:00 Load
ing registry credentials from service account secrets
tanzu-java-web-app-build-1-build-pod[prepare] 2023-06-15T11:28:12.747402066-05:00 Load
ing secret for "gcr.io" from secret "registry-credentials" at location "/var/build-sec
rets/registry-credentials"
tanzu-java-web-app-build-1-build-pod[prepare] 2023-06-15T11:28:12.747417620-05:00 Load
ing secret for "https://gcr.io/" from secret "registry-credentials" at location "/var/
build-secrets/registry-credentials"
...

```

–export flag

A clean workload definition export can be committed to GitHub or applied to a different environment without having to make significant edits because the export only includes the fields specified by the developer who created it.

By default, the `--export` flag is configured to display the workload in `yaml` format. However, the behavior can be modified by combining it with the `--output` flag, which accepts `yaml`, `yaml`, and `json` as values.

For example, if a workload is created with:

```
tanzu apps workload apply tanzu-where-for-dinner --git-repo https://github.com/vmware-tanzu/application-accelerator-samples --git-branch main --sub-path where-for-dinner
```

When querying the workload with `--export`, the default export format in `yaml` is as follows:

```
# with yaml format
tanzu apps workload get tanzu-where-for-dinner --export
```

```
---
apiVersion: carto.run/v1alpha1
kind: Workload
metadata:
  labels:
    apps.tanzu.vmware.com/workload-type: web
    name: tanzu-where-for-dinner
    namespace: default
spec:
  source:
    git:
      ref:
        branch: main
      url: https://github.com/vmware-tanzu/application-accelerator-samples
      subPath: where-for-dinner
```

```
# with json format
# shorthand for --output flag is -o
# an alternative for this command would be
# tanzu apps workload get rmq-sample-app --export -ojson
tanzu apps workload get rmq-sample-app --export --output json
```

```
{
  "apiVersion": "carto.run/v1alpha1",
  "kind": "Workload",
  "metadata": {
    "labels": {
      "apps.tanzu.vmware.com/workload-type": "web"
    },
    "name": "rmq-sample-app",
    "namespace": "default"
  },
  "spec": {
    "serviceClaims": [
      {
        "name": "rmq",
        "ref": {
          "apiVersion": "rabbitmq.com/v1beta1",
          "kind": "RabbitmqCluster",
          "name": "example-rabbitmq-cluster-1"
        }
      }
    ],
    "source": {
      "git": {
        "ref": {
          "branch": "main"
        },
        "url": "https://github.com/jhvhs/rabbitmq-sample"
      }
    }
  }
}
```

–output flag with `tanzu apps workload get` command

Use the `--output` flag with `tanzu apps workload get` to retrieve a workload with all the cluster-specifics.

```
# with json format
tanzu apps workload get rmq-sample-app --output json # can also be used as tanzu apps
workload get rmq-sample-app -ojson
```

```
{
  "kind": "Workload",
  "apiVersion": "carto.run/v1alpha1",
  "metadata": {
    "name": "rmq-sample-app",
    "namespace": "default",
    "uid": "3619ff6d-9e73-473a-9112-891a6d8aee9e",
    "resourceVersion": "11657434",
    "generation": 2,
    "creationTimestamp": "2022-11-28T05:10:32Z",
    "labels": {
      "apps.tanzu.vmware.com/workload-type": "web"
    },
    ...
  },
  ...
  "status": {
    "observedGeneration": 2,
    "conditions": [
      {
        "type": "SupplyChainReady",
        "status": "True",
        "lastTransitionTime": "2022-11-28T05:10:32Z",
        "reason": "Ready",
        "message": ""
      },
      ...
    ],
    "supplyChainRef": {
      "kind": "ClusterSupplyChain",
      "name": "source-to-url"
    },
    "resources": [
      {
        "name": "source-provider",
        "stampedRef": {
          "kind": "GitRepository",
          "namespace": "default",
          "name": "rmq-sample-app",
          "apiVersion": "source.toolkit.fluxcd.io/v1beta1",
          "resource": "gitrepositories.source.toolkit.fluxcd.io"
        },
        "templateRef": {
          "kind": "ClusterSourceTemplate",
          "name": "source-template",
          "apiVersion": "carto.run/v1alpha1"
        },
        ...
      }
    ],
    ...
  }
}
```

```
## with yaml format
tanzu apps workload get rmq-sample-app --output yaml # can also be used as tanzu apps
workload get rmq-sample-app -oyaml
```

```

---
apiVersion: carto.run/v1alpha1
kind: Workload
metadata:
  creationTimestamp: "2022-11-28T05:10:32Z"
  generation: 2
  labels:
    apps.tanzu.vmware.com/workload-type: web
  ...
  name: rmq-sample-app
  namespace: default
  resourceVersion: "11657434"
  uid: 3619ff6d-9e73-473a-9112-891a6d8aee9e
spec:
  serviceClaims:
  - name: rmq
    ref:
      apiVersion: rabbitmq.com/v1beta1
      kind: RabbitmqCluster
      name: example-rabbitmq-cluster-1
  source:
    git:
      ref:
        branch: main
      url: https://github.com/jhvhs/rabbitmq-sample
status:
  conditions:
  - lastTransitionTime: "2022-11-28T05:10:32Z"
    message: ""
    reason: Ready
    status: "True"
    type: SupplyChainReady
  ...
  observedGeneration: 2
  resources:
  ...
  name: source-provider
  outputs:
  - digest: sha256:97b2cb779b4ea31339595cd204a3fec0053805eeacbbd6d6dd23af7d3000a6ae
    lastTransitionTime: "2022-11-28T05:16:01Z"
    name: url
    preview: |
      http://fluxcd-source-controller.flux-system.svc.cluster.local./gitrepository/default/rmq-sample-app/73c6311eefbf724fee9ad6f4524fa24ec842ff34.tar.gz
  - digest: sha256:e7884b071felbbb2551d42a171043d061a7591e744705572136e689c2a154b7a
    lastTransitionTime: "2022-11-28T05:16:01Z"
    name: revision
    preview: |
      HEAD/73c6311eefbf724fee9ad6f4524fa24ec842ff34
  ...

```

-output flag with `tanzu apps workload apply` command

Use this flag to retrieve the workload in the `yaml`, `yml`, or `json` format after it is applied. When combined with the `--yes` flag, all prompts are bypassed, and only the workload definition is returned. Additionally, use the `--wait` or `--tail` flags, to retrieve the workload with its current status.

```

tanzu apps workload create tanzu-where-for-dinner --git-repo https://github.com/vmware-
-tanzu/application-accelerator-samples --git-branch main --sub-path where-for-dinner -
oyaml
Create workload:
1 + |---

```



```

2 + |apiVersion: carto.run/v1alpha1
3 + |kind: Workload
4 + |metadata:
5 + |  labels:
6 + |    apps.tanzu.vmware.com/workload-type: web
7 + |  name: tanzu-where-for-dinner
8 + |  namespace: default
9 + |spec:
10 + |  source:
11 + |    git:
12 + |      ref:
13 + |        branch: main
14 + |      url: https://github.com/vmware-tanzu/application-accelerator-samples
15 + |      subPath: where-for-dinner
Do you want to create this workload? [yN]: y
Created workload "tanzu-where-for-dinner"

```

To see logs: `"tanzu apps workload tail tanzu-where-for-dinner --timestamp --since 1 h"`

To get status: `"tanzu apps workload get tanzu-where-for-dinner"`

```

---
apiVersion: carto.run/v1alpha1
kind: Workload
metadata:
  creationTimestamp: "2023-07-06T17:22:34Z"
  generation: 1
  labels:
    apps.tanzu.vmware.com/workload-type: web
  name: tanzu-where-for-dinner
  namespace: default
  resourceVersion: "249375192"
  uid: 8a8132e5-9ee4-41f3-af92-9578ealefb01
spec:
  source:
    git:
      ref:
        branch: main
        url: https://github.com/vmware-tanzu/application-accelerator-samples
        subPath: where-for-dinner
status:
  supplyChainRef: {}

```

Using `--yes` flag with the command

```

tanzu apps workload create tanzu-where-for-dinner --git-repo https://github.com/vmware
-tanzu/application-accelerator-samples --git-branch main --sub-path where-for-dinner -
ojson -y
{
  "apiVersion": "carto.run/v1alpha1",
  "kind": "Workload",
  "metadata": {
    "creationTimestamp": "2023-07-06T18:03:07Z",
    "generation": 1,
    "labels": {
      "apps.tanzu.vmware.com/workload-type": "web"
    },
    "name": "tanzu-where-for-dinner",
    "namespace": "default",
    "resourceVersion": "249455362",
    "uid": "06a9793b-6747-4f9e-8455-6f5b342c3631"
  },
  "spec": {
    "source": {
      "git": {
        "ref": {

```

```

        "branch": "main"
      },
      "url": "https://github.com/vmware-tanzu/application-accelerator-sample
s"
    },
    "subPath": "where-for-dinner"
  }
},
"status": {
  "supplyChainRef": {}
}
}

```

Delete a workload

This topic tells you about the Tanzu Apps CLI `tanzu apps workload delete` command.

Use the `tanzu apps workload delete` command to remove one or more workloads from a specific namespace on the target cluster.



Note

This command does not automatically remove a workload's corresponding images from the registry.

To specify the workload for deletion, either provide the workload name and namespace or use a `yaml` file containing the workload definition.

To control the deletion process, use the `--wait` flag, which waits until the workload is deleted, or the `--wait-timeout` flag, which sets a specific timeout duration for the deletion process.

Delete all workloads in a namespace

Delete workloads all at once with the `--all` flag. If there is a particular namespace where all workloads should be deleted, use the `--namespace` flag to specify it.

```

# --namespace shorthand is -n
# an alternative for this same command is
# tanzu apps workload delete --all -n my-namespace
tanzu apps workload delete --all --namespace my-namespace
Really delete all workloads in the namespace "my-namespace"? Yes
Deleted workloads in namespace "my-namespace"

```

Apps CLI how-to-guides

The how-to-guides section contains the following topics:

- [Integrate with Local Source Proxy](#)
- [Manage workload merge behavior](#)

Integrate with Local Source Proxy

This topic tells you how to integrate the Tanzu Apps CLI with Local Source Proxy.

You can configure workloads to push local source code to a registry that is predefined using the Local Source Proxy component.

For more information about Local Source Proxy, see [Overview of Local Source Proxy](#) and [Create a workload from Local Source](#).

Check Local Source Proxy health

To check the installation and health of Local Source Proxy and determine if failures originate from the Local Source Proxy or the upstream registry, run:

```
tanzu apps local-source-proxy health
```

This returns an overview of the health of the Local Source Proxy. This information is obtained directly from the Local Source Proxy and provides a status code and message.

Use the `--output` flag to specify one of the following formats: `yaml`, `yaml`, and `json`. The default format is `yaml`.

The API is called at the `/health` endpoint, and there are five possible outputs based on the response received:

- All checks pass. Format is `yaml`.

```
user_has_permission: true
reachable: true
upstream_authenticated: true
overall_health: true
message: "All health checks passed"
```

- You do not have permission to list the service. The possible reason is a 403 error from the Kubernetes API Server. Format is `yaml`.

```
user_has_permission: false
reachable: false
upstream_authenticated: false
overall_health: false
message: "The current user does not have permission to access the local source proxy"
```

- You can list the services, but it's not there. The possible reason is a 404 error from the Kubernetes API Server. Format is `Source-Controller`

```
user_has_permission: true
reachable: false
upstream_authenticated: false
overall_health: false
message: "Local source proxy is not installed on the cluster"
```

- `/health` from Local Source Proxy returns a 5xx. Format is `yaml`.

```
user_has_permission: true
reachable: true
upstream_authenticated: false
overall_health: false
message: "Local source proxy is not healthy. Error: <error>"
```

- `/health` from upstream returns a non-2xx, 4xx, 5xx. `/health` from Local Source Proxy will still be 2xx. Format is `yaml`.

```
user_has_permission: true
reachable: true
upstream_authenticated: false
overall_health: false
```

```
message: "Local source proxy was unable to authenticate against the target registry. Error: <error>"
```

- All checks pass. Format is `json`.

```
{
  "user_has_permission": true
  "reachable": true
  "upstream_authenticated": true
  "overall_health": true
  "message": ""
}
```

Update the local source code for workloads

To create a workload from local source code, there are two options available:

1. Use Local Source Proxy, which automatically defaults to a predefined registry.
2. Use the `--source-image` flag to specify a registry. You must be authenticated to access the registry.

To distinguish whether a workload was created with the Local Source Proxy or the `--source-image` flag, check if the workload contains the `local-source-proxy.apps.tanzu.vmware.com` annotation. This annotation indicates the method used to create the workload.

For more information, see [Create a workload from Local Source](#).

Use the `--source-image` flag

After a workload is created using the `--source-image` flag, it is not possible to update it to use Local Source Proxy. However, you do not need to repeatedly specify the `--source-image` flag during subsequent updates, as it is retrieved from the existing workload specification within the cluster. If you do want to change the registry or storage location for the source code, specify the `--source-image` flag again with a new value.

```
# create a workload using source image
# inside the local source code folder
tanzu apps workload apply java-web-app --local-path . -s my-registry.io/my-project/java-app
a-app
The files and/or directories listed in the .tanzuignore file are being excluded from the
uploaded source code.
Publishing source in "." to "my-registry.io/my-project/java-app"...
Published source

Create workload:
 1 + |---
 2 + |apiVersion: carto.run/v1alpha1
 3 + |kind: Workload
 4 + |metadata:
 5 + |  labels:
 6 + |    apps.tanzu.vmware.com/workload-type: web
 7 + |  name: java-web-app
 8 + |  namespace: default
 9 + |spec:
10 + |  source:
11 + |    image: my-registry.io/my-project/java-app:latest@sha256:447db92e289dbe3
a6969521917496ff2b6b0a1d6fbff1beec3af726430ce8493
Do you want to create this workload? [yN]: y
Created workload "java-web-app"

To see logs:  "tanzu apps workload tail java-web-app --timestamp --since 1h"
To get status: "tanzu apps workload get java-web-app"
```

```
# update the workload and check the source image is not changed to use Local Source Proxy
tanzu apps workload apply java-web-app --label hello=world
Update workload:
...
 3, 3 |kind: Workload
 4, 4 |metadata:
 5, 5 | labels:
 6, 6 |   apps.tanzu.vmware.com/workload-type: web
 7 + |   hello: world
 7, 8 | name: java-web-app
 8, 9 | namespace: default
 9, 10 |spec:
10, 11 | source:
...
Really update the workload "java-web-app"? [yN]:
```

Switch from Local Source Proxy to `--source-image` flag

If a workload was initially created using the Local Source Proxy, it can be updated to use the `--source-image` flag. The workload transitions to use the specified source image. As a result, the annotation that establishes the connection between the workload and the Local Source Proxy is removed.

```
# inside the folder that contains the local source code
tanzu apps workload apply java-web-app --local-path .
The files and/or directories listed in the .tanuignore file are being excluded from the
uploaded source code.
Publishing source in "." to "local-source-proxy.tap-local-source-system.svc.cluster.local/source:default-java-web-app"...
Published source

Create workload:
 1 + |---
 2 + |apiVersion: carto.run/v1alpha1
 3 + |kind: Workload
 4 + |metadata:
 5 + | annotations:
 6 + |   local-source-proxy.apps.tanzu.vmware.com: my-registry.io/my-project/source:default-java-web-app@sha256:447db92e289dbe3a6969521917496ff2b6b0a1d6fbff1beec3af726430ce8493
 7 + | labels:
 8 + |   apps.tanzu.vmware.com/workload-type: web
 9 + | name: java-web-app
10 + | namespace: default
11 + |spec:
12 + | source:
13 + |   image: my-registry.io/my-project/source:default-java-web-app@sha256:447db92e289dbe3a6969521917496ff2b6b0a1d6fbff1beec3af726430ce8493
Do you want to create this workload? [yN]: y
Created workload "java-web-app"

To see logs: "tanzu apps workload tail java-web-app --timestamp --since 1h"
To get status: "tanzu apps workload get java-web-app"

# update to use a source image and see how the Local Source Proxy annotation is removed
# and the `spec.source.image` field also changes
tanzu apps workload apply java-web-app --local-path . -s my-registry.io/my-project/java-web-app
The files and/or directories listed in the .tanuignore file are being excluded from the
uploaded source code.
Publishing source in "." to "gcr.io/tanzu-framework-playground/java-web-app"...
```

```

37.58 kB / 37.16 kB [-----] 101.14%
-----]
31.94 kB p/s
Published source

Update workload:
1, 1 |---
2, 2 |apiVersion: carto.run/v1alpha1
3, 3 |kind: Workload
4, 4 |metadata:
5   - | annotations:
6   - |   local-source-proxy.apps.tanzu.vmware.com: my-registry.io/my-project/sou
rce:default-java-web-app@sha256:447db92e289dbe3a6969521917496ff2b6b0a1d6fbff1beec3af72
6430ce8493
7, 5 | labels:
8, 6 |   apps.tanzu.vmware.com/workload-type: web
9, 7 | name: java-web-app
10, 8 | namespace: default
11, 9 |spec:
12, 10 | source:
13   - |   image: my-registry.io/my-project/source:default-java-web-app@sha256:447
db92e289dbe3a6969521917496ff2b6b0a1d6fbff1beec3af726430ce8493
      11 + |   image: my-registry.io/my-project/java-web-app:latest@sha256:447db92e289
dbe3a6969521917496ff2b6b0a1d6fbff1beec3af726430ce8493
      Really update the workload "java-web-app"? [yN]:

```

Manage workload merge behavior

This topic tells you how to manage the workload update behavior with the Tanzu Apps CLI `--update-strategy` flag.

When updating a workload from a file, manage the workload update behavior with the `--update-strategy` flag. There are two possible values: `merge` or `replace`. The default value is `merge`.

merge

If the `--file workload.yaml` deletes an existing on-cluster property or value, it is not removed from the on-cluster definition. If the `--file workload.yaml` includes a new property or value, it is added to the on-cluster workload property value. If the `--file workload.yaml` updates an existing value for a property, it is updated on the on-cluster definition.

replace

The on-cluster workload is updated to exactly what is specified in the `--file workload.yaml` definition.

The current default merge strategy intents to prevent unintentional deletions of critical properties from existing workloads.



Note

The default value for the `--update-strategy` flag will change from `merge` to `replace` in Tanzu Application Platform v1.7.0.

Examples of the outcomes of both the `merge` and `replace` values:

```

# Export workload if there is no previous yaml definition
tanzu apps workload get spring-petclinic --export > spring-petclinic.yaml

```

```
# modify the workload definition
vi rmq-sample-app.yaml
---
apiVersion: carto.run/v1alpha1
kind: Workload
metadata:
  name: spring-petclinic
  labels:
    app.kubernetes.io/part-of: spring-petclinic
    apps.tanzu.vmware.com/workload-type: web
spec:
  resources:
    requests:
      memory: 1Gi
    limits:
      # delete this line
      memory: 1Gi # delete this line
      cpu: 500m # delete this line
  source:
    git:
      url: https://github.com/sample-accelerators/spring-petclinic
      ref:
        tag: tap-1.1
```

After saving the file, to verify how both of the update strategy options behave, run:

```
tanzu apps workload apply -f ./spring-petclinic.yaml --update-strategy merge # if flag
is not specified, merge is taken as default
```

This produces the following output:

```
WARNING: Configuration file update strategy is changing. By default, provided config
uration files
will replace rather than merge existing configuration. The change will take place in t
he January 2024
Tanzu Application Platform release (use "--update-strategy" to control strategy explic
itly).

Workload is unchanged, skipping update
```

By contrast, use `replace` as follows:

```
tanzu apps workload apply -f ./spring-petclinic.yaml --update-strategy replace
```

This produces the following output:

```
WARNING: Configuration file update strategy is changing. By default, provided config
uration files
will replace rather than merge existing configuration. The change will take place in t
he January 2024
Tanzu Application Platform release (use "--update-strategy" to control strategy explic
itly).

Update workload:
...
 8,  8 | name: spring-petclinic
 9,  9 | namespace: default
10, 10 | spec:
11, 11 |   resources:
12   - |     limits:
13   - |       cpu: 500m
14   - |       memory: 1Gi
15, 12 |     requests:
16, 13 |       memory: 1Gi
17, 14 |   source:
```

```
18, 15 | git:
...
Really update the workload "spring-petclinic"? [yN]:
```

The lines that were deleted in the `yaml` file are deleted as well in the workload running in the cluster. The only text boxes that remain exactly as they were created are the system populated metadata text boxes; `resourceVersion`, `uuid`, `generation`, `creationTimestamp`, and `deletionTimestamp`.

Troubleshoot Apps CLI plug-in

The troubleshooting section contains the following topics:

- [Troubleshooting workloads](#)
- [Troubleshooting local source proxy integration](#)

Troubleshoot workloads

This topic tells you how to use the Tanzu Apps CLI to troubleshoot workloads in Tanzu Application Platform (commonly known as TAP).

Check build logs

After a workload is created, tail the workload to view the build and runtime logs.

Run:

```
tanzu apps workload tail WORKLOAD --since 10m --timestamp
```

Where:

- `WORKLOAD` is the name of the workload.
- `--since` is optional. The amount of time to go back to begin streaming logs. The default is 1 second.
- `--timestamp` is optional. Prints the timestamp with each log entry.

Get the workload status and details

After the workload build process is complete, a Knative service can be created to run the workload. Workload details can be viewed at any time during the process. Some details, such as the workload URL, are only available after the workload is running.

Run:

```
tanzu apps workload get WORKLOAD
```

Where `WORKLOAD` is the name of the workload to be checked

Now the workload should be in a running state. When the workload is created, `tanzu apps workload get` includes the URL for the running workload. In some terminals, you can **Ctrl+click** the URL to view it. You can also copy the URL into a web browser to see the application.

Common workload errors

A workload can either be ready, be in an error state, or have an unknown status.

There are known errors that cause the workload to enter an error or unknown status. Look at the supply chain or delivery steps for status and review the messages section for clues when the workload appears to be having issues.

Local Path Development Error Cases

The section describes the cause and resolution for some of the most common issues.

Message: Writing `registry/project/repo/workload:latest`: Writing image: Unexpected status code `401 Unauthorized` (HEAD responses have no body, use GET for details)

Cause: Apps plug-in cannot talk to the registry because the registry credentials are missing or invalid.

Resolution: Run `docker logout registry` and `docker login registry` commands and specify the valid credentials for the registry.

Message: Writing `registry/project/workload:latest`: Writing image: HEAD Unexpected status code `400 Bad Request` (HEAD responses have no body, use GET for details)

Cause: Certain registries like Harbor or GCR have a concept of `Project`. A 400 Bad request is sent when either the project does not exist, the user does not have access to it, or the path in the `--source-image` flag is missing either project or repository.

Resolution: Fix the path in the `--source-image` flag value to point to a valid repository path.

WorkloadLabelsMissing/SupplyChainNotFound

Message: No supply chain found where full selector is satisfied by `labels: map[app.kubernetes.io/part-of:spring-petclinic]`.

Cause: The labels and attributes in the workload object did not fully satisfy any installed supply chain on the cluster.

Resolution: Use the `tanzu apps cluster-supply-chain list` (alias `csc`) and `tanzu apps csc get <supply-chain-name>` commands to see the workload selection criteria for the supply chain available on the cluster. Apply any missing labels to a workload by using `tanzu apps workload apply --label required-label-name=required-label-value`. For example:

```
tanzu apps workload apply workload-name --type web
# or
tanzu apps workload apply workload-name --label apps.tanzu.vmware.com/workload-type=web
```

MissingValueAtPath

Message: Waiting to read value `[.status.artifact.url]` from resource `gitrepository.source.toolkit.fluxcd.io` in namespace `[ns]`

Possible Cause 1: The Git `url/tag/branch/commit` parameters passed in the workload are not valid.

Resolution 1: Fix the invalid Git parameters by using `tanzu apps workload apply`.

Possible Cause 2: The Git repository is not accessible from the cluster.

Resolution 2: Configure the cluster networking or the Git repository networking so that they can communicate with each other.

Possible Cause 3: The namespace is missing the Git secret for communicating with the private repository.

Resolution 3: For more information, see [Git authentication](#).

TemplateRejectedByAPIServer

Message: Unable to apply object [ns/workload-name] for resource [source-provider] in supply chain [source-to-url]: failed to get unstructured [ns/workload-name] from API server: imagerepositories.source.apps.tanzu.vmware.com “workload-name” is forbidden: User “system:serviceaccount:ns:default” cannot get resource “imagerepositories” in API group “source.apps.tanzu.vmware.com” in the namespace “ns”

Cause: This error happens when the service account in the workload object does not have permission to create objects that are stamped out by the supply chain.

Resolution: Set up the Set up developer namespaces to use your installed packages with the required service account and permissions. For more information, see [Developer namespace setup for Supply Chain Security Tools - Store](#).

Review supply chain steps

After a workload is created with the `tanzu apps workload create` or `tanzu apps workload apply` command, run the `tanzu apps workload get` command to display the current condition of each supply chain.

For example:

```
...
Supply Chain
  name:  source-to-url

  NAME          READY  HEALTHY  UPDATED  RESOURCE
  source-provider  True   True     71m      gitrepositories.source.toolkit.fluxc
d.io/spring-petclinic
  image-provider  True   True     70m      images.kpack.io/spring-petclinic
  config-provider  True   True     69m      podintents.conventions.carto.run/spr
ing-petclinic
  app-config      True   True     69m      configmaps/spring-petclinic
  service-bindings  True   True     69m      configmaps/spring-petclinic-with-cla
ims
  api-descriptors  True   True     69m      configmaps/spring-petclinic-with-api
-descriptors
  config-writer    True   True     69m      runnables.carto.run/spring-petclinic
-config-writer

Delivery
  name:  delivery-basic

  NAME          READY  HEALTHY  UPDATED  RESOURCE
  source-provider  True   True     69m      imagerepositories.source.apps.tanzu.v
mware.com/spring-petclinic-delivery
  deployer        True   True     69m      apps.kappctrl.k14s.io/spring-petclini
c

Messages
  No messages found.
...
```

The `Supply Chain` section displays the supply chain steps associated with the workload. If a step fails, the `READY` column value is `Unknown` or `False`, and the `HEALTHY` column value is `False`. If a resource is in the `Unknown` or `False` status, inspect it with:

```
kubectl describe RESOURCE-NAME
```

Where `RESOURCE-NAME` is the name of the stamped out resource, displayed in the `RESOURCE` column.

For example, if `tanzu apps workload get` command returns this resource:

```

NAME                READY   HEALTHY   UPDATED   RESOURCE
source-provider    False   False     3h12m    gitrepositories.source.toolkit.fluxcd.io/spring-petclinic

```

The resource can be checked with:

```
kubectl describe gitrepositories.source.toolkit.fluxcd.io/spring-petclinic
```

The `Messages` section might give a hint about what went wrong in the process. For example, a message similar to the following is shown:

```

Messages
Workload [HealthyConditionRule]: failed to checkout and determine revision: failed to resolve commit object for '425ae9a2a2f84d195a9f3862668e8b2abf81418a': object not found

```

This might mean that the commit does not belong to the specified branch or does not exist in the repository.

Additional Troubleshooting References

For more workload troubleshooting tips, see [Troubleshoot using Tanzu Application Platform page](#).

Troubleshooting Local Source Proxy integration

This topic tells you how to troubleshoot the Tanzu Apps CLI plug-in integration with Local Source Proxy.

Use the following topics to troubleshoot the Local Source Proxy integration:

[Integrate with Local Source Proxy](#)

[Troubleshoot Local Source Proxy](#)

Tanzu Apps CLI reference

The reference section contains the following topics:

- [Dependency matrix for the different versions of Apps CLI Plug-in](#)
- [tanzu apps clustersupplychain](#) sub-commands and details.
- `tanzu apps workload` sub-commands and flags usage for each:
 - [tanzu apps workload get](#)
 - [tanzu apps workload list](#)
 - [tanzu apps workload tail](#)
 - [tanzu apps workload delete](#)
 - [tanzu apps workload create and apply](#)

Tanzu Apps CLI plug-in dependency matrix

This topic tells you what versions of the Tanzu Apps CLI are supported in Tanzu Application Platform (commonly known as TAP).

Tanzu Application Platform Version	Apps CLI Version	Required Cartographer Version
v1.3.x	v0.9.x	v0.5.x or later
v1.4.x	v0.10.x	v0.6.x or later
v1.5.x	v0.11.x	v0.7.x or later
v1.6.x	v0.12.x	v0.7.x or later

Check Cartographer version

To see the Cartographer version installed in the cluster, run:

```
kubectl get -n tap-install packageinstalls.packaging.carvel.dev cartographer
```

tanzu apps cluster-supply-chain

This topic tells you about the Tanzu Apps CLI `cluster-supply-chain` command.

tanzu apps clustersupplychain list

The `cluster-supply-chain` command provides details about the cluster supply chain installed in the target cluster.

The following aliases are supported:

- `csc`
- `cluster-supply-chains`
- `clustersupplychains`

Run the following command to view more detailed information about the selectors and conditions that must be met for a workload to be selected by a certain supply chain:

```
tanzu apps cluster-supply-chain get SUPPLYCHAIN-NAME
```

Default view

The default view displays the name of the supply chain, whether it is ready or not, and its age.

For example:

```
tanzu apps clustersupplychain list
NAME                READY  AGE
basic-image-to-url  Ready  11d
source-to-url       Ready  11d

To view details: "tanzu apps cluster-supply-chain get <name>"
```

tanzu apps cluster-supply-chain get

The `tanzu apps cluster-supply-chain get` command gets detailed information about the cluster supply chain.

Default view

The default view displays the status of the supply chain, and the selectors that a workload must match so it is taken by that supply chain.

For example:

```
tanzu apps cluster-supply-chain get source-to-url
---
# source-to-url: Ready
---
Supply Chain Selectors
  TYPE          KEY                                OPERATOR  VALUE
  expressions   apps.tanzu.vmware.com/workload-type  In        web
  expressions   apps.tanzu.vmware.com/workload-type  In        server
  expressions   apps.tanzu.vmware.com/workload-type  In        worker
```

This output indicates the attributes a workload needs to be selected by the `source-to-url` supply chain on the target cluster. For example:

- The workload must have the `--type` flag value of `web`, `server`, or `worker`.
- Or, if expressed through `workload.yaml`, the `Workload.metadata.labels` label `apps.tanzu.vmware.com/workload-type` must exist and have a value of `web`, `server`, or `worker`.

Another example is the `testing/scanning` pipeline, which has the `tekton` steps for testing and the scanning steps.

```
---
# source-test-scan-to-url: Ready
---
Supply Chain Selectors
  TYPE          KEY                                OPERATOR  VALUE
  labels        apps.tanzu.vmware.com/has-tests      true
  expressions   apps.tanzu.vmware.com/workload-type  In        web
  expressions   apps.tanzu.vmware.com/workload-type  In        server
  expressions   apps.tanzu.vmware.com/workload-type  In        worker
```

In this case, the workload must have both labels `apps.tanzu.vmware.com/has-tests: true` and `apps.tanzu.vmware.com/workload-type` set up as `web`, `server`, or `worker` to be selected for the supply chain.

tanzu apps workload apply

This topic tells you about the Tanzu Apps CLI `tanzu apps workload apply` command.

Use the `tanzu apps workload apply` command to create and update workloads that are deployed in a cluster through a supply chain.

The `tanzu apps workload apply` and `tanzu apps workload create` commands have the same behavior and flags with the following exceptions:

- The `tanzu apps workload create` command fails if a workload with the same name preexists on the target cluster.
- The `--update-strategy` flag is only supported by `tanzu apps workload apply` because `tanzu apps workload create` doesn't support updating existing workloads.

Default view

In the output of the `tanzu apps workload apply` command, the specification for the workload is shown in YAML file format.

Example

```
tanzu apps workload apply tanzu-java-web-app --git-repo https://github.com/vmware-tanzu/application-accelerator-samples --sub-path tanzu-java-web-app --git-tag tap-1.6.13 -type web
Create workload:
 1 + |---
 2 + |apiVersion: carto.run/v1alpha1
 3 + |kind: Workload
 4 + |metadata:
 5 + |  labels:
 6 + |    apps.tanzu.vmware.com/workload-type: web
 7 + |  name: tanzu-java-web-app
 8 + |  namespace: default
 9 + |spec:
10 + |  source:
11 + |    git:
12 + |      ref:
13 + |        tag: tap-1.6.13
14 + |      url: https://github.com/vmware-tanzu/application-accelerator-samples
15 + |      subPath: tanzu-java-web-app
Do you want to create this workload? [yN]:
Created workload "tanzu-java-web-app"

To see logs: "tanzu apps workload tail tanzu-java-web-app --timestamp --since 1h"
To get status: "tanzu apps workload get tanzu-java-web-app"
```

In the first section, the definition of workload is displayed. It's followed by a dialog box asking whether the workload should be created or updated. In the last section, if a workload is created or updated, some hints are displayed about the next steps.

Workload Apply flags

--annotation

Sets the annotations to be applied to the workload. To specify more than one annotation set the flag multiple times. These annotations are passed as parameters to be processed in the supply chain.

Example

```
tanzu apps workload apply tanzu-java-web-app --git-repo https://github.com/vmware-tanzu/application-accelerator-samples --sub-path tanzu-java-web-app --git-tag tap-1.6.13 -type web --annotation tag=tap-1.6.13 --annotation name="Tanzu Java Web"
Create workload:
 1 + |---
 2 + |apiVersion: carto.run/v1alpha1
 3 + |kind: Workload
 4 + |metadata:
 5 + |  labels:
 6 + |    apps.tanzu.vmware.com/workload-type: web
 7 + |  name: tanzu-java-web-app
 8 + |  namespace: default
 9 + |spec:
10 + |  params:
11 + |    - name: annotations
12 + |      value:
13 + |        name: Tanzu Java Web
14 + |        tag: tap-1.6.13
15 + |  source:
16 + |    git:
17 + |      ref:
18 + |        tag: tap-1.6.13
```

```
19 + |      url: https://github.com/vmware-tanzu/application-accelerator-samples
20 + |      subPath: tanzu-java-web-app
```

To delete an annotation, use `-` after its name.

Example

```
tanzu apps workload apply tanzu-java-web-app --annotation tag-
Update workload:
...
10, 10 |   params:
11, 11 |   - name: annotations
12, 12 |     value:
13, 13 |       name: Tanzu Java Web
14   - |       tag: tap-1.6.13
15, 14 |   source:
16, 15 |     git:
17, 16 |       ref:
18, 17 |       tag: tap-1.6.13
...
Really update the workload "tanzu-java-web-app"? [yN]:
```

`--app / -a`

This is the application the workload is part of. This is part of the workload metadata section.

Example

```
tanzu apps workload apply tanzu-app --git-repo https://github.com/vmware-tanzu/applica
tion-accelerator-samples --sub-path tanzu-java-web-app --git-tag tap-1.6.13 --type web
--app tanzu-java-web-app

Create workload:
 1 + |---
 2 + |apiVersion: carto.run/v1alpha1
 3 + |kind: Workload
 4 + |metadata:
 5 + |  labels:
 6 + |    app.kubernetes.io/part-of: tanzu-java-web-app
 7 + |    apps.tanzu.vmware.com/workload-type: web
 8 + |  name: tanzu-app
 9 + |  namespace: default
10 + |spec:
11 + |  source:
12 + |    git:
13 + |      ref:
14 + |        tag: tap-1.6.13
15 + |      url: https://github.com/vmware-tanzu/application-accelerator-samples
16 + |      subPath: tanzu-java-web-app
Do you want to create this workload? [yN]:
Created workload "tanzu-app"

To see logs:  "tanzu apps workload tail tanzu-app --timestamp --since 1h"
To get status: "tanzu apps workload get tanzu-app"
```

`--build-env`

Sets environment variables to use in the build phase by the build resources in the supply chain.

Example

```
tanzu apps workload apply tanzu-java-web-app --git-repo https://github.com/vmware-tanz
u/application-accelerator-samples --sub-path tanzu-java-web-app --git-tag tap-1.6.13 -
-type web --build-env JAVA_VERSION=1.8
```

```

Create workload:
 1 + |---
 2 + |apiVersion: carto.run/v1alpha1
 3 + |kind: Workload
 4 + |metadata:
 5 + |  labels:
 6 + |    apps.tanzu.vmware.com/workload-type: web
 7 + |  name: tanzu-java-web-app
 8 + |  namespace: default
 9 + |spec:
10 + |  build:
11 + |    env:
12 + |      - name: JAVA_VERSION
13 + |        value: "1.8"
14 + |  source:
15 + |    git:
16 + |      ref:
17 + |        tag: tap-1.6.13
18 + |      url: https://github.com/vmware-tanzu/application-accelerator-samples
19 + |      subPath: tanzu-java-web-app
Do you want to create this workload? [yN]:

```

To delete a build environment variable, use `-` after its name.

Example

```

tanzu apps workload apply tanzu-java-web-app --build-env JAVA_VERSION-
Update workload:
...
 6, 6 |    apps.tanzu.vmware.com/workload-type: web
 7, 7 |  name: tanzu-java-web-app
 8, 8 |  namespace: default
 9, 9 |spec:
10   - |  build:
11   - |    env:
12   - |      - name: JAVA_VERSION
13   - |        value: "1.8"
14, 10 |  source:
15, 11 |    git:
16, 12 |      ref:
17, 13 |        tag: tap-1.6.13
...
Really update the workload "tanzu-java-web-app"? [yN]:

```

`--debug`

Sets the parameter variable `debug` to true in the workload.

Example

```

tanzu apps workload apply tanzu-java-web-app --git-repo https://github.com/vmware-tanzu/application-accelerator-samples --sub-path tanzu-java-web-app --git-branch main --type web --debug
Create workload:
 1 + |---
 2 + |apiVersion: carto.run/v1alpha1
 3 + |kind: Workload
 4 + |metadata:
 5 + |  labels:
 6 + |    apps.tanzu.vmware.com/workload-type: web
 7 + |  name: tanzu-java-web-app
 8 + |  namespace: default
 9 + |spec:
10 + |  params:
11 + |    - name: debug

```



```

12 + |     value: "true"
13 + |   source:
14 + |     git:
15 + |       ref:
16 + |         branch: main
17 + |       url: https://github.com/vmware-tanzu/application-accelerator-samples
18 + |       subPath: tanzu-java-web-app
Do you want to create this workload? [yN]:

```

--dry-run

Prepares all the steps to submit the workload to the cluster and stops before sending it, showing an output of the final structure of the workload.

Example

```

tanzu apps workload apply tanzu-java-web-app --git-repo https://github.com/vmware-tanzu/application-accelerator-samples --sub-path tanzu-java-web-app --git-tag tap-1.6.13 --type web --build-env JAVA_VERSION=1.8 --param-yaml server='port: 8080\nmanagement-port: 8181' --dry-run
---
apiVersion: carto.run/v1alpha1
kind: Workload
metadata:
  creationTimestamp: null
  labels:
    apps.tanzu.vmware.com/workload-type: web
  name: tanzu-java-web-app
  namespace: default
spec:
  build:
    env:
      - name: JAVA_VERSION
        value: "1.8"
    params:
      - name: server
        value:
          management-port: 8181
          port: 8080
  source:
    git:
      ref:
        tag: tap-1.6.13
      url: https://github.com/vmware-tanzu/application-accelerator-samples
      subPath: tanzu-java-web-app
status:
  supplyChainRef: {}

```

--env / -e

Sets the environment variables to the workload so the supply chain resources can use it to deploy the workload application.

Example

```

tanzu apps workload apply tanzu-java-web-app --git-repo https://github.com/vmware-tanzu/application-accelerator-samples --sub-path tanzu-java-web-app --git-tag tap-1.6.13 --type web --env NAME="Tanzu Java App"
Create workload:
1 + |---
2 + |apiVersion: carto.run/v1alpha1
3 + |kind: Workload
4 + |metadata:
5 + |  labels:

```

```

6 + | apps.tanzu.vmware.com/workload-type: web
7 + | name: tanzu-java-web-app
8 + | namespace: default
9 + |spec:
10 + | env:
11 + | - name: NAME
12 + |   value: Tanzu Java App
13 + | source:
14 + |   git:
15 + |     ref:
16 + |       tag: tap-1.6.13
17 + |     url: https://github.com/vmware-tanzu/application-accelerator-samples
18 + |     subPath: tanzu-java-web-app
Do you want to create this workload? [yN]:

```

To unset an environment variable, use `-` after its name.

```

tanzu apps workload apply tanzu-java-web-app --env NAME-
Update workload:
...
6, 6 | apps.tanzu.vmware.com/workload-type: web
7, 7 | name: tanzu-java-web-app
8, 8 | namespace: default
9, 9 |spec:
10 - | env:
11 - | - name: NAME
12 - |   value: Tanzu Java App
13, 10 | source:
14, 11 |   git:
15, 12 |     ref:
16, 13 |       tag: tap-1.6.13
...
Really update the workload "tanzu-java-web-app"? [yN]:

```

`--file, -f`

Sets the workload specification file to create the workload. This comes from any other workload specification passed by flags to the command set or overrides what is in the file. Another way to use this flag is by using `-` in the command to receive workload definition through stdin.

For an example, see [Create a workload from a `workload.yaml` file or from a URL](#).

```

tanzu apps workload apply tanzu-java-web-app -f java-app-workload.yaml --param-yaml se
rver=${port: 9090\nmanagement-port: 9190}
Create workload:
1 + |---
2 + |apiVersion: carto.run/v1alpha1
3 + |kind: Workload
4 + |metadata:
5 + |  labels:
6 + |    apps.tanzu.vmware.com/workload-type: web
7 + |    name: tanzu-java-web-app
8 + |    namespace: default
9 + |spec:
10 + |  build:
11 + |    env:
12 + |      - name: JAVA_VERSION
13 + |        value: "1.8"
14 + |    params:
15 + |      - name: server
16 + |        value:
17 + |          management-port: 9190
18 + |          port: 9090
19 + |    source:

```

```

20 + |   git:
21 + |     ref:
22 + |       tag: tap-1.6.13
23 + |     url: url: https://github.com/vmware-tanzu/application-accelerator-sa
mples
24 + |     subPath: tanzu-java-web-app
Do you want to create this workload? [yN]:

```

--git-repo

The Git repository from which the workload is created. Specify one or more of the following: `--git-tag`, `--git-commit`, or `--git-branch`. If you set this flag to an empty string, the whole `spec.source.git` section is removed from workload definition.

For Git source, if all the flags are specified, `--git-tag`, `--git-commit`, and `--git-branch`, the revision to which the workload checkouts depends on the source controller.

--git-branch

The branch in a Git repository from where the workload is created. You can specify `--git-commit` and `--git-tag` with this flag. To unset, define as an empty string when applying a workload: `--git-branch ""`.

Example

```

tanzu apps workload apply tanzu-java-web-app --git-repo https://github.com/vmware-tanzu/application-accelerator-samples --sub-path tanzu-java-web-app --git-branch main --type web
Create workload:
1 + |---
2 + |apiVersion: carto.run/v1alpha1
3 + |kind: Workload
4 + |metadata:
5 + |  labels:
6 + |    apps.tanzu.vmware.com/workload-type: web
7 + |  name: tanzu-java-web-app
8 + |  namespace: default
9 + |spec:
10 + |  source:
11 + |    git:
12 + |      ref:
13 + |        branch: main
14 + |      url: https://github.com/vmware-tanzu/application-accelerator-samples
15 + |      subPath: tanzu-java-web-app
Do you want to create this workload? [yN]:

```

--git-tag

The tag in a Git repository from which the workload is created. To unset, define as an empty string when applying a workload: `--git-tag ""`.

--git-commit

Commit in Git repository from where the workload is resolved. Either `--git-branch` or `--git-tag` can be specified with it too. To unset, define as an empty string when applying a workload: `--git-commit ""`.

Example

```

tanzu apps workload apply tanzu-java-web-app --git-repo https://github.com/vmware-tanzu/application-accelerator-samples --sub-path tanzu-java-web-app --git-commit 1c4cf82e4

```

```

99f7e46da182922d4097908d4817320 --type web
Create workload:
 1 + |---
 2 + |apiVersion: carto.run/v1alpha1
 3 + |kind: Workload
 4 + |metadata:
 5 + |  labels:
 6 + |    apps.tanzu.vmware.com/workload-type: web
 7 + |  name: tanzu-java-web-app
 8 + |  namespace: default
 9 + |spec:
10 + |  source:
11 + |    git:
12 + |      ref:
13 + |        commit: 1c4cf82e499f7e46da182922d4097908d4817320
14 + |        url: https://github.com/vmware-tanzu/application-accelerator-samples
15 + |        subPath: tanzu-java-web-app
Do you want to create this workload? [yN]:

```

--image / -i

Sets the OSI image to be used as the workload application source instead of a Git repository

Example

```

tanzu apps workload apply tanzu-java-web-app --image private.repo.domain.com/tanzu-jav
a-web-app --type web
Create workload:
 1 + |---
 2 + |apiVersion: carto.run/v1alpha1
 3 + |kind: Workload
 4 + |metadata:
 5 + |  labels:
 6 + |    apps.tanzu.vmware.com/workload-type: web
 7 + |  name: tanzu-java-web-app
 8 + |  namespace: default
 9 + |spec:
10 + |  image: private.repo.domain.com/tanzu-java-web-app
Do you want to create this workload? [yN]:

```

--label / -l

Sets the label to be applied to the workload. To specify more than one label, set the flag multiple times.

Example

```

tanzu apps workload apply tanzu-java-web-app --git-repo https://github.com/vmware-tanz
u/application-accelerator-samples --sub-path tanzu-java-web-app --git-branch main --ty
pe web --label stage=production
Create workload:
 1 + |---
 2 + |apiVersion: carto.run/v1alpha1
 3 + |kind: Workload
 4 + |metadata:
 5 + |  labels:
 6 + |    apps.tanzu.vmware.com/workload-type: web
 7 + |    stage: production
 8 + |  name: tanzu-java-web-app
 9 + |  namespace: default
10 + |spec:
11 + |  source:
12 + |    git:
13 + |      ref:

```

```

14 + |         branch: main
15 + |         url: https://github.com/vmware-tanzu/application-accelerator-samples
16 + |         subPath: tanzu-java-web-app
Do you want to create this workload? [yN]:

```

To unset labels, use `-` after their name.

Example

```

tanzu apps workload apply tanzu-java-web-app --label stage-
Update workload:
...
3, 3 | kind: Workload
4, 4 | metadata:
5, 5 | labels:
6, 6 |   apps.tanzu.vmware.com/workload-type: web
7   - |   stage: production
8, 7 | name: tanzu-java-web-app
9, 8 | namespace: default
10, 9 | spec:
11, 10 | source:
...
Really update the workload "tanzu-java-web-app"? [yN]:

```

`--limit-cpu`

The maximum CPU the workload pods are allowed to use.

Example

```

tanzu apps workload apply tanzu-java-web-app --git-repo https://github.com/vmware-tanzu/application-accelerator-samples --sub-path tanzu-java-web-app --git-branch main --type web --limit-cpu .2
Create workload:
1 + |---
2 + |apiVersion: carto.run/v1alpha1
3 + |kind: Workload
4 + |metadata:
5 + | labels:
6 + |   apps.tanzu.vmware.com/workload-type: web
7 + | name: tanzu-java-web-app
8 + | namespace: default
9 + | spec:
10 + | resources:
11 + |   limits:
12 + |     cpu: 200m
13 + | source:
14 + |   git:
15 + |     ref:
16 + |       branch: main
17 + |       url: https://github.com/vmware-tanzu/application-accelerator-samples
18 + |       subPath: tanzu-java-web-app
Do you want to create this workload? [yN]:

```

`--limit-memory`

The maximum memory the workload pods are allowed to use.

Example

```

tanzu apps workload apply tanzu-java-web-app --git-repo https://github.com/vmware-tanzu/application-accelerator-samples --sub-path tanzu-java-web-app --git-branch main --type web --limit-memory 200Mi
Create workload:

```

```

1 + |---
2 + |apiVersion: carto.run/v1alpha1
3 + |kind: Workload
4 + |metadata:
5 + |  labels:
6 + |    apps.tanzu.vmware.com/workload-type: web
7 + |  name: tanzu-java-web-app
8 + |  namespace: default
9 + |spec:
10 + |  resources:
11 + |    limits:
12 + |      memory: 200Mi
13 + |  source:
14 + |    git:
15 + |      ref:
16 + |        branch: main
17 + |      url: https://github.com/vmware-tanzu/application-accelerator-samples
18 + |      subPath: tanzu-java-web-app
Do you want to create this workload? [yN]:

```

--live-update

Enable this to deploy the workload once, save changes to the code, and see those changes reflected in the workload running on the cluster.

Example

An example with a Spring Boot application:

1. Clone the repository by running:

```
git clone https://github.com/vmware-tanzu/application-accelerator-samples
```

2. Change into the `tanzu-java-web-app` directory.
3. In `Tiltfile`, first change the `SOURCE_IMAGE` variable to use your registry and project.
4. At the very end of the file add:

```
allow_k8s_contexts('your-cluster-name')
```

5. Inside the directory, run:

```
tanzu apps workload apply tanzu-java-web-app --live-update --local-path . -s
gr.io/my-project/tanzu-java-web-app-live-update -y
```

Expected output:

```

The files and directories listed in the .tanzuignore file are being excluded fr
om the uploaded source code.
Publishing source in "." to "gr.io/my-project/tanzu-java-web-app-live-updat
e"...
  Published source

Create workload:
1 + |---
2 + |apiVersion: carto.run/v1alpha1
3 + |kind: Workload
4 + |metadata:
5 + |  name: tanzu-java-web-app
6 + |  namespace: default
7 + |spec:
8 + |  params:
9 + |    - name: live-update

```

```

10 + |     value: "true"
11 + |     source:
12 + |     image: gcr.io/my-project/tanzu-java-web-app-live-update:latest@sha2
56:3c9fd738492a23ac532a709301fcf0c9aa2a8761b2b9347bdbab52ce9404264b

Created workload "tanzu-java-web-app"

To see logs:  "tanzu apps workload tail tanzu-java-web-app --timestamp --since
1h"
To get status: "tanzu apps workload get tanzu-java-web-app"

```

6. Run Tilt to deploy the workload.

```

tilt up

Tilt started on http://localhost:10350/
v0.23.6, built 2022-01-14

(space) to open the browser
(s) to stream logs (--stream=true)
(t) to open legacy terminal mode (--legacy=true)
(ctrl-c) to exit
Tilt started on http://localhost:10350/
v0.23.6, built 2022-01-14

Initial Build • (Tiltfile)
Loading Tiltfile at: /path/to/repo/tanzu-java-web-app/Tiltfile
Successfully loaded Tiltfile (1.500809ms)
tanzu-java-w... |
tanzu-java-w... | Initial Build • tanzu-java-web-app
tanzu-java-w... | WARNING: Live Update failed with unexpected error:
tanzu-java-w... |   Cannot extract live updates on this build graph structure
tanzu-java-w... | Falling back to a full image build + deploy
tanzu-java-w... | STEP 1/1 – Deploying
tanzu-java-w... |   Objects applied to cluster:
tanzu-java-w... |     → tanzu-java-web-app:workload
tanzu-java-w... |
tanzu-java-w... |   Step 1 - 8.87s (Deploying)
tanzu-java-w... |   DONE IN: 8.87s
tanzu-java-w... |
tanzu-java-w... | Tracking new pod rollout (tanzu-java-web-app-build-1-build-po
d):
tanzu-java-w... |   | Scheduled      - (...) Pending
tanzu-java-w... |   | Initialized    - (...) Pending
tanzu-java-w... |   | Ready          - (...) Pending
...

```

--local-path

Sets the path to a source in the local machine from where the workload creates an image to use as an application source. The local path can be a directory, a JAR, a ZIP, or a WAR file. Java/Spring Boot compiled binaries are also supported. This flag must be used with `--source-image` flag.

If Java/Spring compiled binary is passed instead of source code, the command takes less time to apply the workload because the build pack skips the compiling steps and start uploading the image.

When working with local source code, you can exclude files from the source code to be uploaded within the image by creating a file `.tanzuignore` at the root of the source code. The `.tanzuignore` file contains a list of file paths to exclude from the image including the file itself. The directories must not end with the system path separator (`/` or `\`). If the file contains directories that are not in the source code, they are ignored. Lines starting with a `#` hashtag are also ignored.

--maven-artifact

This artifact is an output of a Maven project build. This flag must be used with `--maven-version` and `--maven-group`.

Example

```
tanzu apps workload apply petc-mvn --maven-artifact petc --maven-version 2.6.1 --maven-
-group demo.com
  Create workload:
  1 + |---
  2 + |apiVersion: carto.run/v1alpha1
  3 + |kind: Workload
  4 + |metadata:
  5 + |  name: petc-mvn
  6 + |  namespace: default
  7 + |spec:
  8 + |  params:
  9 + |    - name: maven
 10 + |      value:
 11 + |        artifactId: petc
 12 + |        groupId: demo.com
 13 + |        version: 2.6.1
  Do you want to create this workload? [yN]:
```

--maven-group

This group identifies the project across all other Maven projects.

--maven-type

This specifies the type of artifact that the Maven project produces. This flag is optional and is set by default as `jar` by the supply chain.

--maven-version

Definition of the current version of the Maven project.

--source-image, -s

Registry path where the local source code is uploaded as an image.

Example

```
tanzu apps workload apply spring-pet-clinic --local-path /home/user/workspace/spring-p
et-clinic --source-image gcr.io/spring-community/spring-pet-clinic --type web
  Publish source in "/home/user/workspace/spring-pet-clinic" to "gcr.io/spring-communi
ty/spring-pet-clinic"? It might be visible to others who can pull images from that rep
ository Yes
  The files and/or directories listed in the .tanzuignore file are being excluded from t
he uploaded source code.
  Publishing source in "/home/user/workspace/spring-pet-clinic" to "gcr.io/spring-commun
ity/spring-pet-clinic"...
  Published source

  Create workload:
  1 + |---
  2 + |apiVersion: carto.run/v1alpha1
  3 + |kind: Workload
  4 + |metadata:
  5 + |  labels:
  6 + |    apps.tanzu.vmware.com/workload-type: web
  7 + |  name: spring-pet-clinic
```



```

 8 + | namespace: default
 9 + |spec:
10 + | source:
11 + |   image:gcr.io/spring-community/spring-pet-clinic:latest@sha256:5feb0d9da
f3f639755d8683ca7b647027cfddc7012e80c61dcdac27f0d7856a7
Do you want to create this workload? [yN]:

```

--namespace, -n

Specifies the namespace in which the workload is created or updated in.

Example

```

tanzu apps workload apply tanzu-java-web-app --git-repo https://github.com/vmware-tanzu/application-accelerator-samples --sub-path tanzu-java-web-app --git-branch main --type web --namespace my-namespace
Create workload:
 1 + |---
 2 + |apiVersion: carto.run/v1alpha1
 3 + |kind: Workload
 4 + |metadata:
 5 + | labels:
 6 + |   apps.tanzu.vmware.com/workload-type: web
 7 + | name: tanzu-java-web-app
 8 + | namespace: my-namespace
 9 + |spec:
10 + | source:
11 + |   git:
12 + |     ref:
13 + |       branch: main
14 + |     url: https://github.com/vmware-tanzu/application-accelerator-samples
15 + |     subPath: tanzu-java-web-app
Do you want to create this workload? [yN]:

```

--output, -o

Retrieves a workload after it's applied in the specified format; `yaml`, `yml`, `json`. If used with the `--yes` flag, all prompts are skipped and it only returns the workload definition. Use with the `--wait` or `--tail` flag to return the workload with its status.

Example

```

tanzu apps workload apply rmq-sample-app --git-repo https://github.com/jhvhs/rabbitmq-sample --git-branch main --service-ref "rmq=rabbitmq.com/v1beta1:RabbitmqCluster:example-rabbitmq-cluster-1" --type web --output yaml
Create workload:
 1 + |---
 2 + |apiVersion: carto.run/v1alpha1
 3 + |kind: Workload
 4 + |metadata:
 5 + | labels:
 6 + |   apps.tanzu.vmware.com/workload-type: web
 7 + | name: rmq-sample-app
 8 + | namespace: default
 9 + |spec:
10 + | serviceClaims:
11 + |   - name: rmq
12 + |     ref:
13 + |       apiVersion: rabbitmq.com/v1beta1
14 + |       kind: RabbitmqCluster
15 + |       name: example-rabbitmq-cluster-1
16 + | source:
17 + |   git:
18 + |     ref:

```

```

19 + |         branch: main
20 + |         url: https://github.com/jhvhs/rabbitmq-sample
Do you want to create this workload? [yN]: y
Created workload "rmq-sample-app"

To see logs:  "tanzu apps workload tail rmq-sample-app --timestamp --since 1h"
To get status: "tanzu apps workload get rmq-sample-app"

---
apiVersion: carto.run/v1alpha1
kind: Workload
metadata:
  creationTimestamp: "2023-04-04T15:18:13Z"
  generation: 1
  labels:
    apps.tanzu.vmware.com/workload-type: web
  name: rmq-sample-app
  namespace: default
  resourceVersion: "184169566"
  uid: 6588d398-b803-47e3-b31a-23d9a1a633a9
spec:
  serviceClaims:
  - name: rmq
    ref:
      apiVersion: rabbitmq.com/v1beta1
      kind: RabbitmqCluster
      name: example-rabbitmq-cluster-1
  source:
    git:
      ref:
        branch: main
        url: https://github.com/jhvhs/rabbitmq-sample
status:
  supplyChainRef: {}

```

--param / -p

Additional parameters sent to the supply chain, the value is sent as a string. For complex YAML and JSON objects use `--param-yaml`.

Example

```

tanzu apps workload apply tanzu-java-web-app --git-repo https://github.com/vmware-tanzu/application-accelerator-samples --sub-path tanzu-java-web-app --git-branch main --type web --param port=9090 --param management-port=9190
Create workload:
1 + |---
2 + |apiVersion: carto.run/v1alpha1
3 + |kind: Workload
4 + |metadata:
5 + |  labels:
6 + |    apps.tanzu.vmware.com/workload-type: web
7 + |  name: tanzu-java-web-app
8 + |  namespace: default
9 + |spec:
10 + |  params:
11 + |    - name: port
12 + |      value: "9090"
13 + |    - name: management-port
14 + |      value: "9190"
15 + |  source:
16 + |    git:
17 + |      ref:
18 + |        branch: main
19 + |        url: https://github.com/vmware-tanzu/application-accelerator-samples

```

```

20 + |     subPath: tanzu-java-web-app
Do you want to create this workload? [yN]:

```

To unset parameters, use `-` after their name.

Example

```

tanzu apps workload apply tanzu-java-web-app --param port-
Update workload:
...
 7, 7 | name: tanzu-java-web-app
 8, 8 | namespace: default
 9, 9 | spec:
10,10 |   params:
11   - |   - name: port
12   - |     value: "9090"
13,11 |   - name: management-port
14,12 |     value: "9190"
15,13 |   source:
16,14 |     git:
...
Really update the workload "tanzu-java-web-app"? [yN]:

```

`--param-yaml`

Additional parameters to be sent to the supply chain, the value is sent as a complex object.

Example

```

tanzu apps workload apply tanzu-java-web-app --git-repo https://github.com/vmware-tanzu/application-accelerator-samples --sub-path tanzu-java-web-app --git-branch main --type web --param-yaml server='port: 9090\nmanagement-port: 9190'
Create workload:
 1 + |---
 2 + |apiVersion: carto.run/v1alpha1
 3 + |kind: Workload
 4 + |metadata:
 5 + |  labels:
 6 + |    apps.tanzu.vmware.com/workload-type: web
 7 + |  name: tanzu-java-web-app
 8 + |  namespace: default
 9 + | spec:
10 + |   params:
11 + |     - name: server
12 + |       value:
13 + |         management-port: 9190
14 + |         port: 9090
15 + |   source:
16 + |     git:
17 + |       ref:
18 + |         branch: main
19 + |       url: https://github.com/vmware-tanzu/application-accelerator-samples
20 + |       subPath: tanzu-java-web-app
Do you want to create this workload? [yN]:

```

To unset parameters, use `-` after their name.

Example

```

tanzu apps workload apply tanzu-java-web-app --param-yaml server-
Update workload:
...
 6, 6 |   apps.tanzu.vmware.com/workload-type: web
 7, 7 |   name: tanzu-java-web-app
 8, 8 |   namespace: default

```

```

 9, 9 |spec:
10   - |  params:
11     - |    - name: server
12       - |      value:
13         - |        management-port: 9190
14         - |        port: 9090
15, 10 | source:
16, 11 |   git:
17, 12 |     ref:
18, 13 |     branch: main
...
Really update the workload "tanzu-java-web-app"? [yN]:

```

--registry-ca-cert

Refers to the path of the self-signed certificate needed for the custom/private registry. This is also populated with a default value through environment variables. If the environment variable `TANZU_APPS_REGISTRY_CA_CERT` is set, it's not necessary to use it in the command.

See [Custom registry credentials](#) for the supported environment variables.

Example

```

tanzu apps workload apply my-workload --local-path . -s registry.url.nip.io/my-packag
e/my-image --type web --registry-ca-cert path/to/cacert/mycert.nip.io.crt --registry-u
sername my-username --registry-password my-password
Publish source in "." to "registry.url.nip.io/my-package/my-image"? It might be visi
ble to others who can pull images from that repository Yes
Publishing source in "." to "registry.url.nip.io/my-package/my-image"...
Published source

Create workload:
 1 + |---
 2 + |apiVersion: carto.run/v1alpha1
 3 + |kind: Workload
 4 + |metadata:
 5 + |  labels:
 6 + |    apps.tanzu.vmware.com/workload-type: web
 7 + |    name: my-workload
 8 + |    namespace: default
 9 + |spec:
10 + |  source:
11 + |    image: registry.url.nip.io/my-package/my-image:latest@sha256:caeb7e3a0e
3ae0659f74d01095b6fdfe0d3c4a12856a15ac67ad6cd3b9e43648
Do you want to create this workload? [yN]:

```

--registry-password

If credentials are needed, the user name and password values are set through the `--registry-password` flag. The value of this flag can also be specified through `TANZU_APPS_REGISTRY_PASSWORD`.

--registry-token

Used for token authentication in the private registry. This flag is set as `TANZU_APPS_REGISTRY_TOKEN` environment variable.

--registry-username

Often used with `--registry-password` to set private registry credentials. Can be provided using `TANZU_APPS_REGISTRY_USERNAME` environment variable to avoid setting it every time in the command.

--request-cpu

Refers to the minimum CPU the workload pods request to use.

Example

```
tanzu apps workload apply tanzu-java-web-app --git-repo https://github.com/vmware-tanzu/application-accelerator-samples --sub-path tanzu-java-web-app --git-branch main --type web --request-cpu .3
Create workload:
 1 + |---
 2 + |apiVersion: carto.run/v1alpha1
 3 + |kind: Workload
 4 + |metadata:
 5 + |  labels:
 6 + |    apps.tanzu.vmware.com/workload-type: web
 7 + |  name: tanzu-java-web-app
 8 + |  namespace: default
 9 + |spec:
10 + |  resources:
11 + |    requests:
12 + |      cpu: 300m
13 + |  source:
14 + |    git:
15 + |      ref:
16 + |        branch: main
17 + |      url: https://github.com/vmware-tanzu/application-accelerator-samples
18 + |      subPath: tanzu-java-web-app
Do you want to create this workload? [yN]:
```

--request-memory

Refers to the minimum memory the workload pods are requesting to use.

Example

```
tanzu apps workload apply tanzu-java-web-app --git-repo https://github.com/vmware-tanzu/application-accelerator-samples --sub-path tanzu-java-web-app --git-branch main --type web --request-memory 300Mi
Create workload:
 1 + |---
 2 + |apiVersion: carto.run/v1alpha1
 3 + |kind: Workload
 4 + |metadata:
 5 + |  labels:
 6 + |    apps.tanzu.vmware.com/workload-type: web
 7 + |  name: tanzu-java-web-app
 8 + |  namespace: default
 9 + |spec:
10 + |  resources:
11 + |    requests:
12 + |      memory: 300Mi
13 + |  source:
14 + |    git:
15 + |      ref:
16 + |        branch: main
17 + |      url: https://github.com/vmware-tanzu/application-accelerator-samples
18 + |      subPath: tanzu-java-web-app
Do you want to create this workload? [yN]:
```

--service-account

Refers to the service account to associate with the workload. A service account provides an identity for a workload object.

Example

```
tanzu apps workload apply tanzu-java-web-app --git-repo https://github.com/vmware-tanzu/application-accelerator-samples --sub-path tanzu-java-web-app --git-branch main --type web --service-account petc-serviceaccount

Create workload:
 1 + |---
 2 + |apiVersion: carto.run/v1alpha1
 3 + |kind: Workload
 4 + |metadata:
 5 + |  labels:
 6 + |    apps.tanzu.vmware.com/workload-type: web
 7 + |  name: tanzu-java-web-app
 8 + |  namespace: default
 9 + |spec:
10 + |  serviceAccountName: petc-serviceaccount
11 + |  source:
12 + |    git:
13 + |      ref:
14 + |        branch: main
15 + |      url: https://github.com/vmware-tanzu/application-accelerator-samples
16 + |      subPath: tanzu-java-web-app
Do you want to create this workload? [yN]:
```

To unset a service account, pass empty string.

Example

```
tanzu apps workload apply tanzu-java-web-app --git-repo https://github.com/vmware-tanzu/application-accelerator-samples --sub-path tanzu-java-web-app --git-branch main --type web --service-account ""

Update workload:
...
 6, 6 |    apps.tanzu.vmware.com/workload-type: web
 7, 7 |  name: tanzu-java-web-app
 8, 8 |  namespace: default
 9, 9 |spec:
10   - |  serviceAccountName: petc-serviceaccount
11, 10 |  source:
12, 11 |    git:
13, 12 |      ref:
14, 13 |        branch: main
...
Really update the workload "tanzu-java-web-app"? [yN]:
```

--service-ref

Binds a service to a workload to provide the information from a service resource to an application.

For more information, see [Tanzu Application Platform documentation](#).

Example

```
tanzu apps workload apply rmq-sample-app --git-repo https://github.com/jhvhs/rabbitmq-sample --git-branch main --service-ref "rmq=rabbitmq.com/v1beta1:RabbitmqCluster:example-rabbitmq-cluster-1"

Create workload:
 1 + |---
 2 + |apiVersion: carto.run/v1alpha1
 3 + |kind: Workload
 4 + |metadata:
 5 + |  name: rmq-sample-app
 6 + |  namespace: default
 7 + |spec:
 8 + |  serviceClaims:
```

```

 9 + | - name: rmq
10 + |   ref:
11 + |     apiVersion: rabbitmq.com/v1beta1
12 + |     kind: RabbitmqCluster
13 + |     name: example-rabbitmq-cluster-1
14 + |   source:
15 + |     git:
16 + |       ref:
17 + |         branch: main
18 + |       url: https://github.com/jhvhs/rabbitmq-sample
Do you want to create this workload? [yN]:

```

To delete service binding, use the service name followed by `-.`

Example

```

tanzu apps workload apply rmq-sample-app --service-ref rmq-
Update workload:
...
 4, 4 |metadata:
 5, 5 |  name: rmq-sample-app
 6, 6 | namespace: default
 7, 7 |spec:
 8   - |  serviceClaims:
 9   - |    - name: rmq
10   - |      ref:
11   - |        apiVersion: rabbitmq.com/v1beta1
12   - |        kind: RabbitmqCluster
13   - |        name: example-rabbitmq-cluster-1
14, 8 |  source:
15, 9 |    git:
16,10 |      ref:
17,11 |        branch: main
...
Really update the workload "rmq-sample-app"? [yN]:

```

`--sub-path`

Defines which path is used as the root path to create and update the workload.

Example

- Git repository

```

tanzu apps workload apply subpathtester --git-repo https://github.com/path-to-r
epo/my-repo --git-branch main --type web --sub-path my-subpath
Create workload:
 1 + |---
 2 + |apiVersion: carto.run/v1alpha1
 3 + |kind: Workload
 4 + |metadata:
 5 + |  labels:
 6 + |    apps.tanzu.vmware.com/workload-type: web
 7 + |  name: subpathtester
 8 + |  namespace: default
 9 + |spec:
10 + |  source:
11 + |    git:
12 + |      ref:
13 + |        branch: main
14 + |        url: https://github.com/path-to-repo/my-repo
15 + |        subPath: my-subpath
Do you want to create this workload? [yN]:

```

- Local path

- o In the directory of the project you want to create the workload from

```
tanzu apps workload apply my-workload --local-path . -s gcr.io/my-registry/my-workload-image --sub-path subpath_folder
Publish source in "." to "gcr.io/my-registry/my-workload-image"? It might be visible to others who can pull images from that repository Yes
Publishing source in "." to "gcr.io/my-registry/my-workload-image"...
Published source

Create workload:
 1 + |---
 2 + |apiVersion: carto.run/v1alpha1
 3 + |kind: Workload
 4 + |metadata:
 5 + |  name: myworkload
 6 + |  namespace: default
 7 + |spec:
 8 + |  source:
 9 + |    image: gcr.io/my-registry/my-workload-image:latest@sha256:f28c5fedd0e902800e6df9605ce5e20a8e835df9e87b1a0aa256666ea179fc3f
10 + |    subPath: subpath_folder
Do you want to create this workload? [yN]:
```

--tail

Prints the logs of the workload creation in every step.

Example

```
tanzu apps workload apply tanzu-java-web-app --git-repo https://github.com/vmware-tanzu/application-accelerator-samples --sub-path tanzu-java-web-app --git-branch main --type web --tail
Create workload:
 1 + |---
 2 + |apiVersion: carto.run/v1alpha1
 3 + |kind: Workload
 4 + |metadata:
 5 + |  labels:
 6 + |    apps.tanzu.vmware.com/workload-type: web
 7 + |  name: tanzu-java-web-app
 8 + |  namespace: default
 9 + |spec:
10 + |  source:
11 + |    git:
12 + |      ref:
13 + |        branch: main
14 + |      url: https://github.com/vmware-tanzu/application-accelerator-samples
15 + |      subPath: tanzu-java-web-app
Do you want to create this workload? [yN]: y
Created workload "tanzu-java-web-app"

To see logs: "tanzu apps workload tail tanzu-java-web-app --timestamp --since 1h"
To get status: "tanzu apps workload get tanzu-java-web-app"

Waiting for workload "tanzu-java-web-app" to become ready...
+ tanzu-java-web-app-build-1-build-pod > prepare
tanzu-java-web-app-build-1-build-pod[prepare] Build reason(s): CONFIG
tanzu-java-web-app-build-1-build-pod[prepare] CONFIG:
tanzu-java-web-app-build-1-build-pod[prepare] + env:
tanzu-java-web-app-build-1-build-pod[prepare] + - name: BP_OCI_SOURCE
tanzu-java-web-app-build-1-build-pod[prepare] +   value: main/d381fb658cb435a04e2271ca85bd3e8627a5e7e4
tanzu-java-web-app-build-1-build-pod[prepare] resources: {}
tanzu-java-web-app-build-1-build-pod[prepare] - source: {}
```



```
tanzu-java-web-app-build-1-build-pod[prepare] + source:
tanzu-java-web-app-build-1-build-pod[prepare] + blob:
tanzu-java-web-app-build-1-build-pod[prepare] + url: http://source-controller.flux-system.svc.cluster.local./gitrepository/default/tanzu-java-web-app/1c4cf82e499f7e46da182922d4097908d4817320.tar.gz
...
...
...
```

--tail-timestamp

Prints the logs of the workload creation in every step adding the time in which the log is occurring.

Example

```
tanzu apps workload apply tanzu-java-web-app --git-repo https://github.com/vmware-tanzu/application-accelerator-samples --sub-path tanzu-java-web-app --git-branch main --type web --tail-timestamp
Create workload:
 1 + |---
 2 + |apiVersion: carto.run/v1alpha1
 3 + |kind: Workload
 4 + |metadata:
 5 + |  labels:
 6 + |    apps.tanzu.vmware.com/workload-type: web
 7 + |  name: tanzu-java-web-app
 8 + |  namespace: default
 9 + |spec:
10 + |  source:
11 + |    git:
12 + |      ref:
13 + |        branch: main
14 + |        url: https://github.com/vmware-tanzu/application-accelerator-samples
15 + |        subPath: tanzu-java-web-app
Do you want to create this workload? [yN]: y
Created workload "tanzu-java-web-app"

To see logs: "tanzu apps workload tail tanzu-java-web-app --timestamp --since 1h"
To get status: "tanzu apps workload get tanzu-java-web-app"

Waiting for workload "tanzu-java-web-app" to become ready...
+ tanzu-java-web-app-build-1-build-pod > prepare
tanzu-java-web-app-build-1-build-pod[prepare] 2022-06-15T11:28:01.348418803-05:00 Build reason(s): CONFIG
tanzu-java-web-app-build-1-build-pod[prepare] 2022-06-15T11:28:01.364719405-05:00 CONFIG:
tanzu-java-web-app-build-1-build-pod[prepare] 2022-06-15T11:28:01.364761781-05:00 + env:
tanzu-java-web-app-build-1-build-pod[prepare] 2022-06-15T11:28:01.364771861-05:00 + - name: BP_OCI_SOURCE
tanzu-java-web-app-build-1-build-pod[prepare] 2022-06-15T11:28:01.364781718-05:00 + value: main/d381fb658cb435a04e2271ca85bd3e8627a5e7e4
tanzu-java-web-app-build-1-build-pod[prepare] 2022-06-15T11:28:01.364788374-05:00 re sources: {}
tanzu-java-web-app-build-1-build-pod[prepare] 2022-06-15T11:28:01.364795451-05:00 - source: {}
tanzu-java-web-app-build-1-build-pod[prepare] 2022-06-15T11:28:01.365344965-05:00 + source:
tanzu-java-web-app-build-1-build-pod[prepare] 2022-06-15T11:28:01.365364101-05:00 + blob:
tanzu-java-web-app-build-1-build-pod[prepare] 2022-06-15T11:28:01.365372427-05:00 + url: http://source-controller.flux-system.svc.cluster.local./gitrepository/default/tanzu-java-web-app/1c4cf82e499f7e46da182922d4097908d4817320.tar.gz
...
...
```

```
...
...
```

--type / -t

Sets the type of workload by adding the label `apps.tanzu.vmware.com/workload-type`, which is used as a matcher by supply chains. Use the `TANZU_APPS_TYPE` environment variable to have a default value for this flag.

Example

```
tanzu apps workload apply tanzu-java-web-app --git-repo https://github.com/vmware-tanzu/application-accelerator-samples --sub-path tanzu-java-web-app --git-branch main --type web
Create workload:
 1 + |---
 2 + |apiVersion: carto.run/v1alpha1
 3 + |kind: Workload
 4 + |metadata:
 5 + |  labels:
 6 + |    apps.tanzu.vmware.com/workload-type: web
 7 + |  name: tanzu-java-web-app
 8 + |  namespace: default
 9 + |spec:
10 + |  source:
11 + |    git:
12 + |      ref:
13 + |        branch: main
14 + |      url: https://github.com/vmware-tanzu/application-accelerator-samples
15 + |      subPath: tanzu-java-web-app
```

--update-strategy

Specifies whether the update from file should replace or merge the current workload. The default is merge.



Note

This flag is only applicable to the `tanzu apps workload apply` command. It is not applicable to the `tanzu apps workload create` command.

Example

For example, there is a workload created from a file, which has in its `spec` the following:

```
...
spec:
  resources:
    requests:
      memory: 1Gi
    limits:
      memory: 1Gi      # delete this line
      cpu: 500m       # delete this line
...

```

If the workload file is changed as specified in the comments, there are two ways to update the workload running in the cluster.

One, with `merge` update strategy.

```
tanzu apps workload apply -f ./spring-petclinic.yaml # defaulting to merge
```

```
WARNING: Configuration file update strategy is changing. By default, provided configuration files will replace rather than merge existing configuration. The change will take place in the January 2024 TAP release (use "--update-strategy" to control strategy explicitly).
```

```
Workload is unchanged, skipping update
```

The other, with `replace` update strategy, which completely overwrites the workload in the cluster according to the new specifications in the file.

```
tanzu apps workload apply -f ./spring-petclinic.yaml --update-strategy replace
```

```
WARNING: Configuration file update strategy is changing. By default, provided configuration files will replace rather than merge existing configuration. The change will take place in the January 2024 TAP release (use "--update-strategy" to control strategy explicitly).
```

```
Update workload:
...
 8, 8 | name: spring-petclinic
 9, 9 | namespace: default
10, 10 | spec:
11, 11 | resources:
12 - | limits:
13 - |   cpu: 500m
14 - |   memory: 1Gi
15, 12 | requests:
16, 13 |   memory: 1Gi
17, 14 | source:
18, 15 |   git:
...
Really update the workload "spring-petclinic"? [yN]:
```

--wait

Holds the command until the workload is ready.

Example

```
tanzu apps workload apply tanzu-java-web-app --git-repo https://github.com/vmware-tanzu/application-accelerator-samples --sub-path tanzu-java-web-app --git-tag tap-1.6.13 --type web --wait
Update workload:
...
10, 10 | source:
11, 11 |   git:
12, 12 |     ref:
13, 13 |       branch: main
14 + |       tag: tap-1.6.13
14, 15 |     url: https://github.com/vmware-tanzu/application-accelerator-samples
15, 16 |     subPath: tanzu-java-web-app
Really update the workload "tanzu-java-web-app"? Yes
Updated workload "tanzu-java-web-app"

To see logs: "tanzu apps workload tail tanzu-java-web-app --timestamp --since 1h"
To get status: "tanzu apps workload get tanzu-java-web-app"

Waiting for workload "tanzu-java-web-app" to become ready...
Workload "tanzu-java-web-app" is ready
```

--wait-timeout

Sets a timeout to wait for the workload to become ready.

Example

```
tanzu apps workload apply tanzu-java-web-app --git-repo https://github.com/vmware-tanzu/application-accelerator-samples --sub-path tanzu-java-web-app --git-tag tap-1.6.13-take1 --type web --wait --wait-timeout 1m
Update workload:
...
10, 10 | source:
11, 11 | git:
12, 12 | ref:
13, 13 | branch: main
14 - | tag: tap-1.6.13
14 + | tag: tap-1.6.13-take1
15, 15 | url: https://github.com/vmware-tanzu/application-accelerator-samples
16, 16 | subPath: tanzu-java-web-app
Really update the workload "tanzu-java-web-app"? Yes
Updated workload "tanzu-java-web-app"

To see logs: "tanzu apps workload tail tanzu-java-web-app --timestamp --since 1h"
To get status: "tanzu apps workload get tanzu-java-web-app"

Waiting for workload "tanzu-java-web-app" to become ready...
Workload "tanzu-java-web-app" is ready
```

--yes, -y

Assumes `--yes` on all the survey prompts.

Example

```
tanzu apps workload apply spring-pet-clinic --local-path/home/user/workspace/spring-pet-clinic --source-image gcr.io/spring-community/spring-pet-clinic --type web -y
The files and/or directories listed in the .tanzuignore file are being excluded from the uploaded source code.
Publishing source in "/Users/dalfonso/Documents/src/java/tanzu-java-web-app" to "gcr.io/spring-community/spring-pet-clinic"...
Published source

Create workload:
 1 + |---
 2 + |apiVersion: carto.run/v1alpha1
 3 + |kind: Workload
 4 + |metadata:
 5 + | labels:
 6 + |   apps.tanzu.vmware.com/workload-type: web
 7 + | name: spring-pet-clinic
 8 + | namespace: default
 9 + |spec:
10 + | source:
11 + |   image: gcr.io/spring-community/spring-pet-clinic:latest@sha256:5feb0d9daf3f639755d8683ca7b647027cfddc7012e80c61dcdac27f0d7856a7
Created workload "spring-pet-clinic"

To see logs: "tanzu apps workload tail spring-pet-clinic --timestamp --since 1h"
To get status: "tanzu apps workload get spring-pet-clinic"
```

tanzu apps workload delete

This topic tells you about the Tanzu Apps CLI `tanzu apps workload delete` command. This command deletes workloads in a cluster. Deleting a workload does not mean the images published in the registry are deleted with it.

Default view

A message is displayed in the terminal asking if a workload should be deleted unless the `--yes` flag is used. If you indicate “Y”, then the workload starts a deletion process inside the cluster.

```
tanzu apps workload delete spring-pet-clinic
Really delete the workload "spring-pet-clinic"? Yes
Deleted workload "spring-pet-clinic"
```

```
tanzu apps workload delete spring-pet-clinic --yes
Deleted workload "spring-pet-clinic"
```

Workload Delete flags

`--all`

Deletes all workloads in a namespace.

```
tanzu apps workload delete --all
Really delete all workloads in the namespace "default"? (y/N) Y
Deleted workloads in namespace "default"
```

```
tanzu apps workload delete --all -n my-namespace
Really delete all workloads in the namespace "my-namespace"? Yes
Deleted workloads in namespace "my-namespace"
```

`--file, -f`

Path to a file that contains the specification of the workload to be deleted.

```
tanzu apps workload delete -f path/to/file/spring-petclinic.yaml
Really delete the workload "spring-petclinic"? Yes
Deleted workload "spring-petclinic"
```

`--namespace, -n`

Specifies the namespace in which the workload is to be deleted.

```
tanzu apps workload delete spring-petclinic -n spring-petclinic-ns
Really delete the workload "spring-petclinic"? Yes
Deleted workload "spring-petclinic"
```

`--wait`

Waits until workload is deleted.

```
tanzu apps workload delete -f path/to/file/spring-petclinic.yaml --wait
Really delete the workload "spring-petclinic"? Yes
Deleted workload "spring-petclinic"
Waiting for workload "spring-petclinic" to be deleted...
Workload "spring-petclinic" was deleted
```

`--wait-timeout`

Sets a timeout to wait for workload to be deleted.

```
tanzu apps workload delete -f path/to/file/spring-petclinic.yaml --wait --wait-timeout
1m
  Really delete the workload "spring-petclinic"? Yes
  Deleted workload "spring-petclinic"
Waiting for workload "spring-petclinic" to be deleted...
Workload "spring-petclinic" was deleted
```

```
tanzu apps workload delete spring-petclinic -n spring-petclinic-ns --wait --wait-timeo
ut 1m
  Really delete the workload "spring-petclinic"? Yes
  Deleted workload "spring-petclinic"
Waiting for workload "spring-petclinic" to be deleted...
Error: timeout after 1m waiting for "spring-petclinic" to be deleted
To view status run: tanzu apps workload get spring-petclinic --namespace spring-petcli
nic-ns
Error: exit status 1

✘ exit status 1
```

--yes, -f

Assume yes on all the survey prompts.

```
tanzu apps workload delete spring-petclinic --yes
  Deleted workload "spring-petclinic"
```

tanzu apps workload get

This topic tells you how to use the Tanzu Apps CLI `tanzu apps workload get` command to retrieve information and status about a workload.

Some of the workload details in the command output are as follows:

- Workload name, type, and namespace.
- The source code used to build the workload or the pre-built OCI image.
- The supply chain that processed the workload.
- The specific resources within the supply chain that interacted with the workload, and the stamped out resources associated with each of those interactions.
- The delivery workflow that the application follows.
- Any issues associated with deploying the workload.
- The *Pods* the workload generates.
- And when applicable, the Knative services related to the workload.

Default view

There are multiple sections in the workload `get` command output. The following data is displayed:

- Name of the workload and its status.
- Displays source information of workload.
- If the workload was matched with a supply chain, the information of its name and the status is displayed.
- Information and status of the individual steps that is defined in the supply chain for the workload.

- Any issue with the workload: the name and corresponding message.
- Workload related resource information and status like services claims, related pods, knative services.

At the very end of the command output, a hint to follow up commands is also displayed.

Note

The **Supply Chain** and **Delivery** sections are included in the command output depending on whether those resources are present on the target cluster. For example, if the target includes only build components, there would be no **Delivery** resources available and therefore the **Delivery** section would not be included in the command output.

```
tanzu apps workload get rmq-sample-app
Overview
  name:      rmq-sample-app
  type:      web
  namespace: default

Source
  type:      git
  url:       https://github.com/jhvhs/rabbitmq-sample
  branch:    main

Supply Chain
  name:      source-to-url

NAME          READY   HEALTHY   UPDATED   RESOURCE
source-provider      True    True      7d11h    gitrepositories.source.toolkit.fluxcd.io/rmq-sample-app
image-provider      True    True      2d18h    images.kpack.io/rmq-sample-app
config-provider     True    True      7d11h    podintents.conventions.carto.run/rmq-sample-app
app-config          True    True      7d11h    configmaps/rmq-sample-app
service-bindings    True    True      7d11h    configmaps/rmq-sample-app-with-claims
api-descriptors    True    True      7d11h    configmaps/rmq-sample-app-with-api-descriptors
config-writer       True    True      2d18h    runnables.carto.run/rmq-sample-app-config-writer

Delivery
  name:      delivery-basic

NAME          READY   HEALTHY   UPDATED   RESOURCE
source-provider      True    True      7d11h    imagerepositories.source.apps.tanzu.vmware.com/rmq-sample-app-delivery
deployer           True    True      6m25s    apps.kappctrl.k14s.io/rmq-sample-app

Messages
  No messages found.

Services
CLAIM  NAME          KIND          API VERSION
rmq    example-rabbitmq-cluster-1  RabbitmqCluster  rabbitmq.com/v1beta1

Pods
NAME          READY   STATUS    RESTARTS   AGE
rmq-sample-app-build-1-build-pod  0/1    Completed  0           56d
rmq-sample-app-build-2-build-pod  0/1    Completed  0           46d
```

```

rmq-sample-app-build-3-build-pod      0/1    Completed    0      45d
rmq-sample-app-config-writer-54mwk-pod 0/1    Completed    0      6d12h
rmq-sample-app-config-writer-74qvp-pod 0/1    Completed    0      6d16h
rmq-sample-app-config-writer-78r5w-pod 0/1    Completed    0      45d
rmq-sample-app-config-writer-9xs5f-pod 0/1    Completed    0      46d

```

Knative Services

```

NAME          READY   URL
rmq-sample-app  Ready   http://rmq-sample-app.default.127.0.0.1.nip.io

```

To see logs: "tanzu apps workload tail rmq-sample-app --timestamp --since 1h"

--export

Exports the submitted workload in `yaml` format. This flag can also be used with the `--output` flag. The output is shortened because some text boxes are removed.

```

tanzu apps workload get tanzu-java-web-app --export

---
apiVersion: carto.run/v1alpha1
kind: Workload
metadata:
  labels:
    apps.tanzu.vmware.com/workload-type: web
    autoscaling.knative.dev/min-scale: "1"
name: tanzu-java-web-app
namespace: default
spec:
  source:
    git:
      ref:
        tag: tap-1.3
        url: https://github.com/vmware-tanzu/application-accelerator-samples
        subPath: tanzu-java-web-app

```

--output/-o

Configures how the workload is shown. This supports the values `yaml`, `yml`, and `json`, where `yaml` and `yml` are equal. It shows the actual workload in the cluster.

- `yaml/yml`

```

tanzu apps workload get tanzu-java-web-app -o yaml

---
apiVersion: carto.run/v1alpha1
kind: Workload
metadata:
  creationTimestamp: "2022-06-03T18:10:59Z"
  generation: 1
  labels:
    apps.tanzu.vmware.com/workload-type: web
    autoscaling.knative.dev/min-scale: "1"
  ...
spec:
  source:
    git:
      ref:
        tag: tap-1.1
        url: https://github.com/vmware-tanzu/application-accelerator-samples
        subPath: tanzu-java-web-app
  status:
    conditions:

```



```

- lastTransitionTime: "2022-06-03T18:10:59Z"
  message: ""
  reason: Ready
  status: "True"
  type: SupplyChainReady
- lastTransitionTime: "2022-06-03T18:14:18Z"
  message: ""
  reason: ResourceSubmissionComplete
  status: "True"
  type: ResourcesSubmitted
- lastTransitionTime: "2022-06-03T18:14:18Z"
  message: ""
  reason: Ready
  status: "True"
  type: Ready
observedGeneration: 1
resources:
...
supplyChainRef:
  kind: ClusterSupplyChain
  name: source-to-url
...

```

- `json`

```

tanzu apps workload get tanzu-java-web-app -o json
{
  "kind": "Workload",
  "apiVersion": "carto.run/v1alpha1",
  "metadata": {
    "name": "tanzu-java-web-app",
    "namespace": "default",
    "uid": "937679ca-9c72-4e23-bfef-6334e6c003a7",
    "resourceVersion": "111637840",
    "generation": 1,
    "creationTimestamp": "2022-06-03T18:10:59Z",
    "labels": {
      "apps.tanzu.vmware.com/workload-type": "web",
      "autoscaling.knative.dev/min-scale": "1"
    },
    ...
  }
  "spec": {
    "source": {
      "git": {
        "url": "https://github.com/vmware-tanzu/application-accelerator-samples",
        "ref": {
          "tag": "tap-1.3"
        }
      },
      "subPath": "tanzu-java-web-app"
    },
    "status": {
      "observedGeneration": 1,
      "conditions": [
        {
          "type": "SupplyChainReady",
          "status": "True",
          "lastTransitionTime": "2022-06-03T18:10:59Z",
          "reason": "Ready",
          "message": ""
        },
        {
          "type": "ResourcesSubmitted",

```

```

        "status": "True",
        "lastTransitionTime": "2022-06-03T18:14:18Z",
        "reason": "ResourceSubmissionComplete",
        "message": ""
    },
    {
        "type": "Ready",
        "status": "True",
        "lastTransitionTime": "2022-06-03T18:14:18Z",
        "reason": "Ready",
        "message": ""
    }
],
"supplyChainRef": {
    "kind": "ClusterSupplyChain",
    "name": "source-to-url"
},
"resources": [
    {
        "name": "source-provider",
        "stampedRef": {
            "kind": "GitRepository",
            "namespace": "default",
            "name": "tanzu-java-web-app",
            ...
        }
    }
]
...
}
...
}

```

--namespace/-n

Specifies the namespace where the workload is deployed.

```

tanzu apps workload get tanzu-java-web-app -n development

Overview
name:          tanzu-java-web-app
type:          web
namespace:     development

Source
type:          git
url:           https://github.com/vmware-tanzu/application-accelerator-samples
sub-path:      tanzu-java-web-app
tag:           tap-1.3

Supply Chain
name:          source-to-url

NAME           READY   HEALTHY   UPDATED   RESOURCE
source-provider True     True      31m       gitrepositories.source.toolkit.fluxcd.io/tanzu-java-web-app
image-provider True     True      30m       images.kpack.io/tanzu-java-web-app
config-provider True     True      30m       podintents.conventions.carto.run/tanzu-java-web-app
app-config     True     True      30m       configmaps/tanzu-java-web-app
service-bindings True     True      30m       configmaps/tanzu-java-web-app-with-claims
api-descriptors True     True      30m       configmaps/tanzu-java-web-app-with-api-descriptors
config-writer  True     True      30m       runnables.carto.run/tanzu-java-web-app

```

```

pp-config-writer

Delivery
  name:  delivery-basic

NAME          READY   HEALTHY   UPDATED   RESOURCE
source-provider  True    True      30m       imagerepositories.source.apps.tanzu.v
mware.com/tanzu-java-web-app-delivery
deployer        True    True      30m       apps.kappctrl.k14s.io/tanzu-java-web-
app

Messages
  No messages found.

Pods
NAME          READY   STATUS      RESTARTS   AGE
tanzu-java-web-app-build-11-build-pod  0/1    Completed   0           6d12h
tanzu-java-web-app-build-12-build-pod  0/1    Completed   0           22h
tanzu-java-web-app-build-3-build-pod   0/1    Completed   0           60d
tanzu-java-web-app-config-writer-655rb-pod  0/1    Completed   0           21d
tanzu-java-web-app-config-writer-7h8bn-pod  0/1    Completed   0           6d12h
tanzu-java-web-app-config-writer-7xr6m-pod  0/1    Completed   0           60d
tanzu-java-web-app-config-writer-g9gp8-pod  0/1    Completed   0           45d

Knative Services
NAME          READY   URL
tanzu-java-web-app  Ready  http://tanzu-java-web-app.default.127.0.0.1.nip.io

To see logs: "tanzu apps workload tail tanzu-java-web-app --namespace development --ti
mestamp --since 1h"

```

tanzu apps workload list

This topic tells you about the Tanzu Apps CLI `tanzu apps workload list` command.

The `tanzu apps workload list` command gets the workloads present in the cluster, either in the current namespace, in another namespace, or all namespaces.

Default view

The default view for `tanzu apps workload list` is a table with the workloads present in the cluster in the specified namespace. Each row displays the name of the workload, the application it is related to, its status, and how long it's been in the cluster.

For example, in the default namespace

```

tanzu apps workload list

NAME          TYPE    APP                READY   AGE
nginx4        web     <empty>            Ready   7d9h
petclinic2    web     <empty>            Ready   29h
rmq-sample-app  web     <empty>            Ready   164m
rmq-sample-app4  web     <empty>            WorkloadLabelsMissing  29d
spring-pet-clinic  web     <empty>            Unknown  166m
spring-petclinic2  web     spring-petclinic  Unknown  29d
spring-petclinic3  <empty>  spring-petclinic  Ready   29d
tanzu-java-web-app  web     tanzu-java-web-app  Ready   40m
tanzu-java-web-app2  web     tanzu-java-web-app  Ready   20m

```

`--all-namespaces, -A`

Shows workloads in all namespaces in cluster.

```
tanzu apps workload list -A
```

NAMESPACE	TYPE	NAME	APP	READY
AGE				
default	web	nginx4	<empty>	Ready
7d9h				
default	web	petclinic2	<empty>	Ready
30h				
default	web	rmq-sample-app	<empty>	Ready
179m				
default	web	rmq-sample-app4	<empty>	WorkloadLabelsMissing
29d				
default	web	spring-pet-clinic	<empty>	Unknown
3h1m				
default	web	spring-petclinic2	spring-petclinic	Unknown
29d				
default	web	spring-petclinic3	spring-petclinic	Ready
29d				
default	web	tanzu-java-web-app	tanzu-java-web-app	Ready
40m				
default	web	tanzu-java-web-app2	tanzu-java-web-app	Ready
20m				
nginx-ns	web	nginx2	<empty>	TemplateRejectedByAPISer
ver 8d				
nginx-ns	web	nginx4	<empty>	TemplateRejectedByAPISer
ver 8d				

--app

Shows workloads which application is the one specified in the command.

```
tanzu apps workload list --app spring-petclinic
```

NAME	TYPE	READY	AGE
spring-petclinic2	web	Unknown	29d
spring-petclinic3	web	Ready	29d

--namespace, -n

Lists all the workloads present in the specified namespace.

```
tanzu apps workload list -n my-namespace
```

NAME	TYPE	APP	READY	AGE
app1	web	<empty>	TemplateRejectedByAPIServer	8d
app2	web	<empty>	Ready	8d
app3	web	<empty>	Unknown	8d

--output, -o

Lists all workloads in the specified namespace in yaml, yml or json format.

- yaml/yml

```
---
- apiVersion: carto.run/v1alpha1
  kind: Workload
  metadata:
```

```

creationTimestamp: "2022-05-17T22:06:49Z"
generation: 1
labels:
  app.kubernetes.io/part-of: tanzu-java-web-app
  apps.tanzu.vmware.com/workload-type: web
managedFields:
  ...
  ...
  manager: cartographer
  operation: Update
  time: "2022-05-17T22:06:52Z"
name: tanzu-java-web-app2
namespace: default
resourceVersion: "6071972"
uid: 7fbcd40d-4eb3-41dc-a1db-657b64148708
spec:
  source:
    git:
      ref:
        tag: tap-1.3
      url: https://github.com/vmware-tanzu/application-accelerator-samples
      subPath: tanzu-java-web-app
    ...
    ...
    ---
- apiVersion: carto.run/v1alpha1
kind: Workload
metadata:
  creationTimestamp: "2022-05-17T22:06:49Z"
  generation: 1
  labels:
    app.kubernetes.io/part-of: tanzu-java-web-app
    apps.tanzu.vmware.com/workload-type: web
  managedFields:
    ...
    ...
  manager: cartographer
  operation: Update
  time: "2022-05-17T22:06:52Z"
name: tanzu-java-web-app
namespace: default
resourceVersion: "6071972"
uid: 7fbcd40d-4eb3-41dc-a1db-657b64148708
spec:
  source:
    git:
      ref:
        tag: tap-1.3
      url: https://github.com/vmware-tanzu/application-accelerator-samples
      subPath: tanzu-java-web-app
    ...
    ...

```

- json

```

[
  {
    "kind": "Workload",
    "apiVersion": "carto.run/v1alpha1",
    "metadata": {
      "name": "tanzu-java-web-app2",
      "namespace": "default",
      "uid": "7fbcd40d-4eb3-41dc-a1db-657b64148708",
      "resourceVersion": "6071972",

```

```

        "generation": 1,
        "creationTimestamp": "2022-05-17T22:06:49Z",
        "labels": {
          "app.kubernetes.io/part-of": "tanzu-java-web-app",
          "apps.tanzu.vmware.com/workload-type": "web"
        },
        ...
      }
    },
    ...
  {
    "kind": "Workload",
    "apiVersion": "carto.run/v1alpha1",
    "metadata": {
      "name": "tanzu-java-web-app",
      "namespace": "default",
      "uid": "7fbcd40d-4eb3-41dc-a1db-657b64148708",
      "resourceVersion": "6071972",
      "generation": 1,
      "creationTimestamp": "2022-05-17T22:06:49Z",
      "labels": {
        "app.kubernetes.io/part-of": "tanzu-java-web-app",
        "apps.tanzu.vmware.com/workload-type": "web"
      },
      ...
    }
    ...
  },
  ...
  ...
]

```

tanzu apps workload tail

This topic tells you about the Tanzu Apps CLI `tanzu apps workload tail` command.

The `tanzu apps workload tail` checks the runtime logs of a workload.

Default view

Without timestamp set, `tanzu apps workload tail` shows the stage where it is and the related log.

```

+ spring-pet-clinic-build-1-build-pod > prepare
+ spring-pet-clinic-build-1-build-pod > detect
+ spring-pet-clinic-build-1-build-pod > analyze
+ spring-pet-clinic-build-1-build-pod > build
+ spring-pet-clinic-build-1-build-pod > restore
spring-pet-clinic-build-1-build-pod[detect] ===== Output: tanzu-buildpacks/poetry@
0.1.0 =====
spring-pet-clinic-build-1-build-pod[detect] pyproject.toml must include [tool.poetry.d
ependencies.python], see https://python-poetry.org/docs/pyproject/#dependencies-and-de
v-dependencies
spring-pet-clinic-build-1-build-pod[analyze] Restoring data for sbom from previous ima
ge
spring-pet-clinic-build-1-build-pod[detect] err: tanzu-buildpacks/poetry@0.1.0 (1)
spring-pet-clinic-build-1-build-pod[detect] ===== Output: tanzu-buildpacks/poetry@
0.1.0 =====
spring-pet-clinic-build-1-build-pod[detect] pyproject.toml must include [tool.poetry.d
ependencies.python], see https://python-poetry.org/docs/pyproject/#dependencies-and-de
v-dependencies
spring-pet-clinic-build-1-build-pod[detect] err: tanzu-buildpacks/poetry@0.1.0 (1)
spring-pet-clinic-build-1-build-pod[detect] 10 of 38 buildpacks participating
spring-pet-clinic-build-1-build-pod[detect] paketo-buildpacks/ca-certificates 3.1.0
spring-pet-clinic-build-1-build-pod[detect] paketo-buildpacks/bellsoft-liberica 9.2.0

```

```

spring-pet-clinic-build-1-build-pod[detect] paketo-buildpacks/syft 1.10.0
spring-pet-clinic-build-1-build-pod[detect] paketo-buildpacks/gradle 6.4.1
spring-pet-clinic-build-1-build-pod[detect] paketo-buildpacks/maven 6.4.0
spring-pet-clinic-build-1-build-pod[detect] paketo-buildpacks/executable-jar 6.1.0
spring-pet-clinic-build-1-build-pod[detect] paketo-buildpacks/apache-tomcat 7.2.0
spring-pet-clinic-build-1-build-pod[detect] paketo-buildpacks/dist-zip 5.2.0
spring-pet-clinic-build-1-build-pod[detect] paketo-buildpacks/spring-boot 5.8.0
spring-pet-clinic-build-1-build-pod[detect] paketo-buildpacks/image-labels 4.1.0
...
...
...

```

--component

Set the component from which the tail command should stream the logs. The values that the flag can take depend on the final deployed pods label `app.kubernetes.io/component`, for example, `build`, `run` and, `config-writer`

```

tanzu apps workload tail pet-clinic --component build

pet-clinic-build-1-build-pod[export] Adding label 'io.buildpacks.project.metadata'
pet-clinic-build-1-build-pod[export] Adding label 'org.opencontainers.image.title'
pet-clinic-build-1-build-pod[export] Adding label 'org.opencontainers.image.version'
pet-clinic-build-1-build-pod[export] Adding label 'org.springframework.boot.version'
pet-clinic-build-1-build-pod[export] Adding label 'org.opencontainers.image.source'
pet-clinic-build-1-build-pod[export] Setting default process type 'web'
pet-clinic-build-1-build-pod[export] Saving gcr.io/dalfonso-tanzu-dev-frmwrk/pet-clinic-default...
pet-clinic-build-1-build-pod[export] *** Images (sha256:2ae6154c4433d870a330a0c2fc825340c3ead2603e3d1526e47c47cb6297fffe):
pet-clinic-build-1-build-pod[export]          gcr.io/dalfonso-tanzu-dev-frmwrk/pet-clinic-default
pet-clinic-build-1-build-pod[export]          gcr.io/dalfonso-tanzu-dev-frmwrk/pet-clinic-default:b1.20220603.181107
pet-clinic-build-1-build-pod[export] Adding cache layer 'paketo-buildpacks/bellsoft-liberica:jdk'
pet-clinic-build-1-build-pod[export] Adding cache layer 'paketo-buildpacks/syft:syft'
pet-clinic-build-1-build-pod[export] Adding cache layer 'paketo-buildpacks/maven:application'
pet-clinic-build-1-build-pod[export] Adding cache layer 'paketo-buildpacks/maven:cache'
pet-clinic-build-1-build-pod[export] Adding cache layer 'cache.sbom'

```

--namespace, -n

Specifies the namespace where the workload was deployed to get logs from.

```

tanzu apps workload tail pet-clinic -n development

pet-clinic-00004-deployment-6445565f7b-ts815[workload] 2022-06-14 16:28:52.684 INFO 1
--- [          main] org.apache.catalina.core.StandardEngine : Starting Servlet engine: [Apache Tomcat/9.0.63]
+ pet-clinic-build-3-build-pod > export
pet-clinic-00004-deployment-6445565f7b-ts815[workload] 2022-06-14 16:28:52.699 INFO 1
--- [          main] o.a.c.c.C.[Tomcat-1].[localhost].[/] : Initializing Spring embedded WebApplicationContext
pet-clinic-00004-deployment-6445565f7b-ts815[workload] 2022-06-14 16:28:52.699 INFO 1
--- [          main] w.s.c.ServletWebServerApplicationContext : Root WebApplicationContext: initialization completed in 131 ms
pet-clinic-00004-deployment-6445565f7b-ts815[workload] 2022-06-14 16:28:52.755 INFO 1
--- [          main] o.s.b.a.e.web.EndpointLinksResolver : Exposing 13 endpoint(s) beneath base path '/actuator'

```



```

bG12ZS52aWV3LmFwcGxpY2F0aW9uLmZsYXZvdXJzOiBzcHJpbmctYm9vdFxuICAgICAgICB0YW56dS5hcHAubG
l2ZS52aWV3LmFwcGxpY2F0aW9uLm5hbWU6IHBlbGlnNsaW5pY1xuICAgIHNoZWZmXG4gICAgICBjb250YWluZXJz
OlxuICAgICAgLSBlbnY6XG4gICAgICAgIC0gdmFtZTogSkFwQV9UT09MX09QVElPTlNcbiAgICAgICAgICB2YW
x1ZTogLURtYW5hZ2VtZW50LmVuZHBvaW50LmhlYWx0aC5wcm9iZXMuYWRkLWFkZG10aW9uYWwtcGF0aHM9XCJ0
cnVlXCIGLURtYW5hZ2VtZW50LmVuZHBvaW50LmhlYWx0aC5zaG93LWRldGFpbHM9YWx3YXlzIC1EbWFuYWdlbW
VudC5lbnRwb2ludHMud2ViLmJhc2UtcGF0aD1cIi9hY3R1YXRvclwiIC1EbWFuYWdlbWVudC5lbnRwb2ludHMud
2ViLmV4cG9zdXJlLmLuY2x1ZGU9KiAtrG1hbmbFnZWllbnQuaGVhbnR0LnByb2Jlcy5lbnRwFibGvkPVwidHJ1ZV
wiIC1EbWFuYWdlbWVudC5zZXJ2ZXIucG9ydD1cIjgwODF0cIjgwODF0cIjgwODF0cIjgwODF0cIjgwODF0cIjgw
ODF0cIjgwODF0cIjgwODF0cIjgwODF0cIjgwODF0cIjgwODF0cIjgwODF0cIjgwODF0cIjgwODF0cIjgwODF0c
8tdGFuenUtZGV2LWZyYXdyay9wZXQtY2xpbnRlLWRLZmFlbHRac2hhMjU2OjM5NjRiNTQwNTVlZjNkNmFiNWQ3
YTM5MmVjOGU3OWJhOjg2NjczODU2NmIyOGY2OGY2OGY2OGY2OGY2OGY2OGY2OGY2OGY2OGY2OGY2OGY2OGY2OGY
9iZTpcbiAgICAgICAgICBodHRwR2V0O1xuICAgICAgICAgICAgICAgICAgICAgICAgICAgICAgICAgICAgICAgIC
b3J0Oia4MDgwXG4gICAgICAgICAgICBzY2h1bWU6IEhUVFBcbiAgICAgICAgbmFtZTogd29ya2xvYWRcbiAgIC
AgICAgcG9ydHM6XG4gICAgICAgIC0gY29udGFpbmVpY29udGFpbmVpY29udGFpbmVpY29udGFpbmVpY29udGFpb
Q1BcbiAgICAgICAgcmVhZGluZXNzUHJvYmU6XG4gICAgICAgICAgHR0cEdldDpcbiAgICAgICAgICAgICAgICAgIC
g6IC9yZWZkeXpcbiAgICAgICAgICAgICAgICAgICAgICAgICAgICAgICAgICAgICAgICAgICAgICAgICAgICAgIC
ICAgICAgICAgICAgICAgICAgICAgICAgICAgICAgICAgICAgICAgICAgICAgICAgICAgICAgICAgICAgICAgIC
I6IDEwMDBcbiAgICAgICAgICAgICAgICAgICAgICAgICAgICAgICAgICAgICAgICAgICAgICAgICAgICAgICAgIC
pet-clinic-config-writer-9fbk6-pod[step-main] + base64 --decode
pet-clinic-config-writer-9fbk6-pod[step-main] ++ cat files.json
+ pet-clinic-config-writer-kpmc6-pod > place-tools
pet-clinic-config-writer-9fbk6-pod[step-main] ++ jq -r 'to_entries | .[] | @sh "mkdir
-p $(dirname \(.key)) && echo \(.value) > \(.key)'"
+ pet-clinic-config-writer-kpmc6-pod > step-main
+ pet-clinic-config-writer-kpmc6-pod > step-init
+ pet-clinic-config-writer-kpmc6-pod > place-scripts
pet-clinic-config-writer-9fbk6-pod[step-main] + eval 'mkdir -p $(dirname \''delivery.
yaml\''') && echo \''apiVersion: serving.knative.dev/v1'
pet-clinic-config-writer-9fbk6-pod[step-main] kind: Service
pet-clinic-config-writer-9fbk6-pod[step-main] metadata:
pet-clinic-config-writer-9fbk6-pod[step-main]   name: pet-clinic
pet-clinic-config-writer-9fbk6-pod[step-main]   labels:
pet-clinic-config-writer-9fbk6-pod[step-main]     apps.tanzu.vmware.com/workload-type:
web
pet-clinic-config-writer-9fbk6-pod[step-main]     autoscaling.knative.dev/min-scale:
"1"
pet-clinic-config-writer-9fbk6-pod[step-main]     app.kubernetes.io/component: run
pet-clinic-config-writer-9fbk6-pod[step-main]     carto.run/workload-name: pet-clinic

```

--timestamp, -t

Adds the timestamp to the beginning of each log message

```

tanzu apps workload tail pet-clinic -t

pet-clinic-00002-deployment-5cc69cfdc8-t45sc[workload] 2022-06-09T18:10:07.645910625-0
5:00
pet-clinic-00002-deployment-5cc69cfdc8-t45sc[workload] 2022-06-09T18:10:07.645942876-0
5:00
pet-clinic-00002-deployment-5cc69cfdc8-t45sc[workload] 2022-06-09T18:10:07.645951930-0
5:00
pet-clinic-00002-deployment-5cc69cfdc8-t45sc[workload] 2022-06-09T18:10:07.645957151-0
5:00
pet-clinic-00002-deployment-5cc69cfdc8-t45sc[workload] 2022-06-09T18:10:07.645961411-0
5:00
pet-clinic-00002-deployment-5cc69cfdc8-t45sc[workload] 2022-06-09T18:10:07.645967316-0
5:00
pet-clinic-00002-deployment-5cc69cfdc8-t45sc[workload] 2022-06-09T18:10:07.645971010-0
5:00
pet-clinic-00002-deployment-5cc69cfdc8-t45sc[workload] 2022-06-09T18:10:07.645976591-0
5:00
pet-clinic-00002-deployment-5cc69cfdc8-t45sc[workload] 2022-06-09T18:10:07.645986474-0
5:00
pet-clinic-00002-deployment-5cc69cfdc8-t45sc[workload] 2022-06-09T18:10:07.645990521-0

```

- For installations using a **LoadBalancer**, look up the External IP address by using:

```
kubectl get -n accelerator-system service/acc-server
```

Use `http://<External-IP>` as the URL.

- For any other configuration, you can use port forwarding by using:

```
kubectl port-forward service/acc-server -n accelerator-system 8877:80
```

Use `http://localhost:8877` as the URL.

Using “ACC_SERVER_URL” environment variable

The developer can set an `ACC_SERVER_URL` environment variable to avoid having to provide the same `--server-url` flag for every command. Run `export ACC_SERVER_URL=<URL>` for the terminal session in use. If the developer explicitly specifies the `--server-url` flag, it overrides the `ACC_SERVER_URL` environment variable if it is set.

Installation

For information about installing the Tanzu CLI Accelerator plug-in, see [Install Accelerator CLI plug-in](#).

Command reference

For information about available commands, see [Command Reference](#).

Overview of Tanzu Accelerator CLI

The Tanzu Accelerator Tanzu CLI includes commands for developers and operators to create and use accelerators.

Server API connections for operators and developers

The Tanzu Accelerator CLI must connect to a server for all provided commands except for the `help` and `version` commands.

Operators typically use **create**, **update**, and **delete** commands for managing accelerators in a Kubernetes context. They also use the **fragment** commands to manage accelerator fragments. These commands require a Kubernetes context where the operator is already authenticated and is authorized to create and edit the accelerator resources. Operators can also use the **get** and **list** commands by using the same authentication. For any of these commands, the operator can specify the `--context` flag to access accelerators in a specific Kubernetes context.

Developers use the **list**, **get**, and **generate** commands for using accelerators available in an Application Accelerator server. Developers use the `--server-url` to point to the Application Accelerator server they want to use.

You can either use the proxy that is part of TAP-GUI or you can use the URL for the Application Accelerator server, if that is configured to be exposed. VMware recommends using the TAP-GUI address.

Using TAP-GUI URL

1. Specify `--server-url` as:

```
https://tap-gui.DOMAIN
```

Where `DOMAIN` defaults to the `shared.ingress_domain` value provided in the Tanzu Application Platform values file.

2. Add the following flags to the `tap-values.yaml` file when `shared.ingress_domain` is set.

```
accelerator:
  ingress:
    include: true
```

Using Application Accelerator Server URL

If you cannot use the TAP-GUI URL, the fallback is to use Application Accelerator server directly. In this case the URL depends on the configuration settings for Application Accelerator:

- For installations configured with a **shared ingress** and where the Application Accelerator server is configured to use the ingress, use `https://accelerator.<domain>` where `domain` defaults to the `shared.ingress_domain` value provided in the values file of Tanzu Application Platform.
- For installations using a **LoadBalancer**, look up the External IP address by using:

```
kubectl get -n accelerator-system service/acc-server
```

Use `http://<External-IP>` as the URL.

- For any other configuration, you can use port forwarding by using:

```
kubectl port-forward service/acc-server -n accelerator-system 8877:80
```

Use `http://localhost:8877` as the URL.

Using “ACC_SERVER_URL” environment variable

The developer can set an `ACC_SERVER_URL` environment variable to avoid having to provide the same `--server-url` flag for every command. Run `export ACC_SERVER_URL=<URL>` for the terminal session in use. If the developer explicitly specifies the `--server-url` flag, it overrides the `ACC_SERVER_URL` environment variable if it is set.

Installation

For information about installing the Tanzu CLI Accelerator plug-in, see [Install Accelerator CLI plug-in](#).

Command reference

For information about available commands, see [Command Reference](#).

Install Tanzu Accelerator CLI

This topic tells you how to install the Tanzu Accelerator CLI.



Note

Follow the steps in this topic if you do not want to use a profile to install Tanzu Accelerator CLI. For more information about profiles, see [About Tanzu Application](#)

Prerequisites

Before you install the Tanzu Accelerator CLI:

- Follow the instructions to [Install or update the Tanzu CLI and plug-ins](#).

Install

To install the Tanzu Accelerator CLI:

1. From the `$HOME/tanzu` directory, run:

```
tanzu plugin install --local ./cli accelerator
```

2. To verify that the CLI is installed correctly, run:

```
tanzu accelerator version
```

A version will be displayed in the output.

If the following error is displayed during installation:

```
Error: could not find plug-in "accelerator" in any known repositories
✘ could not find plug-in "accelerator" in any known repositories
```

Verify that there is an `accelerator` entry in the `cli/manifest.yaml` file:

```
plugins:
...
- name: accelerator
  description: Manage accelerators in a Kubernetes cluster
  versions: []
```

Command reference

This topic provides you with a list of the Tanzu Accelerator CLI commands.

- `tanzu accelerator`
 - `tanzu accelerator apply`
 - `tanzu accelerator create`
 - `tanzu accelerator delete`
 - `tanzu accelerator fragment`
 - `tanzu accelerator fragment create`
 - `tanzu accelerator fragment delete`
 - `tanzu accelerator fragment get`
 - `tanzu accelerator fragment list`
 - `tanzu accelerator fragment update`
 - `tanzu accelerator generate`
 - `tanzu accelerator generate-from-local`

- [tanzu accelerator get](#)
- [tanzu accelerator list](#)
- [tanzu accelerator push](#)
- [tanzu accelerator update](#)

tanzu accelerator

This topic tells you how to use the Tanzu Accelerator CLI `tanzu accelerator` command to manage accelerators in a Kubernetes cluster.

Options

```
--context name      name of the kubeconfig context to use (default is current-co
ntext defined by kubeconfig)
-h, --help          help for accelerator
--kubeconfig file   kubeconfig file (default is $HOME/.kube/config)
```

SEE ALSO

- [tanzu accelerator apply](#) - Apply accelerator resource
- [tanzu accelerator create](#) - Create a new accelerator
- [tanzu accelerator delete](#) - Delete an accelerator
- [tanzu accelerator fragment create](#) - Create a fragment
- [tanzu accelerator generate](#) - Generate project from accelerator
- [tanzu accelerator generate-from-local](#) - Generate a project from local or registered accelerators/fragments
- [tanzu accelerator get](#) - Get accelerator information
- [tanzu accelerator list](#) - List accelerators
- [tanzu accelerator push](#) - Push local path to source image
- [tanzu accelerator update](#) - Update an accelerator

tanzu accelerator

This topic tells you how to use the Tanzu Accelerator CLI `tanzu accelerator` command to manage accelerators in a Kubernetes cluster.

Options

```
--context name      name of the kubeconfig context to use (default is current-co
ntext defined by kubeconfig)
-h, --help          help for accelerator
--kubeconfig file   kubeconfig file (default is $HOME/.kube/config)
```

SEE ALSO

- [tanzu accelerator apply](#) - Apply accelerator resource
- [tanzu accelerator create](#) - Create a new accelerator
- [tanzu accelerator delete](#) - Delete an accelerator

- [tanzu accelerator fragment create](#) - Create a fragment
- [tanzu accelerator generate](#) - Generate project from accelerator
- [tanzu accelerator generate-from-local](#) - Generate a project from local or registered accelerators/fragments
- [tanzu accelerator get](#) - Get accelerator information
- [tanzu accelerator list](#) - List accelerators
- [tanzu accelerator push](#) - Push local path to source image
- [tanzu accelerator update](#) - Update an accelerator

tanzu accelerator apply

This topic tells you how to use the Tanzu Accelerator CLI `tanzu accelerator apply` command to create or update accelerators.

Synopsis

Create or update accelerator resource using specified manifest file.

```
tanzu accelerator apply [flags]
```

Examples

```
tanzu accelerator apply --filename <path-to-resource-manifest>
```

Options

```
-f, --filename string    path of manifest file for the resource
-h, --help              help for apply
-n, --namespace string  namespace for the resource (default "accelerator-system")
```

Options inherited from parent commands

```
--context name          name of the kubeconfig context to use (default is current-co
ntext defined by kubeconfig)
--kubeconfig file       kubeconfig file (default is $HOME/.kube/config)
```

SEE ALSO

- [tanzu accelerator](#) - Manage accelerators in a Kubernetes cluster

tanzu accelerator create

This topic tells you how to use the Tanzu Accelerator CLI `tanzu accelerator create` command to create a new accelerator.

Synopsis

Create a new accelerator resource with specified configuration.

Accelerator configuration options include:

- Git repository URL and branch/tag where accelerator code and metadata is defined
- Metadata like description, display-name, tags, and icon-url

The Git repository option is required. Metadata options are optional and override any values for the same options specified in the accelerator metadata retrieved from the Git repository.

```
tanzu accelerator create [flags]
```

Examples

```
tanzu accelerator create <accelerator-name> --git-repository <URL> --git-branch <branch>
```

Options

```
--description string      description of this accelerator
--display-name string     display name for the accelerator
--git-branch string       Git repository branch to be used (default "main")
--git-repo string         Git repository URL for the accelerator
--git-sub-path string     Git repository subPath to be used
--git-tag string          Git repository tag to be used
-h, --help                help for create
--icon-url string         URL for icon to use with the accelerator
--interval string        interval for checking for updates to Git or image repository
--local-path string       path to the directory containing the source for the accelerator
-n, --namespace string    namespace for accelerator system (default "accelerator-system")
--secret-ref string       name of secret containing credentials for private Git or image repository
--source-image string     name of the source image for the accelerator
--tags strings            tags that can be used to search for accelerators
```

Options inherited from parent commands

```
--context name           name of the kubeconfig context to use (default is current-context defined by kubeconfig)
--kubeconfig file        kubeconfig file (default is $HOME/.kube/config)
```

SEE ALSO

[tanzu accelerator](#)

tanzu accelerator delete

This topic tells you how to use the Tanzu Accelerator CLI `tanzu accelerator delete` command to delete an accelerator.

Synopsis

Delete the accelerator resource with the specified name.

```
tanzu accelerator delete [flags]
```

Examples

```
tanzu accelerator delete <accelerator-name>
```

Options

```
-h, --help           help for delete
-n, --namespace string namespace for accelerator system (default "accelerator-system")
```

Options inherited from parent commands

```
--context name      name of the kubeconfig context to use (default is current-context defined by kubeconfig)
--kubeconfig file   kubeconfig file (default is $HOME/.kube/config)
```

SEE ALSO

- [tanzu accelerator](#) - Manage accelerators in a Kubernetes cluster

tanzu accelerator fragment

This topic tells you how to use the Tanzu Accelerator CLI `tanzu accelerator fragment` command to manage fragments.

Synopsis

Commands to manage accelerator fragments

Examples

```
tanzu accelerator fragment --help
```

Options

```
-h, --help  help for fragment
```

Options inherited from parent commands

```
--context name      name of the kubeconfig context to use (default is current-context defined by kubeconfig)
--kubeconfig file   kubeconfig file (default is $HOME/.kube/config)
```

SEE ALSO

- [Using accelerator fragments](#)
- [tanzu accelerator](#) - Manage accelerators in a Kubernetes cluster

- [tanzu accelerator fragment create](#) - Create a new accelerator fragment
- [tanzu accelerator fragment delete](#) - Delete an accelerator fragment
- [tanzu accelerator fragment get](#) - Get accelerator fragment information
- [tanzu accelerator fragment list](#) - List accelerator fragments
- [tanzu accelerator fragment update](#) - Update an accelerator fragment

tanzu accelerator fragment create

This topic tells you how to use the Tanzu Accelerator CLI `tanzu accelerator fragment create` command to create a new accelerator fragment.

Synopsis

Create a new accelerator fragment resource with specified configuration.

Accelerator configuration options include:

- Git repository URL and branch/tag where accelerator code and metadata is defined
- Metadata like description, display-name, tags and icon-url

The Git repository option is required. Metadata options are optional and will override any values for the same options specified in the accelerator metadata retrieved from the Git repository.

```
tanzu accelerator fragment create [flags]
```

Example

```
tanzu accelerator fragment create <fragment-name> --git-repository <URL> --git-branch
<branch> --git-sub-path <sub-path>
```

Options

```
--display-name string  display name for the accelerator fragment
--git-branch string    Git repository branch to be used (default "main")
--git-repo string      Git repository URL for the accelerator fragment
--git-sub-path string  Git repository subPath to be used
--git-tag string       Git repository tag to be used
-h, --help             help for create
--interval string     interval for checking for updates to Git or image repository
--local-path string   path to the directory containing the source for the accelerator fragment
-n, --namespace string namespace for accelerator system (default "accelerator-system")
--secret-ref string   name of secret containing credentials for private Git or image repository
--source-image string name of the source image for the accelerator
```

Options inherited from parent commands

```
--context name        name of the kubeconfig context to use (default is current-context defined by kubeconfig)
--kubeconfig file     kubeconfig file (default is $HOME/.kube/config)
```

SEE ALSO

[tanzu accelerator fragment](#)

tanzu accelerator fragment delete

This topic tells you how to use the Tanzu Accelerator CLI `tanzu accelerator fragment delete` command to delete an accelerator fragment.

Synopsis

Delete the accelerator fragment resource with the specified name.

```
tanzu accelerator fragment delete [flags]
```

Examples

```
tanzu accelerator fragment delete <fragment-name>
```

Options

```
-h, --help                help for delete
-n, --namespace string    namespace for accelerator system (default "accelerator-system")
```

Options inherited from parent commands

```
--context name           name of the kubeconfig context to use (default is current-context defined by kubeconfig)
--kubeconfig file        kubeconfig file (default is $HOME/.kube/config)
```

SEE ALSO

[tanzu accelerator fragment](#)

tanzu accelerator fragment get

This topic tells you how to use the Tanzu Accelerator CLI `tanzu accelerator fragment get` command to get accelerator fragment information.

Synopsis

Get accelerator fragment information.

```
tanzu accelerator fragment get [flags]
```

Examples

```
tanzu accelerator get <fragment-name>
```

Options

```
-h, --help           help for get
-n, --namespace string namespace for accelerator system (default "accelerator-system")
```

Options inherited from parent commands

```
--context name      name of the kubeconfig context to use (default is current-context defined by kubeconfig)
--kubeconfig file   kubeconfig file (default is $HOME/.kube/config)
```

SEE ALSO

- [tanzu accelerator fragment](#) - Fragment commands

tanzu accelerator fragment list

This topic tells you how to use the Tanzu Accelerator CLI `tanzu accelerator fragment list` to list accelerator fragments.

Synopsis

List all accelerator fragments.

```
tanzu accelerator fragment list [flags]
```

Examples

```
tanzu accelerator fragment list
```

Options

```
-h, --help           help for list
-n, --namespace string namespace for accelerator system (default "accelerator-system")
-v, --verbose        include repository and show long URLs or image digests in the output
```

Options inherited from parent commands

```
--context name      name of the kubeconfig context to use (default is current-context defined by kubeconfig)
--kubeconfig file   kubeconfig file (default is $HOME/.kube/config)
```

SEE ALSO

[tanzu accelerator fragment](#)

tanzu accelerator fragment update

This topic tells you how to use the Tanzu Accelerator CLI `tanzu accelerator fragment update` command to update an accelerator fragment.

Synopsis

Update an accelerator fragment resource with the specified name using the specified configuration.

Accelerator configuration options include: - Git repository URL and branch/tag where accelerator code and metadata is defined - Metadata like display-name

The update command also provides a `--reconcile` flag that will force the accelerator fragment to be refreshed with any changes made to the associated Git repository.

```
tanzu accelerator fragment update [flags]
```

Examples

```
tanzu accelerator update <accelerator-name> --description "Lorem Ipsum"
```

Options

```

--display-name string  display name for the accelerator fragment
--git-branch string    Git repository branch to be used
--git-repo string      Git repository URL for the accelerator fragment
--git-sub-path string  Git repository subPath to be used
--git-tag string       Git repository tag to be used
-h, --help            help for update
--interval string     interval for checking for updates to Git repository
-n, --namespace string namespace for accelerator fragments (default "accelerato
r-system")
--reconcile           trigger a reconciliation including the associated GitRep
ository resource
--secret-ref string   name of secret containing credentials for private Git re
pository

```

Options inherited from parent commands

```

--context name        name of the kubeconfig context to use (default is current-co
nfig)
--kubeconfig file    kubeconfig file (default is $HOME/.kube/config)

```

SEE ALSO

- [tanzu accelerator fragment](#) - Fragment commands

tanzu accelerator generate

tanzu accelerator generate

This topic tells you how to use the Tanzu Accelerator CLI `tanzu accelerator generate` command to generate a project from an accelerator.

Synopsis

Generate a project from an accelerator using provided options and download project artifacts as a ZIP file.

Generation options are provided as a JSON string and should match the metadata options that are specified for the accelerator used for the generation. The options can include “projectName” which defaults to the name of the accelerator. This “projectName” will be used as the name of the generated ZIP file.

You can see the available options by using the “tanzu accelerator get ” command.

Here is an example of an options JSON string that specifies the “projectName” and an “includeKubernetes” boolean flag:

```
--options '{"projectName":"test", "includeKubernetes": true}'
```

You can also provide a file that specifies the JSON string using the `-options-file` flag.

The generate command needs access to the Application Accelerator server. You can specify the `-server-url` flag or set an `ACC_SERVER_URL` environment variable. If you specify the `-server-url` flag it overrides the `ACC_SERVER_URL` environment variable if it is set.

```
tanzu accelerator generate [flags]
```

Examples

```
tanzu accelerator generate <accelerator-name> --options '{"projectName":"test"}'
```

Options

```
-h, --help                help for generate
--options string          options JSON string
--options-file string     path to file containing options JSON string
--output-dir string       directory that the zip file will be written to
--server-url string       the URL for the Application Accelerator server
```

Options inherited from parent commands

```
--context name           name of the kubeconfig context to use (default is current-co
ntext defined by kubeconfig)
--kubeconfig file        kubeconfig file (default is $HOME/.kube/config)
```

SEE ALSO

- [tanzu accelerator](#) - Manage accelerators in a Kubernetes cluster

tanzu accelerator generate-from-local

This topic tells you how to use the Tanzu Accelerator CLI `tanzu accelerator generate-from-local` command to generate a project from a combination of registered and local artifacts.

Synopsis

Generate a project from a combination of local files and registered accelerators/fragments using provided options and download project artifacts as a ZIP file.

Options values are provided as a JSON object and should match the declared options that are specified for the accelerator used for the generation. The options can include “projectName” which

defaults to the name of the accelerator. This “projectName” is used as the name of the generated ZIP file.

Here is an example of an options JSON string that specifies the “projectName” and an “includeKubernetes” Boolean flag:

```
--options '{"projectName":"test", "includeKubernetes": true}'
```

You can also provide a file that specifies the JSON string using the `--options-file` flag.

The `generate-from-local` command needs access to the Application Accelerator server. You can specify the `--server-url` flag or set an `ACC_SERVER_URL` environment variable. If you specify the `--server-url` flag it overrides the `ACC_SERVER_URL` environment variable if it is set.

```
tanzu accelerator generate-from-local [flags]
```

Examples

```
tanzu accelerator generate-from-local --accelerator-path java-rest=workspace/java-rest
--fragment-paths java-version=workspace/version --fragment-names tap-workload --option
s '{"projectName":"test"}
```

Options

```
--accelerator-name string          name of the registered accelerator to use
--accelerator-path "key=value" pair key value pair of the name and path to the
directory containing the accelerator
-f, --force                        force clean and rewrite of output-dir
--fragment-names strings           names of the registered fragments to use
--fragment-paths stringToString    key value pairs of the name and path to th
e directory containing each fragment (default [])
-h, --help                          help for generate-from-local
--options string                   options JSON string (default "{}")
--options-file string              path to file containing options JSON strin
g
-o, --output-dir string            the directory that the project will be cre
ated in (defaults to the project name)
--server-url string                the URL for the Application Accelerator se
rver
```

Options inherited from parent commands

```
--context name          name of the kubeconfig context to use (default is current-co
nfig)
--kubeconfig file       kubeconfig file (default is $HOME/.kube/config)
```

SEE ALSO

[tanzu accelerator](#)

tanzu accelerator get

This topic tells you how to use the Tanzu Accelerator CLI `tanzu accelerator get` command to get accelerator information.

Synopsis

Get accelerator information.

You can choose to get the accelerator from the Application Accelerator server using `--server-url` flag or from a Kubernetes context using `--from-context` flag. The default is to get accelerators from the Kubernetes context. To override this, you can set the `ACC_SERVER_URL` environment variable with the URL for the Application Accelerator server you want to access.

```
tanzu accelerator get [flags]
```

Examples

```
tanzu accelerator get <accelerator-name> --from-context
```

Options

```

--from-context      retrieve resources from current context defined in kubecon
fig
-h, --help          help for get
-n, --namespace string namespace for accelerator system (default "accelerator-sys
tem")
--server-url string the URL for the Application Accelerator server
-v, --verbose       include all fields and show long URLs in the output

```

Options inherited from parent commands

```

--context name      name of the kubeconfig context to use (default is current-co
nfig)
--kubeconfig file   kubeconfig file (default is $HOME/.kube/config)

```

SEE ALSO

[tanzu accelerator](#)

tanzu accelerator list

This topic tells you how to use the Tanzu Accelerator CLI `tanzu accelerator list` command to list accelerators.

Synopsis

List all accelerators.

You can choose to list the accelerators from the Application Accelerator server using `--server-url` flag or from a Kubernetes context using `--from-context` flag. The default is to list accelerators from the Kubernetes context. To override this, you can set the `ACC_SERVER_URL` environment variable with the URL for the Application Accelerator server you want to access.

```
tanzu accelerator list [flags]
```

Examples

```
tanzu accelerator list
```

Options

```

--from-context      retrieve resources from the current context defined in kub
econfig
-h, --help          help for list
-n, --namespace string namespace for accelerator system (default "accelerator-sys
tem")
--server-url string the URL for the Application Accelerator server
-t, --tags strings  accelerator tags to match against
-v, --verbose       include repository and show long URLs or image digests in
the output

```

Options inherited from parent commands

```

--context name      name of the kubeconfig context to use (default is current-co
nfig context defined by kubeconfig)
--kubeconfig file   kubeconfig file (default is $HOME/.kube/config)

```

SEE ALSO

[tanzu accelerator](#)

tanzu accelerator push

This topic tells you how to use the Tanzu Accelerator CLI `tanzu accelerator push` command to push source code from local path to source image.

Synopsis

Push source code from local path to source image used by an accelerator

```
tanzu accelerator push [flags]
```

Examples

```
tanzu accelerator push --local-path <local path> --source-image <image>
```

Options

```

-h, --help          help for push
--local-path string path to the directory containing the source for the acce
lerator
--source-image string name of the source image for the accelerator

```



Note

When you run the `tanzu accelerator push` command, `--source-image` is only required if the registry being used is not handled by Local Source Proxy.

Configure Local Source Proxy

For information about Local Source Proxy, see [Overview of Local Source Proxy](#).

If Local Source Proxy cannot be configured, use a source image registry. Before deploying a workload, you must authenticate with an image registry to store your source code.

Options inherited from parent commands

```
--context name      name of the kubeconfig context to use (default is current-co
ntext defined by kubeconfig)
--kubeconfig file   kubeconfig file (default is $HOME/.kube/config)
```

SEE ALSO

- [tanzu accelerator](#) - Manage accelerators in a Kubernetes cluster

tanzu accelerator update

This topic tells you how to use the Tanzu Accelerator CLI `tanzu accelerator update` command to update an accelerator.

Synopsis

Update an accelerator resource with the specified name using the specified configuration.

Accelerator configuration options include: - Git repository URL and branch/tag where accelerator code and metadata is defined - Metadata like description, display-name, tags and icon-url

The update command also provides a `-reconcile` flag that will force the accelerator to be refreshed with any changes made to the associated Git repository.

```
tanzu accelerator update [flags]
```

Examples

```
tanzu accelerator update <accelerator-name> --description "Lorem Ipsum"
```

Options

```
--description string      description of this accelerator
--display-name string     display name for the accelerator
--git-branch string       Git repository branch to be used
--git-repo string         Git repository URL for the accelerator
--git-sub-path string     Git repository subPath to be used
--git-tag string          Git repository tag to be used
-h, --help                help for update
--icon-url string         URL for icon to use with the accelerator
--interval string         interval for checking for updates to Git or image reposi
tory
-n, --namespace string    namespace for accelerator system (default "accelerator-s
ystem")
--reconcile               trigger a reconciliation including the associated GitRep
ository resource
--secret-ref string       name of secret containing credentials for private Git or
image repository
```

```
--source-image string  name of the source image for the accelerator
--tags strings         tags that can be used to search for accelerators
```

Options inherited from parent commands

```
--context name          name of the kubeconfig context to use (default is current-co
ncontext defined by kubeconfig)
--kubeconfig file      kubeconfig file (default is $HOME/.kube/config)
```

SEE ALSO

- [tanzu accelerator](#) - Manage accelerators in a Kubernetes cluster

Overview of Build Service CLI plug-in

Use the Build Service CLI plug-in to view all the Tanzu Build Service resources on any Kubernetes cluster that has Tanzu Application Platform or Tanzu Build Service installed.

Command reference

For information about all available commands, see [Command Reference](#).

Image Command

Use the `image` command to interact with the kpack image resource that is created by the supply chain.

Image List

To list all the images in the workload namespace, run:

```
tanzu build-service image list -n WORKLOAD-NAMESPACE
```

Image Status

To get the status of a specific image, run:

```
tanzu build-service image status IMAGE_NAME -n WORKLOAD-NAMESPACE
```

This displays information about the latest build, what triggered the latest build, source information, and a general status message.

If the previous build has finished you can see the buildpacks that were used.

Build Command

Use the `build` command to investigate and debug failures with builds.

Build List

To see all the builds associated with an image, run:

```
tanzu build-service build list IMAGE_NAME -n WORKLOAD-NAMESPACE
```

Build Status

To view more details about the latest build, run:

```
tanzu build-service build status IMAGE_NAME -n WORKLOAD-NAMESPACE
```

To view details about a particular build, run:

```
tanzu build-service build status IMAGE-NAME -n WORKLOAD-NAMESPACE --build BUILD-NUMBER
```

Build Logs

To view logs from the latest build, run:

```
tanzu build-service build logs IMAGE-NAME -n WORKLOAD-NAMESPACE
```

For details about a particular build, run:

```
tanzu build-service build logs IMAGE-NAME -n WORKLOAD-NAMESPACE --build BUILD-NUMBER
```

ClusterBuilder Command

Use the `clusterbuilder` command to list available builders and examine their contents.

ClusterBuilder List

To list all ClusterBuilders that can be used by a workload, run:

```
tanzu build-service clusterbuilder list
```

To see a detailed view of all the buildpack versions inside a ClusterBuilder:

```
tanzu build-service clusterbuilder status CLUSTERBUILDER-NAME
```

ClusterBuildpack Command

Use the `clusterbuildpack` command to list information about available buildpacks.

ClusterBuildpack List

To list all language-family ClusterBuildpacks, run:

```
tanzu build-service clusterbuildpack list
```

To see a detailed view of a particular language-family buildpack and see its component buildpack versions, run:

```
tanzu build-service clusterbuildpack status CLUSTERBUILDPACK-NAME
```

tanzu build-service

This topic tells you about Tanzu Build Service CLI plug-in options.

Options

```
-h, --help help for build-service
```

SEE ALSO

- [tanzu build-service build](#) - Build Commands
- [tanzu build-service builder](#) - Builder Commands
- [tanzu build-service buildpack](#) - Buildpack Commands
- [tanzu build-service clusterbuilder](#) - ClusterBuilder Commands
- [tanzu build-service clusterbuildpack](#) - ClusterBuildpack Commands
- [tanzu build-service clusterstack](#) - ClusterStack Commands
- [tanzu build-service clusterstore](#) - ClusterStore Commands
- [tanzu build-service image](#) - Image commands

tanzu build-service build

This topic tells you about the Tanzu Build Service CLI `tanzu build-service build` command options.

Options

```
-h, --help  help for build
```

SEE ALSO

- [tanzu build-service](#) - plug-in to interact with Tanzu Build Service (TBS) crds
- [tanzu build-service build list](#) - List builds
- [tanzu build-service build logs](#) - Tails logs for an image resource build
- [tanzu build-service build status](#) - Display status for an image resource build

tanzu build-service builder

This topic tells you about the Tanzu Build Service CLI `tanzu build-service builder` command options.

Options

```
-h, --help  help for builder
```

SEE ALSO

- [tanzu build-service](#) - plug-in to interact with Tanzu Build Service (TBS) crds
- [tanzu build-service builder list](#) - List available builders
- [tanzu build-service builder status](#) - Display status of a builder

tanzu build-service builder list

This topic tells you how to use the Tanzu Build Service CLI `tanzu build-service build list` command to list available builders.

Synopsis

Prints a table of the most important information about the available builders in the provided namespace.

The namespace defaults to the kubernetes current-context namespace.

```
tanzu build-service builder list [flags]
```

Examples

```
tanzu build-service builder list
tanzu build-service builder list -n my-namespace
```

Options

```
-h, --help           help for list
-n, --namespace string kubernetes namespace
```

SEE ALSO

- [tanzu build-service builder](#) - Builder Commands

tanzu build-service builder status

This topic tells you how to use the Tanzu Build Service CLI `tanzu build-service builder status` command to display the status of a builder.

Synopsis

Prints detailed information about the status of a specific builder in the provided namespace.

The namespace defaults to the kubernetes current-context namespace.

```
tanzu build-service builder status <name> [flags]
```

Examples

```
tanzu build-service builder status my-builder
tanzu build-service builder status -n my-namespace other-builder
```

Options

```
-h, --help           help for status
-n, --namespace string kubernetes namespace
```

SEE ALSO

- [tanzu build-service builder](#) - Builder Commands

tanzu build-service buildpack

This topic tells you about the Tanzu Build Service CLI `tanzu build-service buildpack` command options.

Options

```
-h, --help    help for buildpack
```

SEE ALSO

- [tanzu build-service](#) - plug-in to interact with Tanzu Build Service (TBs) crds
- [tanzu build-service buildpack list](#) - List available buildpacks
- [tanzu build-service buildpack status](#) - Display status of a buildpack

tanzu build-service buildpack list

This topic tells you how to use the Tanzu Build Service CLI `build-service buildpack list` command to lists available buildpacks.

Synopsis

Prints a table of the most important information about the available buildpacks in the provided namespace.

The namespace defaults to the kubernetes current-context namespace.

```
tanzu build-service buildpack list [flags]
```

Examples

```
tanzu build-service buildpack list
tanzu build-service buildpack list -n my-namespace
```

Options

```
-h, --help            help for list
-n, --namespace string kubernetes namespace
```

SEE ALSO

- [tanzu build-service buildpack](#) - Buildpack Commands

tanzu build-service buildpack status

This topic tells you how to use the Tanzu Build Service CLI `build-service buildpack status` command to display the status of a buildpack.

Synopsis

Prints detailed information about the status of a specific buildpack in the provided namespace.

The namespace defaults to the kubernetes current-context namespace.

```
tanzu build-service buildpack status <name> [flags]
```

Examples

```
tanzu build-service buildpack status my-buildpack
tanzu build-service buildpack status -n my-namespace other-buildpack
```

Options

```
-h, --help           help for status
-n, --namespace string kubernetes namespace
```

SEE ALSO

- [tanzu build-service buildpack](#) - Buildpack Commands

tanzu build-service build list

This topic tells you how to use the Tanzu Build Service CLI `tanzu build-service build list` command to lists builds.

Synopsis

Prints a table of the most important information about builds in the provided namespace.

The namespace defaults to the Kubernetes current-context namespace.

```
tanzu build-service build list [image-resource-name] [flags]
```

Examples

```
tanzu build-service build list
tanzu build-service build list my-image
tanzu build-service build list my-image -n my-namespace
```

Options

```
-h, --help           help for list
-n, --namespace string kubernetes namespace
```

SEE ALSO

- [tanzu build-service build](#) - Build Commands

tanzu build-service build logs

This topic tells you how to use the Tanzu Build Service CLI `tanzu build-service build logs` command to tails logs.

Synopsis

Tails logs from the containers of a specific build of an image resource in the provided namespace. The build defaults to the latest build number. The namespace defaults to the kubernetes current-context namespace.

```
tanzu build-service build logs <image-name> [flags]
```

Examples

```
tanzu build-service build logs my-image
tanzu build-service build logs my-image -b 2 -n my-namespace
```

Options

```
-b, --build string      build number
-h, --help              help for logs
-n, --namespace string  kubernetes namespace
```

SEE ALSO

- [tanzu build-service build](#) - Build Commands

tanzu build-service build status

This topic tells you how to use the Tanzu Build Service CLI `tanzu build-service build status` command to display the status for an image resource build.

Synopsis

Prints detailed information about the status of a specific build of an image resource in the provided namespace.

The build defaults to the latest build number. The namespace defaults to the kubernetes current-context namespace.

```
tanzu build-service build status <image-name> [flags]
```

Examples

```
tanzu build-service build status my-image
tanzu build-service build status my-image -b 2 -n my-namespace
```

Options

```
-b, --build string      build number
-h, --help              help for status
-n, --namespace string  kubernetes namespace
```

SEE ALSO

- [tanzu build-service build](#) - Build Commands

tanzu build-service clusterbuilder

This topic tells you about the Tanzu Build Service CLI `tanzu build-service clusterbuilder` command options.

Options

```
-h, --help  help for clusterbuilder
```

SEE ALSO

- [tanzu build-service](#) - plug-in to interact with Tanzu Build Service (TBS) crds
- [tanzu build-service clusterbuilder list](#) - List available cluster builders
- [tanzu build-service clusterbuilder status](#) - Display cluster builder status

tanzu build-service clusterbuilder list

This topic tells you how to use the Tanzu Build Service CLI `tanzu build-service clusterbuilder list` command to list available cluster builders.

Synopsis

This command prints a table of the most important information about the available cluster builders.

```
tanzu build-service clusterbuilder list [flags]
```

Examples

```
tanzu build-service clusterbuilder list
```

Options

```
-h, --help  help for list
```

SEE ALSO

- [tanzu build-service clusterbuilder](#) - ClusterBuilder Command

tanzu build-service clusterbuilder status

This topic tells you how to use the Tanzu Build Service CLI `tanzu build-service clusterbuilder status` command to display cluster builder status.

Synopsis

Prints detailed information about the status of a specific cluster builder.

```
tanzu build-service clusterbuilder status <name> [flags]
```

Examples

```
tanzu build-service clusterbuilder status my-builder
```

Options

```
-h, --help help for status
```

SEE ALSO

- [tanzu build-service clusterbuilder](#) - ClusterBuilder Commands

tanzu build-service clusterbuildpack

This topic tells you about the Tanzu Build Service CLI `tanzu build-service clusterbuildpack` command options.

Options

```
-h, --help help for clusterbuildpack
```

SEE ALSO

- [tanzu build-service](#) - plug-in to interact with Tanzu Build Service (TBS) crds
- [tanzu build-service clusterbuildpack list](#) - List available cluster buildpacks
- [tanzu build-service clusterbuildpack status](#) - Display status of a buildpack

tanzu build-service clusterbuildpack list

This topic tells you how to use the Tanzu Build Service CLI `tanzu build-service clusterbuildpack list` command to lists available cluster buildpacks.

Synopsis

Prints a table of the most important information about the available cluster buildpacks in the provided namespace.

```
tanzu build-service clusterbuildpack list [flags]
```

Examples

```
tanzu build-service clusterbuildpack list
```

Options

```
-h, --help help for list
```

SEE ALSO

- [tanzu build-service clusterbuildpack](#) - ClusterBuildpack Commands

tanzu build-service clusterbuildpack status

This topic tells you how to use the Tanzu Build Service CLI `tanzu build-service clusterbuildpack status` command to display the status of a buildpack.

Synopsis

Prints detailed information about the status of a specific buildpack in the provided namespace.

The namespace defaults to the kubernetes current-context namespace.

```
tanzu build-service clusterbuildpack status <name> [flags]
```

Examples

```
tanzu build-service clusterbuildpack status my-buildpack
```

Options

```
-h, --help           help for status
-n, --namespace string kubernetes namespace
```

SEE ALSO

- [tanzu build-service clusterbuildpack](#) - ClusterBuildpack Commands

tanzu build-service clusterstack

This topic tells you about the Tanzu Build Service CLI `tanzu build-service clusterstack` command options.

Options

```
-h, --help  help for clusterstack
```

SEE ALSO

- [tanzu build-service](#) - plug-in to interact with Tanzu Build Service (TBS) crds
- [tanzu build-service clusterstack list](#) - List cluster stacks
- [tanzu build-service clusterstack status](#) - Display cluster stack status

tanzu build-service clusterstack list

This topic tells you how to use the Tanzu Build Service CLI `tanzu build-service clusterstack status` command to list cluster stacks.

Synopsis

Prints a table of the most important information about cluster-scoped stacks in the cluster.

```
tanzu build-service clusterstack list [flags]
```

Examples

```
tanzu build-service clusterstack list
```

Options

```
-h, --help    help for list
```

SEE ALSO

- [tanzu build-service clusterstack](#) - ClusterStack Commands

tanzu build-service clusterstack status

This topic tells you how to use the Tanzu Build Service CLI `tanzu build-service clusterstack status` command to display cluster stack status.

Synopsis

Prints detailed information about the status of a specific cluster-scoped stack.

```
tanzu build-service clusterstack status <name> [flags]
```

Examples

```
tanzu build-service clusterstack status my-stack
```

Options

```
-h, --help    help for status
-v, --verbose display mixins
```

SEE ALSO

- [tanzu build-service clusterstack](#) - ClusterStack Commands

tanzu build-service clusterstore

This topic tells you about the Tanzu Build Service CLI `tanzu build-service clusterstore` command options.

Options

```
-h, --help    help for clusterstore
```

SEE ALSO

- [tanzu build-service](#) - plug-in to interact with Tanzu Build Service (TBS) crds
- [tanzu build-service clusterstore list](#) - List cluster stores
- [tanzu build-service clusterstore status](#) - Display cluster store status

tanzu build-service clusterstore list

This topic tells you how to use the Tanzu Build Service CLI `tanzu build-service clusterstore list` command to lists cluster stores.

Synopsis

Prints a table of the most important information about cluster-scoped stores

```
tanzu build-service clusterstore list [flags]
```

Examples

```
tanzu build-service clusterstore list
```

Options

```
-h, --help    help for list
```

SEE ALSO

- [tanzu build-service clusterstore](#) - ClusterStore Commands

tanzu build-service clusterstore status

This topic tells you how to use the Tanzu Build Service CLI `tanzu build-service clusterstore status` command to display cluster store status.

Synopsis

Prints information about the status of a specific cluster-scoped store.

```
tanzu build-service clusterstore status <store-name> [flags]
```

Examples

```
tanzu build-service clusterstore status my-store
```

Options

```
-h, --help    help for status
-v, --verbose includes buildpacks and detection order
```

SEE ALSO

- [tanzu build-service clusterstore](#) - ClusterStore Commands

tanzu build-service image

This topic tells you about the Tanzu Build Service CLI `tanzu build-service` command options.

Options

```
-h, --help  help for image
```

SEE ALSO

- [tanzu build-service](#) - plug-in to interact with Tanzu Build Service (TBS) crds
- [tanzu build-service image list](#) - List image resources
- [tanzu build-service image status](#) - Display status of an image resource
- [tanzu build-service image trigger](#) - Trigger an image resource build

tanzu build-service image list

This topic tells you how to use the Tanzu Build Service CLI `tanzu build-service image list` command to lists image resources.

Synopsis

Prints a table of the most important information about image resources in the provided namespace.

The namespace defaults to the kubernetes current-context namespace.

```
tanzu build-service image list [flags]
```

Examples

```
tanzu build-service image list
tanzu build-service image list -A
tanzu build-service image list -n my-namespace
tanzu build-service image list --filter ready=true --filter latest-reason=commit,trigger
```

Options

```
-A, --all-namespaces  Return objects found in all namespaces
--filter stringArray  Each new filter argument requires an additional filter flag.
                       Multiple values can be provided using comma separation.
                       Supported filters and values:
                           builder=string
                           clusterbuilder=string
                           latest-reason=commit,trigger,config,stack,buildpack
                           ready=true,false,unknown
-h, --help            help for list
-n, --namespace string  kubernetes namespace
```

SEE ALSO

- [tanzu build-service image](#) - Image commands

tanzu build-service image status

This topic tells you how to use the Tanzu Build Service CLI `tanzu build-service image status` command to display the status of an image resource.

Synopsis

Prints detailed information about the status of a specific image resource in the provided namespace.

The namespace defaults to the kubernetes current-context namespace.

```
tanzu build-service image status <name> [flags]
```

Examples

```
tanzu build-service image status my-image
tanzu build-service image status my-other-image -n my-namespace
```

Options

```
-h, --help           help for status
-n, --namespace string kubernetes namespace
```

SEE ALSO

- [tanzu build-service image](#) - Image commands

tanzu build-service image trigger

This topic tells you how to use the Tanzu Build Service CLI `tanzu build-service image trigger` command to trigger an image resource build.

Synopsis

Trigger a build using current inputs for a specific image resource in the provided namespace.

The namespace defaults to the kubernetes current-context namespace.

```
tanzu build-service image trigger <name> [flags]
```

Examples

```
tanzu build-service image trigger my-image
```

Options

```
-h, --help          help for trigger
-n, --namespace string kubernetes namespace
```

SEE ALSO

- [tanzu build-service image](#) - Image commands

Overview of Tanzu Insight plug-in

The Tanzu Insight CLI plug-in helps you query vulnerability, image, and package data.

Follow these steps to install, configure, and use your Tanzu Insight CLI plug-in:



Note

Before using the CLI plug-in, you must install Supply Chain Security Tools (SCST) - Store, either as its own package or as part of the Tanzu Application Platform View profile.

1. Install the Tanzu Insight plug-in. The Tanzu Insight plug-in is in the Tanzu Application Platform plug-ins group, see [Install Tanzu CLI plug-ins](#).
2. [Configure your Tanzu Insight CLI plug-in](#).

Once `tanzu insight` CLI plug-in is set up:

1. [Add data](#)
2. [Query data](#)
3. [Triage vulnerabilities](#)

Overview of Tanzu Insight plug-in

The Tanzu Insight CLI plug-in helps you query vulnerability, image, and package data.

Follow these steps to install, configure, and use your Tanzu Insight CLI plug-in:



Note

Before using the CLI plug-in, you must install Supply Chain Security Tools (SCST) - Store, either as its own package or as part of the Tanzu Application Platform View profile.

1. Install the Tanzu Insight plug-in. The Tanzu Insight plug-in is in the Tanzu Application Platform plug-ins group, see [Install Tanzu CLI plug-ins](#).
2. [Configure your Tanzu Insight CLI plug-in](#).

Once `tanzu insight` CLI plug-in is set up:

1. [Add data](#)
2. [Query data](#)
3. [Triage vulnerabilities](#)

Install your Tanzu Insight CLI plug-in

This topic tells you how to install your Tanzu Insight CLI plug-in.



Note

Follow the steps in this topic if you do not want to use a profile to install the Tanzu Insight CLI plug-in. For more information about profiles, see [About Tanzu Application Platform > components and profiles](#).

1. From your `tanzu` directory, install the local version of the Tanzu Insight plug-in you downloaded by running:

```
cd $HOME/tanzu
tanzu plugin install insight --local cli
```

2. Follow the steps in [Configure the Tanzu Insight CLI plug-in](#).

Configure your Tanzu Insight CLI plug-in

This topic tells you how to configure your Tanzu Insight CLI plug-in.

Set the target and certificate authority (CA) certificate

These instructions are for the recommended configuration where Ingress is enabled. For instructions on non Ingress setups, see [Configure target endpoint and certificate](#).

Set the endpoint host to:

```
metadata-store.INGRESS-DOMAIN
```

Where `INGRESS-DOMAIN` is the value of the `ingress_domain` property in your deployment YAML

Example:

```
metadata-store.example.domain.com
```



Note

In a multicluster setup, a DNS record is required for the domain. The following instructions for single cluster setup do not apply, skip to the [Set the target](#) section.

Single-cluster setup

In a single-cluster setup, a DNS record is still recommended. However, if no accessible DNS record exists for the domain, edit the `/etc/hosts` file to add a local record:

```
ENVOY_IP=$(kubectl get svc envoy -n tanzu-system-ingress -o jsonpath="{.status.loadBalancer.ingress[0].ip}")

# Replace with your domain
METADATA_STORE_DOMAIN="metadata-store.example.domain.com"

# Delete any previously added entry
sudo sed -i ' ' "/$METADATA_STORE_DOMAIN/d" /etc/hosts

echo "$ENVOY_IP $METADATA_STORE_DOMAIN" | sudo tee -a /etc/hosts > /dev/null
```

Set the target

To get the certificate, run:

```
kubectl get secret tap-ingress-selfsigned-root-ca -n cert-manager -o json | jq -r '.data."ca.crt"' | base64 -d > insight-ca.crt
```

Set the target by running:

```
tanzu insight config set-target https://$METADATA_STORE_DOMAIN --ca-cert insight-ca.crt
```



Important

The `tanzu insight config set-target` does not initiate a test connection. Use `tanzu insight health` to test connecting using the configured endpoint and CA certificate. Neither commands test whether the access token is correct. For that you must use the plug-in to [add data](#) and [query data](#).

Set the access token

When using the `insight` plug-in, you must set the `METADATA_STORE_ACCESS_TOKEN` environment variable, or use the `--access-token` flag. VMware discourages using the `--access-token` flag as the token appears in your shell history.

The following command retrieves the access token from the default `metadata-store-read-write-client` service account and stores it in `METADATA_STORE_ACCESS_TOKEN`:

```
export METADATA_STORE_ACCESS_TOKEN=$(kubectl get secrets metadata-store-read-write-client -n metadata-store -o jsonpath="{.data.token}" | base64 -d)
```

Verify the connection

Verify that your configuration is correct and you can make a connection using `tanzu insight health`.



Important

The `tanzu insight health` command tests the configured endpoint and CA certificate. However, it does not test whether the access token is correct. For that, you must use the plug-in to [add](#) and [query data](#).

For example:

```
$ tanzu insight health
Success: Reached Metadata Store!
```

Query vulnerabilities, images, and packages

This topic tells you how to query the database to understand vulnerability, image, and dependency relationships. The Tanzu Insight CLI plug-in queries the database for vulnerability scan reports or Software Bill of Materials (commonly known as SBOM) files.

Supported use cases

The following are use cases supported by the CLI:

- What packages and CVEs exist in a particular image? ([image](#))
- What packages and CVEs exist in my source code? ([source](#))
- What dependencies are affected by a specific CVE? ([vulnerabilities](#))

Query using the Tanzu Insight CLI plug-in

Install the [Tanzu Insight CLI plug-in](#) if you have not already done so.

There are four commands for querying and adding data.

- [image](#) - Post an [image SBOM](#) or query images for packages and vulnerabilities.
- [package](#) - Query packages for vulnerabilities or by image or source code.
- [source](#) - Post a [source code SBOM](#) or query source code for packages and vulnerabilities.
- [vulnerabilities](#) - Query vulnerabilities by image, package, or source code.

Example #1: What packages and CVEs does a specific image contain?

To query an image scan for vulnerabilities, you need the image's digest, which you can get from the image scan resource.

Find an image's digest

Find an image's digest using Supply Chain Tools - Scan 2.0 or Supply Chain Tools - Scan Pre-2.0.

Find an image's digest using Supply Chain Tools - Scan 2.0

When using Supply Chain Tools - Scan 2.0, find the image digest by looking inside the corresponding image vulnerability scan custom resource.

To get a list of image vulnerability scans, run:

```
kubectl get imagevulnerabilityscan -n WORKLOAD-NAMESPACE
```

For example:

```
$ kubectl get imagevulnerabilityscan -n my-apps
NAME                                SUCCEEDED REASON
tanzu-java-web-app-grype-scan-jb76m True       Succeeded
```

The name of the image vulnerability scan starts with the name of the workload.

To describe the image vulnerability scan, run:

```
kubectl describe imagevulnerabilityscan IMAGE-VULNERABILITY-SCAN-NAME -n WORKLOAD-NAME
SPACE
```

For example:

```
kubectl describe imagevulnerabilityscan tanzu-java-web-app-grype-scan-jb76m -n my-apps
```

In the resource, look for the `Spec.Image` field. The value points to the image that was scanned, including its digest.

For example:

```
Spec:
  Image: fake.oci-registry.io/dev-cluster/supply-chain-apps/tanzu-java-web-app-my-apps
@sha256:a24a8d8eb724b6816f244925cc6625a84c15f6ced6a19335121343424be693cd
```

In this example, the image's digest is:

```
sha256:a24a8d8eb724b6816f244925cc6625a84c15f6ced6a19335121343424be693cd
```

Find an image's digest using Supply Chain Tools - Scan Pre-2.0

When using Supply Chain Tools - Scan Pre-2.0, find the image digest by looking inside the corresponding image scan custom resource.

Run:

```
kubectl get imagescan WORKLOAD-NAME -n WORKLOAD-NAMESPACE
```

For example:

```
kubectl get imagescan tanzu-java-web-app -n my-apps
```

In the resource, look for the `Spec.Registry.Image` field. The value points to the image that was scanned, including its digest.

For example:

```
Spec:
  Registry:
    Image: fake.oci-registry.io/dev-cluster/supply-chain-apps/tanzu-java-web-app-my-ap
ps@sha256:e8c648533c4c7440ee9a93142ac7480205e0f7669e4f86771cede8bfaacdc2cf
```

In this example, the image's digest is:

```
sha256:e8c648533c4c7440ee9a93142ac7480205e0f7669e4f86771cede8bfaacdc2cf
```

Query an image with image digest

Run:

```
tanzu insight image get --digest DIGEST
```

Where:

- `DIGEST` is the component version or image digest.

For example:

```
$ tanzu insight image get --digest sha256:407d7099d6ce7e3632b6d00682a43028d75d3b088600
797a833607bd629d1ed5
Registry:      docker.io
Image Name:    checkr/flagr:1.1.12
Digest:        sha256:407d7099d6ce7e3632b6d00682a43028d75d3b088600797a833607bd629d1ed
5
Packages:
  1. alpine-baselayout@3.1.2-r0
  2. alpine-keys@2.1-r2
  3. apk-tools@2.10.4-r2
CVEs:
  1. CVE-2021-30139 (High)
```

```

2. CVE-2021-36159 (Critical)
4. busybox@1.30.1-r3
CVEs:
1. CVE-2021-28831 (High)
...

```

Example #2: What packages and CVEs does my source code contain?

Determining source code org, repo, and commit SHA

To query a source scan for vulnerabilities, you need a Git org and Git repository, or the commit SHA. Find these by examining the source scan resource.

Run:

```
kubectl describe sourcescan WORKLOAD-NAME -n WORKLOAD-NAMESPACE
```

For example:

```
kubectl describe sourcescan tanzu-java-web-app -n my-apps
```

In the resource look for the `Spec.Blob` field. Within, there's `Revision` and `URL`.

For example:

```

Spec:
  Blob:
    Revision:      master/c7e4c27ba43250a4b7c46f030355c108aa73cc39
    URL:           http://source-controller.flux-system.svc.cluster.local./gitrepository/my-apps/tanzu-java-web-app-gitops/c7e4c27ba43250a4b7c46f030355c108aa73cc39.tar.gz

```

In the earlier example, the URL is parsed and split into the org and repo. Revision is parsed as the commit SHA.

- Org is parsed as `gitrepository`
- Repo is parsed as `my-apps/tanzu-java-web-app-gitops/c7e4c27ba43250a4b7c46f030355c108aa73cc39.tar.gz`
- Commit SHA is parsed as `master/c7e4c27ba43250a4b7c46f030355c108aa73cc39`

Use this information to perform your search.

Source code query with repo and org

Run:

```
tanzu insight source get --repo REPO --org ORG
```

Where:

- `REPO` specifies the repository. For example, `java-web-app, my-apps/java-web-app/c7ls8bakd87sakjda8d7.tar.gz`
- `ORG` is the source code's organization. For example, `gitrepository, gitrepository-kj32ka18`

For example:

```

$ tanzu insight source get --repo my-apps/java-web-app/c7ls8bakd87sakjda8d7.tar.gz --org gitrepository
ID:          1

```

```
Repository: my-apps/java-web-app/c71s8bakd87sakjda8d7.tar.gz
Commit: c7e4c27ba43250a4b7c46f030355c108aa73cc39
Organization: gitrepository
Packages:
    1. go.uber.org/atomic@v1.7.0
    CVEs:
        1. CVE-2022-42322 (Low)
    2. golang.org/x/crypto@v0.0.0-20220518034528-6f7dac969898
    3. github.com/valyala/bytebufferpool@v1.0.0
```

Source code query with commit SHA

Run:

```
tanzu insight source get --commit COMMIT
```

Where:

- `COMMIT` specifies the commit. For example, `d7e4c27ba43250a4b7c46f030355c108aa73cc39`, `main/d7e4c27ba43250a4b7c46f030355c108aa73cc39`

For example:

```
$ tanzu insight source get --commit b66668e
ID: 2
Repository: kpack
Commit: b66668e
Organization: pivotal
Packages:
    1. cloud.google.com/go/kms@v1.0.0
    2. github.com/BurntSushi/toml@v3.1.1
    CVEs:
        1. CVE-2021-30999 (Low)
    3. github.com/Microsoft/go-winio@v0.5.2
```

Example #3: What dependencies are affected by a specific CVE?

Run:

```
tanzu insight vulnerabilities get --cveid CVE-IDENTIFIER
```

Where:

- `CVE-IDENTIFIER` is the CVE identifier, for example, `CVE-2021-30139`.

For example:

```
$ tanzu insight vulnerabilities get --cveid CVE-2010-4051
1. CVE-2010-4051 (Low)
Packages:
    1. libc-bin@2.28-10
    2. libc-110n@2.28-10
    3. libc6@2.28-10
    4. locales@2.28-10
```

Add data

For more information about manually adding data, see [\[Add Data\]\(Add data to your Supply Chain Security Tools - Store.hbs.md\)](#).

Add data to your Supply Chain Security Tools - Store

This topic tells you how to add vulnerability scan reports or Software Bill of Materials (SBOM) files to your Supply Chain Security Tools (SCST) - Store.

Supported formats and file types

Currently, only CycloneDX XML and JSON files are accepted.

Source commits and image files have been tested. Additional file types might work, but are not fully supported (for example, JAR files).

If you are not using a source commit or image file, you must ensure the `component.version` field in the CycloneDX file is non-null.

Generate a CycloneDX file

A CycloneDX file is needed to post data. Supply Chain Security Tools - Scan outputs CycloneDX files automatically. For more information, see [Supply Chain Security Tools - Scan](#).

To generate a file to post manually, use Grype or another tool in the [CycloneDX Tool Center](#).

To use Grype to scan an image and generate an image report in CycloneDX format:

1. Install [Grype](#).
2. Scan the image and generate a report by running:

```
grype REPO:TAG -o cyclonedx > IMAGE-CVE-REPORT
```

Where:

- `REPO` is the name of your repository
- `TAG` is the name of a tag
- `IMAGE-CVE-REPORT` is the resulting file name of the Grype image scan report

For example:

```
$ grype docker.io/checkr/flagr:1.1.12 -o cyclonedx > image-cve-report
✓ Vulnerability DB           [updated]
✓ Parsed image
✓ Cataloged packages        [21 packages]
✓ Scanned image             [8 vulnerabilities]
```

Add data with the Tanzu Insight plug-in

Use the following commands to add data:

- `image add`
- `source add`

If you are not using a source commit or image file, you can select either option.

Example #1: Add an image report

To use a CycloneDX-formatted image report, run:

```
tanzu insight image add --cyclonedxtype TYPE --path IMAGE-CVE-REPORT
```

Where:

- `TYPE` specifies XML or JSON, the two supported file types
- `IMAGE-CVE-REPORT` is the location of a Cyclone DX formatted file

For example:

```
$ tanzu insight image add --cyclonedxtype xml --path downloads/image-cve-report
Image report created.
```



Note

The Metadata Store only stores a subset of CycloneDX file data. Support for more data might be added in the future.

Example #2: Add a source report

To use a CycloneDX-formatted source report, run:

```
tanzu insight source add --cyclonedxtype TYPE --path SOURCE-CVE-REPORT
```

Where:

- `TYPE` specifies XML or JSON, the two supported file types
- `SOURCE-CVE-REPORT` is the location of a Cyclone DX formatted file

For example:

```
$ tanzu insight source add --cyclonedxtype json --path source-cve-report
Source report created.
```



Note

Supply Chain Security Tools - Store only stores a subset of a CycloneDX file's data. Support for more data might be added in the future.

Triage vulnerabilities (alpha)

This topic tells you how to add analyze vulnerabilities associated with a workload in the Supply Chain Security Tools (SCST) - Store. This is an experimental feature, and the API is prone to changes in subsequent releases.



Important

The capability to triage scan results in SCST - Store is in the alpha stage, which means that it is still in early development and is subject to change at any point. You might encounter unexpected behavior from it.

Triage

Vulnerability analysis, or triage is the process of evaluating a reported vulnerability to decide an effective remediation plan. Triage helps application teams to generate useful insights about the vulnerabilities in their software so that they can make the right decisions about when and how to mitigate them. The current implementation of triage follows [CycloneDX's Vulnerability Exploitability eXchange \(VEX\)](#) specification, and is designed specifically to work with Tanzu workloads.

For information about this feature, see [Data models and concepts for SCST - Store](#).

Prerequisites

Before you begin vulnerability analysis, you must:

- Install the [Tanzu Insight CLI plug-in](#).
- Add vulnerability scan reports to the SCST - Store. You can do this either by using the `tanzu insight image add` command or by installing the SCST - Scan. For more information, see [Add data and Supply Chain Security Tools - Scan](#).

Create vulnerability analyses

A vulnerability analysis contains the following data:

1. `state`: Declares the current state of an occurrence of a vulnerability, after automated or manual analysis.
2. `justification`: The rationale of why the impact analysis state was asserted.
3. `response`: A response to the vulnerability by the manufacturer, supplier, or project responsible for the affected component or service.
4. `comment`: Free form comments to provide additional details.

For more information about the supported values for each of these fields, see [tanzu insight triage update](#).

For example, if you are interested in a vulnerability affecting a specific image in your workload, and are investigating its impact, you can add this information to the SCST - Store:

```
tanzu insight triage update \
  --cveid $CVEID \
  --pkg-name $PKG-NAME \
  --pkg-version $PKG-VERSION \
  --img-digest $IMG-DIGEST \
  --artifact-group-uid $AG-UID \
  --state in_triage
```

Where:

- `CVEID` is the unique identifier of the vulnerability
- `PKG-NAME` and `PKG-VERSION` are the name and version of the Application and OS package affected by the vulnerability
- `IMG-DIGEST` is the digest of the image that contains the affected Application and OS package
- `AG-UID` is the unique identifier for the workload that contains the image. If your workload was deployed with Tanzu CLI, you can find its unique identifier with the command:

```
kubectl get workload $MY_WORKLOAD_NAME --namespace $MY_WORKLOAD_NAMESPACE --out
put jsonpath='{.metadata.uid}'
```

**Note**

If your affected package is linked to a source instead of an image, you can use `--src-commit` instead of `--img-digest`

As you continue to investigate the vulnerability, you can update your analysis with the latest findings by using the `tanzu insight triage update` command as many times as needed.

View existing analysis

To view all the existing analysis in SCST - Store:

```
tanzu insight triage list
```

The results are paginated by default. You can switch the current page or the number of results returned by providing the `--page` or `--limit` flags respectively. You can also filter the results by image or source. For more information, use the `--help` flag or see [tanzu insight triage list](#).

Copy an analysis

Sometimes, you might run into scenarios where an existing analysis might be shared between multiple images, for example, when a new version of an existing image is deployed by your workload and it contains the same vulnerability as the previous version, or when you create an analysis for an image that is shared between multiple workloads.

To speed up triage in those cases, you can use the `copy` subcommand:

```
tanzu insight triage copy \
  --trriage-uid-to-copy $TRIRAGE-UID \
  --img-digest $TARGET-IMAGE
```

Where:

- `TRIRAGE-UID` is the uid of an existing analysis
- `TARGET-IMAGE` is the digest of an image you want to copy the analysis to

The following conditions are required for this action:

1. If specified, the targeted image or source must contain the package affected by the vulnerability in the existing analysis.
2. If only an image or source are specified, they must belong to the same workload as the one in the existing analysis.
3. If only an `artifact-group-uid` is specified, it must contain the image or source associated in the existing analysis.

**Note**

The responsibility of assessing a vulnerability's impact is up to the person in charge of triage. Images and sources with the same package and version might use the package in a different way and might not have the same analysis values.

Tanzu insight CLI plug-in command reference

This topic tells you about the Tanzu Insight CLI plug-in.

Synopsis

This CLI plug-in is used to post data and query the Supply Chain Security Tools - Store through its secure REST API. Source commit and image vulnerability reports can be uploaded using CycloneDX format, XML and JSON and SPDX format JSON. Source commit, image, package, and vulnerabilities can be queried and outputted in CycloneDX XML, JSON, and human-readable text formats.

Options

```
-h, --help  help for insight
```

See also

- [tanzu insight config](#) - Config commands
- [tanzu insight health](#) - Checks if endpoint is reachable
- [tanzu insight image](#) - Image commands
- [tanzu insight package](#) - Package commands
- [tanzu insight source](#) - Source commands
- [tanzu insight triage](#) - Vulnerability analysis commands
- [tanzu insight vulnerabilities](#) - Vulnerabilities commands

tanzu insight config

This topic tells you how to use the Tanzu Insight CLI `tanzu insight config` command to get help for the configuration commands.

Options

```
-h, --help  help for config
```

See also

- [tanzu insight](#) - post & query image, package, source, and vulnerability data
- [tanzu insight config set-target](#) - Set metadata store endpoint

tanzu insight config set-target

This topic tells you how to use the Tanzu Insight CLI `tanzu insight config set-target` command to set your metadata store endpoint.

Synopsis

To set the target endpoint for the metadata store, run@

```
tanzu insight config set-target <endpoint> [--ca-cert <ca certificate path to verify peer against>] [--access-token <kubernetes service account access token>] [flags]
```

Examples

```
insight config set-target https://localhost:8443 --ca-cert=/tmp/ca.crt --access-token
eyJhbGc...
```

Options

```
--access-token string    Kubernetes access token. It is recommended to use the En
environment Variable METADATA_STORE_ACCESS_TOKEN during the API calls, this will overrid
e access token flag. Note: using the the access-token flag stores the token on disk, t
he Environment Variable is retrieved at the time of the API call
--ca-cert string         trusted ca certificate
-h, --help              help for set-target
```

See also

- [tanzu insight config](#) - Config commands

tanzu insight health

This topic tells you how to use the Tanzu Insight CLI `tanzu insight health` command to check if an endpoint is reachable.

Synopsis

Checks if endpoint is reachable

```
tanzu insight health [flags]
```

Examples

```
insight health
```

Options

```
-h, --help    help for health
```

See also

- [tanzu insight](#) - post & query image, package, source, and vulnerability data

tanzu insight image

This topic tells you how to use the Tanzu Insight CLI `tanzu insight image` command to get help for the image commands.

Options

```
-h, --help    help for image
```

See also

- [tanzu insight](#) - post & query image, package, source, and vulnerability data
- [tanzu insight image add](#) - Add an image report
- [tanzu insight image get](#) - Get image by digest
- [tanzu insight image packages](#) - Get image packages
- [tanzu insight image vulnerabilities](#) - Get image vulnerabilities

tanzu insight image add

This topic tells you how to use the Tanzu Insight CLI `tanzu insight image add` command to add an image report.

Synopsis

Add an image to the metadata store with the image's SBOM or vulnerability scan. By default command will show Standard output and errors together. Output and errors can be redirected to files by using `1>out.txt 2>error.txt`

```
tanzu insight image add --path <filepath> [flags]
```

Examples

```
insight image add --input-format cyclonedx-xml --output-format text --path /path/to/file.xml
  insight image add --input-format spdx-json --output-format api-json --path /path/to/file.json
  insight image add --path /path/to/file.xml
  insight image add --path /path/to/file.xml --artifact-group-uid workload-uid --artifact-group-label name=example --artifact-group-label namespace=example-ns
  insight image add --path /path/to/file.xml --artifact-group-uid workload-uid --artifact-group-label name=example,namespace=example-ns
  insight image add --input-format spdx-json --output-format api-json --path /path/to/file.json 1>out.txt 2>error.txt (* Output will be redirected to out.txt and error will be redirected to error.txt .)
```

Options

```
--artifact-group-label strings  specify artifact group labels, must be in key=value format. This flag can be set multiple times to provide multiple labels in one call, or can be passed a list of labels separated by commas. Note: This flag can only be specified if artifact-group-uid flag is set.
--artifact-group-uid string      uid of artifact group to add to, or create if it doesn't already exist
-h, --help                      help for add
-i, --input-format string        specify the file's SBOM report format and file type, options=[cyclonedx-xml, cyclonedx-json, spdx-json] (default: cyclonedx-xml)
--output-format string          specify the response's SBOM report format and file type format, options=[text, api-json] (default: text)
-p, --path string              path to file, required
```

See also

- [tanzu insight image](#) - Image commands

tanzu insight image get

This topic tells you how to use the Tanzu Insight CLI `tanzu insight image get` command to get an image by digest.

Synopsis

Get image by digest

```
tanzu insight image get --digest <image-digest> [flags]
```

Examples

```
insight image get --digest sha256:a86859ac1946065d93df9ecb5cb7060adeeb0288fad610b1b659907
insight image get --digest sha256:a86859ac1946065d93df9ecb5cb7060adeeb0288fad610b1b659907 --output-format api-json
insight image get --digest sha256:a86859ac1946065d93df9ecb5cb7060adeeb0288fad610b1b659907 --output-format cyclonedx-xml
```

Options

```
-d, --digest string      image digest
-h, --help              help for get
--output-format string  specify the response's SBOM report format and file type
format, options=[text, api-json, cyclonedx-xml, spdx-json] (default: text)
```

See also

- [tanzu insight image](#) - Image commands

tanzu insight image packages

This topic tells you how to use the Tanzu Insight CLI `tanzu insight image packages` command to get the image packages.

Synopsis

Get image packages

```
tanzu insight image packages [--digest <image-digest>] [--name <name>] [flags]
```

Examples

```
insight image packages --digest sha256:a86859ac1946065d93df9ecb5cb7060adeeb0288fad610b1b659907
insight image packages --name ubuntu --output-format api-json
```

Options

```
-d, --digest string      image digest
-h, --help              help for packages
```

```
-n, --name string          image name
--output-format string    specify the response's SBOM report format and file type
format, options=[text, api-json] (default: text)
```

See also

- [tanzu insight image](#) - Image commands

tanzu insight image vulnerabilities

This topic tells you how to use the Tanzu Insight CLI `tanzu insight image vulnerabilities` command to get the image vulnerabilities.

Synopsis

Get image vulnerabilities

```
tanzu insight image vulnerabilities --digest <image-digest> [flags]
```

Examples

```
insight image vulnerabilities --digest sha256:a86859ac1946065d93df9ecb5cb7060adeeb0288
fad610b1b659907
insight image vulnerabilities --digest sha256:a86859ac1946065d93df9ecb5cb7060adeeb0288
fad610b1b659907 --output-format api-json
```

Options

```
-d, --digest string      image digest
-h, --help              help for vulnerabilities
--output-format string  specify the response's SBOM report format and file type
format, options=[text, api-json] (default: text)
```

See also

- [tanzu insight image](#) - Image commands

tanzu insight package

This topic tells you how to use the Tanzu Insight CLI `tanzu insight package` command to get help for the package commands.

Options

```
-h, --help  help for package
```

See also

- [tanzu insight](#) - post & query image, package, source, and vulnerability data
- [tanzu insight package get](#) - Get package by name, version, and package manager
- [tanzu insight package images](#) - Get images that contain the given package by name

- [tanzu insight package sources](#) - Get sources that contain the given package by name
- [tanzu insight package vulnerabilities](#) - Get package vulnerabilities

tanzu insight package get

This topic tells you how to use the Tanzu Insight CLI `tanzu insight package get` command to get the package by name, version, and package manager.

Synopsis

To get package by name, version, and package manager, run:

```
tanzu insight package get --name <package name> --version <package version> --pkgmgr
Unknown [flags]
```

Examples

```
insight package get --name client --version 1.0.0a --pkgmgr Unknown
insight package get --name client --version 1.0.0a --pkgmgr Unknown --output-format
api-json
```

Options

```
-h, --help                help for get
-n, --name string         name of the package
    --output-format string specify the response's SBOM report format and file type
format, options=[text, api-json] (default: text)
-p, --pkgmgr string       Package manager of the dependency. 'Unknown' is current
ly the only supported value (default "Unknown")
-v, --version string      version of the package
```

See also

- [tanzu insight package](#) - Package commands

tanzu insight package images

This topic tells you how to use the Tanzu Insight CLI `tanzu insight package images` command to get the images that contain the given package by name.

Synopsis

To get images that contain the given package by name.

```
tanzu insight package images --name <package name> [flags]
```

Examples

```
insight package images --name client
insight package images --name client --output-format api-json
```

Options

```
-h, --help          help for images
-n, --name string   name of the package
--output-format string specify the response's SBOM report format and file type
format, options=[text, api-json] (default: text)
```

See also

- [tanzu insight package](#) - Package commands

tanzu insight package sources

This topic tells you how to use the Tanzu Insight CLI `tanzu insight package sources` command to get the sources that contain the given package by name.

Synopsis

To get sources that contain the given package by name, run:

```
tanzu insight package sources --name <package name> [flags]
```

Examples

```
insight package sources --name client
insight package sources --name client --output-format api-json
```

Options

```
-h, --help          help for sources
-n, --name string   name of the package
--output-format string specify the response's SBOM report format and file type
format, options=[text, api-json] (default: text)
```

See also

- [tanzu insight package](#) - Package commands

tanzu insight package vulnerabilities

This topic tells you how to use the Tanzu Insight CLI `tanzu insight package vulnerabilities` command to get the package vulnerabilities.

Synopsis

Get package vulnerabilities

```
tanzu insight package vulnerabilities --name <package name> [flags]
```

Examples

```
insight package vulnerabilities --name client
insight package vulnerabilities --name client --output-format api-json
```

Options

```
-h, --help          help for vulnerabilities
-n, --name string   name of the package
--output-format string specify the response's SBOM report format and file type
format, options=[text, api-json] (default: text)
```

See also

- [tanzu insight package](#) - Package commands

tanzu insight source

This topic tells you how to use the Tanzu Insight CLI `tanzu insight source` command to get help for the source commands.

Options

```
-h, --help  help for source
```

See also

- [tanzu insight](#) - post & query image, package, source, and vulnerability data
- [tanzu insight source add](#) - Add a source report
- [tanzu insight source get](#) - Get sources by repository, commit or organization
- [tanzu insight source packages](#) - Get source packages
- [tanzu insight source vulnerabilities](#) - Get source vulnerabilities

tanzu insight source add

This topic tells you how to use the Tanzu Insight CLI `tanzu insight source add` command to add a source report.

Synopsis

Add a source to the metadata store with the source's SBOM or vulnerability scan. By default command will show Standard output and errors together. Output and errors can be redirected to files by using `1>out.txt 2>error.txt`

```
tanzu insight source add --path <filepath> [flags]
```

Examples

```
insight source add --input-format cyclonedx-xml --output-format text --path /path/to/file.xml
insight source add --input-format spdx-json --output-format api-json --path /path/to/file.json
insight source add --path /path/to/file.xml
insight source add --path /path/to/file.xml --artifact-group-uid workload-uid --artifact-group-label name=example --artifact-group-label namespace=example-ns
insight source add --path /path/to/file.xml --artifact-group-uid workload-uid --artifact-group-label name=example,namespace=example-ns
```

```
insight source add --input-format spdx-json --output-format api-json --path /path/to/file.json 1>out.txt 2>error.txt (* Output will be redirected to out.txt and error will be redirected to error.txt .)
```

Options

```
--artifact-group-label strings    specify artifact group labels, must be in key=value format. This flag can be set multiple times to provide multiple labels in one call, or can be passed a list of labels separated by commas. Note: this flag can only be specified if artifact-group-uid flag is set
--artifact-group-uid string       uid of artifact group to add to, or create if it doesn't already exist
-h, --help                        help for add
-i, --input-format string         specify the file's SBOM report format and file type, options=[cyclonedx-xml, cyclonedx-json, spdx-json] (default: cyclonedx-xml)
--output-format string           specify the response's SBOM report format and file type format, options=[text, api-json] (default: text)
-p, --path string                path to file, required
```

See also

- [tanzu insight source](#) - Source commands

tanzu insight source get

This topic tells you how to use the Tanzu Insight CLI `tanzu insight source get` command to get sources by repository, commit or organization.

Synopsis

Get sources by repository, commit or organization

```
tanzu insight source get --repo <repository-name> --commit <commit-hash> --org <organization-name> [flags]
```

Examples

```
insight source get --org company --repo example-repo --commit b33dfce51
insight source get --org company --repo example-repo --commit b33dfce51 --output-format api-json
insight source get --org company --repo example-repo --commit b33dfce51 --output-format cyclonedx-xml
```

Options

```
-c, --commit string              commit hash
-h, --help                       help for get
-o, --org string                 organization that owns the source
--output-format string           specify the response's SBOM report format and file type format, options=[text, api-json, cyclonedx-xml, spdx-json] (default: text)
-r, --repo string                repository name
```

See also

- [tanzu insight source](#) - Source commands

tanzu insight source packages

This topic tells you how to use the Tanzu Insight CLI `tanzu insight source packages` command to get the source packages.

Synopsis

Get source packages

```
tanzu insight source packages [--commit <commit-hash>] [--repo <repository-name>] [flags]
```

Examples

```
insight sources packages --commit 0b1b659907 --repo example-repo
insight sources packages --commit 0b1b659907 --repo example-repo --output-format api
-json
```

Options

```
-c, --commit string      commit hash
-h, --help              help for packages
    --output-format string specify the response's SBOM report format and file type
format, options=[text, api-json] (default: text)
-r, --repo string       repository name
```

See also

- [tanzu insight source](#) - Source commands

tanzu insight source vulnerabilities

This topic tells you how to use the Tanzu Insight CLI `tanzu insight source vulnerabilities` command to get the source vulnerabilities.

Synopsis

Get source vulnerabilities. You can specify either commit or repo.

```
tanzu insight source vulnerabilities [--commit <commit-hash>] [--repo <repository-name>] [flags]
```

Examples

```
insight sources vulnerabilities --commit eb55fc13 --repo example-repo
insight sources vulnerabilities --commit eb55fc13 --repo example-repo --output-format api-json
```

Options

```
-c, --commit string      commit hash
-h, --help              help for vulnerabilities
```

```
--output-format string  specify the response's SBOM report format and file type
format, options=[text, api-json] (default: text)
-r, --repo string      repository name
```

See also

- [tanzu insight source](#) - Source commands

tanzu insight triage

This topic tells you how to use the Tanzu Insight CLI `tanzu insight triage` command to get help for the vulnerability analysis commands.

Options

```
-h, --help            help for triage
--output-format string specify the response's format, options=[text, api-json]
(default "text")
```

See also

- [tanzu insight](#) - post & query image, package, source, and vulnerability data
- [tanzu insight triage copy](#) - Copy an existing analysis to a new image, source or artifact group
- [tanzu insight triage list](#) - Return the list of existing vulnerability triages
- [tanzu insight triage update](#) - Create or update a vulnerability analysis

tanzu insight triage copy

This topic tells you how to use the Tanzu Insight CLI `tanzu insight triage copy` command to copy an existing analysis to a new image, source or artifact group.

Synopsis

This command takes an existing triage and copies the latest analysis to target a new image, source or artifact group affected by the vulnerability of the existing triage. This allows you to easily copy analysis between images and sources that belong to different artifact groups, or different versions of an image/source that belong to the same artifact group.

If an image or source are provided, validations will run to make sure they contain the affected package and vulnerability, and that they belong to the existing triage's artifact group. If an artifact group is provided, validations will run to make sure it contains the provided image/source, or the original ones from the existing triage.

```
tanzu insight triage copy --trriage-uid-to-copy <uid> [--img-digest <digest>] [--src-co
mmit <commit>] [--artifact-group-uid <ag-uid>] [flags]
```

Examples

```
insight triage copy --trriage-uid-to-copy BEC0F39C-FE99-4F18-A0AF-069A4AA8D71A --img-di
gest sha256:192369123812
insight triage copy --trriage-uid-to-copy BEC0F39C-FE99-4F18-A0AF-069A4AA8D71A --src-co
mmit 5025112c8b1 --artifact-group-uid AG-00003
```

```
insight triage copy --trriage-uid-to-copy BEC0F39C-FE99-4F18-A0AF-069A4AA8D71A --artifa
ct-group-uid AG-00002
```

Options

```
-a, --artifact-group-uid string  Artifact group uid
-h, --help                       help for copy
-d, --img-digest string          Image digest
  --img-registry string          Image registry
-c, --src-commit string          Source commit
  --src-org string               Source organization
  --src-repo string              Source repository
-u, --trriage-uid-to-copy string  Triage UID to copy from
-y, --yes                         Force update
```

Options inherited from parent commands

```
--output-format string  specify the response's format, options=[text, api-json]
(default "text")
```

See also

- [tanzu insight triage](#) - Vulnerability analysis commands

tanzu insight triage list

This topic tells you how to use the Tanzu Insight CLI `tanzu insight triage list` command to get a list of the existing vulnerability triages.

```
tanzu insight triage list [flags]
```

Examples

```
insight triage list --img-digest sha256:123456789
insight triage list --src-commit als2d3f4 --limit 5
insight triage list --output-format api-json
insight triage list --page 5 --limit 20
```

Options

```
-h, --help                       help for list
-d, --img-digest string          Image digest
-l, --limit uint                 Limits the number of analysis to show (default 10)
-p, --page uint                 Allows to paginate the results based on the specified limi
t (default 1)
-c, --src-commit string          Source commit
```

Options inherited from parent commands

```
--output-format string  specify the response's format, options=[text, api-json]
(default "text")
```

See also

- [tanzu insight triage](#) - Vulnerability analysis commands

tanzu insight triage update

This topic tells you how to use the Tanzu Insight CLI `tanzu insight triage update` command to create or update a vulnerability analysis.

Synopsis

Create or update a vulnerability impact analysis. For impact analysis, you must target a specific OS and application package, vulnerability, and image or source belonging to a specific Artifact Group. This tool follows CycloneDX's VEX specification for impact analysis, that includes flag options for each of the CycloneDX's VEX fields, and support for only their predefined values. Here is a description of the fields and their supported options:

Impact Analysis States `--state`

Declares the current state of an occurrence of a vulnerability, after automated or manual analysis.

- `resolved` = the vulnerability is remediated.
- `resolved_with_pedigree` = the vulnerability is remediated and evidence of the changes are provided in the affected components pedigree containing verifiable commit history or diffs.
- `exploitable` = the vulnerability might be directly or indirectly exploitable.
- `in_triage` = the vulnerability is being investigated.
- `false_positive` = the vulnerability is not specific to the component or service and was falsely identified or associated.
- `not_affected` = the component or service is not affected by the vulnerability.

Impact Analysis Justifications `--justification`

The rationale of why the impact analysis state was asserted is described here:

- `code_not_present` = the code is removed or tree-shaked.
- `code_not_reachable` = the vulnerable code is not invoked at runtime.
- `requires_configuration` = exploitability requires a configurable option to be set or unset.
- `requires_dependency` = exploitability requires a dependency that is not present.
- `requires_environment` = exploitability requires a certain environment that is not present.
- `protected_by_compiler` = exploitability requires a compiler flag to be set or unset.
- `protected_at_runtime` = exploits are prevented at runtime.
- `protected_at_perimeter` = attacks are blocked at physical, logical, or network perimeter.
- `protected_by_mitigating_control` = preventative measures have been implemented that reduce the likelihood or impact of the vulnerability.



Note

`--justification` is required when `--state` is set to `not_affected`

Impact Analysis Responses --response

A response to the vulnerability by the manufacturer, supplier, or project responsible for the affected component or service. More than one response is allowed. Responses are strongly encouraged for vulnerabilities where the analysis state is exploitable

- can_not_fix
- will_not_fix
- update
- rollback
- workaround_available



Note

`--response` is highly encouraged when `--state` is set to `exploitable`; however, CycloneDX specification does not require this.

Free form comments --comment

Syntax:

```
tanzu insight triage update --cveid CVE-ID --pkg-name PKG-NAME --pkg-version PKG-VERSION --img-digest DIGEST --artifact-group-uid UID [--state STATE] [--justification JUSTIFICATION] [--response RESPONSE1, RESPONSE2] [--comment COMMENT] [flags]
```

Examples

The following section shows more examples:

```
insight triage update --cveid CVE-2022-5089 --pkg-name google.golang.org/protobuf --pkg-version 1.23.2 --img-digest sha256:192369123812 --artifact-group-uid AG-00001 --state false_positive
insight triage update --cveid CVE-2022-5089 --pkg-name google.golang.org/protobuf --pkg-version 1.23.2 --img-digest sha256:192369123812 --img-registry internal-hub.docker.io --artifact-group-uid AG-00001 --state not_affected --justification code_not_reachable --comment "The code can't be reached by external users"
insight triage update --cveid CVE-2020-1034 --pkg-name libssl --pkg-version 1.3.0-dev.35 --src-commit 5025112c8b1 --artifact-group-uid AG-00002
insight triage update --cveid CVE-2020-1034 --pkg-name libssl --pkg-version 1.3.0-dev.35 --src-commit 5025112c8b1 --artifact-group-uid AG-00002 --state exploitable --response will_not_fix,update
```

For more information, see the [NIST website](#).

Options

The following section shows options:

```
-a, --artifact-group-uid string  Artifact group uid
-t, --comment string            Analysis comment
-v, --cveid string              CVE id
-h, --help                      help for update
-d, --img-digest string          Image digest
    --img-registry string        Image registry
-j, --justification string       Analysis justification
```

```

-n, --pkg-name string      Package name
-p, --pkg-version string   Package version
-r, --response strings     Analysis response
-c, --src-commit string    Source commit
  --src-org string         Source organization
  --src-repo string        Source repository
-s, --state string         Analysis state (default "in_triage")
-y, --yes                  Force update

```

Options inherited from parent commands

The following section shows options inherited from parent commands:

```

--output-format string    specify the response's format, options=[text, api-json]
                           (default "text")

```

See also

- [tanzu insight triage](#) - Vulnerability analysis commands

tanzu insight vulnerabilities

This topic tells you how to use the Tanzu Insight CLI `tanzu insight vulnerabilities` command to get help for the vulnerabilities commands.

Options

```

-h, --help    help for vulnerabilities

```

See also

- [tanzu insight](#) - post & query image, package, source, and vulnerability data
- [tanzu insight vulnerabilities get](#) - Get vulnerability by CVE id.
- [tanzu insight vulnerabilities images](#) - Get images with a given vulnerability.
- [tanzu insight vulnerabilities packages](#) - Get packages with a given vulnerability.
- [tanzu insight vulnerabilities sources](#) - Get sources with a given vulnerability.

tanzu insight vulnerabilities get

This topic tells you how to use the Tanzu Insight CLI `tanzu insight vulnerabilities get` command to get a vulnerability by CVE ID.

Synopsis

Get vulnerability by CVE id.

```

tanzu insight vulnerabilities get --cveid CVE-ID [flags]

```

Examples

```
insight vulnerabilities get --cveid CVE-123123-2021
insight vulnerabilities get --cveid CVE-123123-2021 --output-format api-json
```

Options

```
-c, --cveid string      CVE id
-h, --help              help for get
    --output-format string specify the response's SBOM report format and file type
format, options=[text, api-json] (default: text)
```

See also

- [tanzu insight vulnerabilities](#) - Vulnerabilities commands

tanzu insight vulnerabilities images

This topic tells you how to use the Tanzu Insight CLI `tanzu insight vulnerabilities images` command to get the images with a given vulnerability.

Synopsis

Get images with a given vulnerability.

```
tanzu insight vulnerabilities images --cveid <cve-id> [flags]
```

Examples

```
insight vulnerabilities images --cveid CVE-123123-2021
insight vulnerabilities images --cveid CVE-123123-2021 --output-format api-json
```

Options

```
-c, --cveid string      CVE id
-h, --help              help for images
    --output-format string specify the response's SBOM report format and file type
format, options=[text, api-json] (default: text)
```

See also

- [tanzu insight vulnerabilities](#) - Vulnerabilities commands

tanzu insight vulnerabilities packages

This topic tells you how to use the Tanzu Insight CLI `tanzu insight vulnerabilities packages` command to get the packages with a given vulnerability.

Synopsis

Get packages with a given vulnerability.

```
tanzu insight vulnerabilities packages --cveid <cve-id> [flags]
```

Examples

```
insight vulnerabilities packages --cveid CVE-123123-2021
insight vulnerabilities packages --cveid CVE-123123-2021 --output-format api-json
```

Options

```
-c, --cveid string      CVE id
-h, --help              help for packages
    --output-format string specify the response's SBOM report format and file type
format, options=[text, api-json] (default: text)
```

See also

- [tanzu insight vulnerabilities](#) - Vulnerabilities commands

tanzu insight vulnerabilities sources

This topic tells you how to use the Tanzu Insight CLI `tanzu insight vulnerabilities sources` command to get the sources with a given vulnerability.

Synopsis

Get sources with a given vulnerability.

```
tanzu insight vulnerabilities sources --cveid <cve-id> [flags]
```

Examples

```
insight vulnerabilities sources --cveid CVE-123123-2021
insight vulnerabilities sources --cveid CVE-123123-2021 --output-format api-json
```

Options

```
-c, --cveid string      CVE id
-h, --help              help for sources
    --output-format string specify the response's SBOM report format and file type
format, options=[text, api-json] (default: text)
```

See also

- [tanzu insight vulnerabilities](#) - Vulnerabilities command

Overview of API Auto Registration

This topic provides an overview of API Auto Registration for Tanzu Application Platform.

Overview

API Auto Registration automates the registration of API specification defined in a workload's configuration. The registered API specification is accessible in Tanzu Developer Portal (formerly

named Tanzu Application Platform GUI) without any additional steps.

An automated workflow using a supply chain, leverages API Auto Registration to create and manage a Kubernetes Custom Resource (CR) of kind `APIDescriptor`. A Kubernetes controller periodically reconciles the CR and updates the API entity in Tanzu Application Platform GUI to achieve automated API specification registration from origin workloads.

You might also use API Auto Registration without supply chain automation, with other GitOps processes, or by directly applying an `APIDescriptor` CR to the cluster.

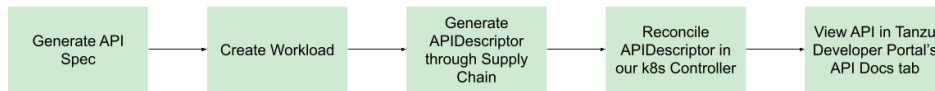

Getting started

For information about API Auto Registration architecture, or the `APIDescriptor` CR and API entities in Tanzu Developer Portal (formerly called Tanzu Application Platform GUI), see [Key Concepts](#).

For information about configuring iterate, run, and full Tanzu Application Platform cluster profiles, see [Configure API Auto Registration](#).

For information about generating API specifications and registering them with Tanzu Developer Portal catalog, see [Use API Auto Registration](#).

For information about other profiles, install the `api-auto-registration` package. See [Install API Auto Registration](#).

For information about troubleshooting and debugging API Auto Registration, see [Troubleshooting](#).

Overview of API Auto Registration

This topic provides an overview of API Auto Registration for Tanzu Application Platform.

Overview

API Auto Registration automates the registration of API specification defined in a workload's configuration. The registered API specification is accessible in Tanzu Developer Portal (formerly named Tanzu Application Platform GUI) without any additional steps.

An automated workflow using a supply chain, leverages API Auto Registration to create and manage a Kubernetes Custom Resource (CR) of kind `APIDescriptor`. A Kubernetes controller periodically reconciles the CR and updates the API entity in Tanzu Application Platform GUI to achieve automated API specification registration from origin workloads.

You might also use API Auto Registration without supply chain automation, with other GitOps processes, or by directly applying an `APIDescriptor` CR to the cluster.

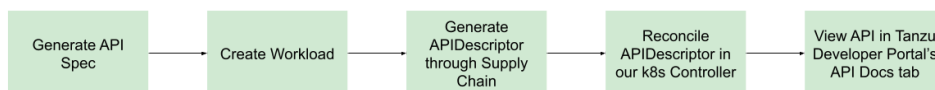

Getting started

For information about API Auto Registration architecture, or the APIDescriptor CR and API entities in Tanzu Developer Portal (formerly called Tanzu Application Platform GUI), see [Key Concepts](#).

For information about configuring iterate, run, and full Tanzu Application Platform cluster profiles, see [Configure API Auto Registration](#).

For information about generating API specifications and registering them with Tanzu Developer Portal catalog, see [Use API Auto Registration](#).

For information about other profiles, install the `api-auto-registration` package. See [Install API Auto Registration](#).

For information about troubleshooting and debugging API Auto Registration, see [Troubleshooting](#).

Key Concepts for API Auto Registration

This topic explains key concepts you use with API Auto Registration.

API Auto Registration Architecture

You can use the full potential of API Auto Registration by using a distributed environment, like the one in this diagram:

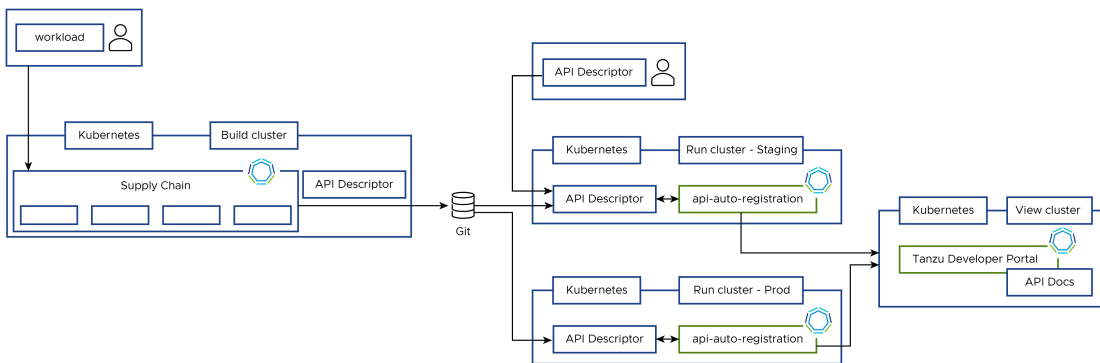

APIDescriptor Custom Resource Explained

To use API Auto Registration, you must create a custom resource of type `APIDescriptor`. The information from this custom resource is used to construct an API entity in Tanzu Developer Portal (formerly named Tanzu Application Platform GUI).

This custom resource exposes the following text boxes:

```
apiVersion: apis.apps.tanzu.vmware.com/v1alpha1
kind: APIDescriptor
metadata:
  name:           # name of your APIDescriptor
  namespace:     # optional namespace of your APIDescriptor
spec:
  type:          # type of the API spec. oneOf(openapi, grpc, asynapi, graphql)
  description:   # description for the API exposed
  system:       # system that the API is part of
  owner:        # person/team that owns the API
  location:
    path:        # sub-path where the API spec is available
    baseURL:     # base URL object where the API spec is available. oneOf(url, ref)
```

```

url:          # static absolute base URL
ref:          # object ref to oneOf(HTTPProxy, Knative Service, Ingress)
  apiVersion:
  kind:
  name:
  namespace:

```

The text boxes cause specific behavior in Tanzu Developer Portal (formerly called Tanzu Application Platform GUI):

- The system and owner are copied to the API entity. You might have to separately create and add the [System](#) and [Group](#) kind to the catalog.
- Tanzu Developer Portal uses the namespace for the API entity where the APIDescriptor CR is applied. This causes the API entity's name, system, and owner to all be in that namespace.
- To explicitly use a system or owner in a different namespace, you can specify that in the `system: my-namespace/my-other-system` Or `owner: my-namespace/my-other-team` text boxes.
- If the system or owner you are trying to link doesn't have a namespace specified, you can qualify them with the `default` namespace. For example, `system: default/my-default-system`

With an Absolute URL

To create an APIDescriptor with a static `baseURL.url`, you must apply the following YAML to your cluster.

```

apiVersion: apis.apps.tanzu.vmware.com/v1alpha1
kind: APIDescriptor
metadata:
  name: sample-absolute-url
spec:
  type: openapi
  description: A set of API endpoints to manage the resources within the petclinic ap
p.
  system: spring-petclinic
  owner: team-petclinic
  location:
    path: "/v3/api-docs.yaml"
    baseURL:
      url: https://myservice.com

```

With an Object Ref

You can use an object reference, instead of hard coding the URL, to point to a HTTPProxy, Knative Service, or Ingress.

With an HTTPProxy Object Ref

This section includes an example YAML that points to an HTTPProxy from which the controller extracts the `.spec.virtualhost.fqdn` as the `baseURL`.

```

apiVersion: apis.apps.tanzu.vmware.com/v1alpha1
kind: APIDescriptor
metadata:
  name: sample-contour-ref
spec:
  type: openapi

```

```

description: A set of API endpoints to manage the resources within the petclinic ap
p.
system: spring-petclinic
owner: team-petclinic
location:
  path: "/test/openapi"
  baseURL:
    ref:
      apiVersion: projectcontour.io/v1
      kind: HTTPProxy
      name: my-httpproxy
      namespace: my-namespace # optional

```

With a Knative Service Object Ref

To use a Knative Service, your controller reads the `status.url` as the baseURL. For example:

```

# all other fields similar to the above example
baseURL:
  ref:
    apiVersion: serving.knative.dev/v1
    kind: Service
    name: my-knative-service
    namespace: my-namespace # optional

```

With an Ingress Object Ref

To use an Ingress instead, your controller reads the URL from the `jsonPath` specified. When the `jsonPath` is left empty, your controller reads the `"{.spec.rules[0].host}"` as the URL. For example:

```

# all other fields similar to the above example
baseURL:
  ref:
    apiVersion: networking.k8s.io/v1
    kind: Ingress
    name: my-ingress
    jsonPath: "{.spec.rules[1].host}"
    namespace: my-namespace # optional

```

APIDescriptor Status Fields

When processing an APIDescriptor several fields are added to the `status`. One of these is `conditions`, which provide information useful for troubleshooting. The conditions are explained in the [Troubleshooting Guide](#).

In addition to `conditions` the `status` contains a couple of other useful fields. The following is a list of these fields with a brief explanation of what they contain.

```

status:
  registeredEntityURL: # Url of the corresponding API Entity in Tanzu Developer Port
al
  registeredTapUID: # Unique identifier for the corresponding API Entity in Tanzu
Developer Portal
  resolvedAPISpec: # Full API Spec as retrieved by Api Auto Registration

```

Install API Auto Registration

This topic describes how you can install API Auto Registration from the Tanzu Application Platform package repository.

**Note**

Follow the steps in this topic if you do not want to use a profile to install API Auto Registration. For more information about profiles, see [Components and installation profiles](#).

Tanzu Application Platform prerequisites

Before installing API Auto Registration, complete all prerequisites to install Tanzu Application Platform. See [Tanzu Application Platform Prerequisites](#).

Using with TLS

Starting in Tanzu Application Platform v1.4, TLS is turned on by default for several components. API Auto Registration automatically trusts the CA for the shared `ingress_issuer` when using the default ClusterIssuer `tap-ingress-selfsigned`. This change means that a `Certificate` is automatically generated using this issuer.

If you do not want a `Certificate` to generate automatically, you can set the `auto_generate_cert` flag to `false` in the values file. To replace the default with a custom ingress issuer, see [Security and compliance](#). Whenever you do not use the default ClusterIssuer `tap-ingress-selfsigned`, do not automatically generate certificates, or use other custom CAs, you must manually set the certificate. See [Troubleshooting](#).

Install

To install the API Auto Registration package:

1. List version information for the package by running:

```
tanzu package available list apis.apps.tanzu.vmware.com --namespace tap-install
```

For example:

```
$ tanzu package available list apis.apps.tanzu.vmware.com --namespace tap-install
- Retrieving package versions for apis.apps.tanzu.vmware.com...
NAME                                     VERSION  RELEASED-AT
apis.apps.tanzu.vmware.com 0.1.0    2022-08-30 19:00:00 -0500 -05
apis.apps.tanzu.vmware.com 0.2.0    2022-11-24 12:20:00 -0500 -05
```

2. (Optional) Gather values schema.

Display values schema of the package:

```
tanzu package available get apis.apps.tanzu.vmware.com/VERSION-NUMBER --values-schema --namespace tap-install
```

Where `VERSION-NUMBER` is the version of the package you retrieved.

For example:

```
tanzu package available get apis.apps.tanzu.vmware.com/0.2.2 --values-schema --namespace tap-install

Retrieving package details for apis.apps.tanzu.vmware.com/0.2.2...
KEY                                     DEFAULT                                     TYPE
DESCRIPTION
```

ca_cert_data		string
Optional: PEM-encoded certificate data for the controller to trust TLS.		
ingress_issuer		string
Optional: Name of the default cluster issuer used to generate certificates		
auto_generate_cert	true	boolean
Flag that indicates if a cert-manager certificate should be generated using the ingress_issuer. Only applies if the ingress_issuer is specified		
connections	with a custom CA	
cluster_name	dev	string
Name of the cluster used for setting the API entity lifecycle in TAP GUI. The value should be unique for each run cluster.		
sync_period	5m	string
Time period used for reconciling an APIDescriptor.		
tap_gui_url	http://server.tap-gui.svc.cluster.local:7000	string
FQDN URL for TAP GUI.		
replicas	1	integer
Number of controller replicas to deploy.		
resources.limits.cpu	500m	string
CPU limit of the controller.		
resources.limits.memory	500Mi	string
Memory limit of the controller.		
resources.requests.cpu	20m	string
CPU request of the controller.		
resources.requests.memory	100Mi	string
Memory request of the controller.		
logging_profile	production	string
Logging profile for controller. If set to development, use console logging with full stack traces, else use JSON logging.		

3. Locate the Tanzu Developer Portal (formerly Tanzu Application Platform GUI) URL.

When running on a full profile Tanzu Application Platform cluster, the default value of Tanzu Developer Portal URL is sufficient. You can edit this to match the externally available FQDN of Tanzu Developer Portal to display the entity URL in the externally accessible APIDescriptor status.

When installed in a run cluster or with a profile where Tanzu Developer Portal is not installed in the same cluster, you must set the `tap_gui_url` parameters correctly for successful entity registration with Tanzu Developer Portal.

You can locate the `tap_gui_url` by going to the view cluster with the Tanzu Developer Portal you want to register the entity with:

```
kubectl get secret tap-values -n tap-install -o jsonpath="{.data['tap-values\.yaml']}" | base64 -d | yq '.tap_gui.app_config.app.baseUrl'
```

4. (Optional) VMware recommends creating `api-auto-registration-values.yaml`.

To overwrite the default values when installing the package, create a `api-auto-registration-values.yaml` file:

```
tap_gui_url: https://tap-gui.view-cluster.com
cluster_name: staging-us-east
ca_cert_data: |
  -----BEGIN CERTIFICATE-----
  MIIFXzCCA0egAwIBAgIJAJYm37SFocj1MA0GCSqGSIb3DQEBAQUAMEY...
  -----END CERTIFICATE-----
sync_period: 2m
```

5. Install the package using the Tanzu CLI:

```
tanzu package install api-auto-registration
--package apis.apps.tanzu.vmware.com
--namespace tap-install
```

```
--version VERSION-NUMBER
--values-file api-auto-registration-values.yaml
```

Where `VERSION-NUMBER` is the version of the package you retrieved in the earlier step.

- Verify the package installation by running:

```
tanzu package installed get api-auto-registration -n tap-install
```

Verify that `STATUS` is `Reconcile succeeded`:

```
kubectl get pods -n api-auto-registration
```

- Verify that applying an `APIDescriptor` resource to your cluster causes the `STATUS` showing `Ready`:

```
kubectl apply -f - <<EOF
apiVersion: apis.apps.tanzu.vmware.com/v1alpha1
kind: APIDescriptor
metadata:
  name: sample-api-descriptor-with-absolute-url
spec:
  type: openapi
  description: A sample APIDescriptor to validate package installation successf
ul
  system: test-installation
  owner: test-installation
  location:
    path: "/api/v3/openapi.json"
    baseURL:
      url: https://petstore3.swagger.io
EOF
```

Verify that the `APIDescriptor` status shows `Ready`:

```
kubectl get apidescriptors
NAME                                STATUS
sample-api-descriptor-with-absolute-url  Ready

kubectl get apidescriptors -owide
NAME                                STATUS  TAP GUI ENTITY URL  API
SPEC URL
sample-api-descriptor-with-absolute-url  Ready  <url-to-the-entity>  <ur
l-to-the-api-spec>
```

If the status does not show `Ready`, you can inspect the reason with the detailed message shown by running:

```
kubectl get apidescriptor sample-api-descriptor-with-absolute-url -o jsonpath
='{.status.conditions[?(@.type=="Ready")].message}'
```

Verify that the entity is created in your Tanzu Developer Portal: [TAP-GUI-URL/catalog/default/api/sample-api-descriptor-with-absolute-url](#)

Use API Auto Registration

This topic describes how you can use API Auto Registration.



Note

The run profile requires you to [update the install values](#) before proceeding. For iterate and full profiles, the default values work but you might prefer to update them. For information about profiles, see [About Tanzu Application Platform profiles](#).

API Auto Registration requires the following:

1. A location exposing a dynamic or static API specification.
2. An APIDescriptor Custom Resource (CR) with that location created in the cluster.
3. (Optional) Configure Cross-Origin Resource Sharing (CORS) for OpenAPI specifications.

To generate OpenAPI Spec:

- [By creating a simple Spring Boot app](#)
- [By scaffolding a new project using App Accelerator Template](#)
- [In an existing Spring Boot project](#)

To create APIDescriptor Custom Resource:

- [Using Out Of The Box Supply Chains](#)
- [Using Custom Supply Chains](#)
- [Using other GitOps processes or Manually](#)

To configure:

- [CORS for viewing OpenAPI Spec in Tanzu Developer Portal](#)

Generate OpenAPI Spec

Using a Spring Boot app with a REST service

You can use a [Spring Boot example app](#) built using [Building a RESTful Web Service guide](#). and has the [Springdoc dependency](#).

Example of a workload using the Spring Boot app:

```
apiVersion: carto.run/v1alpha1
kind: Workload
metadata:
  name: simple-rest-app
  labels:
    ...
    apis.apps.tanzu.vmware.com/register-api: "true"
spec:
  source:
    ...
  params:
    - name: api_descriptor
      value:
        type: openapi
        location:
          path: "/v3/api-docs"
        system: dev
        owner: team-a
        description: "A set of API endpoints."
```

Using App Accelerator Template

If you are creating a new application exposing an API, you might use the [java-rest-service](#) App Accelerator template to get a pre-built app that includes a [workload.yaml](#) with a basic REST API.

From your Tanzu Developer Portal (formerly called Tanzu Application Platform GUI) Accelerators tab, search for the accelerator and scaffold it according to your needs.

Using an existing Spring Boot project using springdoc

If you have an existing Spring Boot app that exposes an API, you can generate OpenAPI specifications using springdoc. See the [springdoc documentation](#)

After you have springdoc configured and an OpenAPI automatically generated, you can choose one of the three methods of creating the APIDescriptor custom resource. VMware recommends having your Spring Boot app to be managed using Workloads and the Out-Of-The-Box (OOTB) supply chain. See the [Use Out-Of-The-Box \(OOTB\) supply chains](#) for further instructions. Alternatively, if you want to use custom supply chains, see [Using Custom Supply Chains](#). Lastly, if you want to use a different GitOps process or manage the APIDescriptor CR manually, see the [Using other GitOps processes or Manually](#) section.

Create APIDescriptor Custom Resource

Use Out-Of-The-Box (OOTB) supply chains

All the Out-Of-The-Box (OOTB) supply chains are modified so that they can use API Auto Registration. If you want your workload to be auto registered, you must make modifications to your workload YAML:

1. Add the label `apis.apps.tanzu.vmware.com/register-api: "true"`.
2. Add a parameter of `type api_descriptor`:

```
params:
  - name: api_descriptor
    value:
      type: openapi # We currently support any of openapi, aysncapi, graphql, grpc
      location:
        path: "/v3/api-docs" # The path to the api documentation
        owner: team-petclinic # The team that owns this
        description: "A set of API endpoints to manage the resources within the petclinic app."
```

There are 2 different options for the location:

- The default supply chains use Knative to deploy your applications. In this event the only location information you must send is the path to the API documentation. The controller can figure out the base URL for you.
- You can hardcode the URL using the baseURL property. The controller uses a combination of this baseURL and your path to retrieve the YAML.

Example workload that exposes a Knative service:

```
apiVersion: carto.run/v1alpha1
kind: Workload
metadata:
  name: petclinic-knative
  labels:
    ...
    apis.apps.tanzu.vmware.com/register-api: "true"
spec:
  source:
    ...
  params:
    - name: api_descriptor
```

```

value:
  type: openapi
  location:
    path: "/v3/api-docs"
  system: pet-clinics
  owner: team-petclinic
  description: "A set of API endpoints to manage the resources within the petcli
nic app."

```

Example of a workload with a hardcoded URL to the API documentation:

```

apiVersion: carto.run/v1alpha1
kind: Workload
metadata:
  name: petclinic-hard-coded
  labels:
    ...
    apis.apps.tanzu.vmware.com/register-api: "true"
spec:
  source:
    ...
  params:
    - name: api_descriptor
      value:
        type: openapi
        location:
          baseURL: http://petclinic-hard-coded.my-apps.tapdemo.vmware.com/
          path: "/v3/api-docs"
        owner: team-petclinic
        system: pet-clinics
        description: "A set of API endpoints to manage the resources within the petcli
nic app."

```

After the supply chain runs, it creates an `APIDescriptor` custom resource. This resource is what Tanzu Application Platform uses to auto register your API. See [APIDescriptor explained](#).

Using Custom Supply Chains

If you are creating custom supply chains, you can still use API Auto Registration. To write a supply chain pipeline, use `ClusterConfigTemplate` by the name of `config-template` in your pipeline. To write a custom task, verify how the template is written to read parameters, interpret baseURL from Knative Services, and construct `APIDescriptor` CRs.

In the Delivery pipeline, you must directly create an `APIDescriptor` custom resource. You must grant permissions to create the CR from the delivery pipeline.

For information about `APIDescriptors`, see [Key Concepts](#).

Using other GitOps processes or Manually

Using your GitOps process, or manually, you must stamp out an `APIDescriptor` CR and apply it in the cluster you choose. Be sure specify all the required fields for an `APIDescriptor` CR to reconcile.

For information about `APIDescriptors`, see [Key Concepts](#).

Additional configuration

Setting up CORS for OpenAPI specifications

The agent, usually a browser, uses the `CORS` protocol to verify whether the current origin uses an API. To use the “Try it out” feature for OpenAPI specifications from the API Documentation plugin, you must configure CORS to allow successful requests.

Your API must be configured to allow CORS Requests from Tanzu Developer Portal. How you accomplish this varies based on the programming language and framework you are using. If you are using Spring, see [CORS support in spring framework](#).

At a high level, the Tanzu Developer Portal domain must be accepted as valid cross-origin by your API.

Verify the following:

- **Origins allowed** header: `Access-Control-Allow-Origin`: A list of comma-separated values. This list must include your Tanzu Developer Portal host.
- **Methods allowed** header: `Access-Control-Allow-Method`: Must allow the method used by your API. Also confirm that your API supports preflight requests, a valid response to the OPTIONS HTTP method.
- **Headers allowed** header: `Access-Control-Allow-Headers`: If the API requires any header, you must include it in the API configuration or your authorization server.

Troubleshoot API Auto Registration

This topic contains ways that you can troubleshoot API Auto Registration.

Debug API Auto Registration

This section includes commands for debugging or troubleshooting the APIDescriptor Custom Resource (commonly known as CR).

1. Get the details of APIDescriptor CR.

```
kubectl get apidescriptor API-DESCRIPTOR-NAME -owide
```

Where `API-DESCRIPTOR-NAME` is the name of the API descriptor you want to debug.

2. Find the status of the APIDescriptor CR.

```
kubectl get apidescriptor API-DESCRIPTOR-NAME -o jsonpath='{.status.conditions}'
```

Where `API-DESCRIPTOR-NAME` is the name of the API descriptor you want to debug.

3. Read logs from the `api-auto-registration` controller.

```
kubectl -n api-auto-registration logs deployment.apps/api-auto-registration-controller
```

4. Patch an APIDescriptor that is stuck in Deleting mode.

This might happen if the controller package is uninstalled before you clean up the APIDescriptor resources. You can reinstall the package and delete all the APIDescriptor resources first, or run the following command for each stuck APIDescriptor resource.

```
kubectl patch apidescriptor API-DESCRIPTOR-NAME -p '{"metadata":{"finalizers":null}}' --type=merge
```

Where `API-DESCRIPTOR-NAME` is the name of the API descriptor you want to debug.



Note

If you manually remove the finalizers from the APIDescriptor resources, you can have stale API entities within Tanzu Developer Portal (formerly called Tanzu Application Platform GUI) that you must manually deregister.

APIDescriptor CRD shows message of `connection refused` but service is up and running

In Tanzu Application Platform v1.4 and later, if your workloads use ClusterIssuer for the TLS configuration or your API specifications location URL is secured using a custom CA, you might encounter the following message.

Your APIDescription CRD shows a status and message similar to:

```
Message:          Get "https://spring-petclinic.example.com/v3/api-docs": dial tcp 12.34.56.78:443: connect: connection refused
Reason:          FailedToRetrieve
Status:          False
Type:            APISpecResolved
Last Transition Time: 2022-11-28T09:59:13Z
```

This might be due to your workloads using a custom Ingress issuer. To solve this issue, either:

- Configure `ca_cert_data` following the instructions in [Configure CA Cert Data](#).
- Deactivate TLS by setting `shared.ingress_issuer: ""`. VMware discourages this method. Deactivating TLS reduces your ability to test plugin functionality and iterate quickly.

Configure CA Cert Data

1. Obtain the PEM Encoded crt file for your ClusterIssuer or TLS setup . You use this to update the `api-auto-registration` package.
2. If you installed the API Auto Registration package through predefined profiles, you must update the `tap-values.yaml` and update the Tanzu Application Platform installation. Place the PEM encoded certificate into the `shared.ca_cert_data` key of the values file. See [Install your Tanzu Application Platform profile](#). Run the following command to update the package.

```
tanzu package installed update tap -p tap.tanzu.vmware.com -v TAP-VERSION --values-file tap-values.yaml -n tap-install
```

Where `TAP-VERSION` is the version of Tanzu Application Platform installed.

3. If you installed the API Auto Registration package as standalone, you must update the `api-auto-registration-values.yaml` and then update the package. Place the PEM encoded certificate into the `ca_cert_data` key of the values file. Run to update the package.

```
tanzu package installed update api-auto-registration --version API-AUTO-REGISTRATION-VERSION --namespace tap-install --values-file api-auto-registration-values.yaml
```

Where `API-AUTO-REGISTRATION-VERSION` is the version of API Auto Registration installed.

You can find the available api-auto-registration versions by running:

```
tanzu package available list -n tap-install | grep 'API Auto Registration'
```

APIDescriptor CRD shows message of `x509: certificate signed by unknown authority` but service is running

Your APIDescription CRD shows a status and message similar to:

```

Message:          Put "https://tap-gui.tap.my-cluster.tapdemo.vmware.com/api/
catalog/immediate/entities": x509: certificate signed by unknown authority
Reason:          Error
Status:          False
Type:            Ready
Last Transition Time: 2022-11-28T09:59:13Z

```

This is the same issue as `connection refused` described earlier.

Overview of API portal for VMware Tanzu

You can use API portal for VMware Tanzu to find APIs you can use in your own applications. You can view detailed API documentation and try out an API to meet your needs. API portal assembles its dashboard and detailed API documentation views by ingesting OpenAPI documentation from the source URLs. An API portal operator can add any number of OpenAPI source URLs in a single instance.

Getting started

To install the package without the predefined profiles of Tanzu Application Platform, see [Install API portal](#).

For information about API portal for VMware Tanzu, see [API portal for VMware Tanzu](#).

For information about configuring the package, see [Configuring API portal for VMware Tanzu on Kubernetes](#).

API portal for VMware Tanzu supports:

- Authentication through Single Sign-On (SSO)
- API keys configuration and management
- Secure communication by using TLS

Overview of API portal for VMware Tanzu

You can use API portal for VMware Tanzu to find APIs you can use in your own applications. You can view detailed API documentation and try out an API to meet your needs. API portal assembles its dashboard and detailed API documentation views by ingesting OpenAPI documentation from the source URLs. An API portal operator can add any number of OpenAPI source URLs in a single instance.

Getting started

To install the package without the predefined profiles of Tanzu Application Platform, see [Install API portal](#).

For information about API portal for VMware Tanzu, see [API portal for VMware Tanzu](#).

For information about configuring the package, see [Configuring API portal for VMware Tanzu on Kubernetes](#).

API portal for VMware Tanzu supports:

- Authentication through Single Sign-On (SSO)
- API keys configuration and management

- Secure communication by using TLS

Install API portal for VMware Tanzu

This topic tells you how to install and update Tanzu API portal for VMware Tanzu from the Tanzu Application Platform (commonly known as TAP) package repository.



Note

Follow the steps in this topic if you do not want to use a profile to install API portal. For more information about profiles, see [Components and installation profiles](#).

Prerequisites

Before installing API portal:

- Complete all prerequisites to install Tanzu Application Platform. For more information, see [Prerequisites](#).

Install

To install the API portal package:

1. Confirm what versions of API portal are available to install by running:

```
tanzu package available list -n tap-install api-portal.tanzu.vmware.com
```

For example:

```
$ tanzu package available list api-portal.tanzu.vmware.com --namespace tap-inst
all
- Retrieving package versions for api-portal.tanzu.vmware.com...
  NAME                                VERSION  RELEASED-AT
  api-portal.tanzu.vmware.com         1.0.3   2021-10-13T00:00:00Z
```

2. (Optional) Gather values schema.

```
tanzu package available get api-portal.tanzu.vmware.com/VERSION-NUMBER --values
-schema --namespace tap-install
```

Where **VERSION-NUMBER** is the version of the API Portal package listed earlier.

For example:

```
$ tanzu package available get api-portal.tanzu.vmware.com/1.0.3 --values-schema
--namespace tap-install

Retrieving package details for api-portal.tanzu.vmware.com/1.0.3...
```

3. (Optional) VMware recommends creating [api-portal-values.yaml](#).

To overwrite the default values when installing the package, create a [api-portal-values.yaml](#) file by following the values schema.

4. Install API portal by running:

```
tanzu package install api-portal -n tap-install -p api-portal.tanzu.vmware.com
-v VERSION-NUMBER --values-file api-portal-values.yaml
```

Where `VERSION-NUMBER` is the version of the API Portal package listed earlier.

For example:

```
$ tanzu package install api-portal -n tap-install -p api-portal.tanzu.vmware.com
-m -v 1.0.3 --values-file api-portal-values.yaml

/ Installing package 'api-portal.tanzu.vmware.com'
| Getting namespace 'api-portal'
| Getting package metadata for 'api-portal.tanzu.vmware.com'
| Creating service account 'api-portal-api-portal-sa'
| Creating cluster admin role 'api-portal-api-portal-cluster-role'
| Creating cluster role binding 'api-portal-api-portal-cluster-rolebinding'
/ Creating package resource
- Package install status: Reconciling

Added installed package 'api-portal' in namespace 'tap-install'
```

5. Verify the package installation by running:

```
tanzu package installed get api-portal -n tap-install
```

Verify that `STATUS` is `Reconcile succeeded`:

```
kubectl get pods -n api-portal
```

Update the installation values for the `api-portal` package

To update the installation values for the `api-portal` package:

1. To overwrite the default values, create new values, or update the existing values, you need an `api-portal-values.yaml` file. If you do not already have an existing values file, you can extract the existing values by running:

```
tanzu package installed get api-portal -n tap-install --values-file-output api-portal-values.yaml
```

You can view the schema of the package:

```
tanzu package available get apis.apps.tanzu.vmware.com/VERSION-NUMBER --values-schema --namespace tap-install
```

Where `VERSION-NUMBER` is the version of the API Portal package listed in the earlier step.

For example:

```
tanzu package available get api-portal.tanzu.vmware.com/1.2.5 --values-schema --namespace tap-install
```

2. Update the package by using the Tanzu CLI:

```
tanzu package installed update api-auto-registration
--package apis.apps.tanzu.vmware.com
--namespace tap-install
--version VERSION-NUMBER
--values-file api-portal-values.yaml
```

Where `VERSION-NUMBER` is the version of the API Portal package listed in the earlier step.

3. If you installed the API portal package as part of Tanzu Application Platform, you must update the `tap-values.yaml` and update the installation of Tanzu Application Platform. See [Install your Tanzu Application Platform profile](#).

```
tanzu package installed update tap --package tap.tanzu.vmware.com --version VERSION-NUMBER --values-file tap-values.yaml -n tap-install
```

Where `VERSION-NUMBER` is the version of the API Portal package listed in the earlier step.



Note

You can update API portal as part of upgrading Tanzu Application Platform. See [Upgrading Tanzu Application Platform](#).

Overview of API Validation and Scoring

API Validation and Scoring focuses on scanning and validating an OpenAPI specification. The API specification is generated from the [API Auto Registration](#). After an API is registered, the API specification goes through static scan analysis and is validated. Based on the validation, a scoring is provided to indicate the quality and health of the API specification as it relates to Documentation, OpenAPI best practices, and Security. The Validation Analysis card on the API overview page displays the summary of the scores. To learn more details about the scores, you can go to the detailed view by clicking the **MORE DETAILS** link.

API Validation and Scoring helps you to ensure your APIs are secure and robust, by providing feedback and recommendations early on in the software development life cycle. Based on the feedback and recommendations, you can edit your API specifications, improve the scores and the posture of your APIs and better understand how well the APIs are implemented.

Overview of API Validation and Scoring

API Validation and Scoring focuses on scanning and validating an OpenAPI specification. The API specification is generated from the [API Auto Registration](#). After an API is registered, the API specification goes through static scan analysis and is validated. Based on the validation, a scoring is provided to indicate the quality and health of the API specification as it relates to Documentation, OpenAPI best practices, and Security. The Validation Analysis card on the API overview page displays the summary of the scores. To learn more details about the scores, you can go to the detailed view by clicking the **MORE DETAILS** link.

API Validation and Scoring helps you to ensure your APIs are secure and robust, by providing feedback and recommendations early on in the software development life cycle. Based on the feedback and recommendations, you can edit your API specifications, improve the scores and the posture of your APIs and better understand how well the APIs are implemented.

Install API Validation and Scoring

This topic tells you how to install API Validation and Scoring from the Tanzu Application Platform (commonly known as TAP) package repository.

Prerequisites

Before installing API Validation and Scoring, complete the following prerequisites:

1. Create a [Broadcom Support](#) account to download Tanzu Application Platform packages.

2. Provision Kubernetes cluster v1.22, v1.23 or v1.24 on Amazon Elastic Kubernetes Service.



Note

The Installation of API scoring and validation package must be done on a new cluster without any existing Tanzu Application Platform installations.

3. [Install Tanzu CLI](#).
4. [Install kapp](#).
5. Install Kubernetes CLI. For more information, see [Install Tools](#) in the Kubernetes documentation.
6. [Deploy Cluster Essentials](#)

Resource requirements

To deploy API Validation and Scoring package, your cluster must have at least:

- 5 nodes.
- 4 vCPUs available per node.
- 16 GB of RAM available per node.
- 100 GB of disk space available across all nodes.

Relocate images to a registry



Before installation, you must relocate the Tanzu Application Platform images from tanzu.packages.broadcom.com to your own container image registry.

The supported registries are Harbor, Azure Container Registry, Google Container Registry, and Quay.io. See the following documentation to learn how to set up your container image registry:

- [Harbor documentation](#)
- [Google Container Registry documentation](#)
- [Quay.io documentation](#)

To relocate images from tanzu.packages.broadcom.com to your registry:

1. Retrieve your Broadcom registry API token:
 1. Sign in to the [Broadcom Support Portal](#).
 2. Go to [Tanzu Application Platform \(TAP\)](#) and expand the **VMware Tanzu Application Platform** dropdown.
 3. Click the Token Download icon next to the Tanzu Application Platform version you want to download.

Release	Release Level Info	Language	
1.10.1	521283	English	
1.10.0	360181	English	
1.9.1	360147	English	

- Follow the instructions in the dialog box. Save the token as a variable named `MY_BROADCOM_SUPPORT_ACCESS_TOKEN`. For example:

```
export MY_BROADCOM_SUPPORT_ACCESS_TOKEN=API-TOKEN
```

Where `API-TOKEN` is your token from the Broadcom Support Portal.

- Set up environment variables for installation use by running:

```
export IMGPKG_REGISTRY_HOSTNAME_0=tanzu.packages.broadcom.com
export IMGPKG_REGISTRY_USERNAME_0=MY-BROADCOM-SUPPORT-USERNAME
export IMGPKG_REGISTRY_PASSWORD_0=${MY_BROADCOM_SUPPORT_ACCESS_TOKEN}
export IMGPKG_REGISTRY_HOSTNAME_1=MY-REGISTRY
export IMGPKG_REGISTRY_USERNAME_1=MY-REGISTRY-USER
export IMGPKG_REGISTRY_PASSWORD_1=MY-REGISTRY-PASSWORD
export INSTALL_REGISTRY_USERNAME="${IMGPKG_REGISTRY_USERNAME_1}"
export INSTALL_REGISTRY_PASSWORD="${IMGPKG_REGISTRY_PASSWORD_1}"
export APIX_VERSION=VERSION-NUMBER
export INSTALL_REPO=TARGET-REPOSITORY
```

Where:

- `MY-BROADCOM-SUPPORT-USERNAME` is the user with access to the images in `tanzu.packages.broadcom.com`.
- `MY-REGISTRY` is your own container registry.
- `MY-REGISTRY-USER` is the user with write access to `MY-REGISTRY`.
- `MY-REGISTRY-PASSWORD` is the password for `MY-REGISTRY-USER`.
- `VERSION-NUMBER` is your API Validation and Scoring package version. For example, `0.2.5`
- `TARGET-REPOSITORY` is your target repository, a folder/repository on `MY-REGISTRY` that serves as the location for the installation files for API Validation and Scoring.

- Install the Carvel tool `imgpkg` CLI.

To query for the available `imgpkg` CLI versions on `tanzu.packages.broadcom.com`, run:

```
imgpkg tag list -i tanzu.packages.broadcom.com/tanzu-application-platform/apix
| sort -V
```

- Relocate the images with the `imgpkg` CLI by running:

```
imgpkg copy -b tanzu.packages.broadcom.com/tanzu-application-platform/apix:${APIX_VERSION} --to-repo ${INSTALL_REGISTRY_HOSTNAME}/${INSTALL_REPO}/apix
```

Add the API Validation and Scoring package repository

Tanzu CLI packages are available on repositories. Adding the API Validation and Scoring package repository makes the packages available for installation.

To add the API Validation and Scoring package repository to your cluster:

- Create a namespace called `apix-install` for deploying API Validation and Scoring package by running:

```
kubectl create ns apix-install
```

This namespace keeps the objects grouped together logically.

2. Create a secret for adding the API Validation and Scoring package repository:

```
tanzu secret registry add tap-registry --username ${INSTALL_REGISTRY_USERNAME}
--password ${INSTALL_REGISTRY_PASSWORD} --server ${INSTALL_REGISTRY_HOSTNAME} -
-export-to-all-namespaces --yes --namespace apix-install
```

3. Add the API Validation and Scoring package repository to the cluster by running:

```
tanzu package repository add apix-repository \
--url ${INSTALL_REGISTRY_HOSTNAME}/${INSTALL_REPO}/apix:${APIX_VERSION} \
--namespace apix-install
```

4. Verify the package installation by running:

```
tanzu package available list -n apix-install
```

If the package installed, expect to see the output that resembles the following:

NAME	DISPLAY-NAME	SHORT_DESCRIPTION	L
ATEST-VERSION			
apix.apps.tanzu.vmware.com	apix	apix.apps.tanzu.vmware.com	
0.2.5			

5. Get the status of the API Validation and Scoring package repository by running:

```
tanzu package repository get apix-repository --namespace apix-install
```

For example:

```
~ % tanzu package repository get apix-repository --namespace apix-install
NAME:      apix-repository
VERSION:   796582
REPOSITORY: projects.registry.vmware.com/mazinger/apix
TAG:       0.2.5
STATUS:    Reconcile succeeded
REASON:
```

Verify the **STATUS** is **Reconcile succeeded**

Install

Follow these steps to install the API Validation and Scoring package:

1. To overwrite the default values when installing the package, create the `apix-values.yaml` file:

```
apix:
  host: "HOST"
  backstage:
    host: "BACKSTAGE-HOST"
    port: "BACKSTAGE-PORT"
```

Where:

- o **HOST** is the hostname of the API Validation and Scoring GUI. It can be left empty "" to use the default value.
- o **BACKSTAGE-HOST** is the Tanzu Developer Portal or Backstage host that you want to point to. For example, <https://tap-gui.view-cluster.com>

- `BACKSTAGE-PORT` is the Tanzu Developer Portal or Backstage port that you want to point to. For example, `443`

2. Install the API Validation and Scoring package using the Tanzu CLI by running:

```
tanzu package install apix -n apix-install -p apix.apps.tanzu.vmware.com -v ${APIX_VERSION} -f apix-values.yaml
```

3. Verify that STATUS is `Reconcile succeeded` by running:

```
tanzu package installed get apix -n apix-install
```

If your package successfully reconciled, expect to see the output that resembles the following::

```
NAME:                apix
PACKAGE-NAME:       apix.apps.tanzu.vmware.com
PACKAGE-VERSION:    0.2.5
STATUS:             Reconcile succeeded
CONDITIONS:        [{"ReconcileSucceeded True  }]
USEFUL-ERROR-MESSAGE:
```

Uninstall

Uninstall the API Validation and Scoring package by running:

```
tanzu package installed delete apix -n apix-install
```

For example:

```
% tanzu package installed delete apix -n apix-install
Deleting installed package 'apix' in namespace 'apix-install'. Are you sure? [y/N]: y
Uninstalling package 'apix' from namespace 'apix-install'
Getting package install for 'apix'
Deleting package install 'apix' from namespace 'apix-install'
'PackageInstall' resource deletion status: Deleting
Deleting admin role 'apix-apix-install-cluster-role'
Deleting role binding 'apix-apix-install-cluster-rolebinding'
Deleting secret 'apix-apix-install-values'
Deleting service account 'apix-apix-install-sa'
Uninstalled package 'apix' from namespace 'apix-install'
```

Use API Validation and Scoring to score your auto-registered API

Use API Validation and Scoring to score your auto-registered API

This topic tells you how an [Auto Registered API](#) is scored:

- See [Use API Auto Registration](#) to deploy the workload.
- Go to Tanzu Developer Portal (formerly named Tanzu Application Platform GUI) to view the API.
- The **Overview** tab of your API in Tanzu Developer Portal shows the API scores.
- To view more details about the Validation Analysis and the required improvements for your API, click **MORE DETAILS**.

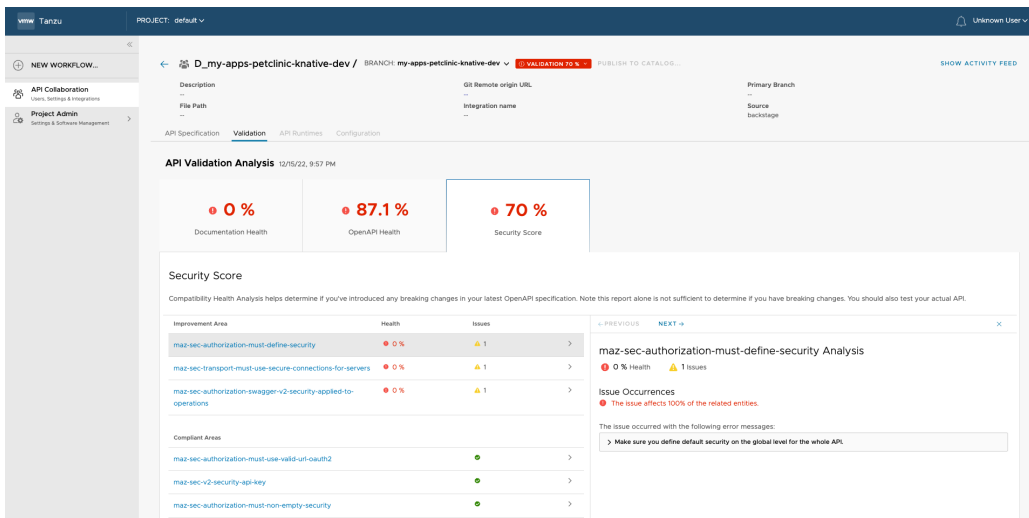
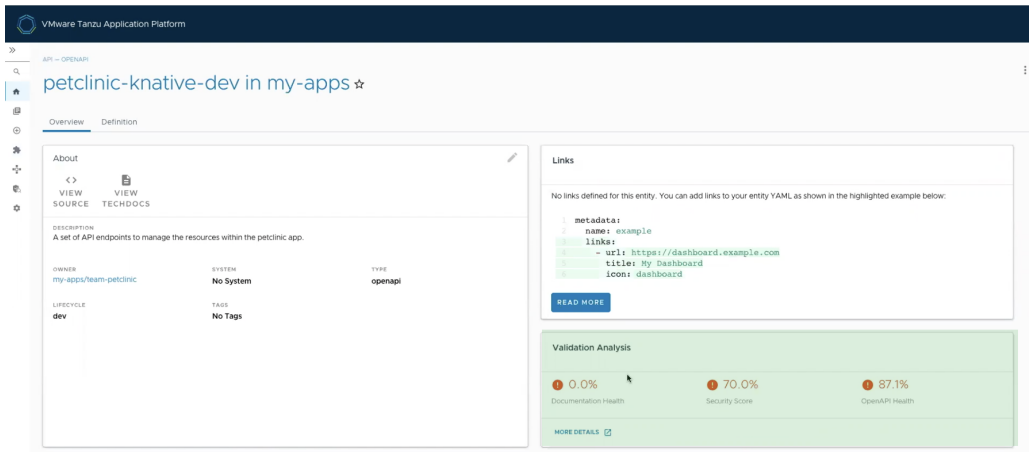

Overview of Application Accelerator

This topic tells you about the Application Accelerator component and architecture in Tanzu Application Platform (commonly known as TAP).

Overview

Application Accelerator for VMware Tanzu helps you bootstrap developing your applications and deploying them in a discoverable and repeatable way.

Enterprise Architects author and publish accelerator projects that provide developers and operators in their organization ready-made, conforming code and configurations.

Published accelerator projects are maintained in Git repositories. You can then use Application Accelerator to create new projects based on those accelerator projects.

The Application Accelerator UI enables you to discover available accelerators, configure them, and generate new projects to download.

Architecture

The following diagram of Accelerator components illustrates the Application Accelerator architecture.

Accelerator Components

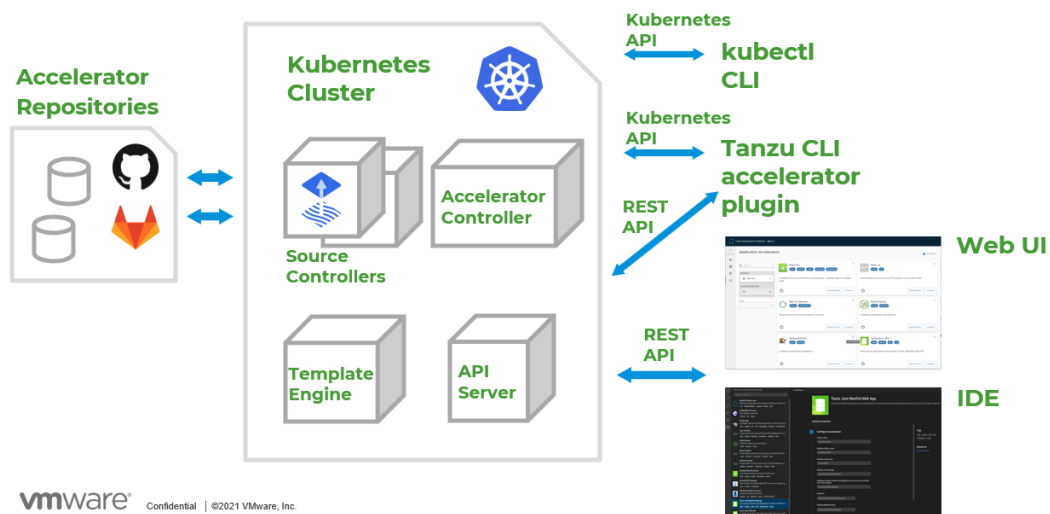

How does Application Accelerator work?

Application Accelerator allows you to generate new projects from files in Git repositories. An `accelerator.yaml` file in the repository declares input options for the accelerator. This file also contains instructions for processing the files when you generate a new project.

Accelerator custom resources (CRs) control which repositories appear in both the Tanzu Application Platform Application Accelerator UI and in the Application Accelerator extension for VS Code. You can maintain CRs by using Kubernetes tools such as `kubectl` or by using the Tanzu CLI accelerator commands. The Accelerator controller reconciles the CRs with a Flux2 Source Controller to fetch files from GitHub or GitLab.

The Application Accelerator web UI gives you a searchable list of accelerators to choose from. After you select an accelerator, the UI presents text boxes for the options that are defined within the `accelerator.yaml` of the selected accelerator.

Application Accelerator sends the input values to the Accelerator Engine for processing. (Optional) The user can choose to have a new Git repository created as part of the project creation process. The Engine then returns the project in a ZIP file. If the project was generated using the Application Accelerator extension for VS Code, the project automatically be extracted to the directory location of your choice on your local machine. You can then open the project in your favorite integrated development environment (IDE) to develop further.

Next steps

Learn more about:

- [Creating Accelerators](#)

Overview of Application Accelerator

This topic tells you about the Application Accelerator component and architecture in Tanzu Application Platform (commonly known as TAP).

Overview

Application Accelerator for VMware Tanzu helps you bootstrap developing your applications and deploying them in a discoverable and repeatable way.

Enterprise Architects author and publish accelerator projects that provide developers and operators in their organization ready-made, conforming code and configurations.

Published accelerator projects are maintained in Git repositories. You can then use Application Accelerator to create new projects based on those accelerator projects.

The Application Accelerator UI enables you to discover available accelerators, configure them, and generate new projects to download.

Architecture

The following diagram of Accelerator components illustrates the Application Accelerator architecture.

Accelerator Components

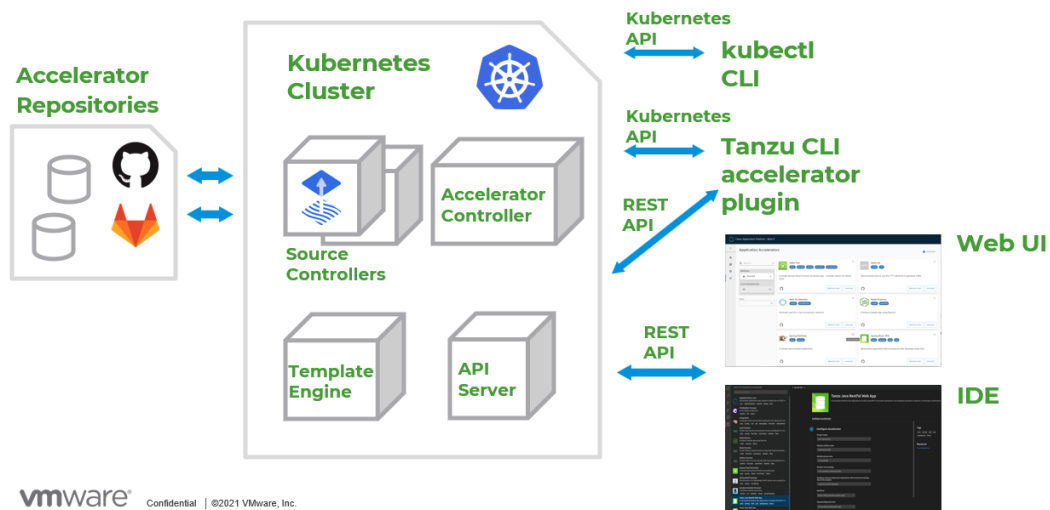

How does Application Accelerator work?

Application Accelerator allows you to generate new projects from files in Git repositories. An `accelerator.yaml` file in the repository declares input options for the accelerator. This file also contains instructions for processing the files when you generate a new project.

Accelerator custom resources (CRs) control which repositories appear in both the Tanzu Application Platform Application Accelerator UI and in the Application Accelerator extension for VS Code. You can maintain CRs by using Kubernetes tools such as `kubectl` or by using the Tanzu CLI accelerator commands. The Accelerator controller reconciles the CRs with a Flux2 Source Controller to fetch files from GitHub or GitLab.

The Application Accelerator web UI gives you a searchable list of accelerators to choose from. After you select an accelerator, the UI presents text boxes for the options that are defined within the `accelerator.yaml` of the selected accelerator.

Application Accelerator sends the input values to the Accelerator Engine for processing. (Optional) The user can choose to have a new Git repository created as part of the project creation process. The Engine then returns the project in a ZIP file. If the project was generated using the Application Accelerator extension for VS Code, the project automatically be extracted to the directory location of your choice on your local machine. You can then open the project in your favorite integrated development environment (IDE) to develop further.

Next steps

Learn more about:

- [Creating Accelerators](#)

Install Application Accelerator

This topic tells you how to install Application Accelerator from the Tanzu Application Platform (commonly known as TAP) package repository.



Note

Follow the steps in this topic if you do not want to use a profile to install Application Accelerator. For more information about profiles, see [About Tanzu Application Platform components and profiles](#).

Prerequisites

Before installing Application Accelerator:

- Complete all prerequisites to install Tanzu Application Platform. For more information, see [Prerequisites](#).
- Install Flux SourceController on the cluster. See [Install Flux CD Source Controller](#).
- Install Source Controller on the cluster. See [Install Source Controller](#).

Install

To install Application Accelerator:

1. List version information for the package by running:

```
tanzu package available list accelerator.apps.tanzu.vmware.com --namespace tap-install
```

For example:

```
$ tanzu package available list accelerator.apps.tanzu.vmware.com --namespace tap-install

- Retrieving package versions for accelerator.apps.tanzu.vmware.com...
NAME                                VERSION  RELEASED-AT
accelerator.apps.tanzu.vmware.com  1.4.0    2022-12-08 12:00:00 -0500 EST
```

2. (Optional) View the changes you can make to the default installation settings by running:

```
tanzu package available get accelerator.apps.tanzu.vmware.com/VERSION-NUMBER \
--values-schema \
--namespace tap-install
```

Where **VERSION-NUMBER** is the version of the Application Accelerator package listed earlier.

For example:

```
$ tanzu package available get accelerator.apps.tanzu.vmware.com/1.4.0 \
--values-schema \
--namespace tap-install
```

For more information about values schema options, see the properties listed in [Configure properties and resource use](#) later.

3. Create a file named `app-accelerator-values.yaml` using the following example code:

```
server:
  service_type: "LoadBalancer"
  watched_namespace: "accelerator-system"
samples:
  include: true
```

4. Edit the values in your `app-accelerator-values.yaml` if needed, or leave the default values. You can add values you want from [Configure properties and resource use](#).
5. Install the package by running:

```
tanzu package install app-accelerator \
  --package accelerator.apps.tanzu.vmware.com \
  --version VERSION-NUMBER \
  --namespace tap-install \
  --values-file app-accelerator-values.yaml
```

Where `VERSION-NUMBER` is the version of the Application Accelerator package listed earlier.

For example:

```
$ tanzu package install app-accelerator \
  --package accelerator.apps.tanzu.vmware.com \
  --version 1.4.0 \
  --namespace tap-install \
  --values-file app-accelerator-values.yaml

- Installing package 'accelerator.apps.tanzu.vmware.com'
| Getting package metadata for 'accelerator.apps.tanzu.vmware.com'
| Creating service account 'app-accelerator-tap-install-sa'
| Creating cluster admin role 'app-accelerator-tap-install-cluster-role'
| Creating cluster role binding 'app-accelerator-tap-install-cluster-rolebinding'
| Creating secret 'app-accelerator-tap-install-values'
- Creating package resource
- Package install status: Reconciling

Added installed package 'app-accelerator' in namespace 'tap-install'
```

6. Verify the package install by running:

```
tanzu package installed get app-accelerator -n tap-install
```

For example:

```
$ tanzu package installed get app-accelerator -n tap-install

| Retrieving installation details for cc...
NAME:                app-accelerator
PACKAGE-NAME:        accelerator.apps.tanzu.vmware.com
PACKAGE-VERSION:     1.4.0
STATUS:              Reconcile succeeded
CONDITIONS:          [{"ReconcileSucceeded True  }]
USEFUL-ERROR-MESSAGE:
```

Verify that `STATUS` is `Reconcile succeeded`.

7. To see the IP address for the Application Accelerator API when the `server.service_type` is set to `LoadBalancer`, run:

```
kubectl get service -n accelerator-system
```

This lists an external IP address for use with the `--server-url` Tanzu CLI flag for the Accelerator plug-in `generate & generate-from-local` command.

For how to troubleshoot installation issues, see [Troubleshoot Application Accelerator](#).

Configure properties and resource use

When you install the Application Accelerator, you can configure the following optional properties from within your `app-accelerator-values.yaml` configuration file:

Property	Default	Description
<code>registry.secret_ref</code>	<code>reg-creds</code>	The secret used for accessing the registry where the App-Accelerator images are located
<code>server.service_type</code>	<code>ClusterIP</code>	The service type for the acc-ui-server service including LoadBalancer, NodePort, or ClusterIP
<code>server.watched_namespace</code>	<code>accelerator-system</code>	The namespace the server watches for accelerator resources
<code>server.engine_invocation_url</code>	<code>http://acc-engine.accelerator-system.svc.cluster.local/invocations</code>	The URL to use for invoking the accelerator engine
<code>engine.service_type</code>	<code>ClusterIP</code>	The service type for the acc-engine service including LoadBalancer, NodePort, or ClusterIP
<code>engine.max_direct_memory_size</code>	<code>32M</code>	The maximum size for the Java -XX:MaxDirectMemorySize setting
<code>samples.include</code>	<code>True</code>	Option to include the bundled sample Accelerators in the installation
<code>ingress.include</code>	<code>False</code>	Option to include the ingress configuration in the installation
<code>ingress.enable_tls</code>	<code>False</code>	Option to include TLS for the ingress configuration
<code>domain</code>	<code>tap.example.com</code>	Top-level domain to use for ingress configuration, default is <code>shared.ingress_domain</code>
<code>tls.secret_name</code>	<code>tls</code>	The name of the secret
<code>tls.namespace</code>	<code>tanzu-system-ingress</code>	The namespace for the secret
<code>telemetry.retain_invocation_events_for_days</code>	<code>30</code>	The number of days to retain recorded invocation events resources
<code>telemetry.record_invocation_events</code>	<code>true</code>	The system records each engine invocation when generating files for an accelerator?
<code>git_credentials.secret_name</code>	<code>git-credentials</code>	The name to use for the secret storing Git credentials for accelerators
<code>git_credentials.username</code>	<code>null</code>	The user name to use in secret storing Git credentials for accelerators
<code>git_credentials.password</code>	<code>null</code>	The password to use in secret storing Git credentials for accelerators

Property	Default	Description
<code>git_credentials.ca_file</code>	<code>null</code>	The CA certificate data to use in secret storing Git credentials for accelerators
<code>managed_resources.enabled</code>	<code>false</code>	Whether to enable the App used to control managed accelerator resources
<code>managed_resources.git.url</code>	<code>none</code>	Required if managed_resources are enabled. Git repository URL containing manifests for managed accelerator resources
<code>managed_resources.git.ref</code>	<code>origin/main</code>	Required if managed_resources are enabled. Git ref to use for repository containing manifests for managed accelerator resources
<code>managed_resources.git.sub_path</code>	<code>null</code>	Git subPath to use for repository containing manifests for managed accelerator resources
<code>managed_resources.git.secret_ref</code>	<code>git-credentials</code>	Secret name to use for repository containing manifests for managed accelerator resources

VMware recommends that you do not override the default setting for `registry.secret_ref`, `server.engine_invocation_url`, or `engine.service_type`. These properties are only used to configure non-standard installations.

The following table is the resource use configurations for the components of Application Accelerator.

Component	Resource requests	Resource limits
acc-controller	CPU: 100m memory: 20Mi	CPU: 100m memory: 30Mi
acc-server	CPU: 100m memory: 20Mi	CPU: 100m memory: 30Mi
acc-engine	CPU: 500m memory: 1Gi	CPU: 500m memory: 2Gi

Configure Application Accelerator

This topic tells you about advanced configuration options available for Application Accelerator in Tanzu Application Platform (commonly known as TAP). This includes configuring Git-Ops style deployments of accelerators and configurations for use with non-public repositories and in air-gapped environments.

Accelerators are created either using the Tanzu CLI or by applying a YAML manifest using `kubectl`. Another option is [Using a Git-Ops style configuration for deploying a set of managed accelerators](#).

Application Accelerator pulls content from accelerator source repositories using either the “Flux SourceController” or the “Tanzu Application Platform Source Controller” components. If the repository used is accessible anonymously from a public server, you do not have to configure anything additional. Otherwise, provide authentication as explained in [Using non-public repositories](#). There are also options for making these configurations easier explained in [Configuring tap-values.yaml with Git credentials secret](#)

Using a Git-Ops style configuration for deploying a set of managed accelerators

To enable a Git-Ops style of managing resources used for deploying accelerators, there is a new set of properties for the Application Accelerator configuration. The resources are managed using a

Carvel kapp-controller App in the `accelerator-system` namespace that watches a Git repository containing the manifests for the accelerators. This means that you can make changes to the manifests, or to the accelerators they point to, and the changes are reconciled and reflected in the deployed resources.

You can specify the following accelerator configuration properties when installing the Application Accelerator. The same properties are provided in the `accelerator` section of the `tap-values.yaml` file:

```

accelerator:
  managed_resources:
    enable: true
  git:
    url: GIT-REPO-URL
    ref: origin/main
    sub_path: null
    secret_ref: git-credentials

```

Where:

- `GIT-REPO-URL` is the URL of a Git repository that contains manifest YAML files for the accelerators that you want to have managed. The URL must start with `https://` or `git@`. You can specify a `sub_path` if necessary and also a `secret_ref` if the repository requires authentication. If not needed, then leave these additional properties out.

For more information, see [Configure tap-values.yaml with Git credentials secret](#) and [Creating a manifest with multiple accelerators and fragments](#) in this topic.

Functional and Organizational Considerations

Any accelerator manifest that is defined under the `GIT-REPO-URL` and optional `sub_path` is selected by the kapp-controller app. If there are multiple manifests at the defined `GIT-REPO-URL`, they are all watched for changes and displayed to the user as a merged catalog.

For example: if you have two manifests containing multiple accelerator or fragment definitions, `manifest-1.yaml`, and `manifest-2.yaml`, on the same path in the organizational considerations. The resulting catalog is (`manifest-1.yaml` + `manifest-2.yaml`).

Examples for creating accelerators

A minimal example for creating an accelerator

A minimal example might look like the following manifest:

`spring-cloud-serverless.yaml`

```

apiVersion: accelerator.apps.tanzu.vmware.com/v1alpha1
kind: Accelerator
metadata:
  name: spring-cloud-serverless
spec:
  git:
    url: https://github.com/vmware-tanzu/application-accelerator-samples
    subPath: spring-cloud-serverless
    ref:
      branch: main

```

This example creates an accelerator named `spring-cloud-serverless`. The `displayName`, `description`, `iconUrl`, and `tags` text boxes are populated based on the content under the

`accelerator` key in the `accelerator.yaml` file found in the `main` branch of the Git repository at [Application Accelerator Samples](#) under the sub-path `spring-cloud-serverless`. For example:

`accelerator.yaml`

```
accelerator:
  displayName: Spring Cloud Serverless
  description: A simple Spring Cloud Function serverless app
  iconUrl: https://raw.githubusercontent.com/vmware-tanzu/application-accelerator-samples/main/icons/icon-cloud.png
  tags:
    - java
    - spring
    - cloud
    - function
    - serverless
    - tanzu
  ...
```

To create this accelerator with `kubectl`, run:

```
kubectl apply --namespace --accelerator-system --filename spring-cloud-serverless.yaml
```

Or, you can use the Tanzu CLI and run:

```
tanzu accelerator create spring-cloud-serverless --git-repo https://github.com/vmware-tanzu/application-accelerator-samples.git --git-branch main --git-sub-path spring-cloud-serverless
```

An example for creating an accelerator with customized properties

You can specify the `displayName`, `description`, `iconUrl`, and `tags` text boxes and this overrides any values provided in the accelerator's Git repository. The following example explicitly sets those text boxes and the `ignore` text box:

`my-spring-cloud-serverless.yaml`

```
apiVersion: accelerator.apps.tanzu.vmware.com/v1alpha1
kind: Accelerator
metadata:
  name: my-spring-cloud-serverless
spec:
  displayName: My Spring Cloud Serverless
  description: My own Spring Cloud Function serverless app
  iconUrl: https://raw.githubusercontent.com/vmware-tanzu/application-accelerator-samples/main/icons/icon-cloud.png
  tags:
    - spring
    - cloud
    - function
    - serverless
  git:
    ignore: ".git/, bin/"
    url: https://github.com/vmware-tanzu/application-accelerator-samples
    subPath: spring-cloud-serverless
    ref:
      branch: test
```

To create this accelerator with `kubectl`, run:

```
kubectl apply --namespace --accelerator-system --filename my-spring-cloud-serverless.yaml
```

To use the Tanzu CLI, run:

```
tanzu accelerator create my-spring-cloud-serverless --git-repo https://github.com/vmware-tanzu/application-accelerator-samples --git-branch main --git-sub-path spring-cloud-serverless \
  --description "My own Spring Cloud Function serverless app" \
  --display-name "My Spring Cloud Serverless" \
  --icon-url https://raw.githubusercontent.com/vmware-tanzu/application-accelerator-samples/main/icons/icon-cloud.png \
  --tags "spring,cloud,function,serverless"
```



Note

It is not possible to provide the `git.ignore` option with the Tanzu CLI.

Creating a manifest with multiple accelerators and fragments

You might have a manifest that contains multiple accelerators or fragments. For example:

`accelerator-collection.yaml`

```
---
apiVersion: accelerator.apps.tanzu.vmware.com/v1alpha1
kind: Accelerator
metadata:
  name: spring-cloud-serverless
spec:
  git:
    url: https://github.com/vmware-tanzu/application-accelerator-samples
    subPath: spring-cloud-serverless
    ref:
      branch: main
---
apiVersion: accelerator.apps.tanzu.vmware.com/v1alpha1
kind: Accelerator
metadata:
  name: tanzu-java-web-app
spec:
  git:
    url: https://github.com/vmware-tanzu/application-accelerator-samples.git
    subPath: tanzu-java-web-app
    ref:
      branch: main
```

For a larger example of this, see [Sample Accelerators Main](#). Optionally, use this to create an initial catalog of accelerators and fragments during a fresh Application Accelerator install.

Configure `tap-values.yaml` with Git credentials secret



Note

For how to create a new OAuth Token for optional Git repository creation, see [Create an Application Accelerator Git repository during project creation](#).

When deploying accelerators using Git repositories that requires authentication or are installed with custom CA certificates, you must provide some additional authentication values in a secret. The examples in the next section provide more details. This section describes how to configure a Git credentials secret that is used in later Git-based examples.

You can specify the following accelerator configuration properties when installing Application Accelerator. The same properties are provided in the `accelerator` section of the `tap-values.yaml` file:

```

accelerator:
  git_credentials:
    secret_name: git-credentials
    username: GIT-USER-NAME
    password: GIT-CREDENTIALS
    ca_file: CUSTOM-CA-CERT

```

Where:

- `GIT-USER-NAME` is the user name for authenticating with the Git repository.
- `GIT-CREDENTIALS` is the password or access token used for authenticating with the Git repository. VMware recommends using an access token for this.
- `CUSTOM-CA-CERT` is the certificate data needed when accessing the Git repository.

This is an example of this part of a `tap-values.yaml` configuration:

```

accelerator:
  git_credentials:
    secret_name: git-credentials
    username: testuser
    password: s3cret
    ca_file: |
      -----BEGIN CERTIFICATE-----
      .
      .
      . < certificate data >
      .
      .
      -----END CERTIFICATE-----

```

You can specify the custom CA certificate data using the shared config value `shared.ca_cert_data` and it propagates to all components that can make use of it, including the App Accelerator configuration. The example earlier produces an output such as this using the shared value:

```

shared:
  ca_cert_data: |
    -----BEGIN CERTIFICATE-----
    .
    .
    . < certificate data >
    .
    .
    -----END CERTIFICATE-----

accelerator:
  git_credentials:
    secret_name: git-credentials
    username: testuser
    password: s3cret

```

Using non-public repositories

For GitHub repositories that aren't accessible anonymously, you must provide credentials in a Secret.

- For HTTPS repositories the secret must contain user name and password fields. The password field can contain a personal access token instead of an actual password. For more

information, see [Fluxcd/source-controller basic access authentication](#).

- For HTTPS with self-signed certificates, you can add a `.data.caFile` value to the secret created for HTTPS authentication. For more information, see [fluxcd/source-controller HTTPS Certificate Authority](#).
- For SSH repositories, the secret must contain `identity`, `identity.pub`, and `known_hosts` text boxes. For more information, see [fluxcd/source-controller SSH authentication](#).
- For Image repositories that aren't publicly available, an image pull secret might be provided. For more information, see [Kubernetes documentation on using imagePullSecrets](#).

Examples for a private Git repository

Example using http credentials

To create an accelerator using a private Git repository, first create a secret with the HTTP credentials.



Note

For better security, use an access token as the password.

```
kubectl create secret generic https-credentials \
  --namespace accelerator-system \
  --from-literal=username=USER \
  --from-literal=password=ACCESS-TOKEN
```

Verify that your secret was created by running:

```
kubectl get secret --namespace accelerator-system https-credentials -o yaml
```

The output is similar to:

```
apiVersion: v1
kind: Secret
metadata:
  name: https-credentials
  namespace: accelerator-system
type: Opaque
data:
  username: <BASE64>
  password: <BASE64>
```

After you created and verified the secret, you can create the accelerator by using the `spec.git.secretRef.name` property:

`private-acc.yaml`

```
apiVersion: accelerator.apps.tanzu.vmware.com/v1alpha1
kind: Accelerator
metadata:
  name: private-acc
spec:
  displayName: private
  description: Accelerator using a private repository
  git:
    url: REPOSITORY-URL
    ref:
      branch: main
```

```
secretRef:
  name: https-credentials
```

For https credentials, the `REPOSITORY-URL` must use `https://` as the URL scheme.

If you are using the Tanzu CLI, add the `--secret-ref` flag to your `tanzu accelerator create` command and provide the name of the secret for that flag.

Example using http credentials with self-signed certificate

To create an accelerator using a private Git repository with a self-signed certificate, create a secret with the HTTP credentials and the certificate.



Note

For better security, use an access token as the password.

```
kubectl create secret generic https-ca-credentials \
  --namespace accelerator-system \
  --from-literal=username=USER \
  --from-literal=password=ACCESS-TOKEN \
  --from-file=caFile=PATH-TO-CA-FILE
```

Verify that your secret was created by running:

```
kubectl get secret --namespace accelerator-system https-ca-credentials -o yaml
```

The output is similar to:

```
apiVersion: v1
kind: Secret
metadata:
  name: https-ca-credentials
  namespace: accelerator-system
type: Opaque
data:
  username: <BASE64>
  password: <BASE64>
  caFile: <BASE64>
```

After you have the secret created, you can create the accelerator by using the `spec.git.secretRef.name` property:

`private-acc.yaml`

```
apiVersion: accelerator.apps.tanzu.vmware.com/v1alpha1
kind: Accelerator
metadata:
  name: private-acc
spec:
  displayName: private
  description: Accelerator using a private repository
  git:
    url: REPOSITORY-URL
    ref:
      branch: main
    secretRef:
      name: https-ca-credentials
```

**Important**

For https credentials, the `REPOSITORY-URL` must use `https://` as the URL scheme.

If you are using the Tanzu CLI, add the `--secret-ref` flag to your `tanzu accelerator create` command and provide the name of the secret for that flag.

Example using SSH credentials

To create an accelerator using a private Git repository, create a secret with the SSH credentials such as this example:

```
ssh-keygen -q -N "" -f ./identity
ssh-keyscan github.com > ./known_hosts
kubectl create secret generic ssh-credentials \
  --namespace accelerator-system \
  --from-file=./identity \
  --from-file=./identity.pub \
  --from-file=./known_hosts
```

If you have a key file already created, skip the `ssh-keygen` and `ssh-keyscan` steps and replace the values for the `kubectl create secret` command. Such as:

- `--from-file=identity=PATH-TO-YOUR-IDENTITY-FILE`
- `--from-file=identity.pub=PATH-TO-YOUR-IDENTITY.PUB-FILE`
- `--from-file=known_hosts=PATH-TO-YOUR-KNOWN-HOSTS-FILE`

Verify that your secret was created by running:

```
kubectl get secret --namespace accelerator-system ssh-credentials -o yaml
```

The output is similar to :

```
apiVersion: v1
kind: Secret
metadata:
  name: ssh-credentials
  namespace: accelerator-system
type: Opaque
data:
  identity: <BASE64>
  identity.pub: <BASE64>
  known_hosts: <BASE64>
```

To use this secret when creating an accelerator, provide the secret name in the `spec.git.secretRef.name` property:

`private-acc-ssh.yaml`

```
apiVersion: accelerator.apps.tanzu.vmware.com/v1alpha1
kind: Accelerator
metadata:
  name: private-acc
spec:
  displayName: private
  description: Accelerator using a private repository
  git:
    url: REPOSITORY-URL
    ref:
      branch: main
```

```
secretRef:
  name: ssh-credentials
```

When using SSH credentials, the `REPOSITORY-URL` must include the user name as part of the URL. For example: `ssh://user@example.com:22/repository.git`. For more information, see [Flux documentation](#).

If you are using the Tanzu CLI, add the `--secret-ref` flag to your `tanzu accelerator create` command and provide the name of the secret for that flag.

Examples for a private source-image repository

If your registry uses a self-signed certificate then you must add the CA certificate data to the configuration for the “Tanzu Application Platform Source Controller” component. Add it under `source_controller.ca_cert_data` in your `tap-values.yaml` file that is used during installation.

`tap-values.yaml`

```
source_controller:
  ca_cert_data: |-
    -----BEGIN CERTIFICATE-----
    .
    .
    . < certificate data >
    .
    .
    -----END CERTIFICATE-----
```

Example using image-pull credentials

To create an accelerator using a private source-image repository, create a secret with the image-pull credentials:

```
create secret generic registry-credentials \
  --namespace accelerator-system \
  --from-literal=username=USER \
  --from-literal=password=PASSWORD
```

Verify that your secret was created by running:

```
kubectl get secret --namespace accelerator-system registry-credentials -o yaml
```

The output is similar to:

```
apiVersion: v1
kind: Secret
metadata:
  name: registry-credentials
  namespace: accelerator-system
type: Opaque
data:
  username: <BASE64>
  password: <BASE64>
```

After you have the secret created, you can create the accelerator by using the `spec.git.secretRef.name` property:

`private-acc.yaml`

```
apiVersion: accelerator.apps.tanzu.vmware.com/v1alpha1
kind: Accelerator
```

```

metadata:
  name: private-acc
spec:
  displayName: private
  description: Accelerator using a private repository
  source:
    image: "registry.example.com/test/private-acc-src:latest"
    imagePullSecrets:
      - name: registry-credentials

```

If you are using the Tanzu CLI, add the `--secret-ref` flag to your `tanzu accelerator create` command and provide the name of the secret for that flag.

Configure ingress timeouts when some accelerators take longer to generate

If Tanzu Application Platform is configured to use an ingress for Tanzu Developer Portal (formerly named Tanzu Application Platform GUI) and the Accelerator Server, then it might detect a timeout during accelerator generation.

This can happen if the accelerator takes a longer time to generate than the default timeout. When this happens, Tanzu Developer Portal appears to continue to run for an indefinite period. In the IDE extension, it shows a `504` error. To mitigate this, you can increase the timeout value for the HTTPProxy resources used for the ingress by applying secrets with overlays to edit the HTTPProxy resources.

Configure an ingress timeout overlay secret for each HTTPProxy

For Tanzu Developer Portal, create the following overlay secret in the `tap-install` namespace:

```

apiVersion: v1
kind: Secret
metadata:
  name: patch-tap-gui-timeout
  namespace: tap-install
stringData:
  patch.yaml: |
    #@ load("@ytt:overlay", "overlay")
    #@overlay/match by=overlay.subset({"kind": "HTTPProxy", "metadata": {"name": "tap-gui"}})
    ---
    spec:
      routes:
        #@overlay/match by=overlay.subset({"services": [{"name": "server"}]})
        #@overlay/match-child-defaults missing_ok=True
        - timeoutPolicy:
            idle: 30s
            response: 30s

```

For Accelerator Server (used for IDE extension), create the following overlay secret in the `tap-install` namespace:

```

apiVersion: v1
kind: Secret
metadata:
  name: patch-accelerator-timeout
  namespace: tap-install
stringData:
  patch.yaml: |
    #@ load("@ytt:overlay", "overlay")
    #@overlay/match by=overlay.subset({"kind": "HTTPProxy", "metadata": {"name": "acce

```



```

lerator"}})
---
spec:
  routes:
    #@overlay/match by=overlay.subset({"services": [{"name": "acc-server"}]})
    #@overlay/match-child-defaults missing_ok=True
    - timeoutPolicy:
        idle: 30s
        response: 30s

```

Apply the timeout overlay secrets in tap-values.yaml

Add the following `package_overlays` section to `tap-values.yaml` before installing or updating Tanzu Application Platform:

```

package_overlays:
- name: tap-gui
  secrets:
  - name: patch-tap-gui-timeout
- name: accelerator
  secrets:
  - name: patch-accelerator-timeout

```

Configuring skipping TLS verification for access to Source Controller

You can configure the Flux or Tanzu Application Platform Source Controller to use Transport Layer Security (TLS) and use custom certificates. In that case, configure the Accelerator System to skip the TLS verification for calls to access the sources by providing the following property in the `accelerator` section of the `tap-values.yaml` file:

```

sources:
  skip_tls_verify: true

```

Enabling TLS for Accelerator Server

To enable TLS for the Accelerator Server, the following properties must be provided in the `accelerator` section of the `tap-values.yaml` file:

```

server:
  tls:
    enabled: true
    key: SERVER-PRIVATE-KEY
    crt: SERVER-CERTIFICATE

```

Where:

- `SERVER-PRIVATE-KEY` is the pem encoded server private key.
- `SERVER-CERTIFICATE` is the pem encoded server certificate.

Here is a sample `tap-values.yaml` configuration with TLS enabled for Accelerators Server:

```

server:
  tls:
    enabled: true
    key: |
      -----BEGIN PRIVATE KEY-----
      .
      . < private key data >

```

```

.
-----END PRIVATE KEY-----
cert: |
-----BEGIN CERTIFICATE-----
.
. < certificate data >
.
-----END CERTIFICATE-----

```

Configuring skipping TLS verification of Engine calls for Accelerator Server

If you configure the Accelerator Engine to use TLS and use custom certificates, then you can configure the Accelerator Server to skip the TLS verification for calls to the Engine by providing the following property in the `accelerator` section of the `tap-values.yaml` file:

```

server:
  engine_skip_tls_verify: true

```

Enabling TLS for Accelerator Engine

To enable TLS for the Accelerator Engine, the following properties are provided in the `accelerator` section of the `tap-values.yaml` file:

```

engine:
  tls:
    enabled: true
    key: ENGINE-PRIVATE-KEY
    crt: ENGINE-CERTIFICATE

```

Where:

- `ENGINE-PRIVATE-KEY` is the pem encoded acc-engine private key.
- `ENGINE-CERTIFICATE` is the pem encoded acc-engine certificate.

Here is a sample `tap-values.yaml` configuration with TLS enabled for Accelerators Engine:

```

engine:
  tls:
    enabled: true
    key: |
      -----BEGIN PRIVATE KEY-----
      .
      . < private key data >
      .
      -----END PRIVATE KEY-----
    crt: |
      -----BEGIN CERTIFICATE-----
      .
      . < certificate data >
      .
      -----END CERTIFICATE-----

```

Next steps

- [Creating accelerators](#)

Create accelerators

This topic tells you how to create an accelerator in Tanzu Developer Portal (formerly named Tanzu Application Platform GUI).

An accelerator contains your conforming code and configurations that developers can use to create new projects that by default follow the standards defined in your accelerators.

Prerequisites

The following prerequisites are required to create an accelerator:

- Application Accelerator is installed. For information about installing Application Accelerator, see [Installing Application Accelerator for VMware Tanzu](#).
- You can access Tanzu Developer Portal from a browser or use the Application Accelerator extension for VS Code.
 - For more information about Tanzu Developer Portal, see [Overview of Tanzu Developer Portal](#).
 - For more information about Application Accelerator extension for VS Code, see [Application Accelerator Visual Studio Code extension](#).
- kubectl is installed and authenticated with admin rights for your target cluster.

Getting started

You can use any Git repository to create an accelerator. You need the URL of the repository to create an accelerator.

For this example, the Git repository is `public` and contains a `README.md` file. These are options available when you create repositories on GitHub.

Use the following procedure to create an accelerator based on this Git repository:

1. Clone your Git repository.
2. Create a file named `accelerator.yaml` in the root directory of this Git repository.
3. Add the following content to the `accelerator.yaml` file:

```

accelerator:
  displayName: Simple Accelerator
  description: Contains just a README
  iconUrl: https://images.freecreatives.com/wp-content/uploads/2015/05/smiley-559124_640.jpg
  tags:
    - simple
    - getting-started

```

Feel free to use a different icon if it uses a reachable URL.

4. Add the new `accelerator.yaml` file, commit this change and push to your Git repository.

Publishing the new accelerator

1. To publish your new accelerator, run:

```

tanzu accelerator create simple --git-repository ${GIT_REPOSITORY_URL} --git-branch ${GIT_REPOSITORY_BRANCH}

```

Where:

- o `GIT-REPOSITORY-URL` is the URL for your Git repository where the accelerator is located.
 - o `GIT-REPOSITORY-BRANCH` is the name of the branch where you pushed the new `accelerator.yaml` file.
2. Refresh Tanzu Developer Portal or the Application Accelerator extension in VS Code to reveal the newly published accelerator. It might take a few seconds to refresh the catalog and add an entry for your new accelerator.

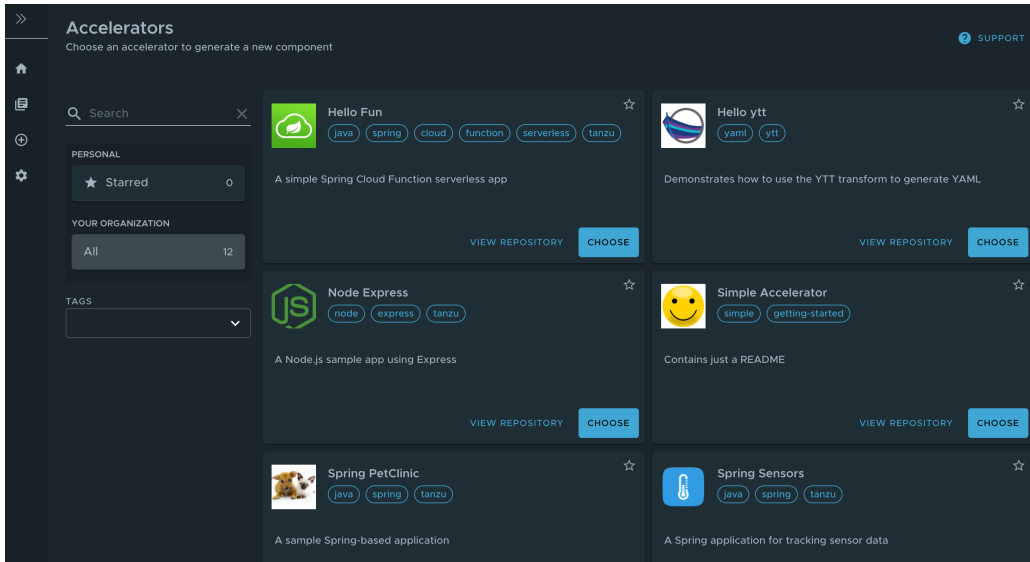

Alternatively, use the Tanzu CLI to create a separate manifest file and apply it to the cluster.

1. Create a `simple-manifest.yaml` file and add the following content, filling in with your Git repository and branch values.

```
apiVersion: accelerator.apps.tanzu.vmware.com/v1alpha1
kind: Accelerator
metadata:
  name: simple
  namespace: accelerator-system
spec:
  git:
    url: YOUR-GIT-REPOSITORY-URL
    ref:
      branch: YOUR-GIT-BRANCH
```

2. To apply the `simple-manifest.yaml`, run this command in your terminal in the directory where you created this file:

```
tanzu accelerator apply -f simple-manifest.yaml
```

Using accelerator fragments

Accelerator fragments are reusable accelerator components that can provide options, files, or transforms. They can be imported from accelerators using an `import` entry and the transforms from the fragment can be referenced in an `InvokeFragment` transform in the accelerator that is declaring the import. For additional details see [InvokeFragment transform](#).

The accelerator samples include three fragments - `java-version`, `tap-initialize`, and `live-update`. See [vmware-tanzu/application-accelerator-samples/fragments](#) Git repository for the content of these fragments.

To discover what fragments are available to use, run:

```
tanzu accelerator fragment list
```

Look at the `java-version` fragment as an example. It contains the following `accelerator.yaml` file:

```
accelerator:
  options:
    - name: javaVersion
      inputType: select
      label: Java version to use
      choices:
        - value: "1.8"
          text: Java 8
        - value: "11"
          text: Java 11
        - value: "17"
          text: Java 17
      defaultValue: "11"
      required: true

engine:
  merge:
    - include: [ "pom.xml" ]
      chain:
        - type: ReplaceText
          regex:
            pattern: "<java.version>.*<"
            with: "'<java.version>' + #javaVersion + '<'"
    - include: [ "build.gradle" ]
      chain:
        - type: ReplaceText
          regex:
            pattern: "sourceCompatibility = .*"
            with: "'sourceCompatibility = '" + #javaVersion + "'"
    - include: [ "config/workload.yaml" ]
      chain:
        - type: ReplaceText
          condition: "#javaVersion == '17'"
          substitutions:
            - text: "spec:"
              with: "'spec:\n  build:\n    env:\n      - name: BP_JVM_VERSION\n        valu
e: \"17\"'"
```

This fragment contributes the following to any accelerator that imports it:

1. An option named `javaVersion` with three choices `Java 8`, `Java 11`, and `Java 17`
2. Three `ReplaceText` transforms:
 - o If the accelerator has a `pom.xml` file, then what is specified for `<java.version>` is replaced with the chosen version.
 - o If the accelerator has a `build.gradle` file, then what is specified for `sourceCompatibility` is replaced with the chosen version.
 - o If the accelerator has a `config/workload.yaml` file, and the user selected “Java 17” then a build environment entry of `BP_JVM_VERSION` is inserted into the `spec:` section.

Deploying accelerator fragments

To deploy new fragments to the accelerator system, use the new `tanzu accelerator fragment create` CLI command or apply a custom resource manifest file with either `kubectl apply` or the

`tanzu accelerator apply` commands.

The resource manifest for the `java-version` fragment looks like this:

```
apiVersion: accelerator.apps.tanzu.vmware.com/v1alpha1
kind: Fragment
metadata:
  name: java-version
  namespace: accelerator-system
spec:
  displayName: Select Java Version
  git:
    ref:
      tag: GIT_TAG_VERSION
    url: https://github.com/vmware-tanzu/application-accelerator-samples.git
    subPath: fragments/java-version
```

Where `GIT-TAG-VERSION` is the Git tag of the `java-version` fragment. For example, `tap-1.4.0` is a valid Git tag for the `java-version` fragment.

To create the fragment, save the above manifest in a `java-version.yaml` file) and run:

```
tanzu accelerator apply -f ./java-version.yaml
```



Note

The `accelerator apply` command can be used to apply both Accelerator and Fragment resources.

To avoid having to create a separate manifest file, run:

```
tanzu accelerator fragment create java-version \
--git-repo https://github.com/vmware-tanzu/application-accelerator-samples.git \
--git-tag ${GIT_TAG_VERSION} \
--git-sub-path fragments/java-version
```

Where `GIT-TAG-VERSION` is the Git tag of the `java-version` fragment. For example, `tap-1.4.0` is a valid Git tag for the `java-version` fragment.

Now you can use this `java-version` fragment in an accelerator:

```
accelerator:
  displayName: Hello Fragment
  description: A sample app
  tags:
    - java
    - spring
    - cloud
    - tanzu

  imports:
    - name: java-version

engine:
  merge:
    - include: ["**/*.yml"]
    - type: InvokeFragment
      reference: java-version
```

The earlier accelerator imports the `java-version` which, as seen earlier, provides an option to select the Java version to use for the project. It then instructs the engine to run the transforms

provided in the fragment that updates the Java version used in `pom.xml` or `build.gradle` files from the accelerator.

For more detail on the use of fragments, see [InvokeFragment transform](#).

Next steps

Learn how to:

- Write an `accelerator.yaml`.
- Configure accelerators with [Accelerator Custom Resources](#).
- Manipulate files using [Transforms](#).
- Use [SpEL in the accelerator.yaml file](#).

Create accelerators

This topic tells you how to create an accelerator in Tanzu Developer Portal (formerly named Tanzu Application Platform GUI).

An accelerator contains your conforming code and configurations that developers can use to create new projects that by default follow the standards defined in your accelerators.

Prerequisites

The following prerequisites are required to create an accelerator:

- Application Accelerator is installed. For information about installing Application Accelerator, see [Installing Application Accelerator for VMware Tanzu](#).
- You can access Tanzu Developer Portal from a browser or use the Application Accelerator extension for VS Code.
 - For more information about Tanzu Developer Portal, see [Overview of Tanzu Developer Portal](#).
 - For more information about Application Accelerator extension for VS Code, see [Application Accelerator Visual Studio Code extension](#).
- `kubectl` is installed and authenticated with admin rights for your target cluster.

Getting started

You can use any Git repository to create an accelerator. You need the URL of the repository to create an accelerator.

For this example, the Git repository is `public` and contains a `README.md` file. These are options available when you create repositories on GitHub.

Use the following procedure to create an accelerator based on this Git repository:

1. Clone your Git repository.
2. Create a file named `accelerator.yaml` in the root directory of this Git repository.
3. Add the following content to the `accelerator.yaml` file:

```

accelerator:
  displayName: Simple Accelerator
  description: Contains just a README
  imageUrl: https://images.freecreatives.com/wp-content/uploads/2015/05/smiley-559124_640.jpg

```

```
tags:
- simple
- getting-started
```

Feel free to use a different icon if it uses a reachable URL.

4. Add the new `accelerator.yaml` file, commit this change and push to your Git repository.

Publishing the new accelerator

1. To publish your new accelerator, run:

```
tanzu accelerator create simple --git-repository ${GIT_REPOSITORY_URL} --git-branch ${GIT_REPOSITORY_BRANCH}
```

Where:

- `GIT-REPOSITORY-URL` is the URL for your Git repository where the accelerator is located.
 - `GIT-REPOSITORY-BRANCH` is the name of the branch where you pushed the new `accelerator.yaml` file.
2. Refresh Tanzu Developer Portal or the Application Accelerator extension in VS Code to reveal the newly published accelerator. It might take a few seconds to refresh the catalog and add an entry for your new accelerator.

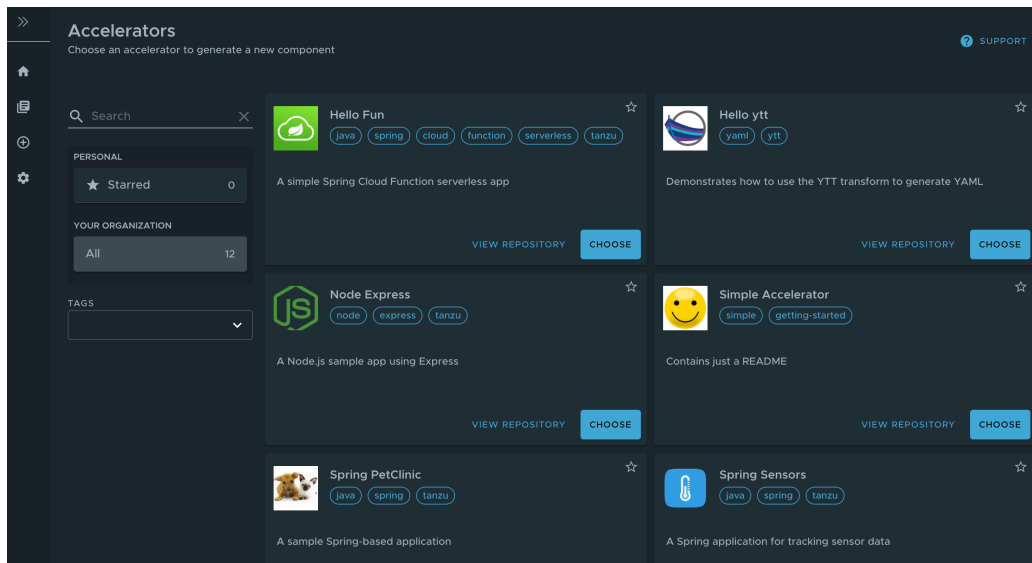

Alternatively, use the Tanzu CLI to create a separate manifest file and apply it to the cluster.

1. Create a `simple-manifest.yaml` file and add the following content, filling in with your Git repository and branch values.

```
apiVersion: accelerator.apps.tanzu.vmware.com/v1alpha1
kind: Accelerator
metadata:
  name: simple
  namespace: accelerator-system
spec:
  git:
    url: YOUR-GIT-REPOSITORY-URL
    ref:
      branch: YOUR-GIT-BRANCH
```

2. To apply the `simple-manifest.yaml`, run this command in your terminal in the directory where you created this file:

```
tanzu accelerator apply -f simple-manifest.yaml
```

Using accelerator fragments

Accelerator fragments are reusable accelerator components that can provide options, files, or transforms. They can be imported from accelerators using an `import` entry and the transforms from the fragment can be referenced in an `InvokeFragment` transform in the accelerator that is declaring the import. For additional details see [InvokeFragment transform](#).

The accelerator samples include three fragments - `java-version`, `tap-initialize`, and `live-update`. See [vmware-tanzu/application-accelerator-samples/fragments](#) Git repository for the content of these fragments.

To discover what fragments are available to use, run:

```
tanzu accelerator fragment list
```

Look at the `java-version` fragment as an example. It contains the following `accelerator.yaml` file:

```
accelerator:
  options:
    - name: javaVersion
      inputType: select
      label: Java version to use
      choices:
        - value: "1.8"
          text: Java 8
        - value: "11"
          text: Java 11
        - value: "17"
          text: Java 17
      defaultValue: "11"
      required: true

engine:
  merge:
    - include: [ "pom.xml" ]
      chain:
        - type: ReplaceText
          regex:
            pattern: "<java.version>.*<"
            with: "'<java.version>' + #javaVersion + '<'"
    - include: [ "build.gradle" ]
      chain:
        - type: ReplaceText
          regex:
            pattern: "sourceCompatibility = .*"
            with: "'sourceCompatibility = '" + #javaVersion + "'"
    - include: [ "config/workload.yaml" ]
      chain:
        - type: ReplaceText
          condition: "#javaVersion == '17'"
          substitutions:
            - text: "spec:"
              with: "'spec:\n build:\n env:\n - name: BP_JVM_VERSION\n valu
e: \"17\"'"
```

This fragment contributes the following to any accelerator that imports it:

1. An option named `javaVersion` with three choices `Java 8`, `Java 11`, and `Java 17`
2. Three `ReplaceText` transforms:
 - If the accelerator has a `pom.xml` file, then what is specified for `<java.version>` is replaced with the chosen version.
 - If the accelerator has a `build.gradle` file, then what is specified for `sourceCompatibility` is replaced with the chosen version.
 - If the accelerator has a `config/workload.yaml` file, and the user selected “Java 17” then a build environment entry of `BP_JVM_VERSION` is inserted into the `spec:` section.

Deploying accelerator fragments

To deploy new fragments to the accelerator system, use the new `tanzu accelerator fragment create` CLI command or apply a custom resource manifest file with either `kubectl apply` or the `tanzu accelerator apply` commands.

The resource manifest for the `java-version` fragment looks like this:

```
apiVersion: accelerator.apps.tanzu.vmware.com/v1alpha1
kind: Fragment
metadata:
  name: java-version
  namespace: accelerator-system
spec:
  displayName: Select Java Version
  git:
    ref:
      tag: GIT_TAG_VERSION
    url: https://github.com/vmware-tanzu/application-accelerator-samples.git
    subPath: fragments/java-version
```

Where `GIT-TAG-VERSION` is the Git tag of the `java-version` fragment. For example, `tap-1.4.0` is a valid Git tag for the `java-version` fragment.

To create the fragment, save the above manifest in a `java-version.yaml` file) and run:

```
tanzu accelerator apply -f ./java-version.yaml
```



Note

The `accelerator apply` command can be used to apply both Accelerator and Fragment resources.

To avoid having to create a separate manifest file, run:

```
tanzu accelerator fragment create java-version \
  --git-repo https://github.com/vmware-tanzu/application-accelerator-samples.git \
  --git-tag ${GIT_TAG_VERSION} \
  --git-sub-path fragments/java-version
```

Where `GIT-TAG-VERSION` is the Git tag of the `java-version` fragment. For example, `tap-1.4.0` is a valid Git tag for the `java-version` fragment.

Now you can use this `java-version` fragment in an accelerator:

```

accelerator:
  displayName: Hello Fragment
  description: A sample app
  tags:
  - java
  - spring
  - cloud
  - tanzu

  imports:
  - name: java-version

engine:
  merge:
  - include: ["**/*"]
  - type: InvokeFragment
    reference: java-version

```

The earlier accelerator imports the `java-version` which, as seen earlier, provides an option to select the Java version to use for the project. It then instructs the engine to run the transforms provided in the fragment that updates the Java version used in `pom.xml` or `build.gradle` files from the accelerator.

For more detail on the use of fragments, see [InvokeFragment transform](#).

Next steps

Learn how to:

- Write an [accelerator.yaml](#).
- Configure accelerators with [Accelerator Custom Resources](#).
- Manipulate files using [Transforms](#).
- Use [SpEL in the accelerator.yaml file](#).

Create an accelerator.yaml file in Application Accelerator

This topic tells you how to use Application Accelerator to create an `accelerator.yaml` file in Tanzu Application Platform (commonly known as TAP).

By including an `accelerator.yaml` file in your Accelerator repository, you can declare input options that users fill in using a form in the UI. Those option values control processing by the template engine before it returns the zipped output files. For more information, see the [Sample accelerator](#).

When there is no `accelerator.yaml`, the repository still works as an accelerator but the files are passed unmodified to users.

`accelerator.yaml` has two top-level sections: `accelerator` and `engine`.

Accelerator

This section documents how an accelerator is presented to users in the web UI. For example:

```

accelerator:
  displayName: Hello Fun
  description: A simple Spring Cloud Function serverless app
  iconUrl: https://raw.githubusercontent.com/vmware-tanzu/application-accelerator-samp
les/main/icons/icon-cloud.png
  tags:
  - java

```

```

- spring

options:
- name: deploymentType
  inputType: select
  choices:
  - value: none
    text: Skip Kubernetes deployment
  - value: k8s-simple
    text: Kubernetes deployment and service
  - value: knative
    text: Knative service
  defaultValue: k8s-simple
  required: true

```

Accelerator metadata

These properties are in accelerator listings such as the web UI:

- **displayName:** A human-readable name.
- **description:** A more detailed description.
- **iconUrl:** A URL pointing to an icon image.
- **tags:** A list of tags used to filter accelerators.

Accelerator options

The list of options is passed to the UI to create input text boxes for each option.

The following option properties are used by both the UI and the engine.

- **name:** Each option must have a unique, camelCase name. The option value entered by a user is made available as a [SPeL](#) variable name. For example, `#deploymentType`.

You can specify your own default name by including:

```

options:
- name: projectName
  label: Name
  inputType: text
  defaultValue: myname
  required: true

```

- **dataType:** Data types that work with the UI are:
 - `string`
 - `boolean`
 - `number`
 - Custom types defined in the accelerator `types` section
 - Arrays of these such as `[string]`, `[number]`, and so on.

Most input types return a string, which is the default. Use Boolean values with `checkbox`.

- **defaultValue:** This literal value pre-populates the option. Ensure that its type matches the `dataType`. For example, use `["text 1", "text 2"]` for the `dataType` `[string]`. Options without a `defaultValue` can trigger a processing error if the user doesn't provide a value for that option.
- **validationRegex:** When present, a regex validates the string representation of the option value *when set*. It doesn't apply when the value is blank. As a consequence, don't use the

regex to enforce prerequisites. See **required** for that purpose.

This regex is used in several layers in Application Accelerator, built using several technologies, for example, JavaScript and Java. So refrain from using “exotic” regex features. Also, the regex applies to portions of the value by default. That is, `[a-z]+` matches `Hello world` despite the capital `H`. To apply it to the whole value (or just start/end), anchor it using `^` and `$`.

Finally, backslashes in a YAML string using double quotes must be escaped, so to match a number, write `validationRegex: "\\d+"` or use another string style.

The following option properties are for UI purposes only.

- **label:** A human-readable version of the `name` identifying the option.
- **description:** A tooltip to accompany the input.
- **inputType:**
 - `text`: The default input type.
 - `textarea`: Single text value with larger input allowing line breaks.
 - `checkbox`: Ideal for Boolean values or multi-value selection from choices.
 - `select`: Single-value selection from choices using a drop-down menu.
 - `radio`: Alternative single-value selection from choices using buttons.
- **choices:** This is a list of predefined choices. Users can select from the list in the UI. Choices are supported by `checkbox`, `select`, and `radio`. Each choice must have a `text` property for the displayed text, and a `value` property for the value that the form returns for that choice. The list is presented in the UI in the same order as it is declared in `accelerator.yaml`.
- **required:** `true` forces users to enter a value in the UI.
- **dependsOn:** This is a way to control visibility by specifying the `name` and optional `value` of another input option. When the other option has a value exactly equal to `value`, or `true` if no `value` is specified, then the option with `dependsOn` is visible. Otherwise, it is hidden. Ensure that the value matches the `dataType` of the `dependsOn` option. For example, a multi-value option (`dataType = [string]`) such as a `checkbox` uses `[matched-value]` to trigger another option when `matched-value` (and only `matched-value`) is selected. See the following section for more information about `dependsOn`.

DependsOn and multi-value dataType

`dependsOn` tests for strict equality, even for multi-valued options. This means that a multi-valued option must not be used to trigger several other options unfolding, one for each value. Instead, use several single-valued options:

Instead of

```
options:
- name: toppings
  dataType: [string]
  inputType: checkbox
  choices:
  - value: vegetables
    text: Vegetables
  - value: meat
    text: Meat
  ...
- name: vegType
  dependsOn:
    name: toppings
```

```

    value: [vegetables] # or vegetables, this won't do what you want either
  - name: meatType
    dependsOn:
      name: toppings
      value: [meat]
  ...

```

do this:

```

options:
  - name: useVeggies
    dataType: boolean
    inputType: checkbox
    label: Vegetables
  - name: useMeat
    dataType: boolean
    inputType: checkbox
    label: Meat
  - name: vegType
    dependsOn:
      name: useVeggies
      value: true
  - name: meatType
    dependsOn:
      name: useMeat
      value: true
  ...

```

Examples

The later screenshot and [accelerator.yaml](#) file snippet that follows demonstrates each `inputType`. You can also see the GitHub sample [demo-input-types](#).

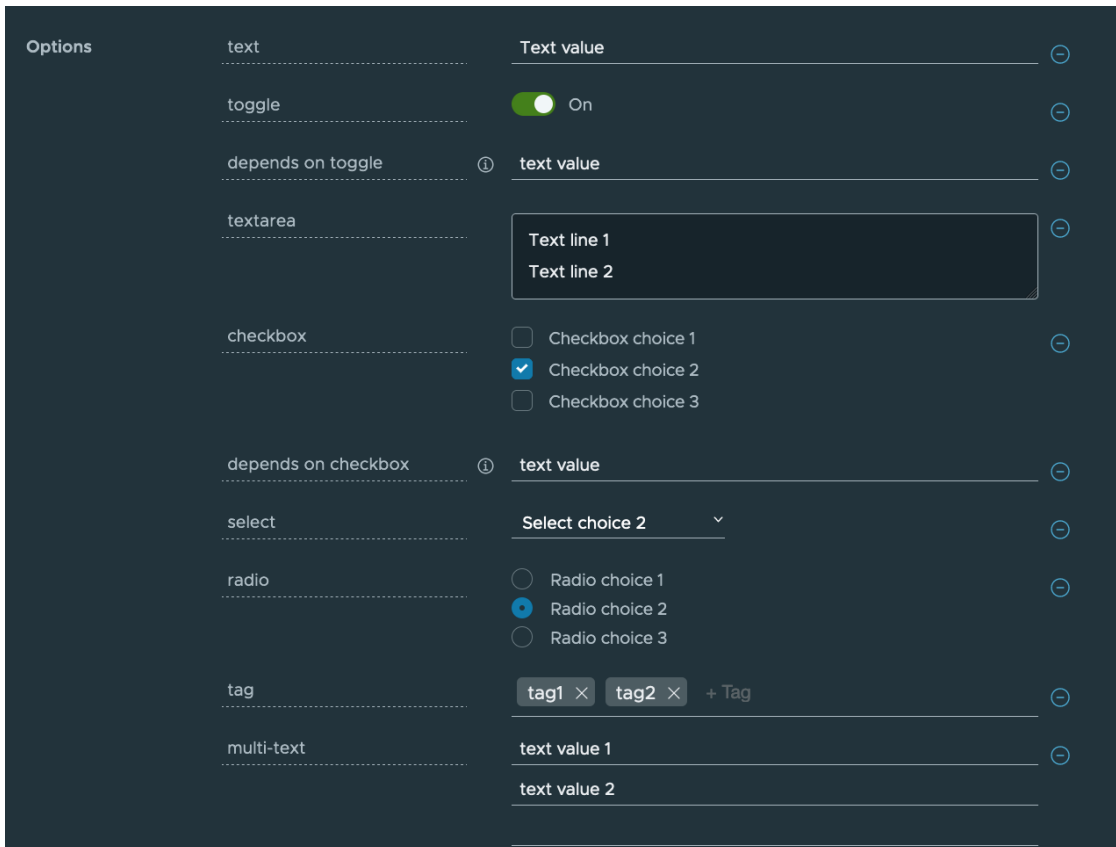

```

accelerator:
  displayName: Demo Input Types
  description: "Accelerator with options for each inputType"
  iconUrl: https://raw.githubusercontent.com/vmware-tanzu/application-accelerator-samples/main/icons/icon-cloud.png
  tags: ["demo", "options"]

options:

- name: text
  display: true
  defaultValue: Text value

- name: toggle
  display: true
  dataType: boolean
  defaultValue: true

- name: dependsOnToggle
  label: 'depends on toggle'
  description: Visibility depends on the value of the toggle option being true.
  dependsOn:
    name: toggle
  defaultValue: text value

- name: textarea
  inputType: textarea
  display: true
  defaultValue: |
    Text line 1
    Text line 2

- name: checkbox
  inputType: checkbox
  display: true
  dataType: [string]
  defaultValue:
    - value-2
  choices:
    - text: Checkbox choice 1
      value: value-1
    - text: Checkbox choice 2
      value: value-2
    - text: Checkbox choice 3
      value: value-3

- name: dependsOnCheckbox
  label: 'depends on checkbox'
  description: Visibility depends on the checkbox option containing exactly value value-2.
  dependsOn:
    name: checkbox
    value: [value-2]
  defaultValue: text value

- name: select
  inputType: select
  display: true
  defaultValue: value-2
  choices:
    - text: Select choice 1
      value: value-1
    - text: Select choice 2
      value: value-2
    - text: Select choice 3
      value: value-3

```

```

- name: radio
  inputType: radio
  display: true
  defaultValue: value-2
  choices:
    - text: Radio choice 1
      value: value-1
    - text: Radio choice 2
      value: value-2
    - text: Radio choice 3
      value: value-3

engine:
  type: YTT

```

Engine

The engine section describes how to take the files from the accelerator root directory and transform them into the contents of a generated project file.

The YAML notation here defines what is called a transform. A transform is a function on a set of files. It uses a set of files as input. It produces a modified set of files as output derived from this input.

Different types of transforms do different tasks:

- Filtering the set of files: that is, removing, or keeping files that match certain criteria.
- Changing the contents of files. For example, replacing some strings in the files.
- Renaming or moving files: that is, changing the paths of the files.

The notation also provides the composition operators `merge` and `chain`, which enable you to create more complex transforms by composing simpler transforms together.

The following is an example of what is possible. To learn the notation, see [Introduction to transforms](#).

Engine example

```

engine:
  include:
    ["**/*.md", "**/*.xml", "**/*.gradle", "**/*.java"]
  exclude:
    ["**/secret/**"]
  let:
    - name: includePoms
      expression:
        "#buildType == 'Maven'"
    - name: includeGradle
      expression: "#buildType == 'Gradle'"
  merge:
    - condition:
        "#includeGradle"
      include: ["*.gradle"]
    - condition: "#includePoms"
      include: ["pom.xml"]
    - include: ["**/*.java", "README.md"]
  chain:
    - type: ReplaceText
      substitutions:
        - text: "Hello World!"
          with: "#greeting"

```



```

chain:
  - type: RewritePath
    regex: (.*)simpleboot(.*)
    rewriteTo: "#g1 + #packageName + #g2"
  - type: ReplaceText
    substitutions:
      - text: simpleboot
        with: "#packageName"
onConflict:
  Fail

```

Engine notation descriptions

This section describes the notations in the preceding example.

`engine` is the global transformation node. It produces the final set of files to be zipped and returned from the accelerator. As input, it receives all the files from the accelerator repository root. The properties in this node dictate how this set of files is transformed into a final set of files zipped as the accelerator result.

`engine.include` filters the set of files, retaining only those matching a list of path patterns. This ensures that the accelerator only detects files in the repository that match the list of patterns.

`engine.exclude` further restricts which files are detected. The example ensures files in any directory called `secret` are never detected.

`engine.let` defines additional variables and assigns them values. These derived symbols function such as options, but instead of being supplied from a UI widget, they are computed by the accelerator itself.

`engine.merge` executes each of its children in parallel. Each child receives a copy of the current set of input files. These are files remaining after applying the `include` and `exclude` filters. Each of the children therefore produces a set of files. All the files from all the children are then combined, as if overlaid on top of each other in the same directory. If more than one child produces a file with the same path, the transform resolves the conflict by dropping the file contents from the earlier child and keeping the contents from the later child.

`engine.merge.chain` specifies additional transformations to apply to the set of files produced by this child. In the example, `ReplaceText` is only applied to Java files and `README.md`.

`engine.chain` applies transformation to all files globally. The chain has a list of child transformations. These transformations are applied after everything else in the same node. This is the global node. The children in a chain are applied sequentially.

`engine.onConflict` specifies how conflict is handled when an operation, such as merging, produces multiple files at the same path: - `Fail` raises an error when there is a conflict. - `UseFirst` keeps the contents of the first file. - `UseLast` keeps the contents of the last file. - `Append` keeps both by using `cat <first-file> <second-file>`.

Advanced accelerator use

Additional advanced features can be leveraged when writing an `accelerator.yaml`. For more information see, [Creating dynamic parameters using custom types](#)

Application Accelerator sample accelerator.yaml file

This topic provides you with a sample accelerator file to get you started writing your own accelerators in Tanzu Application Platform (commonly known as TAP).

```

accelerator:
  # The `accelerator` section serves to document how an accelerator is presented to th

```

```

e
# user in the accelerator web UI.

# displayName: a descriptive human-readable name. Make this short so as to look nice
#           in a list of many accelerators shown to a user.
displayName: Hello Spring Boot

# description: a more detailed description that a user can see if they took a closer
#           look at a particular accelerator.
description: Simple Hello World Rest Service based on Spring Boot

# imageUrl: Optional, a nice colorful, icon for your accelerator to make it stand out
visually.
imageUrl: https://raw.githubusercontent.com/vmware-tanzu/application-accelerator-samp
les/main/icons/icon-cloud.png

# tags: A list of classification tags. The UI allows users to search for accelerator
s based on tags
tags:
  - Java
  - Spring
  - Function

# options are parameters that can affect how the accelerator behaves.
# The purpose of the options section is
# - to list all applicable options
# - describe each option in enough detail so that the UI can create
#   a suitable input widget for it.
options: # a list of options
  # a first option
  - name:
      greeting
      # name: each option must have a name.
      # This must be
      # - camelCase
      # - unique (i.e. no two options can have the same name)
      # This is like a variable used by the accelerator to refer to
      # and use the value during its execution.
      # This name is internal to your accelerator and is not shown to
      # the user.
    label:
      Greeting Message
      # A human readable version of the `name`. This is used to identify an
      # option to the user in the UI.
      # This should be short (so as not to look ugly in a ui with limited
      # space available for labeling the input widgets).
      # There are no limits on what characters can be used in the label (so spaces
      # are allowed).
    description:
      Greeting message displayed by the Hello World app.
      # An optional more detailed description / explanation that can be shown to
      # to the user in the UI when the short label alone might not be enough to unde
rstand
      # its purpose.
    dataType:
      string
      # type of data the accelerator expects during execution (this is
      # like the type of the 'variable'.
      # possible dataTypes are string, boolean, number or [string] (the latter meani
ng a
      # list of strings
    inputType:
      text
      # Related to the dataType but somewhat independent, this identifies the type
      # of widget shown in the ui. Available types are:
      # - text - the default

```

```

    # - toggle (boolean on/off control)
    # - textarea (single text value with larger input that allows linebreaks)
    # - checkbox - multivalue selection from choices
    # - select - single value selection from choices
    # - radio - alternative single value selection from choices
    # - tag - multivalue input ui for entering single-word tags
    required: true
    defaultValue: Hello Accelerator
# second option:
- name: packageName
  label: "Package Name"
  description: Name of Java package
  dataType: string
  inputType: text
  defaultValue: somepackage
# another option:
- name: buildType
  label: Build Type
  description: Choose whether to use Maven or Gradle to build the project.
  dataType: string
  inputType: select
  choices:
    - value: Maven
      text: Maven (pom.xml)
    - value: Gradle
      text: Gradle (build.gradle)

# The 'engine' section describes how to take the files from the accelerator
# repo root folder and 'transform' them into the contents of a generated project / zip.
# transformation operate on the files as a set and can do things like:
# - filtering the set of files (i.e. removing / keeping only files that match certain
# criteria)
# - changing the contents of a file (e.g. replacing some strings in them)
# - renaming or moving files (changing the paths of the files)
engine:
# this is the 'global' transformation node. It produces the final set of
# files to be zipped and returned from the accelerator.
# As input it receives all the files from the accelerator repo root.

# The properties in this node dictate how this set of files is
# transformed into a final set of files to zip up as the accelerator
# result.

include:
  ["**/*.md", "**/*.xml", "**/*.gradle", "**/*.java"]
# This globally defined `include` filters the set of files
# retaining only those matching a given list of path patterns.
# This can ensure that only files in the repo matching the list of
# patterns will be seen / considered by the accelerator.

exclude:
  ["**/secret/**"]
# This globally defined `exclude` further restricts what files are considered.
# This example ensures files in any directory called `secret` are never considered.

# Under 'let' you can define additional variables and assign them values
# These 'derived symbols' function much like options, but instead of
# being supplied from a UI widget, they are computed by the accelerator itself.
let:
  - name: includePoms # name of a symbol, must be camelCase
    expression:
      "#buildType == 'Maven'" # <- SpEL expression given as a string. You must take
      care to use
      # proper quotes to avoid yaml treating '#' as starting a comment.

```

```

- name: includeGradle
  expression: "#buildType == 'Gradle'"
merge: # This merge section executes each of its children 'in parallel'.
  # Each child receives a copy of the current set of input files.
  # (i.e. the files that are remaining after considering the `include` and `exclude`
  # Each of the children thus produces a set of files.
  # Merge then combines all the files from all the children, as if by overlaying the
  # on top of each other
  # in the same directory. If more than one child produces a file with the same path,
  # this 'conflict' is resolved by dropping the file contents from the earlier child
  # and keeping only the later one.
  # merge child 1: this child node wants to contribute 'gradle' files to the final result
- condition:
  "#includeGradle" # this child is deactivated if the Gradle option was not selected by the user
  # A deactivated child doesn't contribute anything to the final result.
  include: ["*.gradle"] # this child only focusses on gradle files (ignoring all other files)
  # merge child 2: this child wants to contribute 'pom' files to the final result
- condition: "#includePoms"
  include: ["pom.xml"]
  # merge child 3: this child wants to contribute Java code and README.md to the final result
- include: ["**/*.java", "README.md"]
  # Using: chain you can specify additional transformations to be applied to the set
  # of files produced by this child (i.e. the `ReplaceText` below is only applied to .java files and README.md)
  chain:
    - type: ReplaceText
      substitutions:
        - text: "Hello World!"
          with: "#greeting"
  chain:
    # Globally specified chain, works like the one `from merge child 3`. But because it is global, it
    # applies transformation to all files globally.
    #
    # The chain has a list of child transformations. These transformation are applied after everything else
    # in the same node (here we are in the 'global node').
    #
    # The children in a chain are applied sequentially.
    - type: RewritePath
      regex: (.*)simpleboot(.*)
      rewriteTo: "#g1 + #packageName + #g2" # SpEL expression. You can use '#g1' and '#g2' to reference 'match groups'
    - type: ReplaceText
      substitutions:
        - text: simpleboot
          with: "#packageName"
onConflict:
  Fail # other values are `UseFirst`, `UseLast`, or `Append`
  # when merging (or really any operation) produces multiple files at the same path
  # this defines how that conflict is handled.
  # Fail: raise an error when conflict happens
  # UseFirst: keep the contents of the first file
  # UseLast: keep the contents of the last file
  # Append: keep both as by using `cat <first-file> <second-file>`.

```

Use transforms in Application Accelerator

This topic tells you about using transforms with Application Accelerator.

When the accelerator engine executes the accelerator, it produces a ZIP file containing a set of files. The purpose of the `engine` section is to describe precisely how the contents of that ZIP file is created.

```
accelerator:
  ...
engine:
  <transform-definition>
```

Why transforms?

When you run an accelerator, the contents of the accelerator produce the result. It is made up of subsets of the files taken from the accelerator `<root>` directory and its subdirectories. You can copy the files as is, or transform them in a number of ways before adding them to the result.

The YAML notation in the `engine` section defines a transformation that takes as input a set of files (in the `<root>` directory of the accelerator) and produces as output another set of files, which are put into the ZIP file.

Every transform has a `type`. Different types of transform have different behaviors and different YAML properties that control precisely what they do.

In the following example, a transform of type `Include` is a filter. It takes as input a set of files and produces as output a subset of those files, retaining only those files whose path matches any one of a list of `patterns`.

If the accelerator has something like this:

```
engine:
  type: Include
  patterns: ['**/*.java']
```

This accelerator produces a ZIP file containing all the `.java` files from the accelerator `<root>` or its subdirectories but nothing else.

Transforms can also operate on the contents of a file, instead of merely selecting it for inclusion.

For example:

```
type: ReplaceText
substitutions:
- text: hello-fun
  with: "#artifactId"
```

This transform looks for all instances of a string `hello-fun` in all its input files and replaces them with an `artifactId`, which is the result of evaluating a SpEL expression.

Combining transforms

From the preceding examples, you can see that transforms such as `ReplaceText` and `Include` are too primitive to be useful by themselves. They are meant to be the building blocks of more complex accelerators.

To combine transforms, provide two operators called `Chain` and `Merge`. These operators are recursive in the sense that they compose a number of child transforms to create a more complex transform. This allows building arbitrarily deep and complex trees of nested transform definitions.

The following example shows what each of these two operators does and how they are used together.

Chain

Because transforms are functions whose input and output are of the same type (a set of files), you can take the output of one function and feed it as input to another. This is what `Chain` does. In mathematical terms, `Chain` is function composition.

You might, for example, want to do this with the `ReplaceText` transform. Used by itself, it replaces text strings in all the accelerator input files. What if you wanted to apply this replacement to only a subset of the files? You can use an `Include` filter to select only a subset of files of interest and chain that subset into `ReplaceText`.

For example:

```
type: Chain
transformations:
- type: Include
  patterns: ['**/pom.xml']
- type: ReplaceText
  substitutions:
  - text: hello-fun
    with: "#artifactId"
```

Merge

Chaining `Include` into `ReplaceText` limits the scope of `ReplaceText` to a subset of the input files. It also eliminates all other files from the result.

For example:

```
engine:
  type: Chain
  transformations:
  - type: Include
    patterns: ['**/pom.xml']
  - type: ReplaceText
    substitutions:
    - text: hello-fun
      with: "#artifactId"
```

The preceding accelerator produces a ZIP file that only contains `pom.xml` files and nothing else.

What if you also wanted other files in that ZIP? Perhaps you want to include some Java files as well, but don't want to apply the same text replacement to them.

You might be tempted to write something such as:

```
engine:
  type: Chain
  transformations:
  - type: Include
    patterns: ['**/pom.xml']
  - type: ReplaceText
    ...
  - type: Include
    patterns: ['**/*.java']
```

However, that doesn't work. If you chain non-overlapping includes together like this, the result is an empty result set. The reason is that the first include retains only `pom.xml` files. These files are fed

to the next transform in the chain. The second include only retains `.java` files, but because there are only `pom.xml` files left in the input, the result is an empty set.

This is where `Merge` comes in. A `Merge` takes the outputs of several transforms executed independently on the same input sourceset and combines or merges them together into a single sourceset.

For example:

```
engine:
  type: Merge
  sources:
  - type: Chain
    - type: Include
      patterns: ['**/pom.xml']
    - type: ReplaceText
      ...
  - type: Include
    patterns: ['**/*.java']
```

The preceding accelerator produces a result that includes both:

- The `pom.xml` files with some text replacements applied to them.
- Verbatim copies of all the `.java` files.

Shortened notation

It becomes cumbersome and verbose to combine transforms such as `Include`, `Exclude`, and `ReplaceText` with explicit `Chain` and `Merge` operators. Also, there is a common composition pattern to using them. Specifically, select an interesting subset using includes and excludes, apply a chain of additional transformations to the subset, and merge the result with the results of other transforms. That is why there is a transform known the `Combo` transform that combines `Include`, `Exclude`, `Merge`, and `Chain`.

For example:

```
type: Combo
include: ['**/*.txt', '**/*.md']
exclude: ['**/secret/**']
merge:
- <transform-definition>
- ...
chain:
- <transform-definition>
- ...
```

Each of the properties in this `Combo` transform is optional if you specify at least one.

Notice how each of the properties `include`, `exclude`, `merge`, and `chain` corresponds to the name of a type of transform, only spelled with lowercase letters.

If you specify only one of the properties, the `Combo` transform behaves exactly as if you used that type of transformation by itself.

For example:

```
merge: ...
```

Behaves the same as:

```
type: Merge
```

```
sources: ...
```

When you do specify multiple properties at the same time, the `Combo` transform composes them together and combines `Merge` and `Chain`.

For example:

```
include: ['**/*.txt', '**.md']
chain:
- type: ReplaceText
  ...
```

Is the same as:

```
type: Chain
transformations:
- type: Include
  patterns: ['**/*.txt', '**.md']
- type: Chain
  transformations:
  - type: ReplaceText
    ...
```

When you use all of the properties of `Combo` at once:

```
include: I
exclude: E
merge:
- S1
- S2
chain:
- T1
- T2
```

This is equivalent to:

```
type: Chain
transformations:
- type: Include
  patterns: I
- type: Exclude
  patterns: E
- type: Merge
  sources:
  - S1
  - S2
- T1
- T2
```

A Combo of one?

You can use the `Combo` as a convenient shorthand for a single type of annotation. However, though you can use it to combine multiple types, and though that is its main purpose, that doesn't mean you have to.

For example:

```
include: ["**/*.java"]
```

This is a `Combo` transform (remember, `type: Combo` is optional), but rather than combining multiple types of transforms, it only defines the `include` property. This makes it behave exactly as an `Include` transform:

```
type: Include
patterns: ["**/*.java"]
```

It is usually more convenient to use a **Combo** transform to denote a single **Include**, **Exclude**, **Chain**, or **Merge** transform, because it is slightly shorter to write it as a **Combo** than writing it with an explicit `type: property`.

A common pattern with merge transforms

It is a common and useful pattern to use merges with overlapping contents to apply a transformation to a subset of files and then replace these changed files within a bigger context.

For example:

```
engine:
  merge:
    - include: ["**/*"]
    - include: ["**/pom.xml"]
    chain:
      - type: ReplaceText
        substitutions: ...
```

The preceding accelerator copies all files from accelerator `<root>` while applying some text replacements only to `pom.xml` files. Other files are copied verbatim.

Here in more detail is how this works:

- **Transform A** is applied to the files from accelerator `<root>`. It selects all files, including `pom.xml` files.
- **Transform B** is *also* applied to the files from accelerator `<root>`. Again, **Merge** passes the same input independently to each of its child transforms. Transform B selects `pom.xml` files and replaces some text in them.

So both **Transform A** and **Transform B** output `pom.xml` files. The fact that both result sets contain the same file, and with different contents in them in this case, is a conflict that has to be resolved. By default, **Combo** follows a simple rule to resolve such conflicts: take the contents from the last child. Essentially, it behaves as if you overlaid both result sets one after another into the same location. The contents of the latter overwrite any previous files placed there by the earlier.

In the preceding example, this means that while both **Transform A** and **Transform B** produce contents for `pom.xml`, the contents from **Transform B** “wins.” So you get the version of the `pom.xml` that has text replacements applied to it rather than the verbatim copy from **Transform A**.

Conditional transforms

Every `<transform-definition>` can have a `condition` attribute.

```
- condition: "#k8sConfig == 'k8s-resource-simple'"
  include: [ "kubernetes/app/*.yaml" ]
  chain:
    - type: ReplaceText
      substitutions:
        - text: hello-fun
          with: "#artifactId"
```

When a transform’s condition is `false`, that transform is deactivated. This means it is replaced by a transform that does nothing. However, doing nothing can have different meanings depending on the context:

- When in the context of a **Merge**, a deactivated transform behaves like something that returns an empty set. A **Merge** adds things together using a kind of union; adding an empty set to union essentially does nothing.
- When in the context of a **Chain** however, a deactivated transform behaves like the **identity** function instead (that is, `lambda (x) => x`). When you chain functions together, a value is passed through all functions in succession. So each function in the chain has the chance to do something by returning a different modified value. If you are a function in a chain, to do nothing means to return the input you received unchanged as your output.

If a transform is deactivated in the context of your accelerator definition, it evaluates to false and is ignored. Your accelerator behaves as if you deleted or commented out that transform's YAML text from the accelerator definition file.

The following examples illustrate both cases.

Conditional 'Merge' transform

This example, **transform A**, has a conditional transform in a **Merge** context:

```
merge:
- condition: "#k8sConfig == 'k8s-resource-simple'"
  include: [ "kubernetes/app/*.yaml" ]
  chain:
  ...
- include: [ "pom.xml" ]
  chain:
  ...
```

If the condition of **transform A** is **false**, it is replaced with an empty set because it is used in a **Merge** context. This has the same effect as if the whole of **transform A** was deleted or commented out:

```
merge:
- include: [ "pom.xml" ]
  chain:
  ...
```

In this example, if the condition is **false**, only `pom.xml` file is in the result.

Conditional 'Chain' transform

In the following example, some conditional transforms are used in a **Chain** context:

```
merge:
- include: [ '**/*.json' ]
  chain:
- type: ReplaceText
  condition: '#customizeJson'
  substitutions: ...
- type: JsonPrettyPrint
  condition: '#prettyJson'
  indent: '#jsonIndent'
```

In the preceding example, both **transform A** and **transform B** are conditional and used in a **Chain** context. **Transform A** is chained after the `include` transform. Whereas **transform B** is chained after **transform A**. When either of these conditions is **false**, the corresponding transform behaves like the identity function. Namely, whatever set of files it receives as input is exactly what it returns as output.

For example, if **transform A**'s condition is `false`, it behaves as if **transform A** isn't there.

Transform A is chained after `include` so it receives the `include`'s result, returns it unchanged, and this is passed to **transform B**. In other words, the result of the `include` is passed as is to **transform B**.

A small gotcha with using conditionals in merge transforms

As mentioned earlier, it is a useful pattern to use merges with overlapping contents. But you must be careful using this in combination with conditional transforms.

For example:

```
engine:
  merge:
    - include: ["**/*"]
    - include: ["**/pom.xml"]
  chain:
    - type: ReplaceText
      substitutions: ...
```

If you only want to include pom files, if you select a `useMaven` option, when you add a 'condition' to **transform B** to deactivate it, the final result still contains `pom.xml` files.:

```
engine:
  merge:
    - include: "**/*"
    - condition: '#useMaven'
      include: ["**/pom.xml"]
  chain:
    - type: ReplaceText
      substitutions: ...
```

This is because if a transform is deactivated in the context of your accelerator definition, it evaluates to false and is ignored. So when `#useMaven` is `false`, the example reduces to:

```
engine:
  merge:
    - include: ["**/*"]
```

This accelerator copies all files from accelerator `<root>`, including `pom.xml`.

There are several ways to avoid this. One is to ensure the `pom.xml` files are not included in **transform A** by explicitly excluding them:

```
...
- include: ["**/*"]
  exclude: ["**/pom.xml"]
...
```

Another way is to apply the exclusion of `pom.xml` conditionally in a `Chain` after the main transform:

```
engine:
  merge:
    - include: ["**/*"]
    - include: ["**/pom.xml"]
  chain:
    - type: ReplaceText
      substitutions: ...
  chain:
    - condition: '!#useMaven'
      exclude: ['**/pom.xml']
```

Merge conflict

The representation of the set of files upon which transforms operate is richer than what you can physically store on a file system. A key difference is that in this case, the set of files allows for multiple files with the same path to exist at the same time. When files are initially read from a physical file system, or a ZIP file, this situation does not arise. However, as transforms are applied to this input, it can produce results that have more than one file with the same path and yet different contents.

Earlier examples illustrated this happening through a `merge` operation. For example:

```
merge:
- include: ["**/*"]
- include: ["**/pom.xml"]
  chain:
  - type: ReplaceText
    substitutions: ...
```

The result of the preceding `merge` is two files with path `pom.xml`, assuming there was a `pom.xml` file in the input. **Transform A** produces a `pom.xml` that is a verbatim copy of the input file. **Transform B** produces a modified copy with some text replaced in it.

It is impossible to have two files on a disk with the same path. Therefore, this conflict must be resolved before you can write the result to disk or pack it into a ZIP file.

As the example shows, merges are likely to give rise to these conflicts, so you might call this a “merge conflict.” However, such conflicts can also arise from other operations. For example,

`RewritePath`:

```
type: RewritePath
regex: '.*.md'
rewriteTo: "'docs/README.md'"
```

This example renames any `.md` file to `docs/README.md`. Assuming the input contains more than one `.md` file, the output contains multiple files with path `docs/README.md`. Again, this is a conflict, because there can only be one such file in a physical file system or ZIP file.

Resolving merge conflicts

By default, when a conflict arises, the engine doesn't do anything with it. Our internal representation for a set of files allows for multiple files with the same path. The engine carries on manipulating the files as is. This isn't a problem until the files must be written to disk or a ZIP file. If a conflict is still present at that time, an error is raised.

If your accelerator produces such conflicts, they must be resolved before writing files to disk. VMware provides the `UniquePath` transform. This transform allows you to specify what to do when more than one file has the same path. For example:

```
chain:
- type: RewritePath
  regex: '.*.md'
  rewriteTo: "'docs/README.md'"
- type: UniquePath
  strategy: Append
```

The result of the above transform is that all `.md` files are gathered up and concatenated into a single file at path `docs/README.md`. Another possible resolution strategy is to keep only the contents of one of the files. See [Conflict Resolution](#).

Combo transform includes some convenient built-in support for conflict resolution. It automatically selects the `UseLast` strategy if none is explicitly supplied. You rarely, if ever, need to specify a conflict resolution strategy.

File ordering

As mentioned earlier, our set of files representation is richer than the files on a typical file system in that it allows for multiple files with the same path. Another way in which it is richer is that the files in the set are ordered. That is, a `FileSet` is more like an ordered list than an unordered set.

In most situations, the order of files in a `FileSet` doesn't matter. However, in conflict resolution it is significant. If you look at the preceding `RewritePath` example again, you might wonder about the order in which the various `.md` files are appended to each other. This ordering is determined by the order of the files in the input set.

So what is that order? In general, when files are read from disk to create a `FileSet`, you cannot assume a specific order. Yes, the files are read and processed in a sequential order, but the actual order is not well defined. It depends on implementation details of the underlying file system. The accelerator engine therefore does not ensure a specific order in this case. It only ensures that it preserves whatever ordering it receives from the file system, and processes files in accord with that order.

If you do not want the file order produced from reading directly from a file system and want to control the order of the sections in the `README.md` file, change the order of the merge children. `Merge` processes its children in order and reflects this order in the resulting output

For example:

```
chain:
  - merge:
    - include: ['README.md']
    - include: ['DEPLOYMENT.md']
      chain:
        - type: RewritePath
          rewriteTo: "README.md"
  - type: UniquePath
    strategy: Append
```

In this example, `README.md` from the first child of `merge` comes before `DEPLOYMENT.md` from the second child of `merge`.

Next steps

This introduction focused on an intuitive understanding of the `<transform-definition>` notation. This notation defines precisely how the accelerator engine generates new project content from the files in the accelerator root.

For more information, see:

- An exhaustive [Reference](#) of all built-in transform types
- A sample, commented [accelerator.yaml](#) to learn from a concrete example

Use custom types in Application Accelerator

This topic tells you how to declare new `types` in `accelerator.yaml`

Use these types for options declaration, in addition to the built-in types `string`, `number`, and `boolean`.

In `accelerator.yaml`, use the `types` entry (inside the top-level `accelerator` section) to define custom types.

The name must be an initial capital letter.

In the following example, the `struct` type definition is syntactically equivalent to a sequence of option definitions:

```

accelerator:
  options:
    ...
  types:
    - name: Task
      struct:
        - name: title
          dataType: string
          label: Title
          description: A sample title
        - name: details
          label: Task details
          description: Enter the task details
        - name: done
          dataType: boolean
          label: Done?
          defaultValue: false

```

This example creates a new `type` that is available for the `dataType` property of any option. For example,

```

accelerator:
  options:
    - name: myTask
      dataType: Task
  types:
    ...

```

UIs render similar to the following:

Title*

A sample title

Task details

Enter the task details

Done?

and associate the entered values to the `myTask` top-level name, resulting in the following example values submission (here represented using JSON notation):

```

{
  "myTask": { // Note the use of a nested object here
    "title": "Get job done!",
    "details": "Needs this asap",
    "done": false
  }
}

```

```
}
}
```

The type of the `myTask` value is `object` (in Javascript/JSON parlance) and `Map<String, ?>` when seen from the Java engine side.

The earlier example is technically possible with the custom types feature, but brings little benefit over having three options named to achieve the same result, for example, `myTaskTitle`, `myTaskDetails`, and `myTaskDone`. The value of custom types is when they are used in sequence types, allowing you to enter an unbounded list of structured data:

```
accelerator:
  options:
    - name: myTasks
      dataType: [Task]
  types:
    ...
```

Which might result in the following example submission (JSON):

```
{
  "myTasks": [ // Note the use of JSON array
    { // with elem 0 being an object
      "details": "something",
      "done": true,
      "title": "The Title"
    },
    { // and elem 1 as well, etc
      "details": "something else",
      "done": false,
      "title": "The other Title"
    }
  ]
}
```

Limitations

A `struct` custom type declaration is made of an ordered series of option definitions. The support and semantics for individual text boxes of option-definition-like elements when used in the type *declaration* are stated in the following example.

When *referencing* a custom type in an option definition, some previously valid properties of an option definition might become irrelevant or unsupported. This is stated in the following example:

```
accelerator:
  types:
    - name: MyType
      struct:
        - name: someField # the "option name" will become a 'property' of the newly
          created type
          dataType: string # is the type of this single property. Typically, will be
          a simple
          # scalar type like string or number
          defaultValue: foo # supported and is the default if not overridden at usage
          point by the option's defaultValue
          description: something # will become the description for the field's widget
          choices: # supported
            - value: v
              text: t
          validationRegex: # validates that single property
          label: # will become the "title" of the widget
          inputType: # supported
```

```

    required:          # supported
    dependsOn:        # supported against other properties of THIS struct
    .. other fields
options:
  - name: anOptionThatUsesACustomType
    dataType: MyType
    defaultValue: # supported, should then be an object (or array thereof)
    description: # supported, is the description of the whole option (as opposed to
individual fields)
    label:          # supported, idem
    choices:        # NOT supported
      - value: v
        text: t
    validationRegex: # NOT supported
    inputType:      # NOT supported
    required:       # technically supported, useless in practice
    dependsOn:      # OK to depend on another option

```

Interaction with SpEL

Everywhere that SpEL is used in the engine syntax, accelerator authors might use SpEL syntax for accessing properties or array elements:

```
#myTasks[2]['done']
```

Do not use array indexing either with a literal number or a variable, as the purpose of the list of the custom types feature is that you don't know the data length in advance. For more information about idiomatic uses of repeated structured data, see [Loop Transform](#).

Interaction with Composition

Using composition alongside custom types has the following advantages/disadvantages:

- You might want to **leverage** types declared in an imported fragment
- There might be a type **name clash** between a host accelerator/fragment and an imported fragment, because the imported fragment author is unaware of how the fragment is to be used.

For more information about the syntax to customize the imported types names, see [Use fragments in Application Accelerator](#).

Use fragments in Application Accelerator

This topic tells you how to use fragments in Application Accelerator.

Introduction

Despite their benefits, writing and maintaining, accelerators can become repetitive and verbose as new accelerators are added. Some create a project different from the next with similar aspects, requiring some form of copy-paste.

To alleviate this concern, Application Accelerators support a feature named Composition that allows the re-use of parts of an accelerator, called **fragments**.

Introducing fragments

A **fragment** looks exactly the same as an accelerator:

- It is made of a set of files.
- It contains an `accelerator.yaml` descriptor with options, declarations, and a root transform.

There are differences however. Namely:

- Fragments are declared to the system differently. They are filed as **fragment** custom resources.
- They deal with files differently. Because fragments deal with their own files and files from the accelerator using them, they use dedicated conflict resolution [strategies](#) (more on this later).

Fragments may be thought of as “functions” in programming languages. After being defined and referenced, they are “called” at various points in the main accelerator. The composition feature is designed with ease of use and “common use first” in mind, so these “functions” are typically called with as little noise as possible. You can also call them complex or different values.

Composition relies on two building blocks that play hand in hand:

- The `imports` section at the top of an accelerator manifest.
- The, `InvokeFragment` transform, to be used alongside any other transform.

The `imports` section explained

To be usable in composition, a fragment MUST be *imported* into the dedicated section of an accelerator manifest:

```
accelerator:
  name: my-awesome-accelerator
  options:
    - name: flavor
      dataType: string
      defaultValue: Strawberry
  imports:
    - name: my-first-fragment
    - name: another-fragment
  engine:
    ...
```

The effect of importing a fragment this way is twofold:

- It makes its files available to the engine (therefore importing a fragment is required).
- It exposes all of its options as options of the accelerator as if they were defined by the accelerator itself.

So in the earlier example, if the `my-first-fragment` fragment had the following `accelerator.yaml` file:

```
accelerator
  name: my-first-fragment
  options:
    - name: optionFromFragment
      dataType: boolean
      description: this option comes from the fragment
  ...
```

Then it is as if the `my-awesome-accelerator` accelerator defined it:

```
accelerator:
  name: my-awesome-accelerator
  options:
```

```

- name: flavor
  dataType: string
  defaultValue: Strawberry
- name: optionFromFragment
  dataType: boolean
  description: this option comes from the fragment
imports:
  - name: my-first-fragment
  - name: another-fragment
engine:
  ...

```

All the metadata about options (type, default value, description, choices if applicable, *etc.*) come along when imported.

Because of this, users are prompted for a value for those options that come from fragments, as if they were options of the accelerator.

Using the `InvokeFragment` Transform

The second part at play in the composition is the `InvokeFragment` Transform.

As with any other transform, it may be used anywhere in the `engine` tree and receives files that are “visible” at that point. Those files, alongside those that make up the fragment, are made available to the fragment logic. If the fragment wants to choose between two versions of a file for a path, two new conflict resolution `strategies` are available: `FavorForeign` and `FavorOwn`.

The behavior of the `InvokeFragment` transform is very straightforward: after having validated options that the fragment expects (and maybe after having set default values for options that support one), it executes the whole transform of the fragment *as if it was written in place of `InvokeFragment`*.

See the `InvokeFragment` [reference page](#) for more explanations, examples, and configuration options. This topic now focuses on additional features of the `imports` section that are seldom used but still available to cover more complex use cases.

Back to the `imports` section

The complete definition of the `imports` section is as follows, with features in increasing order of “complexity”:

```

accelerator:
  name: ...
  options:
    - name: ...
    ...
  imports:
    - name: some-fragment

    - name: another-fragment
      expose:
        - name: "*"
      exposeTypes:
        - name: "*"

    - name: yet-another-fragment
      expose:
        - name: someOption

        - name: someOtherOption
          as: aDifferentName
      exposeType:
        - name: SomeType

```

```

      - name: SomeOtherType
        as: ADifferentName
engine:
  ...

```

As shown earlier, the `imports` section calls a list of fragments to import. By default, all their options and types become options/type of the accelerator. Those options appear *after* the options defined by the accelerator, in the order the fragments are imported in.

It is even possible for a fragment to import another fragment, the semantics being the same as when an accelerator imports a fragment. This is a way to break apart a fragment even further if needed.

When importing a fragment, you can select which options of the fragment to make available as options of the accelerator. **This feature should only be used when a name clash arises in option names.**

The semantics of the `expose` block are as follows:

- For every `name/as` pair, don't use the original (`name`) of the option but instead, use the alias (`as`). Other metadata about the option is left unchanged.
- If the special `name: "*" (which is NOT a legit option name usually) appears, all imported option names that are not remapped (the index at which the * appears in the YAML list is irrelevant) might be exposed with their original name.`
- The default value for `expose` is `[{name: "*"}]`, that is, by default exposes all options with their original name.
- As soon as a single remap rule appears, the default is overridden. For example, to override some names AND expose the others unchanged, the `*` must be explicitly re-added.
- To explicitly un-expose ALL options from an imported fragment, an empty array may be used and overrides the default: `expose: []`.

Similarly, you can also select which `custom types` of the fragment to make available as types of the accelerator. **This feature should only be used when a name clash arises in types names.**

The semantics of the `exposeTypes` block are as follows:

- For every `name/as` pair, don't use the original (`name`) of the type but instead, use the alias (`as`). Options that used the original name are automatically "rewritten" to use the new name.
- If the special `name: "*" appears, which is NOT usually a legit type name, all imported other type names that are not remapped are exposed with their original name. The index at which the * appears in the YAML list is irrelevant.`
- The default value for `exposeTypes` is `[{name: "*"}]`, that is, by default exposes all types with their original name.
- As soon as a single remap rule appears, the default is overridden. For example, to override some names AND expose the others unchanged, the `*` must be explicitly re-added.
- To explicitly un-expose ALL types from an imported fragment, an empty array may be used, which overrides the default: `exposeTypes: []`.

Using `dependsOn` in the `imports` section

Lastly, as a convenience for the conditional use of fragments, you can make an exposed imported option *depend on* another option, as in the following example:

```
imports:
  - name: tap-initialize
    expose:
      - name: gitRepository
        as: gitRepository
        dependsOn:
          name: deploymentType
          value: workload
      - name: gitBranch
        as: gitBranch
        dependsOn:
          name: deploymentType
          value: workload
```

This plays well with the use of `condition`, as in the following example:

```
...
engine:
  ...
  type: InvokeFragment
  condition: "#deploymentType == 'workload'"
  reference: tap-initialize```
```

Discovering fragments using Tanzu CLI accelerator plug-in

Using the accelerator plug-in for Tanzu CLI, you can view a list of available fragments. Run:

```
tanzu accelerator fragment list
```

To see a list of available accelerator fragments. For example:

NAME	READY	REPOSITORY
app-sso-client	true	source-image: registry.example.com/app-accelerator/fragments/app-sso-client@sha256:ed5cf5544477d52d4c7baf3a76f71a112987856e77558697112e46947ada9241
java-version	true	source-image: registry.example.com/app-accelerator/fragments/java-version@sha256:df99a5ace9513dc8d083fb5547e2a24770dfb08ec111b6591e98497a329b969d
live-update	true	source-image: registry.example.com/app-accelerator/fragments/live-update@sha256:c2eda015b0f811b0eeaa587b6f2c5410ac87d40701906a357cca0decb3f226a4
spring-boot-app-sso-auth-code-flow	true	source-image: registry.example.com/app-accelerator/fragments/spring-boot-app-sso-auth-code-flow@sha256:78604c96dd52697ea0397d3933b42f5f5c3659cbcdc0616ff2f57be558650499
tap-initialize	true	source-image: registry.example.com/app-accelerator/fragments/tap-initialize@sha256:7a3ae8f9277ef633200622dbf9d0f5a07dea25351ac3dbf803ea2fa759e3baac
tap-workload	true	source-image: registry.example.com/app-accelerator/fragments/tap-workload@sha256:8056ad9f05388883327d9bbe457e6a0122dc452709d179f683eceb6d848338d0

The `tanzu accelerator fragment get <fragment-name>` command shows all the options defined for the fragment and also any accelerators or other fragments that import this fragment. Run:

```
tanzu accelerator fragment get java-version
```

The following output is displayed:

```
name: java-version
namespace: accelerator-system
displayName: Select Java Version
```

```

ready: true
options:
- choices:
  - text: Java 8
    value: "1.8"
  - text: Java 11
    value: "11"
  - text: Java 17
    value: "17"
  defaultValue: "11"
  inputType: select
  label: Java version to use
  name: javaVersion
  required: true
artifact:
  message: Resolved revision: registry.example.com/app-accelerator/fragments/java-vers
ion@sha256:df99a5ace9513dc8d083fb5547e2a24770dfb08ec111b6591e98497a329b969d
  ready: true
  url: http://source-controller-manager-artifact-service.source-system.svc.cluster.loc
al./imagerepository/accelerator-system/java-version-frag-97nwp/df99a5ace9513dc8d083fb5
547e2a24770dfb08ec111b6591e98497a329b969d.tar.gz
imports:
  None
importedBy:
  accelerator/java-rest-service
  accelerator/java-server-side-ui
  accelerator/spring-cloud-serverless

```

This shows the `options` and `importedBy` with a list of three accelerators that import this fragment.

Correspondingly, the `tanzu accelerator get <accelerator-name>` shows the fragments that an accelerator imports. Run:

```
tanzu accelerator get java-rest-service
```

The following output is shown:

```

name: java-rest-service
namespace: accelerator-system
description: A Spring Boot Restful web application including OpenAPI v3 document gener
ation and database persistence, based on a three-layer architecture.
displayName: Tanzu Java Restful Web App
iconUrl: data:image/png;base64,...abbreviated...
source:
  image: registry.example.com/app-accelerator/samples/java-rest-service@sha256:c098bb3
8b50d8bbead0a1b1e9be5118c4fdce3e260758533c38487b39ae0922d
  secret-ref: [{reg-creds}]
tags:
- java
- spring
- web
- jpa
- postgresql
- tanzu
ready: true
options:
- defaultValue: customer-profile
  inputType: text
  label: Module artifact name
  name: artifactId
  required: true
- defaultValue: com.example
  inputType: text
  label: Module group name
  name: groupId

```

```

required: true
- defaultValue: com.example.customerprofile
  inputType: text
  label: Module root package
  name: packageName
  required: true
- defaultValue: customer-profile-database
  inputType: text
  label: Database Instance Name this Application will use (can be existing one in
    the cluster)
  name: databaseName
  required: true
- choices:
  - text: Maven (https://maven.apache.org/)
    value: maven
  - text: Gradle (https://gradle.org/)
    value: gradle
  defaultValue: maven
  inputType: select
  name: buildTool
  required: true
- choices:
  - text: Flyway (https://flywaydb.org/)
    value: flyway
  - text: Liquibase (https://docs.liquibase.com/)
    value: liquibase
  defaultValue: flyway
  inputType: select
  name: databaseMigrationTool
  required: true
- dataType: boolean
  defaultValue: false
  label: Expose OpenAPI endpoint?
  name: exposeOpenAPIEndpoint
- defaultValue: ""
  dependsOn:
    name: exposeOpenAPIEndpoint
  inputType: text
  label: System API Belongs To
  name: apiSystem
- defaultValue: ""
  dependsOn:
    name: exposeOpenAPIEndpoint
  inputType: text
  label: Owner of API
  name: apiOwner
- defaultValue: ""
  dependsOn:
    name: exposeOpenAPIEndpoint
  inputType: text
  label: API Description
  name: apiDescription
- choices:
  - text: Java 8
    value: "1.8"
  - text: Java 11
    value: "11"
  - text: Java 17
    value: "17"
  defaultValue: "11"
  inputType: select
  label: Java version to use
  name: javaVersion
  required: true
- dataType: boolean
  defaultValue: true

```

```

dependsOn:
  name: buildTool
  value: maven
inputType: checkbox
label: Include TAP IDE Support for Java Workloads
name: liveUpdateIDESupport
- defaultValue: dev.local
dependsOn:
  name: liveUpdateIDESupport
description: The prefix for the source image repository where source can be stored
  during development
inputType: text
label: The source image repository prefix to use when pushing the source
name: sourceRepositoryPrefix
artifact:
  message: Resolved revision: registry.example.com/app-accelerator/samples/java-rest-s
  ervice@sha256:c098bb38b50d8bbead0a1b1e9be5118c4fdce3e260758533c38487b39ae0922d
  ready: true
  url: http://source-controller-manager-artifact-service.source-system.svc.cluster.loc
  al./imagerepository/accelerator-system/java-rest-service-acc-wcn8x/c098bb38b50d8bbead0
  a1b1e9be5118c4fdce3e260758533c38487b39ae0922d.tar.gz
imports:
  java-version
  live-update
  tap-workload

```

The `imports` section at the end shows the fragments that this accelerator imports. The `options` section shows all options defined for this accelerator. This includes all options defined in the imported fragments, for example, the options for the Java version imported from the `java-version` fragment.

Transforms reference

This topic provides you with a list and brief description of the available Application Accelerator transforms in Tanzu Application Platform (commonly known as TAP).

Available transforms

You can use:

- [Combo](#) as a shortcut notation for many common operations. It combines the behaviors of many of the other transforms.
- [Include](#) to select files to operate on.
- [Exclude](#) to select files to operate on.
- [Merge](#) to work on subsets of inputs and to gather the results at the end.
- [Chain](#) to apply several transforms in sequence using function composition.
- [Let](#) to introduce new scoped variables to the model.
- [InvokeFragment](#) allows re-using various fragments across accelerators.
- [ReplaceText](#) to perform simple token replacement in text files.
- [RewritePath](#) to move files around using regular expression (regex) rules.
- [OpenRewriteRecipe](#) to apply [Rewrite](#) recipes, such as package rename.
- [YTT](#) to run the `ytt` tool on its input files and gather the result.
- [UseEncoding](#) to set the encoding to use when handling files as text.
- [UniquePath](#) to decide what to do when several files end up on the same path.

- [Loop](#) to iterate over a list and apply a transform for each element.
- [Provenance](#) to generate a manifest of the accelerator run.

See also

- [Conflict Resolution](#)

Transforms reference

This topic provides you with a list and brief description of the available Application Accelerator transforms in Tanzu Application Platform (commonly known as TAP).

Available transforms

You can use:

- [Combo](#) as a shortcut notation for many common operations. It combines the behaviors of many of the other transforms.
- [Include](#) to select files to operate on.
- [Exclude](#) to select files to operate on.
- [Merge](#) to work on subsets of inputs and to gather the results at the end.
- [Chain](#) to apply several transforms in sequence using function composition.
- [Let](#) to introduce new scoped variables to the model.
- [InvokeFragment](#) allows re-using various fragments across accelerators.
- [ReplaceText](#) to perform simple token replacement in text files.
- [RewritePath](#) to move files around using regular expression (regex) rules.
- [OpenRewriteRecipe](#) to apply [Rewrite](#) recipes, such as package rename.
- [YTT](#) to run the `ytt` tool on its input files and gather the result.
- [UseEncoding](#) to set the encoding to use when handling files as text.
- [UniquePath](#) to decide what to do when several files end up on the same path.
- [Loop](#) to iterate over a list and apply a transform for each element.
- [Provenance](#) to generate a manifest of the accelerator run.

See also

- [Conflict Resolution](#)

Combo transform

This topic tells you about the Application Accelerator [Combo](#) transform in Tanzu Application Platform (commonly known as TAP).

The [Combo](#) transform combines the behaviors of [Include](#), [Exclude](#), [Merge](#), [Chain](#), [UniquePath](#), and [Let](#).

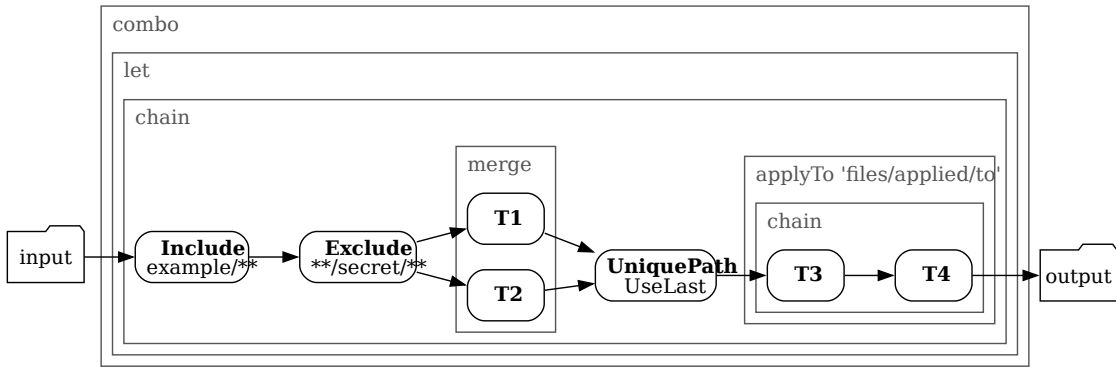

Syntax reference

Here is the full syntax of `Combo`:

```

type: Combo # This can be omitted, because Combo is the default transform type.
let: # See Let.
  - name: <string>
    expression: <SpEL expression>
  - name: <string>
    expression: <SpEL expression>
condition: <SpEL expression>
include: [<ant pattern>] # See Include.
exclude: [<ant pattern>] # See Exclude.
merge: # See Merge.
  - <m1-transform>
  - <m2-transform>
  - ...
chain: # See Chain.
  - <c1-transform>
  - <c2-transform>
  - ...
applyTo: [<ant pattern>] # See Chain
onConflict: <conflict resolution> # See UniquePath.

```

Behavior

The `Combo` transform properties have default values, are optional, and you must use at least one property.

When you configure the `Combo` transform with all properties, it behaves as follows:

1. Applies the `include` as if it were the first element of a `Chain`. The default value is `['**']`; if not present, all files are retained.
2. Applies the `exclude` as if it were the second element of the chain. The default value is `[]`; if not present, no files are excluded. Only files that match the `include`, but are not excluded by the `exclude`, remain.
3. Feeds all those files as input to all transforms declared in the `merge` property, exactly as `Merge` does. The result of that `Merge`, which is the third transform in the big chain, is another set of files. If there are no elements in `merge`, the previous result is directly fed to the next step.
4. The result of the merge step is prone to generate duplicate entries for the same `path`. It's implicitly forwarded to a `UniquePath` check, configured with the `onConflict` strategy. The

default policy is to retain files appearing later. The results of the transforms that appear later in the `merge` block “win” against results appearing earlier.

5. Passes that result as the input to the `chain` defined by the `chain` property. The combo chain is prolonged with the elements defined in `chain`. If there are no elements in `chain`, it's as if the previous result was used directly. If the `applyTo` property is set, it applies to the sub-chain (and that sub-chain only).
6. If the `let` property is defined in the `Combo`, the whole execution is wrapped inside a `Let` that exposes its derived symbols.

To recap in pseudo code, a giant `Combo` behaves like this:

```
Let(symbols, in:
  Chain(
    include,
    exclude,
    Chain(Merge(<m1-transform>, <m2-transform>, ...), UniquePath(onConflict)),
    Chain(<applyTo>, <c1-transform>, <c2-transform>, ...)
  )
)
```

You rarely use at any one time all the features that `Combo` offers. Yet `Combo` is a good way to author other common building blocks without having to write their `type: x` in full.

For example, this:

```
include: ['**/*.txt']
```

is a perfectly valid way to achieve the same effect as this:

```
type: Include
patterns: ['**/*.txt']
```

Similarly, this:

```
chain:
- type: T1
  ...
- type: T2
  ...
```

is often preferred over the more verbose:

```
type: Chain
transformations:
- type: T1
  ...
- type: T2
  ...
```

As with other transforms, the order of declaration of properties has no impact. For clarity, a convention that mimics the actual behavior is used, but the following applies **T1** and **T2** on all `.yaml` files even though it places the `include` section after the `merge` section.

```
merge:
- type: T1
- type: T2
include: [".yaml"]
```

In other words, **Combo** applies **include** filters before **merge** irrespective of the physical order of the keys in the YAML text. It's a good practice to place the **include** key before the **merge** key. This makes the accelerator definition more readable, but has no effect on its execution order.

Examples

The following are typical use cases for **Combo**.

Example 1

To apply separate transformations to separate sets of files. For example, to all **.yaml** files and to all **.xml** files:

```
merge:
  # This uses the Merge syntax in a first Combo.
  - include: ['*.yaml']      # This actually nests a second Combo inside the first.
    chain:
      - type: T1
      - type: T2
  - include: ['*.xml']      # Here comes a third Combo, used as the 2nd child inside t
    he first
    chain:
      - type: T3
      - type: T4
```

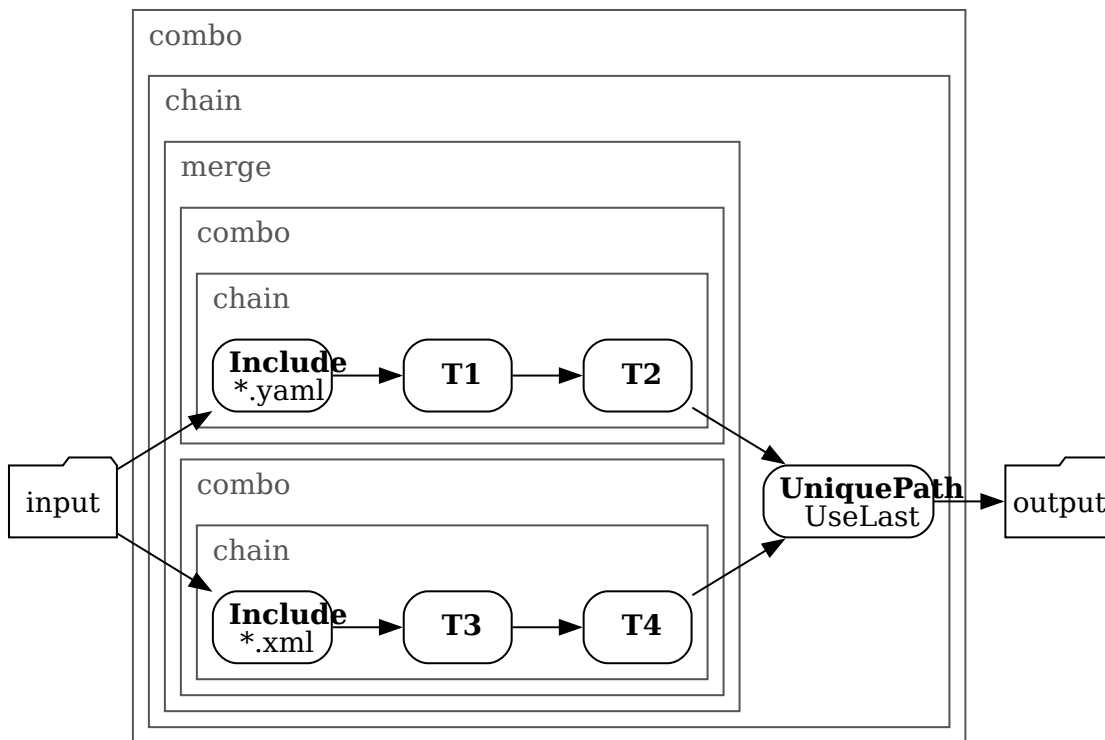

Example 2

To apply **T1** then **T2** on all **.yaml** files that are not in any **secret** directory:

```
include: ['**/*.yaml']
exclude: ['**/secret/**']
chain:
  - type: T1
  ..
```

```
- type: T2
  ..
```

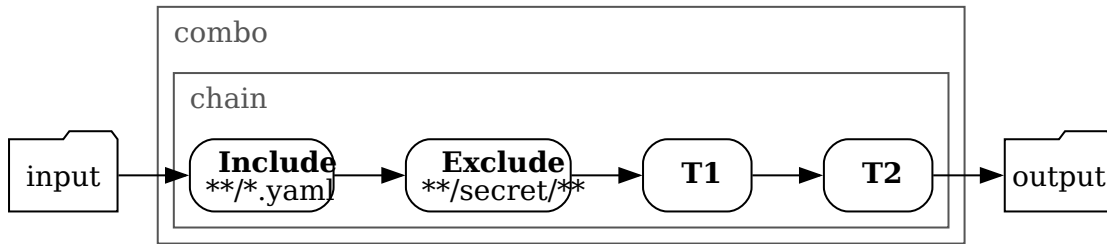

Include transform

This topic tells you about the Application Accelerator [Include](#) transform in Tanzu Application Platform (commonly known as TAP).

The [Include](#) transform retains files based on their [path](#), letting in *only* those files whose path matches at least one of the configured [patterns](#). The contents of files, and any of their other characteristics, are unaffected.

[Include](#) is a basic building block seldom used as is, which makes sense if composed inside a [Chain](#) or a [Merge](#). It is often more convenient to leverage the shorthand notation offered by [Combo](#).

Syntax reference

```
type: Include
patterns: [<ant pattern>]
condition: <SpEL expression>
```

Examples

```
type: Chain
transformations:
- type: Include
  patterns: ["**/*.yaml"]
- type: # At this point, only yaml files are affected
```

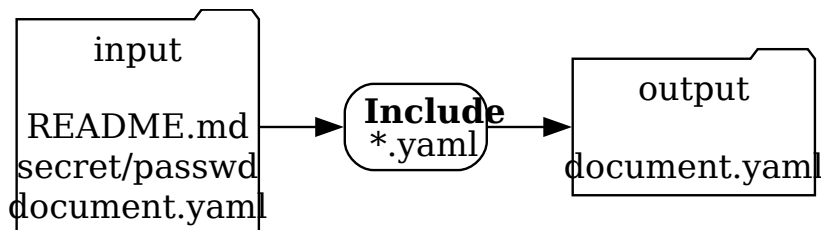

See also

- [Exclude](#)
- [Combo](#)

Exclude transform

This topic tells you about the Application Accelerator [Exclude](#) transform in Tanzu Application Platform (commonly known as TAP).

The `Exclude` transform retains files based on their `path`, allowing all files except ones with a path that matches at least one of the configured `patterns`. The contents of files, and any of their other characteristics are unaffected.

`Exclude` is a basic building block seldom used *as is*, which makes sense if composed inside a `Chain` or a `Merge`. It is often more convenient to leverage the shorthand notation offered by `Combo`.

Syntax reference

```
type: Exclude
patterns: [<ant pattern>]
condition: <SpEL expression>
```

Examples

```
type: Chain
transformations:
- type: Exclude
  patterns: ["**/secret/**"]
- type: # At this point, no file matching **/secret/** is affected.
```

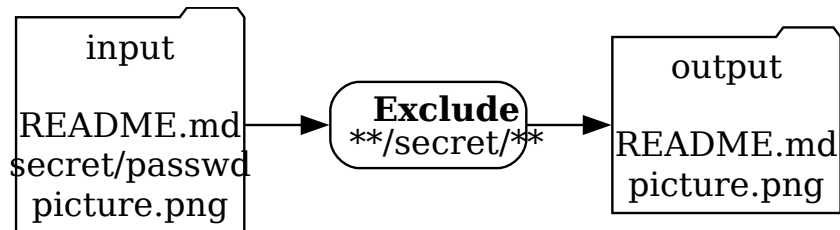

See also

- [Include](#)
- [Combo](#)

Merge transform

This topic tells you about the Application Accelerator `Merge` transform in Tanzu Application Platform (commonly known as TAP).

The `Merge` transform feeds a copy of its input to several other transforms and merges the results together using set union.

A `Merge` of `T1`, `T2`, and `T3` applied to input `I` results in `T1(I) ∪ T2(I) ∪ T3(I)`.

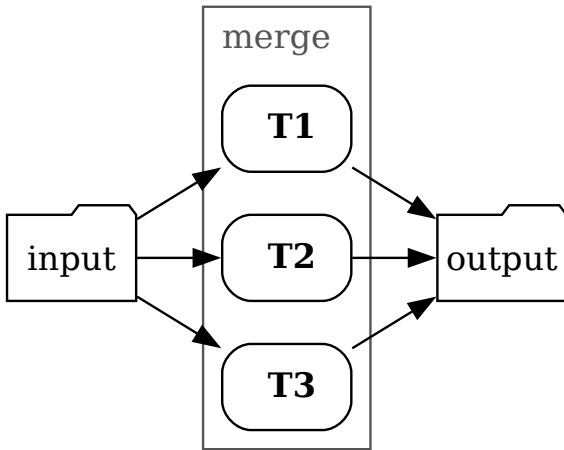

An empty merge produces nothing (\emptyset).

Syntax reference

```

type: Merge
sources:
  - <transform>
  - <transform>
  - <transform>
  - ...
condition: <SpEL expression>
    
```

See also

- [Combo](#) is often used to express a [Merge](#) and other transformations in a shorthand syntax.

Chain transform

This topic tells you about the Application Accelerator [Chain](#) transform in Tanzu Application Platform (commonly known as TAP).

The [Chain](#) transform uses function composition to produce its final output.

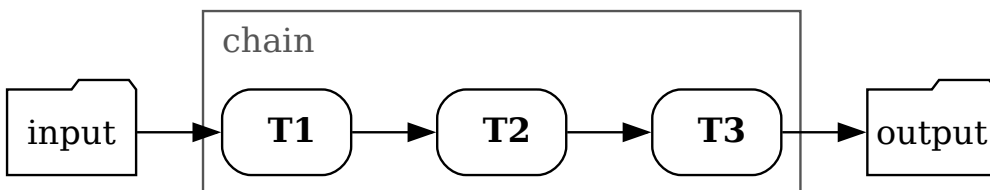

Syntax reference

```

type: Chain
transformations:
  - <transform>
  - <transform>
  - <transform>
  - ...
applyTo: [<ant pattern>]
condition: <SpEL expression>
    
```

Behavior

A chain of **T1** then **T2** then **T3** first applies transform **T1**. It then applies **T2** to the output of **T1**, and finally applies **T3** to the output of that. In other words, **T3** to **T2** to **T1**.

An empty chain acts as function identity.

If the optional `applyTo` property is set, then the chained transformations are only applied to files with paths that match the `applyTo` patterns. Files with paths that don't match are left untouched and merged back with the other results to form the final result of the `Chain` transform.

Let transform

This topic tells you about the Application Accelerator `Let` transform in Tanzu Application Platform (commonly known as TAP).

The `Let` transform wraps another transform, creating a new scope that extends the existing scope.

SpEL expressions inside the `Let` can access variables from both the existing scope and the new scope.

Variables defined by the `Let` should not shadow existing variables. If they do, those existing variables won't be accessible.

Syntax reference

```
type: Let
symbols:
- name: <string>
  expression: <SpEL expression>
- ...
in: <transform> # <- new symbols are visible in here
```

Execution

The `Let` adds variables to the new scope by computation of `SpEL expressions`.

```
engine:
  let:
  - name: <string>
    expression: <SpEL expression>
  - ...
```

Both a `name` and an `expression` must define each symbol where:

- `name` must be a camelCase string name. If a `let symbol` happens to have the same name as a symbol already defined in the surrounding scope, then the local symbol shadows the symbol from the surrounding scope. This makes the variable from the surrounding scope inaccessible in the remainder of the `Let` but doesn't alter its original value.
- `expression` must be a valid SpEL expression expressed as a YAML string. Be careful when using the `#` symbol for variable evaluation, because this is the comment marker in YAML. So SpEL expressions in YAML must enclose strings in quotes or rely on block style. For more information about block style, see [Block Style Productions](#).

Symbols defined in the `Let` are evaluated in the new scope in the order they are defined. This means that symbols lower in the list can make use of the variables defined higher in the list but not the other way around.

See also

- [Combo](#) provides a way to declare a `Let` scope and other transforms in a short syntax.

Loop transform

This topic tells you about the Application Accelerator `Loop` transform in Tanzu Application Platform (commonly known as TAP).

The `Loop` transform iterates over elements in a list and applies the provided transform for every element in that list.

When `doAsMerge` is used, a copy of the `Loop` transform's input is passed to each transform and the outputs from each transform are merged using a set union.

When `doAsChain` is used, each transform is executed sequentially, receiving the previous transform's output as its input. The first transform is to receive the `Loop` transform's input as its input.

Syntax reference

```
type: Loop
on: <SpEL expression>
var: <string>
index: <string>
doAsChain: <transform>
doAsMerge: <transform>
```

- `on` must be a SpEL expression that evaluates a list. This is the list of elements to be iterated over.
- `var` is the name of the variable to be assigned to the current element on each iteration. (optional)
- `index` is the variable's name to be assigned to the index of the current element on each iteration. (optional)
- `doAsMerge` is the transform to be executed for every element in the list, on a copy of the `Loop` transform's input.
- `doAsChain` is the transform to be executed for every element in the list, passing the output of the transform as input to the next transform.

Both `var` and `index` are optional.

Only one of the `doAsMerge` or `doAsChain` variables is to be used in a `Loop` transform.

Behavior

Consider the following when choosing `doAsMerge` or `doAsChain`:

`doAsMerge` executes the transform on the same input files for every iteration and merges the resulting outputs. It is best suited when a transform is executed multiple times on the same input and does not have conflicts.

`doAsChain` executes the transform on the initial input files once and then passes the resulting output to the second iteration and so on. It is best suited when a transform must detect any changes that occurred in the previous iteration.

Examples

See the following examples using the `Loop` transform.

Example 1

Create a new directory for every module in `modules` (a list of strings) based on the contents of the “template” directory.

```

type: Loop
on: "#modules"
var: m
doAsMerge:
  type: RewritePath
  regex: "template/(.*)"
  rewriteTo: "#m + '/' + #g1"
    
```

The following diagram shows how this example behaves:

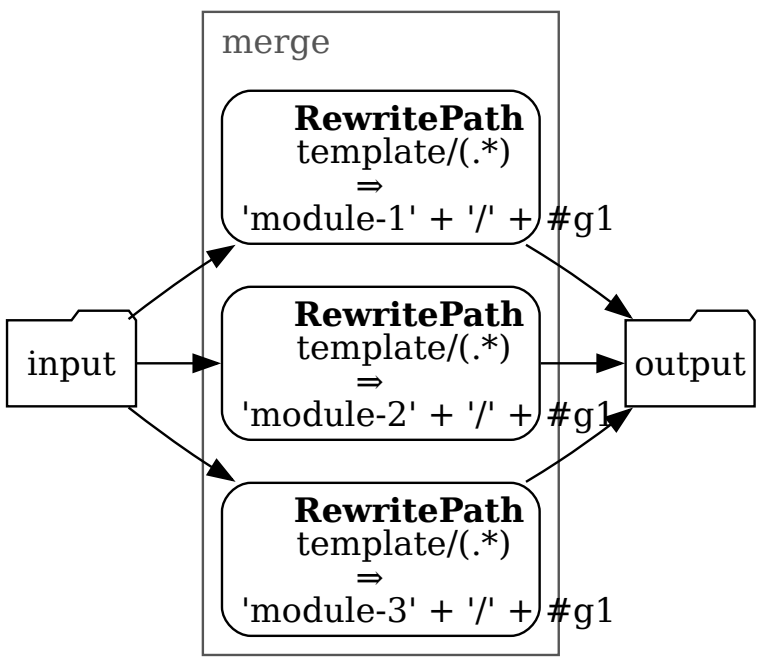

Example 2

Add every `artifactId` in `artifacts` (a list of strings) as a Spring dependency.

```

type: Loop
on: "#artifacts"
var: a
doAsChain:
  type: OpenRewriteRecipe
  recipe: org.openrewrite.maven.AddDependency
  options:
    groupId: "'org.springframework'"
    artifactId: "#a"
    version: "'5.7.1'"
    
```

The following diagram shows how this example behaves:

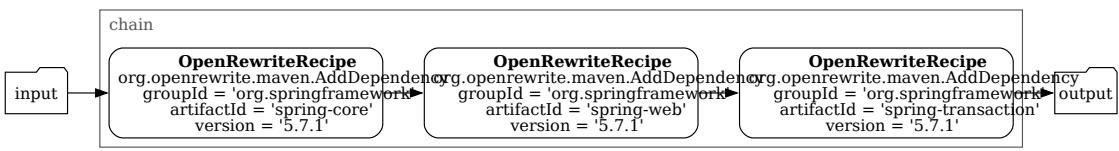

Example 3

You can use `Loop` in combination with custom types, for example:

```

accelerator:
  types:
    - name: MavenPlugin
      struct:
        - name: groupId
        - name: artifactId
        - name: version
      options:
        - name: pluginsToAdd
          dataType: [MavenPlugin] # End users will be able to enter a collection of GAV tuples
  engine:
    include: [pom.xml]
    chain:
      - type: Loop
        on: pluginsToAdd # Iterate on the pluginsToAdd collection
        var: p           # The variable "p" will contain each tuple in turn
        doAsChain:      # Will apply the second execution to the result of the first, and so on...
          type: OpenRewriteRecipe
          recipe: org.openrewrite.maven.AddPlugin
          options:
            groupId: "#p['groupId']"
            artifactId: "#p['artifactId']"
            version: "#p['version']"

```

For more information, see [Using Custom Types](#).

InvokeFragment transform

This topic tells you about the Application Accelerator `InvokeFragment` transform in Tanzu Application Platform (commonly known as TAP).

The `InvokeFragment` performs transformations defined in an imported Fragment, allowing re-use across accelerators.

Syntax reference

```

type: InvokeFragment
reference: <imported-fragment>
let: # See Let
  - name: <string>
    expression: <SpEL expression>
  ...
anchor: [<file path>]

```

Behavior

Assuming some fragment `my-fragment` has been imported in the accelerator (thus exposing the options it defines as options of the current accelerator), the following construct invokes `my-fragment`:

```

type: InvokeFragment
reference: my-fragment

```

This passes all input files (depending where this invocation sits in the “tree”) to the invoked fragment, which can then manipulate them alongside its own files. The result of the invocation becomes the result of this transform.

Variables

At the point of invocation, all currently defined variables are made visible to the invoked fragment. Therefore, if it was `import`-ed in the most straightforward manner, a fragment defining an option `myOption` is defining an option named `myOption` at the accelerator level, and the value provided by the user is visible at the time of invocation.

To override a value, or if an imported option has been exposed under a different name, or not at all, you can use a `let` construct when using `InvokeFragment`. This behaves as the `Let` transform: for the duration of the fragment invocation, the variables defined by `let` now have their newly defined values. Outside the scope of the invocation, the regular model applies.

Files

The set of files coming from the invoking accelerator and made visible to the fragment is the set of files that “reach” the point of invocation. For example, in the following case:

```
include: ["somedir/**"]
chain:
  - type: InvokeFragment
    reference: my-fragment
```

All files that the fragment invocation “sees” are files in the `somedir/` subdirectory. If the `my-fragment` has not been written accordingly, this can be problematic. Chances are that this re-usable fragment expects files to be present at the root of the project tree and work on them.

To better cope with this typical situation, the `InvokeFragment` transform exposes the optional `anchor` configuration property. Continuing with the earlier example, by using `anchor: somedir`, then all files coming from the current accelerator are exposed as if their `path` had the `somedir/` prefix removed. When it comes to gathering the result of the invocation though, all resulting files are re-introduced with a prefix prepended to their `path` (this applies to **all** files produced by the fragment, not just the ones originating from the accelerator).

The value of the `anchor` property must not start nor end with a slash (/) character.

Examples

The following is a full-featured example showcasing the interaction between the `imports` section and `InvokeFragment`:

```
accelerator:
  name: my-accelerator
  options:
    - name: someOption
      dataType: number
  imports:
    - name: my-fragment

engine:
  merge:
    - include: ["..."]
    - ...
  chain:
    - include: ["**/pom.xml"]
```

```
- type: InvokeFragment
  reference: my-fragment
```

Assuming `my-fragment` is defined as follows:

```
accelerator:
  name: my-fragment
  options:
    - name: indentationLevel
      dataType: number
      defaultValue: 2
  transform:
    chain:
      - include: ["**/*.xml"]
      - type: SomeTransform
      ...
```

Then users will be presented with two options: `someOption` and `indentationLevel`, as if `indentationLevel` was defined in the host accelerator.

Moreover, the behavior of the calling accelerator is exactly as if the body of the fragment transform was inserted in-place of `InvokeFragment`:

```
accelerator:
  name: my-accelerator
  options:
    - name: someOption
      dataType: number
    - name: indentationLevel
      dataType: number
      defaultValue: 2

engine:
  merge:
    - include: ["..."]
    - ...
    - chain:
      - include: ["**/pom.xml"]
      - chain:
        - include: ["**/*.xml"]
        - type: SomeTransform
      ...
```

Now you can imagine some scenarios to better clarify all configuration properties.

If, for some reason, you don't want to use the value entered in the `indentationLevel` option for the fragment, but twice the value provided for `someOption`. The `InvokeFragment` block can be rewritten as follows:

```
type: InvokeFragment
reference: my-fragment
let:
  - name: indentationLevel
    value: '2 * #someOption'
```

Finally, if the invocation in the accelerator looks like this:

```
engine:
  merge:
    - include: ["..."]
    - ...
    - chain:
      - include: ["**/README.md"]
```

```
- type: InvokeFragment
  reference: my-fragment
```

Then there is zero visible effect, because this is forwarding only `README.md` files to the fragment and the fragment is itself using a filter on `*.xml` files.

See also

- [Let](#)
- [RewritePath](#)

ReplaceText transform

This topic tells you about the Application Accelerator `ReplaceText` transform in Tanzu Application Platform (commonly known as TAP).

The `ReplaceText` transform allows replacing one or several text tokens in files as they are being copied to their destination. The replacement values are the result of dynamic evaluation of [SpEL expressions](#).

This transform is text-oriented and requires knowledge of how to interpret the stream of bytes that make up the file contents into text. All files are assumed to use `UTF-8` encoding by default, but you can use the [UseEncoding](#) transform upfront to specify a different charset to use on some files.

You can use `ReplaceText` transform in one of two ways:

- To replace several literal text tokens.
- To define the replacement behavior using a single regular expression, in which case the replacement SpEL expression can leverage the regex capturing group syntax.

Syntax reference

Syntax reference for replacing several literal text tokens:

```
type: ReplaceText
substitutions:
- text: STRING
  with: SPEL-EXPRESSION
- text: STRING
  with: SPEL-EXPRESSION
- ..
condition: SPEL-EXPRESSION
```

Syntax reference for defining the replacement behavior using a *single* regular expression:

Regex is used to match the entire document. To match on a per line basis, enable multiline mode by including `(?m)` in the regex.

```
type: ReplaceText
regex:
  pattern: REGULAR-EXPRESSION
  with: SPEL-EXPRESSION
condition: SPEL-EXPRESSION
```

In both cases, the SpEL expression can use the special `#files` helper object. This enables the replacement string to consist of the contents of an accelerator file. See the following [example](#).

Another set of helper objects are functions of the form `xxx2Yyyy()` where `xxx` and `yyy` can take the value `camel`, `kebab`, `pascal`, or `snake`. For example, `camel2Snake()` enables changing from

camelCase to snake_case.

Examples

See the following examples using The `ReplaceText` transform.

Example 1

Replacing the hardcoded string "hello-world-app" with the value of variable `#artifactId` in all `.md`, `.xml`, and `.yaml` files.

```
include: ['**/*.md', '**/*.xml', '**/*.yaml']
chain:
  - type: ReplaceText
    substitutions:
      - text: "hello-world-app"
        with: "#artifactId"
```

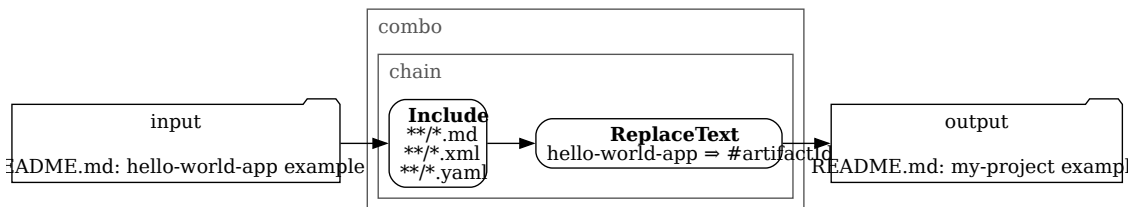

Example 2

Replacing the hardcoded string "hello-world-app" with the value of variable `#artifactId` in the `README-fr.md` and `README-de.md` files, which are encoded using the `ISO-8859-1` charset:

```
include: ['README-fr.md', 'README-de.md']
chain:
  - type: UseEncoding
    encoding: 'ISO-8859-1'
  - type: ReplaceText
    substitutions:
      - text: "hello-world-app"
        with: "#artifactId"
```

Example 3

Similar to the preceding example, but making sure the value appears as kebab case, while the entered `#artifactId` is using camel case:

```
include: ['**/*.md', '**/*.xml', '**/*.yaml']
chain:
  - type: ReplaceText
    substitutions:
      - text: "hello-world-app"
        with: "#camel2Kebab(#artifactId)"
```

Example 4

Replacing the hardcoded string "REPLACE-ME" with the contents of file named after the value of the `#platform` option in `README.md`:

```
include: ['README.md']
chain:
```

```
- type: ReplaceText
  substitutions:
    - text: "REPLACE-ME"
      with: "#files.contentsOf('snippets/install-' + #platform + '.md')"
```

Example 5

Replacing all occurrences of `apple` or `orange`, singular or plural, with the value of the accelerator option `#vegetable`, for example `'banana'`, keeping the trailing `'s'` when there was one.

```
include: ['README.md']
chain:
  - type: ReplaceText
    regex:
      pattern: "(apple|orange) (s)?"
      # This constructs a SpEL string containing eg 'banana$2' where $2
      # refers to the second capturing group (the optional 's')
      with: "#vegetable + '$2'"
```

See also

- [UseEncoding](#)

RewritePath transform

This topic tells you about the Application Accelerator `RewritePath` transform in Tanzu Application Platform (commonly known as TAP).

The `RewritePath` transform allows you to change the name and path of files without affecting their content.

Syntax reference

```
type: RewritePath
regex: <string>
rewriteTo: <SpEL expression>
matchOrFail: <boolean>
```

For each input file, `RewritePath` attempts to match its `path` by using the regular expression (regex) defined by the `regex` property. If the regex matches, `RewritePath` changes the `path` of the file to the evaluation result of `rewriteTo`.

`rewriteTo` is an expression that has access to the overall engine model and to variables defined by capturing groups of the regular expression. Both *named capturing groups* (`?<example>[a-z]*`) and regular *index-based* capturing groups are supported. `g0` contains the whole match, `g1` contains the first capturing group, and so on.

If the regex doesn't match, the behavior depends on the `matchOrFail` property:

- If set to `false`, which is the default, the file is left untouched.
- If set to `true`, an error occurs. This prevents misconfiguration if you expect all files coming in to match the regex. For more information about typical interactions between `RewritePath` and `Chain + Include`, see the following section, [Interaction with Chain and Include](#).

The default value for `regex` is the following regular expression, which provides convenient access to some named capturing groups:

```
^(?<folder>.*\/)?(?<filename>([^\/?!]|(?=(?<ext>\.[^/.]*)?)?)$)
```

Using `some/deep/nested/file.xml` as an example, the preceding regular expression captures:

- **folder:** The full folder path the file is in. In this example, `some/deep/nested/`.
- **filename:** The full name of the file, including extension *if present*. In this example, `file.xml`.
- **ext:** The last dot and extension in the filename, *if present*. In this example, `.xml`.

The default value for `rewriteTo` is the expression `#folder + #filename`, which doesn't rewrite paths.

Examples

See the following examples using the `RewritePath` transform.

Example 1

The following moves all files from `src/main/java` to `sub-module/src/main/java`:

```
type: RewritePath
regex: src/main/java/(.*)
rewriteTo: "'sub-module/src/main/java' + #g1" # 'sub-module/' + #g0 works too
```

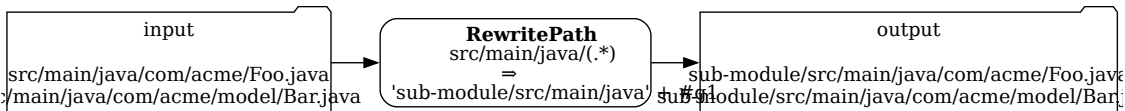

Example 2

The following flattens all files found inside the `sub-path` directory and its subdirectories, and puts them into the `flattened` folder:

```
type: RewritePath
regex: sub-path/(.*)*(?<filename>[^\/]*)
rewriteTo: "'flattened' + #filename" # 'flattened' + #g2 would work too
```

Example 3

The following turns all paths into lowercase:

```
type: RewritePath
rewriteTo: "#g0.toLowerCase()"
```

Interaction with Chain and Include

It's common to define pipelines that perform a `Chain` of transformations on a subset of files, typically selected by `Include/Exclude`:

```
- include: ["**/*.java"]
- chain:
  - # do something here
  - # and then here
```

If one of the transformations in the chain is a `RewritePath` operation, chances are you want the rewrite to apply to *all* files matched by the `Include`. For those typical configurations, you can set the `matchOrFail` guard to `true` to ensure the `regex` you provide indeed matches all files coming in.

See also

- Use [UniquePath](#) to ensure rewritten paths don't clash with other files, or to decide which path to select if they do clash.

OpenRewriteRecipe transform

This topic tells you about the Application Accelerator [OpenRewriteRecipe](#) transform in Tanzu Application Platform (commonly known as TAP).

The [OpenRewriteRecipe](#) transform allows you to apply any [Open Rewrite Recipe](#) to a set of files and gather the results.

The following Open Rewrite Recipes are supported:

- [Java recipes](#)
- [Maven recipes](#)
- [XML recipes](#)
- [YAML recipes](#)
- [JSON recipes](#)
- [Properties recipes](#)

The engine leverages v7.38.0 of Open Rewrite and parses Java files using the grammar for Java 11.

Syntax reference

```
type: OpenRewriteRecipe
recipe: <string> # Full qualified classname of the recipe
options:
  <string>: <SpEL expression> # Keys and values depend on the class of the recipe
  <string>: <SpEL expression> # Refer to the documentation of said recipe
  ...
```

Example

The following example applies the [ChangePackage](#) Recipe to a set of Java files in the `com.acme` package and moves them to the value of `#companyPkg`. This is more powerful than using [RewritePath](#) and [ReplaceText](#), as it reads the syntax of files and correctly deals with imports, fully compared to non-fully qualified names, and so on.

```
chain:
- include: ["**/*.java"]
- type: OpenRewriteRecipe
  recipe: org.openrewrite.java.ChangePackage
  options:
    oldPackageName: "'com.acme'"
    newPackageName: "#companyPkg"
```

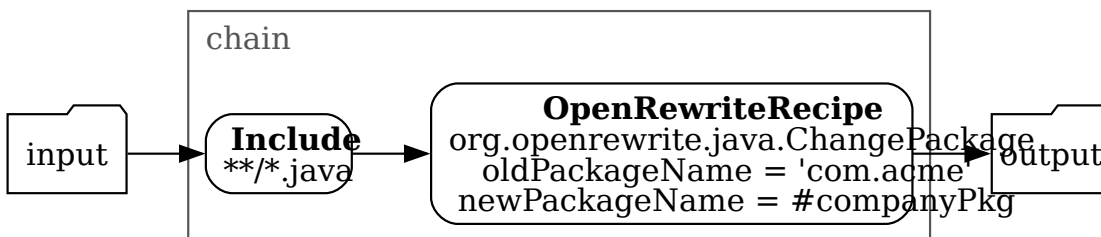

YTT transform

This topic tells you about the Application Accelerator **YTT** transform in Tanzu Application Platform (commonly known as TAP).

The **YTT** transform starts the **YTT** template engine as an external process.

Syntax reference

```
type: YTT
extraArgs: # optional
  - <SPEL-EXPRESSION-1>
  - <SPEL-EXPRESSION-2>
  - ...
```

The **YTT** transform’s YAML notation does not require any parameters. When invoked without parameters, which is the typical use case, the YTT transform’s input is determined entirely by two things only:

1. The input files fed into the transform.
2. The current values for options and derived symbols.

Execution

YTT is invoked as an external process with the following command line:

```
ytt -f <input-folder> \
  --data-values-file <symbols.json> \
  --output-files <output-folder> \
  <extra-args>
```

The **<input-folder>** is a temporary directory into which the input files are “materialized.” That is, the set of files passed to the YTT transform as input is written out into this directory to allow the YTT process to read them.

The **<symbols.json>** file is a temporary JSON file, which the current option values and derived symbols are materialized in the form of a JSON map. This allows YTT templates in the **<input-folder>** to make use of these symbols during processing.

The **<output-folder>** is a fresh temporary directory that is empty at the time of invocation. In a typical scenario, upon completion, the output directory contains files generated by YTT.

The **<extra-args>** are additional command line arguments obtained by evaluating the SPEL expressions from the **extraArgs** attribute.

When the **ytt** process completes with a 0 exit code, this is considered a successful execution and the contents of the output directory is taken to be the result of the YTT transform.

When the **ytt** process completes with a non 0 exit code, the execution of the **YTT** transform is considered to have failed and an exception is raised.

Examples

See the following examples using the **YTT** transform.

Basic invocation

When you want to execute **ytt** on the contents of the entire accelerator repository, use the YTT transform as your only transform in the engine declaration.

```

accelerator:
  ...
engine:
  type: YTT

```

To do anything beyond calling YTT, compose YTT into your accelerator flow using merge or chain combinators. This is exactly the same as composing any other type of transform.

For example, when you want to define some derived symbols as well as merge the results from YTT with results from other parts of your accelerator transform, you can reference this example:

```

engine:
  let: # Define derived symbols visible to all transforms (including YTT)
  - name: theAnswer
    expression: "41 + 1"
  merge:
  - include: ["deploy/**/*.yaml"] # select some yaml files to process with YTT
    chain: # Chain selected yaml files to YTT
    - type: YTT
  - ... include/generate other stuff to be merged alongside yaml generated by YTT...

```

The preceding example uses a combination of [Chain](#) and [Merge](#). You can use either [Merge](#) or [Chain](#) or both to compose YTT into your accelerator flow. Which one you choose depends on how you want to use YTT as part of your larger accelerator.

Using [extraArgs](#)

The [extraArgs](#) passes additional command line arguments to YTT. This adds file marks. See [File Marks](#) in the Carvel documentation.

For example, the following runs YTT and renames the `foo/demo.yaml` file in its output to `bar/demo.yaml`.

```

engine:
  type: YTT
  extraArgs: ["'--file-mark'", "'foo/demo.yaml:path=bar/demo.yaml'"]

```

The [extraArgs](#) attribute expects SPEL expressions. Take care to use proper escaping of literal strings using double and single quotes (that is, `""LITERAL-STRING""`).

UseEncoding transform

This topic tells you about the Application Accelerator [UseEncoding](#) transform in Tanzu Application Platform (commonly known as TAP).

When considering files in textual form, for example, when doing text replacement with the [ReplaceText](#) transform, the engine must decide which [encoding](#) to use.

By default, [UTF-8](#) is assumed. If any files must be handled differently, use the [UseEncoding](#) transform to annotate them with an explicit encoding.

[UseEncoding](#) returns an error if you apply encoding to files that have already been explicitly configured with a particular encoding.

Syntax reference

```

type: UseEncoding
encoding: <encoding> # As recognized by the java java.nio.charset.Charset class
condition: <SpEL expression>

```

Supported encoding names include, for example, [UTF-8](#), [US-ASCII](#), and [ISO-8859-1](#).

Example use

[UseEncoding](#) is typically used as an upfront transform to, for example, [ReplaceText](#) in a chain:

```
type: Chain # Or using "Combo"
transformations:
  - type: UseEncoding
    encoding: ISO-8859-1
  - type: ReplaceText
    substitutions:
      - text: "hello"
        with: "#howToSayHello"
```

See also

- [ReplaceText](#)

UniquePath transform

This topic tells you about the Application Accelerator [UniquePath](#) transform in Tanzu Application Platform (commonly known as TAP).

You can use the [UniquePath](#) transform to ensure there are no [path](#) conflicts between files transformed. You can often use this at the tail of a [Chain](#).

Syntax reference

```
type: UniquePath
strategy: <conflict resolution>
condition: <SpEL expression>
```

Examples

The following example concatenates the file that was originally named [DEPLOYMENT.md](#) to the file [README.md](#):

```
chain:
  - merge:
      - include: ['README.md']
      - include: ['DEPLOYMENT.md']
      chain:
        - type: RewritePath
          rewriteTo: "'README.md'"
  - type: UniquePath
    strategy: Append
```

See also

- [UniquePath](#) uses a [Conflict Resolution](#) strategy to decide what to do when several input files use the same [path](#).
- [Combo](#) implicitly embeds a [UniquePath](#) after the [Merge](#) defined by its [merge](#) property.

Conflict resolution

This topic tells you how to resolve conflicts that Application Accelerator transforms in Tanzu Application Platform (commonly known as TAP) might produce.

For example, if you're using [Merge](#) (or [Combo's merge](#) syntax) or [RewritePath](#), a transform can produce several files at the same `path`. The engine then must take an action: Should it keep the last file? Report an error? Concatenate the files together?

Syntax reference

Conflicts can arise for a number of reasons. You can avoid or resolve them by configuring transforms with a conflict resolution. For example:

- [Combo](#) uses [UseLast](#) by default, but you can configure it to do otherwise.
- You can explicitly end a transform [Chain](#) with a [UniquePath](#), which by default uses [Fail](#). This is customizable.

Combo

```

type: Combo      # often omitted
merge:
  - <transform>
  - <transform>
  - <transform>
chain:
  - <transform>
  - ...
onConflict: <conflict resolution> # defaults to 'UseLast'
    
```

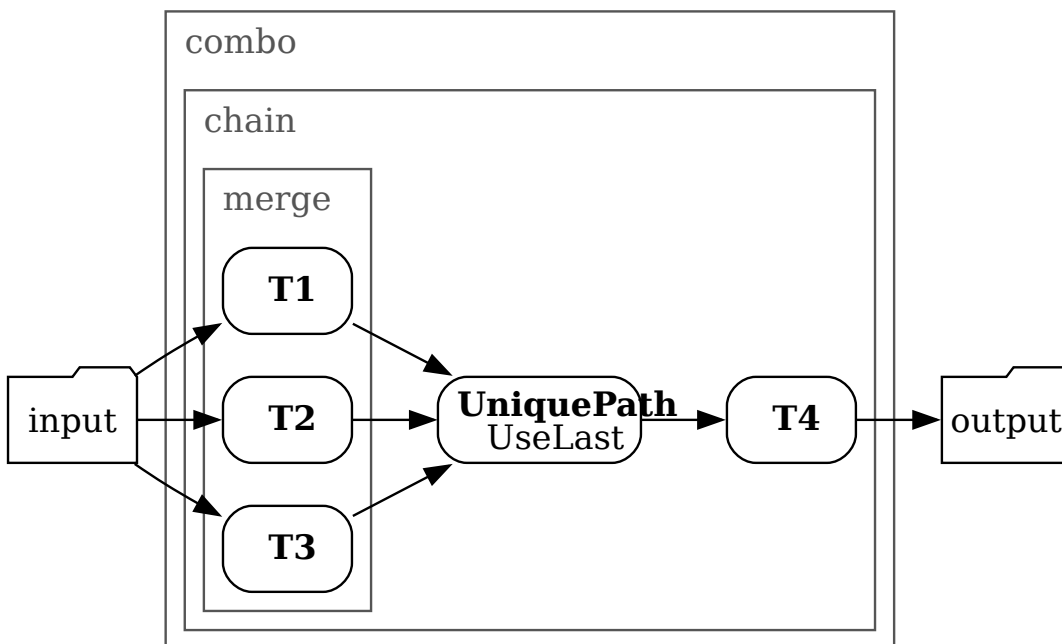

Chain

```

type: Chain      # or implicitly using Combo
transformations:
  - <transform>
  - <transform>
  - type: UniquePath
    strategy: <conflict resolution> # defaults to 'Fail'
    
```

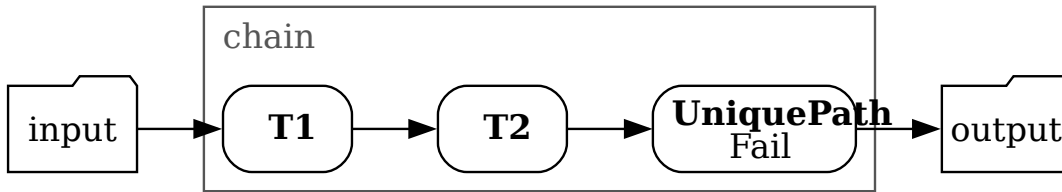

Available strategies

The following values and behaviors are available:

- **Fail**: Stop processing on the first file that exhibits `path` conflicts.
- **UseFirst**: For each conflicting file, the file produced first (typically by a transform appearing earlier in the YAML definition) is retained.
- **UseLast**: For each conflicting file, the file produced last (typically by a transform appearing later in the YAML definition) is retained.
- **Append**: The conflicting versions of files are concatenated (as if using `cat file1 file2 ...`), with files produced first appearing first.
- **FavorOwn**: Only makes sense in the context of `composition`. Selects the version of the file that comes from the current executing fragment if possible, falls back to the caller version otherwise.
- **FavorForeign**: Only makes sense in the context of `composition`. Selects the version of the file that was provided by the caller if present, falls back to the file originating from this fragment's fileset otherwise.
- **NWayDiff**: Try to merge the conflicting resources by applying patches computed against a common ancestor. The resulting resource has the attributes of the first conflicting resource.

See also

- [Combo](#)
- [UniquePath](#)

Provenance transform

This topic tells you about the Application Accelerator `Provenance` transform in Tanzu Application Platform (commonly known as TAP).

The `Provenance` transform is a special transform used to generate a file that provides details of the accelerator engine transform.

Syntax reference

```

type: Provenance
condition: <SpEL expression>
  
```

The `Provenance` transform is added as a child to the top-most transform, which is usually a `Merge` or a `Chain`, using a `Combo`.

Behavior

The `Provenance` transform ignores its input and outputs a single resource named `accelerator-info.yaml`. For example:

```
id: <unique GUID of invocation>
timestamp: <timestamp in RFC3339 format>
username: <captured username of user triggering the run>
source: <client environment from which accelerator was run>
accelerator:
  name: <name of registered accelerator>
  git:
    url: <git repository location>
    ref:
      branch: <branch name> or
      tag: <tag name> or
      commit: <specific requested commit>
    subPath: <optional subpath inside the repo>
    commit: <actual SHA the branch or tag pointed to>
  fragments:
    - name: <name of registered fragment 1>
      git:
        url: <git repository location>
        ref:
          branch: <branch name> or
          tag: <tag name> or
          commit: <specific requested commit>
        subPath: <optional subpath inside the repo>
        commit: <actual SHA the branch or tag pointed to>
    - name: <name of registered fragment 2>
      git:
        url: <git repository location>
        ref:
          branch: <branch name> or
          tag: <tag name> or
          commit: <specific requested commit>
        subPath: <optional subpath inside the repo>
        commit: <actual SHA the branch or tag pointed to>
    - ...
  options:
    - name: <option name>
      value: <option value>
    - name: <option name>
      value: <option value>
```



Note

Depending on the invocation scenario, some pieces of data might not be present.

Use SpEL with Application Accelerator

This topic tells you about some common Spring Expression Language (SpEL) use cases for the `accelerator.yaml` file in Application Accelerator.

For more information, see [Spring Expression Language](#) documentation.

Variables

You can reference all the values added as options in the `accelerator` section from the YAML file as variables in the `engine` section. You can access the value using the syntax `#<option name>`:

```
options:
  - name: foo
    dataType: string
    inputType: text
  ...
engine:
  - include: ["some/file.txt"]
    chain:
      - type: ReplaceText
        substitutions:
          - text: bar
            with: "#foo"
```

This sample replaces every occurrence of the text `bar` in the file `some/file.txt` with the contents of the `foo` option.

Implicit variables

Some variables are made available to the model by the engine, including:

- `artifactId` is a built-in value derived from the `projectName` passed in from the UI with spaces replaced by “_”. If that value is empty, it is set to `app`.
- `files` is a helper object that currently exposes the `contentsOf(<path>)` method. For more information, see [ReplaceText](#).
- `camel2Kebab` and other variations of the form `xxx2Yyyy` is a series of helper functions for dealing with changing case of words. For more information, see [ReplaceText](#).

Conditionals

You can use Boolean options for conditionals in your transformations.

```
options:
  - name: numbers
    inputType: select
    choices:
      - text: First Option
        value: first
      - text: Seconf Option
        value: second
    defaultValue: first
  ...
engine:
  - include: ["some/file.txt"]
    condition: "#numbers == 'first'"
    chain:
      - type: ReplaceText
        substitutions:
          - text: bar
            with: "#foo"
```

This replaces the text only if the selected option is the first one.

Rewrite path concatenation

```
options:
  - name: renameTo
    dataType: string
    inputType: text
  ...
```



```
engine:
  - include: ["some/file.txt"]
  chain:
    - type: RewritePath
      rewriteTo: "'somewhere/' + #renameTo + '.txt'"
```

Regular expressions

Regular expressions allow you to use patterns as a matcher for strings. Here is a small example of what you can do with them:

```
options:
  - name: foo
    dataType: string
    inputType: text
    defaultValue: abcZ123
  ...
engine:
  - include: ["some/file.txt"]
    condition: "#foo.matches('[a-z]+Z\d+')"
    chain:
      - type: ReplaceText
        substitutions:
          - text: bar
            with: "#foo"
```

This example uses RegEx to match a string of letters that ends with a capital Z and any number of digits. If this condition is fulfilled, the text is replaced in the file, `file.txt`.

Dealing with string arrays

Options with a `dataType` of `[string]` come out as an array of strings.

To use them and for example format the result as a bulleted list, you can use the Java static `String.join()` method. For example:

```
accelerator:
  options:
    - name: meals
      dataType: [string]
      inputType: checkbox
      choices:
        - value: fish
        - value: chips
        - value: BLT
    ...
  engine:
    type: ReplaceText
    substitutions:
      - text: recipe
        with: "' * ' + T(java.lang.String).join('\n * ', #meals)'"
```

Accelerator custom resource definition

This topic tells you about the Application Accelerator custom resource definition.

Overview

The `Accelerator` custom resource definition (CRD) defines any accelerator resources to be made available to the Application Accelerator for VMware Tanzu system. It is a namespaced CRD, meaning that any resources created belong to a namespace. For the resource to be available to the Application Accelerator system, it must be created in the namespace that the Application Accelerator UI server is configured to watch.

The `Fragment` custom resource definition (CRD) defines any accelerator fragment resources to be made available to the Application Accelerator for VMware Tanzu system. It is a namespaced CRD, meaning that any resources created belong to a namespace. For the resource to be available to the Application Accelerator system, it must be created in the namespace that the Application Accelerator UI server is configured to watch.

API definitions

The `Accelerator` CRD is defined with the following properties:

Property	Value
Name	Accelerator
Group	accelerator.apps.tanzu.vmware.com
Version	v1alpha1
ShortName	acc

Accelerator CRD Spec

The `Accelerator` CRD *spec* defined in the `AcceleratorSpec` type has the following fields:

Field	Description	Required/Optional
<code>displayName</code>	A short descriptive name used for an Accelerator.	Optional (*)
<code>description</code>	A longer description of an Accelerator.	Optional (*)
<code>iconUrl</code>	A URL for an image to represent the Accelerator in a UI.	Optional (*)
<code>tags</code>	An array of strings defining attributes of the Accelerator that can be used in a search.	Optional (*)
<code>git</code>	Defines the accelerator source Git repository.	Optional (***)
<code>git.url</code>	The repository URL, can be a HTTP/S or SSH address.	Optional (***)
<code>git.gitImplementation</code>	Determines which git client library to use. The default setting is to go-git. Valid values are ('go-git').	Optional (**)
<code>git.ignore</code>	Overrides the set of excluded patterns in the <code>.sourceignore</code> format (which is the same as <code>.gitignore</code>). If not provided, a default of <code>.git/</code> is used.	Optional (**)
<code>git.interval</code>	The interval at which to inquire for repository updates. If not provided the default setting is 10 minutes. There is an additional refresh interval (currently 10s) involved before accelerators can appear in the UI. There might be a 10s delay before changes are reflected in the UI.*	Optional (**)
<code>git.ref</code>	Git reference to checkout and monitor for changes, the default is main branch.	Optional (**)
<code>git.ref.branch</code>	The Git branch to checkout, the default is main.	Optional (**)
<code>git.ref.commit</code>	The Git commit SHA to checkout, if specified tag filters are ignored.	Optional (**)

Field	Description	Required/Optional
git.ref.semver	The Git tag semver expression, takes precedence over tag.	Optional (**)
git.ref.tag	The Git tag to checkout, takes precedence over branch.	Optional (**)
git.secretRef	The secret name containing the Git credentials. For HTTPS repositories, the secret must contain user name and password fields. For SSH repositories, the secret must contain identity, identity.pub, and known_hosts fields.	Optional (**)
git.subPath	SubPath is the folder inside the git repository to consider as the root of the accelerator or fragment. Defaults at the root of the repository.	Optional
source	Defines the source image repository.	Optional (***)
source.image	Image is a reference to an image in a remote registry.	Optional (***)
source.imagePullSecrets	ImagePullSecrets contains the names of the Kubernetes Secrets containing registry login information to resolve image metadata	Optional
source.interval	The interval at which to check for repository updates.	Optional
source.serviceAccountName	ServiceAccountName is the name of the Kubernetes ServiceAccount used to authenticate the image pull if the service account has attached pull secrets	Optional

The `Fragment` CRD is defined with the following properties:

Property	Value
Name	Fragment
Group	accelerator.apps.tanzu.vmware.com
Version	v1alpha1
ShortName	frag

Fragment CRD Spec

The `Fragment` CRD *spec* defined in the `FragmentSpec` type has the following fields:

Field	Description	Required/Optional
displayName	DisplayName is a short descriptive name used for a Fragment.	Optional
git	Defines the fragment source Git repository.	Required
git.url	The repository URL, can be a HTTP/S or SSH address.	Required
git.gitImplementation	Determines which git client library to use. The default setting is to go-git. Valid values are ('go-git', 'libgit2'). Deprecated: gitImplementation is deprecated. go-git is the only supported implementation.	Optional (**)
git.ignore	Overrides the set of excluded patterns in the .sourceignore format (which is the same as .gitignore). If not provided, a default of .git/ is used.	Optional (**)
git.interval	The interval at which to inquire for repository updates. If not provided the default is 10 min.	Optional (**)
git.ref	Git reference to checkout and monitor for changes, the default is main branch.	Optional (**)

Field	Description	Required/Optional
git.ref.branch	The Git branch to checkout, defaults to main.	Optional (**)
git.ref.commit	The Git commit SHA to checkout, if specified tag filters are ignored.	Optional (**)
git.ref.semver	The Git tag semver expression, takes precedence over tag.	Optional (**)
git.ref.tag	The Git tag to checkout, takes precedence over branch.	Optional (**)
git.secretRef	The secret name containing the Git credentials. For HTTPS repositories, the secret must contain user name and password fields. For SSH repositories, the secret must contain identity, identity.pub, and known_hosts fields.	Optional (**)
git.subPath	SubPath is the directory inside the Git repository to consider as the root of the accelerator or fragment. Defaults at the root of the repository.	Optional

* Any optional text boxes marked with an asterisk (*) are populated from a text box of the same name in the `accelerator` definition in the `accelerator.yaml` file if that is present in the Git repository for the accelerator.

** Any fields marked with a double asterisk (**) are part of the Flux GitRepository CRD that is documented in the Flux Source Controller [Git Repositories](#) documentation.

*** Any fields marked with a triple asterisk (***) are optional but either `git` or `source` is required to specify the repository to use. If `git` is specified, the `git.url` is required, and if `source` is specified, `source.image` is required.

Excluding files

The `git.ignore` field defaults to `.git/`, which is different from the defaults provided by the Flux Source Controller GitRepository implementation. You can override this, and provide your own exclusions. For more information, see [fluxcd/source-controller Excluding files](#).

Test accelerators in Application Accelerator

This topic tells you how to test an updated accelerator or fragment that is not registered in your Tanzu Application Platform (commonly known as TAP) cluster.

Generate a project from local sources

When you are authoring your accelerator, you can test it before committing any changes.

With the `tanzu accelerator generate-from-local` command, you can run your accelerator (or fragment), including any changes you have locally, specify a set of options and view the generated project.

You can run the accelerator using the components on your Tanzu Application Platform cluster, without impacting the state of the Tanzu Application Platform cluster.

To do so, ensure that you have the following prerequisites:

- The Tanzu CLI is installed, with the Application Accelerator plug-in. For details about installing the Tanzu CLI and plug-ins, see [Tanzu CLI](#).
- The server URL is pointing to the Tanzu Application Platform cluster you want to test with. For details about setting the server URL, see [Application Accelerator CLI plug-in overview](#).

For example, to use the accelerator that is located at the path `workspace/java-rest`:

```
tanzu accelerator generate-from-local --accelerator-path java-rest=workspace/java-rest \
\
--fragment-names tap-workload,java-version --options '{"projectName":"test"}' --output
-dir \
generated-project
```

This generates the project in the local directory `generated-project`, using the accelerator located at `workspace/java-rest`, the fragments `tap-workload` and `java-version` which are assumed to be already registered in the Tanzu Application Platform cluster and the option `projectName` set to `test`.

For example, to use the fragment named `java-version` that is located at the path `workspace/version`:

```
tanzu accelerator generate-from-local --accelerator-name java-rest --fragment-paths \
java-version=workspace/version --fragment-names tap-workload --options '{"projectName":"test"}' \
--output-dir generated-project
```

This generates the project in the local directory `generated-project`, using the accelerator `java-rest` and the fragment `tap-workload` which are assumed to be already registered in the Tanzu Application Platform cluster, the fragment named `java-version` located at `workspace/version`, and the option `projectName` set to `test`.

For the full documentation for the `generate-from-local` command, see reference [Tanzu accelerator generate-from-local](#).

No changes are made to the Tanzu Application Platform cluster that is provided with the server URL. No new accelerators/fragments are registered or modified. A Tanzu Application Platform cluster is required to ensure that there is consistency between the version that is used for testing and the version that is used when the accelerator is registered. Furthermore, it allows using registered fragments and accelerators as dependencies for the local accelerator/fragment.

CI/CD Pipeline

As you iterate on an accelerator, you can have some automated assertions run before any changes to the accelerator are accepted.

The process for generating a project from the committed source files is the same as described earlier.

When the generated project is available, run various assertions on it by running:

```
cd generated-project
test -f build.gradle
./gradlew test
```

If you have multiple assertions, you can use a predefined script by running:

```
cd generated-project
../assertions/validate-generate-project.sh
```

You can generate multiple projects from the same accelerator, providing different options for each accelerator and running different assertions on each generated project.

Add the Tanzu CLI to a CI/CD pipeline

If the Tanzu CLI is already available in your CI/CD pipeline, skip this section.

To add the Tanzu CLI to a CI/CD pipeline:

1. Follow the steps in [Installing the Tanzu CLI](#). Install the binary file that matches the operating system and architecture that you use in your CI.
2. From your CI script, install the `accelerator` plug-in by running these commands:

```
tanzu config eula accept
tanzu ceip-participation set false
tanzu init
tanzu plugin install accelerator --target kubernetes
```

Use the Provenance transform in Application Accelerator

This topic tells you about the Application Accelerator `Provenance` transform in Tanzu Application Platform (commonly known as TAP).

The `Provenance` transform is a special transform used to generate a file that provides details of the accelerator engine transform.

The `Provenance` transform provides traceability and visibility into the generation of an application from an accelerator. The following information is embedded into a file that is part of the generated project:

- Which accelerator was used to bootstrap the project
- Which version of the accelerator was used
- When the application was bootstrapped
- Who bootstrapped the application

For more information on the structure of the file and how to enable application bootstrapping provenance, see [Provenance transform](#).

Use the Application Accelerator Visual Studio Code extension

This topic describes how to use the Application Accelerator Visual Studio Code extension to explore and generate projects from the defined accelerators in Tanzu Application Platform (commonly known as TAP) using VS Code.

The Application Accelerator Visual Studio Code extension lets you explore and generate projects from the defined accelerators in Tanzu Application Platform using VS Code.

Dependencies

- To use the VS Code extension, the extension must access the Tanzu Developer Portal (formerly named Tanzu Application Platform GUI) URL. For information about how to retrieve the Tanzu Developer Portal URL, see [Retrieving the URL for the Tanzu Developer Portal](#).
- (Optionally) To use Git repository provisioning during project creation in the VS Code extension, you must enable GitHub repository creation in the Application Accelerator plug-in. For more information, see [Create an Application Accelerator Git repository during project creation](#).

Install the extension

Use the following steps to install the Application Accelerator Visual Studio Code extension:

1. Open Visual Studio Code.

2. Open the command palette and enter `Extensions`.
3. Click **Extensions: Install Extensions**.
4. The **Extensions** view opens on the left side of your screen. In the search box, enter `Tanzu`.
5. Click **Tanzu App Accelerator**.
6. Click **Install**.

Configure the extension

Before using the extension, you need follow the next steps:

1. Go to VS Code settings - click **Code > Preferences > Settings > Extensions > Tanzu App Accelerator**.
2. Look for the setting `Tap Gui Url`.
3. Add the Tanzu Application Platform GUI URL.

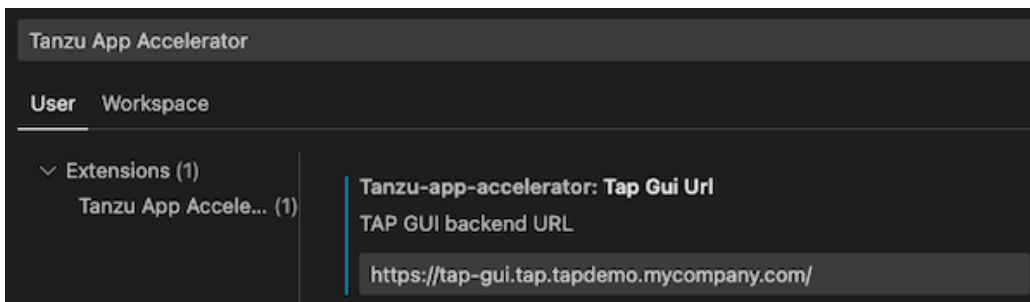

An example URL: `https://tap-gui.myclusterdomain.myorg.com`. If you have access to the Tanzu Application Platform cluster that is running the Tanzu Developer Portal, you can run the following command to determine the fully-qualified domain name:

```
kubectl get httpproxy tap-gui -n tap-gui
```

Using the extension

To use the VS Code extension:

1. Click the Tanzu Application Accelerator extension icon in the Activity Bar to explore the defined accelerators.

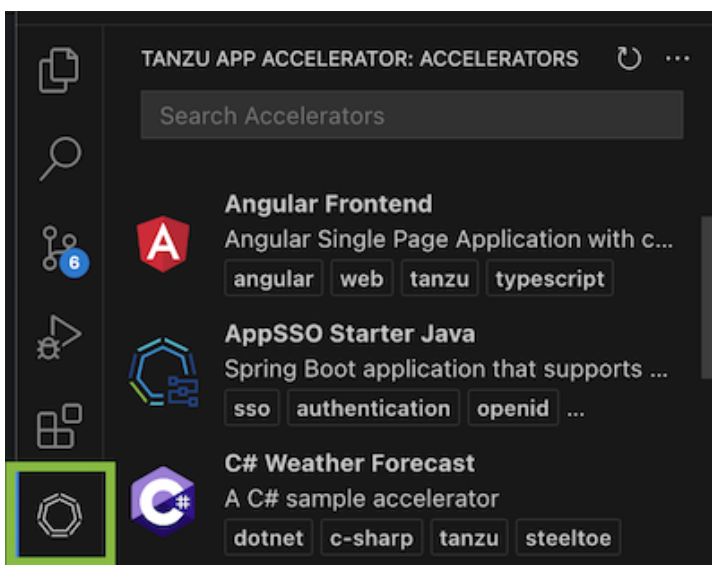

- Choose any of the defined accelerators, fill in the options under **Configure Accelerator**, and click **Next**.

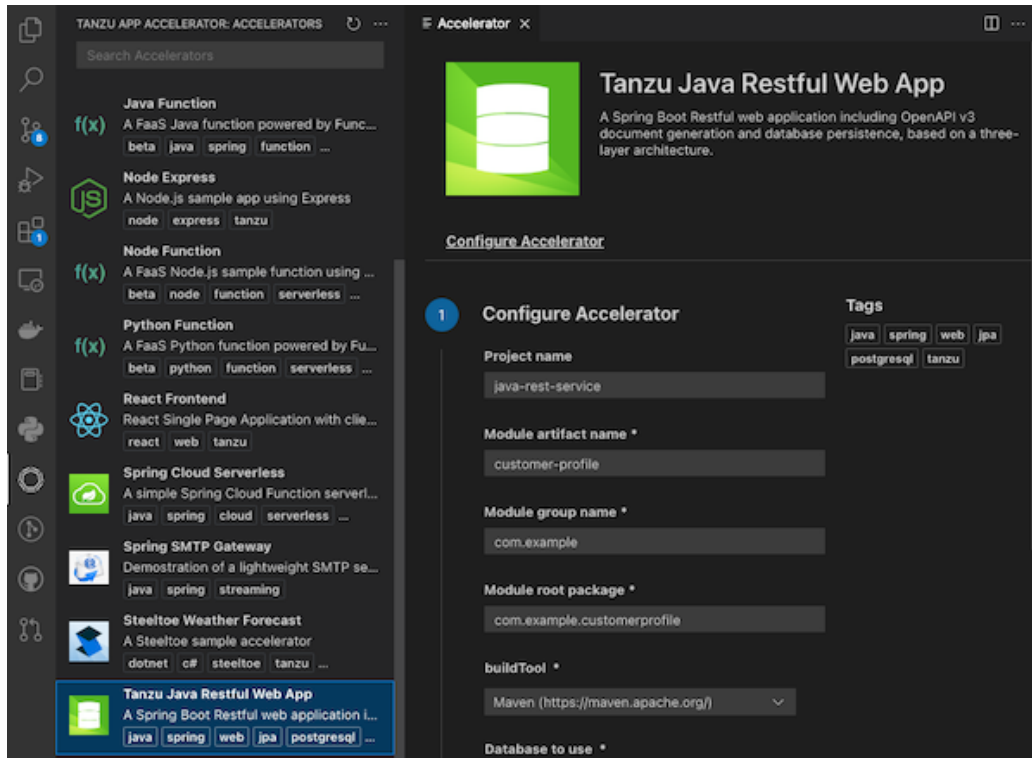

- Review your settings and click **Generate Project**.

Retrieving the URL for the Tanzu Developer Portal

If you have access to the Tanzu Application Platform cluster that is running Tanzu Developer Portal, run the following command to determine the fully-qualified domain name:

```
kubectl get httpproxy tap-gui -n tap-gui
```

Example output:

NAME	FQDN	TLS SECRET	STATUS	STATUS DES
tap-gui	tap-gui.tap.tapdemo.myorg.com	tap-gui-cert	valid	Valid HTTP Proxy

Download and Install Self-Signed Certificates from the Tanzu Developer Portal

To enable the Application Accelerator extension for VS Code to communicate with a Tanzu Developer Portal instance that is secured using TLS, you must download and install the certificates locally.

Prerequisites

`yq` is required to process the YAML output.

Procedure

1. Find the name of the Tanzu Developer Portal certificate. The name of the certificate might look different to the following example.

```
kubectl get secret -n cert-manager
```

NAME	DATA	AGE	TYPE
canonical-registry-secret			kubernetes.io/dockerconfigjson
1		18d	
cert-manager-webhook-ca			Opaque
3		18d	
postgres-operator-ca-certificate			kubernetes.io/tls
3		18d	
tanzu-sql-with-mysql-operator-ca-certificate			kubernetes.io/tls
3		18d	
tap-ingress-selfsigned-root-ca			kubernetes.io/tls
3		18d	<----- This is the certificate that is needed

2. Download the certificate:

```
kubectl get secret -n cert-manager tap-ingress-selfsigned-root-ca -o yaml | yq '.data."ca.crt"' | base64 -d > ca.crt
```

3. Install the certificate on your local system and fully restart any applications that uses the certificate. After restarting, the application uses the certificate to communicate with the endpoints using TLS. For more information, see [Installing a root CA certificate in the trust store](#) in the Ubuntu documentation.

macOS

Run:

```
sudo security add-trusted-cert -d -r trustRoot -k /Library/Keychains/System.legacychain ca.crt
```

Windows

Complete the following steps:

1. Use Windows Explorer to navigate to the directory where the certificate was downloaded and click on the certificate.
2. In the Certificate window, click **Install Certificate...**
3. Change the **Store Location** from **Current User** to **Local Machine**. Click **Next**.
4. Select **Place all certificates in the following store**, click **Browse**, and select **Trusted Root Certification Authorities**
5. Click **Finish**.
6. A pop-up window stating **The import was successful.** is displayed.

Use the Application Accelerator IntelliJ plug-in

This topic tells you about the Application Accelerator IntelliJ plug-in. The plug-in is used to explore and generate projects from the defined accelerators in Tanzu Application Platform (commonly called TAP) using IntelliJ.

Dependencies

The plug-in must have access to the Tanzu Developer Portal (formerly named Tanzu Application Platform GUI) URL. For information about how to retrieve the Tanzu Developer Portal URL, see [Retrieving the URL for the Tanzu Developer Portal](#).

Install the plug-in

The VMware Tanzu Application Accelerator plug-in for IntelliJ is available from the [JetBrains Marketplace](#).

To install the plug-in from the JetBrains Marketplace:

1. Open IntelliJ.
2. Open the command palette, enter `Plugins`, and click **Plugins**.
3. Select the **Marketplace** tab in the **Plugins Settings** dialog box.
4. In the search box, enter `Tanzu`.
5. Click **Tanzu Application Accelerator** then click **Install**.

Configure the plug-in

Before using the plug-in, you must enter the Tanzu Developer Portal URL in the IntelliJ Preferences:

1. Go to the IntelliJ menu, select **IntelliJ IDEA > Preferences > Tools > Tanzu Application Accelerator**.
2. Add the Tanzu Developer Portal URL. For example, `https://tap-gui.myclusterdomain.myorg.com`. If you have access to the Tanzu Application Platform cluster that is running the Tanzu Developer Portal, run the following command to determine the fully-qualified domain name:

```
kubectl get httpproxy tap-gui -n tap-gui
```

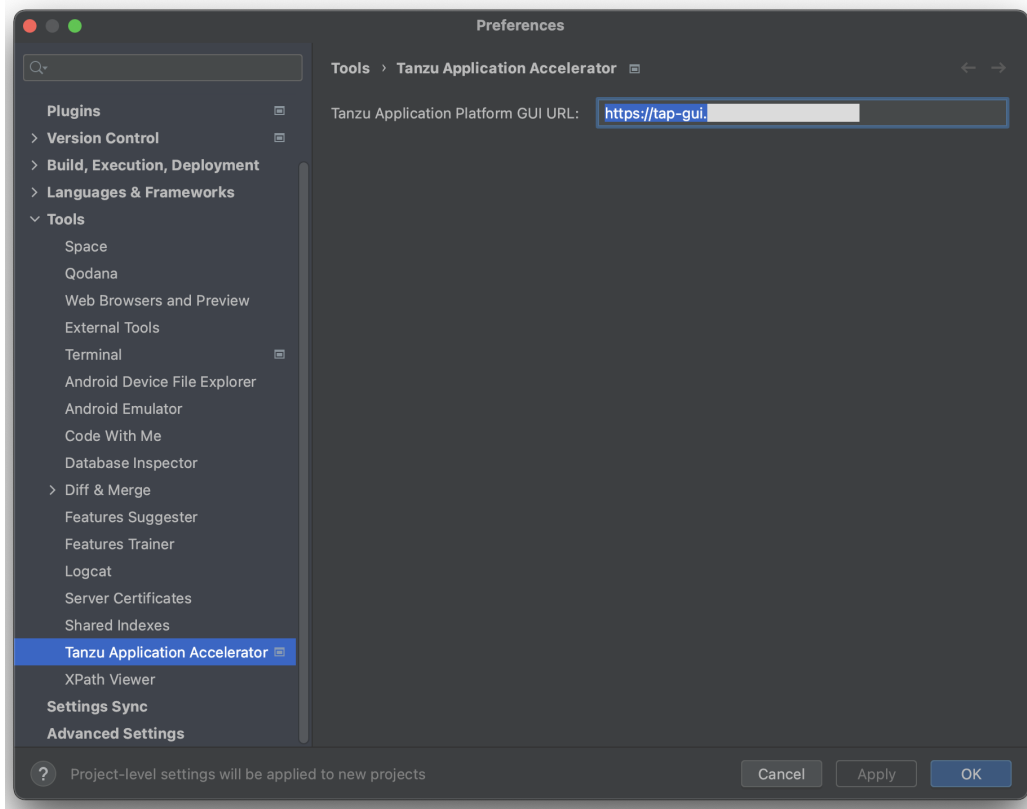

3. Click **Apply** and **OK**.

Use the plug-in

To use the IntelliJ plug-in:

1. To explore the defined accelerators, select **New Project**, then select **Tanzu Application Accelerator**.

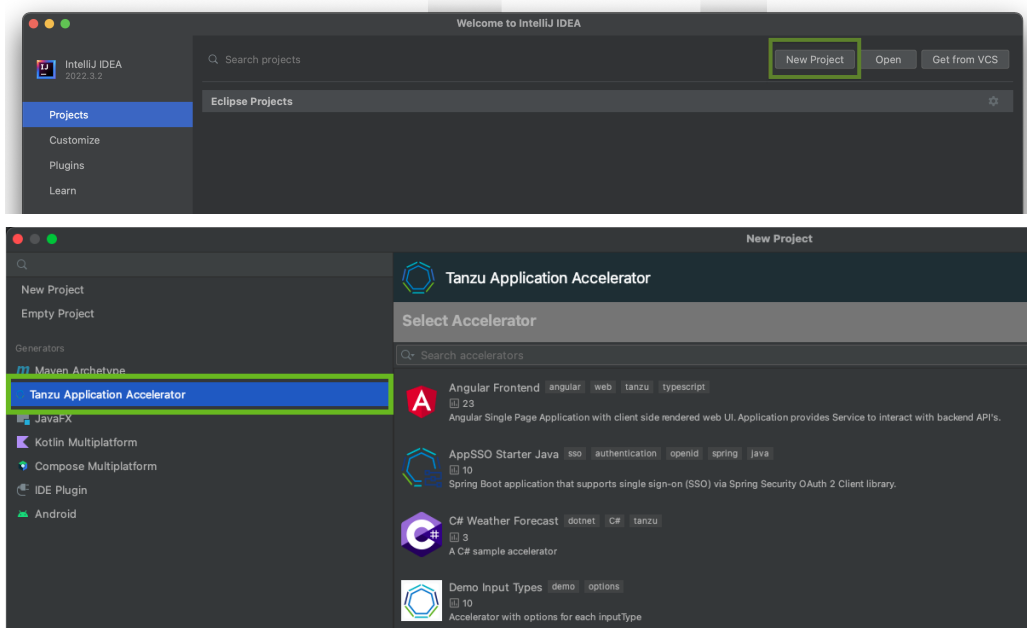

2. Choose one of the defined accelerators and configure the options.

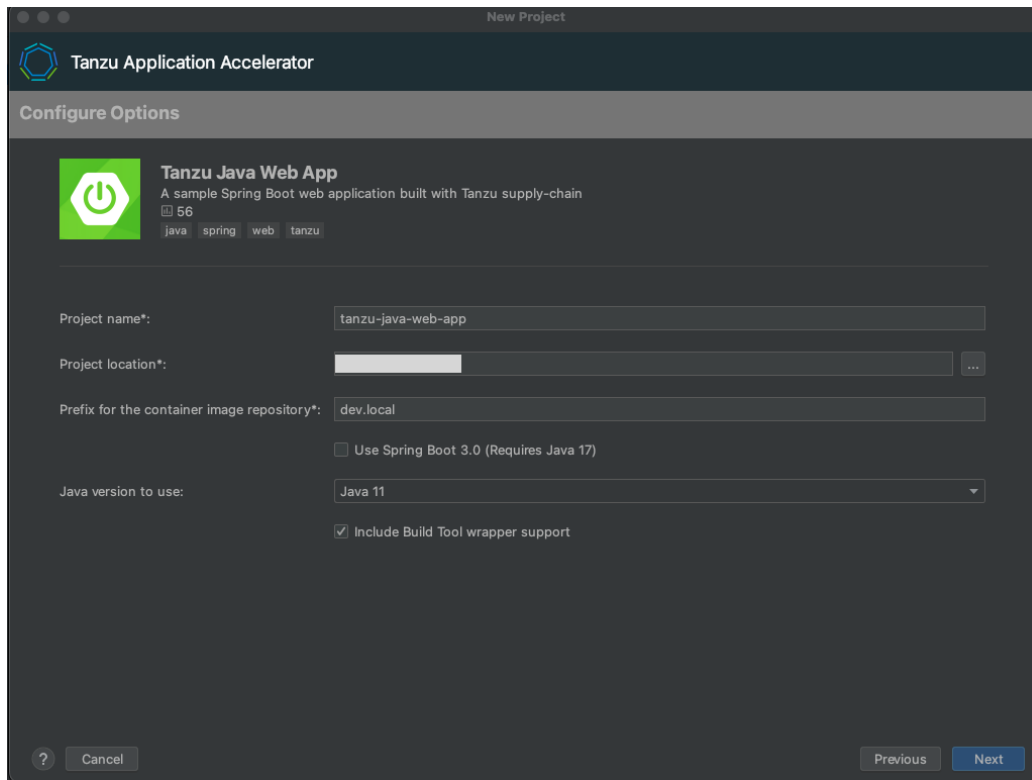

3. Click **Next** to go to the optional step `create git repository`.

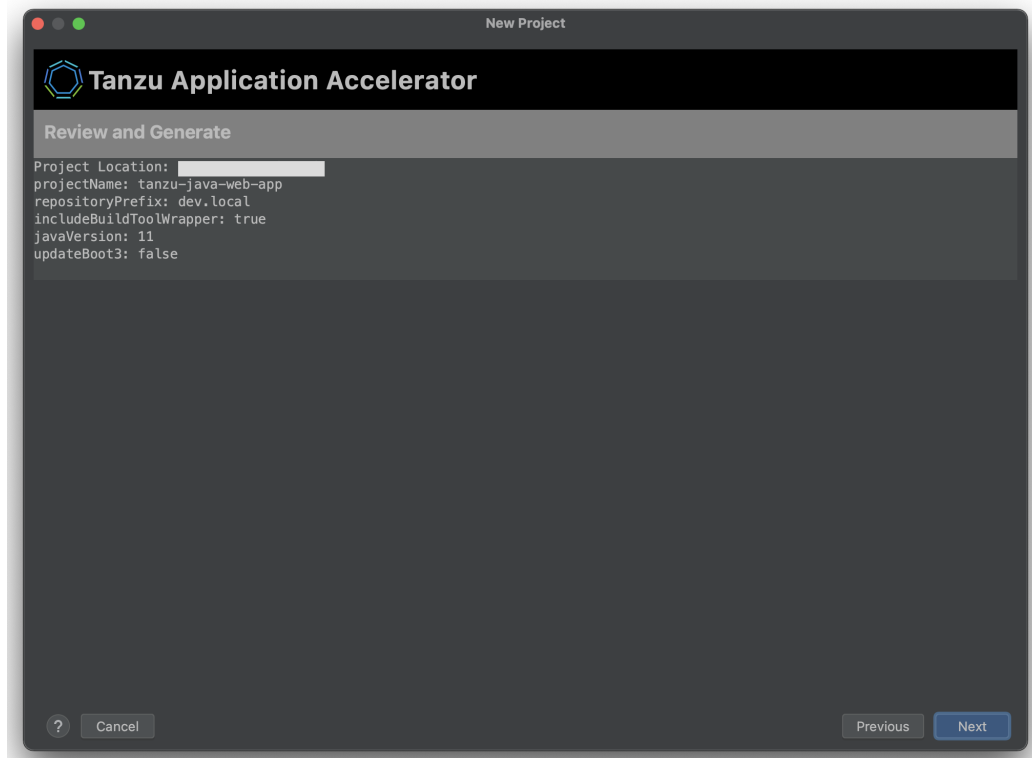

4. Fill the fields required to create the Git repository, a personal access token from the Git provider is required, this will be stored in a secured location for future use, click **Next** to go to the review step.

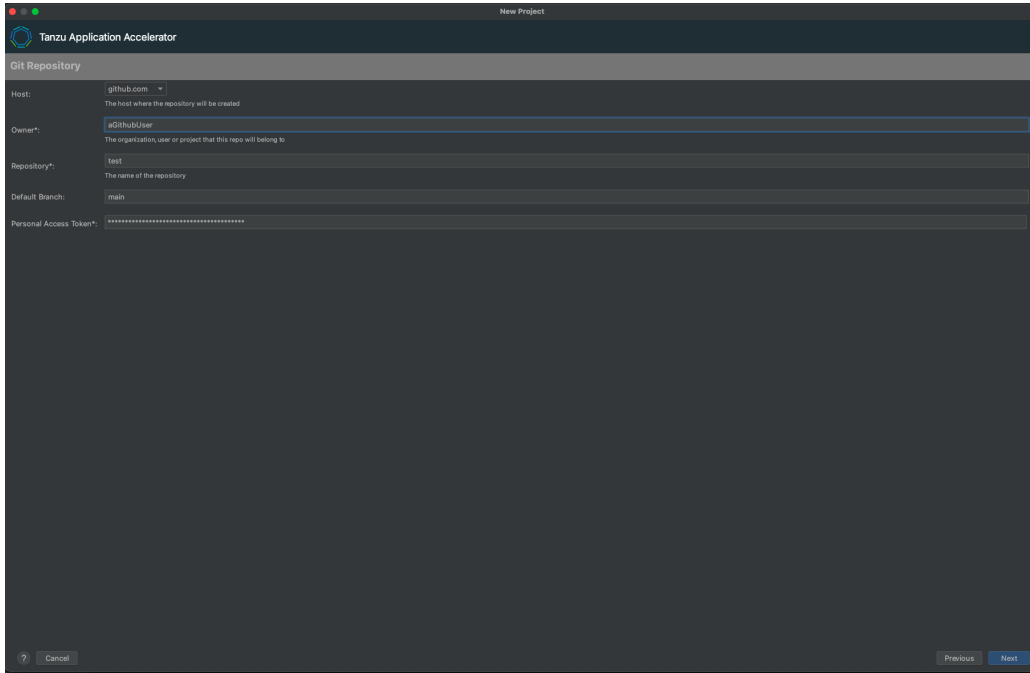

Note: This is an optional step, the values can be left blank if a repository isn't required.

5. Click **Next** to download the project. If the project is downloaded successfully, the **Create** button is enabled and you can now create and open the project.

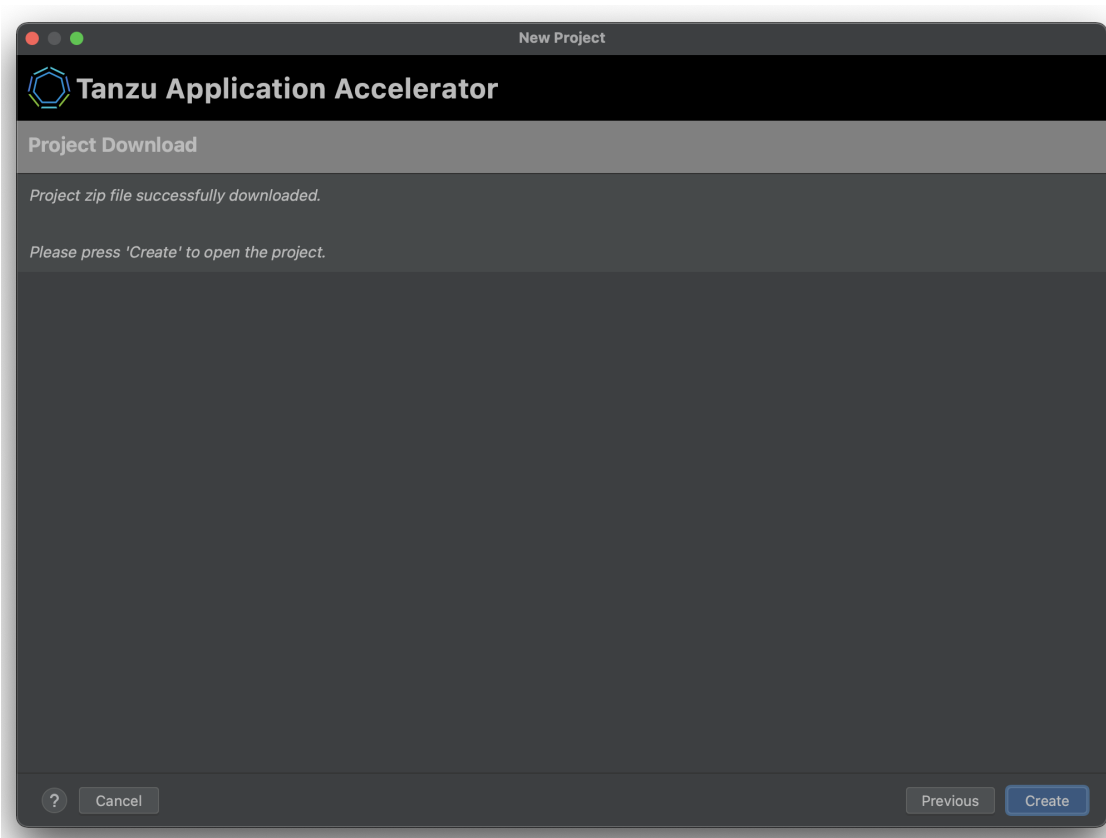

Retrieving the URL for the Tanzu Developer Portal

If you have access to the Tanzu Application Platform cluster that is running the Tanzu Application Platform GUI, run the following command to determine the fully-qualified domain name:

```
kubectl get httpproxy tap-gui -n tap-gui
```

The result is similar to:

NAME	FQDN	TLS SECRET	STATUS	STATUS DES
DESCRIPTION				
tap-gui	tap-gui.tap.tapdemo.myorg.com	tap-gui-cert	valid	Valid HTTP
Proxy				

Download and Install Self-Signed Certificates

To enable communication between the Application Accelerator plug-in and a Tanzu Application Platform GUI instance that is secured using TLS, you must download and install the certificates locally.

Prerequisites

`yq` is required to process the YAML output.

Procedure

1. Find the name of the Tanzu Developer Portal certificate. The name of the certificate might look different to the following example.

```
kubectl get secret -n cert-manager
```

For example:

NAME	DATA	AGE	TYPE
canonical-registry-secret	1	18d	kubernetes.io/dockerconfigjson
cert-manager-webhook-ca	3	18d	Opaque
postgres-operator-ca-certificate	3	18d	kubernetes.io/tls
tanzu-sql-with-mysql-operator-ca-certificate	3	18d	kubernetes.io/tls
tap-ingress-selfsigned-root-ca	3	18d	kubernetes.io/tls
	3	18d	<----- This is the certificate that is needed

2. Download the certificate:

```
kubectl get secret -n cert-manager tap-ingress-selfsigned-root-ca -o yaml | yq
'.data."ca.crt"' | base64 -d > ca.crt
```

3. Install the certificate on your local system and restart any applications that use the certificate. After restarting, the application uses the certificate to communicate with the endpoints using TLS.

macOS

Run:

```
sudo security add-trusted-cert -d -r trustRoot -k /Library/Keychains/System.k
eychain ca.crt
```

For more information, see [Installing a root CA certificate in the trust store](#) in the Ubuntu documentation.

Windows

Complete the following steps:

1. Use Windows Explorer to navigate to the directory where the certificate was downloaded and select the certificate.
2. In the Certificate window, click **Install Certificate...**
3. Change the **Store Location** from **Current User** to **Local Machine**. Click **Next**.
4. Select **Place all certificates in the following store**, click **Browse**, and select **Trusted Root Certification Authorities**
5. Click **Finish**.
6. A pop-up window stating **The import was successful.** is displayed.

Application Accelerator best practices

The following topics tell you about best practices for authoring accelerators and fragments.

- [Best practices for using Accelerators](#)
A collection of best practices for authoring accelerators.
- [Best practices for using Fragments](#)
A collection of best practices for authoring fragments.

Best practices for using accelerators

This topic tells you about the benefits, and design considerations for accelerators.

Benefits of using an accelerator

There are several good reasons to develop accelerators:

- If you're repeatedly using the same application architecture for new applications.
- To enforce standardization of technology stacks and application setups throughout your organization.
- To share best practices around application architecture, application, and test setup.

Design considerations

Each accelerator must have only one base technology stack, combined with related tooling, and one target architecture. For example, if you use both Spring Boot and C# .NET Core applications in your target environment, you must set up two separate accelerators. Mixing multiple technology stacks and multiple target architectures makes both the directory structure and acceleratory.YAML unreadable.

The scope of your accelerator must align with your different types of deployments. For example, back-end API, front-end UI, business service, and so on.

Choose OpenRewrite-based transformation over ReplaceText-based transformation when possible. OpenRewrite-based transformations understand the semantics of the files they work on, for example, Maven pom.xml or Java source files. OpenRewrite-based transformations also provide more accurate and robust modifications. As a last resort, ReplaceText supports a regex mode. When used with capturing groups in the replacement string, ReplaceText allows most modifications.

Housekeeping rules

VMware has found that the following rules keep the set of accelerators clear and findable for end users:

- Use an intuitive name and short description that reflects the accelerators purpose. The word ‘accelerator’ must not be in the name.
- Use an appropriate and intuitive icon.
- Use tags that reflect language, framework, and type of service. For example, database, messaging, and so on. This helps when searching for an accelerator by tags. Tag names must use lowercase letters, consist of [a-z0-9+#] separated by [-], and not exceed 63 characters.
- Accelerators must expose options to allow configuring an accelerator for different use cases instead of creating multiple similar accelerators.
- Options must be straightforward, the description of each clearly stating the role it plays in the accelerator. Options must have default values when appropriate.
- Options must be short so that they are easy to navigate. Make options conditional on other options as appropriate.
- Free text options that have limitations on their values must ensure these limitations are met by a regular expression-based validation. This validation ensures early feedback on invalid user input.
- Generated application skeletons must have a detailed README file that describes the function and structure of a generated application. It must provide detailed information about how developers can build and deploy a generated application of the accelerator and how to use it.

Tests

Application skeleton

An accelerator that generates an application skeleton without a good test suite for the different layers of the application promotes bad behavior. It could result in code running in production without testing.

Tests you could use for the application skeleton:

- An overall application test that bootstraps the application to see if it comes online.
- A test per layer of the application. For example, presentation layer, business layer, and data layer. These tests can be unit tests that leverage stubbing or mocking frameworks.
- An integration test per layer of the application, especially the presentation and data layer. For example, you can provide an integration test with some database interaction by using [test containers](#).

Best practices for using fragments

This topic tells you about the benefits, and design considerations for fragments.

Benefits of using Fragment

A fragment is a partial accelerator. It can do the same transformations as an accelerator, but it cannot run on its own. It’s always part of the calling (host) accelerator.

Developing a fragment is useful in the following situations:

- When you must update a version of an element of a technology stack in multiple locations. For example, when the Java Development Kit (JDK) version must be updated in the build tool configuration, the buildpack configuration, and in the deployment options.
- To add a consistent cross-cutting concern to a set of accelerators. For example, logging, monitoring, or support for a certain type of deployment or framework.
- To add integration with some technology to a generated application skeleton. For example, certain database support, support for a messaging middleware, or integration with an email provider.

Design considerations

Developing and maintaining a fragment is complex. The following is a list of design considerations:

- The fragment you develop must work with all possible syntax and format variations. For example, dependency in a `Gradle` `build.gradle.kts` can have the following forms:
 - `implementation('org.springframework.boot:spring-boot-starter')`
 - `implementation("org.springframework.boot:spring-boot-starter")`
 - `implementation(group = "org.springframework.boot", name= "spring-boot-starter")`
 - `implementation(group = 'org.springframework.boot', name= 'spring-boot-starter')`
 - `implementation(name= "spring-boot-starter", group = "org.springframework.boot")`
- The fragment can be used in multiple accelerator contexts and its behavior must result in a compilable and deployable application skeleton.
- Testing a fragment in isolation is more difficult than testing an accelerator. Testing takes more time because all the combinations must be tested from an accelerator perspective.
- When flexibly reusing fragments in different combinations, each fragment must cover a small, cohesive function. Fragments must follow these two UNIX principles:
 - Small is beautiful.
 - Each fragment does one thing well.
- Keep the files the fragment changes to a minimum. Only change the files that are related to the same technology stack for the same purpose.
- The design of both the accelerator and fragment is limited by the technology stack and the target deployment technology chosen for the accelerator. For example, to create a fragment for standardizing logging, you must create one fragment per base technology stack.

Housekeeping rules

Fragments are used by accelerator authors. VMware has found that the following guidelines keep fragments understandable and reusable.

- Give fragments an intuitive name and short description that reflects their purpose. Do not include “fragment” in the name.
- Fragments must expose options to allow configuring the output of execution.

- Each fragment must contain a README file explaining the additional functions the fragment adds to a generated application skeleton. List any options expected by this fragment. Also describe how this fragment can be included in a host accelerator. Be sure to state any known limitations or use cases not covered. For example, if the fragment supports Maven and Gradle as build tools but only Groovy DSL of Gradle is supported, the README file must include this information.
- If a fragment must provide additional documentation to end users, it can either be added to a README-X file of the generated application skeleton or append a section to the host's README.

Versioning

Fragments might require the use of versioning. For example, if accelerator `acc-1` imports fragment `frag`, and accelerator `acc-2` also uses fragment `frag`, then care must be taken in the contract that the fragment exposes. Changing its behavior for the benefit of `acc-1` might break its use in `acc-2`.

To resolve this, you can track the versions of the fragment and document with numbers when there is an incompatible change. VMware recommends that you use [semantic versioning](#) to track the contract for fragments.

To give you more flexibility with version control, Application Accelerator does not manage versioning. VMware recommends that you track the semantic version of fragments in the fragment name. For example, if fragment `frag` changes its contract in a way that is not compatible with previous accelerators that use it, it becomes `frag-v2` and is regarded as a different fragment.

You can store fragment versions where you want, but version control systems such as Git are a good choice.

Troubleshoot Application Accelerator

This topic provides troubleshooting steps for development, accelerator authorship, and operations issues in Application Accelerator.

Installation issues

Depending on the error output, you can take the following actions to troubleshoot installation problems.

Verify installed packages

The package might be already installed. Verify this by running:

```
tanzu package installed list -n tap-install
```

Look for any package called `accelerator.apps.tanzu.vmware.com`.

Look at resource events

The error might be within the custom resources such as accelerator, Git repository, fragment, and so on. Find these errors by using the Kubernetes command line interface tool (kubectl).

Here is an example using the custom resource `accelerator`:

1. Check for errors. For example, review the custom resource `accelerator` by running:

```
kubectl get acc -n accelerator-system
```

Note items in the output with a **READY** status **False**:

NAME	READY	REASON	AGE
appsso-starter-java	True	Ready	5h2m
where-for-dinner	True	Ready	5h2m
java-function	True	Ready	5h2m
java-rest-service	True	Ready	5h2m
java-server-side-ui	True	Ready	5h2m
node-express	True	Ready	5h2m
node-function	False	Not-Ready	5h2m
python-function	True	Ready	5h2m
spring-cloud-serverless	True	Ready	5h2m
spring-smtp-gateway	True	Ready	5h2m
tanzu-java-web-app	True	Ready	5h2m
tap-initialize	True	Ready	5h2m
weatherforecast-csharp	True	Ready	5h2m
weatherforecast-steeltoe	True	Ready	5h2m

2. To see more information about any error events you found, run:

```
kubectl get acc node-function -n accelerator-system -o yaml
```

Look at the event section for more information about the error.

Development issues

Failure to generate a new project

URI is not absolute error

The **generate** command fails with the following error:

```
% tanzu accelerator generate test --server-url https://accelerator.example.com
Error: there was an error generating the accelerator, the server response was: "URI is
not absolute"

Use:
  tanzu accelerator generate [flags]

Examples:
  tanzu accelerator generate <accelerator-name> --options '{"projectName":"test"}'

Flags:
  -h, --help                help for generate
  --options string          options JSON string
  --options-file string     path to file containing options JSON string
  --output-dir string       directory that the zip file will be written to
  --server-url string       the URL for the Application Accelerator server

Global Flags:
  --context name            name of the kubeconfig context to use (default is current-co
ntext defined by kubeconfig)
  --kubeconfig file        kubeconfig file (default is $HOME/.kube/config)

there was an error generating the accelerator, the server response was: "URI is not ab
solute"

Error: exit status 1

✘ exit status 1
```

This indicates that the accelerator resource requested is not in a **READY** state. Review the instructions in the [When Accelerator ready column is false](#) section or contact your system admin.

Accelerator authorship issues

General tips

Speed up the reconciliation of the accelerator

Set the `git.interval` to make the accelerator reconcile sooner. The default interval is 10 minutes, which is too long when developing an accelerator.

You can set this when using the YAML manifest:

```
apiVersion: accelerator.apps.tanzu.vmware.com/v1alpha1
kind: Accelerator
metadata:
  name: test-accelerator
spec:
  git:
    url: https://github.com/trisberg/test-accelerator
    ref:
      branch: main
    interval: 10s
```

You can also set this when creating the accelerator resource. To do so from the Tanzu CLI, run:

```
tanzu accelerator create test-accelerator --git-repo https://github.com/trisberg/test-accelerator --git-branch main --interval 10s
```

Use a source image with local accelerator source directory

You don't have to use a Git repository when developing an accelerator. You can create an accelerator based on content in a local directory using `--local-path` when creating the accelerator resource.

Push the local path content to an OCI image by running:

```
tanzu accelerator create test-accelerator --local-path . --source-image REPO-PREFIX/test-accelerator --interval 10s
```

Where `REPO-PREFIX` is your own repository prefix. Use a repository that the deployed Application Accelerator system can access.

The interval is 10s so that you can push changes to the source-image repository and get faster reconcile time for the accelerator resource. When you have made changes to your accelerator source, push those changes by running:

```
tanzu accelerator push --local-path . --source-image REPO-PREFIX/test-accelerator
```

Where `REPO-PREFIX` is your own repository prefix. Use a repository that is accessible to the deployed Application Accelerator system.

Expression evaluation errors

Expression evaluation errors include:

- Expression `evaluated to null`, such as:

```
Could not read response from accelerator: java.lang.IllegalArgumentException: Expression '#mytestexp' evaluated to null
```

In most cases, a typo in the variable name causes this error. Compare the expression with the defined options or any variables declared with `let`.

- `could not parse SpEL expression`, such as:

```
Could not read response from accelerator: Error reading manifest:could not parse SpEL expression at [Source: (InputStreamReader); line: 65, column: 1] (through reference chain: com.vmware.tanzu.accelerator.engine.manifest.Manifest["engine"]->com.vmware.tanzu.accelerator.engine.transform.transforms.Combo["let"]->java.util.ArrayList[0]->com.vmware.tanzu.accelerator.engine.transform.transforms.Let$DerivedSymbol["expression"])
```

In most cases, an error in a `let` expression causes this error. Review the error message and, for more information, see [SpEL samples](#).

- `SpelEvaluationException`, such as:

```
Could not read response from accelerator: org.springframework.expression.spel.SpelEvaluationException: EL1007E: Property or field 'test' cannot be found on null
```

In most cases, an error in a transform expression causes this error. Review the error message and, for more information, see [SpEL samples](#).

Operations issues

Accelerator persists in Tanzu Developer Portal after deletion

If an accelerator still displays in the Tanzu Developer Portal (formerly named Tanzu Application Platform GUI) after it is deleted using the `tanzu accelerator delete` command, complete the following steps to delete:

1. Navigate to your instance of the Tanzu Developer Portal.
2. Search for the accelerator which should be deleted and select it.
3. On the top right of the window, click the three dots, and select **Unregister Template**.

The accelerator is not longer displayed in the Tanzu Developer Portal Accelerator Catalog.

Check status of accelerator resources

Verify the status of accelerator resources by using `kubectl` or the Tanzu CLI:

- From `kubectl`, run:

```
kubectl get accelerators.accelerator.apps.tanzu.vmware.com -n accelerator-system
```

- From the Tanzu CLI, run:

```
tanzu accelerator list
```

Verify that the `READY` status is `true` for all accelerators.

When Accelerator ready column is blank

1. View the status of `accelerator-system` by running:

```
kubectl get deployment -n accelerator-system
```

Example output:

NAME	READY	UP-TO-DATE	AVAILABLE	AGE
acc-engine	1/1	1	1	3d5h
acc-server	1/1	1	1	2d1h
accelerator-controller-manager	0/1	1	0	3d5h

- View the logs for any component with no Pods available by running:

```
kubectl logs deployment/COMPONENT-NAME/ -n accelerator-system -p
```

Where **COMPONENT-NAME** is the component with no pods you retrieved in the previous step.

- If the log has the following error then the Flux CD source-controller is not installed:

```
2021-11-18T20:55:18.963Z ERROR setup problem running manager {"error": "failed to wait for accelerator caches to sync: no matches for kind \"GitRepository\" in version \"source.toolkit.fluxcd.io/v1beta1\""}

```

- If the log has the following error, the Tanzu Application Platform source-controller is not installed:

```
2021-11-18T20:50:10.557Z ERROR setup problem running manager {"error": "failed to wait for accelerator caches to sync: no matches for kind \"ImageRepository\" in version \"source.apps.tanzu.vmware.com/v1alpha1\""}

```

When Accelerator ready column is false

View the **REASON** column for non-ready accelerators. Run:

```
kubectl get accelerators.accelerator.apps.tanzu.vmware.com -n accelerator-system
```

REASON: `GitRepositoryResolutionFailed`

For example:

```
$ kubectl get accelerators.accelerator.apps.tanzu.vmware.com -n accelerator-system
NAME      READY   REASON                                AGE
more-fun  False   GitRepositoryResolutionFailed         28s

```

- View the resource status. Run:

```
kubectl get -oyaml accelerators.accelerator.apps.tanzu.vmware.com -n accelerator-system hello-fun
```

- Read `status.conditions.message` near the end of the output to learn the likely cause of failure. For example:

```
status:
  address:
    url: http://accelerator-engine.accelerator-system.svc.cluster.local/invocations
  artifact:
    message: 'unable to clone ''https://github.com/vmware-tanzu/application-accelerator-samples'',
      error: couldn't find remote ref "refs/heads/test"'
  ready: false

```

```

url: ""
conditions:
- lastTransitionTime: "2021-11-18T21:05:47Z"
  message: |-
    failed to resolve GitRepository
    unable to clone 'https://github.com/vmware-tanzu/application-accelerator-
samples', error: couldn't find remote ref "refs/heads/test"
    reason: GitRepositoryResolutionFailed
    status: "False"
    type: Ready
  description: Test-git
  observedGeneration: 1

```

In this example, `couldn't find remote ref "refs/heads/test"` reveals that the branch or tag specified doesn't exist.

Another common problem is that the Git repository doesn't exist. For example:

```

status:
  address:
    url: http://accelerator-engine.accelerator-system.svc.cluster.local/invo
cations
  artifact:
    message: 'unable to clone 'https://github.com/vmware-tanzu/application-acc
elerator-sampl'',
    error: authentication required'
    ready: false
    url: ""
  conditions:
- lastTransitionTime: "2021-11-18T21:09:52Z"
  message: |-
    failed to resolve GitRepository
    unable to clone 'https://github.com/vmware-tanzu/application-accelerator-
sampl', error: authentication required
    reason: GitRepositoryResolutionFailed
    status: "False"
    type: Ready
  description: Test-git
  observedGeneration: 1

```

An error message about failed authentication might display because the Git repository doesn't exist. For example:

```

unable to clone 'https://github.com/vmware-tanzu/application-accelerator-samp
l', error: authentication required

```

REASON: `GitRepositoryResolutionPending`

For example:

```

$ kubectl get accelerators.accelerator.apps.tanzu.vmware.com -n accelerator-system
NAME          READY   REASON                    AGE
more-fun     False   GitRepositoryResolutionPending   28s

```

1. See the resource status. Run:

```

kubectl get -oyaml accelerators.accelerator.apps.tanzu.vmware.com -n accelerato
r-system hello-fun

```

2. Locate `status.conditions` at the end of the output. For example:

```

status:
  address:
    url: http://accelerator-engine.accelerator-system.svc.cluster.local/invo
    cations
  artifact:
    message: ""
    ready: false
    url: ""
  conditions:
  - lastTransitionTime: "2021-11-18T20:17:38Z"
    message: GitRepository not yet resolved
    reason: GitRepositoryResolutionPending
    status: "False"
    type: Ready
  description: Test-git
  observedGeneration: 1

```

3. Verify that the Flux system is running and that the `READY` column has `1/1`. Run:

```
kubectl get -n flux-system deployment/source-controller
```

Example output:

NAME	READY	UP-TO-DATE	AVAILABLE	AGE
source-controller	1/1	0	0	5d4h

REASON: `ImageRepositoryResolutionPending`

For example:

```

$ kubectl get accelerators.accelerator.apps.tanzu.vmware.com -n accelerator-system
NAME          READY   REASON                                AGE
more-fun      False   ImageRepositoryResolutionPending       28s

```

1. See the resource status. Run:

```
kubectl get -oyaml accelerators.accelerator.apps.tanzu.vmware.com -n accelera
tor-system hello-fun
```

2. Locate `status.conditions` at the end of the output. For example:

```

$ kubectl get -oyaml accelerators.accelerator.apps.tanzu.vmware.com -n accelera
tor-system more-fun

apiVersion: accelerator.apps.tanzu.vmware.com/v1alpha1
kind: Accelerator
metadata:
  annotations:
    kubectl.kubernetes.io/last-applied-configuration: |
      {"apiVersion":"accelerator.apps.tanzu.vmware.com/v1alpha1","kind":"Accele
rator","metadata":{"annotations":{},"name":"more-fun","namespace":"accelerato
r-system"},"spec":{"description":"Test-image","source":{"image":"trisberg/more-fu
n-source"}}}
  creationTimestamp: "2021-11-18T20:32:36Z"
  generation: 1
  name: more-fun
  namespace: accelerator-system
  resourceVersion: "605401"
  uid: 407b565d-14aa-44fe-ad8d-c9b3c3a7e5ce
spec:
  description: Test-image
  source:

```



```

image: trisberg/more-fun-source
status:
  address:
    url: http://accelerator-engine.accelerator-system.svc.cluster.local/invo
    cations
  artifact:
    message: ""
    ready: false
    url: ""
  conditions:
  - lastTransitionTime: "2021-11-18T20:32:36Z"
    message: ImageRepository not yet resolved
    reason: ImageRepositoryResolutionPending
    status: "False"
    type: Ready
  description: Test-image
  observedGeneration: 1

```

3. Verify that Tanzu Application Platform source-controller system is running and the **READY** column has 1/1. Run:

```
kubectl get -n source-system deployment/source-controller-manager
```

Expected output:

NAME	READY	UP-TO-DATE	AVAILABLE	AGE
source-controller-manager	1/1	0	0	5d5h

Overview of Application Configuration Service for VMware Tanzu

Application Configuration Service (commonly known as App Config Service) provides a Kubernetes-native experience to enable the runtime configuration of existing Spring applications that were previously leveraged by using Spring Cloud Config Server.

Spring Cloud Config Server was an essential component in microservices architectures for providing runtime configuration to Spring Boot applications.

Spring Cloud Config Server did this by enabling configuration management to be hosted in Git repositories on different branches and in directories that could be used to generate runtime configuration properties for applications.

Application Configuration Service is compatible with the existing Git repository configuration management approach. It filters runtime configuration for any application by using slices that produce secrets.

For more information about Application Configuration Service, see the [Application Configuration Service for VMware Tanzu documentation](#).

Overview of Application Configuration Service for VMware Tanzu

Application Configuration Service (commonly known as App Config Service) provides a Kubernetes-native experience to enable the runtime configuration of existing Spring applications that were previously leveraged by using Spring Cloud Config Server.

Spring Cloud Config Server was an essential component in microservices architectures for providing runtime configuration to Spring Boot applications.

Spring Cloud Config Server did this by enabling configuration management to be hosted in Git repositories on different branches and in directories that could be used to generate runtime configuration properties for applications.

Application Configuration Service is compatible with the existing Git repository configuration management approach. It filters runtime configuration for any application by using slices that produce secrets.

For more information about Application Configuration Service, see the [Application Configuration Service for VMware Tanzu documentation](#).

Install Application Configuration Service for VMware Tanzu

This topic tells you how to install Application Configuration Service for VMware Tanzu (commonly known as App Config Service) from the Tanzu Application Platform (commonly known as TAP) package repository.

Prerequisites

Before installing Application Configuration Service, complete all prerequisites to install Tanzu Application Platform. For more information, see [Prerequisites](#).

Install

To install Application Configuration Service on a compliant Kubernetes cluster:

1. List version information for the package by running:

```
tanzu package available list application-configuration-service.tanzu.vmware.com
--namespace tap-install
```

For example:

```
$ tanzu package available list application-configuration-service.tanzu.vmware.c
om --namespace tap-install
- Retrieving package versions for application-configuration-service.tanzu.vmware
e.com...
NAME                                VERSION  RELEASED-AT
application-configuration-service.tanzu.vmware.com  2.0.0    2023-03-08 19:00:0
0 -0500 EST
```

2. (Optional) Make changes to the default installation settings by running:

```
tanzu package available get application-configuration-service.tanzu.vmware.com/
VERSION-NUMBER \
--values-schema --namespace tap-install
```

Where **VERSION-NUMBER** is the number you discovered previously. For example, **2.0.0**.

3. Install the package by running:

```
tanzu package install application-configuration-service \
--package application-configuration-service.tanzu.vmware.com \
--version VERSION -n tap-install \
--values-file values.yaml
```

Where **VERSION** is the version you want, such as **2.0.0**. Using a **values.yaml** file is optional.

For example:

```

$ tanzu package install application-configuration-service \
--package application-configuration-service.tanzu.vmware.com \
--version 2.0.0 -n tap-install

Installing package 'application-configuration-service.tanzu.vmware.com'
Getting package metadata for 'application-configuration-service.tanzu.vmware.com'
Creating service account 'application-configuration-service-tap-install-sa'
Creating cluster admin role 'application-configuration-service-tap-install-cluster-role'
Creating cluster role binding 'application-configuration-service-tap-install-cluster-rolebinding'
Creating package resource
Waiting for 'PackageInstall' reconciliation for 'application-configuration-service'
'PackageInstall' resource install status: Reconciling
'PackageInstall' resource install status: ReconcileSucceeded

Added installed package 'application-configuration-service'

```

4. Verify that you installed the package by running:

```
tanzu package installed get application-configuration-service -n tap-install
```

For example:

```

$ tanzu package installed get application-configuration-service -n tap-install

NAME:                application-configuration-service
PACKAGE-NAME:        application-configuration-service.tanzu.vmware.com
PACKAGE-VERSION:     2.0.0
STATUS:              Reconcile succeeded
CONDITIONS:         [{"ReconcileSucceeded True  }]
USEFUL-ERROR-MESSAGE:

```

Overview of Application Live View

Application Live View is a lightweight insights and troubleshooting tool for app developers and app operators that helps you to look inside running applications. It is based on the concept of Spring Boot Actuators.

The application provides information from inside the running processes using endpoints, in this case, HTTP endpoints. Application Live View uses those endpoints to get and interact with the data from apps.

Value proposition

Application Live View is a diagnostic tool for developers to manage and analyze runtime characteristics of containerized apps. In addition, it provides a Kubernetes-native feel for developers to manage their apps in a Kubernetes environment more effectively.

Intended audience

This documentation is intended for developers and operators to visualize the actuator information of their running apps on Application Live View for VMware Tanzu. This documentation helps developers to monitor and troubleshoot apps in development, staging, and production environments. It is also intended to help app operators to deploy and administer containerized apps in a Kubernetes environment.

Supported application platforms

You can extend Application Live View to support multiple app platforms, including, but not limited to, Spring Boot, Spring Cloud Gateway, and Steeltote.

Multicloud compatibility

Using Tanzu platform, you can integrate Application Live View to monitor apps running across on-premises, public clouds, and edge. The platform provides a centralized view to manage apps across cloud environments, which accelerates developer productivity and reduces time-to-market.

Deployment

Use a connector as the mode of deployment for registering apps with the Application Live View running on a Kubernetes cluster. A connector is a component responsible for discovering multiple apps running on a Kubernetes cluster and is installed as a DaemonSet by default.

Overview of Application Live View

Application Live View is a lightweight insights and troubleshooting tool for app developers and app operators that helps you to look inside running applications. It is based on the concept of Spring Boot Actuators.

The application provides information from inside the running processes using endpoints, in this case, HTTP endpoints. Application Live View uses those endpoints to get and interact with the data from apps.

Value proposition

Application Live View is a diagnostic tool for developers to manage and analyze runtime characteristics of containerized apps. In addition, it provides a Kubernetes-native feel for developers to manage their apps in a Kubernetes environment more effectively.

Intended audience

This documentation is intended for developers and operators to visualize the actuator information of their running apps on Application Live View for VMware Tanzu. This documentation helps developers to monitor and troubleshoot apps in development, staging, and production environments. It is also intended to help app operators to deploy and administer containerized apps in a Kubernetes environment.

Supported application platforms

You can extend Application Live View to support multiple app platforms, including, but not limited to, Spring Boot, Spring Cloud Gateway, and Steeltote.

Multicloud compatibility

Using Tanzu platform, you can integrate Application Live View to monitor apps running across on-premises, public clouds, and edge. The platform provides a centralized view to manage apps across cloud environments, which accelerates developer productivity and reduces time-to-market.

Deployment

Use a connector as the mode of deployment for registering apps with the Application Live View running on a Kubernetes cluster. A connector is a component responsible for discovering multiple apps running on a Kubernetes cluster and is installed as a DaemonSet by default.

Install Application Live View

This topic tells you how to install Application Live View from the Tanzu Application Platform (commonly known as TAP) package repository.

Overview

Application Live View includes four packages you must install. The following table lists these packages and shows the Tanzu Application Platform profiles each package is included in.

Package	Profiles	Details
Application Live View APIServer (apiserver.appliveview.tanzu.vmware.com)	Full, Iterate, Run	Installed in the <code>appliveview-tokens-system</code> namespace
Application Live View backend (backend.appliveview.tanzu.vmware.com)	Full, View	Installed with Tanzu Developer Portal (formerly named Tanzu Application Platform GUI) in the <code>app-live-view</code> namespace
Application Live View connector (connector.appliveview.tanzu.vmware.com)	Full, Iterate, Run	Installed as a DaemonSet in the <code>app-live-view-connector</code> namespace
Application Live View conventions (conventions.appliveview.tanzu.vmware.com)	Full, Iterate, Build	Installed in the <code>app-live-view-conventions</code> namespace

For more information about these packages, see [Application Live View internal architecture](#).



Note

Follow the steps in this topic if you do not want to use a profile to install Application Live View. For more information about profiles, see [About Tanzu Application Platform components and profiles](#).

Prerequisites

Before installing Application Live View:

- Complete all prerequisites to install Tanzu Application Platform. For more information, see [Prerequisites](#).
- Install Cartographer Conventions, which is bundled with Supply Chain Choreographer as of v0.5.3. To install, see [Installing Supply Chain Choreographer](#). For more information, see [Cartographer Conventions](#).

Install Application Live View

You can install Application Live View in single cluster or multicluster environment:

- **Single cluster:** All Application Live View components are deployed in a single cluster. The user can access Application Live View plug-in information of the applications across all the namespaces in the Kubernetes cluster. This is the default mode of Application Live View.
- **Multicluster:** In a multicluster environment, the Application Live View back end component is installed only once in a single cluster and exposes a RSocket registration for the other clusters using Tanzu shared ingress. Each cluster continues to install the connector as a DaemonSet. The connectors are configured to connect to the central instance of the Application Live View back end.

The improved security and access control secures the communication between the Application Live View components. For more information, see [Configure security and access control in Application Live View](#).

Install Application Live View back end

To install Application Live View back end:

1. List version information for the package by running:

```
tanzu package available list backend.appliveview.tanzu.vmware.com --namespace t
ap-install
```

For example:

```
$ tanzu package available list backend.appliveview.tanzu.vmware.com --namespace
tap-install

- Retrieving package versions for backend.appliveview.tanzu.vmware.com...
NAME                                VERSION    RELEASED-AT
backend.appliveview.tanzu.vmware.com 1.5.1     2023-03-29T00:00:00Z
```

2. Create the file `app-live-view-backend-values.yaml` using the following information:
 - o **For a single-cluster environment:** The Application Live View back end is exposed through the Kubernetes cluster service.
By default, ingress is deactivated for Application Live View back end. You do not have to change your `app-live-view-backend-values.yaml` file in this step.
 - o **For a multicluster environment:** Set the flag `ingressEnabled` to `true` for the Application Live View back end to be exposed on the ingress domain.

```
appliveview:
  ingressEnabled: true
```

- o **For a profile install using shared ingress domain key:** If you are using a Tanzu Application Platform profile installation and the top-level key `shared.ingress_domain` is set in the `tap-values.yaml`, the back end is automatically exposed through the shared ingress.

To override the shared ingress for Application Live View in a multicluster environment, use the following values:

```
appliveview:
  ingressEnabled: true
  ingressDomain: ${INGRESS-DOMAIN}
```

Where `INGRESS-DOMAIN` is the top-level domain you use for the `tanzu-shared-ingress` service's external IP address. The `appliveview` subdomain is prepended to

the value provided.

3. Configure TLS in your `app-live-view-backend-values.yaml` file:

- o To enable TLS for Application Live View back end using a self-signed certificate:

1. Create the `app-live-view` namespace and the TLS secret for the domain. You must do this before installing the Tanzu Application Platform packages in the cluster so that the HTTPProxy is updated with the TLS secret. To create a TLS secret, run:

```
kubectl create -n app-live-view secret tls alv-cert --cert=CERT-FILE --key=KEY-FILE
```

Where:

- `SECRET-NAME` is the name you want for the TLS secret for the domain, for example, `alv-cert`.
 - `CERT-FILE` is a `.crt` file that contains the PEM encoded server certificate.
 - `KEY-FILE` is a `.key` file that contains the PEM encoded server private key.
2. Provide the following properties in your `app-live-view-backend-values.yaml`:

```
appliveview:
  ingressEnabled: true
  tls:
    namespace: "NAMESPACE"
    secretName: "SECRET-NAME"
```

Where:

- `NAMESPACE` is the targeted namespace of TLS secret for the domain.
- `SECRET-NAME` is the name of TLS secret for the domain.

You can edit the values to suit your project needs or leave the default values as is.

When `ingressEnabled` is `true`, the HTTPProxy object is created in the cluster.

3. Verify the HTTPProxy object with the TLS secret by running:

```
kubectl get httpproxy -A
```

Expected output:

NAMESPACE	NAME	FQDN	T
LS	SECRET	STATUS	STATUS DESCRIPTION
app-live-view	appliveview	appliveview.192.168.42.55.nip.io	a
pp-live-view	alv-cert	valid	Valid HTTPProxy

- o To enable TLS for Application Live View back end using ClusterIssuer:

1. Set the `ingressEnabled` key to `true` for TLS to be enabled on Application Live View back end using ClusterIssuer. This key is set to `false` by default.

```
appliveview:
  ingressEnabled: true
```

TLS is then automatically enabled on Application Live View back end using the shared ClusterIssuer. The `appliveview-cert` certificate is generated by default and its issuerRef points to the `.ingress_issuer` value. The `ingress_issuer` key consumes the value `shared.ingress_issuer` from `tap-values.yaml` by default if you don't specify the `ingress_issuer` in `tap-values.yaml`.

When `ingressEnabled` is `true`, HTTPProxy object is created in the cluster and also `appliveview-cert` certificate is generated by default in the `app_live_view` namespace. Here, the secretName `appliveview-cert` stores this certificate.

- To verify the HTTPProxy object with the secret, run:

```
kubectl get httpproxy -A
```

Expected output:

NAMESPACE	NAME	FQDN	T
LS SECRET	STATUS	STATUS DESCRIPTION	
app-live-view	appliveview	appliveview.192.168.42.55.nip.io	a
ppliveview-cert	valid	Valid HTTPProxy	

- To verify the Application Live View pages in a multicluster setup, set the appropriate connector configuration in your run cluster as listed in [Install Application Live View connector](#) later in this topic.
- (Optional) View additional changes you can make in your `app-live-view-backend-values.yaml` file by running:

```
tanzu package available get backend.appliveview.tanzu.vmware.com/VERSION-NUMBER \
--values-schema \
--namespace tap-install
```

Where `VERSION-NUMBER` is the version of the package listed earlier. For example, `1.5.1`.

For example:

```
$ tanzu package available get backend.appliveview.tanzu.vmware.com/1.5.1 \
--values-schema \
--namespace tap-install
```

KEY	DEFAULT	TYPE	DESCRIPTION
<code>tls.namespace</code>	<code><nil></code>	string	The targeted namespace for secret consumption by the HTTPProxy.
<code>tls.secretName</code>	<code><nil></code>	string	The name of secret for consumption by the HTTPProxy.
<code>ingressDomain</code>	<code>tap.example.com</code>	string	Domain to be used by the HTTPProxy ingress object. The "appliveview" subdomain will be prepended to the value provided. For example: "example.com" would become "appliveview.example.com".
<code>ingressEnabled</code>	<code>false</code>	boolean	Flag for whether or not to create an HTTPProxy for ingress.
<code>ingress_issuer</code>		string	Cluster issuer to be used in App Live View Backend.
<code>kubernetes_distribution</code>		string	Kubernetes distribution

```

that this package is being installed on. Accepted
values: ['', 'openshi
ft'']
kubernetes_version      string      Optional: The Kubernet
s Version. Valid value
s are '1.24.*', or ''
server.tls.crt           string      TLS cert file
server.tls.enabled      boolean    Flag to enable tls on
backend
server.tls.key           string      TLS key file

```

5. Install the Application Live View back end package by running:

```

tanzu package install appliveview \
  --package backend.appliveview.tanzu.vmware.com \
  --version VERSION-NUMBER \
  --namespace tap-install \
  --values-file app-live-view-backend-values.yaml

```

Where `VERSION-NUMBER` is the version of the package listed earlier. For example, `1.5.1`.

For example:

```

$ tanzu package install appliveview \
  --package backend.appliveview.tanzu.vmware.com \
  --version 1.5.1 \
  --namespace tap-install \
  --values-file app-live-view-backend-values.yaml

- Installing package 'backend.appliveview.tanzu.vmware.com'
| Getting namespace 'tap-install'
| Getting package metadata for 'backend.appliveview.tanzu.vmware.com'
| Creating service account 'appliveview-tap-install-sa'
| Creating cluster admin role 'appliveview-tap-install-cluster-role'
| Creating cluster role binding 'appliveview-tap-install-cluster-rolebinding'
| Creating package resource
| Package install status: Reconciling

Added installed package 'appliveview' in namespace 'tap-install'

```

The Application Live View back end component is deployed in `app-live-view` namespace by default.

6. Verify the Application Live View back end package installation by running:

```

tanzu package installed get appliveview -n tap-install

```

For example:

```

$ tanzu package installed get appliveview -n tap-install

\ Retrieving installation details for appliveview...
NAME:                appliveview
PACKAGE-NAME:        backend.appliveview.tanzu.vmware.com
PACKAGE-VERSION:     1.5.1
STATUS:              Reconcile succeeded
CONDITIONS:          [{ReconcileSucceeded True  }]
USEFUL-ERROR-MESSAGE:

```

Verify that `STATUS` is `Reconcile succeeded`.

Install Application Live View connector

To install Application Live View connector:

1. List version information for the package by running:

```
tanzu package available list connector.appliveview.tanzu.vmware.com --namespace tap-install
```

For example:

```
$ tanzu package available list connector.appliveview.tanzu.vmware.com --namespace tap-install

- Retrieving package versions for connector.appliveview.tanzu.vmware.com...
NAME                                VERSION          RELEASED-AT
connector.appliveview.tanzu.vmware.com 1.5.1           2023-03-29T00:00:00Z
```

2. Create the file `app-live-view-connector-values.yaml` using the following details:
 - o **For a single-cluster environment:** The Application Live View connector connects to the `cluster-local` Application Live View back end to register the applications. By default, ingress is deactivated for connector. You do not have to change your `app-live-view-connector-values.yaml` file in this step.
 - o **For a multicluster environment:** Set the flag `ingressEnabled` to `true` for the Application Live View connector to connect to the Application Live View back end by using the ingress domain. For example:

```
appliveview_connector:
  backend:
    ingressEnabled: true
```

- o **For a profile install using shared ingress domain key:** If you are using a Tanzu Application Platform profile installation and the top-level key `shared.ingress_domain` is set in the `tap-values.yaml`, the Application Live View connector and Application Live View back end are configured to communicate through ingress. The Application Live View connector then uses the `shared.ingress_domain` to reach the back end.

To override the shared ingress for Application Live View in a multicluster environment, use the following values:

```
appliveview_connector:
  backend:
    host: appliveview.INGRESS-DOMAIN
```

Where `INGRESS-DOMAIN` is the top-level domain the Application Live View back end exposes by using `tanzu-shared-ingress` for the connectors in other clusters to reach the Application Live View back end. Prepend the `appliveview` subdomain to the provided value.

3. Configure TLS in your `app-live-view-connector-values.yaml`. Choose a tab depending on how you configured TLS in [Install Application Live View back end](#) earlier.
 - o To configure TLS with a self-signed certificate, set the CA certificate for the ingress domain in the `backend.caCertData` key for SSL validation as follows:

```
appliveview_connector:
  backend:
    ...
    caCertData: |-
```

```
-----BEGIN CERTIFICATE-----
MIIGMzCCBBUGAwIBAgIJALHHzQjxM6wMMA0GCSqGSIb3DQEEDQUAMGcxCzAJBgNV
BAGMAk1OMRQwEgYDVQQHDAtNaW5uZWZwY2xpczEPMA0GA1UECgwGVk13YXJ1MRMw
-----END CERTIFICATE-----
```

`backend.sslDeactivated` is set to `false` by default.

- o To enable TLS using ClusterIssuer:
 1. Retrieve the certificate from the HTTPProxy secret by running the following command in the view cluster:

```
kubectl get secret appliveview-cert -n app-live-view -o yaml | yq
'.data."ca.crt"' | base64 -d
```

2. Set the following connector configuration in the run cluster:

```
appliveview_connector:
  backend:
    ingressEnabled: true
    sslDeactivated: false
    host: appliveview.INGRESS-DOMAIN
    caCertData: |-
      -----BEGIN CERTIFICATE-----
      MIIGMzCCBBUGAwIBAgIJALHHzQjxM6wMMA0GCSqGSIb3DQEEDQUAMGcxCzAJ
BgNV
      BAGMAk1OMRQwEgYDVQQHDAtNaW5uZWZwY2xpczEPMA0GA1UECgwGVk13YXJ1
MRMw
      -----END CERTIFICATE-----
```

Where:

- `caCertData` is the certificate you retrieved from the HTTPProxy secret exposed by the Application Live View back end in the view cluster.
 - `host` is the backend host in the view cluster.
- o To deactivate TLS if TLS is not enabled for the `INGRESS-DOMAIN` in the Application Live View back end, set `backend.sslDeactivated` to `true`. For example:

```
appliveview_connector:
  backend:
    ...
    sslDeactivated: true
```



Note

The `sslDisabled` key is deprecated and has been renamed to `sslDeactivated`.

You can edit the values to suit your project needs or leave the default values as is.

Using the HTTP proxy either on 80 or 443 based on SSL config exposes the back end service running on port 7000. The connector connects to the back end on port 80/443 by default. Therefore, you are not required to explicitly configure the `port` field.

4. (Optional) View additional changes you can make in your `app-live-view-connector-values.yaml` file by running:

```
tanzu package available get connector.appliveview.tanzu.vmware.com/VERSION-NUMBER \
--values-schema \
--namespace tap-install
```

Where `VERSION-NUMBER` is the version of the package listed earlier. For example, `1.5.1`.

For example:

```
$ tanzu package available get connector.appliveview.tanzu.vmware.com/1.5.1 \
--values-schema \
--namespace tap-install
```

KEY	DEFAULT	TYPE	DESCRIPTION
<code>backend.caCertData</code>	<code>cert-in-pem-format</code>	string	CA Cert Data for ingress domain
<code>backend.host</code>	<code><nil></code>	string	Domain to be used to reach the application live view backend. Prepend "appliveview" subdomain to the value if you are using shared ingress. For example: "example.com" would become "appliveview.example.com".
<code>backend.ingressEnabled</code>	<code>false</code>	boolean	Flag for the connector to connect to ingress on backend
<code>backend.port</code>	<code><nil></code>	number	Port to reach the application live view backend
<code>backend.sslDeactivated</code>	<code>false</code>	boolean	Flag for whether or not to deactivate ssl
<code>backend.sslDisabled</code>	<code>false</code>	boolean	The key <code>sslDisabled</code> has been deprecated in TAP 1.4.0 and will be removed in TAP 1.X+Y.0 of TAP, please migrate to the key <code>sslDeactivated</code>
<code>connector.namespace_scoped.enabled</code>	<code>false</code>	boolean	Flag for the connector to run in namespace scope
<code>connector.namespace_scoped.namespace</code>	<code>default</code>	string	Namespace to deploy connector
<code>kubernetes_distribution</code>		string	Kubernetes distribution that this package is being installed on. Accepted values: <code>['', 'openshift']</code>
<code>kubernetes_version</code>		string	Optional: The Kubernetes Version. Valid values are '1.24.*', or ''
<code>activateAppLiveViewSecureAccessControl</code>		boolean	Optional: Configuration required to enable Secure Access Connection between App Live View components
<code>activateSensitiveOperations</code>		boolean	Optional: Configuration to allow connector to execute sensitive operations on a running application

5. Install the Application Live View connector package by running:

```
tanzu package install appliveview-connector \
--package connector.appliveview.tanzu.vmware.com \
--version VERSION-NUMBER \
--namespace tap-install \
--values-file app-live-view-connector-values.yaml
```

Where `VERSION-NUMBER` is the version of the package listed earlier. For example, `1.5.1`.

For example:

```

$ tanzu package install appliveview-connector \
  --package connector.appliveview.tanzu.vmware.com \
  --version 1.5.1 \
  --namespace tap-install \
  --values-file app-live-view-connector-values.yaml

| Installing package 'connector.appliveview.tanzu.vmware.com'
| Getting namespace 'tap-install'
| Getting package metadata for 'connector.appliveview.tanzu.vmware.com'
| Creating service account 'appliveview-connector-tap-install-sa'
| Creating cluster admin role 'appliveview-connector-tap-install-cluster-role'
| Creating cluster role binding 'appliveview-connector-tap-install-cluster-role
binding'
- Creating package resource
/ Package install status: Reconciling

Added installed package 'appliveview-connector' in namespace 'tap-install'

```

Each cluster installs the connector as a DaemonSet. The connector is configured to connect to the central instance of the back end. The Application Live View connector component is deployed in `app-live-view-connector` namespace by default.

6. Verify the `Application Live View connector` package installation by running:

```
tanzu package installed get appliveview-connector -n tap-install
```

For example:

```

$ tanzu package installed get appliveview-connector -n tap-install

| Retrieving installation details for appliveview-connector...
NAME:                appliveview-connector
PACKAGE-NAME:        connector.appliveview.tanzu.vmware.com
PACKAGE-VERSION:     1.5.1
STATUS:              Reconcile succeeded
CONDITIONS:          [{ReconcileSucceeded True  }]
USEFUL-ERROR-MESSAGE:

```

Verify that `STATUS` is `Reconcile succeeded`.

Install Application Live View conventions

To install Application Live View conventions:

1. List version information for the package by running:

```
tanzu package available list conventions.appliveview.tanzu.vmware.com --namespace tap-install
```

For example:

```

$ tanzu package available list conventions.appliveview.tanzu.vmware.com --namespace tap-install

- Retrieving package versions for conventions.appliveview.tanzu.vmware.com...
NAME                                VERSION      RELEASED-AT
conventions.appliveview.tanzu.vmware.com  1.5.1       2023-03-29T00:00:00Z

```

2. (Optional) View the changes you can make to the default installation settings by running:

```
tanzu package available get conventions.appliveview.tanzu.vmware.com/VERSION-NUMBER \
```

```
--values-schema \  
--namespace tap-install
```

Where **VERSION-NUMBER** is the version of the package listed earlier. For example, **1.5.1**.

For example:

```
$ tanzu package available get conventions.appliveview.tanzu.vmware.com/1.5.1 \  
  --values-schema \  
  --namespace tap-install
```

KEY	DEFAULT	TYPE	DESCRIPTION
kubernetes_distribution		string	Kubernetes distribution that this package is installed on. Accepted values: ['','openshift'].
kubernetes_version		string	Optional: The Kubernetes Version. Valid values are '1.24.*', or ''.

- (Optional) Create a file named `app-live-view-conventions-values.yaml` to override the default installation settings using the information output in the previous step.
- Install the Application Live View conventions package.

Default values

To install Application Live View conventions with the default settings, run:

```
tanzu package install appliveview-conventions \  
  --package conventions.appliveview.tanzu.vmware.com \  
  --version VERSION-NUMBER \  
  --namespace tap-install
```

Where **VERSION-NUMBER** is the version of the package listed earlier. For example, **1.5.1**.

For example:

```
$ tanzu package install appliveview-conventions \  
  --package conventions.appliveview.tanzu.vmware.com \  
  --version 1.5.1 \  
  --namespace tap-install
```

```
- Installing package 'conventions.appliveview.tanzu.vmware.com'  
| Getting namespace 'tap-install'  
| Getting package metadata for 'conventions.appliveview.tanzu.vmware.com'  
| Creating service account 'appliveview-conventions-tap-install-sa'  
| Creating cluster admin role 'appliveview-conventions-tap-install-cluster-role'  
| Creating cluster role binding 'appliveview-conventions-tap-install-cluster-rolebinding'  
- Creating package resource  
\ Package install status: Reconciling
```

```
Added installed package 'appliveview-conventions' in namespace 'tap-install'
```

Overriding values

To install Application Live View conventions while overriding the default settings, run:

```
tanzu package install appliveview-conventions \  
  --package conventions.appliveview.tanzu.vmware.com \  
  --version VERSION-NUMBER \  
  --namespace tap-install \  
  --values-file app-live-view-conventions-values.yaml
```

Where `VERSION-NUMBER` is the version of the package listed earlier. For example, `1.5.1`.

5. Verify the package install for Application Live View conventions package by running:

```
tanzu package installed get appliveview-conventions -n tap-install
```

For example:

```
$ tanzu package installed get appliveview-conventions -n tap-install

| Retrieving installation details for appliveview-conventions...
NAME:                appliveview-conventions
PACKAGE-NAME:        conventions.appliveview.tanzu.vmware.com
PACKAGE-VERSION:     1.5.1
STATUS:              Reconcile succeeded
CONDITIONS:          [{"ReconcileSucceeded": true}]
USEFUL-ERROR-MESSAGE:
```

Verify that `STATUS` is `Reconcile succeeded`.

Install Application Live View APIServer

To install Application Live View APIServer:

1. List version information for the package by running:

```
tanzu package available list apiserver.appliveview.tanzu.vmware.com --namespace tap-install
```

For example:

```
$ tanzu package available list apiserver.appliveview.tanzu.vmware.com --namespace tap-install

- Retrieving package versions for apiserver.appliveview.tanzu.vmware.com...
NAME                                VERSION    RELEASED-AT
apiserver.appliveview.tanzu.vmware.com 1.5.1     2023-03-29T00:00:00Z
```

2. (Optional) View the changes you can make to the default installation settings by running:

```
tanzu package available get apiserver.appliveview.tanzu.vmware.com/VERSION-NUMBER \
--values-schema \
--namespace tap-install
```

Where `VERSION-NUMBER` is the version of the package listed earlier. For example, `1.5.1`.

For example:

```
$ tanzu package available get apiserver.appliveview.tanzu.vmware.com/1.5.1 \
--values-schema \
--namespace tap-install \

KEY                                DEFAULT    TYPE    DESCRIPTION
kubernetes_distribution             string    Kubernetes distribution that this package is installed on. Accepted values: ['','openshift'].
kubernetes_version                  string    Optional: The Kubernetes Version. Valid values are '1.24.*', or ''.
```

- (Optional) Create a file named `app-live-view-apiserver-values.yaml` to override the default installation settings using the information output in the previous step.
- Install the Application Live View APIServer package.

Default values

To install Application Live View APIServer with the default settings, run:

```
tanzu package install appliveview-apiserver \
  --package apiserver.appliveview.tanzu.vmware.com \
  --version VERSION-NUMBER \
  --namespace tap-install
```

Where `VERSION-NUMBER` is the version of the package listed earlier. For example, `1.5.1`.

For example:

```
$ tanzu package install appliveview-apiserver \
  --package apiserver.appliveview.tanzu.vmware.com \
  --version 1.5.1 \
  --namespace tap-install

- Installing package 'apiserver.appliveview.tanzu.vmware.com'
| Getting namespace 'tap-install'
| Getting package metadata for 'apiserver.appliveview.tanzu.vmware.com'
- Creating package resource
\ Package install status: Reconciling

Added installed package 'appliveview-apiserver' in namespace 'tap-install'
```

Overriding values

To install Application Live View APIServer while overriding the default settings, run:

```
tanzu package install appliveview-apiserver \
  --package apiserver.appliveview.tanzu.vmware.com \
  --version VERSION-NUMBER \
  --namespace tap-install \
  --values-file app-live-view-apiserver-values.yaml
```

Where `VERSION-NUMBER` is the version of the package listed earlier. For example, `1.5.1`.

- Verify the package install for Application Live View APIServer package by running:

```
tanzu package installed get appliveview-apiserver -n tap-install
```

For example:

```
$ tanzu package installed get appliveview-apiserver -n tap-install

| Retrieving installation details for appliveview-apiserver...
NAME:                appliveview-apiserver
PACKAGE-NAME:        apiserver.appliveview.tanzu.vmware.com
PACKAGE-VERSION:     1.5.1
STATUS:              Reconcile succeeded
CONDITIONS:          [{"ReconcileSucceeded True  }]
USEFUL-ERROR-MESSAGE:
```

Verify that `STATUS` is `Reconcile succeeded`.

The Application Live View UI plug-in is part of Tanzu Developer Portal. To access the Application Live View UI, see [Application Live View in Tanzu Application Platform GUI](#).

Deprecation notice for the sslDisabled key

The `appliveview_connector.backend.sslDisabled` key is deprecated and renamed to `appliveview_connector.backend.sslDeactivated`. The `appliveview_connector.backend.sslDisabled` key is marked for removal in Tanzu Application Platform 1.7.0.

Configure security and access control in Application Live View

This topic tells you how to enable improved security and access control in Application Live View in Tanzu Application Platform (commonly known as TAP). Improved security and access control in Application Live View secures the REST API exposed by the Application Live View back end.

For more information about Application Live View packages, see [Install Application Live View](#).

Security and access control overview

There is one instance of Application Live View back end installed per View profile. Multiple users access this back-end API to fetch actuator data for different applications. All the REST API calls to the back end are secured. A token must be passed to the Application Live View back end on each call to the REST API to fetch actuator data. This token is obtained from Application Live View APIServer.

The Application Live View APIServer generates a unique token upon access validation of a user to a pod. The Application Live View back end passes this token to the Application Live View connector when requesting the actuator data. The Application Live View connector verifies this token by calling the Application Live View APIServer and proxies the actuator data only if the token is valid.

The Application Live View UI plug-in part of Tanzu Developer Portal (formerly named Tanzu Application Platform GUI) uses the preceding approach to securely query for the actuator data for a pod. It requests a token from Application Live View APIServer and passes it in the subsequent calls to the back end. This ensures that actuator data from the running application is fetched only if the user is authorized to see the live information for the pod.

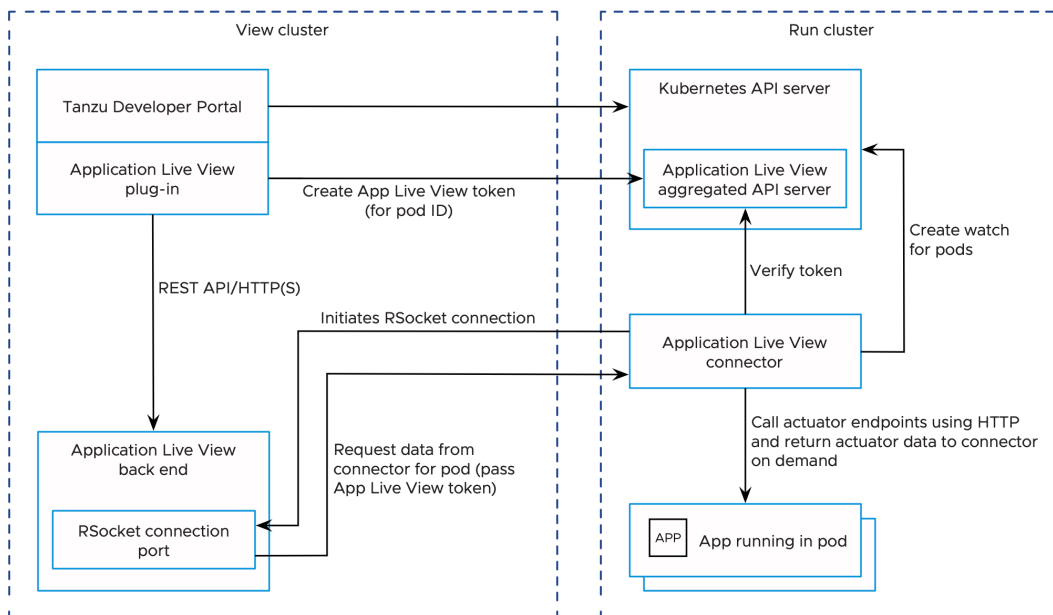

The Application Live View UI plug-in relies on Tanzu Developer Portal authentication and authorization to access the Application Live View APIServer and fetch the Application Live View tokens.

The Tanzu Developer Portal controls the access to Kubernetes resources based on user roles and permissions for each of the remote clusters. For more information, see [View runtime resources on authorization-enabled clusters](#).

For more information about how to set up unrestricted remote cluster visibility, see [Viewing resources on multiple clusters in Tanzu Developer Portal](#).

Prerequisites

1. You install the Application Live View APIServer package (apiserver.appliveview.tanzu.vmware.com) in Tanzu Application Platform. For more information, see [Install Application Live View APIServer](#).
2. Assign users necessary roles and permissions for the Kubernetes clusters. For more information about managing role-based access control, see [Assign roles and permissions on Kubernetes clusters](#)

For example: If you are using Service Account to view resources on a cluster in Tanzu Developer Portal, verify that the `ClusterRole` has rules to access and request tokens from the Application Live View APIServer.

```
- apiGroups: ['appliveview.apps.tanzu.vmware.com']
  resources:
  - resourceinspectiongrants
  verbs: ['get', 'watch', 'list', 'create']
```

For more information, see [Set up a Service Account to view resources on a cluster](#).



Note

With the Service Account approach to view resources on a cluster, every user with the Service Account Token with access to view the pods is able to see the live information in Application Live View.

Configure improved security

The improved security feature is enabled by default for Application Live View.

In a Tanzu Application Platform profile install, the Application Live View connector (connector.appliveview.tanzu.vmware.com) and the Tanzu Application Platform GUI (tap-gui.tanzu.vmware.com) are automatically configured to enable the secure communication between Application Live View components.

You can control this feature by setting the top-level key `shared.activateAppLiveViewSecureAccessControl` in the `tap-values.yaml`.

For example:

```
shared:
  activateAppLiveViewSecureAccessControl: true
```

To override the security feature at the individual component level, take the following steps.

Application Live View connector

1. (Optional) Change the default installation settings for Application Live View connector by running:

```
tanzu package available get connector.appliveview.tanzu.vmware.com/VERSION-NUMBER --values-schema --namespace tap-install
```

Where `VERSION-NUMBER` is the version of the package listed. For example, `1.5.0-build.5`.

For example:

```
$ tanzu package available get connector.appliveview.tanzu.vmware.com/1.5.0-build.5 --values-schema --namespace tap-install
```

KEY	DEFAULT	TYPE	DESCRIPTION
kubernetes_version		string	Optional: The Kubernetes Version. Valid values are '1.24.*', or ''.
backend.sslDeactivated	false	boolean	Flag for whether to disable SSL.
backend.caCertData	cert-in-pem-format	string	CA Cert Data for ingress domain.
backend.host	<nil>	string	Domain used to reach the Application Live View back end. Prepend "appliveview" subdomain to the value if you use shared ingress. For example: "example.com" becomes "appliveview.example.com".
backend.ingressEnabled	false	boolean	Flag for the connector to connect to ingress on back end.
backend.port	<nil>	number	Port to reach the Application Live View back end.
connector.namespace_scoped.enabled	false	boolean	Flag for the connector to run in namespace scope.
connector.namespace_scoped.namespace	default	string	Namespace to deploy connector.
kubernetes_distribution		string	Kubernetes distribution that this package is being installed on. Accepted values: ['','','openshift'].
activateAppLiveViewSecureAccessControl		boolean	Optional: Configuration required to enable Secure Access Connection between App Live View components.
activateSensitiveOperations		boolean	Optional: Configuration to allow connector to execute sensitive operations on a running application.

For more information about values schema options, see the properties listed earlier.

2. Create `app-live-view-connector-values.yaml` with the following details:

To override the default security settings for connector, use the following values:

```
activateAppLiveViewSecureAccessControl: false
```

By default, `activateAppLiveViewSecureAccessControl` is set to `true`.

The `activateSensitiveOperations` key activates/deactivates the execution of sensitive operations, such as editing environment variables, downloading heap dump data, and changing log levels for the applications in the cluster. It is set to `false` by default.

To enable the sensitive operations, set `activateSensitiveOperations` to `true`.

```
activateSensitiveOperations: true
```

To control permissions to execute sensitive operations at a user level, see [Authorize a user to execute sensitive operations](#).

3. Install the Application Live View connector package by running:

```
tanzu package install appliveview-connector \
  --package connector.appliveview.tanzu.vmware.com \
  --version VERSION-NUMBER \
  --namespace tap-install \
  --values-file app-live-view-connector-values.yaml
```

Where `VERSION-NUMBER` is the version of the package listed. For example, `1.5.0-build.5`.

For example:

```
$ tanzu package install appliveview-connector \
  --package connector.appliveview.tanzu.vmware.com \
  --version 1.5.0-build.5 \
  --namespace tap-install \
  --values-file app-live-view-connector-values.yaml
| Installing package 'connector.appliveview.tanzu.vmware.com'
| Getting namespace 'tap-install'
| Getting package metadata for 'connector.appliveview.tanzu.vmware.com'
| Creating service account 'appliveview-connector-tap-install-sa'
| Creating cluster admin role 'appliveview-connector-tap-install-cluster-role'
| Creating cluster role binding 'appliveview-connector-tap-install-cluster-role
binding'
- Creating package resource
/ Package install status: Reconciling

Added installed package 'appliveview-connector' in namespace 'tap-install'
```

4. Verify the [Application Live View connector](#) package installation by running:

```
tanzu package installed get appliveview-connector -n tap-install
```

For example:

```
tanzu package installed get appliveview-connector -n tap-install
5s
| Retrieving installation details for appliveview-connector...
NAME:                appliveview-connector
PACKAGE-NAME:        connector.appliveview.tanzu.vmware.com
PACKAGE-VERSION:     1.5.0-build.5
STATUS:              Reconcile succeeded
CONDITIONS:          [{"ReconcileSucceeded True  }]
USEFUL-ERROR-MESSAGE:
```

Verify that `STATUS` is `Reconcile succeeded`.

Application Live View UI plug-in

The Application Live View UI plug-in is part of Tanzu Developer Portal. To override the default security settings for the Application Live View UI plug-in, take the following steps.

1. (Optional) Make changes to the default installation settings by running:

```
tanzu package available get tap-gui.tanzu.vmware.com/VERSION-NUMBER --values-sc
hema --namespace tap-install
```

Where `VERSION-NUMBER` is the number you discovered previously. For example, `1.4.6`.

For more information about values schema options, see the individual product documentation.

2. Create `tap-gui-values.yaml` and paste in the following code:

```
ingressEnabled: true
ingressDomain: "INGRESS-DOMAIN"
app_config:
  catalog:
    locations:
      - type: url
        target: https://GIT-CATALOG-URL/catalog-info.yaml
  appLiveView:
    activateAppLiveViewSecureAccessControl: false
```

Where:

- o `INGRESS-DOMAIN` is the subdomain for the host name that you point at the `tanzu-shared-ingress` service's External IP address.
- o `GIT-CATALOG-URL` is the path to the `catalog-info.yaml` catalog definition file from either the included Blank catalog (provided as an additional download named "Blank Tanzu Developer Portal Catalog") or a Backstage-compliant catalog that you've already built and posted on the Git infrastructure specified in [Add Tanzu Developer Portal integrations](#).

3. Install the package by running:

```
tanzu package install tap-gui \
  --package tap-gui.tanzu.vmware.com \
  --version VERSION \
  --namespace tap-install \
  --values-file tap-gui-values.yaml
```

Where `VERSION` is the version that you want. For example, `1.4.6`.

For example:

```
$ tanzu package install tap-gui \
  --package tap-gui.tanzu.vmware.com \
  --version 1.4.6 \
  --namespace tap-install \
  --values-file tap-gui-values.yaml
- Installing package 'tap-gui.tanzu.vmware.com'
| Getting package metadata for 'tap-gui.tanzu.vmware.com'
| Creating service account 'tap-gui-default-sa'
| Creating cluster admin role 'tap-gui-default-cluster-role'
| Creating cluster role binding 'tap-gui-default-cluster-rolebinding'
| Creating secret 'tap-gui-default-values'
- Creating package resource
- Package install status: Reconciling

Added installed package 'tap-gui' in namespace 'tap-install'
```

4. Verify that the package installed by running:

```
tanzu package installed get tap-gui -n tap-install
```

For example:

```
$ tanzu package installed get tap-gui -n tap-install
| Retrieving installation details for cc...
NAME:                tap-gui
```

```

PACKAGE-NAME:      tap-gui.tanzu.vmware.com
PACKAGE-VERSION:   1.4.6
STATUS:            Reconcile succeeded
CONDITIONS:       [{ReconcileSucceeded True  }]
USEFUL-ERROR-MESSAGE:

```

Verify that `STATUS` is `Reconcile succeeded`.

5. To access Tanzu Developer Portal, use the service you exposed in the `service_type` field in the values file.

Authorize a user to execute sensitive operations

You can limit the access to execute sensitive operations to specific users. This secures operations such as editing environment variables, downloading heap dump data, and changing log levels for applications.

To authorize a user to execute these sensitive operations:

1. Create a `ClusterRole` with a rule that specifies the `execute` verb for the `SensitiveOperationsAccess` resource and a corresponding `RoleBinding` to bind it to a user:

```

apiVersion: rbac.authorization.k8s.io/v1
kind: ClusterRole
metadata:
  name: alv-execute-sensitive-op-role
rules:
- apiGroups: ['appliveview.apps.tanzu.vmware.com']
  resources:
  - sensitiveoperationsaccesses
  verbs: ['execute']
---
apiVersion: rbac.authorization.k8s.io/v1
kind: RoleBinding
metadata:
  name: alice-alv-execute-sensitive-op-role-binding
  namespace: dev-team-1
roleRef:
  apiGroup: rbac.authorization.k8s.io
  kind: ClusterRole
  name: alv-execute-sensitive-op-role
subjects:
- kind: User
  name: "alice@example.com"
  apiGroup: rbac.authorization.k8s.io

```

2. If you are using service account to view resources on a cluster in Tanzu Developer Portal, create a `ClusterRole` with a rule that specifies the `execute` verb for the `SensitiveOperationsAccess` resource and a corresponding `RoleBinding` to bind it to the `tap-gui` service account:

```

apiVersion: rbac.authorization.k8s.io/v1
kind: ClusterRole
metadata:
  name: alv-execute-sensitive-op-role
rules:
- apiGroups: ['appliveview.apps.tanzu.vmware.com']
  resources:
  - sensitiveoperationsaccesses
  verbs: ['execute']
---
apiVersion: rbac.authorization.k8s.io/v1
kind: RoleBinding

```

```

metadata:
  name: alv-execute-sensitive-op-role-binding
  namespace: dev-team-1
subjects:
- kind: ServiceAccount
  namespace: tap-gui
  name: tap-gui-viewer
roleRef:
  kind: ClusterRole
  name: alv-execute-sensitive-op-role
  apiGroup: rbac.authorization.k8s.io

```

- (Optional) Edit the tap-gui cluster role `k8s-reader` to add a rule that specifies the `execute` verb for the `SensitiveOperationsAccess` resource in a single cluster setup:

```
kubectl edit clusterrole k8s-reader -n tap-gui
```

- Add the following rule to the cluster role:

```

- apiGroups: ['appliveview.apps.tanzu.vmware.com']
  resources:
  - sensitiveoperationsaccesses
  verbs: ['execute']

```



Note

Executing sensitive operations is deactivated by default. You can enable it at the cluster level by setting the `activateSensitiveOperations: true` key in the `appliveview_connector` config or at the individual user level by assigning the roles and permissions mentioned earlier.

Enabling Spring Boot apps for Application Live View

This topic for developers tells you how to configure a Spring Boot app for observation by Application Live View within Tanzu Application Platform (commonly known as TAP).

Enable Spring Boot apps

For Application Live View to interact with a Spring Boot app within Tanzu Application Platform, add the `spring-boot-starter-actuator` module dependency.

Add the maven dependency in `pom.xml` as follows:

```

<dependency>
  <groupId>org.springframework.boot</groupId>
  <artifactId>spring-boot-starter-actuator</artifactId>
</dependency>

```

Add the following plugin configuration in `pom.xml`:

```

<plugin>
  <groupId>org.springframework.boot</groupId>
  <artifactId>spring-boot-maven-plugin</artifactId>
  <executions>
    <execution>
      <goals>
        <goal>build-info</goal>
      </goals>
    </execution>
  </executions>
</plugin>

```

```

<configuration>
  <additionalProperties>
    <spring.boot.version>${project.parent.version}</spring.boot.version>
  </additionalProperties>
</configuration>
</execution>
</executions>
</plugin>

```

Add the preceding configuration to generate `build-info.properties` into your Spring Boot application. This information is then used to display the Spring Boot version that the app uses in Application Live View.

To enable Application Live View for Spring Boot apps, Spring Boot conventions automatically sets the Application Live View labels onto the PodSpec. For more information about the labels automatically set by Spring Boot conventions, see [Enable Application Live View for Spring Boot applications](#).

Enable Spring Boot 3 apps

For Application Live View to interact with a Spring Boot 3 app within Tanzu Application Platform, add the `spring-boot-starter-actuator` module dependency.

Add the maven dependency in `pom.xml` as follows:

```

<dependency>
  <groupId>org.springframework.boot</groupId>
  <artifactId>spring-boot-starter-actuator</artifactId>
</dependency>

```

Add the following plugin configuration in `pom.xml`:

```

<plugin>
  <groupId>org.springframework.boot</groupId>
  <artifactId>spring-boot-maven-plugin</artifactId>
  <executions>
    <execution>
      <goals>
        <goal>build-info</goal>
      </goals>
      <configuration>
        <additionalProperties>
          <spring.boot.version>${project.parent.version}</spring.boot.version>
        </additionalProperties>
      </configuration>
    </execution>
  </executions>
</plugin>

```

Add the preceding configuration to generate `build-info.properties` into your Spring Boot application. This information is then used to display the Spring Boot version that the app uses in Application Live View.

To enable Application Live View for Spring Boot 3 apps, Spring Boot conventions automatically sets the Application Live View labels onto the PodSpec. For more information about the labels automatically set by Spring Boot conventions, see [Enable Application Live View for Spring Boot applications](#).

Here is an example of creating a workload for a Spring Boot 3 Application:

```

tanzu apps workload create spring-boot-3 --git-repo https://github.com/martinlippert/s
b3-demo.git --git-branch main --annotation autoscaling.knative.dev/min-scale=1 --yes -

```



```
-label app.kubernetes.io/part-of=tanzu-java-web-app --type web --build-env "BP_JVM_VERSION=17" --label apps.tanzu.vmware.com/auto-configure-actuators="true"
```

Enable Spring Cloud Gateway apps

For Application Live View to interact with a Spring Cloud Gateway app within Tanzu Application Platform, add the `spring-boot-starter-actuator` and `spring-cloud-starter-gateway` module dependency.

Add the maven dependencies in `pom.xml` as follows:

```
<dependency>
  <groupId>org.springframework.boot</groupId>
  <artifactId>spring-boot-starter-actuator</artifactId>
</dependency>
<dependency>
  <groupId>org.springframework.cloud</groupId>
  <artifactId>spring-cloud-starter-gateway</artifactId>
</dependency>
```

To enable Application Live View on the Spring Cloud Gateway Tanzu Application Platform workload, Spring Boot conventions automatically applies labels on the workload, such as `tanzu.app.live.view.application.flavours: spring-boot_spring-cloud-gateway` and `tanzu.app.live.view: true`, based on the Spring Cloud Gateway image metadata.

Here is an example of creating a workload for a Spring Cloud Gateway Application:

```
tanzu apps workload create tanzu-scg-web-app --git-repo https://github.com/ksankaranara-vmw/gs-gateway.git --git-branch main --type web --label app.kubernetes.io/part-of=tanzu-scg-web-app --yes --annotation autoscaling.knative.dev/min-scale=1
```

Workload image NOT built with Tanzu Build Service

If your application image is NOT built with Tanzu Build Service, to enable Application Live View on `Spring Boot` Tanzu Application Platform workload, use the following command. For example:

```
tanzu apps workload create boot-app --type web --app boot-app --image <IMAGE NAME> --annotation autoscaling.knative.dev/min-scale=1 --yes --label tanzu.app.live.view=true --label tanzu.app.live.view.application.name=boot-app --label tanzu.app.live.view.application.flavours=spring-boot
```

If your application image is NOT built with Tanzu Build Service, to enable Application Live View on `Spring Cloud Gateway` Tanzu Application Platform workload, use the following command. For example:

```
tanzu apps workload create scg-app --type web --app scg-app --image <IMAGE NAME> --annotation autoscaling.knative.dev/min-scale=1 --yes --label tanzu.app.live.view=true --label tanzu.app.live.view.application.name=scg-app --label tanzu.app.live.view.application.flavours=spring-boot_spring-cloud-gateway
```

If your application image is NOT built with Tanzu Build Service, to enable Application Live View on `Steeltoe` Tanzu Application Platform workload, use the following command. For example:

```
tanzu apps workload create steeltoe-app --type web --app steeltoe-app --image <IMAGE NAME> --annotation autoscaling.knative.dev/min-scale=1 --yes --label tanzu.app.live.view=true --label tanzu.app.live.view.application.name=steeltoe-app --label tanzu.app.live.view.application.flavours=steeltoe
```

Enabling Spring Boot apps for Application Live View

This topic for developers tells you how to configure a Spring Boot app for observation by Application Live View within Tanzu Application Platform (commonly known as TAP).

Enable Spring Boot apps

For Application Live View to interact with a Spring Boot app within Tanzu Application Platform, add the `spring-boot-starter-actuator` module dependency.

Add the maven dependency in `pom.xml` as follows:

```
<dependency>
  <groupId>org.springframework.boot</groupId>
  <artifactId>spring-boot-starter-actuator</artifactId>
</dependency>
```

Add the following plugin configuration in `pom.xml`:

```
<plugin>
  <groupId>org.springframework.boot</groupId>
  <artifactId>spring-boot-maven-plugin</artifactId>
  <executions>
    <execution>
      <goals>
        <goal>build-info</goal>
      </goals>
      <configuration>
        <additionalProperties>
          <spring.boot.version>${project.parent.version}</spring.boot.version>
        </additionalProperties>
      </configuration>
    </execution>
  </executions>
</plugin>
```

Add the preceding configuration to generate `build-info.properties` into your Spring Boot application. This information is then used to display the Spring Boot version that the app uses in Application Live View.

To enable Application Live View for Spring Boot apps, Spring Boot conventions automatically sets the Application Live View labels onto the PodSpec. For more information about the labels automatically set by Spring Boot conventions, see [Enable Application Live View for Spring Boot applications](#).

Enable Spring Boot 3 apps

For Application Live View to interact with a Spring Boot 3 app within Tanzu Application Platform, add the `spring-boot-starter-actuator` module dependency.

Add the maven dependency in `pom.xml` as follows:

```
<dependency>
  <groupId>org.springframework.boot</groupId>
  <artifactId>spring-boot-starter-actuator</artifactId>
</dependency>
```

Add the following plugin configuration in `pom.xml`:

```
<plugin>
  <groupId>org.springframework.boot</groupId>
  <artifactId>spring-boot-maven-plugin</artifactId>
  <executions>
    <execution>
      <goals>
        <goal>build-info</goal>
      </goals>
      <configuration>
        <additionalProperties>
          <spring.boot.version>${project.parent.version}</spring.boot.version>
        </additionalProperties>
      </configuration>
    </execution>
  </executions>
</plugin>
```

Add the preceding configuration to generate `build-info.properties` into your Spring Boot application. This information is then used to display the Spring Boot version that the app uses in Application Live View.

To enable Application Live View for Spring Boot 3 apps, Spring Boot conventions automatically sets the Application Live View labels onto the PodSpec. For more information about the labels automatically set by Spring Boot conventions, see [Enable Application Live View for Spring Boot applications](#).

Here is an example of creating a workload for a Spring Boot 3 Application:

```
tanzu apps workload create spring-boot-3 --git-repo https://github.com/martinlippert/s
b3-demo.git --git-branch main --annotation autoscaling.knative.dev/min-scale=1 --yes -
-label app.kubernetes.io/part-of=tanzu-java-web-app --type web --build-env "BP_JVM_VER
SION=17" --label apps.tanzu.vmware.com/auto-configure-actuators="true"
```

Enable Spring Cloud Gateway apps

For Application Live View to interact with a Spring Cloud Gateway app within Tanzu Application Platform, add the `spring-boot-starter-actuator` and `spring-cloud-starter-gateway` module dependency.

Add the maven dependencies in `pom.xml` as follows:

```
<dependency>
  <groupId>org.springframework.boot</groupId>
  <artifactId>spring-boot-starter-actuator</artifactId>
</dependency>
<dependency>
  <groupId>org.springframework.cloud</groupId>
  <artifactId>spring-cloud-starter-gateway</artifactId>
</dependency>
```

To enable Application Live View on the Spring Cloud Gateway Tanzu Application Platform workload, Spring Boot conventions automatically applies labels on the workload, such as `tanzu.app.live.view.application.flavours: spring-boot_spring-cloud-gateway` and `tanzu.app.live.view: true`, based on the Spring Cloud Gateway image metadata.

Here is an example of creating a workload for a Spring Cloud Gateway Application:

```
tanzu apps workload create tanzu-scg-web-app --git-repo https://github.com/ksankaranar
a-vmw/gw-gateway.git --git-branch main --type web --label app.kubernetes.io/part-of=ta
nzu-scg-web-app --yes --annotation autoscaling.knative.dev/min-scale=1
```

Workload image NOT built with Tanzu Build Service

If your application image is NOT built with Tanzu Build Service, to enable Application Live View on [Spring Boot](#) Tanzu Application Platform workload, use the following command. For example:

```
tanzu apps workload create boot-app --type web --app boot-app --image <IMAGE NAME> --annotation autoscaling.knative.dev/min-scale=1 --yes --label tanzu.app.live.view=true --label tanzu.app.live.view.application.name=boot-app --label tanzu.app.live.view.application.flavours=spring-boot
```

If your application image is NOT built with Tanzu Build Service, to enable Application Live View on [Spring Cloud Gateway](#) Tanzu Application Platform workload, use the following command. For example:

```
tanzu apps workload create scg-app --type web --app scg-app --image <IMAGE NAME> --annotation autoscaling.knative.dev/min-scale=1 --yes --label tanzu.app.live.view=true --label tanzu.app.live.view.application.name=scg-app --label tanzu.app.live.view.application.flavours=spring-boot_spring-cloud-gateway
```

If your application image is NOT built with Tanzu Build Service, to enable Application Live View on [Steeltoe](#) Tanzu Application Platform workload, use the following command. For example:

```
tanzu apps workload create steeltoe-app --type web --app steeltoe-app --image <IMAGE NAME> --annotation autoscaling.knative.dev/min-scale=1 --yes --label tanzu.app.live.view=true --label tanzu.app.live.view.application.name=steeltoe-app --label tanzu.app.live.view.application.flavours=steeltoe
```

Enable Spring Native apps for Application Live View

This topic for developers tells you how to configure a Spring Native app to be observed by Application Live View within Tanzu Application Platform (commonly known as TAP).

Procedure

For Application Live View to interact with a Spring Native app within Tanzu Application Platform:

1. Add the `spring-boot-starter-actuator` module dependency for Maven in `pom.xml` as follows:

```
<dependency>
  <groupId>org.springframework.boot</groupId>
  <artifactId>spring-boot-starter-actuator</artifactId>
</dependency>
```

2. Add a native profile that includes the `native-maven-plugin` for the build phase in `pom.xml`:

```
<profiles>
  <profile>
    <id>native</id>
    <build>
      <plugins>
        <plugin>
          <groupId>org.graalvm.buildtools</groupId>
          <artifactId>native-maven-plugin</artifactId>
        </plugin>
      </plugins>
    </build>
  </profile>
</profiles>
```

**Note**

For Maven based projects, you must add the `org.graalvm.buildtools` build plug-in and configure it to execute when the native profile is active.

3. Add the following configuration in `pom.xml` to generate `build-info.properties` into your Spring Boot application. Application Live View uses this information to display the Spring Boot version that the app uses.

```
<plugin>
  <groupId>org.springframework.boot</groupId>
  <artifactId>spring-boot-maven-plugin</artifactId>
  <executions>
    <execution>
      <goals>
        <goal>build-info</goal>
      </goals>
      <configuration>
        <additionalProperties>
          <spring.boot.version>${project.parent.version}</spring.boot.version>
        </additionalProperties>
      </configuration>
    </execution>
  </executions>
</plugin>
```

4. Create a workload for the Spring Native application. For example:

```
tanzu apps workload create spring-cloud-serverless \
--git-repo https://github.com/vudayani-vmw/spring-cloud-serverless --git-branch
main \
--type web --label apps.tanzu.vmware.com/auto-configure-actuators=true \
--label app.kubernetes.io/part-of=spring-cloud-serverless --yes \
--annotation autoscaling.knative.dev/min-scale=1 \
--build-env "BP_JVM_VERSION=17" --build-env "BP_NATIVE_IMAGE=true" \
--build-env "BP_MAVEN_BUILD_ARGUMENTS= -Pnative -Dmaven.test.skip=true" \
--no-transfer-progress package \
-Dspring-boot.aot.jvmArguments='-Dmanagement.endpoint.health.probes.add-additio
nal-paths=true' \
-Dmanagement.endpoint.health.show-details='always' \
-Dmanagement.endpoints.web.base-path='/actuator' \
-Dmanagement.endpoints.web.exposure.include='*' \
-Dmanagement.health.probes.enabled='true' \
-Dmanagement.server.port=8081 -Dserver.port=8080' " \
--env MANAGEMENT_SERVER_PORT=8081 \
--env MANAGEMENT_ENDPOINT_HEALTH_PROBES_ADD_ADDITIONAL_PATHS=true \
--env MANAGEMENT_ENDPOINT_HEALTH_SHOW_DETAILS=always \
--env MANAGEMENT_ENDPOINTS_WEB_BASE_PATH="/actuator" \
--env MANAGEMENT_ENDPOINTS_WEB_EXPOSURE_INCLUDE="*" \
--env MANAGEMENT_HEALTH_PROBES_ENABLED=true \
--env SERVER_PORT=8080
```

When you run `tanzu apps workload create`:

- o Configure all the required build arguments and environment variables to build a native executable as shown in the code snippet. The build environment variables are required to enable native build profile and native image building.
- o To override configuration options at runtime, provide AOT (Ahead-Of-Time) configuration to the build process using the `spring-boot.aot.jvmArguments` option.

**Note**

For Gradle builds, the `spring-boot.aot.jvmArguments` is set as part of `BP_GRADLE_ADDITIONAL_BUILD_ARGUMENTS` build environment variable.

The Spring Boot conventions set the Application Live View labels onto the PodSpec to enable Application Live View.

Enable Steeltoe apps for Application Live View

This topic for developers tells you how to extend .NET Core Apps to Steeltoe apps and enable Application Live View on Steeltoe workloads within Tanzu Application Platform (commonly known as TAP).

Application Live View supports Steeltoe .NET apps with .NET core runtime version `v6.0.8`.

Extend .NET Core Apps to Steeltoe Apps

A .NET Core application can be extended to a Steeltoe application by adding independent NuGet packages.

To enable the Actuators on a .NET Core App:

1. Add a PackageReference to your `.csproj` file:

```
<PackageReference Include="Steeltoe.Management.EndpointCore" Version="$(SteeltoeVersion)" />
```

**Note**

The PackageReference is expected to change to `Steeltoe.Management.Endpoint` from version Steeltoe 4.0 onwards.

2. Call the extension `AddAllActuators` in your `Program.cs` file:

```
builder.WebHost.AddAllActuators();
```

3. (Optional) You can add app-specific configurations, such as the following.

To expose all management actuator endpoints except `env` endpoint, add the following configuration to your `appsettings.json` file:

```
{
  "Management": {
    "Endpoints": {
      "Actuator": {
        "Exposure": {
          "Include": [ "*" ],
          "Exclude": [ "env" ]
        }
      }
    }
  }
}
```

To enable logging, add the following configuration to your `appsettings.json` file:

```
{
  "Logging": {
    "LogLevel": {
      "Default": "Information",
      "Microsoft": "Warning",
      "Steeltoe": "Warning",
      "Sample": "Information"
    }
  }
}
```

To enable heapdump, add the following configuration to your `appsettings.json` file:

```
{
  "Management": {
    "Endpoints": {
      "HeapDump": {
        "HeapDumpType": "Normal"
      }
    }
  }
}
```

Enable Application Live View on Steeltoe Tanzu Application Platform workload

You can enable Application Live View to interact with a Steeltoe app within Tanzu Application Platform.

To enable Application Live View on the Steeltoe Tanzu Application Platform workload, the Application Live View convention service automatically applies labels on the workload, such as `tanzu.app.live.view.application.flavours: steeltoe` and `tanzu.app.live.view: true`, based on the Steeltoe image metadata.

Here's an example of creating a workload for a Steeltoe Application:

```
tanzu apps workload create steeltoe-app --type web --git-repo https://github.com/vmware-e-tanzu/application-accelerator-samples --sub-path weatherforecast-steeltoe --git-branch main --annotation autoscaling.knative.dev/min-scale=1 --yes --label app.kubernetes.io/part-of=sample-app
```

If your application image is NOT built with Tanzu Build Service, to enable Application Live View on Steeltoe Tanzu Application Platform workload, use the following command. For example:

```
tanzu apps workload create steeltoe-app --type web --app steeltoe-app --image IMAGE-NAME --annotation autoscaling.knative.dev/min-scale=1 --yes --label tanzu.app.live.view=true --label tanzu.app.live.view.application.name=steeltoe-app --label tanzu.app.live.view.application.flavours=steeltoe
```

Where `IMAGE-NAME` is the name of your application image.



Note

Thread metrics is available in SteeltoeVersion `3.2.*`. To enable the Threads page in the Application Live View UI, add the following configuration to your `.csproj` file:

```
<PropertyGroup>
  <SteeltoeVersion>3.2.*</SteeltoeVersion>
```

```
</PropertyGroup>
```

Application Live View convention server

This topic provides information about Application Live View convention, which provides a Webhook handler for [Cartographer Conventions](#).

Role of Application Live View convention

Application Live View conventions works in conjunction with core Cartographer Conventions. It enhances Tanzu PodIntents with metadata such as labels, annotations, or app properties. This metadata allows Application Live View, specifically the connector, to discover app instances so that Application Live View can access the actuator data from those workloads.



Note

Application Live View conventions now supports only Steeltoe applications. Spring Boot conventions supports both Spring Boot and Spring Cloud Gateway applications. For more information about Spring Boot conventions, see [Enable Application Live View with Spring Boot apps](#)

To run Application Live View with Steeltoe apps, the Spring Boot convention recognizes PodIntents and adds the following metadata labels:

- `tanzu.app.live.view: "true"`: Enables the connector to observe application pod.
- `tanzu.app.live.view.application.name: APPLICATION-NAME`: Identifies the app name to be used internally by Application Live View.
- `tanzu.app.live.view.application.actuator.port: ACTUATOR-PORT`: Identifies the port on the pod at which the actuators are available for Application Live View.
- `tanzu.app.live.view.application.flavours: steeltoe`: Exposes the framework flavor of the app.

These metadata labels allow Application Live View to identify pods that are enabled for Application Live View. The metadata labels also tell the Application Live View connector what kind of app it is, and on which port the actuators are accessible for Application Live View.

Description of metadata labels

If a workload resource explicitly defines a label under `metadata.labels` in the `workload.yaml`, then the convention service detects the presence of that label and respects its value. When deploying a workload using Tanzu Application Platform, you can override the labels listed in the following table using the [Workload](#) YAML.

Metadata	Default	Type	Description
<code>tanzu.app.live.view</code>	<code>true</code>	Label	When deploying a workload in Tanzu Application Platform, this label is set to <code>true</code> as default across the supply chain.
<code>tanzu.app.live.view.application.name</code>	<code>steeltoe-app</code>	Label	When deploying a workload in Tanzu Application Platform, this label is set to <code>steeltoe-app</code> if the container image metadata does not contain the app name. Otherwise, the label is set to the app name from container image metadata.

Metadata	Default	Type	Description
<code>tanzu.app.live.view.application flavours</code>	<code>steeltoe</code>	Label	When deploying a Spring Boot workload in Tanzu Application Platform, this label is set to <code>steeltoe</code> as default across the supply chain.

Verify the applied labels and annotations

You can verify the applied labels and annotations by running:

```
kubectl get podintents.conventions.carto.run WORKLOAD-NAME -o yaml
```

Where `WORKLOAD-NAME` is the name of the deployed workload, for example `steeltoe-app`.

Expected output for Steeltoe workload:

```
apiVersion: conventions.carto.run/v1alpha1
kind: PodIntent
metadata:
  creationTimestamp: "2022-11-14T09:56:53Z"
  generation: 1
  labels:
    app.kubernetes.io/component: intent
    app.kubernetes.io/part-of: sample-app
    apps.tanzu.vmware.com/workload-type: web
    carto.run/cluster-template-name: convention-template
    carto.run/resource-name: config-provider
    carto.run/supply-chain-name: source-to-url
    carto.run/template-kind: ClusterConfigTemplate
    carto.run/workload-name: steeltoe-app
    carto.run/workload-namespace: default
  name: steeltoe-app
  namespace: default
  ownerReferences:
  - apiVersion: carto.run/v1alpha1
    blockOwnerDeletion: true
    controller: true
    kind: Workload
    name: steeltoe-app
    uid: 97897399-807a-4815-9693-fb06bb4bcled
  resourceVersion: "428904"
  uid: 0c74e045-075c-4af3-beef-b092b951be7f
spec:
  serviceAccountName: default
  template:
    metadata:
      annotations:
        autoscaling.knative.dev/min-scale: "1"
        developer.conventions/target-containers: workload
      labels:
        app.kubernetes.io/component: run
        app.kubernetes.io/part-of: sample-app
        apps.tanzu.vmware.com/workload-type: web
        carto.run/workload-name: steeltoe-app
    spec:
      containers:
      - image: registry.example.com/app-live-view/test/steeltoe-app-default@sha256:c8e
a14d8714ec31ad978085ebff43d15679613a0c12df37812adf22cb47b5232
        name: workload
        resources: {}
        securityContext:
          runAsUser: 1000
        serviceAccountName: default
  status:
```

```

conditions:
- lastTransitionTime: "2022-11-14T09:56:57Z"
  message: ""
  reason: Applied
  status: "True"
  type: ConventionsApplied
- lastTransitionTime: "2022-11-14T09:56:57Z"
  message: ""
  reason: ConventionsApplied
  status: "True"
  type: Ready
observedGeneration: 1
template:
  metadata:
    annotations:
      autoscaling.knative.dev/min-scale: "1"
      conventions.carto.run/applied-conventions: |-
        spring-boot-convention/auto-configure-actuators-check
        spring-boot-convention/app-live-view-appflavour-check
        appliveview-sample/app-live-view-appflavour-check
        appliveview-sample/app-live-view-connector-steeltoe
        appliveview-sample/app-live-view-appflavours-steeltoe
      developer.conventions/target-containers: workload
    labels:
      app.kubernetes.io/component: run
      app.kubernetes.io/part-of: sample-app
      apps.tanzu.vmware.com/workload-type: web
      carto.run/workload-name: steeltoe-app
      tanzu.app.live.view: "true"
      tanzu.app.live.view.application.flavours: steeltoe
      tanzu.app.live.view.application.name: steeltoe-app
  spec:
    containers:
    - image: registry.example.com/app-live-view/test/steeltoe-app-default@sha256:c8e
      a14d8714ec31ad978085ebff43d15679613a0c12df37812adf22cb47b5232
      name: workload
      resources: {}
      securityContext:
        runAsUser: 1000
      serviceAccountName: default

```

In your output:

- `status.template.metadata.labels` shows the list of applied labels by Application Live View convention server.
- `status.template.metadata.annotations` shows the list of applied annotations by Application Live View convention server.

Custom configuration for the connector

This topic for developers tells you how to custom configure an app or workload for Application Live View.

The connector component is responsible for discovering the app and registering it with Application Live View. Labels from the app PodSpec are used to discover the app and configure the connector to access the actuator data of the app.

Usually, Application Live View conventions applies the necessary configuration automatically. To deactivate the convention and configure the app and the workload manually, the list of labels in the following table gives you an overview of the options:

Label Name	Mandatory	Type	Default	Significance
<code>tanzu.app.live.view</code>	true	Boolean	None	Toggle to activate or deactivate pod discovery
<code>tanzu.app.live.view.application.name</code>	true	String	None	Application name
<code>tanzu.app.live.view.application.port</code>	false	Integer	8080	Application port
<code>tanzu.app.live.view.application.path</code>	false	String	/	Application context path
<code>tanzu.app.live.view.application.actuator.port</code>	false	Integer	8080	Application actuator port
<code>tanzu.app.live.view.application.actuator.path</code>	false	String	/actuator	Actuator context path
<code>tanzu.app.live.view.application.protocol</code>	false	http / https	http	Protocol scheme
<code>tanzu.app.live.view.application.actuator.health.port</code>	false	Integer	8080	Health endpoint port
<code>tanzu.app.live.view.application.flavours</code>	false	Comma separated string	spring-boot, spring-cloud-gateway	Application flavors

You can add connector labels in the app `Workload` or override labels that the convention applies, such as `tanzu.app.live.view` and `tanzu.app.live.view.application.name`. If you do not want Application Live View to observe your app, you can override the existing label

```
tanzu.app.live.view: "false".
```

Configure the developer workload in Tanzu Application Platform

The following YAML is an example of a Spring PetClinic workload that overrides the connector label to `tanzu.app.live.view: "false"`:

```
apiVersion: carto.run/v1alpha1
kind: Workload
metadata:
  name: spring-petclinic
  namespace: default
  labels:
    tanzu.app.live.view: "false"
    app.kubernetes.io/part-of: tanzu-java-web-app
    apps.tanzu.vmware.com/workload-type: web
  annotations:
    autoscaling.knative.dev/minScale: "1"
spec:
  source:
    git:
      ref:
        branch: main
      url: https://github.com/kdvolder/spring-petclinic
```

Deploy the workload

To deploy the workload, run:

```
kapp -y deploy -n default -a workloads -f workloads.yaml
```

Verify the label has propagated through the Supply Chain

To verify the label:

1. Verify that the workload build is successful by ensuring that `SUCCEEDED` is set to `True`:

```
kubectl get builds
NAME                                IMAGE
SUCCEEDED
spring-petclinic-build-1            registry.example.com/app-live-view/test/spring-pet
clinic-default@sha256:9db2a8a8e77e9215239431fd8afe3f2ecdf09cce8afac565dad7b5f0c
5ac0cdf                            True
```

2. Verify the PodIntent of your workload by ensuring `status.template.metadata.labels` shows the newly added label has propagated through the Supply Chain:

```
kubectl get podintents.conventions.carto.run spring-petclinic -oyaml

status:
  conditions:
  - lastTransitionTime: "2021-12-03T15:14:33Z"
    status: "True"
    type: ConventionsApplied
  - lastTransitionTime: "2021-12-03T15:14:33Z"
    status: "True"
    type: Ready
  observedGeneration: 3
  template:
    metadata:
      annotations:
        autoscaling.knative.dev/minScale: "1"
        boot.spring.io/actuator: http://:8080/actuator
        boot.spring.io/version: 2.5.6
        conventions.carto.run/applied-conventions: |-
          appliveview-sample/app-live-view-connector-boot
          appliveview-sample/app-live-view-appflavours-boot
          appliveview-sample/app-live-view-systemproperties
          spring-boot-convention/spring-boot
          spring-boot-convention/spring-boot-graceful-shutdown
          spring-boot-convention/spring-boot-web
          spring-boot-convention/spring-boot-actuator
          spring-boot-convention/service-intent-mysql
        developer.conventions/target-containers: workload
        kapp.k14s.io/identity: v1;default/carto.run/Workload/spring-petclinic;c
        carto.run/v1alpha1
        kapp.k14s.io/original: '{"apiVersion":"carto.run/v1alpha1","kind":"Work
        load","metadata":{"annotations":{"autoscaling.knative.dev/minScale":"2"},"label
        s":{"app.kubernetes.io/part-of":"tanzu-java-web-app","apps.tanzu.vmware.com/wor
        kload-type":"web","kapp.k14s.io/app":"1638455805474051000","kapp.k14s.io/associ
        ation":"v1.5a9384bd7b93ca74ef494c4dec2caa4b","tanzu.app.live.view":"false"},"na
        me":"spring-petclinic","namespace":"default"},"spec":{"source":{"git":{"ref":
        {"branch":"main"},"url":"https://github.com/ksankaranara-vmw/spring-petclini
        c"}}}}}'
        kapp.k14s.io/original-diff-md5: 58e0494c51d30eb3494f7c9198986bb9
        services.conventions.carto.run/mysql: mysql-connector-java/8.0.27
      labels:
        app.kubernetes.io/component: run
        app.kubernetes.io/part-of: tanzu-java-web-app
        apps.tanzu.vmware.com/workload-type: web
        carto.run/workload-name: spring-petclinic
        conventions.carto.run/framework: spring-boot
```

```
kapp.k14s.io/app: "1638455805474051000"
kapp.k14s.io/association: v1.5a9384bd7b93ca74ef494c4dec2caa4b
services.conventions.carto.run/mysql: workload
tanzu.app.live.view: "false"
tanzu.app.live.view.application.flavours: spring-boot
tanzu.app.live.view.application.name: petclinic
```

3. Verify the ConfigMap was created for the app by ensuring `metadata.labels` shows the newly added label has propagated through the Supply Chain:

```
kubectl describe configmap spring-petclinic
Name:          spring-petclinic
Namespace:    default
Labels:       carto.run/cluster-supply-chain-name=source-to-url
              carto.run/cluster-template-name=config-template
              carto.run/resource-name=app-config
              carto.run/template-kind=ClusterConfigTemplate
              carto.run/workload-name=spring-petclinic
              carto.run/workload-namespace=default
Annotations:  <none>

Data
====
delivery.yml:
-----
apiVersion: serving.knative.dev/v1
kind: Service
metadata:
  name: spring-petclinic
  labels:
    app.kubernetes.io/part-of: tanzu-java-web-app
    apps.tanzu.vmware.com/workload-type: web
    kapp.k14s.io/app: "1638455805474051000"
    kapp.k14s.io/association: v1.5a9384bd7b93ca74ef494c4dec2caa4b
    tanzu.app.live.view: "false"
    app.kubernetes.io/component: run
    carto.run/workload-name: spring-petclinic
```

4. Verify the running Knative application pod by ensuring `labels` shows the newly added label on the Knative application pod:

```
kubectl get pods -o yaml spring-petclinic-00002-deployment-77dbb85c65-cf7rn | g
rep labels
  kapp.k14s.io/original: '{"apiVersion":"carto.run/v1alpha1","kind":"Workloa
d","metadata":{"annotations":{"autoscaling.knative.dev/minScale":"1"},"labels":
{"app.kubernetes.io/part-of":"tanzu-java-web-app","apps.tanzu.vmware.com/worklo
ad-type":"web","kapp.k14s.io/app":"1638455805474051000","kapp.k14s.io/associati
on":"v1.5a9384bd7b93ca74ef494c4dec2caa4b","tanzu.app.live.view":"false"},"nam
e":"spring-petclinic","namespace":"default"},"spec":{"source":{"git":{"ref":{"b
ranch":"main"},"url":"https://github.com/ksankaranara-vmw/spring-petclini
c"}}}}'
```

You can add or override the connector in the `Workload` of your Knative app.

Custom configuration for application actuator endpoints

This topic for developers tells you how to configure the Application Live View connector component to access actuator endpoints for custom settings, such as a different base path. By default, the actuator endpoint for an application is exposed on `/actuator`.

The following table describes the actuator configuration scenarios and the associated labels to use, assuming that the app runs on port `8080`:

management.server.base-path	management.server.port	management.endpoints.web.base-path	server.servlet.context.path	Comments	Connector Configuration
None	None	None	None	Actuators endpoints available at localhost:8080/actuator	tanzu.app.live.view.application.actuator.path=actuator, tanzu.app.live.view.application.actuator.port=8080
/path	8082	/	None	Actuator endpoints available at localhost:8082/path	tanzu.app.live.view.application.actuator.path=path, tanzu.app.live.view.application.actuator.port=8082
/path	8082	/manage/actuator	None	Actuator endpoints available at localhost:8082/path/manage/actuator	tanzu.app.live.view.application.actuator.path=path/manage/actuator, tanzu.app.live.view.application.actuator.port=8082
None	None	/	None	Actuators are deactivated to avoid conflicts	None
None	None	/manage	None	Actuator endpoints available at /manage	tanzu.app.live.view.application.actuator.path=manage, tanzu.app.live.view.application.actuator.port=8080
/path	8082	None	None	Actuator endpoints available at localhost:8082/path/actuator	tanzu.app.live.view.application.actuator.path=path/actuator, tanzu.app.live.view.application.actuator.port=8082

management.server.base-path	management.server.port	management.endpoints.web.base-path	server.servlet.context.path	Comments	Connector Configuration
/	8082	None	None	Actuator endpoints available at localhost:8082/actuator	tanzu.app.live.view.application.actuator.path=actuator, tanzu.app.live.view.application.actuator.port=8082
None	None	None	/api	Actuator endpoints available at localhost:8080/api/actuator	tanzu.app.live.view.application.actuator.path=api/actuator, tanzu.app.live.view.application.actuator.port=8080
/path	8082	None	/api	Actuator endpoints available at localhost:8082/path/actuator	tanzu.app.live.view.application.actuator.path=path/actuator, tanzu.app.live.view.application.actuator.port=8082
/path	8082	/manage	/api	Actuator endpoints available at localhost:8082/path/manage	tanzu.app.live.view.application.actuator.path=path/manage, tanzu.app.live.view.application.actuator.port=8082
/path	None	/manage	/api	Actuator endpoints available at localhost:8080/api/manage	tanzu.app.live.view.application.actuator.path=api/manage, tanzu.app.live.view.application.actuator.port=8080
/path	None	/	/api	Actuators are deactivated to avoid conflicts	None

management.server.base-path	management.server.port	management.endpoints.web.base-path	server.servlet.context.path	Comments	Connector Configuration
/path	8082	/	/api	Actuator endpoints available at localhost:8082/path	tanzu.app.live.view.application.actuator.path=path, tanzu.app.live.view.application.actuator.port=8082
None	None	/manage	/api	Actuator endpoints available at localhost:8080/api/manage	tanzu.app.live.view.application.actuator.path=api/manage, tanzu.app.live.view.application.actuator.port=8080

Scaling Knative apps in Tanzu Application Platform

This topic tells you how to use Application Live View when scaling Knative apps or developer workloads in Tanzu Application Platform (commonly known as TAP).

Application Live View is focused on monitoring apps for a **live** window and does not apply to any of the apps that are scaled down to zero. The intended behavior for Knative apps is to keep track of revisions to allow you to rollback easily, but also scale all of the unused revision instances down to zero to keep resource consumption low.

You can configure Knative apps to set `autoscaling.knative.dev/minScale` to `1` so that Application Live View can still observe app instance. This ensures that there is at least one instance of the latest revision, while still scaling down the older instances.

You can configure any app in Tanzu Application Platform using the `Workload` resource. To scale a Knative app, add the annotation `autoscaling.knative.dev/minScale` in the `Workload` and set it to the value you want. For Application Live View to observe an app and have at least one instance of the latest revision, set `autoscaling.knative.dev/minScale = "1"`.

The annotations or labels in the `Workload` get propagated through the Tanzu Application Platform supply chain as follows:

Workload > PodIntent > ConfigMap > Push Config > to repository/registry > git-repository/imagerepository picks the Config from repository/registry > kapp-ctrl deploys and knative runs the config > final pod running on the Kubernetes cluster.

Configure the developer workload in Tanzu Application Platform

The following YAML is an example `Workload` that adds the annotation `autoscaling.knative.dev/minScale = "1"` to set the minimum scale for the `spring-petclinic` app:

```
apiVersion: carto.run/v1alpha1
kind: Workload
metadata:
  name: spring-petclinic
```



```

namespace: default
labels:
  app.kubernetes.io/part-of: tanzu-java-web-app
  apps.tanzu.vmware.com/workload-type: web
annotations:
  autoscaling.knative.dev/minScale: "1"
spec:
  source:
    git:
      ref:
        branch: main
      url: https://github.com/kdvolder/spring-petclinic

```

Deploy the workload

To deploy the workload, run:

```
kapp -y deploy -n default -a workloads -f workloads.yaml
```

Verify the annotation has propagated through the Supply Chain

To verify the annotation:

1. Verify that the workload build is successful by ensuring that `SUCCEEDED` is set to `True`:

```

kubect1 get builds
NAME                                IMAGE
SUCCEEDED
spring-petclinic-build-1            registry.example.com/app-live-view/test/spring-pet
clinic-default@sha256:9db2a8a8e77e9215239431fd8afe3f2ecdf09cce8afac565dad7b5f0c
5ac0cdf                            True

```

2. Verify the PodIntent of your workload by ensuring `status.template.metadata.annotations` shows the newly added annotation has propagated through the Supply Chain:

```

kubect1 get podintents.conventions.carto.run spring-petclinic -oyaml

status:
  conditions:
    - lastTransitionTime: "2021-12-03T15:14:33Z"
      status: "True"
      type: ConventionsApplied
    - lastTransitionTime: "2021-12-03T15:14:33Z"
      status: "True"
      type: Ready
  observedGeneration: 3
  template:
    metadata:
      annotations:
        autoscaling.knative.dev/minScale: "1"

```

3. Verify the ConfigMap was created for the app by ensuring `spec.template.metadata.annotations` shows the newly added annotation has propagated through the Supply Chain:

```

kubect1 describe configmap spring-petclinic
Name:            spring-petclinic
Namespace:       default
Labels:          carto.run/cluster-supply-chain-name=source-to-url

```

```

      carto.run/cluster-template-name=config-template
      carto.run/resource-name=app-config
      carto.run/template-kind=ClusterConfigTemplate
      carto.run/workload-name=spring-petclinic
      carto.run/workload-namespace=default
Annotations:  <none>

Data
====
delivery.yml:
----
apiVersion: serving.knative.dev/v1
kind: Service
metadata:
  name: spring-petclinic
  labels:
    app.kubernetes.io/part-of: tanzu-java-web-app
    apps.tanzu.vmware.com/workload-type: web
    kapp.k14s.io/app: "1638455805474051000"
    kapp.k14s.io/association: v1.5a9384bd7b93ca74ef494c4dec2caa4b
    tanzu.app.live.view: "false"
    app.kubernetes.io/component: run
    carto.run/workload-name: spring-petclinic
spec:
  template:
    metadata:
      annotations:
        autoscaling.knative.dev/minScale: "1"

```

4. Verify the running Knative application pod by ensuring `annotations` shows the newly added annotation on the Knative application pod:

```

kubect1 get pods -o yaml spring-petclinic-00002-deployment-77dbb85c65-cf7rn | g
rep annotations
  annotations:
    kapp.k14s.io/original: '{"apiVersion":"carto.run/v1alpha1","kind":"Workloa
d","metadata":{"annotations":{"autoscaling.knative.dev/minScale":"1"},"labels":
{"app.kubernetes.io/part-of":"tanzu-java-web-app","apps.tanzu.vmware.com/worklo
ad-type":"web","kapp.k14s.io/app":"1638455805474051000","kapp.k14s.io/associati
on":"v1.5a9384bd7b93ca74ef494c4dec2caa4b","tanzu.app.live.view":"false"},"nam
e":"spring-petclinic","namespace":"default"},"spec":{"source":{"git":{"ref":{"b
ranch":"main"},"url":"https://github.com/ksankaranara-vmw/spring-petclini
c"}}}}'

```

Your Knative app is now set to a minimum scale of one so that Application Live View can observe the instance of the app.

Application Live View on OpenShift

Application Live View must run with a custom SecurityContextConstraint (SCC) to enable compliance with restricted Kubernetes Pod Security Standards on Openshift. Tanzu Application Platform configures the following SCC for Application Live View back end, Application Live View connector, and Application Live View convention service when you configure the `kubernetes_distribution: openshift` key in the `tap-values.yaml` file.

The following is a `SecurityContextConstraints` specification for Application Live View connector:

```

---
apiVersion: security.openshift.io/v1
kind: SecurityContextConstraints
metadata:
  name: appliveview-connector-restricted-with-seccomp
allowHostDirVolumePlugin: false

```

```

allowHostIPC: false
allowHostNetwork: false
allowHostPID: false
allowHostPorts: false
allowPrivilegeEscalation: false
allowPrivilegedContainer: false
allowedCapabilities: null
defaultAddCapabilities: null
fsGroup:
  type: MustRunAs
priority: null
readOnlyRootFilesystem: false
requiredDropCapabilities:
  - ALL
runAsUser:
  type: MustRunAsNonRoot
seLinuxContext:
  type: MustRunAs
supplementalGroups:
  type: RunAsAny
volumes:
  - configMap
  - downwardAPI
  - emptyDir
  - persistentVolumeClaim
  - projected
  - secret
seccompProfiles:
  - runtime/default

```

The preceding `SecurityContextConstraints` specification is applicable to Application Live View back end and Application Live View convention service as well.

Support for polyglot apps with Application Live View

Application Live View currently supports Spring Boot, Spring Cloud Gateway, and Steeltoe apps.

- To enable Application Live View on Spring Boot and Spring Cloud Gateway apps, see [Enable Application Live View for Spring Boot apps](#).
- To enable Application Live View on Steeltoe apps, see [Enable Application Live View for Steeltoe apps](#).

Application Live View internal architecture

This topic describes the architecture of Application Live View and its components. You can deploy this system on a Kubernetes stack and use it to monitor containerized apps on hosted cloud platforms or on-premises.

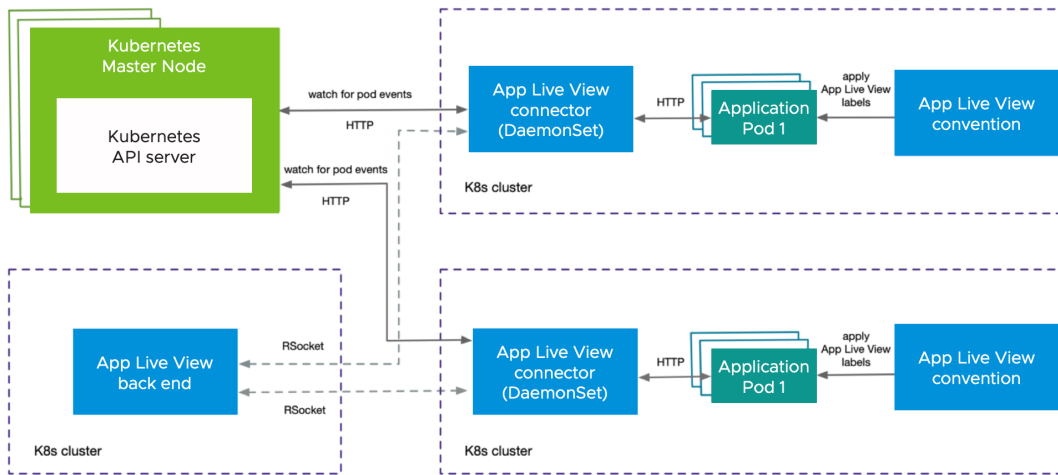

Component overview

Application Live View includes the following components as shown in the architecture diagram:

- **Application Live View back end**

Application Live View back end is the central server component that contains a list of registered apps. It provides a REST API that fetches the actuator data for the applications. The Application Live View UI plug-in, as part of Tanzu Developer Portal (formerly named Tanzu Application Platform GUI), queries this back-end REST API to get live actuator information for the pod.

- **Application Live View connector**

Application Live View connector is the component responsible for discovering the app pods running on the Kubernetes cluster and registering the instances to the Application Live View back end for it to be observed. The Application Live View connector is also responsible for proxying the actuator queries to the app pods running in the Kubernetes cluster. The actuator data is then displayed in the Application Live View UI plug-in as part of Tanzu Developer Portal.

You can deploy Application Live View connector in two modes:

- **Cluster access:** Deploy as a Kubernetes DaemonSet to discover apps across all the namespaces running in a worker node of a Kubernetes cluster. This is the default mode of Application Live View connector.
- **Namespace scoped:** Deploy as a Kubernetes Deployment to discover apps running within a namespace across worker nodes of Kubernetes cluster.

- **Application Live View convention server**

This component provides a webhook handler for the Tanzu convention controller. The webhook handler is registered with Tanzu convention controller. The webhook handler detects supply-chain workloads running a Spring Boot. Such workloads are annotated automatically to enable Application Live View to monitor them.

- **Application Live View APIServer**

Application Live View APIServer generates a unique token when a user receives access validation to a pod. The Application Live View connector component verifies the token against the Application Live View APIServer before proxying the actuator data from the application. This ensures that the actuator data is secured and only the user who has valid access to view the live information for the pod can retrieve the data.

Design flow

As illustrated in the diagram, the applications run by the user are registered with Application Live View back end by using Application Live View connector. After the application is registered, the Application Live View back end offers the ability to serve actuator data from that registered application through its REST API. Application Live View back end proxies the call to the connector for querying actuator endpoint information.

Application Live View connector, which is a lean model, uses specific labels to discover apps across cluster or namespace. Application Live View connector serves as the connection between running applications and Application Live View back end. Application Live View connector communicates with the Kubernetes API server requesting events for pod creation and termination, and then filters out the events to find the pod of interest by using labels. Then Application Live View connector registers the filtered app instances with Application Live View back end.

Application Live View back end and Application Live View connector communicate through a bidirectional RSocket channel. Application Live View connector is implemented as a Java/Spring Boot application and runs as a native executable file (Spring Native using GraalVM). Application Live View connector runs as a DaemonSet by default on every node in the cluster.

Application Live View conventions identifies PodIntents for pods that can serve actuator data and annotates the PodSpec with application-specific labels. Those labels are used by the Application Live View connector to identify running pods that can serve actuator data. Application Live View conventions reads the image metadata to determine the application-specific labels applied on the PodSpec.

Troubleshoot Application Live View

This topic provides information to help you troubleshoot Application Live View.

App is not visible in Application Live View UI

Symptom

Your app is not visible in the Application Live View UI.

Solution

The connector component is responsible for discovering the app and registering it with Application Live View.

To troubleshoot, confirm the following:

1. The app must be a Spring Boot Application.
2. Confirm that an instance of a connector is located in the same namespace as your app.

```
kubectl get pods -n NAMESPACE | grep connector
```

Where `NAMESPACE` is the name of the namespace that your app is located in.

3. Confirm that the actuator endpoints are enabled for your app as follows:

```
management.endpoints.web.exposure.include: "*" 
```

4. Confirm that you have included the following labels within your app deployment YAML file:

```
tanzu.app.live.view="true"
tanzu.app.live.view.application.name="APP-NAME"
```

Where `APP-NAME` is the name of your app.

5. Confirm that the Convention Service workload YAML file does not contain property `management.endpoints.web.exposure.include` overrides.

See also:

- [App is not visible in Application Live View UI with actuator endpoints enabled](#)
- [The UI does not show any information for an app with actuator endpoints exposed at root](#)

App is not visible in Application Live View UI with actuator endpoints enabled

Symptom

Your app is not visible in Application Live View UI, but the actuator endpoints are enabled.

Solution

To troubleshoot:

1. Check the port on which actuator endpoints are configured. By default, they are enabled on the application port. If they are configured on a port different from the application port, set the labels in your app deployment YAML file as follows:

```
tanzu.app.live.view.application.port: "APPLICATION-PORT"
tanzu.app.live.view.application.actuator.port: "ACTUATOR-PORT"
```

Where:

- `APPLICATION-PORT` is the application port.
 - `ACTUATOR-PORT` is the actuator port.
2. Check the path on which the app and actuator endpoints are configured. If they are configured on a different paths, set the labels in your app deployment YAML file as follows:

```
tanzu.app.live.view.application.path: "APPLICATION-PATH"
tanzu.app.live.view.application.actuator.path: "ACTUATOR-PATH"
```

Where:

- `APPLICATION-PATH` is the application port.
- `ACTUATOR-PATH` is the actuator port.

The UI does not show any information for an app with actuator endpoints exposed at root

Symptom

Your app has actuator endpoints exposed at root and the UI does not show any information.

Cause

Application Live View cannot display the app details when the app is exposing the actuator endpoint on root (/). This is due to conflict in the actuator context path and app default context path.

No information shown on the Health page

Symptom

The app shows up in Application Live View UI, but the **Health** page does not show details of health.

Solution

The information exposed by the health endpoint depends on the `management.endpoint.health.show-details` property. This must be set to `always` as follows:

```
management.endpoint.health.show-details: "always"
```

Stale information in Application Live View

Symptom

You can find your app in the UI, but it is an old instance that no longer exists while the new instance doesn't show up yet.

Solution

To troubleshoot:

1. View the Application Live View connector pod logs to see if the connector is sending updates to the back end.
2. Delete the connector pod to recreate it by running:

```
kubectl -n app-live-view-connector delete pods -l=name=application-live-view-connector
```

Unable to find CertificateRequests in Application Live View convention

Symptom

The certificate request is missing for certificate `app-live-view-conventions/appliveview-webhook-cert`.

Solution

To troubleshoot:

1. Run `kubectl get certificaterequest -A` to see if the certificate request is missing for Application Live View convention.
2. Delete the secret `appliveview-webhook-cert` that corresponds to the certificate in the `app-live-view-conventions` namespace by running:

```
kubectl delete secret appliveview-webhook-cert -n app-live-view-conventions
```

This recreates the certificate request and updates the corresponding certificate.

No live information for pod with ID

Symptom

In Tanzu Developer Portal, you receive the error `No live information for pod with id`.

Cause

This might happen because of stale information in Application Live View because it is an old instance that no longer exists while the new instance doesn't show up yet.

Solution

The workaround is to delete the connector pod so it is re-created by running:

```
kubectl -n app-live-view-connector delete pods -l=name=application-live-view-connector
```

Cannot override the actuator path in the labels

Symptom

You are unable to override the actuator path in the labels as part of the workload deployment.

Cause

The changes to add or override the labels or annotations in the [Workload](#) are in progress. The changes from the [Workload](#) must be propagated up through the supply chain for the PodIntent to see the new changes.

Cannot configure SSL in appliveview-connector

Symptom

This might be because `sslDeactivated` flag in the values YAML file does not accept values without quotes.

Cause

The `sslDeactivated` Boolean flag is treated as a string in the Kubernetes YAML file.

Solution

You must specify the value within double quotation marks for the configuration to be picked up.

Verify the labels in your workload YAML file

To verify that the labels in your workload YAML file are working:

1. Verify the app live view convention webhook is running properly by running:

```
kubectl get pods -n app-live-view | grep webhook
```

2. Verify the conventions controller is running properly by running:

```
kubectl get pods -n conventions-system
```

3. Verify that the conventions are applied properly to the PodSpec by running:

```
kubectl get podintents.conventions.carto.run WORKLOAD-NAME -oyaml
```

Where `WORKLOAD-NAME` is the name of your workload.

If everything works correctly, the status will contain a transformed template that includes the labels added as part of your workload YAML file. For example:

```
status:
conditions:
- lastTransitionTime: "2021-10-26T11:26:35Z"
  status: "True"
  type: ConventionsApplied
- lastTransitionTime: "2021-10-26T11:26:35Z"
  status: "True"
  type: Ready
```



```

observedGeneration: 1
template:
  metadata:
    annotations:
      conventions.carto.run/applied-conventions: |-
        appliveview-sample/app-live-view-connector
        appliveview-sample/app-live-view-appflavours
        appliveview-sample/app-live-view-systemproperties
    labels:
      tanzu.app.live.view: "true"
      tanzu.app.live.view.application.flavours: spring-boot
      tanzu.app.live.view.application.name: petclinic
  spec:
    containers:
      - env:
          - name: JAVA_TOOL_OPTIONS
            value: -Dmanagement.endpoint.health.show-details=always -Dmanagement.endpoints.web.exposure.include=*
        image: index.docker.io/kdvdolder/alv-spring-petclinic:latest@sha256:1aa7bd228137471ea38ce36cbf5ffcd629eabeb8ce047f5533b7b9176ff51f98
        name: workload
        resources: {}

```

Override labels set by the Application Live View convention service

It is not possible to override the labels set by the Application Live View convention service for the workload deployment in Tanzu Application Platform. The labels `tanzu.app.live.view`, `tanzu.app.live.view.application.flavours` and `tanzu.app.live.view.application.name` cannot be overridden. The default values set by the Application Live View convention server are used.

However, if you want to override `management.endpoints.web.exposure.include` or `management.endpoint.health.show-details`, you can override these environment properties in `application.properties` or `application.yml` in the Spring Boot Application before deploying the workload in Tanzu Application Platform. Environment properties updated in your app take precedence over the default values set by Application Live View convention server.

Configure labels when `management.endpoints.web.base-path` and `management.server.port` are set

If the custom actuator context path is configured as follows:

```

management.endpoints.web.base-path=/manage
management.server.port=8085

```

Configure the connector as follows:

```

tanzu.app.live.view.application.actuator.path=/manage    (manage is the custom actuator
path set on the application)
tanzu.app.live.view.application.actuator.port=8085    (8085 is the custom management se
rver port set on the application)

```

Uninstall Application Live View

This topic tells you how to uninstall Application Live View from Tanzu Application Platform (commonly known as TAP).

To uninstall the Application Live View back end, Application Live View connector, and Application Live View convention server, run:

```
tanzu package installed delete appliveview -n tap-install
tanzu package installed delete appliveview-connector -n tap-install
tanzu package installed delete appliveview-conventions -n tap-install
```

Overview of Application Single Sign-On for VMware Tanzu® 4.0

Application Single Sign-On for VMware Tanzu® (AppSSO) provides APIs for curating and consuming a “Single Sign-On as a service” offering on Tanzu Application Platform.

To get started with AppSSO, see [Get started with Application Single Sign-On](#).

With AppSSO, Service Operators can configure and deploy authorization servers. Application Operators can then secure their Workloads with these authorization servers to provide Single Sign-On to their end-users.

AppSSO allows integrating authentication and authorization decisions early in the software development and release life cycle. It provides a seamless transition for workloads from development to production when including Single Sign-On solutions in your software.

It’s easy to get started with AppSSO, deploy an authorization server with static test users, and eventually progress to multiple authorization servers of production-grade scale with token key rotation, multiple upstream identity providers, configured secure storage, and client restrictions.

AppSSO’s authorization server is based on the Spring Authorization Server project. For more information, see [Spring documentation](#).

Document organization

The Application Single Sign-On component documentation consists of the following subsections that relate to what you want to achieve:

- [Get started](#): To understand the basics of getting started with Application Single Sign-On.
- [How-to guides](#): To find a set of steps to solve a specific problem acting as a certain user persona.
- [Concepts](#): To gain a deeper understanding of Application Single Sign-On.
- [Reference](#): To find specific information such as Application Single Sign-On’s APIs.

Tutorials and concepts are of most relevance when studying, while how-to guides and reference material are of most use while working.

The following is a selection of useful topics on offer:

For application developers:

- [Application Single Sign-On for App Operators](#)

For service operators:

- [Application Single Sign-On for Service Operators](#)

For platform operators:

- [Application Single Sign-On for Platform Operators](#)

For everyone:

- [Levels of consumption for Application Single Sign-On](#)

Overview of Application Single Sign-On for VMware Tanzu® 4.0

Application Single Sign-On for VMware Tanzu® (AppSSO) provides APIs for curating and consuming a “Single Sign-On as a service” offering on Tanzu Application Platform.

To get started with AppSSO, see [Get started with Application Single Sign-On](#).

With AppSSO, Service Operators can configure and deploy authorization servers. Application Operators can then secure their Workloads with these authorization servers to provide Single Sign-On to their end-users.

AppSSO allows integrating authentication and authorization decisions early in the software development and release life cycle. It provides a seamless transition for workloads from development to production when including Single Sign-On solutions in your software.

It's easy to get started with AppSSO, deploy an authorization server with static test users, and eventually progress to multiple authorization servers of production-grade scale with token key rotation, multiple upstream identity providers, configured secure storage, and client restrictions.

AppSSO's authorization server is based on the Spring Authorization Server project. For more information, see [Spring documentation](#).

Document organization

The Application Single Sign-On component documentation consists of the following subsections that relate to what you want to achieve:

- [Get started](#): To understand the basics of getting started with Application Single Sign-On.
- [How-to guides](#): To find a set of steps to solve a specific problem acting as a certain user persona.
- [Concepts](#): To gain a deeper understanding of Application Single Sign-On.
- [Reference](#): To find specific information such as Application Single Sign-On's APIs.

Tutorials and concepts are of most relevance when studying, while how-to guides and reference material are of most use while working.

The following is a selection of useful topics on offer:

For application developers:

- [Application Single Sign-On for App Operators](#)

For service operators:

- [Application Single Sign-On for Service Operators](#)

For platform operators:

- [Application Single Sign-On for Platform Operators](#)

For everyone:

- [Levels of consumption for Application Single Sign-On](#)

Application Single Sign-On concepts

This topic tells you about the following concepts about Application Single Sign-On (commonly called AppSSO):

- [The three levels of AppSSO consumption](#)

- [Grant types](#)
- [Token signatures](#)

Levels of consumption for Application Single Sign-On

This topic tells you about the three levels of consuming Application Single Sign-On (commonly called AppSSO) services and explains the when and why for selecting a specific level over another.

VMware recommends using `ClassClaim` to consume an Application Single Sign-On service. However, there might be situations where the lower level `WorkloadRegistration` or `ClientRegistration` are a better fit.

At its core, the process of consuming Application Single Sign-On involves obtaining client credentials for an authorization server and loading them into a running workload. This process consists of the following steps:

1. Define your environment-independent OAuth2 client configurations, for example, client authentication method, scopes, and so on.
2. Define your OAuth2 client's redirect URIs.
3. Specify the authorization server that you want credentials for.
4. Create a resource that expresses your configuration.
5. Mount the client credentials into a workload.

Each of the following levels gradually takes away some of these steps by distributing them across APIs. As a result, each persona becomes responsible only for the tasks within their domain:

- **Platform operators** manage the installations of Tanzu Application Platform and Application Single Sign-On.
- **Service operators** curate and manage Application Single Sign-On services.
- **Application operators** consume Application Single Sign-On services from their workloads.

Level 1: ClientRegistration

The lowest-level and most general client API Application Single Sign-On offers is `ClientRegistration`. It holds all relevant OAuth2 client configurations. However, it requires fully qualified redirect URIs and targets its host `AuthServer` by using a label selector.

A hypothetical, fully-configured `ClientRegistration` is provided as follows:

```
---
apiVersion: sso.apps.tanzu.vmware.com/v1alpha1
kind: ClientRegistration
metadata:
  name: my-clientregistration
  namespace: my-namespace
spec:
  authServerSelector:
    matchLabels:
      sso.apps.tanzu.vmware.com/env: staging
      sso.apps.tanzu.vmware.com/ldap: ""
  redirectURIs:
    - https://profile.shop.staging.example.com/login
    - https://profile.shop.example.com/login
    - http://profile.shop.dev.example.com/login
  scopes:
    - name: openid
    - name: email
```

```

- name: profile
- name: roles
- name: coffee.make
  description: bestows the ultimate power
authorizationGrantTypes:
- client_credentials
- authorization_code
- refresh_token
clientAuthenticationMethod: client_secret_basic
requireUserConsent: true

```

To specify redirect URIs for an application running on Tanzu Application Platform, you must know its scheme and FQDN in advance. For example, your redirect URI must be `https://profile.shop.example.com/login`. However, the various components of a redirect URI are controlled by multiple personas such as platform operators and application operators.

In most cases, platform operators control how FQDNs are templated and whether TLS is used. For the redirect URI, platform operators have full control over all the elements in `https://profile.shop.example.com`, which include TLS, the domain name template, and the top-level ingress domain. These configurations can vary across different environments. Therefore, in an alternative environment, setting `https://profile.shop.staging.example.com` can be the appropriate choice.

Application operators control the application's code and its paths. Specifically, they are responsible for managing the `/login` path within the redirect URI. This path is unlikely to change and remains the same regardless of the target environment.

As a result, in a given environment, application operators might not know the FQDN and scheme. In such cases, they must seek assistance from platform operators to obtain this information. On the other hand, platform operators aim to change settings without being coupled to the application operator's configuration.

A `ClientRegistration` must uniquely identify an `AuthServer` by using a label selector. Service operators are in charge of managing `AuthServer`. The labels for a resource are not required to be consistent across environments. However, this can create complications for application operators. Label selectors are considered an advanced concept, and application operators might not be familiar with the specific labels associated with their desired `AuthServers`. It might be worth considering restricting the visibility of `AuthServers` to application operators because it falls within the domain of service operators.

All these factors make it challenging for application operators to use the same `ClientRegistration` across different environments.

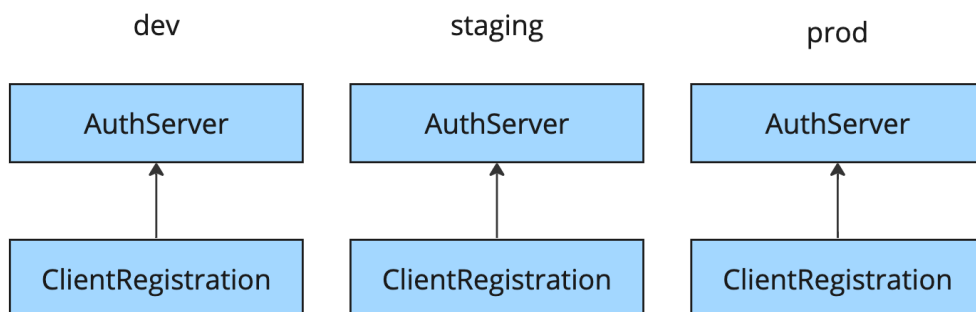

In conclusion, although `ClientRegistration` offers flexibility, it is also complex and not easily transferable between different environments. It combines the responsibilities of multiple personas, making it a less straightforward solution.

Level 2: WorkloadRegistration

A higher-level abstraction over `ClientRegistration` is `WorkloadRegistration`. It is similar to `ClientRegistration` except for one major difference: it templates redirect URIs.

Instead of providing full redirect URIs, a `WorkloadRegistration` receives absolute redirect paths. Platform operators configure the template for redirect URIs while installing Tanzu Application Platform, which includes Application Single Sign-On. They configure this template to match the template for workload domains.

The following is a hypothetical `WorkloadRegistration` example. It is similar to the earlier `ClientRegistration` example, except that it specifies the redirect paths. In its truncated `status`, you can observe the templated redirect URIs.

```
---
apiVersion: sso.apps.tanzu.vmware.com/v1alpha1
kind: WorkloadRegistration
metadata:
  name: my-workloadregistration
  namespace: my-namespace
spec:
  authServerSelector:
    matchLabels:
      sso.apps.tanzu.vmware.com/env: staging
      sso.apps.tanzu.vmware.com/ldap: ""
  redirectPaths:
    - /login
  workloadRef:
    name: my-workload
    namespace: my-namespace
  scopes:
    - name: openid
    - name: email
    - name: profile
    - name: roles
    - name: coffee.make
      description: bestows the ultimate power
  authorizationGrantTypes:
    - client_credentials
    - authorization_code
    - refresh_token
  clientAuthenticationMethod: client_secret_basic
  requireUserConsent: true
status:
  workloadDomainTemplate: "{{.Name}}.{{.Namespace}}.{{.Domain}}"
  redirectURIs:
    - https://my-workload.my-namespace.example.com/login
```

The additional `spec.workloadRef` provides templates for the redirect URIs.

Templating redirect URIs template decouples the application operators from the platform operators. Now the application operator only needs to provide the absolute redirect paths, which are consistent across environments. The platform operators can configure domain templates, ingress domains, and TLS as they see fit, and rest assured that settings are updated without interruption.

However, `WorkloadRegistration` still requires matching an `AuthServer` by the label selector. That means application operators and service operators are still coupled.

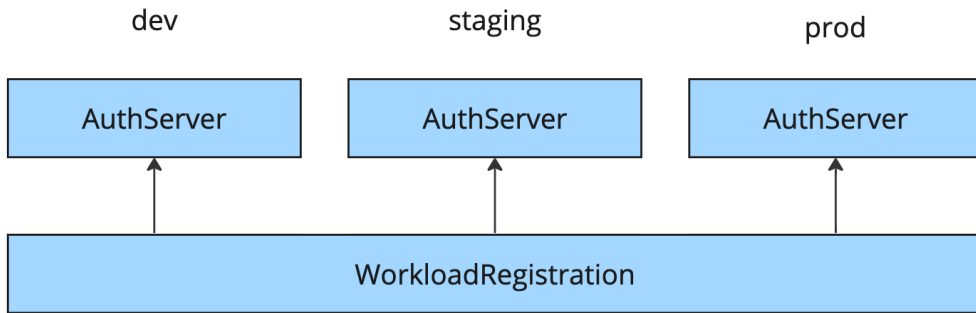

In summary, `WorkloadRegistration` is less flexible, but it is portable across environments when redirect URIs can be templated. However, it still mixes the concerns of personas.

Level 3: ClassClaim (recommended)

The final level is to obtain client credentials by claiming them from an Application Single Sign-On service. Unlike the previous levels that directly interacted with `AuthServer` resources, this level abstracts this part away with `Services Toolkit's APIs`. This eliminates the last remaining coupling between application operators and service operators.

You can pair Application Single Sign-On's `ClusterWorkloadRegistrationClass` with an `AuthServer` as a claimable service. These two APIs allow the service operators to manage the entire life cycle of an Application Single Sign-On service offering.

A `ClusterWorkloadRegistrationClass` exposes an `AuthServer` as a claimable service by creating a `Services Toolkit ClusterInstanceClass` and defining a blueprint `WorkloadRegistration`. This blueprint allows service operators to record the correct label selector for the `AuthServer`, which eliminates application operators' concerns.

Credentials for a service are requested by using `Services Toolkit's general-purpose ClassClaim API`. A `ClassClaim` identifies a `ClusterInstanceClass` and it carries parameters that further describe the request. For Application Single Sign-On services, the parameters are essentially the trimmed `spec` of a `WorkloadRegistration`.

With the `Tanzu Service CLI`, application operators can discover and consume services in a self-service style. Commonly, this is how service operators provide all the services required for application teams to run their applications. This includes databases, queues, in-memory stores, and single sign-on by Application Single Sign-On.

The following is a hypothetical `ClassClaim` for an Application Single Sign-On service called `sso`:

```

---
apiVersion: services.apps.tanzu.vmware.com/v1alpha1
kind: ClassClaim
metadata:
  name: my-client-credentials
  namespace: my-namespace
spec:
  classRef:
    name: sso
  parameters:
    workloadRef:
      name: sample-workload
    redirectPaths:
      - /login
    scopes:
  
```

```

- name: openid
- name: email
- name: profile
- name: roles
- name: coffee.make
  description: bestows the ultimate power
authorizationGrantTypes:
- client_credentials
- authorization_code
- refresh_token
clientAuthenticationMethod: client_secret_basic
requireUserConsent: true

```

This level completely decouples all three personas by providing them with APIs to fulfill their jobs.

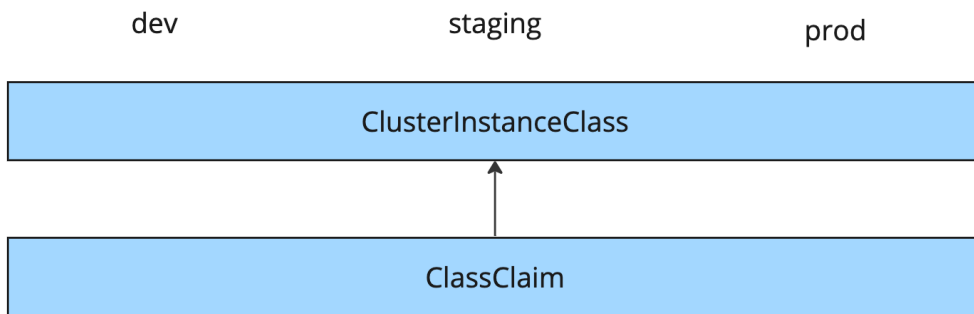

In summary, `ClassClaim` is less flexible but it is portable across environments when the redirect URIs can be templated. It completely decouples the concerns of personas. Additionally, offering a single resource for application operators to manage.

Summary

As an application operator, if your workload and its associated resources must be deployed across multiple environments, `ClassClaim` offers you the highest degree of portability, as long as the redirect URIs of your workload can be templated. In this case, consuming an Application Single Sign-On service only requires a single resource, a `ClassClaim`.

If you require control over the template for your workload's redirect URIs, `WorkloadRegistration` offers the desired flexibility. However, this flexibility comes with the cost of matching an `AuthServer` with a label selector. In situations where you want to consume the Application Single Sign-On service with such a setup, it requires multiple resources: a `WorkloadRegistration` and a `ResourceClaim`.

If your workload's redirect URIs cannot be templated and portability is not a concern, `ClientRegistration` offers the necessary flexibility. However, this flexibility comes at the cost of having to match an `AuthServer` with a label selector. Depending on your setup, consuming AppSSO requires multiple resources: a `ClientRegistration` and a `ResourceClaim`.

In conclusion, VMware recommend to use `ClassClaim` whenever possible.

Configure grant types

This topic tells you how to configure grant types for Application Single Sign-On (commonly called AppSSO).

Apps use grant types or flows to get an access token on behalf of a user. If not included, the default grant type is ['client_credentials']. You must include these grant types in the `authorizationGrantTypes` property list in the [Client Registration](#).

To register a client/application, apply the `yaml` with your specifications to your cluster `kubectl apply -f <path-to-your-yaml>`.

Topics

- [Client Credentials Grant](#)
- [Authorization Code Grant](#)

Client Credentials Grant Type

This grant type allows an application to get an access token for resources about the client itself, rather than a user.

Dynamic Client Registration (via `ClientRegistration` custom resource):

```
apiVersion: sso.apps.tanzu.vmware.com/v1alpha1
kind: ClientRegistration
metadata:
  name: <your client name>
spec:
  authorizationGrantTypes:
    - client_credentials
# ...
```



Note

Ensure that you are able to retrieve a token through your setup

1. Apply your `ClientRegistration`

```
kubectl apply -f <path-to-the-clientregistration-yaml>
```

2. Verify your `ClientRegistration` was created

```
kubectl get clientregistrations
```

→ you should see a `ClientRegistration` with the name you provided

3. Verify your Secret was created

```
kubectl get secrets
```

→ you should see a Secret with that same name you provided for the `ClientRegistration`

4. Get the client secret and decode it

```
kubectl get secret <your-client-registration-name> -o jsonpath="{.data.client-secret}" | base64 -d
```

5. Get the client id (or get it from your configuration)

```
kubectl get secret <your-client-registration-name> -o jsonpath="{.data.client-id}" | base64 -d
```

6. Request token

```
curl -X POST <AUTH-DOMAIN>/oauth2/token?grant_type=client_credentials -v -u "YOUR_CLIENT_ID:DECODED_CLIENT_SECRET"
```

Authorization Code Grant Type

This grant type allows clients to exchange this code for access tokens.

Dynamic Client Registration (via [ClientRegistration](#) custom resource):

```
apiVersion: sso.apps.tanzu.vmware.com/v1alpha1
kind: ClientRegistration
metadata:
  name: <your client name>
spec:
  authorizationGrantTypes:
    - authorization_code
  scopes:
    - openid
  # ...
```



Note

Ensure that you are able to retrieve a token through your setup

Ensure there is an Identity Provider configured

1. Get your authserver's label name

```
kubectl get authserver sso4k8s -o jsonpath="{.metadata.labels.name}"
```

2. Apply this sample ClientRegistration ([read more about ClientRegistrations](#))

The following is an example ClientRegistration that will work in this setup. The required scopes are `openid`, `email`, `profile`, `roles`. The redirect URI here has been set to match that of `oauth2-proxy`.

```
apiVersion: sso.apps.tanzu.vmware.com/v1alpha1
kind: ClientRegistration
metadata:
  name: oauth2-proxy-client
  namespace: <your-namespace>
spec:
  authServerSelector:
    matchLabels:
      name: <your-authserver-label-name>
  authorizationGrantTypes:
    - client_credentials
    - authorization_code
  requireUserConsent: false
  redirectURIs:
    - http://127.0.0.1:4180/oauth2/callback
  scopes:
    - name: openid
    - name: email
    - name: profile
    - name: roles
```

```
kubectl apply -f <path-to-the-clientregistration-yaml>
```

3. Verify your `ClientRegistration` was created

```
kubectl get clientregistrations
```

-> you should see a `ClientRegistration` with the name you provided

4. Verify your Secret was created

```
kubectl get secrets
```

-> you should see a Secret with that same name you provided for the `ClientRegistration`

5. Get the client secret and decode it

```
CLIENT_SECRET=$(kubectl get secret <your-client-registration-name> -o jsonpath="{.data.client-secret}" | base64 -d)
```

6. Get the client id (or get it from your configuration)

```
CLIENT_ID=$(kubectl get secret <your-client-registration-name> -o jsonpath="{.data.client-id}" | base64 -d)
```

7. Get the issuer uri

```
ISSUER_URI=$(kubectl get secret <your-client-registration-name> -o jsonpath="{.data.issuer-uri}" | base64 -d)
```

8. Use the `oauth2-proxy` to spin up a quick trial run of the configured Authserver and run it with docker.

```
docker run -p 4180:4180 --name oauth2-proxy bitnami/oauth2-proxy:latest \
--oidc-issuer-url "$ISSUER_URI" \
--client-id "$CLIENT_ID" \
--insecure-oidc-skip-issuer-verification true \
--client-secret "$CLIENT_SECRET" \
--cookie-secret "0000000000000000" \
--http-address "http://:4180" \
--provider oidc \
--scope "openid email profile roles" \
--email-domain='*' \
--insecure-oidc-allow-unverified-email true \
--upstream "static://202" \
--oidc-groups-claim "roles" \
--oidc-email-claim "sub" \
--redirect-url "http://127.0.0.1:4180/oauth2/callback"
```

**Note**

Ensure that your issuer URL does not resolve to `127.0.0.1`.

9. Check your browser at `127.0.0.1:4180` to see if your configuration allows you to sign in.

You should see a message that says “Authenticated”.

About token signatures

This topic tells you about the concept of token signatures.

Token signature 101

Token signature keys are used by an [AuthServer](#) to sign JSON Web Tokens (JWTs), produce a [JWS Signature](#) and attach it to the [JOSE Header](#) of a JWT. The client application can then verify the JWT signature.

A private key signs a JWT. A public key verifies the signature of a signed JWT.

The sign-and-verify mechanism serves multiple security purposes:

- **Authenticity:** signature verification ensures that the issuer of the JWT is from a source that is advertised.
- **Integrity:** signature verification ensures that the JWT has not been altered in transit or during its issued lifetime. [Integrity is a foundational pillar of the CIA triad concept in Information Security.](#)
- **Non-repudiation:** signature verification ensures that the authorization server that signed the JWT cannot deny that they have signed it after its issuance (granted that the signing key that signed the JWT is available).

AppSSO only supports the [RS256](#) algorithm for signing tokens. For more information, see [JSON Web Algorithms \(JWA\) documentation](#).

Token signature of an [AuthServer](#)

You must configure token signatures for [AuthServer](#). An [AuthServer](#) receives its keys under `spec.tokenSignature`. For example:

```
spec:
  tokenSignature:
    signAndVerifyKeyRef:
      name: sample-token-signing-key
    extraVerifyKeyRefs:
      - name: sample-token-verification-key-1
      - name: sample-token-verification-key-2
```

There can only be **one** token signing key `spec.tokenSignature.signAndVerifyKeyRef` at any given time, and arbitrarily many token verification keys `spec.tokenSignature.extraVerifyKeyRefs`. The token signing key is used to sign and verify actively issued JWTs in circulation, whereas token verification keys are used to verify issued JWTs signatures. Token verification keys are thought to be previous token signing keys but have been rotated into verify only mode as a rotation mechanism measure, and can potentially be slated for eviction at a predetermined time.

The [AuthServer](#) serves its public keys at `{spec.issuerURI}/oauth2/jwks`. For example:

```
$ curl -s authserver-sample.default/oauth2/jwks | jq
{
  "keys": [
    {
      "kty": "RSA",
      "e": "AQAB",
      "kid": "sample-token-signing-key",
      "n": "0iCinir7sWKZE_3QXq4eTub_GU-lvdAKFI9dzDlwX7XZwwSERuzzQQ_Fs7i9djM15bpv2ma_3Z
B-j2W9pR9Zia3nqBI29AHqx2zmVQ8w-GxPDGRmkBdMOWNwyDQGIR1QnJFpXRoSQ5_vIM9gYA56WthkDghrupGU
iB_zqGFYlgnz7sd41C-thgEkDi9vY68DLIFdsXOQIXFqakyEIo43n_0vg6JRGQW1LU_320k6OgA3r6bYcE8VQh
JW3sE1qOSFcp0JrPA3YgmTnuDV6GoCLZeMxDdMDKdDcH5UgERLQe1qMMKw1MCeKamOWgo9eBvcFnWNR0I_MJV6
F14U1WbIcQ"
    },
    {
      "kty": "RSA",
      "e": "AQAB",
      "kid": "sample-token-verification-key-1",
      "n": "wc7uOACU62Yu_zKT9YrI4v-_X3L47nbV1cByi4UTVhg8o0010kiYAPAEoDCEHnDg_54gTWxe3h
```

```
DRcOJrd72PkTAaxH8aFdikoyakRVG9NvAPbcfzvI8R8plepUbs1U7TPPDEDARm_fZX6QdVyz0CTSafrz-yktTA
DxJhYPgvFLeHq7g7RouB1szTWDCM1haoxKa4960_x9meghNn87z0uF3cAd7TM_k3capYnxNOUT5g1vjJ05Vkl4
JU14R294OpMXPCGcFuvu9auXeBqXyKxxTAnLkDdNrgtT0FJHwnh4RGnrNqjYZOwlRvGbzwQ7du97aU2-qgbKkJ
rWYZWcw2bQ"
  },
  {
    "kty": "RSA",
    "e": "AQAB",
    "kid": "sample-token-verification-key-2",
    "n": "qELrLiaD-IVp_nthVn2EsLuShtU9ovyVIPkLVf47AqKogPV2frE_6Sv8k7Zim-SgDXfjLEg-UG
lQrb4KfM_WkaK2Uf6PCapiBnMil1Q5P8qC0WC5LT6XyPY1exCQbMrEsyd89oS0sKxgoc3Qv0XV24jGYiWQyJ7I0
Rub_QEldGM_ds1fbI-1Qt_U6Ll220Ec1D6P1A3MdDrqbur6N7Zemx1KI26-OAdlbNi0u-1FNj3Ss-pfTVi_fD2
hAajRRmc4tmHejQjH36M4F1NSW_gTbb6VX5EerVuDwSCCK0EuGvhcb1hg6kYEoO-qws54AQ0PywBXT5qksCMBm
mzjP6q040w"
  }
]
}
```



Caution

Changes to `spec.tokenSignature.signAngVerifyKeyRef` have immediate effects.

As a service operator, you have control over which keys are used for certain purposes. For more information, see [Manage token signature keys for Application Single Sign-On](#).

Get started with Application Single Sign-On

Use the following topics to get started with Application Single Sign-On (commonly called AppSSO):

- [Overview](#)
- [Provision an AuthServer](#)
- [Provision a client registration](#)
- [Deploy an application secured with SSO](#)

Overview of Application Single Sign-On

This topic tells you about concepts important to getting started with Application Single Sign-On (commonly called AppSSO).

Use this topic to learn how to:

1. [Set up your first authorization server.](#)
2. [Provision a ClientRegistration.](#)
3. [Deploy an application](#) that uses the provisioned ClientRegistration to enable SSO.

After completing these steps, you can proceed with [securing a Workload](#).

Prerequisites

You must install AppSSO on your Tanzu Application Platform cluster. For more information, see [Install AppSSO](#).

Key concepts

At the core of AppSSO is the concept of an Authorization Server, outlined by the [AuthServer custom resource](#). Service Operators create those resources to provision running Authorization

Servers, which are [OpenID Connect Providers](#). They issue [ID Tokens](#) to Client applications, which contain identity information about the end user such as email, first name, last name and so on.

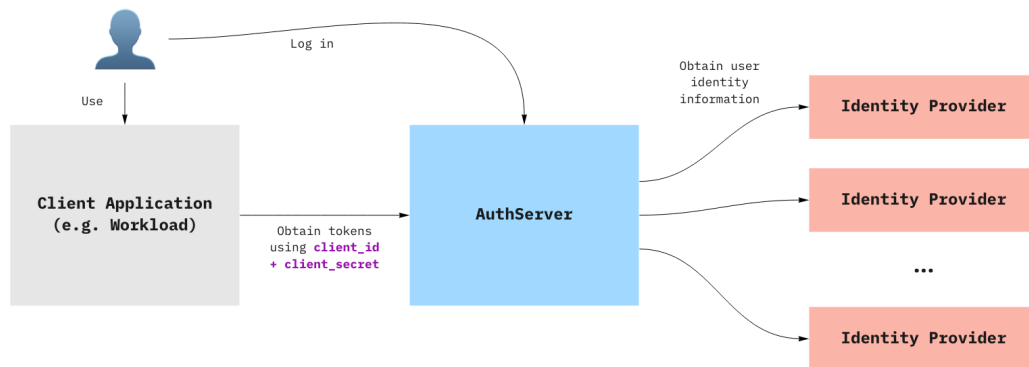

When a Client application uses an AuthServer to authenticate an End-User, the typical steps are:

1. The End-User visits the Client application
2. The Client application redirects the End-User to the AuthServer, with an OAuth2 request
3. The End-User logs in with the AuthServer, usually using an external Identity Provider (e.g. Google, Azure AD)
 1. Identity Providers are set up by Service Operators
 2. AuthServers may use various protocols to obtain identity information about the user, such as OpenID Connect, SAML or LDAP, which may involve additional redirects
4. The AuthServer redirects the End-User to the Client application with an authorization code
5. The Client application exchanges with the AuthServer for an `id_token`
 1. The Client application does not know how the identity information was obtained by the AuthServer, it only gets identity information in the form of an ID Token.

[ID Tokens](#) are JSON Web Tokens containing standard Claims about the identity of the user (e.g. name, email, etc) and about the token itself (e.g. “expires at”, “audience”, etc.). Here is an example of an `id_token` as issued by an Authorization Server:

```

{
  "iss": "https://appsso.example.com",
  "sub": "213435498y",
  "aud": "my-client",
  "nonce": "fkg0-90_mg",
  "exp": 1656929172,
  "iat": 1656928872,
  "name": "Jane Doe",
  "given_name": "Jane",
  "family_name": "Doe",
  "email": "jane.doe@example.com",
  "roles": [
    "developer",
    "org-user"
  ]
}
  
```

`roles` claim can only be part of an `id_token` when user roles are mapped and ‘roles’ scope is requested. For more information about mapping for OpenID Connect, LDAP and SAML, see:

- [OpenID external groups mapping](#)
- [LDAP external groups mapping](#)

- [SAML \(experimental\) external groups mapping](#)

ID Tokens are signed by the [AuthServer](#), using [Token Signature Keys](#). Client applications may verify their validity using the AuthServer's public keys.

Next steps

- [Provision an AuthServer](#)

Provision an AuthServer

This topic tells you how to provision an AuthServer for Application Single Sign-On (commonly called AppSSO). Use this topic to learn how to:

1. Set up your first authorization server in the `default` namespace.
2. Ensure it is running so that users can log in.

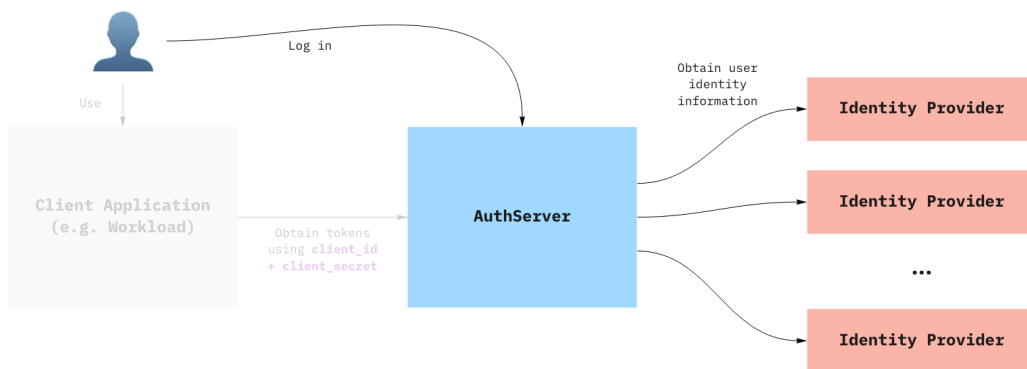

Prerequisites

You must install AppSSO on your Tanzu Application Platform cluster and ensure that your Tanzu Application Platform installation is correctly configured.

AppSSO is installed with the `run`, `iterate`, and `full` profiles, no extra steps required.

To verify AppSSO is installed on your cluster, run:

```
tanzu package installed list -A | grep "sso.apps.tanzu.vmware.com"
```

For more information about the AppSSO installation, see [Install AppSSO](#).

Provision an AuthServer

Deploy your first Authorization Server along with an `RSAPKey` key for signing tokens.



Caution

This [AuthServer](#) example uses an unsafe testing-only identity provider. Never use it in production environments. For more information about identity providers, see [Identity providers](#).

```
---
apiVersion: sso.apps.tanzu.vmware.com/v1alpha1
kind: AuthServer
metadata:
```

```

name: my-authserver-example
namespace: default
labels:
  name: my-first-auth-server
  env: tutorial
annotations:
  sso.apps.tanzu.vmware.com/allow-client-namespaces: "default"
  sso.apps.tanzu.vmware.com/allow-unsafe-issuer-uri: ""
  sso.apps.tanzu.vmware.com/allow-unsafe-identity-provider: ""
spec:
  replicas: 1
  tls:
    deactivated: true
  identityProviders:
    - name: "internal"
      internalUnsafe:
        users:
          - username: "user"
            password: "password"
            email: "user@example.com"
            emailVerified: true
            roles:
              - "user"
  tokenSignature:
    signAndVerifyKeyRef:
      name: "authserver-signing-key"
---
apiVersion: secretgen.k14s.io/v1alpha1
kind: RSAKey
metadata:
  name: authserver-signing-key
  namespace: default
spec:
  secretTemplate:
    type: Opaque
    stringData:
      key.pem: $(privateKey)
      pub.pem: $(publicKey)

```

You can wait for the `AuthServer` to become ready with:

```
kubectl wait --for=condition=Ready authserver my-authserver-example
```

Alternatively, you can inspect your `AuthServer` like any other resource:

```
kubectl get authservers.sso.apps.tanzu.vmware.com --all-namespaces
```

and you should see:

```

NAMESPACE NAME                REPLICAS ISSUER URI
CLIENTS STATUS
default    my-authserver-example 1          http://my-authserver-example.default.<your do
main> 0      Ready

```

As you can see your `AuthServer` gets an issuer URI templated. This is its endpoint. You can find an `AuthServer`'s issuer URI in its status:

```
kubectl get authservers.sso.apps.tanzu.vmware.com my-authserver-example -o jsonpath
='{.status.issuerURI}'
```

Open your `AuthServer`'s issuer URI in your browser. You should see a login page. Log in using username = `user` and password = `password`.

You can review the standard OpenID information of your `AuthServer` by visiting `http://my-authserver-example.default.<your domain>/.well-known/openid-configuration`.



Important

If the issuer URIs domain is not yours, the AppSSO package installation must be updated. For more information, see [Install Application Single Sign-On](#).

The AuthServer spec in detail

Here is a detailed explanation of the `AuthServer` you have applied in the above section. This is intended to give you an overview of the different configuration values that were passed in. It is not intended to describe all the ins-and-outs, but there are links to related docs in each section.

Feel free to skip ahead.

Metadata

```
metadata:
  labels:
    name: my-first-auth-server
    env: tutorial
  annotations:
    sso.apps.tanzu.vmware.com/allow-client-namespaces: "default"
    sso.apps.tanzu.vmware.com/allow-unsafe-issuer-uri: ""
    sso.apps.tanzu.vmware.com/allow-unsafe-identity-provider: ""
```

The `metadata.labels` uniquely identify the `AuthServer`. They are used as selectors by `ClientRegistrations`, to declare from which authorization server a specific client obtains tokens from.

The `sso.apps.tanzu.vmware.com/allow-client-namespaces` annotation restricts the namespaces in which you can create `ClientRegistrations` targeting this authorization server. In this case, the authorization server only picks up client registrations in the `default` namespace.

The `sso.apps.tanzu.vmware.com/allow-unsafe-...` annotations enable “development mode” features, useful for testing. Those should not be used for production-grade authorization servers.

For more information about annotations and labels in `AuthServer` resource, see [Annotation and labels](#).

TLS & issuer URI

```
spec:
  tls:
    deactivated: true
```

The `tls` field configures whether and how to obtain a certificate for an `AuthServer` to secure its issuer URI. If you deactivate `tls`, the issuer URI uses plain HTTP.



Caution

Plain HTTP access is for development purposes only and must never be used in production. For more information about the production readiness with TLS, see [Issuer URI & TLS](#).

Token Signature

```

---
apiVersion: sso.apps.tanzu.vmware.com/v1alpha1
kind: AuthServer
# ...
spec:
  tokenSignature:
    signAndVerifyKeyRef:
      name: "authserver-signing-key"
---
apiVersion: secretgen.k14s.io/v1alpha1
kind: RSAKey
metadata:
  name: authserver-signing-key
  namespace: default
spec:
  secretTemplate:
    type: Opaque
    stringData:
      key.pem: $(privateKey)
      pub.pem: $(publicKey)

```

The token signing key is the private RSA key used to sign ID Tokens, using [JSON Web Signatures](#), and clients use the public key to verify the provenance and integrity of the ID tokens. The public keys used for validating messages are published as [JSON Web Keys](#) at `{.status.issuerURI}/oauth2/jwks`.

The `spec.tokenSignature.signAndVerifyKeyRef.name` references a secret containing PEM-encoded RSA keys, both `key.pem` and `pub.pem`. In this specific example, we are using [Secretgen-Controller](#), a TAP dependency, to generate the key for us.

Learn more about [Token Signatures](#).

Identity providers

```

spec:
  identityProviders:
    - name: "internal"
      internalUnsafe:
        users:
          - username: "user"
            password: "password"
            email: "user@example.com"
            roles:
              - "user"

```

AppSSO's authorization server delegates login and user management to external identity providers (IDP), such as Google, Azure Active Directory, Okta and so on. See diagram at the top of this topic for more information.

In this example, we use an `internalUnsafe` identity provider. As the name implies, it is *not* an external IDP, but rather a list of hardcoded user/passwords. As the name also implies, this is not considered safe for production. Here, we declared a user with `username = user`, and `password = password`. For production setups, consider using OpenID Connect IDPs instead.

The `email` and `roles` fields are optional for internal users. However, they will be useful when we want to use SSO with a client application later in this guide.



Caution

VMware discourages using the `internalUnsafe` identity provider in production environments.

Configuring storage

An `AuthServer` issues a Redis instance by default. It can be used for testing, prototyping and other non-production purposes. No additional configuration is required.

To configure your own storage that is ready for production, see [Storage](#).

Provision a client registration

This topic tells you how to provision a client registration for Application Single Sign-On (commonly called AppSSO). Use this topic to learn how to:

1. Obtain credentials for the Authorization Server that you provisioned in [Provision your first AuthServer](#).
2. Verify that the credentials are valid using client-credentials flow.

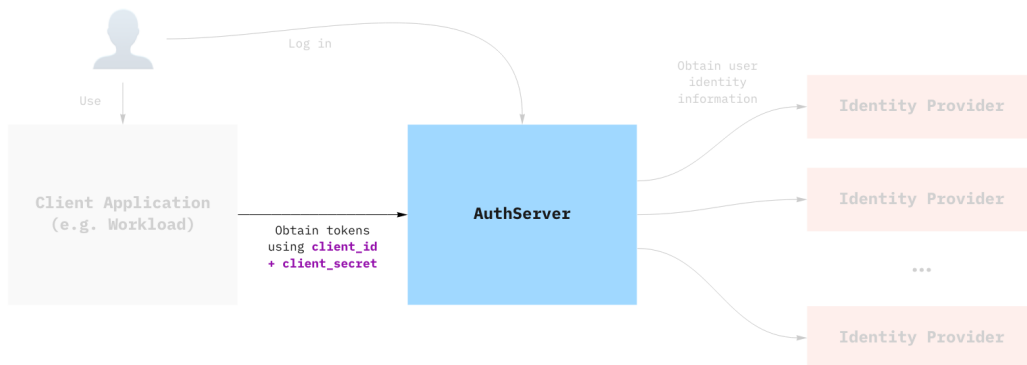

Prerequisites

Complete the steps described in [Get started with Application Single Sign-On](#).

Creating the ClientRegistration

Assuming you have deployed the `AuthServer` as described previously, you can create and apply the following client registration:



Note

AppSSO uses `test-app.example.com` for `ClientRegistration.spec.redirectURIs[0]`. You must customize the URL to match the domain of your Tanzu Application Platform cluster. This is the URL to expose your test application in the next section.

```

apiVersion: sso.apps.tanzu.vmware.com/v1alpha1
kind: ClientRegistration
metadata:
  name: my-client-registration
  namespace: default
spec:
  authServerSelector:
    matchLabels:
  
```

```

    name: my-first-auth-server
    env: tutorial
  redirectURIs:
    - "http://test-app.example.com/oauth2/callback"
  requireUserConsent: false
  clientAuthenticationMethod: client_secret_basic
  authorizationGrantTypes:
    - "client_credentials"
    - "authorization_code"
  scopes:
    - name: "openid"
    - name: "email"
    - name: "profile"
    - name: "roles"
    - name: "message.read"

```

The AuthServer should now have this [ClientRegistration](#) registered. You can verify the status either by looking at the [ClientRegistrationS.status](#) field, or looking at the [AuthServer](#) itself.

```

# Check the client registration
kubectl get clientregistration my-client-registration -n default -o yaml
# Check the authserver
kubectl get authservers
# NAME                                REPLICAS  ISSUER URI                                CLIENTS  TOKEN KE
YS
# my-authserver-example               1          http://authserver.example.com           1        1
#
#                                     the AuthServer now has one client ^

```

AppSSO will create a secret containing the credentials that client applications will use, named after the client registration. The type of the secret is [servicebinding.io/oauth2](#). You can obtain the values in the secret by running:

```

kubectl get secret my-client-registration -n default -o json | jq ".data | map_values
(@base64d)"
# {
#   "authorization-grant-types": "client_credentials,authorization_code",
#   "client-authentication-method": "client_secret_basic",
#   "client-id": "default_my-client-registration",
#   "client-secret": "PLACEHOLDER",
#   "issuer-uri": "http://authserver.example.com",
#   "provider": "appsso",
#   "scope": "openid,email,profile,roles,message.read",
#   "type": "oauth2"
# }

```

Validating that the credentials are working

Before you deploy an app and make use of SSO, you can try the credentials from your machine to try and obtain an [access_token](#) using the [client_credentials](#) grant. You need the [client_id](#) and [client_secret](#) that were created as part of the client registration.

```

CLIENT_ID=$(kubectl get secret my-client-registration -n default -o jsonpath="{.data.c
lient-id}" | base64 -d)
CLIENT_SECRET=$(kubectl get secret my-client-registration -n default -o jsonpath="{.da
ta.client-secret}" | base64 -d)
ISSUER_URI=$(kubectl get secret my-client-registration -n default -o jsonpath="{.data.
issuer-uri}" | base64 -d)
curl -XPOST "$ISSUER_URI/oauth2/token?grant_type=client_credentials&scope=message.rea
d" -u "$CLIENT_ID:$CLIENT_SECRET"

```

You can decode the [access_token](#) using an online service, such as [JWT.io](#).

To learn more about grant types, see [Grant Types](#).

Deploy an application with Application Single Sign-On

This topic tells you how to deploy a minimal Kubernetes application that is protected by Application Single Sign-On (commonly called AppSSO) by using the credentials that [ClientRegistration](#) creates.

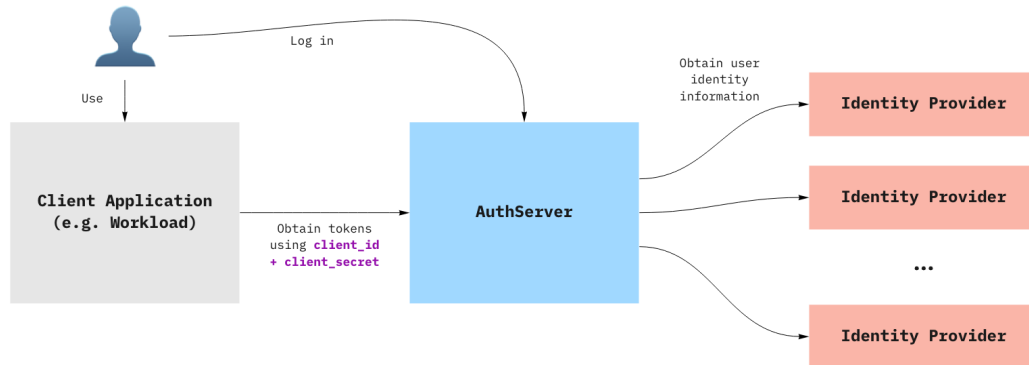

For more information about how a Client application uses an AuthServer to authenticate an end user, see the [Overview of AppSSO](#).

Prerequisites

You must complete the steps described in [Get started with Application Single Sign-On](#). If not, see [Provision a client registration](#).

Deploy a minimal application

You are going to deploy a two-container pod, as a test application.



Important

AppSSO uses `test-app.example.com` for `HTTPProxy.spec.virtualhost.fqdn`. You must customize the URL to match the domain of your Tanzu Application Platform cluster. This URL must match what was set up in `ClientRegistration.spec.redirectURIs[0]` in [Provision a client registration](#)

```
---
apiVersion: apps/v1
kind: Deployment
metadata:
  name: test-application
  namespace: default
spec:
  replicas: 1
  selector:
    matchLabels:
      name: test-application
  template:
    metadata:
      labels:
        name: test-application
    spec:
      containers:
        - image: bitnami/oauth2-proxy:7.3.0
          name: proxy
```

```

ports:
  - containerPort: 4180
    name: proxy-port
    protocol: TCP
env:
  - name: ISSUER_URI
    valueFrom:
      secretKeyRef:
        name: my-client-registration
        key: issuer-uri
  - name: CLIENT_ID
    valueFrom:
      secretKeyRef:
        name: my-client-registration
        key: client-id
  - name: CLIENT_SECRET
    valueFrom:
      secretKeyRef:
        name: my-client-registration
        key: client-secret
command: [ "oauth2-proxy" ]
args:
  - --oidc-issuer-url=${ISSUER_URI}
  - --client-id=${CLIENT_ID}
  - --insecure-oidc-skip-issuer-verification=true
  - --client-secret=${CLIENT_SECRET}
  - --cookie-secret=0000000000000000
  - --cookie-secure=false
  - --http-address=http://:4180
  - --provider=oidc
  - --scope=openid email profile roles
  - --email-domain=*
  - --insecure-oidc-allow-unverified-email=true
  - --oidc-groups-claim=roles
  - --upstream=http://127.0.0.1:8000
  - --redirect-url=http://test-app.example.com/oauth2/callback
  - --skip-provider-button=true
  - --pass-authorization-header=true
  - --prefer-email-to-user=true
- image: python:3.9
  name: application
  resources:
    limits:
      cpu: 100m
      memory: 100Mi
  command: [ "python" ]
  args:
    - -c
    - |
      from http.server import HTTPServer, BaseHTTPRequestHandler
      import base64
      import json

      class Handler(BaseHTTPRequestHandler):
        def do_GET(self):
          if self.path == "/token":
            self.token()
            return
          else:
            self.greet()
            return

        def greet(self):
          username = self.headers.get("x-forwarded-user")
          self.send_response(200)
          self.send_header("Content-type", "text/html")

```

```

        self.end_headers()
        page = f"""
        <h1>It Works!</h1>
        <p>You are logged in as <b>{username}</b></p>
        """
        self.wfile.write(page.encode("utf-8"))

    def token(self):
        token = self.headers.get("Authorization").split("Bearer ")[-1]
        payload = token.split(".")[1]
        decoded = base64.b64decode(bytes(payload, "utf-8") + b'==').deco
de("utf-8")

        self.send_response(200)
        self.send_header("Content-type", "application/json")
        self.end_headers()
        self.wfile.write(decoded.encode("utf-8"))

    server_address = ('', 8000)
    httpd = HTTPServer(server_address, Handler)
    httpd.serve_forever()

---
apiVersion: v1
kind: Service
metadata:
  name: test-application
  namespace: default
spec:
  ports:
    - port: 80
      targetPort: 4180
  selector:
    name: test-application

---
apiVersion: projectcontour.io/v1
kind: HTTPProxy
metadata:
  name: test-application
  namespace: default
spec:
  virtualhost:
    fqdn: test-app.example.com
  routes:
    - conditions:
      - prefix: /
      services:
        - name: test-application
          port: 80

```

Now you can navigate to <http://test-app.example.com/>. It may ask you to log into the AuthServer you haven't already. You can also navigate to <http://test-app.example.com/token> if you wish to see the contents of the ID token.

Deployment manifest

The application was deployed as a two-container pod: one for the app, and one for handling login.

- The main container is called `application`, and runs a bare-bones Python HTTP server, that reads from the `Authorization` header from incoming requests and returns the decoded `id_token`.
- The second container, called `proxy`, is a sidecar container, an "Ambassador". It receives traffic for the Pod, performs OpenID authentication using `OAuth2 Proxy`, and proxies

requests to the `application` with some added headers containing identity information.

Along with this deployment, there is a `Service + HTTPProxy`, to expose the application to the outside world.

OAuth2-Proxy

The setup of the above `OAuth2 Proxy` is minimal, and is not considered suitable for production use. To configure it for production, please refer to the official documentation.

Note that OAuth2 Proxy requires some claims to be present in the `id_token`, notably the `email` claim and the non-standard `groups` claim. The `groups` claim maps to AppSSO's `roles` claim. Therefore, for this proxy to work with AppSSO, users *MUST* have an e-mail defined, and at least one entry in `roles`. If the proxy container logs an error stating `Error redeeming code during OAuth2 callback: could not get claim "groups" [...]`, make sure that the user has `roles` provided in the `identityProvider`.

Application Single Sign-On how-to guides

This subsection describes the how-to guides for specific persona working with Application Single Sign-On (commonly called AppSSO):

- [Platform operators](#)
- [Service operators](#)
- [Application operators](#)
- [Troubleshoot Application Single Sign-on](#)

Application Single Sign-On for Platform Operators

The topics in this section tell you how to manage the Application Single Sign-On (commonly called AppSSO) package installation and what it installs. Use this section to learn:

- [Install AppSSO](#)
- [Upgrades](#)
- [Uninstall AppSSO](#)

Application Single Sign-On for Platform Operators

The topics in this section tell you how to manage the Application Single Sign-On (commonly called AppSSO) package installation and what it installs. Use this section to learn:

- [Install AppSSO](#)
- [Upgrades](#)
- [Uninstall AppSSO](#)

Install Application Single Sign-On

This topic tells you how to install Application Single Sign-On for VMware Tanzu (commonly called AppSSO) from the Tanzu Application Platform (commonly called TAP) package repository.



Note

Follow the steps in this topic if you do not want to use a profile to install Application Single Sign-On. For more information about profiles, see [Components and installation profiles](#).

What's inside

The AppSSO package installs the following resources:

- The `appsso` namespace with a deployment of the AppSSO controller and services for webhooks.
- [RBAC](#)
- [APIs](#)

Prerequisites

Before installing Application Single Sign-On, ensure that you have Tanzu Application Platform installed on your Kubernetes cluster.

The `sso.apps.tanzu.vmware.com` package has these dependencies:

- `cert-manager.tanzu.vmware.com`: Required at installation time and runtime. For more information see, [Install cert-manager](#).
- `crossplane.tanzu.vmware.com`: Required at installation time and runtime. For more information see, [Install Crossplane](#).
- `service-bindings.tanzu.vmware.com`: Required at runtime. For more information see, [Install Service Bindings](#).



Important

Installation time dependencies must be present on the cluster at the time the Application Single Sign-On package is being applied.

Runtime dependencies don't have to be present when the Application Single Sign-On package is being applied, but they are required eventually for it to function fully.

Install Application Single Sign-On for VMware Tanzu

1. Learn more about the AppSSO package by running:

```
tanzu package available get sso.apps.tanzu.vmware.com --namespace tap-install
```

2. Install the AppSSO package by running:

```
tanzu package install appsso \
  --namespace tap-install \
  --package sso.apps.tanzu.vmware.com \
  --version 4.0
```

3. Confirm the package has reconciled by running:

```
tanzu package installed get appsso --namespace tap-install
```

See also

- To configure the Application Single Sign-On package to meet your needs, see [Package configuration for Application Single Sign-On](#).
- To upgrade to a later version of the package, see [Upgrade Application Single Sign-On](#).
- When deployed on an OpenShift cluster, additional OpenShift-specific resources are installed. For more information, see [Application Single Sign-On for OpenShift clusters](#).

Upgrade Application Single Sign-On

This topic tells you how to upgrade Application Single Sign-On (commonly called AppSSO).

The [AppSSO](#) package is upgraded as part of your [TAP](#) package installation.

For migrating your resources in between versions, see the [Migration guides](#).

If you installed the [AppSSO](#) package on its own, and not as part of [TAP](#), you can upgrade it individually by running:

```
tanzu package installed update PACKAGE-INSTALLATION-NAME -p sso.apps.tanzu.vmware.com
-v 4.0 --values-file PATH-TO-YOUR-VALUES-YAML -n YOUR-INSTALL-NAMESPACE
```



Note

You can also upgrade Application Single Sign-On as part of upgrading Tanzu Application Platform as a whole. See [Upgrade Tanzu Application Platform](#) for more information.

Migration guides

v3.0.0 to v3.1.0

VMware recommends that you recreate your [AuthServers](#) after upgrading your Application Single Sign-On to [v3.1.0](#) with the following changes:

- Migrate field `.spec.identityProviders[*].openid.claimMappings["roles"]` to `.spec.identityProviders[*].openid.roles.fromUpstream.claim`.
- Migrate field `.spec.identityProviders[*].ldap.group.roleAttribute` to `.spec.identityProviders[*].ldap.roles.fromUpstream.attribute`.
- Migrate field `.spec.identityProviders[*].ldap.group.search` to `.spec.identityProviders[*].ldap.roles.fromUpstream.search`.
- Migrate field `.spec.identityProviders[*].saml.claimMappings["roles"]` to `.spec.identityProviders[*].saml.roles.fromUpstream.attribute`.

(Optional) If you plan to run Spring Boot 3 based [Workloads](#), you must perform the following migration tasks in your existing [ClientRegistration](#) resources:

- Migrate `.spec.clientAuthenticationMethod` values.
- Migrate the existing value `post` to `client_secret_post` or migrate the existing value `basic` to `client_secret_basic`.

v2.0.0 to v3.0.0

VMware recommends that you recreate your [AuthServers](#) after upgrading your Application Single Sign-On to [v3.0.0](#) with the following changes:

- Migrate the field `.spec.tls.disabled` to `.spec.tls.deactivated`.

v1.0.0 to v2.0.0

VMware recommends that you recreate your `AuthServers` after upgrading your Application Single Sign-On to v2.0.0 with the following changes:

- Migrate from `.spec.issuerURI` to `.spec.tls`:
 1. Configure one of `.spec.tls.{issuerRef, certificateRef, secretRef}`. See [Issuer URI & TLS](#) for more information.
 2. (Optional) Disable TLS with `.spec.tls.disabled`.
 3. Remove `.spec.issuerURI`.
 4. Delete your `AuthServer`-specific `Service` and ingress resources.
 5. Apply your `AuthServer`. You can find its issuer URI in `.status.issuerURI`.
 6. Update the redirect URIs in your upstream identity providers.

Application Single Sign-On templates your issuer URI and enables TLS. When using the newer `.spec.tls`, a custom `Service` and an ingress resource are no longer required.

It is not recommended to continue using `.spec.issuerURI` in Application Single Sign-On v2.0.0. To use `.spec.issuerURI` in v2.0.0, you must provide a `Service` and an ingress resource as in v1.0.0.

- If you use the `internalUnsafe` identity provider to migrate the existing users by replacing the bcrypt hash through the plaintext equivalent, you can still use the existing bcrypt passwords by prefixing them with `{bcrypt}`:

```
---
apiVersion: sso.apps.tanzu.vmware.com/v1alpha1
kind: AuthServer
metadata:
  # ...
spec:
  identityProviders:
    - name: internal
      internalUnsafe:
        users:
          # v1.0
          - username: test-user-1
            password: $2a$10$201z9o/tHlocFsHFTo0plukh03ApBYe4dRiXcqeyRQH6CNNtS8j
WK # bcrypt-encoded "password"
          # ...
          # v2.0
          - username: "test-user-1"
            password: "{bcrypt}$2a$10$201z9o/tHlocFsHFTo0plukh03ApBYe4dRiXcqeyRQ
H6CNNtS8jWK" # same bcrypt hash, with {bcrypt} prefix
          - username: "test-user-2"
            password: "password" # plaintext
          # ...
```

Uninstall Application Single Sign-On

This topic tells you how to uninstall Application Single Sign-On (commonly called AppSSO).

Delete the AppSSO package by running:

```
tanzu package installed delete appssso --namespace tap-install
```

To permanently delete and exclude AppSSO package from your Tanzu Application Platform install, edit your Tanzu Application Platform values file by including the following configuration:

```
excluded_packages:
- sso.apps.tanzu.vmware.com
```

For more information, navigate to [Exclude packages from a Tanzu Application Platform profile](#).

Application Single Sign-On for Service Operators

The following topics tell you how to configure a fully operational authorization server for Application Single Sign-On (commonly called AppSSO).

`AuthServer` represents the request for an OIDC authorization server. It results in the deployment of an authorization server backed by Redis. A Redis with mTLS is either automatically deployed for `AuthServer` or credentials to [external storage](#) can be provided. You can configure the labels with which clients can select an `AuthServer`, the namespaces it allows clients from, its issuer URI, its token signature keys, identity providers, and further details for its deployment.

`ClusterWorkloadRegistrationClass` exposes an `AuthServer` as a ready-to-claim service offering. Application operators can discover this offering and claim credentials. The mechanisms for this are provided by [Services Toolkit](#). This is the recommended way for offering and consuming AppSSO.

If you just want to get started in a non-production environment, `ClusterUnsafeTestLogin` is a zero-config API that produces an unsafe, ready-to-claim AppSSO service offering. It is a higher-level alternative to the combination of `AuthServer` and `ClusterWorkloadRegistrationClass`.

For a full explanation of the available APIs, refer to [the API reference](#).

The following sections outline the essential steps to configure a fully operational, ready-to-claim AppSSO service offering:

- [Configure an unsafe test login](#)
- [Annotations and labels](#)
- [Issuer URI and TLS](#)
- [TLS scenario guides](#)
- [CA certificates](#)
- [Configure workloads to trust a custom CA](#)
- [Identity providers](#)
- [Configure authorization](#)
- [Public clients and CORS](#)
- [Token settings](#)
- [Token signatures](#)
- [Storage](#)
- [AuthServer readiness](#)
- [Scale AuthServer](#)
- [Curate an AppSSO service offering](#)

Application Single Sign-On for Service Operators

The following topics tell you how to configure a fully operational authorization server for Application Single Sign-On (commonly called AppSSO).

`AuthServer` represents the request for an OIDC authorization server. It results in the deployment of an authorization server backed by Redis. A Redis with mTLS is either automatically deployed for `AuthServer` or credentials to [external storage](#) can be provided. You can configure the labels with which clients can select an `AuthServer`, the namespaces it allows clients from, its issuer URI, its token signature keys, identity providers, and further details for its deployment.

`ClusterWorkloadRegistrationClass` exposes an `AuthServer` as a ready-to-claim service offering. Application operators can discover this offering and claim credentials. The mechanisms for this are provided by [Services Toolkit](#). This is the recommended way for offering and consuming AppSSO.

If you just want to get started in a non-production environment, `ClusterUnsafeTestLogin` is a zero-config API that produces an unsafe, ready-to-claim AppSSO service offering. It is a higher-level alternative to the combination of `AuthServer` and `ClusterWorkloadRegistrationClass`.

For a full explanation of the available APIs, refer to [the API reference](#).

The following sections outline the essential steps to configure a fully operational, ready-to-claim AppSSO service offering:

- [Configure an unsafe test login](#)
- [Annotations and labels](#)
- [Issuer URI and TLS](#)
- [TLS scenario guides](#)
- [CA certificates](#)
- [Configure workloads to trust a custom CA](#)
- [Identity providers](#)
- [Configure authorization](#)
- [Public clients and CORS](#)
- [Token settings](#)
- [Token signatures](#)
- [Storage](#)
- [AuthServer readiness](#)
- [Scale AuthServer](#)
- [Curate an AppSSO service offering](#)

Configure an unsafe test login

This topic for service operators describes how you can get started with Application Single Sign-On for VMware Tanzu (commonly called AppSSO) in a non-production environment by using `ClusterUnsafeTestLogin`.

`ClusterUnsafeTestLogin` is a zero-config API that produces an unsafe, ready-to-claim AppSSO service offering. When you create a `ClusterUnsafeTestLogin`, you get a simple `AuthServer` and a `ClusterWorkloadRegistrationClass` for it. The `AuthServer` has a single login `user:password` and is configured to work without extra configuration.



Caution

`ClusterUnsafeTestLogin` is not safe for production. For production, use `AuthServer` and `ClusterWorkloadRegistrationClass`.

Configure a `ClusterUnsafeTestLogin`

The `ClusterUnsafeTestLogin` resource takes zero configuration except a `name`.

To configure a `ClusterUnsafeTestLogin` create a YAML file as follows:

```
---
apiVersion: sso.apps.tanzu.vmware.com/v1alpha1
kind: ClusterUnsafeTestLogin
metadata:
  name: demo
```

Use the unsafe test login

After applying the `ClusterUnsafeTestLogin` resource, application operators can discover credentials for it by running:

```
tanzu service class list
```

Example output:

```
NAME      DESCRIPTION
demo     Login by AppSSO - user:password - UNSAFE FOR PRODUCTION!
```

For how to application operators can claim credentials, see [Claim credentials for an Application Single Sign-On service offering](#).

Annotations and labels for AppSSO

This topic tells you how to configure annotations and labels for Application Single Sign-On (commonly called AppSSO).

An `AuthServer` is selectable by `ClientRegistration` through labels. The namespace an `AuthServer` allows `ClientRegistrations` from is controlled with an annotation.

Labels

`ClientRegistrations` select an `AuthServer` with `spec.authServerSelector`. Therefore, an `AuthServer` must have a set of labels that uniquely identifies it amongst all `AuthServer`. A `ClientRegistration` must match only one `AuthServer`. Registration fails if multiple or no `AuthServer` resources are matched.

For example:

```
---
apiVersion: sso.apps.tanzu.vmware.com/v1alpha1
kind: AuthServer
metadata:
  labels:
    env: dev
    ldap: True
    saml: True
# ...
---
```

```

apiVersion: sso.apps.tanzu.vmware.com/v1alpha1
kind: AuthServer
metadata:
  labels:
    env: prod
    saml: True
# ...

```

Allowing client namespaces

`AuthServer` optionally controls from which namespace (one of more) it allows `ClientRegistrations` with the annotation:

```

---
apiVersion: sso.apps.tanzu.vmware.com/v1alpha1
kind: AuthServer
metadata:
  annotations:
    sso.apps.tanzu.vmware.com/allow-client-namespaces: "my-apps"

```

To allow `ClientRegistrations` only from a restricted set of namespaces, you must set this annotation. Its value is a comma-separated list of allowed `Namespaces`, for example, `"app-team-red,app-team-green"`. If the annotation is missing, the default value is `*`, denoting that all client namespaces are allowed.

VMware recommends explicitly restricting to only workload-related namespaces to narrow the scope of the `AuthServer` operation.

Unsafe configuration

`AuthServer` enforces secure and production-ready configuration. However, sometimes it is required to opt-out those constraints, for example, when deploying `AuthServer` on an iterate cluster.



Caution

Allowing **unsafe** is not recommended for production.

Unsafe identity provider

The `InternalUnsafe` identity provider cannot be used unless explicitly allowed by including the annotation `sso.apps.tanzu.vmware.com/allow-unsafe-identity-provider` as follows:

```

---
apiVersion: sso.apps.tanzu.vmware.com/v1alpha1
kind: AuthServer
metadata:
  annotations:
    sso.apps.tanzu.vmware.com/allow-unsafe-identity-provider: ""
spec:
  identityProviders:
    - name: static-users
      internalUnsafe:
# ...

```

If the annotation is not present and an `InternalUnsafe` identity provider is configured the `AuthServer` will not apply.

Unsafe issuer URI

It's not possible to use a plain HTTP issuer URI, unless it's explicitly allowed by including the annotation `sso.apps.tanzu.vmware.com/allow-unsafe-issuer-uri` as follows:

```
---
apiVersion: sso.apps.tanzu.vmware.com/v1alpha1
kind: AuthServer
metadata:
  annotations:
    sso.apps.tanzu.vmware.com/allow-unsafe-issuer-uri: ""
spec:
  issuerURI: http://this.is.unsafe
```

If the annotation is not present and a plain HTTP issuer URI is configured, the `AuthServer` does not apply.

Issuer URI and TLS for AppSSO

This topic tells you how to configure the issuer URI and TLS for Application Single Sign-On (commonly called AppSSO).

Overview

An `AuthServer` entry point for its clients and their end-users is called *issuer URI*. AppSSO will template the issuer URI and create a TLS-enabled `Ingress` for it. For this purpose, your platform operator configures the domain name and template. Once you created and `AuthServer` you can find the actual URL in `.status.issuerURI`.

You can configure whether and how to obtain a TLS certificate for the issuer URI by using `.spec.tls`. Unless TLS is deactivated, HTTPS is enforced. For example, requests for `http://` are redirected to `https://`. You can observe the TLS configuration in `.status.tls`.

If AppSSO is installed with a [default issuer](#), you can omit `AuthServer.spec.tls` and a TLS certificate is obtained automatically. This is the recommended approach for TLS.

For example:

```
apiVersion: sso.apps.tanzu.vmware.com/v1alpha1
kind: AuthServer
metadata:
  name: login
  namespace: services
  # ...
spec:
  # ...
status:
  issuerURI: https://login.services.example.com
  tls:
    issuerRef:
      name: my-default-issuer
      kind: ClusterIssuer
      group: cert-manager.io
  # ...
```

This `AuthServer` is reachable at its templated issuer URI `https://login.services.example.com` and serves a TLS certificate obtained from `my-default-issuer`.

Learn how to configure TLS for your `AuthServer`:

- [Issuer URI and TLS for AppSSO](#)
 - [Overview](#)

- [Configure TLS by using a \(Cluster\)Issuer](#)
- [Configure TLS by using a Certificate](#)
- [Configure TLS by using a Secret](#)
- [Deactivate TLS \(unsafe\)](#)
- [Allow Workloads to trust a custom CA AuthServer](#)

There are many use-cases that pertain to TLS use. To find out which scenario applies to you and how to configure it, see [TLS scenario guides](#).

If your [AuthServer](#) obtains a certificate from a custom CA, you can enable App Operators to trust it. See [Allow Workloads to trust a custom CA AuthServer](#) for more information.

Configure TLS by using a (Cluster)Issuer

You can obtain a TLS certificate for your [AuthServer](#) by referencing a [cert-manager.io/v1/Issuer](#) or [cert-manager.io/v1/ClusterIssuer](#). This enables AppSSO to retrieve a [cert-manager.io/v1/Certificate](#) from the issuer and apply it to the [Ingress](#) configuration.

The composition of an [AuthServer](#) and a self-signed [Issuer](#) looks as follows:

```
---
apiVersion: cert-manager.io/v1
kind: Issuer
metadata:
  name: my-selfsigned-issuer
  namespace: services
spec:
  selfSigned: { }

---
apiVersion: sso.apps.tanzu.vmware.com/v1alpha1
kind: AuthServer
metadata:
  name: login
  namespace: services
  # ...
spec:
  tls:
    issuerRef:
      name: my-selfsigned-issuer
      # 'kind: Issuer' can be omitted. It is the default.
```

The composition of an [AuthServer](#) and a *self-signed* [ClusterIssuer](#) for looks as follows:

```
---
apiVersion: cert-manager.io/v1
kind: ClusterIssuer
metadata:
  name: my-selfsigned-cluster-issuer
spec:
  selfSigned: { }

---
apiVersion: sso.apps.tanzu.vmware.com/v1alpha1
kind: AuthServer
metadata:
  name: login
  namespace: services
  # ...
spec:
  tls:
```

```

issuerRef:
  name: my-selfsigned-cluster-issuer
  kind: ClusterIssuer

```

Confirm that your `AuthServer` serves a TLS certificate from the specified issuer by visiting its `{.status.issuerURI}`.

For more information about cert-manager and its APIs, see [cert-manager documentation](#).

Configure TLS by using a Certificate

In order to configure TLS for your `AuthServer` using a `cert-manager.io/v1/Certificate` you must know what its templated issuer URI will be. You can infer it from the AppSSO package's domain template.

The composition of an `AuthServer` and a `Certificate` looks as follows:

```

apiVersion: cert-manager.io/v1
kind: Certificate
metadata:
  name: login
  namespace: services
spec:
  dnsNames:
    - login.services.example.com
  issuerRef:
    name: my-cluster-issuer
    kind: ClusterIssuer
  secretName: login-cert

---
apiVersion: sso.apps.tanzu.vmware.com/v1alpha1
kind: AuthServer
metadata:
  name: login
  namespace: services
  # ...
spec:
  tls:
    certificateRef:
      name: login

```

Confirm that your `AuthServer` serves the specified Certificate by visiting its `{.status.issuerURI}`.

For more information about cert-manager and its APIs, see [cert-manager documentation](#).

Configure TLS by using a Secret

If you don't want to use cert-manager.io's APIs or you have a raw TLS certificate in a TLS `Secret`, you can compose it with your `AuthServer` by referencing it. The certificate must be for the issuer URI that will be templated for the `AuthServer`. You can infer it from the AppSSO package's domain template.

The composition of an `AuthServer` and TLS `Secret` looks as follows:

```

apiVersion: v1
kind: Secret
metadata:
  name: my-tls-cert
  namespace: services
type: kubernetes.io/tls
data:
  tls.key: # ...

```

```

tls.crt: # ...

---
apiVersion: sso.apps.tanzu.vmware.com/v1alpha1
kind: AuthServer
metadata:
  name: login
  namespace: services
  # ...
spec:
  tls:
    secretRef:
      name: my-tls-cert

```

Deactivate TLS (unsafe)

If you deactivate TLS autoconfiguration, `AuthServer` only works over plain HTTP. You must deactivate TLS with the `sso.apps.tanzu.vmware.com/allow-unsafe-issuer-uri: ""` annotation.

```

---
apiVersion: sso.apps.tanzu.vmware.com/v1alpha1
kind: AuthServer
metadata:
  name: login
  namespace: services
  annotations:
    sso.apps.tanzu.vmware.com/allow-unsafe-issuer-uri: ""
  # ...
spec:
  tls:
    deactivated: true

```



Caution

Deactivating TLS is unsafe and not recommended for production.

Allow Workloads to trust a custom CA AuthServer

If your `AuthServer` obtains a certificate from a custom CA, its consumers do not trust it by default. You can enable App Operators' `Workloads` to trust your `AuthServer` by exporting a `ca-certificates` service binding `Secret` to their `Namespace`.

A composition of `SecretTemplate` and `SecretExport` are a way to achieve this. If your custom CA's TLS `Secret` is present in the namespace `my-certs`, then you can provide a `ca-certificates` service binding `Secret` like so:

```

---
apiVersion: secretgen.carvel.dev/v1alpha1
kind: SecretTemplate
metadata:
  name: ca-cert
  namespace: my-certs
spec:
  inputResources:
    - name: my-custom-ca
      ref:
        apiVersion: v1
        kind: Secret
        name: my-custom-ca

```

```

template:
  data:
    ca.crt: $(.my-custom-ca.data.tls\.crt)
  stringData:
    type: ca-certificates

---
apiVersion: secretgen.carvel.dev/v1alpha1
kind: SecretExport
metadata:
  name: ca-cert
  namespace: my-certs
spec:
  toNamespace: "*"

```

This templates a `ca-certificates` service binding `Secret` which `Workload` can claim to trust the custom CA. It does not contain the CA's private key and is generally safe to share.

However, be careful, this example exports to all namespace on the cluster. If this does not comply with your policies, then adjust the target namespaces if required.

For more information about secretgen-controller and its APIs, see [secretgen-controller documentation](#) in GitHub.

TLS scenario guides for AppSSO

This topic tells you how to obtain a TLS certificate in different scenarios for Application Single Sign-On (commonly called AppSSO).

Overview

`AuthServer` is a piece of security infrastructure. It is imperative to configure TLS for it, so that its issuer URI's scheme is `https://`.

`AuthServer.spec.tls` accommodates different scenarios for obtaining a TLS certificate. Select the scenario that matches your case.

The recommended path is to install AppSSO with a `default issuer`. In that case, you can omit `AuthServer.spec.tls` and a TLS certificate is obtained automatically.

Prerequisites

Each of the scenarios requires that the AppSSO package is installed and configured. In particular, its `domain_name` must match the ingress domain of your cluster. The presented YAML resources assume `my-tap.example.com` as the ingress domain. Therefore, the AppSSO configuration values look as follows:

```

#! AppSSO values
domain_name: "my-tap.example.com"

```

The default `domain_template: "{{.Name}}.{{.Namespace}}.{{.Domain}}"` works for most scenarios. If a scenario requires a bespoke `domain_template`, it contains the relevant instructions.

After applying each scenario, wait for your `AuthServer` to become ready and then test it by running:

```

kubectl wait --namespace login authserver/sso --for condition=Ready=True --timeout 500
s
curl --location "$(kubectl get --namespace login authserver sso --output=jsonpath='{.status.issuerURI}').well-known/openid-configuration"

```

Alternatively, visit the [AuthServer](#) with your browser. You can obtain its issuer URI by running:

```
kubectl get --namespace login authserver sso --output=jsonpath='{.status.issuerURI}'
```



Caution

Before applying each scenario, you must configure your AppSSO correctly, and make sure that all certificates and DNS names comply with your setup.

Using a default issuer

VMware recommend using a [default issuer](#), because this approach separates the responsibilities of platform operators and service operators. In this case, the `Authserver.spec.tls` field is not required.

To verify whether [AppSSO](#) was installed with a default issuer, run:

```
kctrl package installed get --namespace tap-install --package-install tap --values-file-output tap-values.yaml
```

If a `shared.ingress_issuer` appears in your `tap-values.yaml` file, you have a default issuer.



Important

Ensure [kctrl](#) is installed.

```
apiVersion: v1
kind: Namespace
metadata:
  name: login

---
apiVersion: sso.apps.tanzu.vmware.com/v1alpha1
kind: AuthServer
metadata:
  name: sso
  namespace: login
  annotations:
    sso.apps.tanzu.vmware.com/allow-unsafe-identity-provider: ""
    sso.apps.tanzu.vmware.com/documentation: Uses the default issuer for TLS
spec:
  identityProviders:
    - name: test-users
      internalUnsafe:
        users:
          - username: user
            password: password
  tokenSignature:
    signAndVerifyKeyRef:
      name: signing-key

---
apiVersion: secretgen.k14s.io/v1alpha1
kind: RSAKey
metadata:
  name: signing-key
  namespace: login
spec:
  secretTemplate:
```

```

type: Opaque
stringData:
  key.pem: $(privateKey)
  pub.pem: $(publicKey)

```

Using a `ClusterIssuer`

A `ClusterIssuer` is a cluster-scoped API provided by `cert-manager` from which certificates can be obtained programmatically.

This scenario puts all resources into a single YAML file and uses [Let's Encrypt's production API](#). You might get the `ClusterIssuer` from your platform operators.

For more information, see [cert-manager documentation](#).



Caution

[Let's Encrypt's production API rate limits](#) apply.

```

---
apiVersion: cert-manager.io/v1
kind: ClusterIssuer
metadata:
  name: letsencrypt-production
spec:
  acme:
    privateKeySecretRef:
      name: letsencrypt-production
    server: https://acme-v02.api.letsencrypt.org/directory
    solvers:
      - http01:
          ingress:
            class: contour
---
apiVersion: v1
kind: Namespace
metadata:
  name: login
---
apiVersion: sso.apps.tanzu.vmware.com/v1alpha1
kind: AuthServer
metadata:
  name: sso
  namespace: login
  annotations:
    sso.apps.tanzu.vmware.com/allow-unsafe-identity-provider: ""
spec:
  #! --- TLS ---
  tls:
    issuerRef:
      name: letsencrypt-production
      kind: ClusterIssuer
  #! -----
  identityProviders:
    - name: test-users
      internalUnsafe:
        users:
          - username: user
            password: password
  tokenSignature:

```

```

    signAndVerifyKeyRef:
      name: signing-key

---
apiVersion: secretgen.k14s.io/v1alpha1
kind: RSAKey
metadata:
  name: signing-key
  namespace: login
spec:
  secretTemplate:
    type: Opaque
    stringData:
      key.pem: $(privateKey)
      pub.pem: $(publicKey)

```

Using an Issuer

This scenario is identical to [Using a ClusterIssuer](#), except that the Issuer is scoped to a namespace and must be located in the same namespace as the [AuthServer](#).

```

---
apiVersion: v1
kind: Namespace
metadata:
  name: login

---
apiVersion: cert-manager.io/v1
kind: Issuer
metadata:
  name: letsencrypt-production
  namespace: login
spec:
  acme:
    privateKeySecretRef:
      name: letsencrypt-production
    server: https://acme-v02.api.letsencrypt.org/directory
    solvers:
      - http01:
          ingress:
            class: contour

---
apiVersion: sso.apps.tanzu.vmware.com/v1alpha1
kind: AuthServer
metadata:
  name: sso
  namespace: login
  annotations:
    sso.apps.tanzu.vmware.com/allow-unsafe-identity-provider: ""
spec:
  #! --- TLS ---
  tls:
    issuerRef:
      name: letsencrypt-production
  #! -----
  identityProviders:
    - name: test-users
      internalUnsafe:
        users:
          - username: user
            password: password
  tokenSignature:

```

```

    signAndVerifyKeyRef:
      name: signing-key

---
apiVersion: secretgen.k14s.io/v1alpha1
kind: RSAKey
metadata:
  name: signing-key
  namespace: login
spec:
  secretTemplate:
    type: Opaque
    stringData:
      key.pem: $(privateKey)
      pub.pem: $(publicKey)

```

Using an existing Certificate

A [Certificate](#) is an API provided by [cert-manager](#) that is scoped to a namespace and represents a TLS certificate obtained from a [\(Cluster\)Issuer](#). To create a [Certificate](#), you must know the name and kind of your issuer.

These scenarios use [Let's Encrypt](#)'s production API and require that a [ClusterIssuer](#) by the name [letsencrypt-production](#) exists. See [Using a ClusterIssuer](#) for how to set up the issuer.

When using [Certificate](#), its `.spec.dnsNames` must contain the FQDN of the templated issuer URI. The `domain_name` and `domain_template` of your AppSSO package installation must comply with your DNS name.

If you have an existing [Certificate](#) in the same [Namespace](#) where the [AuthServer](#) is installed, use the following AppSSO configuration values:

```

---
apiVersion: v1
kind: Namespace
metadata:
  name: login

---
apiVersion: cert-manager.io/v1
kind: Certificate
metadata:
  name: sso
  namespace: login
spec:
  dnsNames:
    - "sso.login.my-tap.example.com"
  issuerRef:
    name: letsencrypt-production
    kind: ClusterIssuer
  secretName: sso-cert

---
apiVersion: sso.apps.tanzu.vmware.com/v1alpha1
kind: AuthServer
metadata:
  name: sso
  namespace: login
  annotations:
    sso.apps.tanzu.vmware.com/allow-unsafe-identity-provider: ""
spec:
  #! --- TLS ---
  tls:
    certificateRef:

```



```

    name: sso
  #! -----
  identityProviders:
    - name: test-users
      internalUnsafe:
        users:
          - username: user
            password: password
      tokenSignature:
        signAndVerifyKeyRef:
          name: signing-key
  ---
  apiVersion: secretgen.k14s.io/v1alpha1
  kind: RSAKey
  metadata:
    name: signing-key
    namespace: login
  spec:
    secretTemplate:
      type: Opaque
      stringData:
        key.pem: $(privateKey)
        pub.pem: $(publicKey)

```

`secretgen-controller` allows you to export and import `Secrets` across namespaces. When your `Certificate` is located in another namespace, for example, it's controlled by another team, you can import its `Secret` to other namespaces. If you have an existing `Certificate` in another `Namespace`, use the following AppSSO configuration values:

```

---
apiVersion: v1
kind: Namespace
metadata:
  name: tls
---
apiVersion: cert-manager.io/v1
kind: Certificate
metadata:
  name: sso
  namespace: tls
spec:
  dnsNames:
    - "sso.login.my-tap.example.com"
  issuerRef:
    name: letsencrypt-production
    kind: ClusterIssuer
  secretName: sso-cert
---
apiVersion: secretgen.carvel.dev/v1alpha1
kind: SecretExport
metadata:
  name: sso-cert
  namespace: tls
spec:
  toNamespace: login
---
apiVersion: v1
kind: Namespace
metadata:
  name: login

```

```

---
apiVersion: secretgen.carvel.dev/v1alpha1
kind: SecretImport
metadata:
  name: sso-cert
  namespace: login
spec:
  fromNamespace: tls

---
apiVersion: sso.apps.tanzu.vmware.com/v1alpha1
kind: AuthServer
metadata:
  name: sso
  namespace: login
  annotations:
    sso.apps.tanzu.vmware.com/allow-unsafe-identity-provider: ""
spec:
  #! --- TLS ---
  tls:
    secretRef:
      name: sso-cert
  #! -----
  identityProviders:
    - name: test-users
      internalUnsafe:
        users:
          - username: user
            password: password
  tokenSignature:
    signAndVerifyKeyRef:
      name: signing-key

---
apiVersion: secretgen.k14s.io/v1alpha1
kind: RSAKey
metadata:
  name: signing-key
  namespace: login
spec:
  secretTemplate:
    type: Opaque
  stringData:
    key.pem: $(privateKey)
    pub.pem: $(publicKey)

```



Caution

Be cautious when using `SecretExport` and `SecretImport` to facilitate the transfer across namespaces.

Using an existing TLS certificate

If you have an existing TLS certificate and private key, for example, if your TLS certificate was created outside the cluster, you can apply it directly.

If you don't have a TLS certificate, there are numerous ways to obtain TLS certificates. One of the simplest methods is to use a tool such as [mkcert](#), [step](#) or [openssl](#) in GitHub.

If you have an existing TLS certificate in the same `Namespace` where the `AuthServer` is installed, use the following AppSSO configuration values:

```

---
apiVersion: v1
kind: Namespace
metadata:
  name: login

---
apiVersion: v1
kind: Secret
type: kubernetes.io/tls
metadata:
  name: my-cert
  namespace: login
stringData:
  #! --- ReplaceMe - certificate and private key for "sso.login.my-tap.example.com ---
  tls.crt: |
    -----BEGIN CERTIFICATE-----
    # redacted
    -----END CERTIFICATE-----
  tls.key: |
    -----BEGIN PRIVATE KEY-----
    # redacted
    -----END PRIVATE KEY-----
  #! -----
---
apiVersion: sso.apps.tanzu.vmware.com/v1alpha1
kind: AuthServer
metadata:
  name: sso
  namespace: login
  annotations:
    sso.apps.tanzu.vmware.com/allow-unsafe-identity-provider: ""
spec:
  #! --- TLS ---
  tls:
    secretRef:
      name: my-cert
  #! -----
  identityProviders:
    - name: test-users
      internalUnsafe:
        users:
          - username: user
            password: password
  tokenSignature:
    signAndVerifyKeyRef:
      name: signing-key

---
apiVersion: secretgen.k14s.io/v1alpha1
kind: RSAKey
metadata:
  name: signing-key
  namespace: login
spec:
  secretTemplate:
    type: Opaque
    stringData:
      key.pem: $(privateKey)
      pub.pem: $(publicKey)

```



Important

The TLS certificate `tls.crt` and its corresponding private key `tls.key` must be stored in a secret with these keys.

If you have an existing TLS certificate in another `Namespace`, use the following AppSSO configuration values:

```

---
apiVersion: v1
kind: Namespace
metadata:
  name: tls

---
apiVersion: v1
kind: Secret
type: kubernetes.io/tls
metadata:
  name: my-cert
  namespace: tls
stringData:
  #! --- ReplaceMe - certificate and private key for "sso.login.my-tap.example.com ---
  tls.crt: |
    -----BEGIN CERTIFICATE-----
    # redacted
    -----END CERTIFICATE-----
  tls.key: |
    -----BEGIN PRIVATE KEY-----
    # redacted
    -----END PRIVATE KEY-----
  #! -----
---
apiVersion: secretgen.carvel.dev/v1alpha1
kind: SecretExport
metadata:
  name: my-cert
  namespace: tls
spec:
  toNamespace: login

---
apiVersion: v1
kind: Namespace
metadata:
  name: login

---
apiVersion: secretgen.carvel.dev/v1alpha1
kind: SecretImport
metadata:
  name: my-cert
  namespace: login
spec:
  fromNamespace: tls

---
apiVersion: sso.apps.tanzu.vmware.com/v1alpha1
kind: AuthServer
metadata:
  name: sso
  namespace: login
annotations:
  sso.apps.tanzu.vmware.com/allow-unsafe-identity-provider: ""
spec:

```

```

#! --- TLS ---
tls:
  secretRef:
    name: my-cert
#! -----
identityProviders:
  - name: test-users
    internalUnsafe:
      users:
        - username: user
          password: password
tokenSignature:
  signAndVerifyKeyRef:
    name: signing-key

---
apiVersion: secretgen.k14s.io/v1alpha1
kind: RSAKey
metadata:
  name: signing-key
  namespace: login
spec:
  secretTemplate:
    type: Opaque
    stringData:
      key.pem: $(privateKey)
      pub.pem: $(publicKey)

```



Important

The TLS certificate `tls.crt` and its corresponding private key `tls.key` must be stored in a secret with these keys.

Be cautious when using `SecretExport` and `SecretImport` to facilitate the transfer across namespaces.

Using an existing wildcard TLS certificate

To use wildcard certificates for DNS names such as `*.my-tap.example.com`, you must edit the AppSSO's `domain_template` so that the templated issuer URIs for `AuthServer` match the wildcard. For example:

- `sso.login.my-tap.example.com` does not match the wildcard.
- `sso-login.my-tap.example.com` matches the wildcard.

The following AppSSO configuration values accommodates a wildcard certificate for `*.my-tap.example.com`:

```

#! AppSSO values
domain_name: "my-tap.example.com"
domain_template: "{{.Name}}-{{.Namespace}}.{{.Domain}}"
#!
                ^ note the dash

```

The following scenarios require TLS Secrets, but the same concept applies to `Certificate`.



Important

When using a [\(Cluster\) Issuer](#) for [Let's Encrypt](#), you cannot request wildcard certificates when it uses the [http01 challenge solver](#).

If you have an existing wildcard TLS certificate in the same [Namespace](#) where the AuthServer is installed, use the following AppSSO configuration values:

```

---
apiVersion: v1
kind: Namespace
metadata:
  name: login

---
apiVersion: v1
kind: Secret
type: kubernetes.io/tls
metadata:
  name: my-wildcard-cert
  namespace: login
stringData:
  #! --- ReplaceMe - certificate and private key for "*.my-tap.example.com ---
  tls.crt: |
    -----BEGIN CERTIFICATE-----
    # redacted
    -----END CERTIFICATE-----
  tls.key: |
    -----BEGIN PRIVATE KEY-----
    # redacted
    -----END PRIVATE KEY-----
  #! -----

---
apiVersion: sso.apps.tanzu.vmware.com/v1alpha1
kind: AuthServer
metadata:
  name: sso
  namespace: login
  annotations:
    sso.apps.tanzu.vmware.com/allow-unsafe-identity-provider: ""
spec:
  #! --- TLS ---
  tls:
    secretRef:
      name: my-wildcard-cert
  #! -----
  identityProviders:
    - name: test-users
      internalUnsafe:
        users:
          - username: user
            password: password
  tokenSignature:
    signAndVerifyKeyRef:
      name: signing-key

---
apiVersion: secretgen.k14s.io/v1alpha1
kind: RSAKey
metadata:
  name: signing-key
  namespace: login
spec:
  secretTemplate:
    type: Opaque

```

```
stringData:
  key.pem: $(privateKey)
  pub.pem: $(publicKey)
```

**Note**

This scenario is similar to using an existing TLS certificate in the same namespace, except that the certificate is a wildcard.

If you have an existing wildcard TLS certificate in another [Namespace](#), use the following AppSSO configuration values:

```
---
apiVersion: v1
kind: Namespace
metadata:
  name: tls

---
apiVersion: v1
kind: Secret
type: kubernetes.io/tls
metadata:
  name: my-wildcard-cert
  namespace: login
stringData:
  #! --- Certificate and private key for "*.my-tap.example.com ---
  tls.crt: |
    -----BEGIN CERTIFICATE-----
    # redacted
    -----END CERTIFICATE-----
  tls.key: |
    -----BEGIN PRIVATE KEY-----
    # redacted
    -----END PRIVATE KEY-----
  #! -----

---
apiVersion: secretgen.carvel.dev/v1alpha1
kind: SecretExport
metadata:
  name: my-cert
  namespace: tls
spec:
  toNamespace: login

---
apiVersion: v1
kind: Namespace
metadata:
  name: login

---
apiVersion: secretgen.carvel.dev/v1alpha1
kind: SecretImport
metadata:
  name: my-cert
  namespace: login
spec:
  fromNamespace: tls

---
apiVersion: sso.apps.tanzu.vmware.com/v1alpha1
```

```

kind: AuthServer
metadata:
  name: sso
  namespace: login
  annotations:
    sso.apps.tanzu.vmware.com/allow-unsafe-identity-provider: ""
spec:
  #! --- TLS ---
  tls:
    secretRef:
      name: my-wildcard-cert
  #! -----
  identityProviders:
    - name: test-users
      internalUnsafe:
        users:
          - username: user
            password: password
  tokenSignature:
    signAndVerifyKeyRef:
      name: signing-key

---
apiVersion: secretgen.k14s.io/v1alpha1
kind: RSAKey
metadata:
  name: signing-key
  namespace: login
spec:
  secretTemplate:
    type: Opaque
  stringData:
    key.pem: $(privateKey)
    pub.pem: $(publicKey)

```



Note

This scenario is similar to using an existing TLS certificate in another namespace, except that the certificate is a wildcard.

CA certificates for AppSSO

This topic tells you how to configure CA certificates for `AuthServer` in Application Single Sign-On (commonly called AppSSO).

An `AuthServer` can trust custom CAs. You can establish either for all `AuthServers` or for a single `AuthServer`. This is useful when either your `identity provider` or `storage` serves certificates from a custom CA.

In most cases, CA certificates are PEM-encoded and located in a `Secret` referred from `.spec.caCerts[].secretRef.name`. The controller considers all `Secret` entries matching `*(.crt|ca-bundle)`. That means you can include multiple CA certificates in a single `Secret` or spread them across multiple `Secrets`.

After being created, an `AuthServer` reports the trusted, total custom CA certificates in its `.status.caCerts` together with the location where it sources them from. This includes the CA certificates that are trusted by all `AuthServers`.

For example:

```

---
apiVersion: v1
kind: Secret
metadata:
  name: my-ca
  namespace: services
stringData:
  my.ca-bundle: |
    This is My Company's custom CA. It's common name is "My CA".
    -----BEGIN CERTIFICATE-----
    ...
    -----END CERTIFICATE-----
---
apiVersion: sso.apps.tanzu.vmware.com/v1alpha1
kind: AuthServer
metadata:
  name: login
  namespace: services
  # ...
spec:
  caCerts:
    - secretRef:
        name: my-ca
    # ...
status:
  caCerts:
    - cert:
        subject: CN=My CA,O=My Company,C=Happyland
        source:
          secretEntry: service/my-ca[my.ca-bundle]
    - cert:
        subject: CN=My other CA,O=My Company,C=Happyland
        source:
          secretEntry: appssso/appssso-controller[controller.yaml]
    # ...

```

CA certificates configured for all `AuthServers` by using the package installation's `ca_cert_data` are sourced from `secretEntry: appssso/appssso-controller[controller.yaml]`. This denotes the AppSSO controller's configuration `Secret`.

Configure workloads to trust a custom CA

This topic tells you how to configure workloads to trust a custom Certificate Authority (commonly called CA) for Application Single Sign-On (commonly called AppSSO).

Overview

If your `ClientRegistration` selects an `AuthServer` that serves a certificate from a custom CA, your `Workload` does not trust it by default. This is because the certificate is not issued by a trusted certificate authority from the `Workload`'s perspective.

To establish trust between a `Workload` and an `AuthServer`:

Step	Task	Link
1.	Service Operator exports the custom CA certificate <code>Secret</code> resource from the namespace in which it is issued.	Exporting custom CA certificate Secret
2.	Service Operator imports the custom CA certificate <code>Secret</code> to the namespace in which the <code>Workload</code> is created.	Importing custom CA certificate Secret

Step	Task	Link
3.	Append the deployed <code>Workload</code> as a service resource claim, denoting the custom CA certificate <code>Secret</code> in the workload namespace.	Appending custom CA certificate Secret reference to Workload



Important

These steps are mandatory if Tanzu Application Platform is installed with the default self-signed `ClusterIssuer` resource, in which the CA is custom.

Exporting custom CA certificate Secret

A `ca-certificates` service binding `Secret` allows to configure trust for custom CAs.

For more information about exporting CA certificate Secrets, see [Allow Workloads to trust a custom CA AuthServer](#).

Example: Create a `ca-certificates`-type ServiceBinding Secret from template and offer Tanzu Application Platform's default self-signed CA certificate Secret to workloads namespace.

```
---
apiVersion: secretgen.carvel.dev/v1alpha1
kind: SecretTemplate
metadata:
  name: tap-ca-cert
  namespace: cert-manager # The namespace in which your custom CA
Secret resides.
spec:
  inputResources:
    - name: tap-ingress-selfsigned-root-ca
      ref:
        apiVersion: v1 # The custom CA certificate Secret.
        kind: Secret # ^^
        name: tap-ingress-selfsigned-root-ca # ^^
  template:
    data:
      ca.crt: $(.tap-ingress-selfsigned-root-ca.data.tls.crt)
    stringData:
      type: ca-certificates
---
apiVersion: secretgen.carvel.dev/v1alpha1
kind: SecretExport
metadata:
  name: tap-ca-cert # The name of the SecretTemplate that created the "ca-ce
rtificates" Secret.
  namespace: cert-manager # The namespace in which Tanzu Application Platform's se
lf-signed ClusterIssuer stores its CA cert Secret.
spec:
  toNamespace: my-apps # The namespace in which Workloads are deployed.
```

Importing custom CA certificate Secret

After the custom CA certificate Secret is exported from its original namespace, you can import it into the workloads' namespace.

Example: Accept Tanzu Application Platform's default self-signed CA certificate Secret offer.

```
---
apiVersion: secretgen.carvel.dev/v1alpha1
kind: SecretImport
```

```

metadata:
  name: tap-ca-cert
  namespace: my-apps           # The namespace in which Workloads are deployed.
spec:
  fromNamespace: cert-manager # The namespace in which your custom CA certificate Secret resides.

```

Appending custom CA certificate Secret reference to Workload

With custom CA certificate available in the workloads' namespace, you can append it to the `Workload` as a service resource claim:

Example: Appending custom CA certificate Secret as a resource claim.

```

---
apiVersion: carto.run/v1alpha1
kind: Workload
# ...
spec:
  serviceClaims:
    - name: ca-cert
      ref:
        apiVersion: v1 # The custom CA Secret template that is imported into the workloads' namespace.
        kind: Secret # ^^
        name: tap-ca-cert # ^^
# ...

```

Alternatively, you can provide the workload with a `--service-ref` parameter for the same effect:

```
--service-ref "ca-cert=v1:Secret:tap-ca-cert"
```

For more information about `secretgen-controller` and its APIs, see [secretgen-controller documentation](#) in GitHub.

Identity providers for AppSSO

This topic tells you how to configure Application Single Sign-On (commonly called AppSSO) to use external identity providers (commonly called IdPs).

Users can log in by using external identity providers. OpenID Connect and LDAP providers are supported. SAML providers have limited experimental support. An `AuthServer` does not manage users internally. Developers can get started quickly without needing to connect to an IdP by using static hard-coded users, which is for development purposes only.

Identity providers are configured under `spec.identityProviders`, learn more from [the API reference](#).



Caution

Changes to `spec.identityProviders` do not take effect immediately because the operator will roll out a new deployment of the authorization server.

End-users will be able to log in with these providers when they go to `{spec.issuerURI}` in their browser.

Use the following sections to learn how to configure identity providers for an `AuthServer`:

- [OpenID](#)
- [LDAP](#)
- [SAML \(experimental\)](#)
- [InternalUnsafe](#)

Use the following sections for a deeper understanding of advanced identity provider configurations:

- [Identity token claims mapping](#)
- [Roles claim filtering](#)
- [Roles claim mapping and filtering explained](#)
- [Configure authorization](#)
- [Restrictions](#)

OpenID Connect providers

To set up an OpenID Connect provider, provide the following information for your `AuthServer`:

```
apiVersion: sso.apps.tanzu.vmware.com/v1alpha1
kind: AuthServer
metadata:
# ...
spec:
  identityProviders:
    - name: my-oidc-provider
      openID:
        issuerURI: https://openid.example.com
        clientID: my-client-abcdef
        clientSecretRef:
          name: my-openid-client-secret
        scopes:
          - "openid"
          - "other-scope"
        authorizationUri: https://example.com/oauth2/authorize
        tokenUri: https://example.com/oauth2/token
        jwksUri: https://example.com/oauth2/jwks
        roles:
          fromUpstream:
            claim: "MY-OIDC-PROVIDER-GROUPS"
          idToken:
            claims:
              - fromUpstream: ""
                toClaim: ""
# ...
---
apiVersion: v1
kind: Secret
metadata:
  name: my-openid-client-secret
# ...
stringData:
  clientSecret: very-secr3t
```

Where:

- `.openID`: The issuer identifier. You can define as many OpenID providers as you like. If the provider supports OpenID Connect Discovery, the value of `openID` auto-configures the provider by using the information from <https://openid.example.com/.well-known/openid-configuration>.

- `.openID.issuerURI`: The issuer URI. The value of `issuerURI` must not contain `.well-known/openid-configuration` and must match the value of the `issuer` field. See the OpenID Connect documentation at <https://openid.example.com/.well-known/openid-configuration> for more information.



Note

You can retrieve the values of `issuerURI` and `clientID` when registering a client with the provider, which in most cases, is by using a web UI.

- `.openID.issuerURI` (optional): The issuer URI. This field is deprecated and it relies on `.openID.configurationURI`. The value of `issuerURI` must not contain `.well-known/openid-configuration` and must match the value of the `issuer` field. For more information, see the OpenID Connect documentation for your issuer, for example, at <https://openid.example.com/.well-known/openid-configuration>.



Note

You can retrieve the values of `issuerURI` (<https://openid.example.com>) and `clientID` (`my-client-abcdef`) when registering a client with the provider, which in most cases, is by using a web UI.

You can also run the following to retrieve the correct `issuerURI` value from the upstream identity provider:

```
curl -s "https://openid.example.com/.well-known/openid-configuration" | jq -r ".issuer"
```

- `.openID.scopes`: The scopes requested to the issuer in the authorization request. Its value must contain `"openid"`. Other common `openID.scopes` values include `"profile"` and `"email"`.
- `.openID.clientSecretRef`: The issuer's client secret. The value of `clientSecretRef` must be a `Secret` with the entry `clientSecret`.
- `.openID.authorizationUri` (optional): The URI for performing an authorization request and obtaining an `authorization_code`.
- `.openID.tokenUri` (optional): The URI for performing a token request and obtaining a token.
- `.openID.jwksUri` (optional): The JSON Web Key Set (JWKS) endpoint for obtaining the JSON Web Keys to verify token signatures.
- `.openID.userinfoUri` (optional): The URI for obtaining the additional identity claims from the upstream IdP (identity provider).
- `.openID.roles.fromUpstream.claim` (optional): Selects which claim in the `id_token` contains the `roles` of the user. `roles` is not a standard OpenID Connect claim. When `ClientRegistrations` has a `roles` scope, it populates the `roles` claim in the `id_token` issued by the `AuthServer`. For more information, see [OpenID external groups mapping](#).
 - `MY-OIDC-PROVIDER-GROUPS`: Claim from the ID token issued by `my-oidc-provider` is mapped into the `roles` claim in the id tokens issued by AppSSO.
- `.openID.idToken.claims`: Allows mapping a claim from an upstream identity provider to the current authorization server. See [Identity token claims mapping](#) for more details.

Verify the configuration by visiting the `AuthServer`'s issuer URI in your browser and select `my-oidc-provider`.

You can find the `authorizationUri`, `tokenUri`, `JWKSUri`, and `userinfoUri` properties in `<issuerUri>/.well-known/openid-configuration`.

OpenID external groups mapping

Service operators may map the identity provider's "groups" (or equivalent) claim to the `roles` claim within an `AuthServer`'s identity token.



Note

[Read more about roles claim mapping and filtering here](#)

App Operators may configure their `ClientRegistration` to have the `roles` claim included in the `id_token`.

Configure `AuthServer` with OpenID Connect groups mapping:

```
spec:
  identityProviders:
    - name: "openid-idp"
      openid:
        scopes:
          - upstream-identity-providers-groups-claim # Optional based on the identity
            provider.
        roles:
          fromUpstream:
            claim: "upstream-identity-providers-groups-claim"
```



Caution

Some OpenID providers, such as Okta OpenID, might require requesting the `roles` or `groups` scope from the identity provider, as a result, you must include it in the `.openid.scopes` list.

For every `ClientRegistration` that has the `roles` scope listed, the identity token is populated with the `roles` claim:

```
kind: ClientRegistration
metadata:
  name: my-client-registration
spec:
  scopes:
    - name: openid
    - name: roles
  # ...
```

When groups are mapped (as described above), all the groups provided by the identity provider are retrieved, and the relevant groups that the logged-in user is part of are appended to the `roles` claim of an `id_token`. To filter the available roles within an `id_token`, see [Roles claim filtering section](#).

Note for registering a client with the identity provider

The `AuthServer` will set up redirect URIs based on the provider name in the configuration. For example, for a provider with `name: my-provider`, the redirect URI will be `{spec.issuerURI}/login/oauth2/code/my-provider`. The externally accessible user URI for the `AuthServer`, including scheme and port is `spec.issuerURI`. If the `AuthServer` is accessible on `https://appsso.company.example.com:1234/`, the redirect URI registered with the identity provider should be `https://appsso.company.example.com:1234/login/oauth2/code/my-provider`.

Supported token signing algorithms

AppSSO only supports the `RS256` algorithm for token signature. For more information, see [OpenID Connect documentation](#).

You can find out the signing algorithms your OpenID provider supports by referring to the `id_token_signing_alg_values_supported` response parameter in the [OpenID Connect documentation](#) at `.well-known/openid-configuration`.

For example, you can run:

```
curl -s "ISSUER-URI/.well-known/openid-configuration" | jq ".id_token_signing_alg_values_supported"
```

LDAP



Important

You can not configure more than one `ldap` identity provider.

For example:

```
---
apiVersion: sso.apps.tanzu.vmware.com/v1alpha1
kind: AuthServer
metadata:
# ...
spec:
  identityProviders:
  - name: ldap
    ldap:
      url: "ldaps://example.com:636"
      bind:
        dn: uid=binduser,ou=Users,dc=example,dc=com
        passwordRef:
          name: ldap-password
      user:
        searchBase: ou=Users,dc=example,dc=com
        searchFilter: cn={0}
      roles:
        fromUpstream:
          attribute: cn
          search:
            filter: member={0}
            base: ou=Users,dc=example,dc=com
            searchSubTree: true
            depth: 10
        filterBy:
          - exactMatch: "users"
          - regex: "^admin"
      idToken:
        claims:
          - fromUpstream: ""
```

```

    toClaim: ""
    group: # DEPRECATED, use 'roles' instead
    search:
      filter: member={0}
      base: ou=Users,dc=example,dc=com
      searchSubTree: true
      depth: 10
      roleAttribute: cn
  # ...
---
apiVersion: v1
kind: Secret
metadata:
  name: ldap-password
  namespace: default
stringData:
  password: confidential-password-value

```

Where:

- `.ldap.url`: The URL of the LDAP server. It must be `ldaps` and must contain a port.
- `.ldap.bind.dn`: The DN to perform the bind.
- `.ldap.bind.passwordRef`: Must be a secret with the entry `password`, which is the password to perform the bind.
- `.ldap.user.searchBase`: The branch of tree where the users are located at. Search is performed in the nested entries.
- `.ldap.user.seachFilter`: The filter for LDAP search. It must contain the string `{0}`, which is replaced by the `dn` of the user when performing a search. For example, when logging in with the user name `marie`, the filter for LDAP search is `cn=marie`.
- `.ldap.roles` (optional): Configures how LDAP groups are mapped to user roles in the `id_token` claims. Defaults to unset, meaning the user has no roles.
- `.ldap.roles.fromUpstream.attribute`: Selects which attribute of the group entry are mapped to a user role. If an attribute has multiple values, the first value is selected.
- `.ldap.roles.fromUpstream.search` (optional): Toggles OpenLDAP-style group search, optionally uses recursive search to find groups for a user.
- `.ldap.roles.filterBy` (optional): Applies roles claim filters. See [Roles claim filtering section](#) for more details.
- `.ldap.idToken.claims`: Allows for mapping a claim from an upstream identity provider to the current authorization server. See [Identity token claims mapping](#) for more details.

LDAP providers have the following claims mapped by default:

LDAP attribute	Id token claim
givenname	given_name
sn	family_name
cn	name
mail	email
telephonenumber	phone_number

The following fields are deprecated:

- `.ldap.group` (optional): Configures how LDAP groups are mapped to user roles in the `id_token` claims. If not set, the user has no roles. Use `.ldap.roles` instead.

- `.ldap.group.roleAttribute`: Selects which attributes of the group entry are mapped to a user role. If an attribute has multiple values, the first value is selected.
- `.ldap.group.search` (optional): Toggles Active Directory search and uses recursive search to find groups for a given user.

Verify the configuration by visiting the `AuthServer`'s issuer URI in your browser and log in with the user name and password from LDAP.

LDAP external groups mapping

Service operators can map the identity provider's "groups" or equivalent attribute to the `roles` claim within an `AuthServer`'s identity token.



Note

Read more about [roles claim mapping and filtering here](#)

Configure `AuthServer` with LDAP groups attribute mapping:

```
spec:
  identityProviders:
    - name: "ldap-idp"
      ldap:
        roles:
          fromUpstream:
            attribute: "upstream-identity-providers-groups-attribute" # e.g. "cn" or
"dn"
```

For every `ClientRegistration` that has the `roles` scope listed, the identity token will be populated with the `roles` claim:

```
kind: ClientRegistration
metadata:
  name: my-client-registration
spec:
  scopes:
    - name: openid
    - name: roles
# ...
```

When groups are mapped (as described above), all the groups provided by the identity provider are retrieved, and the relevant groups that the logged-in user is part of are appended to the `roles` claim of an `id_token`. To filter the available roles within an `id_token`, see [Roles claim filtering section](#).

ActiveDirectory group search

In ActiveDirectory groups, user entries have a multi-value `memberOf` attribute, which contains the DNs pointing to the groups of a particular user. To enable this search mode, make sure `roles.fromUpstream.attribute` is set and `roles.fromUpstream.search` is not set.

For example:

```
apiVersion: sso.apps.tanzu.vmware.com/v1alpha1
kind: AuthServer
metadata:
# ...
spec:
  identityProviders:
```

```

- name: ldap
  ldap:
    # ...
    user:
      searchBase: OU=Cloud,DC=ad,DC=example,DC=com
      searchFilter: cn={0}
    roles:
      fromUpstream:
        attribute: sAMAccountName

```

The LDIF definition is as follows:

```

dn: CN=appsso-user,OU=Cloud,DC=ad,DC=example,DC=com
objectClass: top
objectClass: person
objectClass: organizationalPerson
objectClass: user
cn: appsso user
sn: user
givenName: appsso
distinguishedName: CN=appsso user,OU=Cloud,DC=ad,DC=example,DC=com
displayName: appsso user
memberOf: CN=ssogroup,OU=Cloud,DC=ad,DC=example,DC=com
memberOf: CN=developers,OU=Cloud,DC=ad,DC=example,DC=com
sAMAccountName: appssouser
userPrincipalName: appssouser@ad.example.com
objectCategory: CN=Person,CN=Schema,CN=Configuration,DC=ad,DC=example,DC=com
# ...

# Groups
dn: CN=ssogroup,OU=Cloud,DC=ad,DC=example,DC=com
objectClass: top
objectClass: group
cn: ssogroup
member: CN=appsso-user,OU=Cloud,DC=ad,DC=example,DC=com
sAMAccountName: SSO Group
# ...

dn: CN=developers,OU=Cloud,DC=ad,DC=example,DC=com
objectClass: top
objectClass: group
cn: developers
sAMAccountName: Developers
# ...

```

The user `appsso-user` has two values for `memberOf`, pointing to two groups. Given the configuration earlier, `sAMAccountName` is used for the role, so the user has `SSO Group` and `Developers` as roles. The group is not required to have `member` attribute point to the user for the role to be mapped.

“Classic” group search

In non-ActiveDirectory LDAP, users generally do not have a `memberOf` attribute. Group search is performed by looking up groups in a base branch and filtering based on the groups `member` attribute.

An AuthServer can optionally perform:

- group search in sub-branches.
- nested group search, that is, find a hierarchy of groups, in which a group is a member of another group.

The complete configuration is as follows:

```

---
apiVersion: sso.apps.tanzu.vmware.com/v1alpha1
kind: AuthServer
metadata:
# ...
spec:
  identityProviders:
  - name: ldap
    ldap:
      # ...
      roles:
        fromUpstream:
          attribute: description
          search:
            base: ou=Users,dc=example,dc=com
            filter: member={0}
            depth: 10
            searchSubTree: true
# ...

```

Where:

- `search.base` is the base for running an LDAP search for groups.
- `search.filter` is the filter for running an LDAP search for groups. It must contain the string `{0}`, which is replaced by the `dn` of the user when performing group search. For example, `member=cn=marie,ou=Users,dc=example,dc=org`.
- `search.depth` (optional) is the depth at which to perform nested group search. It defaults to unset if left empty.
- `search.searchSubTree` (optional) controls whether to look for groups in sub-trees of the `search.base`. It defaults to unset if left empty.

Direct group search only

Given the following minimal configuration:

```

---
apiVersion: sso.apps.tanzu.vmware.com/v1alpha1
kind: AuthServer
metadata:
# ...
spec:
  identityProviders:
  - name: ldap
    ldap:
      # ...
      user:
        searchBase: ou=Users,dc=example,dc=com
        searchFilter: uid={0}
      roles:
        fromUpstream:
          attribute: description
          search:
            base: ou=Users,dc=example,dc=com
            filter: member={0}
# ...

```

The LDIF definition is as follows:

```

#####
## Users
#####

```

```
## User Marie Curie
## Marie Salomea Skłodowska Curie ; https://en.wikipedia.org/wiki/Marie_Curie
dn: cn=marie,ou=Users,dc=example,dc=org
cn: Marie
sn: Skłodowska Curie
objectClass: inetOrgPerson
objectClass: posixAccount
objectClass: shadowAccount
uid: marie

#####
## Groups
#####
dn: cn=nobels,ou=Users,dc=example,dc=org
objectClass: groupOfNames
description: Nobel Prizes
member: cn=marie,ou=Users,dc=example,dc=org
```

User `marie` has roles `Nobel Prizes`.

Groups in sub-trees

AppSSO can perform group search in sub-trees of the base for group search. This is enabled when `roles.fromUpstream.search.searchSubTree` is explicitly set to `true`. For example:

```
---
apiVersion: sso.apps.tanzu.vmware.com/v1alpha1
kind: AuthServer
metadata:
# ...
spec:
  identityProviders:
  - name: ldap
    ldap:
      # ...
      roles:
        fromUpstream:
          attribute: description
          search:
            base: ou=Users,dc=example,dc=com
            filter: member={0}
            searchSubTree: true
# ...
```

The LDIF definition is as follows:

```
#####
## Users
#####
## User Corazon
## Maria Corazon Sumulong Cojuangco Aquino; https://en.wikipedia.org/wiki/Corazon_Aqui
no
dn: cn=corazon,ou=Users,dc=example,dc=com
cn: Maria Corazon
sn: Sumulong Cojuangco Aquino
objectClass: inetOrgPerson
objectClass: posixAccount
objectClass: shadowAccount
uid: corazon

#####
## Groups
#####
```

```
dn: cn=presidents,ou=Users,dc=example,dc=com
objectClass: groupOfNames
description: Presidents
member: cn=corazon,ou=Users,dc=example,dc=com

dn: cn=chief-commanders,ou=LegionHonor,ou=Users,dc=example,dc=com
objectClass: groupOfNames
description: Chief Commanders
member: cn=corazon,ou=Users,dc=example,dc=com
```

User `corazon` has roles `Presidents` and `Chief Commanders`, which are retrieved from `ou=LegionHonor,ou=Users,dc=example,dc=com`, a subtree of the search base.

Nested group search

AppSSO can perform nested group search by going up a chain where a user is a member of a group, which is itself a member of a group, and so on. This is enabled by setting `roles.fromUpstream.search.depth` to greater than 1. `roles.fromUpstream.search.depth` controls the number of “levels” that AppSSO fetches to get the groups of a user.

For example:

```
---
apiVersion: sso.apps.tanzu.vmware.com/v1alpha1
kind: AuthServer
metadata:
  # ...
spec:
  identityProviders:
    - name: ldap
      ldap:
        # ...
        user:
          searchBase: ou=Users,dc=example,dc=com
          searchFilter: uid={0}
        roles:
          fromUpstream:
            attribute: description
            search:
              base: ou=Users,dc=example,dc=com
              filter: member={0}
              depth: 2
        # ...
```

The LDIF definition is as follows:

```
#####
## Users
#####
## User Corazon
## Maria Corazon Sumulong Cojuangco Aquino; https://en.wikipedia.org/wiki/Corazon_Aqui
no
dn: cn=corazon,ou=Users,dc=example,dc=com
cn: Maria Corazon
sn: Sumulong Cojuangco Aquino
objectClass: inetOrgPerson
objectClass: posixAccount
objectClass: shadowAccount
uid: corazon

#####
## Groups
#####
```

```
# Citizen > Politicians > Presidents > corazon (depth = 3)
dn: cn=citizens,ou=Users,dc=example,dc=com
objectClass: groupOfNames
description: Citizens
member: cn=politicians,ou=Users,dc=example,dc=com

# Politicians > Presidents > corazon (depth = 2)
dn: cn=politicians,ou=Users,dc=example,dc=com
objectClass: groupOfNames
description: Politicians
member: cn=presidents,ou=Users,dc=example,dc=com

# Presidents > corazon (depth = 1, direct group)
dn: cn=presidents,ou=Users,dc=example,dc=com
objectClass: groupOfNames
description: Presidents
member: cn=corazon,ou=Users,dc=example,dc=com
```

User `corazon` has roles `Presidents` and `Politicians`. However, the search stops at depth 2, so they do not have the role `Citizens`, which requires a depth greater or equal to 3.

SAML (experimental)



Caution

Support for SAML providers is experimental.

For SAML providers only autoconfiguration through `metadataURI` is supported.

```
---
apiVersion: sso.apps.tanzu.vmware.com/v1alpha1
kind: AuthServer
metadata:
# ...
spec:
  identityProviders:
  - name: my-saml-provider
    saml:
      metadataURI: https://saml.example.com/sso/saml/metadata # required
      idToken: # optional
      claims:
        - fromUpstream: "" # SAML attribute
          toClaim: "" # claim that is part of an AppSSO id_token
```

`.saml.idToken.claims` field allows for mapping a SAML attribute from an upstream SAML identity provider to the current authorization server. See [Identity token claims mapping](#) for more details.

SAML external groups mapping

Service operators may map the identity provider's "groups" (or equivalent) attribute to the `roles` claim within an `AuthServer`'s identity token.



Note

[Read more about roles claim mapping and filtering here](#)

Configure `AuthServer` with SAML role attribute:

```
spec:
  identityProviders:
    - name: "saml-idp"
      saml:
        roles:
          fromUpstream:
            attribute: "saml-group-attribute"
```

For every [ClientRegistration](#) that has the `roles` scope listed, the identity token will be populated with the `roles` claim:

```
kind: ClientRegistration
metadata:
  name: my-client-registration
spec:
  scopes:
    - name: openid
    - name: roles
  # ...
```

When groups are mapped (as described above), all the groups provided by the identity provider are retrieved, and the relevant groups that the logged-in user is part of are appended to the `roles` claim of an `id_token`. To filter the available roles within an `id_token`, see [Roles claim filtering section](#).

Note for registering a client with the identity provider

The `AuthServer` will set up SSO and metadata URLs based on the provider name in the configuration. For example, for a SAML provider with `name: my-provider`, the SSO URL will be `{spec.issuerURI}/login/saml2/sso/my-provider`. The metadata URL will be `{spec.issuerURI}/saml2/service-provider-metadata/my-provider`. `spec.issuerURI` is the externally accessible issuer URI for an `AuthServer`, including scheme and port. If the `AuthServer` is accessible on `https://appsso.company.example.com:1234/`, the SSO URL registered with the identity provider should be `https://appsso.company.example.com:1234/login/saml2/sso/my-provider`.

InternalUnsafe



Caution

The internal provider is **unsafe** and **must not** be used in production environments.

`InternalUnsafe` must be explicitly allowed by setting the annotation `sso.apps.tanzu.vmware.com/allow-unsafe-identity-provider: ""`.

During development, static users can be useful for testing purposes.

You cannot configure more than one `internalUnsafe` identity provider.

For example:

```
apiVersion: sso.apps.tanzu.vmware.com/v1alpha1
kind: AuthServer
metadata:
  annotations:
    sso.apps.tanzu.vmware.com/allow-unsafe-identity-provider: "" # required annotation
    when using the internal unsafe provider
  # ...
spec:
```

```

identityProviders:
  - name: test-users
    internalUnsafe:
      users:
        - username: ernie
          password: "password" # plain text
          roles:
            - "silly"
          claims: # custom identity token claims
            given_name: "Bert"
            family_name: "Muppet"
            middle_initial: "H"
            email: "bert@muppets.example.com"
            alt_address: "123 Sesame Street"
        - username: bert
          password: "{bcrypt}$2a$10$201z9o/tHlocFsHFTto0plukh03ApBYe4dRiXcqeyRQH6CnntS8jWK" # bcrypt-hashed "password"
          roles:
            - "grumpy"
          claims: # custom identity token claims
            alt_address: "456 Fake Street"
            middle_initial: "T"
# ...

```

The passwords can be plain text or bcrypt-hashed. Bcrypt-hashing passwords must be prefixed with `{bcrypt}`. For more information about the bcrypt-hash string, see [Generating a bcrypt hash from a plain-text password](#).

Verify the configuration by visiting the `AuthServer`'s issuer URI in your browser and logging in as `ernie/password` or `bert/password`.

To use custom claims defined within `.internalUnsafe.users[*].claims`, you must include the `profile` scope within your `ClientRegistration` resource.

Generating a bcrypt hash from a plain-text password

There are multiple options for generating bcrypt hashes:

1. Use an [online bcrypt generator](#)
2. On Unix platforms, use `htpasswd`. Note, you may need to install it, for example on Ubuntu by running `apt install apache2-utils`

```
htpasswd -bnBC 12 "" your-password-here | tr -d ':\n'
```

Identity token claims mapping



Note

This section is applicable to OpenID, LDAP, and SAML (experimental) identity provider configurations.

Service Operators can control which claims appear in an `AuthServer`-issued `id_token`, and how to obtain this value from an upstream identity provider.

For example, consider the following configuration:

```

spec:
  identityProviders:
    - name: my-identity-provider
      openid:

```



```
idToken:
  claims:
    - fromUpstream: "title"
      toClaim: "job_title"
```

With this, if the upstream OpenID identity provider makes a "title" claim available with the value "developer", the corresponding AuthServer-issued `id_token` contains a claim "job_title": "developer".

This field also allows for mapping the [standard OpenID claims](#), such as `given_name`, `family_name`, and non-standard claim, such as the `job_title` claim in the earlier example. When mapping the standard claims, the field types are preserved according to the original OpenID specification. For example, the `given_name` claim is defined as a string in the OpenID specification, so if a custom claim is mapped into this field, the value of the custom claim is coerced into a string type. If the custom claim is an array type, the first value of the array is used.



Important

For the custom claims defined `.spec.identityProviders[*].{openid,ldap,saml}.idToken.claims` to be available in AuthServer-issued `id_tokens`, App Operators must include the `profile` scope within their `ClientRegistration` resource.

```
---
apiVersion: sso.apps.tanzu.vmware.com/v1alpha1
kind: AuthServer
metadata:
# ...
spec:
  identityProviders:
  - name: my-identity-provider
    {openid,ldap,saml}:
      idToken: # optional
        claims:
          - fromUpstream: "" # identity provider claim name
            toClaim: ""      # claim that is part of an AppSSO id_token
```

Constraints

You must adhere to the following identity token mapping constraints:

- Multiple upstream identity provider claims cannot be mapped to a single `AuthServer` identity token claim.
- The value of `claims.fromUpstream` is case-insensitive for LDAP identity providers, and is case-sensitive for OpenID and SAML identity providers.
- `idToken.claims.toClaim` is case-sensitive.
- Reserved claims can not be mapped to. Reserved claims are listed as follows:

Reserved Claim Names

`roles`

`acr`

`amr`

`at_hash`

Reserved Claim Names
<code>auth_time</code>
<code>azp</code>
<code>c_hash</code>
<code>nonce</code>
<code>aud</code>
<code>exp</code>
<code>iat</code>
<code>iss</code>
<code>jti</code>
<code>nbf</code>
<code>sub</code>

Roles claim filtering



Note

This section is applicable to OpenID, LDAP, and SAML (experimental) identity provider configurations.

Once an external groups mapping has been applied (as described per identity provider above), AppSSO is able to retrieve all the groups from an identity provider. An identity provider may have hundreds of groups, and any particular user may be part of a large subset of those groups. When a user logs in, those groups will be appended to their `id_token`'s `roles` claim. This section describes how to filter the `roles` claim.

To filter groups, for a supported identity provider, apply:

```
spec:
  identityProviders:
    - name: my-provider
      <idp>:
        roles:
          filterBy:
            - exactMatch: ""
            - regex: ""
```

where `<idp>` may be `openid`, `ldap`, or `saml`.

Filters are disjunctive (“OR” operator), so each filter is applied to the entire set of groups, and merged into a set of unique filtered groups values. See [filter examples](#) for more information.

Roles claim filters

Available filters are:

- `exactMatch` - match the groups exactly. This filter is **case-sensitive**. e.g. `exactMatch: "developer"` will match only the group named “developer” and no other.
- `regex` - match groups according to the defined regular expression pattern. , and This filter is **case-insensitive**. e.g. `regex: ^admin` will match groups starting with the word “admin”.

- The regular expression pattern syntax used is [RE2](#)
- Expressions should not be surrounded by forward slashes (/) and should only contain the pattern (e.g. `.*`, `^dev`, `\w+`).

Roles claim filter examples

Given an example set of groups retrieved from a hypothetical identity provider:

```
it-admin
it-developer
devops-user
devops-admin
devops-developer
product-user
product-developer
org-user
hr-user
hr-admin
```

Basic exact match filters

```
- exactMatch: "product-user"
- exactMatch: "org-user"
```

returns:

```
product-user
org-user
```

Basic regular expression (RegEx) filters

```
- regex: ".*-developer"
```

returns:

```
it-developer
devops-developer
product-developer
```

Multiple regular expression (RegEx) filters

```
- regex: ".*-developer"
- regex: "^it"      # starts with "it"
- regex: "admin$"  # ends with "admin"
- regex: "\w+"     # at least one word or more
```

returns:

```
it-admin
it-developer
devops-admin
devops-developer
product-developer
hr-admin
```



Note

filters are disjunctive and so multiple filters can filter down the same values, but the resulting set will always have unique values.

Exact match and regular expression (RegEx) filters

```
- exact-match: "hr-admin"
- exact-match: "org-user"
- regex: "developer$" # ends with "developer"
```

returns:

```
it-developer
devops-developer
product-developer
org-user
hr-admin
```

Roles claim mapping and filtering explained

When issuing an `id_token`, OpenID providers may include a (non-standard) claim describing the “groups” the user belongs to, the “roles” of the user, or something similar. This claim is identity provider specific. For example, Azure AD uses the “group” claim by default, and allows administrators to select the name of the claim.

Service Operators may choose to make these “groups”, “roles”, or equivalent, available in the `id_token` issued by an AppSSO `AuthServer`, in the `roles` claim, with `filtering rules` applied.

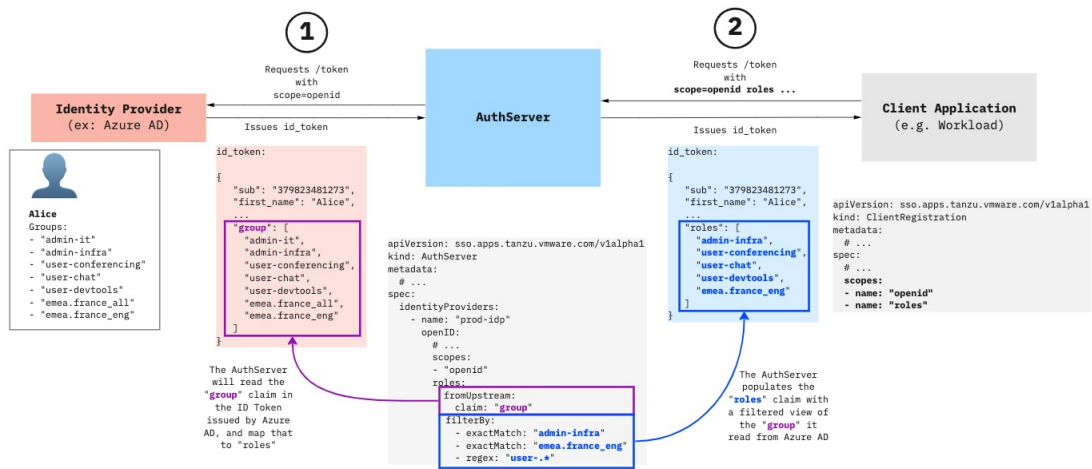

Restrictions

Each identity provider has a declared `name`. The following conditions apply:

- the names must be unique
- the names must not be blank
- the names must follow [Kubernetes' DNS Subdomain Names guidelines](#)
 - contain no more than 253 characters
 - contain only lowercase alphanumeric characters, '-' or '.'
 - start with an alphanumeric character

- end with an alphanumeric character
- the names may not start with `client` or `unknown`

There can be at most one of each `internalUnsafe` and `ldap`.

Configure authorization for AppSSO

This topic tells you how to configure authorization for Application Single Sign-On (commonly called AppSSO).



Note

This topic is applicable to Internal, OpenID, LDAP, and SAML (experimental) identity provider `AuthServer` configurations. For more information, see [AuthServer](#).

Overview

An application or `Workload` can protect certain resources based on user's level of authorization. Within OAuth 2, the application with protected resources, the Resource Server, verifies if the access token provided contains the scopes to perform an action on a protected resource.

The following excerpt is from a Spring Boot application, OAuth2 Resource Server, protecting its message API endpoints `/message/**`:

```
http.authorizeExchange(exchanges -> exchanges
    .pathMatchers("/message/**").hasAuthority("SCOPE_message.read")
    .anyExchange().authenticated()
)
```

The access token to access any endpoint under `/message/` path must have `message.read` scope within its access token.

For full example, see [Spring Security documentation](#).

The following sections describe how to configure the mapping of user roles to authorization scopes at `AuthServer` identity provider and `ClientRegistration` levels.

Retrieving external groups or roles



Important

Skip this section if you work with an internal unsafe provider. External groups mapping is not required because roles are defined in the specifications.

To configure authorization for an identity provider, you must define from which claim or attribute the upstream identity provider supplies the groups or roles that a user is part of:

- [OpenID external groups mapping](#)
- [LDAP external groups mapping](#)
- [SAML \(experimental\) external groups mapping](#)

After external groups mapping is complete, and groups or roles are retrievable, you can optionally filter the roles that are appended to an identity token. For more information about how to filter roles, see [Roles claim filtering](#).

Mapping individual roles into authorization scopes

After external groups or roles are mapped to AppSSO's `roles` claim, and optionally filtered for the desired set of retrieved roles, you can map each role to the desired authorization scopes.

For example, given a retrieved role "hr", any client authorizing by using `my-openid-provider` can request scopes `hr.read` or `hr.write`, provided that the client registered the scopes in `ClientRegistration.spec.scopes`:

```
kind: AuthServer
# ...
spec:
  identityProviders:
    - name: my-openid-provider
      openid:
        accessToken:
          scope:
            rolesToScopes:
              - fromRole: "hr" # -> Role "hr" is mapped to the "hr.read" and "hr.write" scopes.
                toScopes:      # Only users with the "hr" role can be issued access token with these scopes.
                  - "hr.read" # ^^
                  - "hr.write" # ^^
```

For example, given that a `ClientRegistration` is applied to include `hr.read` or `hr.write`:

```
kind: ClientRegistration
# ...
spec:
  scopes:
    - name: "roles" # Must request special 'roles' scope.
    - name: "hr.read"
    - name: "hr.write"
```

Any client can request an access token with the scopes, but an access token can be issued with those scopes only if the user that is being authorized has the role `hr` in the upstream identity provider.

If the user has the role `hr`, he or she must consent to allow the application to request the scopes. After the consent is provided, the user can access resources limited to the `hr.read` and `hr.write` scopes within the application by using their access token.

Default authorization scopes

You can define authorization scopes that are automatically granted to all users within an identity provider, regardless of user role.

For example, given an `AuthServer` with an OpenID provider, with defined authorization scope defaults:

```
kind: AuthServer
# ...
spec:
  identityProviders:
    - name: my-openid-provider
      openid:
        accessToken:
          scope:
            defaults:
              - "developer.read"
```

```

- "developer.write"
- "developer.delete"

```

For example, given that a `ClientRegistration` is applied to include any of the default scopes:

```

kind: ClientRegistration
# ...
spec:
  scopes:
    - name: "roles" # Must request special 'roles' scope.
    - name: "developer.read"

```

When an application or `Workload` is registered by using the `ClientRegistration`, that application, on behalf of the user, can request and be granted with the scope `developer.read` automatically within the issued access token. The user must consent to allow the application to request the scope. After the consent is provided, the user can access resources limited to the `developer.read` scope within the application by using their access token.

The following is a full sample of authorization configurations and the accompanying `ClientRegistration` configurations to allow clients to request the scopes:

```

kind: AuthServer
# ...
spec:
  identityProviders:
    - name: my-openid-provider
      openid:
        roles:
          fromUpstream:
            claim: "groups" # -> Map the upstream identity provider's external groups or roles claim.
            filterBy: # -> Optionally filter the groups or roles retrieved from identity provider.
              - exactMatch: "finance" # ^^
              - exactMatch: "hr" # ^^
              - exactMatch: "marketing" # ^^
          accessToken:
            scope:
              defaults: # -> Optional default scopes granted to any user within the identity provider.
                - "developer.read" # ^^
                - "developer.write" # ^^
                - "developer.delete" # ^^
              rolesToScopes:
                - fromRole: "hr" # -> Role "hr" is mapped to "hr.read", "hr.write" scopes.
                  toScopes: # Only users with "hr" role can be issued access token with these scopes.
                    - "hr.read" # ^^
                    - "hr.write" # ^^
                - fromRole: "finance" # -> Role "finance" is mapped to "finance" scope.
                  toScopes: # Only users with "finance" role can be issued an access token with this scope.
                    - "finance" # ^^
                - fromRole: "marketing" # -> Role "marketing" is mapped to "marketing-reader", "marketing-writer" scopes.
                  toScopes: # Only users with "marketing" role can be issued an access token with these scopes.
                    - "marketing-reader" # ^^
                    - "marketing-writer" # ^^

```

```

kind: ClientRegistration
# ...
spec:
  scopes:
    - name: "roles" # Must request special 'roles' scope.
    - name: "developer.read"
    - name: "developer.write"
    - name: "developer.delete"
    - name: "hr.read"
    - name: "hr.write"
    - name: "finance"
    - name: "marketing-reader"
    - name: "marketing-writer"

```

Public clients and CORS for AppSSO

This topic tells you how to configure Application Single Sign-On (commonly called AppSSO) to use public clients.

Overview

A public client is a client application that does not require credentials to obtain tokens, such as single-page apps (SPAs) or mobile devices. Public clients rely on Proof Key for Code Exchange (PKCE) Authorization Code flow extension.

Follow these steps to configure an `AuthServer` and `ClientRegistrations` for use with public clients:

1. Specify allowed HTTP origin (one or more) by using the `AuthServer.spec.cors` API.

The authorization server relaxes the same-origin policy for the specified domain (one or more), enabling browser-based, single-page applications to interact with the designated authorization server. For more information, see [CORS configuration](#).

2. Set `clientAuthenticationMethod` to `none` within `ClientRegistration` resource.

Native applications and browser-based applications are considered public clients and must not rely on client credentials. Instead, PKCE must be used. Setting `clientAuthenticationMethod: none` ensures client credentials are not used, and makes PKCE mandatory for those clients. For more information, see [Client authentication](#).

CORS configuration

A browser-based public client can interact with an `AuthServer` if the `AuthServer` has the public clients' origin (one or more) specified in `AuthServer.spec.cors`.

VMware recommends designating specific origins as follows:

```

kind: AuthServer
# ...
spec:
  cors:
    allowOrigins:
      - "https://example.com" # Specific domain.
      - "https://mydept.example.com" # Specific subdomain.
      - "https://*.example.com" # Subdomain wildcard notation.
      - "https://*.apps.example.com" # Subdomain wildcard notation.

```

You can also designate that all origins are allowed as follows:

```
kind: AuthServer
metadata:
  annotations:
    sso.apps.tanzu.vmware.com/allow-unsafe-cors: ""
spec:
  cors:
    allowAllOrigins: true
```



Caution

Do not allow all origins in production environments.

You must use the `allow-unsafe-cors` annotation when allowing all origin allowance. The `AuthServer` sends the `Access-Control-Allow-Origin: *` HTTP response header.

Requirements for allowed origin designations include:

- Only `allowOrigins` or `allowAllOrigins` is allowed to be set.
- When using `allowAllOrigins`, you must explicitly set the annotation `sso.apps.tanzu.vmware.com/allow-unsafe-cors: ""`. This is an acknowledgement that using `allowAllOrigins` is inherently unsafe.

Client authentication

When configuring a `ClientRegistration` for a public client, you must set your client authentication method to `none` and ensure that your public client supports Authorization Code with PKCE. With PKCE, the client does not authenticate, but presents a code challenge and subsequent code verifier to establish trust with the authorization server.

To set Client Authentication Method to `none`, ensure your `ClientRegistration` resource defines the following:

```
kind: ClientRegistration
# ...
spec:
  clientAuthenticationMethod: none
```

Public clients supporting Authorization Code with PKCE flow ensure that:

- On every OAuth `authorize` request, parameters `code_challenge` and `code_challenge_method` are provided. Only `code_challenge_method=S256` is supported.
- On every OAuth `token` request, parameter `code_verifier` is provided. Public clients do not provide a Client Secret because they are not tailored to retain any secrets in public view.

For public clients, the `AuthServer` only supports the Authorization Code Flow: `response_type=code`, because public clients such as single page apps cannot safely store sensitive information such as client secrets.

References

- [Proof Key for Code Exchange \(PKCE\) specification](#).
- [PKCE code challenge/verifier example](#).
- [Client types - OAuth 2.1 Draft 7 specification](#).

Token settings for Application Single Sign-On

This topic tells you how to configure token expiry settings for Application Single Sign-On (commonly called AppSSO).

Token expiry

AppSSO allows you to optionally configure the token expiry settings in your `AuthServer` resource.

The default token expiry settings are as follows:

Token type	Lifetime
Access token	12 hours
Identity token	12 hours
Refresh token	720 hours or 30 days

VMware recommends setting a shorter lifetime for access tokens, typically measured in hours, and a longer lifetime for refresh tokens, typically measured in days. Refresh tokens acquire new access tokens, so they have a longer lifespan.

To override the token expiry settings, configure the following in your `AuthServer` resource:

```
kind: AuthServer
# ...
spec:
  token:
    accessToken:
      expiry: "12h"
    idToken:
      expiry: "12h"
    refreshToken:
      expiry: "720h"
```

`expiry` field examples:

Type	Example	Definition
Seconds	10s	10 seconds
Minutes	10m	10 minutes
Hours	10h	10 hours



Note

The `expiry` field adheres to the duration constraints of the Go standard time library and does not support durations in units beyond hours, such as days or weeks. For more information, see the [Go documentation](#).

Constraints

The token expiry constraints are as follows:

- The duration of the `expiry` field cannot be negative or zero.
- The refresh token's expiration time cannot be the same as or shorter than that of the access token.

Verify token settings

After you set up an Application Single Sign-On [AuthServer](#), you can verify that the token received by applications looks as expected. For this purpose, you can create a simple application consuming your [AuthServer](#). The following YAML file creates such an application. When you access its URL, it enables you to log in by using your [AuthServer](#) and displays the token it receives.



Caution

- The simple application is not intended for production use. It only serves a tool to help you verify your setup.
- The following YAML file pulls an unvetted public image [bitnami/oauth2-proxy:7.3.0](#)
- This section does not apply to an air-gapped environment.

If you stored the following YAML in a file named `token-viewer.yaml`, you can apply it to your cluster by running the following command:

```
ytt -f token-viewer.yaml --data-value ingress_domain=YOUR-INGRESS-DOMAIN --data-value-namespace=YOUR-NAMESPACE --data-value-authserver_selector=YOUR-AUTHSERVER-SELECTOR | kubectl apply -f-
```

Where `YOUR-AUTHSERVER-SELECTOR` is the label name and its value. For example: `{"name": "ci"}`.

A full example is as follows:

```
#!
#! Token viewer
#!
#! usage:
#!
#! ytt -f token-viewer.yaml --data-value ingress_domain=example.com --data-value-namespace=YOUR-NAMESPACE --data-value-authserver_selector={"name": "ci"}
#!
#! Then navigate to http://token-viewer.<INGRESS_DOMAIN>
#!

#@ load("@ytt:data", "data")
#@ fqdn = "token-viewer." + data.values.ingress_domain
#@ redirect_uri = "http://" + fqdn + "/oauth2/callback"
#@ namespace = data.values.namespace if "namespace" in data.values else "default"

---
apiVersion: sso.apps.tanzu.vmware.com/v1alpha1
kind: ClientRegistration
metadata:
  name: my-client-registration
  namespace: #@ namespace
spec:
  authServerSelector:
    matchLabels: #@ data.values.authserver_selector
  redirectURIs:
    - #@ redirect_uri
  requireUserConsent: false
  clientAuthenticationMethod: client_secret_basic
  authorizationGrantTypes:
    - "authorization_code"
  scopes:
    - name: "openid"
    - name: "email"
    - name: "profile"
    - name: "roles"
```

```

---
apiVersion: apps/v1
kind: Deployment
metadata:
  name: token-viewer
  namespace: #@ namespace
spec:
  replicas: 1
  selector:
    matchLabels:
      name: token-viewer
  template:
    metadata:
      labels:
        name: token-viewer
    spec:
      securityContext:
        runAsNonRoot: true
        seccompProfile:
          type: RuntimeDefault
      containers:
        - image: bitnami/oauth2-proxy:7.3.0
          name: proxy
          securityContext:
            runAsNonRoot: true
            seccompProfile:
              type: RuntimeDefault
            allowPrivilegeEscalation: false
          capabilities:
            drop:
              - ALL
          ports:
            - containerPort: 4180
              name: proxy-port
              protocol: TCP
          env:
            - name: ISSUER_URI
              valueFrom:
                secretKeyRef:
                  name: my-client-registration
                  key: issuer-uri
            - name: CLIENT_ID
              valueFrom:
                secretKeyRef:
                  name: my-client-registration
                  key: client-id
            - name: CLIENT_SECRET
              valueFrom:
                secretKeyRef:
                  name: my-client-registration
                  key: client-secret
          command: [ "oauth2-proxy" ]
          args:
            - --oidc-issuer-url=$(ISSUER_URI)
            - --client-id=$(CLIENT_ID)
            - --insecure-oidc-skip-issuer-verification=true
            - --client-secret=$(CLIENT_SECRET)
            - --cookie-secret=0000000000000000
            - --cookie-secure=false
            - --http-address=http://:4180
            - --provider=oidc
            - --scope=openid email profile roles
            - --email-domain=*
            - --insecure-oidc-allow-unverified-email=true
            - --oidc-groups-claim=roles
            - --upstream=http://127.0.0.1:8000

```

```

- #@ "--redirect-url=" + redirect_uri
- --ssl-upstream-insecure-skip-verify=true
- --ssl-insecure-skip-verify=true
- --skip-provider-button=true
- --pass-authorization-header=true
- --prefer-email-to-user=true
- image: python:3.9
  name: application
  securityContext:
    runAsNonRoot: true
    runAsUser: 1001
    seccompProfile:
      type: RuntimeDefault
    allowPrivilegeEscalation: false
    capabilities:
      drop:
        - ALL
  resources:
    limits:
      cpu: 100m
      memory: 100Mi
  command: [ "python" ]
  args:
    - -c
    - |
      from http.server import HTTPServer, BaseHTTPRequestHandler
      import base64
      import json

      class Handler(BaseHTTPRequestHandler):
          def do_GET(self):
              if self.path == "/token":
                  self.token()
              elif self.path == "/jwt":
                  self.jwt()
              else:
                  self.greet()

          def greet(self):
              username = self.headers.get("x-forwarded-user")
              self.send_response(200)
              self.send_header("Content-type", "text/html")
              self.end_headers()
              page = f"""
              <h1>It Works!</h1>
              <p>You are logged in as <b>{username}</b></p>
              <p><a href="/jwt">Show me my id_token (JWT format)</a></p>
              <p><a href="/token">Show me my id_token (JSON format)</a></p>
              """
              self.wfile.write(page.encode("utf-8"))

          def token(self):
              token = self.headers.get("Authorization").split("Bearer ")[-1]
              payload = token.split(".")[1].replace("-", "+").replace("_", "/")
              decoded = base64.b64decode(bytes(payload, "utf-8") + b'=').deco
de("utf-8")

              self.send_response(200)
              self.send_header("Content-type", "application/json")
              self.end_headers()
              self.wfile.write(decoded.encode("utf-8"))

          def jwt(self):
              token = self.headers.get("Authorization").split("Bearer ")[-1]
              self.send_response(200)
              self.send_header("Content-type", "text/plain")
              self.end_headers()

```

```

        self.wfile.write(token.encode("utf-8"))

    server_address = ('', 8000)
    httpd = HTTPServer(server_address, Handler)
    httpd.serve_forever()

---
apiVersion: v1
kind: Service
metadata:
  name: token-viewer
  namespace: #@ namespace
spec:
  ports:
    - port: 80
      targetPort: proxy-port
      name: proxy-svc-port
  selector:
    name: token-viewer

---
apiVersion: networking.k8s.io/v1
kind: Ingress
metadata:
  name: token-viewer
  namespace: #@ namespace
spec:
  rules:
    - host: #@ fqdn
      http:
        paths:
          - path: "/"
            pathType: Prefix
            backend:
              service:
                name: token-viewer
                port:
                  name: proxy-svc-port

```

Manage token signature keys for Application Single Sign-On

This topic tells you how to manage token signature keys for Application Single Sign-On (commonly called AppSSO).

Overview

An `AuthServer` must have token signature keys configured to be able to mint tokens.

For more information about token signatures, see [About token signatures](#).

To learn how to manage keys of an `AuthServer`:

- [Creating keys](#)
- [Rotating keys](#)
- [Revoking keys](#)



Important

“Token signature key” or just “key” is AppSSO’s wording for a public/private key pair that is tasked with signing and verifying JSON Web Tokens (JWTs). For more

information, please refer to the following resources:

- [JSON Web Signature \(JWS\) spec](#)
- [JSON Web Algorithms \(JWA\) spec](#)
- [JSON Web Token \(JWT\) spec](#)

Creating keys

You can deploy an `AuthServer` without `spec.tokenSignature` but it won't be able to mint tokens. Therefore, keys must be configured to make it fully operational. The following describe how to create and apply a keys for an `AuthServer`.

An RSA key can be created multiple ways. Below are two recommended approaches – choose one.

Using secretgen-controller



Important

This section assumes you have Tanzu Application Platform running on your cluster with `secretgen-controller` installed.

An `RSAKey CR` allows for expedited creation of a Secret resource containing PEM-encoded public and private keys required by an `AuthServer`.

1. Create an `AuthServer` with `RSAsKeys` as follows:

```
apiVersion: sso.apps.tanzu.vmware.com/v1alpha1
kind: AuthServer
metadata:
  name: authserver-sample
  namespace: default
spec:
  tokenSignature:
    signAndVerifyKeyRef:
      name: my-token-signing-key
    extraVerifyKeyRefs:
      - name: my-token-verification-key
  # ...
---
apiVersion: secretgen.k14s.io/v1alpha1
kind: RSAKey
metadata:
  name: my-token-signing-key
  namespace: default
spec:
  secretTemplate:
    type: Opaque
    stringData:
      key.pem: $(privateKey)
      pub.pem: $(publicKey)
---
apiVersion: secretgen.k14s.io/v1alpha1
kind: RSAKey
metadata:
  name: my-token-verification-key
  namespace: default
spec:
  secretTemplate:
```

```

type: Opaque
stringData:
  key.pem: $(privateKey)
  pub.pem: $(publicKey)

```

2. Observe the creation of an underlying `Secrets`. The name of the each `Secret` is the same as the `RSAPKey` names:

```

# Verify Secret exists
kubectl get secret my-token-signing-key

# View the base64-encoded keys
kubectl get secret my-token-signing-key -o jsonpath='{.data}'

```

You should be able to see two fields within the Secret resource: `key.pem` (private key) and `pub.pem` (public key).

3. Verify that the `AuthServer` serves its keys

```
curl -s authserver-sample.default/oauth2/jwks | jq
```

If you encounter any issues with this approach, see [Carvel Secretgen Controller documentation](#).

Using OpenSSL

You can generate an RSA key yourself using OpenSSL. Here are the steps:

1. Generate a PEM-encoded RSA key pair

This guide references [the freely published OpenSSL Cookbook](#) and the approaches mentioned therein around generating a public and private key pair.

```

# Generate an 4096-bit RSA key
openssl genpkey -out privatekey.pem -algorithm RSA -pkeyopt rsa_keygen_bits:4096
# -> privatekey.pem
# The resulting private key output is in the PKCS#8 format

# Next, extract the public key
openssl pkey -in privatekey.pem -pubout -out publickey.pem
# -> publickey.pem
# The resulting public key output is in the PKCS#8 format

# To view details of the private key
openssl pkey -in privatekey.pem -text -noout

```

For OpenSSL key generation examples, see the [OpenSSL documentation](#).



Important

The minimum key size for an `Authserver` is 2048.

2. Create a secret resource by using the key generated earlier in this procedure:

```

kubectl create secret generic my-key \
  --from-file=key.pem=privatekey.pem \
  --from-file=pub.pem=publickey.pem \
  --namespace default

```

3. Apply your `AuthServer`:

```

apiVersion: sso.apps.tanzu.vmware.com/v1alpha1
kind: AuthServer
metadata:
  name: authserver-sample
  namespace: default
spec:
  tokenSignature:
    signAndVerifyKeyRef:
      name: my-key
  # ...

```

4. Verify that the `AuthServer` serves its keys

```
curl -s authserver-sample.default/oauth2/jwks | jq
```

Rotating keys

This section describes how to “rotate” token signature keys for an `AuthServer`.

The action of “rotating” means moving the active token signing key into the set of token verification keys, generating a new cryptographic key, and assigning it to be the designated token signing key.

Assuming that you have an `AuthServer` with token signature keys configured, rotate keys as follows:

1. Generate a new token signing key first. See [creating keys](#). Verify that the new `Secret` exists before proceeding to the next step.
2. Edit `AuthServer.spec.tokenSignature`, append the existing `spec.tokenSignature.signAndVerifyKeyRef` to `spec.tokenSignature.extraVerifyKeys` and set your new key as `spec.tokenSignature.signAndVerifyKeyRef`.

For example:

```

# Before
---
apiVersion: sso.apps.tanzu.vmware.com/v1alpha1
kind: AuthServer
metadata:
  name: authserver-sample
  namespace: default
spec:
  tokenSignature:
    signAndVerifyKeyRef:
      name: old-key
    extraVerifyKeys: []
  # ...

```

```

# After
---
apiVersion: sso.apps.tanzu.vmware.com/v1alpha1
kind: AuthServer
metadata:
  name: authserver-sample
  namespace: default
spec:
  tokenSignature:
    signAndVerifyKeyRef:
      name: new-key
    extraVerifyKeys:

```

```
- name: old-key
# ...
```

Once you apply your changes, key rotation is effective immediately.

Moving the active token signing key to be a token verification key is an *optional* step – check out the [Revoking keys](#) section for more.

Revoking keys

This section describes how to “revoke” token signature keys for an [AuthServer](#).

The action of “revoking” a key means to entirely remove the key from circulation by an [AuthServer](#), whether it be a token signing key or a token verification key. This action might be needed if your organization requires a complete key refresh where older keys are never retained. Another scenario might be in the case of an emergency in which a key or a session has been compromised and a complete revocation is warranted.

To revoke an existing key or keys, you may remove any references to the keys in the [spec.tokenSignature](#) resource. By removing the reference to the key, the system shall no longer acknowledge that the key is used for signing or verifying JWTs.

For example, if you have a token signing key and a few verification keys:

```
---
apiVersion: sso.apps.tanzu.vmware.com/v1alpha1
kind: AuthServer
metadata:
  name: authserver-sample
  namespace: default
spec:
  tokenSignature:
    signAndVerifyKeyRef:
      name: key-3
    extraVerifyKeys:
      - name: key-2
      - name: key-1
# ...
```

To revoke an existing verification key, remove it from the [extraVerifyKeys](#) list. In the example above, you can remove “key-2” and “key-1” from the list; JWTs signed with those keys will no longer be verifiable.

To revoke an existing token signing key, remove it from [signAndVerifyKeyRef](#) field. However, if you remove an existing token signing key without a replacement key, the [AuthServer](#) will not be able to issue access tokens until a valid token signing key is provided. In the example above, “key-3” would be removed; the system will not be able to sign or verify JWTs.

References and further reading

- [JSON Web Signature \(JWS\) - rfc7515 \(ietf.org\)](#)
- [JSON Web Algorithms \(JWA\) spec](#)
- [JSON Web Token \(JWT\) - rfc7519 \(ietf.org\)](#)

Storage for AppSSO

This topic tells you how to configure the storage for Application Single Sign-On (commonly called AppSSO).

Overview

AppSSOs `AuthServer` handles data pertaining to user's session, identity, access tokens and approved or rejected consents. For production environments, it is critical to provide your own storage source to enable enterprise functions such as data backup and recovery, auditing and long-term persistence according to your organization's data and security policies.

AppSSO currently only supports Redis `v6.0` or above as a storage solution. `v6.0` introduced TLS support to ensure encrypted client-server communication - AppSSO enforces TLS by default.

[Storage provided by default](#) refers to an `AuthServer` resource where `.spec.storage` is not set.

Although data in motion is encrypted by using TLS, data at rest is not encrypted by default through `AuthServer`. Each storage provider is responsible for encrypting their own data. See [data types](#) for more information about storage.

Securing Data at rest

To be compliant with HIPAA, FISMA, PCI and GDPR, you must encrypt data at rest. Securing the underlying infrastructure that Redis uses is crucial to protect against a potential attack. The National Institute for Standards and Technology – Federal Information Processing Standards (NIST-FIPS) sets the standard for best practice when it comes to data security in the US. Symmetric cryptography can be used to protect data at rest. This means that the same key encrypts and decrypts the data, so there is no need for a different private and public key. The [Advanced Encryption Standard \(AES\)](#) encryption algorithm is an industry standard for securing data at rest. For the highest level security, VMware recommends using a 256-bit key.

Configuring Redis

To configure Redis as authorization server storage, you must have the following information of your Redis server:

- **Server CA certificate** (optional): the Certificate Authority (CA) certificate to verify Redis TLS connections. It is not required if Redis Server certificate is signed by a public CA.
- **host** (required): the domain name, IP address, or host name of your Redis server.
- **port** (optional): the port number of your Redis server. It default to `6379` and must be a string.
- **username** (optional): the username to authenticate against your Redis server.
- **password** (optional): the password to authenticate against your Redis server.

AppSSO takes the secure-by-default approach and does not establish non-encrypted communication channels. The `AuthServer` resource enters an error state if a non-encrypted connection is attempted.

mTLS is not supported, however Vanilla Redis uses mTLS by default. It can be turned off by setting `tls-auth-clients no`. For more information, see [Redis documentation](#).

The following steps introduce the path to configuring Redis with AppSSO:

1. [Configuring Redis Server CA certificate](#)
2. [Configuring a Redis Secret](#)
3. [Attaching storage to an AuthServer](#)

Configuring Redis Server CA certificate

If your Redis includes a custom or non-public Server CA certificate, you must instruct AppSSO to trust the CA certificate. This is required for the authorization server to communicate with your Redis over TLS. See [CA certificates](#) for more information about configuring a CA certificate with AppSSO.

Configuring a Redis Secret

To provide coordinates (the location details) of your Redis server, you must create a [Secret](#) resource that follows well-known Secret entries conventions. For more information, see [Service Bindings 1.0.0 specification](#).

Example of a properly formatted [Secret](#) resource:



Important

The Secret must be created in the same namespace as your [AuthServer](#).

```
apiVersion: v1
kind: Secret
metadata:
  name: redis-credentials
  namespace: my-authserver
type: servicebinding.io/redis      # optional, must equal 'servicebinding.io/redis'
if defined
stringData:
  type: "redis"                    # required, must equal 'redis'
  ssl: "true"                       # required, must equal 'true'
  host: "redis01.prod.example.com"  # required
  port: "6379"                     # optional, must be a string, defaults to "6379"
if left empty
  password: "!!veryStrongPassword!!" # optional
  username: "redis01-user"           # optional
```

Attaching storage to an AuthServer

After a Redis Secret resource is applied, you can reference the Secret in [.spec.storage](#). An example of an [AuthServer](#) with a reference to a Redis Secret is as follows:

```
apiVersion: sso.apps.tanzu.vmware.com/v1alpha1
kind: AuthServer
metadata:
  name: my-authserver-example
  namespace: my-authserver
spec:
  # ...
  storage:
    redis:
      serviceRef:
        apiVersion: "v1"
        kind: "Secret"
        name: redis-credentials
```

After [AuthServer](#) is applied, ensure its [Status](#) is [Ready](#).

Inspecting storage of an AuthServer

You can inspect the status of an [AuthServer](#)'s storage as follows:

```
kubectl get authserver <authserver-name> \
  --namespace <authserver-namespace> \
```

```
--output jsonpath="{.status.storage.redis}" | jq
```

Expect to see the following output with the actual Redis host and port:

```
{
  "redis": {
    "host": "ci-redis.authservers.svc.cluster.local",
    "port": "6379"
  }
}
```

Storage provided by default

If no storage is defined, an `AuthServer` provides its own short-lived ephemeral storage solution, Redis. The provided Redis is configured to never flush any data to any volume that might be attached to the pods that operate the authorization server.



Caution

The default storage configuration is designed for prototyping or testing environments and must not be used in production environments.

To view details for Redis of an `AuthServer`:

```
# Get the Redis image
kubectl get authserver <authserver-name> \
  --namespace <authserver-namespace> \
  --output jsonpath="{.status.deployments.redis}" | jq

# Get the Redis host and port
kubectl get authserver <authserver-name> \
  --namespace <authserver-namespace> \
  --output jsonpath="{.status.storage.redis}" | jq
```

Data types

The following data is stored in Redis:

- Client information
 - Authorization grant type
 - Client id
- User session
 - Session token
 - Refresh token
- Identity and access tokens



Note

This is the data that carries the highest level risk.

- Authentication token including the principal
 - Personally identifying information such as email and name

- Approved or rejected consents
 - A client identifier
 - A reference to the user
 - A list of the Authorities that the user has granted to this client

Known limitations of storage providers

Redis Cluster

When your storage is provided by Redis Cluster, additional settings might be required.

The nodes and the maximum number of redirects must be set in your Service Bindings' `Secret`. For example, in addition to the entries in [Configuring a Redis Secret](#), you must provide `cluster` settings as follows:

```
apiVersion: v1
kind: Secret
metadata:
  name: redis-cluster-credentials
  namespace: authservers
type: servicebinding.io/redis
stringData:
  #...
  cluster.max-redirects: 5
  cluster.nodes: 100.90.1.10:6379,100.90.1.11:6379,100.90.1.12:6379
```



Important

`cluster.nodes` must be a comma-separated list of `<ip>:<port>`.

AuthServer readiness for AppSSO

This topic tells you how to use `AuthServer.status` as a reliable source to verify an `AuthServer`'s readiness for Application Single Sign-On (commonly called AppSSO).

You can verify your `AuthServer` by ensuring:

- there is at least one token signing key configured.

```
curl -X GET {spec.issuerURI}/oauth2/jwks
```

The response body should yield at least one key in the list. If there are no keys, please [apply a token signing key](#)

- OpenID discovery endpoint is available.

```
curl -X GET {spec.issuerURI}/.well-known/openid-configuration
```

The response body should yield a valid JSON body containing information about the `AuthServer`.

Client registration check

It is helpful to verify an `AuthServer` by running a test run with a test `ClientRegistration`. It ensures that app developers can register clients with the `AuthServer` successfully.

Follow the steps below to ensure that your installation can:

1. Add a test client.
2. Get an access token.
3. Invalidate/remove the test client.

Prerequisites

Ensure that you have successfully [applied a token signing key](#) to your `AuthServer` before proceeding.

Define and apply a test client

Apply a `ClientRegistration` to your cluster in a Namespace that the `AuthServer` should allow clients from:

```
---
apiVersion: sso.apps.tanzu.vmware.com/v1alpha1
kind: ClientRegistration
metadata:
  name: test-client
  namespace: default
spec:
  authServerSelector:
    matchLabels:
      # appropriate labels for your `AuthServer`
  authorizationGrantTypes:
    - client_credentials
  clientAuthenticationMethod: client_secret_basic
```

See the [ClientRegistration API reference](#) for more field definitions.

This defines a test `ClientRegistration` with the `client_credentials` OAuth grant type.

Apply the `ClientRegistration`:

```
kubectl apply -f appssso-test-client.yaml
```

Once the `ClientRegistration` is applied, inspect its status and verify it's ready.

Get an access token

You should be able to get a token with the client credentials grant for example:

```
# Get client id (`base64` command has to be available on the command line)
export APPSSO_TEST_CLIENT_ID=$(kubectl get secret test-client -n default -o jsonpath="{.data['client-id']}" | base64 --decode)

# Get client secret (`base64` command has to be available on the command line)
export APPSSO_TEST_CLIENT_SECRET=$(kubectl get secret test-client -n default -o jsonpath="{.data['client-secret']}" | base64 --decode)

# Attempt to fetch access token
curl \
  --request POST \
  --location "{spec.issuerURI}/oauth2/token" \
  --header "Content-Type: application/x-www-form-urlencoded" \
  --header "Accept: application/json" \
  --data "grant_type=client_credentials" \
  --basic \
  --user $APPSSO_TEST_CLIENT_ID:$APPSSO_TEST_CLIENT_SECRET
```

You should see a response JSON containing populated field `access_token`. If so, the system is working as expected, and client registration check is successful.

Make sure to delete the test `ClientRegistration` once you are done.

Scale AuthServer for AppSSO

This topic tells you how to scale `AuthServer` for Application Single Sign-On (commonly called AppSSO).

The number of authorization server replicas for an `AuthServer` can be specified under `spec.replicas`.

Furthermore, `AuthServer` implements the `scale` subresource. That means you can scale an `AuthServer` with the existing tooling. For example:

```
kubectl scale authserver authserver-sample --replicas=3
```

The resource of the authorization server and Redis `Deployments` can be configured under `spec.resources` and `spec.redisResources` respectively. See the [API reference](#) for details.

Curate a service offering

This topic describes how you expose an `AuthServer` as a ready-to-claim service offering using a `ClusterWorkloadRegistrationClass`.

`ClusterWorkloadRegistrationClass` creates resources so that application operators can discover and claim credentials for an Application Single Sign-On service offering. A `ClusterWorkloadRegistrationClass` has a description that is shown when application operators discover services by running `tanzu service class list`. This allows you identify the offering as an Application Single Sign-On service.

Furthermore, `ClusterWorkloadRegistrationClass` carries a base `WorkloadRegistration`, which is the blueprint for claims against this service. This base selects the target `AuthServer`. It can optionally receive a custom domain template, labels, and annotations that all `WorkloadRegistration` inherit.

Prerequisites

Before you create a service offering, you must create and configure an `AuthServer`. For instructions, see the topics in the [service operator guide](#).

Create a `ClusterWorkloadRegistrationClass`

For an `AuthServer` with the following labels:

```
---
apiVersion: sso.apps.tanzu.vmware.com/v1alpha1
kind: AuthServer
metadata:
  labels:
    sso.apps.tanzu.vmware.com/env: staging
    sso.apps.tanzu.vmware.com/ldap: ""
#! ...
```

You can expose it as a claimable service offering by configuring a `ClusterWorkloadRegistrationClass` as follows:

```

apiVersion: sso.apps.tanzu.vmware.com/v1alpha1
kind: ClusterWorkloadRegistrationClass
metadata:
  name: demo
spec:
  base:
    spec:
      authServerSelector:
        matchLabels:
          sso.apps.tanzu.vmware.com/env: staging
          sso.apps.tanzu.vmware.com/ldap: ""

```

After you apply this resource, application operators can discover it by running `tanzu service class list`, for example:

```

$ tanzu service class list
NAME      DESCRIPTION
demo     Login by AppSSO

```

Application operators can claim credentials for this service either by running the command `tanzu service class-claim create` or with a `ClassClaim` resource.

When a claim is created, a `WorkloadRegistration` is created from the base and it targets the `AuthServer`.

Customize the `ClusterWorkloadRegistrationClass`

Each `WorkloadRegistration` has `https://` redirect URIs templated. The default template is configured with `default_workload_domain_template`. If `spec.workloadDomainTemplate` is omitted, the default template is used. For more information, see [default_workload_domain_template](#). Otherwise, you can customize it by setting a template on the base, for example, `"{{.Name}}-{{.Namespace}}.demo.{{.Domain}}"`.

You can further customize each `WorkloadRegistration` by setting labels and annotations for them.

The default description of an Application Single Sign-On service offering is "Login by AppSSO", but you can customize this. Consider using a good name and description. For more information, see [Names and descriptions](#) later in this topic.

For example, if you want the `WorkloadRegistration` to template redirect URIs from a custom template and with both `https://` and `http://`, and you want to say that in the service's description, edit the `ClusterWorkloadRegistrationClass` as follows:

```

apiVersion: sso.apps.tanzu.vmware.com/v1alpha1
kind: ClusterWorkloadRegistrationClass
metadata:
  name: demo
spec:
  description:
    short: Login by AppSSO with LDAP for apps in the "demo" subdomain
  base:
    metadata:
      annotations:
        sso.apps.tanzu.vmware.com/template-unsafe-redirect-uris: ""
    spec:
      workloadDomainTemplate: "{{.Name}}-{{.Namespace}}.demo.{{.Domain}}"
      authServerSelector:
        matchLabels:
          sso.apps.tanzu.vmware.com/env: staging
          sso.apps.tanzu.vmware.com/ldap: ""

```

Names and descriptions

When choosing a name and a description for a `ClusterWorkloadRegistrationClass` consider the following:

- When the name of a service is stable across environments, for example, from dev to production, application operators can use the same `ClassClaim` in all environments.
- The description of a service must clearly communicate its flavor and provider. The default description of a `ClusterWorkloadRegistrationClass` is "Login by AppSSO".

If there is a single Application Single Sign-On service offering the default description is usually good enough.

To customize the description for your `ClusterWorkloadRegistrationClass`, consider prefixing it with "Login by AppSSO - ", for example, "Login by AppSSO - LDAP and GitHub".

Application Single Sign-On for App Operators

The following topics explain how to consume an Application Single Sign-On service:

- [Discover AppSSO services](#)
- [Claim credentials for an AppSSO service](#)
- [Secure a workload](#)
- [Secure a Spring Boot workload](#)
- [Secure a single-page app workload](#)

Discover Application Single Sign-On service offerings

This topic describes the recommended method for you to discover Application Single Sign-On service offerings.

VMware recommends that you consume Application Single Sign-On by claiming credentials for an Application Single Sign-On service using [Services Toolkit](#). [Service operators](#) are responsible for curating service offerings.

You can discover the available service offerings with the Tanzu Service CLI:

```
tanzu service class list
```

The output contains a list of services you can claim credentials for, for example:

```
$ tanzu service class list
NAME                DESCRIPTION
mysql-unmanaged     MySQL by Bitnami
postgresql-unmanaged PostgreSQL by Bitnami
rabbitmq-unmanaged  RabbitMQ by Bitnami
redis-unmanaged     Redis by Bitnami
sso                  Login by AppSSO - LDAP
sso-demo             Login by AppSSO - user:password - UNSAFE FOR PRODUCTION!
```

By looking at the `DESCRIPTION` you can identify two of the services as being for Application Single Sign-On: `sso` and `sso-demo`.

Claim credentials for an Application Single Sign-On service offering

This topic describes the recommended method for you to consume Application Single Sign-On service offerings, which is by using a class claim.

When you create a claim for an Application Single Sign-On service, you receive your service credentials through [service bindings](#). This makes it easier to load the credentials into a workload running on Tanzu Application Platform.

To learn about the different levels of Application Single Sign-On service consumption, see [The three levels of Application Single Sign-On consumption](#).

Discover available parameters

To create a claim for an Application Single Sign-On service, target the specific service and provide the required and optional parameters. These parameters allow you to configure the OAuth2 client according to your needs.

To discover the parameter schema for a service, run:

```
tanzu service class get NAME
```

For example:

```
$ tanzu service class get sso

NAME:          app-sso
DESCRIPTION:   Login by AppSSO - OAuth2
READY:        true

PARAMETERS:
  KEY              DESCRIPTION  TYPE      DEFAULT          REQUIRED
  authorizationGrantTypes  [...]      array     [authorization_code]  false
  clientAuthenticationMethod  [...]      string    client_secret_basic  false
  redirectPaths           [...]      array     <nil>             false
  requireUserConsent      [...]      boolean   true               false
  scopes                  [...]      array     [map[...]]         false
  workloadRef.name        [...]      string    <nil>              true
```

Here you can see all the parameters with a brief description, their types, default values, and whether they are required or not. The only required parameter is `workloadRef.name`.

Claim credentials

To claim credentials you can either use the `tanzu service class-claim create` command or create a `ClassClaim` directly.

- **If using the Tanzu CLI**, claim credentials by running:

```
tanzu service class-claim create CLAIM-NAME \
  --class SERVICE-NAME \
  --namespace NAMESPACE \
  --parameter workloadRef.name=WORKLOAD-NAME \
  --parameter PARAMETER
```

Where:

- `CLAIM-NAME` is a name you choose for your claim.
- `SERVICE-NAME` is the name of the service that you want to claim.
- `NAMESPACE` is the namespace that your workload is in.
- `WORKLOAD-NAME` is the name of your workload.

- (Optional) `PARAMETER` is a parameter that you choose in the format `KEY=VALUE`. You can add more than one optional parameter. For how to discover parameters you can add, see [Discover available parameters](#).

For example:

```
$ tanzu service class-claim create my-class-claim \
  --class app-sso \
  --namespace my-namespace \
  --parameter workloadRef.name=my-workload \
  --parameter redirectPaths='["/login/oauth2/code/sso"]' \
  --parameter authorizationGrantTypes='["client_credentials", "authorization_code"]' \
  --parameter requireUserConsent=false
```

- If using a `ClassClaim`, create a YAML file similar to the following example:

```
---
apiVersion: services.apps.tanzu.vmware.com/v1alpha1
kind: ClassClaim
metadata:
  name: my-class-claim
  namespace: my-namespace
spec:
  classRef:
    name: app-sso
  parameters:
    workloadRef:
      name: my-workload
    redirectPaths:                                # Optional
      - /login/oauth2/code/sso
    authorizationGrantTypes:                       # Optional
      - client_credentials
      - authorization_code
    requireUserConsent: false                      # Optional
```



Important

When iterating on your `ClassClaim`, you must recreate it when you make changes. Updates to an existing `ClassClaim` have no effect. For more information, see [Class claims compared to resource claims](#).

Inspect the progress of your claim

You can inspect the progress of your claim creation by running:

```
tanzu service class-claim get MY-CLAIM-NAME --namespace MY-NAMESPACE
```

or

```
kubectl get classclaim MY-CLAIM-NAME --namespace MY-NAMESPACE --output yaml
```



Caution

It can take approximately 60 to 120 seconds for your Application Single Sign-On credentials to propagate into your service bindings secret.

Next steps

You now have service credentials that you can use to secure your workload with SSO. To learn about the specific client settings and how you can use a claim to secure a workload with Application Single Sign-On, see [Secure a workload](#). For tutorials that show how to secure specific types of workloads with Application Single Sign-On, see [Secure a single-page app workload](#) and [Secure a Spring Boot workload](#).

If you have problems claiming credentials for an Application Single Sign-On service, learn how to [troubleshoot](#). For more information about the `tanzu service` command, classes, and claims, see the [Tanzu Service CLI plug-in reference](#).

Secure a workload with Application Single Sign-On

This tutorial tells you how to secure a `Workload` running on Tanzu Application Platform with Application Single Sign-On (commonly called AppSSO).

For specific stack implementations, see [Secure a single-page app workload](#) and [Secure a Spring Boot workload](#).

The [Getting Started](#) section explains how to obtain OAuth2 client credentials for an authorization server by claiming them from an Application Single Sign-On service offering. You can enable this by running the `tanzu service class-claims create` command or by using a `ClassClaim` resource. In either case, you can customize your OAuth2 client settings by providing parameters within your claim. To secure your `Workload`, you must provide the appropriate parameters relevant to the given situation.

The following sections elaborate on each parameter in detail and guide the process of loading credentials into a `Workload`.

When editing your `ClassClaim`, you must recreate it in order for the changes to take effect. Updating an existing `ClassClaim` does not produce any impact. For more information, see [Using a ClassClaim](#).

OAuth2 client parameters

A `ClassClaim` for an Application Single Sign-On service is the request for OAuth2 client credentials for an authorization server.

The following is an example of a claim for a service called `sso`, which customizes all available client parameters:

```
---
apiVersion: services.apps.tanzu.vmware.com/v1alpha1
kind: ClassClaim
metadata:
  name: my-sso-client
  namespace: my-apps
spec:
  classRef:
    name: sso
  parameters:
    workloadRef:
      name: my-workload
    redirectPaths:
      - /login/oauth2/code/my-sso-client
    scopes:
      - name: openid
      - name: email
      - name: profile
```

```

- name: roles
- name: coffee.make
  description: bestows the ultimate power
authorizationGrantTypes:
- client_credentials
- authorization_code
- refresh_token
clientAuthenticationMethod: client_secret_basic
requireUserConsent: true

```

To verify the status of this `ClassClaim`, run:

```
kubectl get classclaim my-sso-client --namespace my-apps
```

After a `ClassClaim` is applied and its status shows `Ready`, it can be consumed by a `Workload`. When the credentials are loaded into a `Workload`, your application code can use them to initiate OAuth2 flows.

redirectPaths

As a critical part of your client parameters, `redirectPaths` define the locations to which your application's end-users are redirected to after the authentication. Incorrect redirect URIs often cause errors for clients and are the most common source of such issues. When redirect URIs are not configured accurately, your application encounters errors and can not perform OAuth2 flows.

For servlet-based Spring Boot workloads using Spring Security OAuth 2 Client library, the default redirect path template looks as follows:

```
/login/oauth2/code/{ClassClaim.metadata.name}`
```

For more information about the format, see the [Spring documentation](#).

For example, configure a single redirect path in `ClassClaim`:

```

spec:
  parameters:
    redirectPaths:
      - /login/oauth2/code/my-sso-client

```

Behind the scenes, your redirect paths are templated into the full redirect URIs including a scheme and fully-qualified domain name. For example, your actual redirect URI might look as follows:

```
https://my-workload.my-apps.example.com/login/oauth2/code/my-sso-client
```

The choice of scheme (`https` or `http`), the template for the subdomain and the ingress domain are under the control of your service operators and platform operators. If your redirect URIs do not template according to your needs, reach out to your service operators and platform operators and request adjustments to the templates.

Redirect paths are one of the values for templating redirect URIs. However, there is another parameter that needs to be considered, which leads us to the next parameter.

workloadRef

`workloadRef.name` is the name of the workload which acts as the OAuth2 client. You can use this value when templating the fully-qualified domain name of your redirect URIs.

```

spec:
  parameters:

```

```
workloadRef:
  name: my-workload
```

Therefore, if you rename your workload from `my-workload` to a different name, you must update this parameter to align with the new name.



Note

`workloadRef` is not resolved to an actual `Workload` existing on the cluster. This means that the claim does not depend on the existence of a `Workload`.

authorizationGrantTypes

In OAuth2, a grant type is the way your application obtains tokens from the authorization server. There are different grant types. Some of them allow your application to act on behalf of an end user, but others do not.

The `authorizationGrantTypes` parameter denotes all the grant types your application can use:

```
spec:
  parameters:
    authorizationGrantTypes:
      - client_credentials
      - authorization_code
      - refresh_token
```

Application Single Sign-On supports the following OAuth2 grant types:

- Authorization Code: `authorization_code`

Applications use this grant type to authenticate and authorize end users. An `AuthServer` issues identity and access tokens to applications to identify end users' identities and their level of access to the protected resources.

- Client Credentials: `client_credentials`

Applications use this grant type to communicate directly to other protected applications through a client identifier and a client secret. For example, in service-to-service communication, an `AuthServer` issues access tokens that define the level of access that the requesting service has to the protected service they seek to communicate with.



Note

Use cases for the grant type `authorization_code` and `client_credentials` are typically different, so VMware recommends creating separate client registrations for each grant type.

- Refresh Token: `refresh_token`

Applications use this grant type to obtain access tokens. If the `refresh_token` grant type is included, a refresh token is attached to every access token issued by an `AuthServer`. You can use the refresh token to fetch the new access tokens before the older ones expire to continue accessing the protected resources.

Client authentication method

A client authentication method defines how your application presents its credentials to the authorization server.

```
spec:
  parameters:
    clientAuthenticationMethod: client_secret_basic
```

There are three client authentication methods:

- `client_secret_basic`(default): Send the client credentials by using the HTTP “Basic” authentication scheme. This is the recommended method for authenticating server-based applications such as Spring Boot or .NET Core apps (confidential clients).
- `client_secret_post`: Send the client credentials in the body of an HTTP POST request.
- `none`: Do not send the client credentials. This is for browser-based single-page apps.

scopes

The `scopes` field defines the OAuth2 scopes requested by your application, including the standard OpenID claims.

```
spec:
  parameters:
    scopes:
      - name: openid # Standard OpenID scope, containing claims "sub" (subject), "aud"
        (audience) and so on.
      - name: email # Standard OpenID scope, containing claims "email" and "email_veri
        fied".
      - name: profile # Standard OpenID scope, containing claims "name", "given_name",
        "family_name" and so on.
      - name: roles # AppSSO special scope, requesting the user roles or groups be pop
        ulated in the "roles" claim.
      - name: coffee.make # Custom the authorization scope.
        description: bestows the ultimate power # With a custom description.
```

To activate the issuance of the users’ identity tokens and authentication, you must include the `openid` scope.

To activate fetching of the user roles or groups, you must include the `roles` scope.

requireUserConsent

The `requireUserConsent` field defines the toggling scopes approved by the end users.

```
spec:
  parameters:
    requireUserConsent: true
```

If activated, the end users are prompted to consent to or reject the scopes that the client requests on behalf of them. If deactivated, all scopes that the client requests are auto-approved or consented to without prompting.

Behind the scenes

When you create a `ClassClaim` for an Application Single Sign-On service, several resources are created behind the scenes. These resources can be helpful for debugging purposes.

- You create a `ClassClaim` for an Application Single Sign-On service with your parameters.
- An `XWorkloadRegistration` with your parameter is created in the same namespace.
- A `WorkloadRegistration` with your parameter is created in the same namespace. The `WorkloadRegistration` templates your redirect URIs.

- A `ClientRegistration` with your parameters and the templated redirect URIs are created in the same namespace.
- The `ClientRegistration` receives the client credentials and passes them all the way to your `ClassClaim`.

Loading client credentials into a `Workload`

Now that you have a client credentials for your application, you can reference the `ClassClaim` from your `Workload`.

An example `Workload` in `my-apps` namespace is as follows:

```
apiVersion: carto.run/v1alpha1
kind: Workload
metadata:
  labels:
    apps.tanzu.vmware.com/workload-type: web
  name: my-workload
  namespace: my-apps
spec:
  serviceClaims:
    - name: my-sso-client # Must match the name of the referenced `ClassClaim`.
      ref:
        apiVersion: services.apps.tanzu.vmware.com/v1alpha1
        kind: ClassClaim
        name: my-sso-claim
  #! ...
```

Alternatively, you can refer to your `ClassClaim` when deploying your workload with the Tanzu CLI:

```
tanzu apps workload create my-workload \
  --service-ref "my-sso-client=services.apps.tanzu.vmware.com/v1alpha1:ClassClaim:my-sso-claim" \
  # ...
```



Important

The service ref name must match the name of the referenced `ClassClaim`.

Thanks to service bindings, your credentials are provided to your `Workload`'s `Pod` (one or more) by mounting a volume containing your client credentials.

The credentials provided by the claim are:

- `client-id`: The identifier of your `Workload` that Application Single Sign-On is registered with. This is a unique identifier.
- `client-secret`: The secret string value used by Application Single Sign-On to verify your client. Keep this value secret.
- `issuer-uri`: The web address of the Application Single Sign-On `AuthServer` and the primary location that your `Workload` goes to when interacting with Application Single Sign-On.
- `authorization-grant-types`: A list of the desired OAuth 2 grant types.
- `client-authentication-method`: The method in which the client is authenticated when requesting an identity or access token.
- `scope`: A list of the desired scopes that your application's users have access to.

These credentials are mounted onto your `Workload`'s `Pod`(one or more) as individual files at the following locations:

```
/bindings
/<name-of-service-claim>
/client-id
/client-secret
/issuer-uri
/authorization-grant-types
/client-authentication-method
/scope
```

Following the earlier example, you can find the location of mounted credentials on every `Pod` at:

```
/bindings/my-sso-client
```

Given these auto-generated values, your `Workload` can now load them at runtime and bind to an Application Single Sign-On authorization server at startup time. Reading the values from the file system is left to the implementer.

Trusting an authorization server

Your application makes a request to the authorization server. The authorization server serves traffic using TLS. If your company uses non-public certificate authority (CA), you must explicitly trust the authorization server or rather the certificate authority. For more information, see [Configure Workloads to trust a custom certificate authority](#).

Summary

This concludes the tutorial explaining how to claim the client credentials for an Application Single Sign-On authorization server and how to secure a workload.

Secure a Spring Boot workload

This tutorial tells you how to secure a sample Spring Boot `Workload` with Application Single Sign-On (commonly called AppSSO), which runs on Tanzu Application Platform (commonly called TAP).

Follow these steps to deploy a sample Spring Boot `Workload`:

1. [Get the sample application](#).
2. [Create a namespace for workloads](#).
3. [Claim client credentials](#).
4. (Optional) [Ensure Workload trusts AuthServer](#).
5. [Deploy the workload](#).

Get the sample application

Follow these steps to fetch the Application Single Sign-On Spring Boot application source code:

1. Download the Application Single Sign-On Starter Java accelerator from the Tanzu Developer Portal (formerly named Tanzu Application Platform GUI) accelerators located on your Tanzu Application Platform cluster:
 - Option 1: Use the Tanzu Developer Portal dashboard through the browser.

Navigate to Application Accelerators and download the “AppSSO Starter Java” accelerator.

- o Option 2: Use the Tanzu Accelerator CLI.

Download the zip file of the accelerator source code by running:

```
tanzu accelerator generate appssso-starter-java --server-url TAP_GUI_SERVE
R_URL
```

2. Unzip the resulting `.zip` file into the `appssso-starter-java` directory in your workspace.

```
unzip appssso-starter-java
```

3. With the resulting project, create an accessible remote Git repository and push your accelerator to the Git remote repository.

Create a namespace for workloads

You must create a namespace for your workloads for the `Workload` resources to function properly. If you have a workloads namespace already, you can skip this step.

```
kubectl create namespace my-apps
kubectl label namespaces my-apps apps.tanzu.vmware.com/tap-ns=""
```

For more information about provisioning namespaces for workloads, see [Set up developer namespaces](#).

Claim client credentials

Follow these steps to claim credentials for an Application Single Sign-On service so that you can secure your workload:

1. Discover the available Application Single Sign-On services with the Tanzu Service CLI:

```
$ tanzu service class list
NAME      DESCRIPTION
sso       Login by AppSSO
```

The actual names of your AppSSO services might be different. VMware assumes that there’s one AppSSO service with the name `sso`.

2. Claim credentials for that service by creating a `ClassClaim` named `appssso-starter-java` in the `my-apps` namespace.

```
---
apiVersion: services.apps.tanzu.vmware.com/v1alpha1
kind: ClassClaim
metadata:
  name: appssso-starter-java
  namespace: my-apps
spec:
  classRef:
    name: sso
  parameters:
    workloadRef:
      name: appssso-starter-java
    redirectPaths:
      - /login/oauth2/code/appssso-starter-java
    scopes:
      - name: openid
```

```
authorizationGrantTypes:
  - authorization_code
clientAuthenticationMethod: client_secret_basic
```

3. Apply the `ClassClaim` and verify its status by running:

```
kubectl get classclaim appssso-starter-java --namespace my-apps
```

Ensure `Workload` trusts `AuthServer`

For Tanzu Application Platform cluster with a custom or self-signed CA certificate, see [Configure workloads to trust a custom Certificate Authority \(CA\)](#).

Deploy the `Workload`

Follow these steps to deploy the `Workload`:

1. Create the Spring Boot accelerator `Workload` by running:

```
tanzu apps workload create appssso-starter-java \
  --namespace my-apps \
  --type web \
  --label app.kubernetes.io/part-of=appssso-starter-java \
  --build-env "BP_JVM_VERSION=17" \
  --service-ref "appssso-starter-java=services.apps.tanzu.vmware.com/v1alpha1:ClassClaim:appssso-starter-java" \
  --service-ref "ca-cert=v1:Secret:tap-ca-cert" \
  --git-repo "<GIT_LOCATION_OF_YOUR_ACCELERATOR>" \
  --git-branch main \
  --live-update
```



Important

Although you can assign any name to the `ClassClaim`, the `Workload`'s service reference name must match the `ClassClaim`'s name.

```
--service-ref "**appssso-starter-java**=services.apps.tanzu.vmware.com/v1alpha1:ClassClaim:appssso-starter-java"
```

If the service reference name does not match the `ClassClaim` name, the `Workload` generates a redirect URI that the authorization server will reject.

It might take a few minutes for the workload to become available through a browser-accessible URL.

2. Query the latest status of the workload by running:

```
tanzu apps workload get appssso-starter-java --namespace my-apps
```

3. Monitor the `Workload` logs:

```
tanzu apps workload tail appssso-starter-java --namespace my-apps
```

After the status of the workload reaches the `Ready` state, you can navigate to the provided URL, which looks similar to:

```
https://appssso-starter-java.my-apps.<TAP_CLUSTER_DOMAIN_NAME>
```

4. Open your preferred web browser and navigate to the URL.
Expect to see a large log-in button tailored for authenticating with AppSSO.

Cleaning up

Delete the running application by running the following commands:

1. Delete the sample application `Workload`:

```
tanzu apps workload delete appssso-starter-java --namespace my-apps
```

2. Delete the claim:

```
tanzu service class-claims delete appssso-starter-java --namespace my-apps
```

Secure a single-page app workload

This tutorial tells you how to secure a sample single-page Angular app `Workload` with Application Single Sign-On (commonly called AppSSO), which runs on Tanzu Application Platform (commonly known as TAP).

Follow these steps to deploy a sample single-page app `Workload`:

1. [Get the sample application.](#)
2. [Create a namespace for workloads.](#)
3. [Claim client credentials.](#)
4. [Verify application authentication settings.](#)
5. [Start a sample back end.](#)
6. [Deploy the Workload.](#)

Get the sample application

Follow these steps to fetch the single-page Angular app source code:

1. Download the Angular Frontend accelerator from the Tanzu Developer Portal accelerators located on your Tanzu Application Platform cluster:

- Option 1: Use the Tanzu Developer Portal dashboard by using a browser.

Navigate to Application Accelerators and choose the **Angular Frontend** accelerator and then select the **Single Sign-on** option.

- Option 2: Use the Tanzu Accelerator CLI.

Download the zip file of the accelerator source code and identify your `AuthServer` Issuer URI by running:

```
kubectl get authserver -A
```

Generate the accelerator by using the `tanzu accelerator` CLI:

```
tanzu accelerator generate angular-frontend \
  --server-url TAP-GUI-SERVER-URL \
  --options '{
    "useSingleSignOn": true,
    "authority": "AUTHSERVER-ISSUER-URI",
    "namespace": "my-apps",
```

```
"authorityLabelKey": "my-sso",
"authorityLabelValue": "true"
}'
```

2. Unzip the resulting `.zip` file into the `angular-frontend` directory in your workspace:

```
unzip angular-frontend
cd angular-frontend
git init
git branch -M main
git remote add origin YOUR-ACCELERATOR-GIT-REPOSITORY
git push origin main -u
```

For public clients, the `AuthServer` only supports the Authorization Code Flow: `response_type=code`, because public clients such as single page apps cannot safely store sensitive information such as client secrets.

3. Push the resulting directory to the remote Git repository.

Create a namespace for workloads

You must create a namespace for your workloads for the `Workload` resources to function properly. If you have a workloads namespace already, you can skip this step.

```
kubectl create namespace my-apps
kubectl label namespaces my-apps apps.tanzu.vmware.com/tap-ns=""
```

For more information about provisioning namespaces for running `Workloads`, see [Set up developer namespaces](#).

Claim the client credentials

Follow these steps to claim the credentials for an Application Single Sign-On service so that you can secure your workload:

1. Discover the available Application Single Sign-On services with the Tanzu Service CLI:

```
$ tanzu service class list
NAME          DESCRIPTION
sso           Login by AppSSO
```

The actual names of your Application Single Sign-On services might be different. VMware assumes that there's one Application Single Sign-On service with the name `sso`.

2. Claim the credentials for that service by creating a `ClassClaim` named `angular-frontend` in the `my-apps` namespace.

```
---
apiVersion: services.apps.tanzu.vmware.com/v1alpha1
kind: ClassClaim
metadata:
  name: angular-frontend
  namespace: my-apps
spec:
  classRef:
    name: sso
  parameters:
    workloadRef:
      name: angular-frontend
    redirectPaths:
      - /user-profile
```

```

- /customer-profiles/list
- /
scopes:
- name: openid
- name: email
- name: profile
- name: message.read
- name: message.write
authorizationGrantTypes:
- authorization_code
clientAuthenticationMethod: none

```

3. Apply the `ClassClaim` and verify the status is `Ready` by running:

```
kubectl get classclaim angular-frontend --namespace my-apps
```

Verify application authentication settings

Within the single-page Angular app accelerator, authentication configuration settings are located in `src/assets/auth.conf.json`. After generating the accelerator, expect to observe the populated settings.

Open the file and verify that it adheres to the following structure:

```

{
  "authority": "ISSUER-URI",
  "clientId": "CLIENT-ID",
  "scope": [ "openid", "profile", "email", "message.read", "message.write" ]
}

```

Retrieve your client id by running:

```

kubectl get secret \
  $(kubectl get classclaim -n my-apps angular-frontend -o jsonpath='{.status.binding.name}') \
  --namespace my-apps \
  --template='{{ index .data "client-id" | base64decode}}'

```

Retrieve your issuer URI by running:

```

kubectl get secret \
  $(kubectl get classclaim -n my-apps angular-frontend -o jsonpath='{.status.binding.name}') \
  --namespace my-apps \
  --template='{{ index .data "issuer-uri" | base64decode}}'

```

Start a sample back end



Important

You can skip this step if you have a `java-rest-service` back end running already.

The `angular-frontend` sample application requires a back end application to start properly:

1. Start a sample simulated back end by running:

```

kubectl run sample-backend --image nginx:NGINX-VERSION -n my-apps
kubectl expose pod sample-backend --port 80 -n my-apps

```

2. In the `angular-frontend` source code, edit the `.server.location[/api/].proxy_pass` field in the `nginx.conf` file at the root of the source directory.
3. After updating the value, commit the changes to the Git remote repository:

```
server {
  # ...
  location /api/ {
    proxy_pass http://sample-backend.my-apps/api/;
  }
  # ...
}
```

Deploy the Workload

Follow these steps to deploy the Workload:

1. Create the `angular-frontend` accelerator Workload by running:

```
tanzu apps workload create angular-frontend \
  --namespace my-apps \
  --type web \
  --param "clusterBuilder=base" \
  --param "annotations=autoscaling.knative.dev/minScale: \"1\"" \
  --label app.kubernetes.io/part-of=angular-frontend \
  --git-repo "GIT-LOCATION-OF-YOUR-ACCELERATOR" \
  --git-branch main
```



Note

As an alternative approach to creating the workload, you can declaratively define a Workload resource by using `config/workload.yaml` within the source repository.

It might take a few minutes for the workload to become available through a browser-accessible URL.

2. Query the latest status of the workload by running:

```
tanzu apps workload get angular-frontend --namespace my-apps
```

3. Monitor the Workload logs:

```
tanzu apps workload tail angular-frontend --namespace my-apps
```

After the status of the workload reaches the `Ready` state, you can navigate to the provided URL, which looks similar to:

```
https://angular-frontend.my-apps.TAP-CLUSTER-DOMAIN-NAME/user-profile
```

4. Open your preferred web browser and navigate to the URL.

Expect to be prompted to sign in by using AppSSO. After successfully signing in, the profile page displays your identifying information.

Clean up

Delete the running application by running these commands:

1. Delete the sample application `Workload`:

```
tanzu apps workload delete angular-frontend --namespace my-apps
```

2. Delete the claim:

```
tanzu service class-claims delete angular-frontend --namespace my-apps
```

3. Delete the sample back end if was previously applied:

```
kubectl delete svc sample-backend --namespace my-apps
kubectl delete pod sample-backend --namespace my-apps
```

Troubleshoot Application Single Sign-on

This topic tells you how to troubleshoot Application Single Sign-On (commonly called AppSSO).

Why is my AuthServer not working?

Generally, `AuthServer.status` is designed to provide you with helpful feedback to debug a faulty `AuthServer`.

Find all `AuthServer` related Kubernetes resources

Identify all `AuthServer` components with Kubernetes common labels. For more information, see [Kubernetes documentation](#).

Query all related `AuthServer` sub-resources by using `app.kubernetes.io/part-of` label. For example:

```
kubectl get all,ingress,service -A -l app.kubernetes.io/part-of=<authserver-name>
```

See logs of all AuthServers

With `stern`, you can tail the logs of all AppSSO managed `Pods` inside your cluster with:

```
stern --all-namespaces --selector=app.kubernetes.io/managed-by=sso.apps.tanzu.vmware.com
```

Wait for change propagation

When applying changes to an `AuthServer`, changes to issuer URI, IdP (identity provider), server and logging configuration take a moment to be effective as the operator rolls out the authorization server `Deployment`.

Set up debug logs



Caution

Debug logs display all identity information from the upstream identity providers, for example, all LDAP attributes for a user. VMware recommends not using debug logs in production.

An `AuthServer` can display more information related to configuration or claim mappings. To enable debug logs, update your configuration with:

```
---
apiVersion: sso.apps.tanzu.vmware.com/v1alpha1
kind: AuthServer
metadata:
  # ...
spec:
  # ...
  # Do not forget the pipe character and preserve the indentation.
  logging: |
    level:
      com.vmware.tanzu.apps.sso: DEBUG
      appssso: DEBUG
```

Misconfigured `clientSecret`

Problem:

When attempting to sign in, you see [This commonly happens due to an incorrect `\[client_secret\]`](#). It might be because the client secret of an identity provider is misconfigured.

Solution:

Validate the `AuthServer.spec.openid.clientSecretRef`.

Misconfigured redirect URI

Problem:

You see `Error: [invalid_request] OAuth 2.0 Parameter: redirect_uri` when signing in.

Solution:

The `redirectURIs` of a `ClientRegistration` must refer to the URI (one or more) of the registered `Workload`. It does not refer to the URI of the `AuthServer`. For more information, see [Redirect URIs](#).

Unsupported `id_token_signed_response_alg` with openid `identityProviders`

Problem:

When trying to log in with an OpenID Connect `identityProvider`, you are unable to sign in and observe the following error in the logs:

```
[invalid_id_token] An error occurred while attempting to decode the Jwt: Signed JWT re
jected: Another algorithm expected, or no matching key(s) found.
```

Solution:

Verify the `identityProvider`'s discovery endpoint at `ISSUER-URI/.well-known/openid-configuration` where `ISSUER-URI` is the value set at `spec.identityProviders.openid.issuerURI`.

The value of `id_token_signing_alg_values_supported` must include `RS256`. If it is not in the list, your identity configuration might not support AppSSO.

If `RS256` is present, expect to see a `jwtks_uri` key in the discovery endpoint. If you visit the URL stored in this key, it must return at least one RSA key. Otherwise, your identity provider might be misconfigured.

Refer to your identity provider's documentation to enable `RS256` token signing.

Misconfigured identity provider clientSecret

Problem:

- When attempting to sign in, you see `<WORKLOAD_URL> redirected you too many times`. It might be because the client secret of an identity provider is misconfigured.
- If you have access to the authserver logs, verify if there is an entry with the text `"error": "[invalid_client] Client authentication failed: client_secret"`.

Solution:

Validate the secret referenced by the `clientSecretRef` for this particular identity provider in your `authserver.spec`.

Missing scopes

Problem:

When attempting to fetch data after signing in to your application by using AppSSO, you see `[invalid_scope] OAuth 2.0 Parameter: scope`.

Solution:

Add the required scopes into your `ClientRegistration` yaml under `spec.scopes`.

Changes to the secret do not propagate to the `ClientRegistration`. If you recreated the `Secret` that contains the `clientSecret`, you must re-deploy the `ClientRegistration`.

Misconfigured sub claim

Problem:

The `sub` claims in `id_tokens` and `access_tokens` follow the `<providerId>_<userId>` pattern. The previous `<providerId>/<userId>` pattern might cause bugs in URLs without proper URL-encoding in client applications.

Solution:

If your client application stores `sub` claims, you must update the `sub` claims to match the new pattern `<providerId>_<userId>`.

Troubleshoot a ClassClaim for an AppSSO service

Problem:

The service binding secret of a `ClassClaim` for an Application Single Sign-On service is empty.

Solution:

Be patient as it can take up to ~60–120s for the client credentials to be propagated into the claim's service binding secret.

If you have waited for a considerable amount of time and the credentials still haven't appeared, see the [Services Toolkit documentation](#) for more troubleshooting information.

Application Single Sign-On Reference

This topic provides you with the following reference documentation of Application Single Sign-On (commonly called AppSSO):

- [API](#)
- [Known issues](#)
- [OpenShift](#)
- [Package configuration](#)
- [RBAC](#)
- [AuthServer audit logs](#)

AppSSO APIs

This topic provides you with detailed information about the following APIs of Application Single Sign-On (commonly called AppSSO):

- [AuthServer](#)
- [ClientRegistration](#)
- [ClusterUnsafeTestLogin](#)
- [ClusterWorkloadRegistrationClass](#)
- [WorkloadRegistration](#)
- [XWorkloadRegistration](#)

AuthServer API for AppSSO

In Application Single Sign-On (commonly called AppSSO), [AuthServer](#) represents the request for an OIDC authorization server. It causes the deployment of an authorization server backed by Redis over mutual TLS if no storage is defined.

An [AuthServer](#) should have labels which allow to uniquely match it amongst others.

[ClientRegistration](#) selects an [AuthServer](#) by label selector and needs a unique match to be successful.

To allow [ClientRegistrations](#) only from a restricted set of [Namespaces](#), you must set the annotation `sso.apps.tanzu.vmware.com/allow-client-namespaces`. Its value is a comma-separated list of allowed [Namespaces](#), for example, `"app-team-red,app-team-green"`. If the annotation is missing, the default value is `*`, denoting that all client namespaces are allowed.

The issuer URI, which is the point of entry for clients and end-users, is constructed through the package's `domain_template`. You can view the issuer URI by running `kubectl get authserver -n authservers`.

See [Issuer URI & TLS](#) for more information.

Token signature keys are configured by using `spec.tokenSignature`. This is a required field. See [Token signatures](#) for more context.

You can configure identity providers under `spec.identityProviders`. If there is none, end-users can not log in. For more information about configuring identity providers, see [Identity providers](#).

The deployment can be further customized by configuring replicas, resources, http server and logging properties.

Spec

```

apiVersion: sso.apps.tanzu.vmware.com/v1alpha1
kind: AuthServer
metadata:
  name: ""
  namespace: ""
  labels: { } # required, must uniquely identify this AuthServer
  annotations:
    sso.apps.tanzu.vmware.com/allow-client-namespaces: "" # optional, a comma-separated list of allowed client namespaces
    sso.apps.tanzu.vmware.com/allow-unsafe-issuer-uri: "" # optional
    sso.apps.tanzu.vmware.com/allow-unsafe-identity-provider: "" # optional
    sso.apps.tanzu.vmware.com/allow-unsafe-cors: "" # optional
spec:
  # .tls is optional if a default issuer is set
  tls:
    # must be one and only one of issuerRef, certificateRef or secretRef, unless deactivated
    issuerRef:
      name: ""
      kind: ""
      group: cert-manager.io
    certificateRef:
      name: ""
    secretRef:
      name: ""
    deactivated: false # If true, requires annotation `sso.apps.tanzu.vmware.com/allow-unsafe-issuer-uri: ""`.
  cors:
    allowOrigins: # optional, cannot be combined with 'allowAllOrigins'.
      - ""
    allowAllOrigins: false # optional
      # If true, requires annotation `sso.apps.tanzu.vmware.com/allow-unsafe-cors: ""`.
      # Cannot be combined with 'allowOrigins'.
  token: # optional
  accessToken: # optional
    expiry: "12h" # optional, default expiry is 12 hours
  refreshToken: # optional
    expiry: "720h" # optional, default expiry is 720 hours (30 days)
  idToken: # optional
    expiry: "12h" # optional, default expiry is 12 hours
  tokenSignature: # required
  signAndVerifyKeyRef:
    name: "" # Must be a secret that contains an RSA private key with a minimum length of 2048 bits.
  extraVerifyKeyRefs:
    - name: "" # Must be a secret that contains an RSA private key with a minimum length of 2048 bits.
  storage: # optional
    redis: # required if 'storage' is defined
    serviceRef: # Reference to a provisioned service within the same namespace as this AuthServer. Only supports Secret reference.
      apiVersion: "v1"
      kind: "Secret"
      name: ""
  caCerts: # optional

```

```

- secretRef: # Reference to Secret resource within the same namespace as this Auth
Server.
  name: ""
identityProviders: # optional
  # each must be one and only one of internalUnsafe, ldap, openID or saml
  - name: "" # must be unique
    internalUnsafe: # requires annotation `sso.apps.tanzu.vmware.com/allow-unsafe-id
entity-provider: ""`
    users:
      - username: ""
        password: ""
        givenName: ""
        familyName: ""
        email: ""
        emailVerified: false
        claims: # optional
          custom_claim: ""
          another_custom_claim: ""
        roles:
          - ""
    accessToken: # optional
      scope:
        defaults: # optional
          - ""
        rolesToScopes: # optional
          - fromRole: ""
            toScopes:
              - ""
- name: "" # must be unique
ldap:
  server:
    scheme: ""
    host: ""
    port: 0
    base: ""
  bind:
    dn: ""
    passwordRef:
      name: ldap-password
  user:
    searchFilter: ""
    searchBase: ""
  roles: # optional
    fromUpstream:
      attribute: "" # required
    search:
      filter: ""
      base: ""
      subTree: false
      depth: 0
    filterBy: # optional
      - exactMatch: ""
      - regex: "" # must be valid regular expression
  idToken: # optional
    claims:
      - fromUpstream: ""
        toClaim: ""
  accessToken: # optional
    scope:
      defaults: # optional
        - ""
      rolesToScopes: # optional
        - fromRole: ""
          toScopes:
            - ""
  group: # deprecated, use 'ldap.roles.fromUpstream' instead.

```

```

    search: # deprecated, use 'ldap.roles.fromUpstream.search' instead.
      filter: ""
      base: ""
      subTree: false
      depth: 0
      roleAttribute: "" # deprecated, use 'ldap.roles.fromUpstream.attribute' instead.
- name: "" # must be unique
  openID:
    issuerURI: ""
    clientID: ""
    clientSecretRef:
      name: ""
    scopes:
      - ""
    roles: # optional
      fromUpstream:
        claim: "" # required
        filterBy: # optional
          - exactMatch: ""
          - regex: "" # must be valid regular expression
      idToken: # optional
        claims:
          - fromUpstream: ""
            toClaim: ""
      accessToken: # optional
        scope:
          defaults: # optional
            - ""
          rolesToScopes: # optional
            - fromRole: ""
              toScopes:
                - ""
- name: "" # must be unique
  saml:
    metadataURI: ""
    roles: # optional
      fromUpstream:
        attribute: "" # required
        filterBy: # optional
          - exactMatch: ""
          - regex: "" # must be valid regular expressions
      idToken: # optional
        claims:
          - fromUpstream: ""
            toClaim: ""
      accessToken: # optional
        scope:
          defaults: # optional
            - ""
          rolesToScopes: # optional
            - fromRole: ""
              toScopes:
                - ""
  replicas: 1 # optional, default 2
  logging: "" # optional, must be valid YAML
  server: "" # optional, must be valid YAML
  resources: # optional, default {requests: {cpu: "256m", memory: "300Mi"}, limits: {cpu: "2", memory: "768Mi"}}
  requests:
    cpu: ""
    mem: ""
  limits:
    cpu: ""
    mem: ""
  redisResources: # optional, default {requests: {cpu: "50m", memory: "100Mi"}, limit

```

```
s: {cpu: "100m", memory: "256Mi"}}
  requests:
    cpu: ""
    mem: ""
  limits:
    cpu: ""
    mem: ""
status:
  observedGeneration: 0
  issuerURI: ""
  clientRegistrationCount: 1
  tokenSignatureKeyCount: 0
  deployments:
    authServer:
      configHash: ""
      image: ""
      replicas: 0
      redis: # left empty if storage is configured by the service operator
      image: ""
  storage:
    redis:
      host: "" # the hostname of the configured Redis
      port: "" # the port of the configured Redis
  tls:
    deactivated: false
    issuerRef:
      name: ""
      kind: ""
      group: cert-manager.io
  conditions:
    - lastTransitionTime:
      message: ""
      reason: ""
      status: "True" # or "False"
      type: ""
```

Alternatively, you can interactively discover the spec with:

```
kubectl explain authservers.sso.apps.tanzu.vmware.com
```

Status & conditions

The `.status` subresource helps you to learn the `AuthServer`'s readiness, resulting deployments, attached clients and to troubleshoot issues.

`.status.issuerURI` is the templated issuer URI. This is the entry point for any traffic.

`.status.tls` is the actual TLS configuration.

`.status.tokenSignatureKeyCount` is the number of currently configured token signature keys.

`.status.clientRegistrationCount` is the number of currently registered clients.

`.status.deployments.authServer` describes the current authorization server deployment by listing the running image, its replicas, the hash of the current configuration and the generation which has last resulted in a restart.

`.status.deployments.redis` describes the current provided Redis deployment by listing its running image. This field is nil if storage is defined explicitly by using `.spec.storage`.

`.status.storage.redis` describes the configured Redis storage such as host name and port number.

`.status.conditions` documents each step in the reconciliation:

- **Valid:** Is the spec valid?
- **ImagePullSecretApplied:** Has the image pull secret been applied?
- **SignAndVerifyKeyResolved:** Has the single sign-and-verify key been resolved?
- **ExtraVerifyKeysResolved:** Have the single extra verify keys been resolved?
- **IdentityProvidersResolved:** Has all identity provider configuration been resolved?
- **ConfigResolved:** Has the complete configuration for the authorization server been resolved?
- **AuthServerConfigured:** Has the complete configuration for the authorization server been applied?
- **IssuerURIReady:** Is the authorization server yet responding to `{.status.issuerURI}/.well-known/openid-configuration`?
- **Ready:** whether all the previous conditions are "True"

The super condition `Ready` denotes a fully successful reconciliation of a given `ClientRegistration`.

If everything goes well you will see something like this:

```

issuerURI: "https://..."
observedGeneration: 1
tokenSignatureKeyCount: 0
clientRegistrationCount: 0
caCerts:
  - cert:
      subject: ""
      source:
        secretEntry: ""
deployments:
  authServer:
    LastParentGenerationWithRestart: 1
    configHash: "11216479096262796218"
    image: "..."
    replicas: 1
    redis: # leave empty if external storage is defined
      image: "..."
storage:
  redis:
    host: "" # the host name of the configured Redis
    port: "" # the port of the configured Redis
tls:
  deactivated: false
  # One of issuerRef, certificateRef or secretRef is set if TLS is enabled
  issuerRef:
    name: ""
    kind: ""
    group: ""
  certificateRef:
    name: ""
  secretRef:
    name: ""
conditions:
  - lastTransitionTime: "2022-08-24T09:58:10Z"
    message: ""
    reason: KeysConfigSecretUpdated
    status: "True"
    type: AuthServerConfigured
  - lastTransitionTime: "2022-08-24T09:58:10Z"
    message: ""
    reason: Resolved
    status: "True"
    type: ConfigResolved
  - lastTransitionTime: "2022-08-24T09:58:10Z"

```

```

message: ""
reason: ExtraVerifyKeysResolved
status: "True"
type: ExtraVerifyKeysResolved
- lastTransitionTime: "2022-08-24T09:58:10Z"
message: ""
reason: Resolved
status: "True"
type: IdentityProvidersResolved
- lastTransitionTime: "2022-08-24T09:58:10Z"
message: ""
reason: ImagePullSecretApplied
status: "True"
type: ImagePullSecretApplied
- lastTransitionTime: "2022-08-24T09:58:28Z"
message: ""
reason: Ready
status: "True"
type: IssuerURIReady
- lastTransitionTime: "2022-08-24T09:58:28Z"
message: ""
reason: Ready
status: "True"
type: Ready
- lastTransitionTime: "2022-08-24T09:58:10Z"
message: ""
reason: SignAndVerifyKeyResolved
status: "True"
type: SignAndVerifyKeyResolved
- lastTransitionTime: "2022-08-24T09:58:10Z"
message: ""
reason: Valid
status: "True"
type: Valid

```

RBAC

The `ServiceAccount` of the authorization server has a `Role` with the following permissions:

```

- apiGroups:
  - ""
resources:
  - secrets
verbs:
  - get
  - list
  - watch
resourceNames:
  - { name }-auth-server-keys
  - { name }-auth-server-clients

```

Example

This example requests an authorization server with two token signature keys and two identity providers.



Note

The label used for matching to `ClientRegistrations` must be unique across namespaces.

```

---
apiVersion: sso.apps.tanzu.vmware.com/v1alpha1
kind: AuthServer
metadata:
  name: authserver-sample
  namespace: default
  labels:
    identifier: authserver-identifier
    sample: "true"
  annotations:
    sso.apps.tanzu.vmware.com/allow-unsafe-identity-provider: ""
    sso.apps.tanzu.vmware.com/allow-unsafe-cors: ""
spec:
  replicas: 1
  tls:
    issuerRef:
      name: my-cluster-issuer
      kind: ClusterIssuer
  tokenSignature:
    signAndVerifyKeyRef:
      name: sample-token-signing-key
    extraVerifyKeyRefs:
      - name: sample-token-verification-key
  cors:
    allowAllOrigins: true
  identityProviders:
    - name: internal
      internalUnsafe:
        users:
          - username: user
            password: password
            claims:
              alt_address: "123 Alternate Street"
            roles:
              - message.write
    - name: okta
      openID:
        issuerURI: https://dev-xxxxxx.okta.com
        clientID: xxxxxxxxxxxxxxxx
        clientSecretRef:
          name: okta-client-secret
        authorizationUri: https://dev-xxxxxx.okta.com/oauth2/v1/authorize
        tokenUri: https://dev-xxxxxx.okta.com/oauth2/v1/token
        jwksUri: https://dev-xxxxxx.okta.com/oauth2/v1/keys
        userinfoUri: https://dev-xxxxxx.okta.com/oauth2/v1/userinfo
        scopes:
          - openid
        roles:
          fromUpstream:
            claim: my_custom_okta_roles_claim
        idToken:
          claims:
            - fromUpstream: "alternate_address"
              toClaim: "alt_address"
        accessToken:
          scope:
            defaults:
              - "developer.read"
              - "developer.write"
            rolesToScopes:
              - fromRole: "finance"
                toScopes:
                  - "finance.read"
                  - "finance.write"
---

```

```

apiVersion: secretgen.k14s.io/v1alpha1
kind: RSAKey
metadata:
  name: sample-token-signing-key
  namespace: default
spec:
  secretTemplate:
    type: Opaque
    stringData:
      key.pem: $(privateKey)
      pub.pem: $(publicKey)

---
apiVersion: secretgen.k14s.io/v1alpha1
kind: RSAKey
metadata:
  name: sample-token-verification-key
  namespace: default
spec:
  secretTemplate:
    type: Opaque
    stringData:
      key.pem: $(privateKey)
      pub.pem: $(publicKey)

---
apiVersion: v1
kind: Secret
metadata:
  name: okta-client-secret
  namespace: default
stringData:
  clientSecret: xxxxxxxxxxxxxxxxxxxxxxxxxxxxxxxxxxxxxxxx

```

ClientRegistration API for AppSSO

In Application Single Sign-On (commonly called AppSSO), `ClientRegistration` is the request for client credentials for an `AuthServer`.

It implements the `Service Bindings ProvisionedService`. The credentials are returned as a `Service Bindings Secret`.

A `ClientRegistration` must uniquely identify an `AuthServer` by using `spec.authServerSelector`. If it matches none, too many or a disallowed `AuthServer`, it does not get credentials. The other fields are for the configuration of the client on the `AuthServer`.

Spec

```

apiVersion: sso.apps.tanzu.vmware.com/v1alpha1
kind: ClientRegistration
metadata:
  name: ""
  namespace: ""
spec:
  authServerSelector: # required
    matchLabels: { }
  redirectURIs: # optional
    - ""
  scopes: # optional
    - name: ""
      description: ""
  authorizationGrantTypes: # optional
    - client_credentials

```

```

- authorization_code
- refresh_token
  clientAuthenticationMethod: "" # optional, values accepted are described in Client authentication methods section
  requireUserConsent: false # optional
status:
  authServerRef:
    apiVersion: ""
    issuerURI: ""
    kind: ""
    name: ""
    namespace: ""
  binding:
    name: ""
  clientID: ""
  clientSecretHelp: ""
  conditions:
    - lastTransitionTime: ""
      message: ""
      reason: ""
      status: "True" # or "False"
      type: ""
  observedGeneration: 0

```

Alternatively, you can interactively discover the spec with:

```
kubectl explain clientregistrations.sso.apps.tanzu.vmware.com
```

Scopes

The following scopes must be included for the issuance of identity tokens:

- `openid` must be included for the identity tokens to be issued.
- `profile` must be included so the custom-mapped claims are included in an issued identity token, for example, `AuthServer.identityProviders[*].{openID,ldap,saml}.idToken.claims`. For more information, see [Identity token claims mapping](#).
- `email` must be included to retain the `email` and `email_verified` claims.
- `address` must be included to retain the `address` claim.
- `phone` must be included to retain the `phone_number` and `phone_number_verified` claims.
- `roles` must be included to retrieve the user role information from an upstream identity provider. For more information, see [Configure authorization](#).

Client authentication methods

Client authentication methods supported by `ClientRegistration` resource are:

- `client_secret_basic`: HTTP header based client authentication (default).
- `client_secret_post`: HTTP POST body based client authentication.
- `basic` (deprecated): HTTP header based client authentication. Use `client_secret_basic` instead.
- `post` (deprecated): HTTP POST body based client authentication. Use `client_secret_post` instead.
- `none`: No client authentication. Required for public clients. For more information, see [Public clients and CORS](#).

**Caution**

When running workloads by using Spring Boot 3, you must use `client_secret_basic` or `client_secret_post`. For more information, see [Spring Boot 3 based Workloads and ClientRegistration](#) resources.

Status & conditions

The `.status` subresource helps you to learn about your client credentials, the matched `AuthServer` and to troubleshoot issues.

`.status.authServerRef` identifies the successfully matched `AuthServer` and its issuer URI.

`.status.binding.name` is the name of the Service Bindings `Secret` which contains the client credentials.

`.status.conditions` documents each step in the reconciliation:

- `Valid`: Is the spec valid?
- `AuthServerResolved`: Has the targeted `AuthServer` been resolved?
- `ClientSecretResolved`: Has the client secret been resolved?
- `ServiceBindingSecretApplied`: Has the Service Bindings Secret with the client credentials been applied?
- `AuthServerConfigured`: Has the resolved `AuthServer` been configured with the client?
- `Ready`: whether all the previous conditions are “True”

The super condition `Ready` denotes a fully successful reconciliation of a given `ClientRegistration`.

If everything goes well you will see something like this:

```
status:
  authServerRef:
    apiVersion: sso.apps.tanzu.vmware.com/v1alpha1
    issuerURI: http://authserver-sample.default
    kind: AuthServer
    name: authserver-sample
    namespace: default
  binding:
    name: clientregistration-sample
    clientID: default_clientregistration-sample
    clientSecretHelp: 'Find your clientSecret: 'kubect1 get secret clientregistration-s
ample --namespace default'''
  conditions:
  - lastTransitionTime: "2022-05-13T07:56:41Z"
    message: ""
    reason: Updated
    status: "True"
    type: AuthServerConfigured
  - lastTransitionTime: "2022-05-13T07:56:40Z"
    message: ""
    reason: Resolved
    status: "True"
    type: AuthServerResolved
  - lastTransitionTime: "2022-05-13T07:56:40Z"
    message: ""
    reason: ResolvedFromBindingSecret
    status: "True"
    type: ClientSecretResolved
  - lastTransitionTime: "2022-05-13T07:56:41Z"
```

```

message: ""
reason: Ready
status: "True"
type: Ready
- lastTransitionTime: "2022-05-13T07:56:40Z"
message: ""
reason: Applied
status: "True"
type: ServiceBindingSecretApplied
- lastTransitionTime: "2022-05-13T07:56:40Z"
message: ""
reason: Valid
status: "True"
type: Valid
observedGeneration: 1

```

Example

```

apiVersion: sso.apps.tanzu.vmware.com/v1alpha1
kind: ClientRegistration
metadata:
  name: my-client-registration
  namespace: app-team
spec:
  authServerSelector:
    matchLabels:
      for: app-team
      ldap: "true"
  redirectURIs:
    - "https://127.0.0.1:8080/authorized"
    - "https://my-application.com/authorized"
  requireUserConsent: false
  clientAuthenticationMethod: client_secret_basic
  authorizationGrantTypes:
    - "client_credentials"
    - "refresh_token"
  scopes:
    - name: "openid"
      description: "To indicate that the application intends to use OIDC to verify the
user's identity"
    - name: "email"
      description: "The user's email"
    - name: "profile"
      description: "The user's profile information"

```

The client is registered with the authorization server with the given `spec`. The resulting client credentials are available in a `Secret` that the `ClientRegistration` owns.

```

apiVersion: v1
kind: Secret
type: servicebinding.io/oauth2
metadata:
  name: my-client-registration
  namespace: app-team
data: # fields below are base64-decoded for display purposes only
  type: oauth2
  provider: appssso
  client-id: default_my-client-registration
  client-secret: c2VjcmV0 # auto-generated
  issuer-uri: https://appssso.example.com
  client-authentication-method: basic
  scope: openid,email,profile
  authorization-grant-types: client_credentials,refresh_token

```

ClusterUnsafeTestLogin API for Application Single Sign-On

`ClusterUnsafeTestLogin` is the recommended way to get started with Application Single Sign-On (commonly called AppSSO) in non-production environments and it is not safe for production.

`ClusterUnsafeTestLogin` represents the request for an unsafe, ready-to-claim AppSSO service offering. It reconciles into an unsafe `AuthServer`, a token signing key `Secret` and a `ClusterWorkloadRegistrationClass`. It is cluster-scoped. It has no specifications. Its short name is `cutl`.

Its `AuthServer` is `http` only, which allows all CORS origins and runs with a single replica. Its name is prefixed with `unsafe-`. Its issuer URI resembles `http://unsafe-demo.appsso.example.com`.

There is a single `user:password` login. That user has roles `user` and `test` and claims `first_name=First-Name`, `last_name=Last-Name` and `email=user@example.com`.

Its `ClusterWorkloadRegistrationClass` templates `WorkloadRegistration` with safe and unsafe redirect URIs. That means a redirect path is templated with both `https` and `http` as the scheme.

Its namespace-scoped resources are placed in the cluster resource namespace. The cluster resource namespace is `configurable`. The default cluster resource namespace is `appsso`.

Once created, you can discover it with the Tanzu Service CLI:

```
$ tanzu service class list
NAME          DESCRIPTION
<name>       Login by AppSSO - user:password - UNSAFE FOR PRODUCTION!
```

Specification

```
---
apiVersion: sso.apps.tanzu.vmware.com/v1alpha1
kind: ClusterUnsafeTestLogin
metadata:
  name: "" #! required
status:
  clusterResourceNamespace: ""
  conditions:
  - lastTransitionTime: ""
    message: ""
    reason: ""
    status: ""
    type: AuthServerReady
  - lastTransitionTime: ""
    message: ""
    reason: ""
    status: ""
    type: ClusterWorkloadRegistrationClassReady
  - lastTransitionTime: ""
    message: ""
    reason: ""
    status: ""
    type: Ready
  - lastTransitionTime: ""
    message: ""
    reason: ""
    status: ""
    type: SignAndVerifyKeyConditionReady
  observedGeneration: 0
  tokenSignature:
    signAndverifyKey:
```



```
name: ""
pem: ""
```

Example

Due to the zero-configuration nature of the `ClusterUnsafeTestLogin` API, there exists only a single feasible example:

```
---
apiVersion: sso.apps.tanzu.vmware.com/v1alpha1
kind: ClusterUnsafeTestLogin
metadata:
  name: demo
```

ClusterWorkloadRegistrationClass API for Application Single Sign-On

In Application Single Sign-On (commonly called AppSSO), `ClusterWorkloadRegistrationClass` represents the request to expose an `AuthServer` as a claimable service offering. It is cluster-scoped and is identified by its short name `cwrc`.

`ClusterWorkloadRegistrationClass` optionally receives a free-form description which explains the offering to those which discover it with the Tanzu CLI. It also receives a base `WorkloadRegistration` section.

`ClusterWorkloadRegistrationClass` reconciles into a Crossplane `Composition` and a Services Toolkit `ClusterInstanceClass`.

The `Composition` defines how to create a `WorkloadRegistration` for an `AuthServer`. The `Composition` is for the composite resource `XWorkloadRegistration`. It relies on Crossplane's provider-kubernetes.

The `ClusterInstanceClass` is applied with its description and a selector for the `Composition`. Instances of this class are claimed by using Services Toolkit's `ClassClaim`. For more information, see [claims](#).

The available parameters of the `ClusterInstanceClass` are those of `XWorkloadRegistration`. For more information about the fields, see [XWorkloadRegistration](#).

The base `WorkloadRegistration` section is the blueprint for claims to this class. It is the base `Object` for the `Composition`. This base is patched with the parameters from claims. Setting fields on the base sets the fields on all claimed `WorkloadRegistration`. This is how they can match a certain `AuthServer`, or have labels and annotations.

The base is a partial projection of `WorkloadRegistration`'s specification. It is limited to the fields `metadata.labels`, `metadata.annotations`, `spec.workloadDomainTemplate` and `spec.authServerSelector`. For more information about the fields, see [WorkloadRegistration](#).

After the offering is created, you can discover it with the Tanzu Service CLI:

```
$ tanzu service class list
NAME          DESCRIPTION
<name>      <description>
```

You can also discover the service's parameters with the Tanzu Service CLI:

```
$ tanzu service class get <name>
NAME:          <name>
DESCRIPTION:  <description>
```

```
READY:          true
```

PARAMETERS:					
KEY	DESCRIPTION	TYPE	DEFAULT	REQUIRED	
authorizationGrantTypes	[...]	array	[authorization_code]	false	
clientAuthenticationMethod	[...]	string	client_secret_basic	false	
redirectPaths	[...]	array	<nil>	false	
requireUserConsent	[...]	boolean	true	false	
scopes	[...]	array	[map[...]]	false	
workloadRef.name	[...]	string	<nil>	true	

`ClusterWorkloadRegistrationClass` aggregates the readiness of its children. It is not ready until its base's `authServerSelector` uniquely selects an `AuthServer`. When an `AuthServer` is matched, its reference is written to the status.

The `Composition` label selector is written to the status.

Specification

```
---
apiVersion: sso.apps.tanzu.vmware.com/v1alpha1
kind: ClusterWorkloadRegistrationClass
metadata:
  name: "" #! required
spec:
  description:
    short: "" #! required, default to "Login by AppSSO"
  base:
    metadata:
      labels: {} #! optional
      annotations: {} #! optional
    spec:
      workloadDomainTemplate: "" #! optional
      authServerSelector:
        matchLabels: {} #! required
status:
  authServerRef:
    apiVersion: sso.apps.tanzu.vmware.com/v1alpha1
    issuerURI: ""
    kind: AuthServer
    name: ""
    namespace: ""
  compositionSelector:
    matchLabels: {}
  conditions:
  - lastTransitionTime: ""
    message: ""
    reason: ""
    status: ""
    type: AuthServerResolved
  - lastTransitionTime: ""
    message: ""
    reason: ""
    status: ""
    type: ClusterInstanceClassReady
  - lastTransitionTime: ""
    message: ""
    reason: ""
    status: ""
    type: CompositionApplied
  - lastTransitionTime: ""
    message: ""
    reason: ""
    status: ""
```

```
type: Ready
observedGeneration: 1
```

Alternatively, you can interactively discover the API with:

```
kubectl explain cwrc
```

Examples

This is a minimal example which selects an [AuthServer](#) that is uniquely identified by the label `sso.apps.tanzu.vmware.com/env=dev`:

```
---
apiVersion: sso.apps.tanzu.vmware.com/v1alpha1
kind: ClusterWorkloadRegistrationClass
metadata:
  name: sample-minimal
spec:
  base:
    spec:
      authServerSelector:
        matchLabels:
          sso.apps.tanzu.vmware.com/env: dev
```

This is a full example which selects an [AuthServer](#) that is uniquely identified by the label `sso.apps.tanzu.vmware.com/env=dev`. It sets a custom [workloadDomainTemplate](#) on the base, a label and an annotation. The annotation causes in safe and unsafe redirect URI templating.

```
---
apiVersion: sso.apps.tanzu.vmware.com/v1alpha1
kind: ClusterWorkloadRegistrationClass
metadata:
  name: sample-full
spec:
  description:
    short: Login by AppSSO with a custom domain template
  base:
    metadata:
      labels:
        app.kubernetes.io/part-of: service-claims
      annotations:
        sso.apps.tanzu.vmware.com/template-unsafe-redirect-uris: ""
    spec:
      workloadDomainTemplate: "{{.Namespace}}-{{.Name}}.apps.{{.Domain}}"
      authServerSelector:
        matchLabels:
          sso.apps.tanzu.vmware.com/env: staging
```

Claims

Instances of this class are claimed by using Services Toolkit's [ClassClaim](#).

The class is identified by its name and the client registration's configuration is set as its parameters. The `spec` of parameters is the specification of [XWorkloadRegistration](#).

For more information about the [ClassClaim](#) API, see [ClusterInstanceClass](#) and [ClassClaim](#).

You can set the propagation time of client credentials to the [ClassClaim](#) up to 120s.

Claims specification

This is the specification of a `ClassClaim` for a `ClusterWorkloadRegistrationClass`, not the specification of the `ClassClaim` API.

```
---
apiVersion: services.apps.tanzu.vmware.com/v1alpha1
kind: ClassClaim
metadata:
  name: "" #! required
  namespace: #! required
spec:
  classRef:
    name: "" #! required
  parameters:
    workloadRef:
      name: "" #! required
    redirectPaths: #! optional
      - "" #! must be an absolute path
    scopes: #! optional
      - name: "" #! required
        description: "" #! optional
    authorizationGrantTypes: #! optional
      - "" #! must be one of "authorization_code", "client_credentials" or "refresh_to
ken"
    clientAuthenticationMethod: "" #! optional, must be one of "client_secret_post",
"client_secret_basic" or "none"
    requireUserConsent: false #! optional
```

Claims examples

If a claimable AppSSO service offering exists as follows:

```
$ tanzu service class list
NAME                DESCRIPTION
demo                Single Sign-On Demo
```

This is a minimal example claim for the AppSSO service offering `demo`:

```
---
apiVersion: services.apps.tanzu.vmware.com/v1alpha1
kind: ClassClaim
metadata:
  name: sample-minimal
spec:
  classRef:
    name: demo
  parameters:
    workloadRef:
      name: sample-workload
    redirectPaths:
      - /redirect/uri/1
      - /redirect/uri/2
```

This is a fully-configured example claim for the AppSSO service offering `demo`:

```
---
apiVersion: services.apps.tanzu.vmware.com/v1alpha1
kind: ClassClaim
metadata:
  name: sample-full
spec:
  classRef:
    name: demo
  parameters:
```

```

workloadRef:
  name: sample-workload
redirectPaths:
  - /redirect/uri/1
  - /redirect/uri/2
scopes:
  - name: openid
  - name: email
  - name: profile
  - name: roles
  - name: coffee.make
    description: bestows the ultimate power
authorizationGrantTypes:
  - client_credentials
  - authorization_code
  - refresh_token
clientAuthenticationMethod: client_secret_basic
requireUserConsent: false

```

Claims updates

`ClassClaim` performs a point-in-time look-up, so updates to an existing `ClassClaim.spec.parameters` have no effect. For more information, see [Class claims compared to resource claims](#).

When creating your `ClassClaim` with kapp, you can configure it to replace the resource instead of updating it when it changes:

```

---
apiVersion: kapp.k14s.io/v1alpha1
kind: Config
rebaseRules:
  - resourceMatchers:
    - apiVersionKindMatcher:
      { apiVersion: services.apps.tanzu.vmware.com/v1alpha1, kind: ClassClaim }
    path: [metadata, annotations, "classclaims.services.apps.tanzu.vmware.com/xrd-name"]
    type: copy
    sources: [new, existing]
---
apiVersion: services.apps.tanzu.vmware.com/v1alpha1
kind: ClassClaim
metadata:
  annotations:
    kapp.k14s.io/update-strategy: always-replace
#! ...

```

WorkloadRegistration API for AppSSO

In Application Single Sign-On (commonly called AppSSO), `WorkloadRegistration` represents the request for client credentials for an `AuthServer`. It is a portable, higher-level abstraction over `ClientRegistration`. It is namespaced and is identified by its short name `workloadreg`.

`WorkloadRegistration` templates redirect URIs and reconciles into a `ClientRegistration`. For more information, see [Redirect URI templating](#).

`WorkloadRegistration` exposes most of the fields of `ClientRegistration`. The exceptions are `spec.redirectPaths` (instead of `spec.redirectURIs`), `spec.workloadDomainTemplate` and `spec.workloadRef`.

By templating redirect URIs, a `WorkloadRegistration` is decoupled from a client workload's specific FQDN. As a result, it is portable across environments.

`spec.workloadDomainTemplate` is a go lang `text/template`. It is optional with default value `{{.Name}}.{{.Namespace}}.{{.Domain}}`. You can change the default value to the `package configuration` value `default_workload_domain_template`.

The values for `{{.Name}}` and `{{.Namespace}}` are inherited from `spec.workloadRef`. The field `spec.workloadRef` is not resolved to an actual workload running on the cluster. It is a holder for template values which identify a workload.

The `package configuration` value `workload_domain_name` defines the value for `{{.Domain}}`.

Similar to `ClientRegistration`:

- `WorkloadRegistration` is bindable. It implements the `Service Bindings ProvisionedService`. The credentials are returned as a `Service Bindings Secret`.
- A `WorkloadRegistration` must uniquely identify an `AuthServer` by using `spec.authServerSelector`. If it matches none, too many or a disallowed `AuthServer`, it does not get credentials.

`WorkloadRegistration` aggregates the readiness of its child `ClientRegistration`.



Note

The term “workload” is meant to express the general notion of a workload. The overlap with Cartographer’s `Workload` API is therefore both incidental and accidental, because that API too is not opinionated as to what specific resources consolidat a “workload”.

`WorkloadRegistration` represents the client registration of any “workload” whose redirect URIs can be templated. It must not be a `Workload` or even be running on a Kubernetes cluster.

Specification

```
---
apiVersion: sso.apps.tanzu.vmware.com/v1alpha1
kind: WorkloadRegistration
metadata:
  name: "" #! required
  namespace: "" #! required
  annotations:
    sso.apps.tanzu.vmware.com/template-unsafe-redirect-uris: "" #! optional
spec:
  workloadDomainTemplate: "" #! optional
  workloadRef:
    name: "" #! required
    namespace: "" #! required
  authServerSelector:
    matchLabels: {} #! required
  redirectPaths: #! optional
  - "" #! must be an absolute path
  scopes: #! optional
  - name: "" #! required
    description: "" #! optional
  authorizationGrantTypes: #! optional
  - "" #! must be one of "authorization_code", "client_credentials" or "refresh_token"
  clientAuthenticationMethod: "" #! optional, must be one of "client_secret_post", "cl
```

```

ient_secret_basic" or "none"
  requireUserConsent: false #! optional
status:
  authServerRef:
    apiVersion: sso.apps.tanzu.vmware.com/v1alpha1
    issuerURI: ""
    kind: AuthServer
    name: ""
    namespace: ""
  binding:
    name: ""
  conditions:
  - lastTransitionTime: ""
    message: ""
    reason: ""
    status: ""
    type: ClientRegistrationReady
  - lastTransitionTime: ""
    message: ""
    reason: ""
    status: ""
    type: Ready
  observedGeneration: 0
  redirectURIs:
  - ""
  workloadDomainTemplate: ""

```

Alternatively, you can interactively discover the API with:

```
kubectl explain workloadreg
```

Examples

This is a minimal example which selects an `AuthServer` that is uniquely identified by the label `sso.apps.tanzu.vmware.com/env=dev`:

```

---
apiVersion: sso.apps.tanzu.vmware.com/v1alpha1
kind: WorkloadRegistration
metadata:
  name: sample-minimal
spec:
  workloadRef:
    name: test-workload-name
    namespace: test-workload-namespace
  authServerSelector:
    matchLabels:
      sso.apps.tanzu.vmware.com/env: dev

```

This is a full example which selects an `AuthServer` that is uniquely identified by label `sso.apps.tanzu.vmware.com/env=dev`. It uses all possible client configurations and sets a custom `workloadDomainTemplate` and an annotation. The annotation causes safe and unsafe redirect URI templating.

```

---
apiVersion: sso.apps.tanzu.vmware.com/v1alpha1
kind: WorkloadRegistration
metadata:
  name: sample-full
  annotations:
    sso.apps.tanzu.vmware.com/template-unsafe-redirect-uris: ""
spec:

```

```

workloadDomainTemplate: "hi-i-live-in-{{.Namespace}}-and-my-name-is-{{.Name}}.sample.{{.Domain}}"
workloadRef:
  name: test-workload-name
  namespace: test-workload-namespace
authServerSelector:
  matchLabels:
    name: authserver-sample
    sample: "true"
redirectPaths:
  - /redirect/uri/1
  - /redirect/uri/2
scopes:
  - name: openid
  - name: email
  - name: profile
  - name: roles
  - name: coffee.make
    description: bestows the ultimate power
authorizationGrantTypes:
  - client_credentials
  - authorization_code
  - refresh_token
clientAuthenticationMethod: client_secret_basic
requireUserConsent: true

```

Redirect URI templating

Redirect URIs are templated as follows:

1. If `spec.redirectPaths` is empty, no further action is required.
2. Resolve the workload domain template by reading `spec.workloadDomainTemplate` or default it to `default_workload_domain_template` if omitted.
3. Resolve the values for `{{.Name}}` and `{{.Namespace}}` from `spec.workloadRef`.
4. Resolve the value for `{{.Domain}}` from `workload_domain_name`.
5. For each entry in `spec.redirectPaths`, template a full redirect URI by joining the path with the rendered workload domain template. Use `https` as the scheme.
6. If the annotation `sso.apps.tanzu.vmware.com/template-unsafe-redirect-uris` is present, template an additional unsafe redirect URI for each entry in `spec.redirectPaths` by using `http` as the scheme.

For example, if you set `workload_domain_name` to `tap.example.com`, a hypothetical

`WorkloadRegistration` might look as follows:

```

---
apiVersion: sso.apps.tanzu.vmware.com/v1alpha1
kind: WorkloadRegistration
metadata:
  name: demo
  annotations:
    sso.apps.tanzu.vmware.com/template-unsafe-redirect-uris: ""
spec:
  workloadRef:
    name: my-workload
    namespace: my-ns
  redirectPaths:
    - /login/success
    - /login/error
  #! ...
status:

```



```

redirectURIs:
  - https://my-workload.my-ns.tap.example.com/login/success
  - http://my-workload.my-ns.tap.example.com/login/success
  - https://my-workload.my-ns.tap.example.com/login/error
  - http://my-workload.my-ns.tap.example.com/login/error
workloadDomainTemplate: '{{.Name}}.{{.Namespace}}.{{.Domain}}'
#! ...

```

XWorkloadRegistration API for AppSSO

In Application Single Sign-On (commonly called AppSSO), `XWorkloadRegistration` is a cluster-scoped Crossplane XRD. It serves as an integration API between Services Toolkit, Crossplane and AppSSO.



Note

This API is not intended for direct usage. Although it is supported, VMware recommend using `ClassClaim`, `WorkloadRegistration`, or `ClientRegistration` instead when you need direct access to this API.

In most cases, when creating a `ClassClaim` for an AppSSO service offering, for example, `ClusterWorkloadRegistrationClass`, Services Toolkit creates an `XWorkloadRegistration`. By using a `Composition`, the `XWorkloadRegistration` is reconciled into a `WorkloadRegistration` with Crossplane's `provider-kubernetes`'s `Object` as an intermediary.

The specification of `XWorkloadRegistration` is identical to `WorkloadRegistration` but without `spec.workloadRef.namespace` and `spec.authServiceSelector`.

Specification

```

---
apiVersion: sso.apps.tanzu.vmware.com/v1alpha1
kind: XWorkloadRegistration
metadata:
  name: "" #! required
spec:
  workloadRef:
    name: "" #! required
  redirectPaths: #! optional
  - "" #! must be an absolute path
  scopes: #! optional
  - name: "" #! required
    description: "" #! optional
  scopes: #! optional
  - name: "" #! required
    description: "" #! optional
  authorizationGrantTypes: #! optional
  - "" #! must be one of "authorization_code", "client_credentials" or "refresh_token"
  clientAuthenticationMethod: "" #! optional, must be one of "client_secret_post", "client_secret_basic" or "none"
  requireUserConsent: false #! optional
status:
  authServiceRef:
    apiVersion: sso.apps.tanzu.vmware.com/v1alpha1
    issuerURI: ""
    kind: AuthServer
    name: ""
    namespace: ""

```

```
binding:
  name: ""
```



Note

Crossplane's standard Crossplane Resource Model (commonly called XRM) fields are omitted.

Examples

If a [Composition](#) for [XWorkloadRegistration](#) exists, for example, by using a [ClusterWorkloadRegistrationClass](#), this is a minimal example:

```
---
apiVersion: sso.apps.tanzu.vmware.com/v1alpha1
kind: XWorkloadRegistration
metadata:
  name: sample-minimal
spec:
  workloadRef:
    name: test-workload-name
```

This is a fully configured example:

```
---
apiVersion: sso.apps.tanzu.vmware.com/v1alpha1
kind: XWorkloadRegistration
metadata:
  name: sample-full
spec:
  workloadRef:
    name: test-workload-name
  redirectPaths:
    - /redirect/uri/1
    - /redirect/uri/2
  scopes:
    - name: openid
    - name: email
    - name: profile
    - name: roles
    - name: coffee.make
      description: bestows the ultimate power
  authorizationGrantTypes:
    - client_credentials
    - authorization_code
    - refresh_token
  clientAuthenticationMethod: client_secret_basic
  requireUserConsent: true
```

Known issues for Application Single Sign-On

This topic describes known limitations and workarounds related to working with Application Single Sign-On (commonly called AppSSO). For further troubleshooting guidance, see [Troubleshoot Application Single Sign-on](#).

Unregistration by deletion

You can only deregister an existing, ready `ClientRegistration` from its selected `AuthServer` by deleting it. Breaking the match between the two resources by updating either the labels of the `AuthServer` or the label selector on the `ClientRegistration` does not deregister the client from the authorization server.

Limited number of `ClientRegistrations` per `AuthServer`

The number of `ClientRegistration` for an `AuthServer` is limited to around 2,000. This is a soft limitation. If you attempt to apply more `ClientRegistration` resources than the limit, those clients applied past the limit will work. This is subject to change in future product versions.

LetsEncrypt: domain name for Issuer URI limited to 64 characters maximum

If you use LetsEncrypt to issue TLS certificates for an `AuthServer`, the domain name for the Issuer URI (excluding the `http{s}` prefix) cannot exceed 64 characters in length. If exceeded, you might receive a LetsEncrypt specific error during the certificate issuance process. You might observe this limitation when your base domain and subdomain joined together exceed the maximum limit.

If your default Issuer URI is too long, use the `domain_template` field in Application Single Sign-On values YAML to shorten the domain.

For example, you can forgo the namespace in the Issuer URI as follows:

```
domain_template: "{{.Name}}.{{.Domain}}"
```



Caution

By leaving out the namespace in your domain template, application routes might conflict if there are multiple `AuthServers` with the same name but in different namespaces.

Spring Boot 3 based `Workloads` and `ClientRegistration` resources

If you run a `Workload` based on Spring Boot 3 or use Spring Security OAuth2 Client 3 library in conjunction with `ResourceClaims`, you must configure your `ClientRegistration` resource to use either of the following client authentication methods:

- `client_secret_basic` (default)
- `client_secret_post`

The existing `post` and `basic` values do not work with Spring Boot 3 based `Workloads` with Spring Cloud Bindings and are deprecated.

`ClassClaim` credential propagation time

It can take up to 60 to 120 seconds for the client credentials to propagate up into a `ClassClaim`'s service binding secret.

Application Single Sign-On for OpenShift clusters

On OpenShift clusters, AppSSO must run with a custom SecurityContextConstraint (SCC) to enable compliance with restricted Kubernetes Pod Security Standards. Tanzu Application Platform configures the following SCC for AppSSO controller and its `AuthServer` managed resources when you configure the `kubernetes_distribution: openshift` key in the `tap-values.yaml` file.

Specification follows:

```
---
kind: SecurityContextConstraints
apiVersion: security.openshift.io/v1
metadata:
  name: appssso-scc
allowHostDirVolumePlugin: false
allowHostIPC: false
allowHostNetwork: false
allowHostPID: false
allowHostPorts: false
allowPrivilegeEscalation: false
allowPrivilegedContainer: false
allowedCapabilities: null
defaultAddCapabilities: null
fsGroup:
  type: MustRunAs
priority: null
readOnlyRootFilesystem: false
requiredDropCapabilities:
- KILL
- MKNOD
- SETUID
- SETGID
runAsUser:
  type: MustRunAsNonRoot
seLinuxContext:
  type: MustRunAs
volumes:
- configMap
- downwardAPI
- emptyDir
- persistentVolumeClaim
- projected
- secret
seccompProfiles:
- 'runtime/default'
```

AppSSO controller's `ServiceAccount` is given the following additional permissions, including a `use` permission for AppSSO SCC, so `AuthServer` can use the custom SCC:

```
- apiGroups:
  - security.openshift.io
resources:
  - securitycontextconstraints
verbs:
  - "get"
  - "list"
  - "watch"
```

```
- apiGroups:
  - security.openshift.io
resourceNames:
  - appssso-scc
resources:
  - securitycontextconstraints
```

```
verbs:
  - "use"
```

Package configuration for Application Single Sign-On

In most cases, the Application Single Sign-on (commonly called AppSSO) package installation is configured by using the meta package installation of Tanzu Application Platform (commonly called TAP). The Tanzu Application Platform package has a `shared` top-level configuration key for sharing common configuration between the packages it installs.

Application Single Sign-on inherits the `shared.{ingress_domain, ingress_issuer, ca_cert_data, kubernetes_distribution}` configuration values from Tanzu Application Platform. You can override these values with Application Single Sign-On specific values under `appssso`. Application Single Sign-On specific configuration has precedence over the shared values of Tanzu Application Platform.

For example:

```
#!/ my-tap-values.yaml

shared:
# Shared configuration goes here.

appssso:
# AppSSO-specific configuration goes here.
```

Configuration values

The package installation of `sso.apps.tanzu.vmware.com` has the following configuration values:

`ca_cert_data`

You can configure trust for custom CAs by providing their certificates as a PEM bundle to `ca_cert_data`. As a result, all `AuthServers` trust your custom CAs.

This is useful if you have [Identity providers](#) serving certificates from a custom CA and [configuring AuthServer storage](#).

Alternatively, you can [configure trust for a single AuthServer](#).



Note

Application Single Sign-on specific `ca_cert_data` is concatenated with `shared.ca_cert_data`. The resulting PEM bundle contains both.

`cluster_resource_namespace`

This setting designates the target namespace when the cluster-scoped APIs reconcile into namespace-scoped resources.

In particular, the cluster-scoped `ClusterUnsafeTestLogin` reconciles into namespace-scoped resources such as an `AuthServer`. These resources are placed in the `cluster_resource_namespace`.

The default value of `cluster_resource_namespace` is `appssso`.



Note

Updating the `cluster_resource_namespace` of an existing package installation delete or create namespace-scoped resources in the new namespace. This causes downtime for the impacted resources momentarily.

`default_authserver_clusterissuer`

You can denote a `cert-manager.io/v1/ClusterIssuer` as a default issuer for `AuthServer.spec.tls.issuerRef` and omit `AuthServer.spec.tls`. When the value of `AuthServer.spec.tls.issuerRef` is the empty string "", no default issuer is assumed and no `AuthServer.spec.tls` is required.

If you configured `shared.ingress_issuer` and omitted `default_authserver_clusterissuer` while installing Tanzu Application Platform, Application Single Sign-on uses the ingress issuer of Tanzu Application Platform and sets `default_authserver_clusterissuer` to `shared.ingress_issuer`.

`default_workload_domain_template`

This is the default template from which `WorkloadRegistration` renders redirect URIs. It is used when `WorkloadRegistration.spec.workloadDomainTemplate` is omitted.

This is a go lang `text/template`. The default is "`{{.Name}}.{{.Namespace}}.{{.Domain}}`".

The domain template is applied with the configured `workload_domain_name` and the name and namespace specified in `WorkloadRegistration.spec.workloadRef`. For more information, see [Redirect URI templating](#).

VMware recommends maintaining consistency between the values of `default_workload_domain_template` and [Cloud Native Runtimes'](#) `domain_template`. Both values share the same default configuration. However, for customization purposes, using the same value for both settings ensures that `Workloads` get the expected redirect URIs templated.

`domain_name`

The Application Single Sign-on package has one required configuration value, its `domain_name`. It templates the issuer URI for `AuthServer`. `domain_name` must be the shared ingress domain of your Tanzu Application Platform package installation. If your Tanzu Application Platform installation is configured with `shared.ingress_domain`, Application Single Sign-on inherits the correct configuration.

If omitted, `domain_name` is set to `shared.ingress_domain`.

`domain_template`

You can customize how Application Single Sign-on template's `issuerURIs` with the `domain_template` configuration. This is a go lang `text/template`. The default value is "`{{.Name}}.{{.Namespace}}.{{.Domain}}`".

The domain template is applied with the given `domain_name` and the `AuthServer`'s name and namespace:

- `{{.Domain}}` evaluates to the configured `domain_name`
- `{{.Name}}` evaluates to `AuthServer.metadata.name`
- `{{.Namespace}}` evaluates to `AuthServer.metadata.namespace`

To use a wild-card certificate, consider "`{{.Name}}-{{.Namespace}}.{{.Domain}}`".

VMware recommends keeping the name and namespace sections of the template to avoid domain name collisions.

kubernetes_distribution

This setting toggles behavior for specific Kubernetes distributions. Currently, the only supported values are "" and `openshift`.

It is processed in combination with `kubernetes_version`.

Application Single Sign-On installs OpenShift specific RBAC and resources. For more information, see [Application Single Sign-On for OpenShift clusters](#).

If omitted, `kubernetes_distribution` is set to `shared.kubernetes_distribution`.

kubernetes_version

This setting toggles behavior for specific Kubernetes distributions. Currently, the only supported values are "" or semantic versions in the form of `\d*\.\d*\.\d*`.

It is processed in combination with `kubernetes_distribution`.

Application Single Sign-On installs OpenShift specific RBAC and resources. For more information, see [Application Single Sign-On for OpenShift clusters](#).

If omitted, `kubernetes_version` is set to `shared.kubernetes_version`.

workload_domain_name

This is used as the value for `{{.Domain}}` in `WorkloadRegistration`'s domain template.

`workload_domain_name` defaults to the value of `domain_name`.

In most cases, the value of `workload_domain_name` matches the value of `Cloud Native Runtimes'` `domain_name`.

replicas

The controller is run with this many replicas. The default value is `1`.

The controller uses leader election so that there is only a single active replica at a time. Increasing this value does not improve the controller's performance.

resources

This is the value for the controller's `Deployment.spec.template.spec.containers[0].resources`.

See [Configuration schema](#) for more information about its structure and default values.

resync_period

This is the duration after which the controller re-synchronizes all resources. That means that every instance of a Application Single Sign-On API is reconciled at this point.

The default value is `2h`.

VMware does not recommend customizing this value in all practical scenarios.

Configuration schema

The package installation of `sso.apps.tanzu.vmware.com` has the following configuration schema:

```
---
#@schema/desc "Optional: Kubernetes platform distribution that this package is being installed on. Accepted values: ['', 'openshift']"
```

```

kubernetes_distribution: ""

#@schema/desc "Optional: Kubernetes platform version that this package is being installed on. Accepted format: ['x.x.x']"
kubernetes_version: ""

#@schema/desc "Domain name for AuthServers."
domain_name: "example.com"

#@schema/desc "Optional: Golang template/text string for constructing AuthServer FQDNs."
domain_template: "{{.Name}}.{{.Namespace}}.{{.Domain}}"

#@schema/desc "Optional: A cert-manager.io/v1/ClusterIssuer for defaulting AuthServer TLS."
default_authserver_clusterissuer: ""

#@schema/desc "Optional: Domain name for Workloads. Defaults to the value of domain_name."
workload_domain_name: ""

#@schema/desc "Optional: Golang template/text string for defaulting Workload FQDNs templating."
default_workload_domain_template: "{{.Name}}.{{.Namespace}}.{{.Domain}}"

#@schema/desc "The namespace which children of cluster-scoped resources are located in."
cluster_resource_namespace: "appsso"

#@schema/desc "Optional: PEM-encoded certificate data for AuthServers to trust TLS connections with a custom CA."
ca_cert_data: ""

#@schema/desc "Optional: Interval at which the controller will re-synchronize applied resources."
resync_period: "2h"

#@schema/desc "Optional: Number of controller replicas to deploy."
replicas: 1

#@schema/desc "Optional: Resource requirements of the controller deployment."
resources:
  requests:
    #@schema/desc "CPU request of the controller."
    cpu: "20m"
    #@schema/desc "Memory request of the controller."
    memory: "100Mi"
  limits:
    #@schema/desc "CPU limit of the controller."
    cpu: "500m"
    #@schema/desc "Memory limit of the controller."
    memory: "500Mi"

```

RBAC for AppSSO

The Application Single Sign-On (commonly called AppSSO) package aggregates the following permissions into Tanzu Application Platform's well-known roles. For more information, see [Role descriptions for Tanzu Application Platform](#).

User aggregated rules

app-operator

```

apiGroups:
  - sso.apps.tanzu.vmware.com
resources:
  - clientregistrations
  - workloadregistrations
verbs:
  - '*'

```

app-editor

```

apiGroups:
  - sso.apps.tanzu.vmware.com
resources:
  - clientregistrations
  - workloadregistrations
verbs:
  - get
  - list
  - watch

```

app-viewer

```

apiGroups:
  - sso.apps.tanzu.vmware.com
resources:
  - clientregistrations
  - workloadregistrations
verbs:
  - get
  - list
  - watch

```

service-operator

```

apiGroups:
  - sso.apps.tanzu.vmware.com
resources:
  - authservers
  - clusterunsafetestlogins
  - clusterworkloadregistrationclasses
verbs:
  - '*'

```

Controller

To manage the life cycle of AppSSO's [APIs](#), the AppSSO controller's [ServiceAccount](#) has a [ClusterRole](#) with the following permissions:

```

- apiGroups:
  - sso.apps.tanzu.vmware.com
  resources:
    - authservers
    - clientregistrations
    - clusterunsafetestlogins
    - clusterworkloadregistrationclasses
    - workloadregistrations
  verbs:
    - '*'
- apiGroups:
  - sso.apps.tanzu.vmware.com

```

```

resources:
  - authservers/status
  - clientregistrations/status
  - clusterunsafetestlogins/status
  - clusterworkloadregistrationclasses/status
  - workloadregistrations/status
verbs:
  - patch
  - update
- apiGroups:
  - sso.apps.tanzu.vmware.com
resources:
  - authservers/finalizers
  - clientregistrations/finalizers
  - clusterunsafetestlogins/finalizers
  - clusterworkloadregistrationclasses/finalizers
  - workloadregistrations/finalizers
verbs:
  - '*'
- apiGroups:
  - ""
resources:
  - events
verbs:
  - create
  - update
  - patch
- apiGroups:
  - coordination.k8s.io
resources:
  - leases
verbs:
  - create
  - get
  - update
- apiGroups:
  - ""
resources:
  - secrets
  - configmaps
  - services
  - serviceaccounts
verbs:
  - '*'
- apiGroups:
  - apps
resources:
  - deployments
verbs:
  - '*'
- apiGroups:
  - rbac.authorization.k8s.io
resources:
  - roles
  - rolebindings
verbs:
  - '*'
- apiGroups:
  - cert-manager.io
resources:
  - certificates
  - issuers
verbs:
  - '*'
- apiGroups:
  - cert-manager.io

```

```

resources:
  - clusterissuers
verbs:
  - get
  - list
  - watch
- apiGroups:
  - networking.k8s.io
resources:
  - ingresses
verbs:
  - '*'
- apiGroups:
  - servicebinding.io
resources:
  - servicebindings
verbs:
  - '*'
- apiGroups:
  - services.apps.tanzu.vmware.com
resources:
  - clusterinstanceclasses
verbs:
  - '*'
- apiGroups:
  - services.apps.tanzu.vmware.com
resources:
  - clusterinstanceclasses
verbs:
  - '*'
- apiGroups:
  - apiextensions.crossplane.io
resources:
  - compositions
verbs:
  - '*'

```

AppSSO also installs OpenShift specific RBAC and resources. For more information, see [Application Single Sign-On for OpenShift clusters](#).

AuthServer audit logs for AppSSO

This topic tells you how to use `AuthServer` audit logs in Application Single Sign-On (commonly called AppSSO).

Overview

`AuthServer`s perform the following tasks:

- Handle user authentication
- Issue `id_token` and `access_token`

Each audit event contains the following information:

- `ts` - date/time of the event
- `remoteIpAddress` - the IP of the user-authentication or if not attainable, the IP of the last proxy

Authentication

`AuthServer` produce the following authentication events:

- `AUTHENTICATION_SUCCESS`
 - **Trigger** successful authentication
 - **Data recorded** Username, Provider ID, Provider Type (INTERNAL, OPENID, ...)
- `AUTHENTICATION_LOGOUT`
 - **Trigger** successful logout
 - **Data recorded** Username, Provider ID, Provider Type (INTERNAL, OPENID, ...)
- `AUTHENTICATION_FAILURE`
 - **Trigger** failed authentication using either `internalUnsafe` or `ldap` identity provider
 - **Data recorded** Username, Provider ID, Provider Type (INTERNAL or LDAP)
- `INVALID_IDENTITY_PROVIDER_CONFIGURATION`
 - **Trigger** some cases of failed authentication with an `openId` or `saml` identity provider
 - **Data recorded** Provider ID, Provider Type, error
 - **Note** usually followed by a human-readable help message, with `"logger": "appsso.help"`

Token flows

`AuthServer` produce the following `authorization_code` and token events:

- `AUTHORIZATION_CODE_ISSUED`
 - **Trigger** `authorization_code` grant type, successful call to `/oauth2/authorize`
 - **Data recorded** Username, Provider ID, Provider Type, Client ID, Scopes requested, Redirect URI
- `AUTHORIZATION_CODE_REQUEST_REJECTED`
 - **Trigger** `authorization_code` grant type, unsuccessful call to `/oauth2/authorize`, for example invalid Client ID, invalid Redirect URI, ...
 - **Data recorded** Error, Error Code (ex: `invalid_scope`), Client ID, Scopes requested Redirect URI, Username (may be `anonymousUser`), Provider ID and Provider Type if available
- `TOKEN_ISSUED`
 - **Trigger** successful call to `/oauth2/token`
 - **Data recorded** Scopes, Client ID, Grant Type (`authorization_code` or `client_credentials`), Username
- `TOKEN_REQUEST_REJECTED`
 - **Trigger** unsuccessful call to `/oauth2/token`, for example invalid Client Secret
 - **Data recorded** Client ID, Scopes requested, Error

Overview of Default roles for Tanzu Application Platform

Tanzu Application Platform (commonly known as TAP) v1.6 includes:

- Six default roles to help you set up permissions for users and [service accounts](#) within a namespace on a cluster that runs one of the Tanzu Application Platform profiles.
- A Tanzu CLI RBAC (role-based access control) plug-in for role binding. For more information, see [Bind a user or group to a default role](#).
- Documentation for [integrating with your existing identity management solution](#).

Default roles

Four roles are for users:

- app-editor
- app-viewer
- app-operator
- service-operator

Two roles are for service accounts associated with the Tanzu Supply Chain:

- workload
- deliverable

The default roles provide an opinionated starting point for the most common permissions that users need when using Tanzu Application Platform. However, as described in the [Kubernetes documentation](#) about RBAC, you can create customized roles and permissions that better meet your needs. Aggregated cluster roles are used to build VMware Tanzu Application Platform default roles.

Cluster admins must be careful when creating Roles or ClusterRoles. When changing roles or adding new roles that carry one of the labels used by the default roles, the roles are automatically updated to the aggregation state. It can lead to unintentional changes in functions and permissions to all users.

The default roles are installed with every Tanzu Application Platform profile except for `view`. For an overview of the different roles and their permissions, see [Role Descriptions](#).

Working with roles using the RBAC CLI plug-in

For more information about working with roles, see [Bind a user or group to a default role](#).

Disclaimer

[Tanzu Developer Portal](#) (formerly named Tanzu Application Platform GUI) does not make use of the described roles. Instead, it provides the user with view access for each cluster.

Overview of Default roles for Tanzu Application Platform

Tanzu Application Platform (commonly known as TAP) v1.6 includes:

- Six default roles to help you set up permissions for users and [service accounts](#) within a namespace on a cluster that runs one of the Tanzu Application Platform profiles.
- A Tanzu CLI RBAC (role-based access control) plug-in for role binding. For more information, see [Bind a user or group to a default role](#).
- Documentation for [integrating with your existing identity management solution](#).

Default roles

Four roles are for users:

- app-editor
- app-viewer
- app-operator

- service-operator

Two roles are for service accounts associated with the Tanzu Supply Chain:

- workload
- deliverable

The default roles provide an opinionated starting point for the most common permissions that users need when using Tanzu Application Platform. However, as described in the [Kubernetes documentation](#) about RBAC, you can create customized roles and permissions that better meet your needs. Aggregated cluster roles are used to build VMware Tanzu Application Platform default roles.

Cluster admins must be careful when creating Roles or ClusterRoles. When changing roles or adding new roles that carry one of the labels used by the default roles, the roles are automatically updated to the aggregation state. It can lead to unintentional changes in functions and permissions to all users.

The default roles are installed with every Tanzu Application Platform profile except for `view`. For an overview of the different roles and their permissions, see [Role Descriptions](#).

Working with roles using the RBAC CLI plug-in

For more information about working with roles, see [Bind a user or group to a default role](#).

Disclaimer

[Tanzu Developer Portal](#) (formerly named Tanzu Application Platform GUI) does not make use of the described roles. Instead, it provides the user with view access for each cluster.

Set up authentication for your Tanzu Application Platform deployment

There are multiple ways to set up authentication for your Tanzu Application Platform (commonly known as TAP) deployment. You can manage authentication at the infrastructure level with your Kubernetes provider, such as Tanzu Kubernetes Grid, EKS, AKS, or GKE.

VMware recommends Pinniped for integrating your identity management into Tanzu Application Platform on multicloud. It provides many supported integrations for widely used identity providers. To use Pinniped, see [Installing Pinniped on Tanzu Application Platform](#) and [Log in by using Pinniped](#).

See [Integrating Azure Active Directory](#) for Azure Active Directory Integration.

Tanzu Kubernetes Grid

For Tanzu Kubernetes Grid clusters, Pinniped is the default identity solution and is installed as a core package. For more information, see [Core Packages](#) and [Enable Identity Management in an Existing Deployment](#) in the Tanzu Kubernetes Grid documentation.

Set up authentication for your Tanzu Application Platform deployment

There are multiple ways to set up authentication for your Tanzu Application Platform (commonly known as TAP) deployment. You can manage authentication at the infrastructure level with your Kubernetes provider, such as Tanzu Kubernetes Grid, EKS, AKS, or GKE.

VMware recommends Pinniped for integrating your identity management into Tanzu Application Platform on multicloud. It provides many supported integrations for widely used identity providers. To use Pinniped, see [Installing Pinniped on Tanzu Application Platform](#) and [Log in by using Pinniped](#).

See [Integrating Azure Active Directory](#) for Azure Active Directory Integration.

Tanzu Kubernetes Grid

For Tanzu Kubernetes Grid clusters, Pinniped is the default identity solution and is installed as a core package. For more information, see [Core Packages](#) and [Enable Identity Management in an Existing Deployment](#) in the Tanzu Kubernetes Grid documentation.

Install Pinniped on Tanzu Application Platform

[Pinniped](#) is used to support authentication on Tanzu Application Platform (commonly known as TAP). This topic tells you how to install Pinniped on a single cluster of Tanzu Application Platform.



Note

This topic only provides an example of one possible installation method for Pinniped on Tanzu Application Platform by using the default Contour ingress controller included in the platform. See [Pinniped documentation](#) for more information about the specific installation method that suits your environment.

Use this topic to learn how to deploy two Pinniped components into the cluster:

- **Pinniped Supervisor:** An OIDC server which allows users to authenticate with an external identity provider (IDP). It hosts an API for the concierge component to fulfill authentication requests.
- **Pinniped Concierge:** A credential exchange API that takes a credential from an identity source, for example, Pinniped Supervisor, proprietary IDP, as input. The Pinniped Concierge authenticates the user by using the credential, and returns another credential that is parsable by the host Kubernetes cluster or by an impersonation proxy that acts on behalf of the user.

Prerequisites

Meet these prerequisites:

- Install the package `certmanager`. This is included in Tanzu Application Platform.
- Install the package `contour`. This is included in Tanzu Application Platform.
- Create a `workspace` directory to function as your workspace.

Environment planning

If you run Tanzu Application Platform on a single cluster, both Pinniped Supervisor and Pinniped Concierge are installed to this cluster.

When running a multicluster setup, you must decide which cluster to deploy the Supervisor onto. Furthermore, every cluster must have the Concierge deployed. Pinniped Supervisor runs as a central component that is consumed by multiple Pinniped Concierge instances. As a result, Pinniped Supervisor must be deployed to a single cluster that meets the [prerequisites](#). You can deploy Pinniped Supervisor to the View Cluster of your Tanzu Application Platform, because it is a

central single instance cluster. For more information, see [Overview of multicluster Tanzu Application Platform](#).

You must deploy the Pinniped Concierge to every cluster that you want to enable authentication for, including the View Cluster itself.

See the following diagram for a possible deployment model:

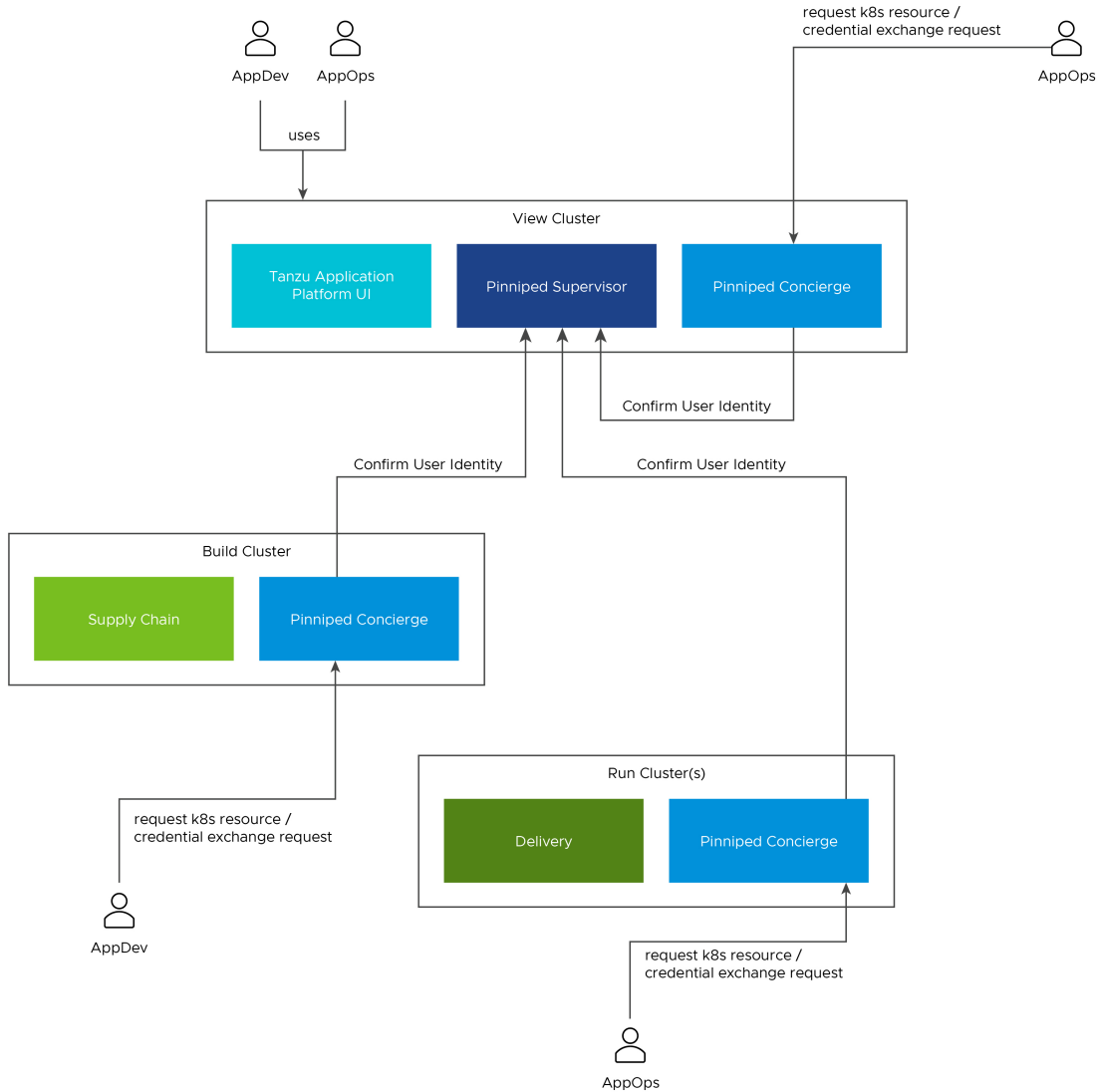

For more information about the Pinniped architecture and deployment model, see [Pinniped documentation](#).

Install Pinniped Supervisor by using Let's Encrypt

Follow these steps to install `pinniped-supervisor`:

1. Switch tooling to the desired cluster.
2. Create the necessary certificate files.
3. Create the Ingress resources.
4. Create the `pinniped-supervisor` configuration.
5. Apply these resources to the cluster.

Create Certificates (`letsencrypt` or `cert-manager`)

Choose a fully qualified domain name (FQDN) that can resolve to the Contour instance in the `tanzu-system-ingress` namespace. The FQDN `pinniped-supervisor.example.com` is used in the following sections.

Create a `ClusterIssuer` for `letsencrypt` and a TLS certificate resource for Pinniped Supervisor by creating the following resources and saving them into `workspace/pinniped-supervisor/certificates.yaml`:

```
---
apiVersion: cert-manager.io/v1
kind: ClusterIssuer
metadata:
  name: letsencrypt-staging
  namespace: cert-manager
spec:
  acme:
    email: "EMAIL"
    privateKeySecretRef:
      name: letsencrypt-staging
    server: https://acme-staging-v02.api.letsencrypt.org/directory
    solvers:
    - http01:
        ingress:
          class: contour
---
apiVersion: cert-manager.io/v1
kind: Certificate
metadata:
  name: pinniped-supervisor-cert
  namespace: pinniped-supervisor
spec:
  secretName: pinniped-supervisor-tls-cert
  dnsNames:
  - "DNS-NAME"
  issuerRef:
    name: letsencrypt-staging
    kind: ClusterIssuer
```

Where:

- `EMAIL` is the user email address for `letsencrypt`. For example, `your-mail@example.com`
- `DNS-NAME` is the domain in which the `pinniped-supervisor` is published. For example, `pinniped-supervisor.example.com`

Create Ingress resources

Create a Service and Ingress resource to make the `pinniped-supervisor` accessible from outside the cluster.

To do so, create the following resources and save them into `workspace/pinniped-supervisor/ingress.yaml`:

```
---
apiVersion: v1
kind: Service
metadata:
  name: pinniped-supervisor
  namespace: pinniped-supervisor
spec:
  ports:
  - name: pinniped-supervisor
    port: 8443
```

```

protocol: TCP
targetPort: 8443
selector:
  app: pinniped-supervisor

---
apiVersion: projectcontour.io/v1
kind: HTTPProxy
metadata:
  name: pinniped-supervisor
  namespace: pinniped-supervisor
spec:
  virtualhost:
    fqdn: "DNS-NAME"
    tls:
      passthrough: true
  routes:
  - services:
    - name: pinniped-supervisor
      port: 8443

```

Where:

- `DNS-NAME` is the domain in which the `pinniped-supervisor` is published. For example, `pinniped-supervisor.example.com`
- `tls.passthrough: true` specifies that the TLS connection is forwarded to and terminated in the supervisor pod.

Create the `pinniped-supervisor` configuration

Create a `FederationDomain` to link the concierge to the supervisor instance and configure an `OIDCIdentityProvider` to connect the supervisor to your OIDC Provider. The following example uses `auth0` as the `OIDCIdentityProvider`. For more information about how to configure different identity providers, including OKTA, GitLab, OpenLDAP, Dex, Microsoft AD and more, see [Pinniped documentation](#).

To create the `pinniped-supervisor` configuration, create the following resources and save them into `workspace/pinniped-supervisor/oidc_identity_provider.yaml`:

```

apiVersion: idp.supervisor.pinniped.dev/v1alpha1
kind: OIDCIdentityProvider
metadata:
  namespace: pinniped-supervisor
  name: auth0
spec:
  # Specify the upstream issuer URL associated with your auth0 application.
  issuer: https://"APPLICATION-SUBDOMAIN".auth0.com/

  # Specify how to form authorization requests.
  authorizationConfig:
    additionalScopes: ["openid", "email"]
    allowPasswordGrant: false

  # Specify how claims are mapped to Kubernetes identities. This varies by provider.
  claims:
    username: email
    groups: groups

  # Specify the name of the Kubernetes Secret that contains your
  # application's client credentials (created as follows).
  client:
    secretName: auth0-client-credentials

```

```

---
apiVersion: v1
kind: Secret
metadata:
  namespace: pinniped-supervisor
  name: auth0-client-credentials
type: secrets.pinniped.dev/oidc-client
stringData:
  clientID: "AUTH0-CLIENT-ID"
  clientSecret: "AUTH0-CLIENT-SECRET"

---
apiVersion: config.supervisor.pinniped.dev/v1alpha1
kind: FederationDomain
metadata:
  name: pinniped-supervisor-federation-domain
  namespace: pinniped-supervisor
spec:
  issuer: "DNS-NAME"
  tls:
    secretName: pinniped-supervisor-tls-cert

```

Where:

- `APPLICATION-SUBDOMAIN` is the application specific subdomain that is assigned after the application registration.
- `AUTH0-CLIENT-ID` and `AUTH0-CLIENT-SECRET` are the credentials retrieved from the application registration.
- `DNS-NAME` is the domain in which the `pinniped-supervisor` is published. For example, `pinniped-supervisor.example.com`

Apply the resources

After creating the resource files, you can install them into the cluster. Follow these steps to deploy them as a `kapp` application:

1. Install the `pinniped-supervisor` by running:

```
kapp deploy -y --app pinniped-supervisor -f pinniped-supervisor -f https://get.pinniped.dev/v0.22.0/install-pinniped-supervisor.yaml
```



Note

To keep the security patches up to date, you must install the most recent version of Pinniped. See [Vmware Tanzu Pinniped Releases](#) in GitHub for more information.

2. Get the external IP address of Ingress by running:

```
kubectl -n tanzu-system-ingress get svc/envoy -o jsonpath='{.status.loadBalancer.ingress[0].ip}'
```

3. If not already covered by the Tanzu Application Platform wildcard DNS entry, add an entry to the DNS system to bind the external IP address with.

Switch to production issuer (`letsencrypt` or `cert-manager`)

Follow these steps to switch to a `letsencrypt` production issuer so the generated TLS certificate is recognized as valid by web browsers and clients:

1. Edit the ClusterIssuer for `letsencrypt` and add TLS certificate resource for `pinniped-supervisor` by creating or updating the following resources and saving them into `workspace/pinniped-supervisor/certificates.yaml`:

```
---
apiVersion: cert-manager.io/v1
kind: ClusterIssuer
metadata:
  name: letsencrypt-prod
  namespace: cert-manager
spec:
  acme:
    server: https://acme-v02.api.letsencrypt.org/directory
    email: "EMAIL"
    privateKeySecretRef:
      name: letsencrypt-prod
    solvers:
    - http01:
        ingress:
          class: contour
---
apiVersion: cert-manager.io/v1
kind: Certificate
metadata:
  name: pinniped-supervisor-cert
  namespace: pinniped-supervisor
spec:
  secretName: pinniped-supervisor-tls-cert
  dnsNames:
  - "DNS-NAME"
  issuerRef:
    name: letsencrypt-prod
    kind: ClusterIssuer
```

Where:

- `EMAIL` is the user email address for `letsencrypt`. For example, `your-mail@example.com`
- `DNS-NAME` is the domain in which the `pinniped-supervisor` is published. For example, `pinniped-supervisor.example.com`

2. Create or update the `pinniped-supervisor` kapp application:

```
kapp deploy -y --app pinniped-supervisor -f pinniped-supervisor -f https://get.pinniped.dev/v0.22.0/install-pinniped-supervisor.yaml
```

Install Pinniped Supervisor Private CA

Follow these steps to install `pinniped-supervisor`:

1. Switch tooling to the desired cluster.
2. Create the necessary certificate files.
3. Create the Ingress resources.
4. Create the `pinniped-supervisor` configuration.
5. Apply these resources to the cluster.

Create Certificate Secret

Choose a fully qualified domain name (FQDN) that can resolve to the Contour instance in the `tanzu-system-ingress` namespace. Create a certificate by using a CA that the clients trust. This FQDN can be under the `ingress_domain` in the TAP values file, or a dedicated DNS entry. The FQDN `pinniped-supervisor.example.com` is used in the following sections.

After the certificate files are available, they must be encoded to base64 format in a single-line layout. For example, you can encode the certificate file `my.crt` by running:

```
cat my.crt | base64 -w 0
```

Create the following resource and save it into `workspace/pinniped-supervisor/ingress.yaml`:

```
---
apiVersion: v1
kind: Secret
metadata:
  name: pinniped-supervisor-tls-cert
  namespace: pinniped-supervisor
type: kubernetes.io/tls
data:
  tls.crt: PRIVATE-KEY
  tls.key: PUBLIC-KEY
```

Where:

- `PRIVATE-KEY` is the base64 encoded public key.
- `PUBLIC-KEY` is the base64 encoded public key.

Create Ingress resources

Create a Service and Ingress resource to make the `pinniped-supervisor` accessible from outside the cluster.

To do so, create the following resources and save them into `workspace/pinniped-supervisor/ingress.yaml`:

```
---
apiVersion: v1
kind: Service
metadata:
  name: pinniped-supervisor
  namespace: pinniped-supervisor
spec:
  ports:
    - name: pinniped-supervisor
      port: 8443
      protocol: TCP
      targetPort: 8080
  selector:
    app: pinniped-supervisor

---
apiVersion: projectcontour.io/v1
kind: HTTPProxy
metadata:
  name: pinniped-supervisor
  namespace: pinniped-supervisor
spec:
  virtualhost:
    fqdn: "DNS-NAME"
  tls:
```

```

    passthrough: true
  routes:
  - services:
    - name: pinniped-supervisor
      port: 8443

```

Where:

- `DNS-NAME` is the domain in which the `pinniped-supervisor` is published. For example, `pinniped-supervisor.example.com`
- `tls.passthrough: true` specifies that the TLS connection is forwarded to and terminated in the supervisor pod.

Create the `pinniped-supervisor` configuration

Create a `FederationDomain` to link the concierge to the supervisor instance and configure an `OIDCIdentityProvider` to connect the supervisor to your OIDC Provider. The following example uses `auth0` as the `OIDCIdentityProvider`. For more information about how to configure different identity providers, including OKTA, GitLab, OpenLDAP, Dex, Microsoft AD and more, see [Pinniped documentation](#).

To create the `pinniped-supervisor` configuration, create the following resources and save them into `workspace/pinniped-supervisor/oidc_identity_provider.yaml`:

```

apiVersion: idp.supervisor.pinniped.dev/v1alpha1
kind: OIDCIdentityProvider
metadata:
  namespace: pinniped-supervisor
  name: auth0
spec:
  # Specify the upstream issuer URL associated with your auth0 application.
  issuer: https://"APPLICATION-SUBDOMAIN".auth0.com/

  # Specify how to form authorization requests.
  authorizationConfig:
    additionalScopes: ["openid", "email"]
    allowPasswordGrant: false

  # Specify how claims are mapped to Kubernetes identities. This varies by provider.
  claims:
    username: email
    groups: groups

  # Specify the name of the Kubernetes Secret that contains your
  # application's client credentials (created as follows).
  client:
    secretName: auth0-client-credentials

---
apiVersion: v1
kind: Secret
metadata:
  namespace: pinniped-supervisor
  name: auth0-client-credentials
type: secrets.pinniped.dev/oidc-client
stringData:
  clientID: "AUTH0-CLIENT-ID"
  clientSecret: "AUTH0-CLIENT-SECRET"

---
apiVersion: config.supervisor.pinniped.dev/v1alpha1
kind: FederationDomain
metadata:

```

```

name: pinniped-supervisor-federation-domain
namespace: pinniped-supervisor
spec:
  issuer: "DNS-NAME"
  tls:
    secretName: pinniped-supervisor-tls-cert

```

Where:

- `APPLICATION-SUBDOMAIN` is the application specific subdomain that is assigned after the application registration.
- `AUTH0-CLIENT-ID` and `AUTH0-CLIENT-SECRET` are the credentials retrieved from the application registration.
- `DNS-NAME` is the domain in which the pinniped-supervisor is published. For example, `pinniped-supervisor.example.com`

Apply the resources

After creating the resource files, you can install them into the cluster. Follow these steps to deploy them as a `kapp` application:

1. Install the supervisor by running:

```
kapp deploy -y --app pinniped-supervisor -f pinniped-supervisor -f https://get.pinniped.dev/v0.22.0/install-pinniped-supervisor.yaml
```



Note

To keep the security patches up to date, you must install the most recent version of Pinniped. See [Vmware Tanzu Pinniped Releases](#) in GitHub for more information.

2. Get the external IP address of Ingress by running:

```
kubectl -n tanzu-system-ingress get svc/envoy -o jsonpath='{.status.loadBalancer.ingress[0].ip}'
```

3. If not already covered by a Tanzu Application Platform wildcard DNS entry, add an entry to the DNS system to bind the external IP address with.

Install Pinniped Concierge

To install Pinniped Concierge:

1. Switch tooling to the desired cluster.
2. Deploy the Pinniped Concierge by running:

```
kapp deploy -y --app pinniped-concierge \
-f https://get.pinniped.dev/v0.22.0/install-pinniped-concierge.yaml
```

3. Get the CA certificate of the supervisor by running the following command against the cluster running the `pinniped-supervisor`:

```
kubectl get secret pinniped-supervisor-tls-cert -n pinniped-supervisor -o 'go-template={{index .data "tls.crt"}}'
```

**Note**

The `tls.crt` contains the entire certificate chain including the CA certificate for `letsencrypt` generated certificates.

4. Create the following resource to `workspace/pinniped-concierge/jwt_authenticator.yaml`:

```
---
apiVersion: authentication.concierge.pinniped.dev/v1alpha1
kind: JWTAuthenticator
metadata:
  name: pinniped-jwt-authenticator
spec:
  issuer: "DNS-NAME"
  audience: concierge
  tls:
    certificateAuthorityData: "CA-DATA"
```

If you use the `letsencrypt` production issuer, you can omit the `tls` section:

```
---
apiVersion: authentication.concierge.pinniped.dev/v1alpha1
kind: JWTAuthenticator
metadata:
  name: pinniped-jwt-authenticator
spec:
  issuer: "DNS-NAME"
  audience: concierge
```

Where:

- `DNS-NAME` is the domain in which the `pinniped-supervisor` is published. For example, `pinniped-supervisor.example.com`
- `CA-DATA` is the public key of the signing CA or the public key of the Pinniped http proxy certificate.

5. Deploy the resource by running:

```
kapp deploy -y --app pinniped-concierge-jwt --into-ns pinniped-concierge -f pinniped-concierge/jwt_authenticator.yaml
```

Log in to the cluster

See [Log in by using Pinniped](#).

Integrate your Azure Active Directory

This topic tells you how to integrate your Azure Active Directory (commonly known as AD).

Integrate Azure AD with a new or existing AKS without Pinniped

Perform the following procedures to integrate Azure AD with a new or existing AKS without Pinniped.

Prerequisites

Meet these prerequisites:

- Download and install the [Azure CLI](#)
- Download and install the [Tanzu CLI](#)
- Download and install the [Tanzu CLI RBAC plug-in](#)

Set up a platform operator

To set up a platform operator:

1. Navigate to the **Azure Active Directory Overview** page.
2. Select **Groups** under the **Manage** side menu.
3. Identify or create an admin group for the AKS cluster.
4. Retrieve the object ID of the admin group.
5. Take one of the following actions.
 - Create an AKS Cluster with Azure AD enabled by running:

```
az group create --name RESOURCE-GROUP --location LOCATION
az aks create -g RESOURCE-GROUP -n MANAGED-CLUSTER --enable-aad --aad-admin-group-object-ids OBJECT-ID
```

Where:

- **RESOURCE-GROUP** is your resource group
 - **LOCATION** is your location
 - **MANAGED-CLUSTER** is your managed cluster
 - **OBJECT-ID** is the object ID
- Enable Azure AD integration on the existing cluster by running:

```
az aks update -g RESOURCE-GROUP -n MANAGED-CLUSTER --enable-aad --aad-admin-group-object-ids OBJECT-ID
```

Where:

- **RESOURCE-GROUP** is your resource group
 - **MANAGED-CLUSTER** is your managed cluster
 - **OBJECT-ID** is the object ID
6. Add **Platform Operators** to the admin group.
 7. Log in to the AKS cluster by running:

```
az aks get-credentials --resource-group RESOURCE-GROUP --name MANAGED-CLUSTER -admin
```

Where:

- **RESOURCE-GROUP** is your resource group
- **MANAGED-CLUSTER** is your managed cluster

Set up a Tanzu Application Platform default role group

To set up a Tanzu Application Platform default role group:

1. Navigate to the **Azure Active Directory Overview** page.

2. Select **Groups** under the **Manage** side menu.
3. Identify or create a list of groups in the Azure AD for each of the Tanzu Application Platform default roles (`app-operator`, `app-viewer`, and `app-editor`).
4. Retrieve the corresponding object IDs for each group.
5. Add users to the groups accordingly.
6. For each object ID retrieved earlier, use the Tanzu CLI RBAC plug-in to bind the `object id` group to a role by running:

```
tanzu rbac binding add -g OBJECT-ID -r TAP-ROLE -n NAMESPACE
```

Where:

- `OBJECT-ID` is the object ID
- `TAP-ROLE` is the Tanzu Application Platform role
- `NAMESPACE` is the namespace

Set up kubeconfig

To set up kubeconfig:

1. Set up the `kubeconfig` to point to the AKS cluster by running:

```
az aks get-credentials --resource-group RESOURCE-GROUP --name MANAGED-CLUSTER
```

Where:

- `RESOURCE-GROUP` is your resource group
- `MANAGED-CLUSTER` is your managed cluster

2. Run any kubectl command to trigger a browser login. For example:

```
kubectl get pods
```

Integrate Azure AD with Pinniped

Perform the following procedures to set up Azure AD with Pinniped.

Prerequisites

Meet these prerequisites:

- Download and install the [Tanzu CLI](#)
- Download and install the [Tanzu CLI RBAC plug-in](#)
- Install [Pinniped supervisor and concierge](#) on the cluster without setting up the [OIDCIdentityProvider](#) and [secret](#).

Set up the Azure AD app

To set up the Azure AD app:

1. Navigate to the **Azure Active Directory Overview** page.
2. Select **App registrations** under the **Manage** side menu.
3. Select **New Registration**.
4. Enter the name of the application. For example, `gke-pinniped-supervisor-app`.

5. Under **Supported account types**, select **Accounts in this organisational directory only (VMware, Inc. only - Single tenant)**.
6. Under **Redirect URI**, select **Web** as the platform.
7. Enter the call URI to the supervisor. For example, <https://pinniped-supervisor.example.com/callback>.
8. Select **Register** to create the app.
9. If not already redirected, navigate to the app settings page.
10. Select **Token configuration** under the **Manage** menu.
11. Select **Add groups claim > All groups (includes distribution lists but not groups assigned to the application)**.
12. Select **Add** to create the group claim.
13. Select the app name in the breadcrumb navigation to return to the app settings page.
14. Select the **Endpoints** tab and record the value in the **OpenID Connect metadata document** field.
15. Return to the app settings page.
16. Record the **Application (client) ID**.
17. Select **Certificates & secrets** under the **Manage** menu.
18. Create a new client secret and record this value.
19. Add the following YAML to [oidc_identity_provider.yaml](#).

```

---
apiVersion: idp.supervisor.pinniped.dev/v1alpha1
kind: OIDCIdentityProvider
metadata:
  namespace: pinniped-supervisor
  name: azure-ad
spec:
  # Specify the upstream issuer URL.
  issuer: ISSUER-URL

  authorizationConfig:
    additionalScopes: ["openid", "email", "profile"]
    allowPasswordGrant: false

  # Specify how claims are mapped to Kubernetes identities.
  claims:
    username: preferred_username
    groups: groups

  # Specify the name of the Kubernetes Secret that contains your
  # application's client credentials (created below).
  client:
    secretName: azure-ad-client-credentials
---
apiVersion: v1
kind: Secret
metadata:
  namespace: pinniped-supervisor
  name: azure-ad-client-credentials
type: secrets.pinniped.dev/oidc-client
stringData:
  clientID: "AZURE-AD-CLIENT-ID"
  clientSecret: "AZURE-AD-CLIENT-SECRET"

```

Where:

- `ISSUER-URL` is the OpenID Connect metadata document URL you recorded earlier, but without the trailing `/.well-known/openid-configuration`
- `AZURE-AD-CLIENT-ID` is the Azure AD client ID you recorded earlier
- `AZURE-AD-CLIENT-SECRET` is the Azure AD client secret you recorded earlier

20. Apply your changes from the kubectl CLI by running:

```
kubectl apply workspace/pinniped-supervisor/oidc_identity_provider.yaml
```

Set up the Tanzu Application Platform default role group

To set up a Tanzu Application Platform default role group:

1. Navigate to the **Azure Active Directory Overview** page.
2. Select **Groups** under the **Manage** side menu.
3. Identify or create a list of groups in the Azure AD for each of the Tanzu Application Platform default roles (`app-operator`, `app-viewer`, and `app-editor`).
4. Retrieve the corresponding object IDs for each group.
5. Add users to the groups accordingly.
6. For each object ID retrieved earlier, use the Tanzu CLI RBAC plug-in to bind the `object id` group to a role by running:

```
tanzu rbac binding add -g OBJECT-ID -r TAP-ROLE -n NAMESPACE
```

Where:

- `OBJECT-ID` is the object ID
- `TAP-ROLE` is the Tanzu Application Platform role
- `NAMESPACE` is the namespace

Set up kubeconfig

Follow these steps to set up kubeconfig:

1. Set up `kubeconfig` using the Pinniped CLI by running:

```
pinniped get kubeconfig --kubeconfig-context YOUR-KUBECONFIG-CONTEXT > /tmp/concierge-kubeconfig
```

Where `YOUR-KUBECONFIG-CONTEXT` is your your kubeconfig context.

2. Run any kubectl command to trigger a browser login. For example:

```
export KUBECONFIG="/tmp/concierge-kubeconfig"
kubectl get pods
```

Role descriptions for Tanzu Application Platform

This topic is a high level overview of each default role in Tanzu Application Platform (commonly known as TAP). For more information about the specific permissions of each role for every Tanzu Application Platform component, see [Detailed role permissions for Tanzu Application Platform](#).

app-editor

The app-editor role can create, edit, and delete a Tanzu workload or deliverable.

Assign this role to a user, for example an app developer, to give permissions to create running workloads on the cluster. This allows them to deploy their applications. This role allows the user to:

- View, create, update, or delete a Tanzu workload or deliverable. This includes viewing the logs of the pods spun up through the Tanzu workload and tracing a commit through the build process.
- Download the images associated with their Tanzu workload so they can test images locally, or create a Tanzu workload from it instead of starting from source code in a repository.
- View and use Application Accelerator templates.
- View, create, update, or delete a Tanzu workload binding with an existing service.

app-viewer

The app-viewer role cannot create, edit, or delete a Tanzu workload or deliverable.

This role has a subset of the permissions of the app-editor role. Use it if you do not want a user to create, edit, or delete a Tanzu workload or deliverable, but they need to view its status. For example, give these permissions to an application developer that requires visibility into the state of their Tanzu workload or micro-service, but does not have the permissions to deploy it, such as to production or staging environments. This role cannot bind services with a Tanzu workload.

app-operator

The app-operator role can create, edit, and delete supply chain resources.

Assign this role to a user who defines the activities within a supply chain or the path to production. For example, building, testing, or scanning. This role can view, create, update, or delete Tanzu supply chain resources, including Tanzu Build Service control plane resources such as:

- kpack's builder, stack, and store
- Scanning resources
- Grype
- The metadata store

If this person must create Tanzu workloads, you can bind the user with the app-editor role as well.

service-operator

The service-operator role can create, edit, and delete service instances, service instance classes, and resource claim policies to permit the claimability of service instances across one or more namespaces.

Assign this role to a user who is responsible for the life cycle (create, edit and delete) of service instances. This role can also view resource claims across all namespaces as well as query for the list of claimable service instances in a given namespace.

workload

This role provides the service account associated with the Tanzu workload the permissions needed to execute the activities in the supply chain. This role is for a "robot" versus a user.

deliverable

This role gives the delivery “robot” service account the permissions needed to create running workloads. This role is not for a user.

Role descriptions for Tanzu Application Platform

This topic is a high level overview of each default role in Tanzu Application Platform (commonly known as TAP). For more information about the specific permissions of each role for every Tanzu Application Platform component, see [Detailed role permissions for Tanzu Application Platform](#).

app-editor

The app-editor role can create, edit, and delete a Tanzu workload or deliverable.

Assign this role to a user, for example an app developer, to give permissions to create running workloads on the cluster. This allows them to deploy their applications. This role allows the user to:

- View, create, update, or delete a Tanzu workload or deliverable. This includes viewing the logs of the pods spun up through the Tanzu workload and tracing a commit through the build process.
- Download the images associated with their Tanzu workload so they can test images locally, or create a Tanzu workload from it instead of starting from source code in a repository.
- View and use Application Accelerator templates.
- View, create, update, or delete a Tanzu workload binding with an existing service.

app-viewer

The app-viewer role cannot create, edit, or delete a Tanzu workload or deliverable.

This role has a subset of the permissions of the app-editor role. Use it if you do not want a user to create, edit, or delete a Tanzu workload or deliverable, but they need to view its status. For example, give these permissions to an application developer that requires visibility into the state of their Tanzu workload or micro-service, but does not have the permissions to deploy it, such as to production or staging environments. This role cannot bind services with a Tanzu workload.

app-operator

The app-operator role can create, edit, and delete supply chain resources.

Assign this role to a user who defines the activities within a supply chain or the path to production. For example, building, testing, or scanning. This role can view, create, update, or delete Tanzu supply chain resources, including Tanzu Build Service control plane resources such as:

- kpack’s builder, stack, and store
- Scanning resources
- Grype
- The metadata store

If this person must create Tanzu workloads, you can bind the user with the app-editor role as well.

service-operator

The service-operator role can create, edit, and delete service instances, service instance classes, and resource claim policies to permit the claimability of service instances across one or more namespaces.

Assign this role to a user who is responsible for the life cycle (create, edit and delete) of service instances. This role can also view resource claims across all namespaces as well as query for the list of claimable service instances in a given namespace.

workload

This role provides the service account associated with the Tanzu workload the permissions needed to execute the activities in the supply chain. This role is for a "robot" versus a user.

deliverable

This role gives the delivery "robot" service account the permissions needed to create running workloads. This role is not for a user.

Detailed role permissions for Tanzu Application Platform

This topic tells you the specific permissions of each role for every Tanzu Application Platform (commonly known as TAP) component.

Native Kubernetes Resources

`apps.tanzu.vmware.com/aggregate-to-app-viewer: "true"`

```
- apiGroups: [""]
  resources: ["configmaps","endpoints","events","persistentvolumeclaims","pods","pods/log","resourcequotas","services"]
  verbs: ["get","list","watch"]
- apiGroups: ["apps"]
  resources: ["deployments","replicasets","statefulsets"]
  verbs: ["get","list","watch"]
- apiGroups: ["batch"]
  resources: ["cronjobs","jobs"]
  verbs: ["get","list","watch"]
- apiGroups: ["events.k8s.io"]
  resources: ["events"]
  verbs: ["get","list","watch"]
- apiGroups: ["networking.k8s.io"]
  resources: ["ingresses"]
  verbs: ["get","list","watch"]
```

`apps.tanzu.vmware.com/aggregate-to-app-operator: "true"`

```
- apiGroups: [""]
  resources: ["configmaps","secrets"]
  verbs: ["get","list","watch","create","patch","update","delete","deletecollection"]
```

App Accelerator

`apps.tanzu.vmware.com/aggregate-to-app-viewer: "true"`

```
- apiGroups: ["accelerator.apps.tanzu.vmware.com"]
  resources: ["accelerators"]
```

```
verbs: ["get","list","watch"]
```

`apps.tanzu.vmware.com/aggregate-to-app-operator: "true"`

```
- apiGroups: ["accelerator.apps.tanzu.vmware.com"]
  resources: ["accelerators"]
  verbs: ["get","list","watch","create","patch","update","delete","deletecollection"]
```

Cartographer

`apps.tanzu.vmware.com/aggregate-to-app-editor: "true"`

```
- apiGroups: ["carto.run"]
  resources: ["deliverables","workloads"]
  verbs: ["create","patch","update","delete","deletecollection"]
```

`apps.tanzu.vmware.com/aggregate-to-app-viewer: "true"`

```
- apiGroups: ["carto.run"]
  resources: ["deliverables","runnables","workloads"]
  verbs: ["get","list","watch"]
```

`apps.tanzu.vmware.com/aggregate-to-app-viewer-cluster-access: "true"`

```
- apiGroups: ["carto.run"]
  resources: ["clusterconfigtemplates","clusterconfigtemplates","clusterdeliveries","clusterdeploymenttemplates","clusterimagetemplates","clusterruntemplates","clustersourc
etemplates","clustersupplychains","clustertemplates"]
  verbs: ["get","list","watch"]
```

`apps.tanzu.vmware.com/aggregate-to-app-operator-cluster-access`

```
- apiGroups: ["carto.run"]
  resources: ["clusterconfigtemplates","clusterconfigtemplates","clusterdeliveries","c
lusterdeploymenttemplates","clusterimagetemplates","clusterruntemplates","clustersourc
etemplates","clustersupplychains","clustertemplates"]
  verbs: ["get","list","watch","create","patch","update","delete","deletecollection"]
```

Cloud Native Runtimes

`apps.tanzu.vmware.com/aggregate-to-app-viewer: "true"`

```
- apiGroups: ["apps"]
  resources: ["deployments","replicasets","statefulsets"]
  verbs: ["get","list","watch"]
- apiGroups: ["batch"]
  resources: ["cronjobs","jobs"]
  verbs: ["get","list","watch"]
- apiGroups: ["networking.k8s.io"]
  resources: ["ingresses"]
  verbs: ["get","list","watch"]
- apiGroups: ["eventing.knative.dev"]
  resources: ["brokers","triggers"]
  verbs: ["get","list","watch"]
- apiGroups: ["serving.knative.dev"]
```



```
resources: ["configurations","services","revisions","routes"]
verbs: ["get","list","watch"]
- apiGroups: ["sources.*"]
resources: ["(many)"]
verbs: ["get","list","watch"]
```

`apps.tanzu.vmware.com/aggregate-to-app-operator: "true"`

```
- apiGroups: ["eventing.knative.dev"]
resources: ["brokers"]
verbs: ["get","list","watch","create","patch","update","delete","deletecollection"]
- apiGroups: ["sources.*"]
resources: ["(many)"]
verbs: ["get","list","watch","create","patch","update","delete","deletecollection"]
```

Convention Service

`apps.tanzu.vmware.com/aggregate-to-app-viewer: "true"`

```
- apiGroups: ["conventions.carto.run"]
resources: ["podintents"]
verbs: ["get","list","watch"]
- apiGroups: ["conventions.apps.tanzu.vmware.com"]
resources: ["podintents"]
verbs: ["get","list","watch"]
```

`apps.tanzu.vmware.com/aggregate-to-app-viewer-cluster-access: "true"`

```
- apiGroups: ["conventions.carto.run"]
resources: ["clusterpodconventions"]
verbs: ["get","list","watch"]
- apiGroups: ["conventions.apps.tanzu.vmware.com"]
resources: ["clusterpodconventions"]
verbs: ["get","list","watch"]
```

`apps.tanzu.vmware.com/aggregate-to-app-operator-cluster-access`

```
- apiGroups: ["conventions.carto.run"]
resources: ["clusterpodconventions"]
verbs: ["get","list","watch","create","patch","update","delete","deletecollection"]
- apiGroups: ["conventions.apps.tanzu.vmware.com"]
resources: ["clusterpodconventions"]
verbs: ["get","list","watch","create","patch","update","delete","deletecollection"]
```

Developer Conventions

`apps.tanzu.vmware.com/aggregate-to-app-editor: "true"`

```
- apiGroups: [""]
resources: ["pods"]
verbs: ["get","list","watch"]
- apiGroups: [""]
resources: ["pods/exec","pods/portforward"]
verbs: ["get","list","create"]
- apiGroups: ["carto.run"]
```

```
resources: ["workloads"]
verbs: ["get", "list", "watch"]
```

OOTB Templates

`apps.tanzu.vmware.com/aggregate-to-app-viewer: "true"`

```
- apiGroups: [""]
  resources: ["configmaps"]
  verbs: ["get", "list", "watch"]
- apiGroups: ["carto.run"]
  resources: ["deliverables", "runnables"]
  verbs: ["get", "list", "watch"]
- apiGroups: ["conventions.carto.run"]
  resources: ["podintents"]
- apiGroups: ["conventions.apps.tanzu.vmware.com"]
  resources: ["podintents"]
  verbs: ["get", "list", "watch"]
- apiGroups: ["kappctrl.k14s.io"]
  resources: ["apps"]
  verbs: ["get", "list", "watch"]
- apiGroups: ["kpack.io"]
  resources: ["images"]
  verbs: ["get", "list", "watch"]
- apiGroups: ["scanning.apps.tanzu.vmware.com"]
  resources: ["imagescans", "sourcescans"]
  verbs: ["get", "list", "watch"]
- apiGroups: ["servicebinding.io"]
  resources: ["servicebindings"]
  verbs: ["get", "list", "watch"]
- apiGroups: ["services.apps.tanzu.vmware.com"]
  resources: ["resourceclaims"]
  verbs: ["get", "list", "watch"]
- apiGroups: ["serving.knative.dev"]
  resources: ["services"]
  verbs: ["get", "list", "watch"]
- apiGroups: ["source.apps.tanzu.vmware.com"]
  resources: ["imagerepositories", "mavenartifacts"]
  verbs: ["get", "list", "watch"]
- apiGroups: ["source.toolkit.fluxcd.io"]
  resources: ["gitrepositories"]
  verbs: ["get", "list", "watch"]
- apiGroups: ["tekton.dev"]
  resources: ["pipelineruns", "taskruns"]
  verbs: ["get", "list", "watch"]
```

`apps.tanzu.vmware.com/aggregate-to-workload: "true"`

```
- apiGroups: ["carto.run"]
  resources: ["deliverables", "runnables"]
  verbs: ["get", "list", "watch", "create", "patch", "update", "delete", "deletecollection"]
- apiGroups: ["conventions.carto.run"]
  resources: ["podintents"]
- apiGroups: ["conventions.apps.tanzu.vmware.com"]
  resources: ["podintents"]
  verbs: ["get", "list", "watch", "create", "patch", "update", "delete", "deletecollection"]
- apiGroups: ["kpack.io"]
  resources: ["images"]
  verbs: ["get", "list", "watch", "create", "patch", "update", "delete", "deletecollection"]
- apiGroups: ["scanning.apps.tanzu.vmware.com"]
  resources: ["imagescans", "sourcescans"]
  verbs: ["get", "list", "watch", "create", "patch", "update", "delete", "deletecollection"]
- apiGroups: ["source.apps.tanzu.vmware.com"]
```

```

resources: ["imagerepositories","mavenartifacts"]
verbs: ["get","list","watch","create","patch","update","delete","deletecollection"]
- apiGroups: ["source.toolkit.fluxcd.io"]
  resources: ["gitrepositories"]
  verbs: ["get","list","watch","create","patch","update","delete","deletecollection"]
- apiGroups: ["tekton.dev"]
  resources: ["pipelineruns","taskruns"]
  verbs: ["get","list","watch","create","patch","update","delete","deletecollection"]

```

`apps.tanzu.vmware.com/aggregate-to-deliverable: "true"`

```

- apiGroups: [""]
  resources: ["configmaps"]
  verbs: ["get","list","watch","create","patch","update","delete","deletecollection"]
- apiGroups: ["kappctrl.k14s.io"]
  resources: ["apps"]
  verbs: ["get","list","watch","create","patch","update","delete","deletecollection"]
- apiGroups: ["servicebinding.io"]
  resources: ["servicebindings"]
  verbs: ["get","list","watch","create","patch","update","delete","deletecollection"]
- apiGroups: ["services.apps.tanzu.vmware.com"]
  resources: ["resourceclaims"]
  verbs: ["get","list","watch","create","patch","update","delete","deletecollection"]
- apiGroups: ["serving.knative.dev"]
  resources: ["services"]
  verbs: ["get","list","watch","create","patch","update","delete","deletecollection"]
- apiGroups: ["source.apps.tanzu.vmware.com"]
  resources: ["imagerepositories","mavenartifacts"]
  verbs: ["get","list","watch","create","patch","update","delete","deletecollection"]
- apiGroups: ["source.toolkit.fluxcd.io"]
  resources: ["gitrepositories"]
  verbs: ["get","list","watch","create","patch","update","delete","deletecollection"]

```

Service Bindings

`apps.tanzu.vmware.com/aggregate-to-app-viewer: "true"`

```

- apiGroups: ["servicebinding.io"]
  resources: ["servicebindings"]
  verbs: ["get","list","watch"]

```

Services Toolkit

`apps.tanzu.vmware.com/aggregate-to-app-viewer: "true"`

```

- apiGroups: ["services.apps.tanzu.vmware.com"]
  resources: ["resourceclaims"]
  verbs: ["get","list","watch"]

```

`apps.tanzu.vmware.com/aggregate-to-app-viewer-cluster-access: "true"`

```

- apiGroups: ["services.apps.tanzu.vmware.com"]
  resources: ["clusterresources"]
  verbs: ["get","list","watch"]

```

`apps.tanzu.vmware.com/aggregate-to-app-operator: "true"`

```
- apiGroups: ["services.apps.tanzu.vmware.com"]
  resources: ["resourceclaims"]
  verbs: ["get", "list", "watch", "create", "patch", "update", "delete", "deletecollection"]
```

`apps.tanzu.vmware.com/aggregate-to-app-operator-cluster-access`

```
- apiGroups: ["services.apps.tanzu.vmware.com"]
  resources: ["clusterresources"]
  verbs: ["get", "list", "watch"]
```

Source Controller

`apps.tanzu.vmware.com/aggregate-to-app-viewer: "true"`

```
- apiGroups: ["source.apps.tanzu.vmware.com"]
  resources: ["imagerepositories", "mavenartifacts"]
  verbs: ["get", "list", "watch"]
```

Supply Chain Security Tools – Scan

`apps.tanzu.vmware.com/aggregate-to-app-viewer: "true"`

```
- apiGroups: ["scanning.apps.tanzu.vmware.com"]
  resources: ["imagescans", "scanpolicies", "scantemplates", "sourcescans"]
  verbs: ["get", "list", "watch"]
```

`apps.tanzu.vmware.com/aggregate-to-app-operator: "true"`

```
- apiGroups: ["scanning.apps.tanzu.vmware.com"]
  resources: ["scanpolicies", "scantemplates"]
  verbs: ["get", "list", "watch", "create", "patch", "update", "delete", "deletecollection"]
```

Tanzu Build Service

`apps.tanzu.vmware.com/aggregate-to-app-editor: "true"`

```
- apiGroups: ["kpack.io"]
  resources: ["builds"]
  verbs: ["patch"]
```

`apps.tanzu.vmware.com/aggregate-to-app-viewer: "true"`

```
- apiGroups: ["kpack.io"]
  resources: ["builds", "builders", "images"]
  verbs: ["get", "list", "watch"]
```

`apps.tanzu.vmware.com/aggregate-to-app-viewer-cluster-access: "true"`

```
- apiGroups: ["kpack.io"]
  resources: ["clusterbuilders", "clusterstacks", "clusterstores"]
  verbs: ["get", "list", "watch"]
```

`apps.tanzu.vmware.com/aggregate-to-app-operator: "true"`

```
- apiGroups: ["kpack.io"]
  resources: ["builders"]
  verbs: ["get", "list", "watch", "create", "patch", "update", "delete", "deletecollection"]
```

`apps.tanzu.vmware.com/aggregate-to-app-operator-cluster-access`

```
- apiGroups: ["kpack.io"]
  resources: ["clusterbuilders", "clusterstacks", "clusterstores"]
  verbs: ["get", "list", "watch", "create", "patch", "update", "delete", "deletecollection"]
```

Tekton

`apps.tanzu.vmware.com/aggregate-to-app-viewer: "true"`

```
- apiGroups: ["tekton.dev"]
  resources: ["pipelineresources", "pipelineruns", "pipelines", "taskruns", "tasks"]
  verbs: ["get", "list", "watch"]
```

`apps.tanzu.vmware.com/aggregate-to-app-viewer-cluster-access: "true"`

```
- apiGroups: ["tekton.dev"]
  resources: ["clustertasks"]
  verbs: ["get", "list", "watch"]
```

`apps.tanzu.vmware.com/aggregate-to-app-operator: "true"`

```
- apiGroups: ["tekton.dev"]
  resources: ["pipelineresources", "pipelines", "tasks"]
  verbs: ["get", "list", "watch", "create", "patch", "update", "delete", "deletecollection"]
```

`apps.tanzu.vmware.com/aggregate-to-app-operator-cluster-access`

```
- apiGroups: ["tekton.dev"]
  resources: ["clustertasks"]
  verbs: ["get", "list", "watch", "create", "patch", "update", "delete", "deletecollection"]
```

Bind a user or group to a default role

You can choose one of the following two approaches to bind a user or group to a default role:

- Use the Tanzu Application Platform RBAC CLI plug-in, which only supports binding Tanzu Application Platform (commonly known as TAP) default roles.
- Use Kubernetes role-based access control (RBAC) role binding.

VMware recommends that you use the Tanzu Application Platform RBAC CLI plug-in. This CLI plug-in simplifies the process by binding the cluster-scoped resource permissions at the same time as the namespace-scoped resource permissions, where applicable, for each default role. The following sections cover the Tanzu Application Platform RBAC CLI plug-in.

Prerequisites

Before you can bind a user or group to a default role, you must:

- Download the latest Tanzu CLI version.
- Download the Tanzu Application Platform RBAC CLI plug-in `tar.gz` file from [Tanzu Network](#).
- Have admin access to the cluster.
- Configure an authentication solution for the cluster. You can use [Pinniped](#) or the authentication service native to your Kubernetes distribution.

Install the Tanzu Application Platform RBAC CLI plug-in

Follow these steps to install the Tanzu Application Platform RBAC CLI plug-in:



Caution

The Tanzu Application Platform RBAC CLI plug-in is currently in beta and is intended for evaluation and test purposes only.

1. Untar the `tar.gz` file:

```
tar -zxvf NAME-OF-THE-TAR
```

2. Install the Tanzu Application Platform RBAC CLI plug-in locally on your operating system:

macOS

```
tanzu plugin install rbac --local darwin-amd64
```

Linux

```
tanzu plugin install rbac --local linux-amd64
```

Windows

```
tanzu plugin install rbac --local windows-amd64
```

(Optional) Use a different kubeconfig location

You can use a different kubeconfig location by running:

```
tanzu rbac --kubeconfig PATH-OF-KUBECONFIG binding add --user USER --role ROLE --namespace NAMESPACE
```



Note

The environment variable `KUBECONFIG` is not implemented. You must use the `--kubeconfig` flag to enter a different location. Otherwise the default `~/.kube/config` is used.

For example:

```
$ tanzu rbac --kubeconfig /tmp/pinniped_kubeconfig.yaml binding add --user username@vmware.com --role app-editor --namespace user-ns
```

Add the specified user or group to a role

Add a user or group to a role by running:

```
tanzu rbac binding add --user USER --role ROLE --namespace NAMESPACE
```

```
tanzu rbac binding add --group GROUP --role ROLE --namespace NAMESPACE
```

For example:

```
$ tanzu rbac binding add --user username@vmware.com --role app-editor --namespace user-ns
```

Get a list of users and groups from a role

Get a list of users and groups from a role by running:

```
tanzu rbac binding get --role ROLE --namespace NAMESPACE
```

For example:

```
$ tanzu rbac binding get --role app-editor --namespace user-ns
```

Remove the specified user or group from a role

Remove a user or group from a role by running:

```
tanzu rbac binding delete --user USER --role ROLE --namespace NAMESPACE
```

```
tanzu rbac binding delete --group GROUP --role ROLE --namespace NAMESPACE
```

For example:

```
$ tanzu rbac binding delete --user username@vmware.com --role app-editor --namespace user-ns
```

Error logs

Authorization error logs might include the following errors:

- Permission Denied:

The current user does not have permissions to create or edit rolebinding objects. Use an admin account when using the RBAC CLI.

```
Error: rolebindings.rbac.authorization.k8s.io "app-operator" is forbidden: User "  
<subject>" cannot get resource "rolebindings" in API group "rbac.authorization.k8s.io" in the namespace "namespace"  
Usage:  
tanzu rbac binding add [flags]  
Flags:  
-g, --group string User Group
```

```
-h, --help help for add
-n, --namespace string Namespace
-r, --role string Role
-u, --user string User Name

Global Flags:
--kubeconfig string kubeconfig file
```

- **Already Bound Error:**

Adding a subject, user or group, to a role that already has the subject produces the following error:

```
Error: User 'test-user' is already bound to 'app-operator' role
Usage:
tanzu rbac binding add [flags]
Flags:
-g, --group string User Group
-h, --help help for add
-n, --namespace string Namespace
-r, --role string Role
-u, --user string User Name

Global Flags:
--kubeconfig string kubeconfig file
```

- **Could Not Find Error:**

When removing a subject from a role, this error can occur in the following two scenarios:

1. The rolebinding does not exist.
2. The subject does not exist in the rolebinding.

Ensure the rolebinding exists and that the subject name is correctly spelled.

```
Error: Did not find User 'test-user' in RoleBinding 'app-operator'
Usage:
tanzu rbac binding delete [flags]

Flags:
-g, --group string User Group
-h, --help help for delete
-n, --namespace string Namespace
-r, --role string Role
-u, --user string User Name

Global Flags:
--kubeconfig string kubeconfig file
```

- **Object Has Been Modified Error:**

This error is a race condition caused by running multiple RBAC CLI actions at the same time. Rerunning the RBAC CLI might fix the issue.

```
Removed User 'test-user' from RoleBinding 'app-operator'
Removed User 'test-user' from ClusterRoleBinding 'app-operator-cluster-access'
Error: Operation cannot be fulfilled on rolebindings.rbac.authorization.k8s.io
"app-operator": the object has been modified; please apply your changes to the
latest version and try again
Usage:
tanzu rbac binding delete [flags]

Flags:
-g, --group string User Group
-h, --help help for delete
```



```
-n, --namespace string Namespace
-r, --role string Role
-u, --user string User Name
```

Troubleshooting

1. Get a list of permissions for a user or a group:

```
export NAME=SUBJECT-NAME
kubectl get rolebindings,clusterrolebindings -A -o json | jq -r ".items[] | select(.subjects[]?.name == \"\${NAME}\") | .roleRef.name" | xargs -n1 kubectl describe clusterroles
```

2. Get a list of user or group for a specific role:

```
tanzu rbac binding get --role ROLE --namespace NAMESPACE
```

Log in to Tanzu Application Platform by using Pinniped

This topic tells you how to log in to your Tanzu Application Platform (commonly known as TAP) by using Pinniped.

As a prerequisite, the administrator must provide users access to resources by using [rolebindings](#). It can be done with the `tanzu rbac` plug-in. For more information, see [Bind a user or group to a default role](#).

To log in to your cluster by using Pinniped, follow these steps:

1. Install the Pinniped CLI.

For more information, see [Pinniped documentation](#).



Important

The latest compatible version of Pinniped CLI is required not only for the administrator to generate the `kubeconfig`, but also for the user to log in with the provided configuration.

2. Generate and distribute `kubeconfig` to users.
3. Login with the provided `kubeconfig`.

Download the Pinniped CLI

You must use a Pinniped CLI version that matches the installed Concierge or Supervisor. Use one of the following links to download the Pinniped CLI version `0.22.0`:

- [Mac OS with AMD64](#)
- [Linux with AMD64](#)
- [Windows with AMD64](#)

You must install the command-line tool on your `$PATH`, such as `/usr/local/bin` on macOS or Linux. You must also mark the file as executable.

Generate and distribute kubeconfig to users

As an administrator, you can generate the `kubeconfig` by using the following command:

```
pinniped get kubeconfig --kubeconfig-context <your-kubeconfig-context> > /tmp/concierge-kubeconfig
```

Distribute this `kubeconfig` to your users so they can login by using `pinniped`.

Login with the provided kubeconfig

As a user of the cluster, you need the `kubeconfig` provided by your admin and the Pinniped CLI installed on your local machine to log in. Logging in is required to request information from the cluster. You can execute any resource request with `kubectl` to enter the authentication flow. For example:

```
kubectl --kubeconfig /tmp/concierge-kubeconfig get pods
```

If you do not want to explicitly use `--kubeconfig` in every command, you can also export an environment variable to set the `kubeconfig` path in your shell session.

```
export KUBECONFIG="/tmp/concierge-kubeconfig"
kubectl get pods
```

This command enables `pinniped` to print a URL for you to visit in the browser. You can then log in, copy the authentication code and paste it back to the terminal. After the login succeeds, you either see the resources or a message indicating that you have no permission to access the resources.

If you use a Windows machine, the command referenced in the generated `kubeconfig` might not work. In this case, you must change the path under `user.exec.command` in the `kubeconfig` to point to the install path of the Pinniped CLI.

Additional resources about Tanzu Application Platform authentication and authorization

Use this topic to learn additional information about authentication and authorization for Tanzu Application Platform (commonly known as TAP).

See [Default roles for Tanzu Application Platform overview](#) to get started.

Install

Default roles are released as part of Tanzu Application Platform. Alternatively, you can also install default roles independently. See [Install default roles independently](#) for more information.



Note

The `tanzu rbac` CLI plug-in requires a [separate installation](#).

Additional resources about Tanzu Application Platform authentication and authorization

Use this topic to learn additional information about authentication and authorization for Tanzu Application Platform (commonly known as TAP).

See [Default roles for Tanzu Application Platform overview](#) to get started.

Install

Default roles are released as part of Tanzu Application Platform. Alternatively, you can also install default roles independently. See [Install default roles independently](#) for more information.



Note

The `tanzu rbac` CLI plug-in requires a [separate installation](#).

Install default roles independently for your Tanzu Application Platform

This topic tells you how to install default roles for Tanzu Application Platform (commonly known as TAP) without deploying a TAP profile.



Note

Follow the steps in this topic if you do not want to use a profile to install default roles. For more information about profiles, see [Components and installation profiles](#).

Prerequisites

Before installing default roles, complete all prerequisites to install Tanzu Application Platform. For more information, see [Prerequisites](#).

Install

To install default roles:

1. List version information for the package by running:

```
tanzu package available list tap-auth.tanzu.vmware.com --namespace tap-install
```

For example:

```
$ tanzu package available list tap-auth.tanzu.vmware.com --namespace tap-install
1
- Retrieving package versions for tap-auth.tanzu.vmware.com...
NAME                                VERSION    RELEASED-AT
tap-auth.tanzu.vmware.com          1.0.1
```

2. Install the package by running:

```
tanzu package install tap-auth \
  --package tap-auth.tanzu.vmware.com \
  --version VERSION \
  --namespace tap-install
```

Where:

- o `VERSION` is the package version number. For example, `1.0.1`.

For example:

```
$ tanzu package install tap-auth \
  --package tap-auth.tanzu.vmware.com \
  --version 1.0.1 \
  --namespace tap-install
```

Overview of Bitnami Services

Bitnami Services provides a set of backing services for Tanzu Application Platform (commonly known as TAP). The services are MySQL, PostgreSQL, RabbitMQ, Redis, MongoDB, and Kafka all of which are backed by the corresponding Bitnami Helm Chart.

Through integration with [Crossplane](#) and [Services Toolkit](#), these six services are immediately ready for apps teams to consume, with no additional setup or configuration required from ops teams. This makes it incredibly quick and easy to get started working with services on Tanzu Application Platform.



Note

The Bitnami Services package provides unmanaged services that are not designed to support long lived instances. Therefore, there is no supported path to upgrade individual instances. Bitnami Services are instantiated using the configuration and version of the package at creation time and so upgrading the Bitnami Services package has no effect on existing instances. VMware discourages changing the `compositionUpdatePolicy` and `compositionRevisionRef` on the individual composite resources (XRs) because this might cause unintended side effects.

Getting started

If this is your first time working with Bitnami Services on Tanzu Application Platform, you can start with the tutorial [Working with Bitnami Services](#). Otherwise, see the [how-to guides](#) and [reference material](#).

Overview of Bitnami Services

Bitnami Services provides a set of backing services for Tanzu Application Platform (commonly known as TAP). The services are MySQL, PostgreSQL, RabbitMQ, Redis, MongoDB, and Kafka all of which are backed by the corresponding Bitnami Helm Chart.

Through integration with [Crossplane](#) and [Services Toolkit](#), these six services are immediately ready for apps teams to consume, with no additional setup or configuration required from ops teams. This makes it incredibly quick and easy to get started working with services on Tanzu Application Platform.



Note

The Bitnami Services package provides unmanaged services that are not designed to support long lived instances. Therefore, there is no supported path to upgrade individual instances. Bitnami Services are instantiated using the configuration and version of the package at creation time and so upgrading the Bitnami Services package has no effect on existing instances. VMware discourages changing the `compositionUpdatePolicy` and `compositionRevisionRef` on the individual composite resources (XRs) because this might cause unintended side effects.

Getting started

If this is your first time working with Bitnami Services on Tanzu Application Platform, you can start with the tutorial [Working with Bitnami Services](#). Otherwise, see the [how-to guides](#) and [reference](#)

material.

Install Bitnami Services

This topic tells you how to install Bitnami Services from the Tanzu Application Platform (commonly known as TAP) package repository.



Note

Follow the steps in this topic if you do not want to use a profile to install Bitnami Services. For more information about profiles, see [Components and installation profiles](#).

Prerequisites

Before installing Bitnami Services, you must:

- Fulfill all [prerequisites for installing Tanzu Application Platform](#)
- [Install Crossplane](#)
- [Install Services Toolkit](#)

Install Bitnami Services

To install Bitnami Services:

1. See what versions of Bitnami Services are available to install by running:

```
tanzu package available list -n tap-install bitnami.services.tanzu.vmware.com
```

For example:

```
$ tanzu package available list -n tap-install bitnami.services.tanzu.vmware.com
NAME                                VERSION      RELEASED-AT
bitnami.services.tanzu.vmware.com  0.1.0       2023-03-10 14:35:15 +000
0 UTC
```

2. Install Bitnami Services by running:

```
tanzu package install bitnami-services \
  --package bitnami.services.tanzu.vmware.com \
  --version VERSION-NUMBER \
  --namespace tap-install
```

Where **VERSION-NUMBER** is the Bitnami Services version you want to install. For example, **0.1.0**.

3. Verify that the package installed by running:

```
tanzu package installed get bitnami-services -n tap-install
```

In the output, confirm that the **STATUS** value is **Reconcile succeeded**.

For example:

```
$ tanzu package installed get bitnami-services -n tap-install
NAMESPACE:      tap-install
NAME:           bitnami-services
```

```
PACKAGE-NAME:      bitnami.services.tanzu.vmware.com
PACKAGE-VERSION:   0.1.0
STATUS:            Reconcile succeeded
CONDITIONS:       - type: ReconcileSucceeded
                   status: "True"
                   reason: ""
                   message: ""
```

Bitnami Services tutorials

This section contains tutorials for how to use Bitnami Services.

In this section:

- [Working with Bitnami Services](#)

Work with Bitnami Services

In this tutorial you learn how [application operators](#) can discover, claim, and bind services to application workloads.

Tanzu Application Platform has six services that are available in the Bitnami Services package. These are MySQL, PostgreSQL, RabbitMQ, Redis, MongoDB, and Kafka. The corresponding Bitnami Helm chart backs each of these services.

About this tutorial

Target user role: Application operator

Complexity: Basic

Estimated time: 15 minutes

Topics covered: Classes, claims, Bitnami,

Learning outcomes: An understanding of how to work with the standard services provided by the Bitnami Services package

Prerequisites

To follow this tutorial, you must have:

- Access to a Tanzu Application Platform cluster v1.5.0 or later.
- Installed the Tanzu Service CLI plug-in v0.6.0 or later.

Concepts

The following diagram provides an overview of the elements you will use during this tutorial and how these elements fit together.

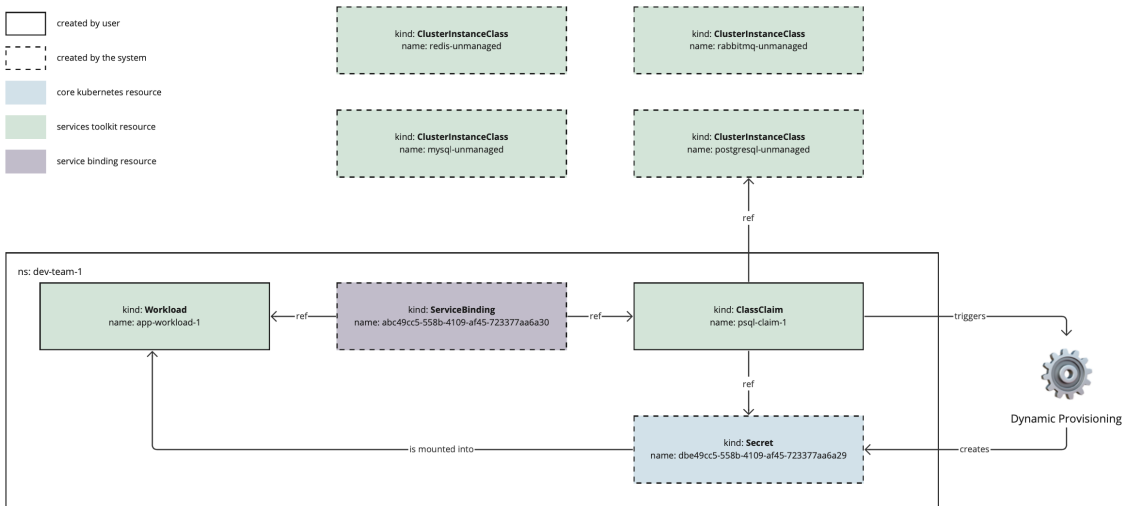

In this diagram:

- There are two elements that require user input. These are creating a **ClassClaim** and creating a **Workload**. The workload is configured to refer to the class claim.
- The life cycles of the **ClassClaim** and the **Workload** are separate. This allows you to update one without affecting the other.
- The dynamic provisioning process is simplified. This is intentional because application operators and developers do not need to know about the inner workings and configuration of service instances.

Procedure

The following steps explain how to work with Bitnami Services.

Step 1: Discover the services

1. Application teams can discover the range of available services by running:

```
tanzu service class list
```

Example output:

NAME	DESCRIPTION
kafka-unmanaged	Kafka by Bitnami
mongodb-unmanaged	MongoDB by Bitnami
mysql-unmanaged	MySQL by Bitnami
postgresql-unmanaged	PostgreSQL by Bitnami
rabbitmq-unmanaged	RabbitMQ by Bitnami
redis-unmanaged	Redis by Bitnami

This output shows six classes. These are the six services available in the Bitnami Services package. You can see from the names and descriptions that they are all *unmanaged* services. This implies that the resulting service instances run on cluster, that is, they are not a managed service running in the cloud. Other classes might be listed here as well.

As an application operator, you review the classes on offer and choose one that meets your requirements.

2. You can learn more about a class by running:

```
tanzu service class get postgresql-unmanaged
```

Example output:

```
NAME:          postgresql-unmanaged
DESCRIPTION:   PostgreSQL by Bitnami
READY:        true

PARAMETERS:
  KEY          DESCRIPTION                                     TYPE
DEFAULT REQUIRED
  storageGB    The desired storage capacity of the database, in Gigabytes. integer
  1           false
```

The output shows the name, a short description for the class, its current status, and the parameters. The parameters represent the set of configuration options that are available to application teams.

The `postgresql-unmanaged` class here has one parameter, which is `storageGB`. You can also see that it is not required to pass this parameter when creating a claim for the class, in which case the default value of `1` is used.

Step 2: Claim a service

In this example you have an application workload that requires a PostgreSQL database to function correctly. You can claim the PostgreSQL Bitnami service to obtain such a database.

To claim a PostgreSQL service:

1. Create the namespace `dev-team-1` by running:

```
kubectl create namespace dev-team-1
```

2. Create a claim for the `postgresql-unmanaged` class.

The following command also overrides the default value of `1` for the `storageGB` parameter by setting it to `3`. You can override any of the options.

```
tanzu service class-claim create psql-1 \
  --class postgresql-unmanaged \
  --parameter storageGB=3 \
  -n dev-team-1
```

Example output:

```
Creating claim 'psql-1' in namespace 'dev-team-1'.
Please run `tanzu service class-claim get psql-1 --namespace dev-team-1` to see
the progress of create.
```

3. Confirm the status of the claim by running:

```
tanzu service class-claim get psql-1 --namespace dev-team-1
```

Example output:

```
Name: psql-1
Namespace: dev-team-1
Claim Reference: services.apps.tanzu.vmware.com/v1alpha1:ClassClaim:psql-1
Class Reference:
  Name: postgresql-unmanaged
Parameters:
  storageGB: 3
Status:
  Ready: True
```



```

Claimed Resource:
  Name: 7974379c-7b4d-41c3-af57-f4f1ae08c65d
  Namespace: dev-team-1
  Group:
  Version: v1
  Kind: Secret

```

Wait for the claim to report `Ready: True`.

After the claim is ready, you then have a successful claim for a PostgreSQL database configured to your needs with 3 GB of storage.

Step 3: Bind the claim to a workload

After creating the service claim, you can bind it to one or more of your application workloads.



Important

If you are binding to more than one application workload, all application workloads must exist in the same namespace. This is a known limitation. For more information, see [Cannot claim and bind to the same service instance from across multiple namespaces](#).

To bind the claim to your workload:

1. Find the reference for the claim by running:

```
tanzu service class-claim get psql-1
```

The reference is in the output under the heading `Claim Reference`.

2. Bind the claim to your workload by passing the reference for the claim to the `--service-ref` flag of the `tanzu apps workload create` command. For example:

```
tanzu apps workload create my-workload \
  --image my-registry/my-app-image \
  --service-ref db=services.apps.tanzu.vmware.com/v1alpha1:ClassClaim:psql-1
```

You must pass the claim reference with a corresponding name that follows the format `--service-ref db=services.apps.tanzu.vmware.com/v1alpha1:ClassClaim:psql-1`. The `db=` prefix to this example reference is an arbitrary name for the reference.

Bitnami Services how-to guides

This section contains how-to guides for Bitnami Services.

In this section:

- [Configure private registry and VMware Tanzu Application Catalog integration for Bitnami Services](#)
- [Obtain credentials for VMware Tanzu Application Catalog integration](#)
- [Troubleshoot Bitnami Services](#)

Configure private registry and VMware Tanzu Application Catalog integration for Bitnami Services

This topic tells you how to integrate Bitnami Services with private registries or with VMware Tanzu Application Catalog. You can configure this globally for all services, or on a per-service basis.

Prerequisites

Before you integrate Bitnami Services with a private registry or VMware Tanzu Application Catalog, you must:

- Have your Helm Chart repository URL in the format `oci://REGISTRY-HOSTNAME/REPOSITORY-PATH/charts`. Some VMware Tanzu Application Catalog instances append the operating system to the repository URL, in which case, use the URL format `oci://REGISTRY-HOSTNAME/REPOSITORY-PATH/charts/centos-7`.
- Have the credentials to access the private registry.

For how to obtain both of these prerequisites for VMware Tanzu Application Catalog integration, see [Obtain credentials for VMware Tanzu Application Catalog integration](#).

Procedure

1. Create two Kubernetes `Secrets`, one with credentials to pull Helm charts and the other with credentials to pull images. The following examples put these in the `default` namespace, but you can choose to place them in any namespace you prefer.

```
$ kubectl create secret generic tac-chart-pull \
-n default \
--from-literal=username='USERNAME' \
--from-literal=password='TOKEN'
```

```
$ kubectl create secret docker-registry tac-container-pull \
-n default \
--docker-server='REGISTRY-HOSTNAME' \
--docker-username='USERNAME' \
--docker-password='TOKEN'
```

2. Apply the configuration either to all Bitnami services or to one specific service.
 - **Apply configuration to all Bitnami services:**
 1. Add the following to your `tap-values.yaml` file:

```
bitnami_services:
  globals:
    helm_chart:
      repo: oci://REGISTRY-HOSTNAME/REPOSITORY-PATH/charts # Update this value.
      chart_pull_secret_ref:
        name: tac-chart-pull
        namespace: default
      container_pull_secret_ref:
        name: tac-container-pull
        namespace: default
```

2. Update Tanzu Application Platform by running:

```
tanzu package installed update tap -p tap.tanzu.vmware.com --value s-file tap-values.yaml -n tap-install
```

- **Apply configuration to one specific Bitnami service:**
 1. Add the following to your `tap-values.yaml` file:

```

bitnami_services:
  mysql: # Choose from mysql, postgresql, rabbitmq, redis, mongod
b, and kafka.
    helm_chart:
      repo: oci://REGISTRY-HOSTNAME/REPOSITORY-PATH/charts # Updat
e this value.
      chart_pull_secret_ref:
        name: tac-chart-pull
        namespace: default
      container_pull_secret_ref:
        name: tac-container-pull
        namespace: default

```

2. Update Tanzu Application Platform by running:

```

tanzu package installed update tap -p tap.tanzu.vmware.com --value
s-file tap-values.yaml -n tap-install

```

3. If your VMware Tanzu Application Catalog instance does not have the default version of a given chart or you want to use a different version, configure the version for the chart by updating the `helm_chart.version` value for the service. For example:

```

bitnami_services:
  mysql: # Choose from mysql, postgresql, rabbitmq, redis, mongodb, and kafka.
    helm_chart:
      version: VERSION

```

Known issue

As of Tanzu Application Platform v1.5.0 there is a known issue that occurs if you try to configure private registry integration for the Bitnami services after having already created a claim for one or more of the Bitnami services using the default configuration. The issue is that the updated private registry configuration does not appear to take effect. This is due to caching behavior in the system which is not currently accounted for during configuration updates.

Workaround

There is a temporary workaround to this issue, which is to delete the `provider-helm-*` pods in the `crossplane-system` namespace and wait for new pods to come back online after having applied updated registry configuration.

Obtain credentials for VMware Tanzu Application Catalog integration with Bitnami Services

This topic tells you how to obtain credentials for VMware Tanzu Application Catalog to use when following the procedure in [Configure private registry and VMware Tanzu Application Catalog integration for Bitnami Services](#).

Prerequisites

Before obtaining credentials, you must have a VMware Tanzu Application Catalog instance that can create access tokens from within the VMware Tanzu Application Catalog UI.

Obtain the Helm chart repository for VMware Tanzu Application Catalog

1. In VMware Tanzu Application Catalog, navigate to the **Applications** side tab.
2. Under **Filter your catalog**, search for Helm Charts in your catalog, for example, **MySQL**, and click **Details** for one of the charts you found:

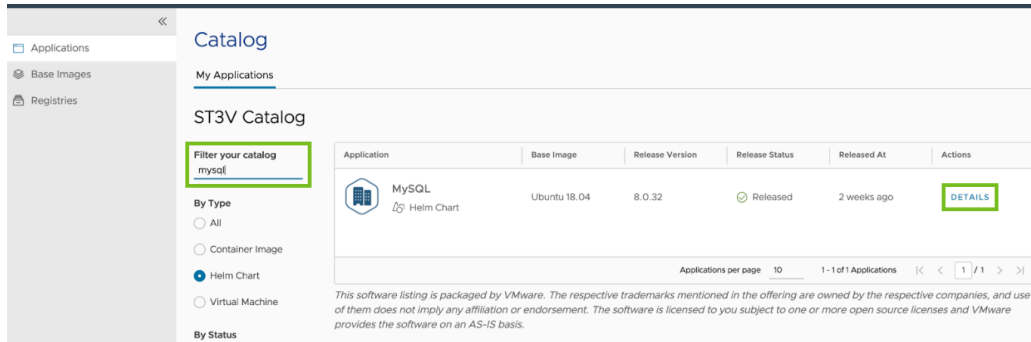

3. Take note of the repository shown under **For Helm CLI >= 3.7.0**. You must include the **oci://** prefix as shown on the page:

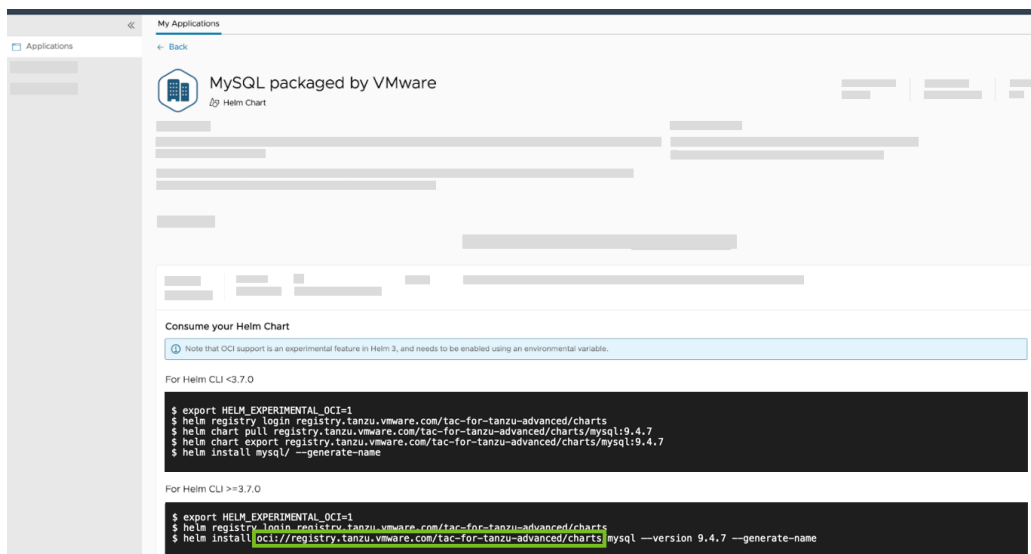

Obtain pull credentials for VMware Tanzu Application Catalog

1. In VMware Tanzu Application Catalog, navigate to the **Registries** side tab:
2. Click on the registry that contains your Helm Charts and container images and record the **Registry URL**.
3. Click the **Registry Credentials** tab.
4. Click **Generate New Credentials**.
5. Record the user name and token you are presented with.

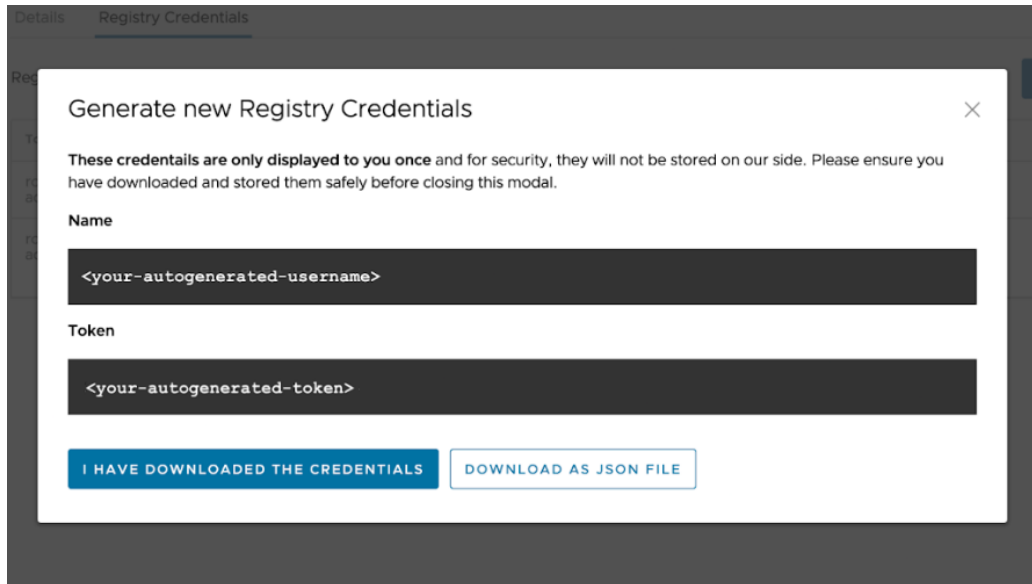

You can now take the repository, user name, and token and use it to configure VMware Tanzu Application Catalog integration with the Bitnami services by following the steps in [Configure Private Registry and VMware Tanzu Application Catalog Integration for Bitnami Services](#).

Troubleshoot Bitnami Services

This topic explains how you troubleshoot issues related to Bitnami Services on Tanzu Application Platform (commonly known as TAP).

Private registry or VMware Tanzu Application Catalog configuration does not take effect

Symptom:

If you [configure private registry integration for the Bitnami services](#) after creating a claim for a Bitnami service using the default configuration, the updated private registry configuration does not appear to take effect.

Cause:

This is due to caching behavior in the system that is not accounted for during configuration updates.

Solution:

Delete the `provider-helm-*` pods in the `crossplane-system` namespace and wait for new pods to come back online after having applied the updated registry configuration.

Bitnami Services reference

This section provides reference documentation for Bitnami Services.

In this section:

- [Dependencies](#)
- [Package values](#)

Dependencies for Bitnami Services

Bitnami Services is an integration package, which means that it provides configuration for other Tanzu Application Platform (commonly known as TAP) components. As such, it has a number of dependencies that must be met before you can use it.

The dependencies for Bitnami Services are:

- **Crossplane and the two providers** `provider-helm` and `provider-kubernetes`: See [Install Crossplane](#)
- **Services Toolkit**: See [Install Services Toolkit](#)

These dependencies are met if you install Tanzu Application Platform using the full, iterate, or run profiles.

Package values for Bitnami Services

This topic lists the keys and values that you can use to configure the behavior of the Bitnami Services package. You can apply configuration globally to all services using the `globals` key, or on a per-service basis using the `mysql`, `postgresql`, `rabbitmq`, `redis`, `mongodb`, and `kafka` keys.

If you are applying configuration to Tanzu Application Platform through the use of profiles and the `tap-values.yaml`, all configuration must exist under the `bitnami_services` top-level key.

For example:

```
bitnami_services:
  globals:
    helm_chart:
      # If you choose to use a custom Helm Chart repo, it's possible you'll also need
      # to configure specific versions
      # for each Chart as well, see example configuration below for postgresql.
      repo: https://charts.mycompany.example.com
  mysql:
    enabled: false
  postgresql:
    helm_chart:
      version: 12.2.6
    instance_class:
      name: company-redis
      description: My company postgres
  rabbitmq:
    instance_class:
      name: company-redis
      description: My company rabbit
  redis:
    instance_class:
      name: company-redis
      description: My company redis
```

Globals

The following table lists configuration that applies to all services.

KEY	DEFAULT	TYPE	DESCRIPTION
<code>globals.create_clusterroles</code>	<code>true</code>	boolean	Optional: Specifies whether to create default ClusterRoles that grant <code>claim</code> permissions to all Tanzu Application Platform Application operators.
<code>globals.helm_chart.pull_secret_ref.name</code>	<code>""</code>	string	Name of the pull secret. Can be overridden by individual services.

KEY	DEFAULT	TYPE	DESCRIPTION
globals.helm_chart.pull_secret_ref.namespace	""	string	Namespace of the pull secret. Can be overridden by individual services.
globals.helm_chart.container_pull_secret_ref.name	""	string	Name of the secret. Can be overridden by individual services.
globals.helm_chart.container_pull_secret_ref.namespace	""	string	Namespace of the secret. Can be overridden by individual services.
globals.helm_chart.repo	https://charts.bitnami.com/bitnami	string	Optional: Repository hosting the Helm charts used to provision the instances of all services. Can be overridden by individual services.
globals.shared_namespace	""	string	Optional: Name of the namespace that is shared by all provisioned instances of all services. By default, each instance is provisioned in its own dedicated namespace. Can be overridden by individual services.

MySQL

The following table lists configuration that applies to the `mysql` service.

KEY	DEFAULT	TYPE	DESCRIPTION
mysql.defaults.storage_size_gb	1	integer	Optional: The amount of storage to give each MySQL instance by default, in Gigabytes.
mysql.enabled	true	boolean	Optional: Provide developers an offering for unmanaged MySQL instances.
mysql.helm_chart.repo	""	string	Optional: Repository hosting the Helm chart used to provision MySQL instances.
mysql.helm_chart.version	9.5.0	string	Optional: Version of the Helm chart used to provision MySQL instances.
mysql.helm_chart.chart_pull_secret_ref.name	""	string	Name of the pull secret.
mysql.helm_chart.chart_pull_secret_ref.namespace	""	string	Namespace of the pull secret.
mysql.helm_chart.container_pull_secret_ref.name	""	string	Name of the secret. Can be overridden by individual services.
mysql.helm_chart.container_pull_secret_ref.namespace	""	string	Namespace of the secret. Can be overridden by individual services.
mysql.instance_class.description	MySQL by Bitnami	string	Optional: Description of the ClusterInstanceClass that developers use to provision and claim MySQL instances.
mysql.instance_class.name	mysql-unmanaged	string	Optional: Name of the ClusterInstanceClass that developers use to provision and claim MySQL instances.
mysql.shared_namespace	""	string	Optional: Name of the namespace that is shared by all provisioned MySQL instances. By default, each instance is provisioned in its own dedicated namespace.

PostgreSQL

The following table lists configuration that applies to the `postgresql` service.

KEY	DEFAULT	TYPE	DESCRIPTION
<code>postgresql.enabled</code>	<code>true</code>	boolean	Optional: Provide developers an offering for unmanaged PostgreSQL instances.
<code>postgresql.helm_chart.chart_pull_secret_ref.name</code>	<code>""</code>	string	Name of the pull secret.
<code>postgresql.helm_chart.chart_pull_secret_ref.namespace</code>	<code>""</code>	string	Namespace of the pull secret.
<code>postgresql.helm_chart.container_pull_secret_ref.name</code>	<code>""</code>	string	Name of the secret. Can be overridden by individual services.
<code>postgresql.helm_chart.container_pull_secret_ref.namespace</code>	<code>""</code>	string	Namespace of the secret. Can be overridden by individual services.
<code>postgresql.helm_chart.repo</code>	<code>""</code>	string	Optional: Repository hosting the Helm chart used to provision PostgreSQL instances.
<code>postgresql.helm_chart.version</code>	<code>12.2.0</code>	string	Optional: Version of the Helm chart used to provision PostgreSQL instances.
<code>postgresql.instance_class.description</code>	<code>PostgreSQL by Bitnami</code>	string	Optional: Description of the ClusterInstanceClass that developers use to provision and claim PostgreSQL instances.
<code>postgresql.instance_class.name</code>	<code>postgresql-unmanaged</code>	string	Optional: Name of the ClusterInstanceClass that developers use to provision and claim PostgreSQL instances.
<code>postgresql.shared_namespace</code>	<code>""</code>	string	Optional: Name of the namespace that is shared by all provisioned PostgreSQL instances. By default, each instance will be provisioned in its own dedicated namespace.
<code>postgresql.defaults.storage_size_gb</code>	<code>1</code>	integer	Optional: The amount of storage to give each PostgreSQL instance by default, in Gigabytes.

RabbitMQ

The following table lists configuration that applies to the `rabbitmq` service.

KEY	DEFAULT	TYPE	DESCRIPTION
<code>rabbitmq.enabled</code>	<code>true</code>	boolean	Optional: Provide developers an offering for unmanaged RabbitMQ instances
<code>rabbitmq.helm_chart.container_pull_secret_ref.name</code>	<code>""</code>	string	Name of the secret. Can be overridden by individual services.
<code>rabbitmq.helm_chart.container_pull_secret_ref.namespace</code>	<code>""</code>	string	Namespace of the secret. Can be overridden by individual services.
<code>rabbitmq.helm_chart.repo</code>	<code>""</code>	string	Optional: Repository hosting the Helm chart used to provision RabbitMQ instances.
<code>rabbitmq.helm_chart.version</code>	<code>11.10.0</code>	string	Optional: Version of the Helm chart used to provision RabbitMQ instances.

KEY	DEFAULT	TYPE	DESCRIPTION
rabbitmq.helm_chart.chart_pull_secret_ref.name	""	string	Name of the pull secret.
rabbitmq.helm_chart.chart_pull_secret_ref.namespace	""	string	Namespace of the pull secret.
rabbitmq.instance_class.description	RabbitMQ by Bitnami	string	Optional: Description of the ClusterInstanceClass that developers use to provision and claim RabbitMQ instances.
rabbitmq.instance_class.name	rabbitmq-unmanaged	string	Optional: Name of the ClusterInstanceClass that developers use to provision and claim RabbitMQ instances.
rabbitmq.shared_namespace	""	string	Optional: Name of the namespace that is shared by all provisioned RabbitMQ instances. By default, each instance will be provisioned in its own dedicated namespace.
rabbitmq.defaults.replica_count	1	integer	Optional: The number of replicas to create for each RabbitMQ instance by default.
rabbitmq.defaults.storage_size_gb	1	integer	Optional: The amount of storage to give each RabbitMQ instance by default, in Gigabytes.

Redis

The following table lists configuration that applies to the `redis` service.

KEY	DEFAULT	TYPE	DESCRIPTION
redis.instance_class.description	Redis by Bitnami	string	Optional: Description of the ClusterInstanceClass that is used by developers to provision and claim Redis instances.
redis.instance_class.name	redis-unmanaged	string	Optional: Name of the ClusterInstanceClass that is used by developers to provision and claim Redis instances.
redis.shared_namespace	""	string	Optional: Name of the namespace that is shared by all provisioned Redis instances. By default, each instance will be provisioned in its own dedicated namespace.
redis.defaults.storage_size_gb	1	integer	Optional: The amount of storage to give each Redis instance by default, in Gigabytes.
redis.enabled	true	boolean	Optional: Provide developers an offering for unmanaged Redis instances.
redis.helm_chart.chart_pull_secret_ref.name	""	string	Name of the pull secret.
redis.helm_chart.chart_pull_secret_ref.namespace	""	string	Namespace of the pull secret.
redis.helm_chart.container_pull_secret_ref.name	""	string	Name of the secret. Can be overridden by individual services.
redis.helm_chart.container_pull_secret_ref.namespace	""	string	Namespace of the secret. Can be overridden by individual services.
redis.helm_chart.repo	""	string	Optional: Repository hosting the Helm chart used to provision Redis instances.

KEY	DEFAULT	TYPE	DESCRIPTION
redis.helm_chart.version	17.8.0	string	Optional: Version of the Helm chart used to provision Redis instances.

MongoDB

The following table lists configuration that applies to the `mongodb` service.

KEY	DEFAULT	TYPE	DESCRIPTION
mongodb.instance_class.description	MongoDB by Bitnami	string	Optional: Description of the ClusterInstanceClass that is used by developers to provision and claim MongoDB instances.
mongodb.instance_class.name	mongodb-unmanaged	string	Optional: Name of the ClusterInstanceClass that is used by developers to provision and claim MongoDB instances.
mongodb.shared_namespace	""	string	Optional: Name of the namespace that is shared by all provisioned MongoDB instances. By default, each instance is provisioned in its own dedicated namespace.
mongodb.defaults.storage_size_gb	1	integer	Optional: The amount of storage in Gigabytes to give each MongoDB instance by default.
mongodb.enabled	true	boolean	Optional: Provide developers an offering for unmanaged MongoDB instances.
mongodb.helm_chart.chart_pull_secret_ref.name	""	string	Name of the pull secret.
mongodb.helm_chart.chart_pull_secret_ref.namespace	""	string	Namespace of the pull secret.
mongodb.helm_chart.container_pull_secret_ref.name	""	string	Name of the secret. Can be overridden by individual services.
mongodb.helm_chart.container_pull_secret_ref.namespace	""	string	Namespace of the secret. Can be overridden by individual services.
mongodb.helm_chart.repo	""	string	Optional: Repository hosting the Helm chart used to provision MongoDB instances.
mongodb.helm_chart.version	13.13.1	string	Optional: Version of the Helm chart used to provision MongoDB instances.

Kafka

The following table lists configuration that applies to the `kafka` service.

KEY	DEFAULT	TYPE	DESCRIPTION
kafka.instance_class.description	Kafka by Bitnami	string	Optional: Description of the ClusterInstanceClass that is used by developers to provision and claim Kafka instances.
kafka.instance_class.name	kafka-unmanaged	string	Optional: Name of the ClusterInstanceClass that is used by developers to provision and claim Kafka instances.
kafka.shared_namespace	""	string	Optional: Name of the namespace that is shared by all provisioned Kafka instances. By default, each instance is provisioned in its own dedicated namespace.

KEY	DEFAULT	TYPE	DESCRIPTION
kafka.defaults.storage_size_gb	1	integer	Optional: The amount of storage in Gigabytes to give each Kafka instance by default.
kafka.enabled	true	boolean	Optional: Provide developers an offering for unmanaged Kafka instances.
kafka.helm_chart.chart_pull_secret_ref.name	""	string	Name of the pull secret.
kafka.helm_chart.chart_pull_secret_ref.namespace	""	string	Namespace of the pull secret.
kafka.helm_chart.container_pull_secret_ref.name	""	string	Name of the secret. Can be overridden by individual services.
kafka.helm_chart.container_pull_secret_ref.namespace	""	string	Namespace of the secret. Can be overridden by individual services.
kafka.helm_chart.repo	""	string	Optional: Repository hosting the Helm chart used to provision Kafka instances.
kafka.helm_chart.version	22.0.0	string	Optional: Version of the Helm chart used to provision Kafka instances.

Version matrix for Bitnami Services

This topic provides you with a version matrix for the Bitnami Services package and its open source components in Tanzu Application Platform (commonly known as TAP) v1.6.

To view this information for another Tanzu Application Platform version, select the version from the drop-down menu at the top of this page.

The following table has the component versions for the Bitnami Services package.

Component	Version
Bitnami Services package	0.2.0
MySQL Chart	9.5.0
PostgreSQL Chart	12.2.0
RabbitMQ Chart	11.10.0
Redis Chart	17.8.0
MongoDB Chart	13.13.1
Kafka Chart	22.0.0



Note

Tanzu Application Platform patch releases are only added to the table when there is a change to one or more of the other versions in the table. Otherwise, the corresponding versions remain the same for each Tanzu Application Platform patch release.

Overview of Cartographer Conventions

This topic gives you an overview of Cartographer Conventions and how you can use it with Tanzu Application Platform (commonly known as TAP).

Overview

Cartographer Conventions provides a means for operators to express their knowledge about how applications can run on Kubernetes as a convention. Cartographer Conventions supports defining and applying conventions to pods. It applies these opinions to fleets of developer workloads as they are deployed to the platform, saving operator and developer time.

The service has two components:

- **The convention controller:**

The convention controller provides the metadata to the convention server and runs the updates to a [PodTemplateSpec](#) in accordance with convention server's requests.

- **The convention server:**

The convention server receives and evaluates metadata associated with a workload and requests updates to the [PodTemplateSpec](#) associated with that workload. You can have one or more convention servers for a single controller instance.

About applying conventions

The convention server uses criteria defined in the convention to detect whether the configuration of a workload must change. The server receives the OCI metadata from the convention controller. If the metadata meets the criteria defined by the convention server, the conventions are applied. A convention can apply to all workloads regardless of metadata.

Applying conventions by using image metadata

You can define conventions to target workloads by using properties of their OCI metadata.

Conventions can use this information to only apply changes to the configuration of workloads when they match specific criteria. Such as, Spring Boot or .Net apps, or Spring Boot v2.3 and later. Targeted conventions can ensure that uniformity across specific workload types deployed on the cluster.

You can use all the metadata details of an image when evaluating workloads. To see the metadata details, use the Docker CLI command:

```
docker image inspect IMAGE.
```



Note

Depending on how the image was built, metadata might not be available to reliably identify the image type and match the criteria for a convention server. Images built with Cloud Native Buildpacks reliably include rich descriptive metadata. Images built by some other process might not include the same metadata.

Applying conventions without using image metadata

Conventions can apply to workloads without targeting build service metadata. Examples of possible uses of this type of convention include:

- Appending a logging or metrics sidecar

- Adding environment variables
- Adding cached volumes

These kinds of conventions ensure that infrastructure uniformity exists across workloads deployed on the cluster while reducing developer toil.



Important

Adding a sidecar alone does not make the log or metrics collection work. To enable the log or metrics collection:

- Deploy collector agents that are accessible from the Kubernetes cluster
- Configure the required access by using the role-based access control (RBAC) policy

Overview of Cartographer Conventions

This topic gives you an overview of Cartographer Conventions and how you can use it with Tanzu Application Platform (commonly known as TAP).

Overview

Cartographer Conventions provides a means for operators to express their knowledge about how applications can run on Kubernetes as a convention. Cartographer Conventions supports defining and applying conventions to pods. It applies these opinions to fleets of developer workloads as they are deployed to the platform, saving operator and developer time.

The service has two components:

- **The convention controller:**

The convention controller provides the metadata to the convention server and runs the updates to a [PodTemplateSpec](#) in accordance with convention server's requests.

- **The convention server:**

The convention server receives and evaluates metadata associated with a workload and requests updates to the [PodTemplateSpec](#) associated with that workload. You can have one or more convention servers for a single controller instance.

About applying conventions

The convention server uses criteria defined in the convention to detect whether the configuration of a workload must change. The server receives the OCI metadata from the convention controller. If the metadata meets the criteria defined by the convention server, the conventions are applied. A convention can apply to all workloads regardless of metadata.

Applying conventions by using image metadata

You can define conventions to target workloads by using properties of their OCI metadata.

Conventions can use this information to only apply changes to the configuration of workloads when they match specific criteria. Such as, Spring Boot or .Net apps, or Spring Boot v2.3 and later. Targeted conventions can ensure that uniformity across specific workload types deployed on the cluster.

You can use all the metadata details of an image when evaluating workloads. To see the metadata details, use the Docker CLI command:

```
docker image inspect IMAGE.
```



Note

Depending on how the image was built, metadata might not be available to reliably identify the image type and match the criteria for a convention server. Images built with Cloud Native Buildpacks reliably include rich descriptive metadata. Images built by some other process might not include the same metadata.

Applying conventions without using image metadata

Conventions can apply to workloads without targeting build service metadata. Examples of possible uses of this type of convention include:

- Appending a logging or metrics sidecar
- Adding environment variables
- Adding cached volumes

These kinds of conventions ensure that infrastructure uniformity exists across workloads deployed on the cluster while reducing developer toil.



Important

Adding a sidecar alone does not make the log or metrics collection work. To enable the log or metrics collection:

- Deploy collector agents that are accessible from the Kubernetes cluster
- Configure the required access by using the role-based access control (RBAC) policy

Install Cartographer Conventions

Cartographer Conventions is bundled with [Supply Chain Choreographer](#) as of the v0.4.0 release. See [Installing Supply Chain Choreographer](#).

Create conventions with Cartographer Conventions

This topic describes how you can create and deploy custom conventions to the Tanzu Application Platform by using Cartographer Conventions.

Introduction

Tanzu Application Platform helps developers transform their code into containerized workloads with a URL. The Supply Chain Choreographer for Tanzu manages this transformation. For more information, see [Supply Chain Choreographer](#).

[Cartographer Conventions](#) is a key component of the supply chain compositions the choreographer calls into action. Cartographer Conventions enables people in operational roles to efficiently apply their expertise. They can specify the runtime best practices, policies, and conventions of their organization to workloads as they are created on the platform.

You can see the power of this component when the conventions of an organization are applied consistently, at scale, without slowing down application developers.

Opinions and policies vary from organization to organization. Cartographer Convention supports the creation of custom conventions to meet the unique operational needs and requirements of an organization.

Before jumping into the details of creating a custom convention, you can view two distinct components of Cartographer Conventions:

- [Convention server](#)
- [Convention controller](#)

Convention server

The convention server is the component that applies a convention already defined on the server. For a Go example of creating a convention server to add Spring Boot conventions, see [spring-convention-server](#) in GitHub. The resource that structures the request body of the request and response from the server is the [PodConventionContext](#).

The [PodConventionContext](#) is a [webhooks.conventions.carto.run/v1alpha1](#) type that defines the structure used to communicate internally by the webhook convention server.

[PodConventionContext](#) does not exist on the Kubernetes API Server.

[PodConventionContext](#) is a wrapper for two types:

- [PodConventionContextSpec](#) which acts as a wrapper for a [PodTemplateSpec](#) and a list of [ImageConfigs](#) provided in the request body of the server.
- [PodConventionContextStatus](#) which is a status type used to represent the current status of the context retrieved by the request.

For information about an example [PodConventionContext](#), see [PodConventionContext](#) in GitHub. For information about a Convention server and the structure of these types, see [OpenAPI Spec](#) in GitHub.

How the convention server works

Each convention server can host one or more conventions. The application of each convention by a convention server is controlled conditionally. The conditional criteria governing the application of a convention are customizable and are based on the evaluation of a custom Kubernetes resource called [PodIntent](#). [PodIntent](#) is the vehicle through which Cartographer Conventions as a whole delivers its value.

A [PodIntent](#) is created, or updated if already existing, when a workload is run by using a Tanzu Application Platform supply chain. The custom resource includes both the [PodTemplateSpec](#) and the Open Containers Initiative (OCI) image metadata associated with a workload. See the [Kubernetes documentation](#). The conditional criteria for a convention are based on any property or value found in the [PodTemplateSpec](#) or the OCI image metadata available in the [PodIntent](#).

If a convention's criteria are met, the convention server enriches the [PodTemplateSpec](#) in the [PodIntent](#). The convention server also updates the [status](#) section of the [PodIntent](#) with the name of the convention that is applied. Afterward you can learn which conventions were applied to the workload.

To provide flexibility in how conventions are organized, you can deploy multiple convention servers. Each server can contain a convention or set of conventions focused on a specific class of runtime modifications, on a specific language framework, and so on. How the conventions are organized, grouped, and deployed is up to you and the needs of your organization.

Convention servers deployed to the cluster do not take action unless the second component of Cartographer Conventions, the convention controller, triggers them to take action.

The convention controller

The convention controller is the orchestrator of one or many convention servers deployed to the cluster. There are resources available on the `conventions.carto.run/v1alpha1` API that allow the controller to perform its functions. These resources include:

- [ClusterPodConvention](#), which is a resource type that allows the conventions author to register a webhook server with the controller by using its `spec.webhook` field.

```
...
spec:
  selectorTarget: PodTemplateSpec # optional field with options, defaults to Po
dTemplateSpec
  selectors: # optional, defaults to match all workloads
  - <metav1.LabelSelector>
  webhook:
    certificate:
      name: sample-cert
      namespace: sample-conventions
    clientConfig:
      <admissionregistrationv1.WebhookClientConfig>
```

- [PodIntent](#), which is a `conventions.carto.run/v1alpha1` resource type. `PodIntent` continuously reconciles and applies decorations to a workload `PodTemplateSpec`, exposing the enriched `PodTemplateSpec` on its status. Updating the status of the `PodIntent` does not cause side effects on the cluster.

As key types defined on the `conventions.carto.run` API, the `ClusterPodConvention` and `PodIntent` resources are both present on the Kubernetes API Server.

`clusterpodconventions.conventions.carto.run` is used to query `ClusterPodConvention`.
`podintents.conventions.carto.run` is used to query `PodIntent`.

How the convention services's controller works

When the Supply Chain Choreographer creates or updates a `PodIntent` for a workload, the convention controller retrieves the OCI image metadata from the repository containing the workload's images and sets it in the `PodIntent`.

The convention controller then uses a webhook architecture to pass the `PodIntent` to each convention server deployed to the cluster. The controller orchestrates the processing of the `PodIntent` by the convention servers sequentially, based on the `priority` value that is set on the convention server. For more information, see [ClusterPodConvention](#).

After all convention servers have finished processing a `PodIntent` for a workload, the convention controller updates the `PodIntent` with the latest version of the `PodTemplateSpec` and sets `PodIntent.status.conditions[].status=True` where `PodIntent.status.conditions[].type=Ready`.

This status change signals the Supply Chain Choreographer that Cartographer Conventions is finished with its work. The status change also executes whatever steps are waiting in the supply chain.

Getting started

With this high-level understanding of Cartographer Conventions components, you are ready to create and deploy a custom convention.

**Note**

This topic covers developing conventions using [Go](#), but you can use other languages that adhere to the specifications.

Prerequisites

The following prerequisites must be met before a convention is developed and deployed:

- The Kubernetes CLI tool (kubectl) CLI is installed. For more information, see the [Kubernetes documentation](#).
- Tanzu Application Platform prerequisites are installed. For more information, see [Prerequisites](#)
- Tanzu Application Platform components are installed. For more information, see the [Installing the Tanzu CLI](#).
- The default supply chain is installed. Download Supply Chain Security Tools for VMware Tanzu from the [Broadcom Support Portal](#).
- Your kubeconfig context is set to the Tanzu Application Platform-enabled cluster:

```
kubectl config use-context CONTEXT_NAME
```

- The `ko` CLI is installed. Use GitHub to install the `ko` CLI. See the [google/ko](#) GitHub repository. These instructions use `ko` to build an image. If there is an existing image or build process, `ko` is optional.

Define convention criteria

The `server.go` file contains the configuration for the server and the logic the server applies when a workload matches the defined criteria. For example, adding a Prometheus sidecar to web applications, or adding a `workload-type=spring-boot` label to any workload that has metadata, indicating it is a Spring Boot app.

**Important**

For this example, the package `model` defines [resource types](#).

1. The example `server.go` configures the `ConventionHandler` to ingest the webhook requests from the convention controller. See [PodConventionContext](#). Here the handler must only deal with the existing `PodTemplateSpec` and `ImageConfig`.

```
...
import (
    corev1 "k8s.io/api/core/v1"
)
...
func ConventionHandler(template *corev1.PodTemplateSpec, images []model.ImageCo
nfig) ([]string, error) {
    // Create custom conventions
}
...
```

Where:

- `template` is the predefined `PodTemplateSpec` that the convention edits. For more information about `PodTemplateSpec`, see the [Kubernetes documentation](#).
- `images` are the `ImageConfig` used as reference to make decisions in the conventions. In this example, the type was created within the `model` package.

2. The example `server.go` also configures the convention server to listen for requests:

```
...
import (
    "context"
    "fmt"
    "log"
    "net/http"
    "os"
    ...
)
...
func main() {
    ctx := context.Background()
    port := os.Getenv("PORT")
    if port == "" {
        port = "9000"
    }
    http.HandleFunc("/", webhook.ServerHandler(convention.ConventionHandler))
    log.Fatal(webhook.NewConventionServer(ctx, fmt.Sprintf(":%s", port)))
}
...
```

Where:

- `PORT` is a possible environment variable, for this example, defined in the deployment.
- `ServerHandler` is the handler function called when any request comes to the server.
- `NewConventionServer` is the function in charge of configuring and creating the HTTP webhook server.
- `port` is the calculated port of the server to listen for requests. It must match the deployment if the `PORT` variable is not defined in it.
- The `path` or pattern (default to `/`) is the convention server's default path. If it is changed, it must be changed in the `ClusterPodConvention`.



Note

The Server Handler, `func ConventionHandler(...)`, and the configure or start web server, `func NewConventionServer(...)`, is defined in the convention controller in the `webhook` package, but you can use a custom one.

3. Creating the Server Handler, which handles the request from the convention controller with the `PodConventionContext` serialized to JSON.

```
package webhook
...
func ServerHandler(conventionHandler func(template *corev1.PodTemplateSpec, images []model.ImageConfig) ([]string, error)) http.HandlerFunc {
    return func(w http.ResponseWriter, r *http.Request) {
        ...
        // Check request method
        ...
    }
}
```

```

    // Decode the PodConventionContext
    podConventionContext := &model.PodConventionContext{}
    err = json.Unmarshal(body, &podConventionContext)
    if err != nil {
        w.WriteHeader(http.StatusBadRequest)
        return
    }
    // Validate the PodTemplateSpec and ImageConfig
    ...
    // Apply the conventions
    pts := podConventionContext.Spec.Template.DeepCopy()
    appliedConventions, err := conventionHandler(pts, podConventionContext.
Spec.Images)
    if err != nil {
        w.WriteHeader(http.StatusInternalServerError)
        return
    }
    // Update the applied conventions and status with the new PodTemplateSp
ec
    podConventionContext.Status.AppliedConventions = appliedConventions
    podConventionContext.Status.Template = *pts
    // Return the updated PodConventionContext
    w.Header().Set("Content-Type", "application/json")
    w.WriteHeader(http.StatusOK)
    json.NewEncoder(w).Encode(podConventionContext)
}
}
...

```

4. Configure and start the web server by defining the `NewConventionServer` function, which starts the server with the defined port and current context. The server uses the `.crt` and `.key` files to handle TLS traffic.

```

package webhook
...
// Watch handles the security by certificates.
type certWatcher struct {
    CrtFile string
    KeyFile string

    m      sync.Mutex
    keyPair *tls.Certificate
}
func (w *certWatcher) Load() error {
    // Creates a X509KeyPair from PEM encoded client certificate and private ke
y.
    ...
}
func (w *certWatcher) GetCertificate() *tls.Certificate {
    w.m.Lock()
    defer w.m.Unlock()

    return w.keyPair
}
...
func NewConventionServer(ctx context.Context, addr string) error {
    // Define a health check endpoint to readiness and liveness probes.
    http.HandleFunc("/healthz", func(w http.ResponseWriter, r *http.Request) {
        w.WriteHeader(http.StatusOK)
    })

    if err := watcher.Load(); err != nil {
        return err
    }
    // Defines the server with the TLS configuration.

```

```

server := &http.Server{
    Addr: addr,
    TLSConfig: &tls.Config{
        GetCertificate: func(_ *tls.ClientHelloInfo) (*tls.Certificate, error) {
            cert := watcher.GetCertificate()
            return cert, nil
        },
        PreferServerCipherSuites: true,
        MinVersion:                 tls.VersionTLS13,
    },
   BaseContext: func(_ net.Listener) context.Context {
        return ctx
    },
}
go func() {
    <-ctx.Done()
    server.Close()
}()

return server.ListenAndServeTLS("", "")
}

```

Define the convention behavior

Any property or value within the PodTemplateSpec or OCI image metadata associated with a workload defines the criteria for applying conventions. See [PodTemplateSpec](#) in the Kubernetes documentation. The following are a few examples.

Matching criteria by labels or annotations

The `conventions.carto.run/v1alpha1` API allows convention authors to use the `selectorTarget` field which complements the `ClusterPodConvention` matchers to specify whether to consider labels on either one of the following available options:

- `PodTemplateSpec`

```

...
template:
  metadata:
    labels:
      awesome-label: awesome-value
    annotations:
      awesome-annotation: awesome-value
...

```

- `PodIntent`

```

...
kind: PodIntent
metadata:
  name: test-pod
  labels:
    environment: production
...

```

The `selectorTarget` field is configured on the `ClusterPodConvention` as follows:

```

...
spec:
  selectorTarget: PodIntent # optional, defaults to PodTemplateSpec
  selectors: # optional, defaults to match all workloads

```

```
- <metav1.LabelSelector>
webhook:
  certificate:
    name: sample-cert
    namespace: sample-conventions
  clientConfig:
    <admissionregistrationv1.WebhookClientConfig>
```

If you do not provide a value for this optional field while using the `conventions.carto.run/v1alpha1` API, the default value is set to `PodTemplateSpec`.

Matching criteria by environment variables

When using environment variables to define whether the convention is applicable, it must be present in the `PodTemplateSpec`, `spec`, `containers`, and `env` to validate the value.

- `PodTemplateSpec`

```
...
template:
  spec:
    containers:
      - name: awesome-container
        env:
...

```

- Handler

```
package convention
...
func conventionHandler(template *corev1.PodTemplateSpec, images []model.ImageCo
nfig) ([]string, error) {
    if len(template.Spec.Containers[0].Env) == 0 {
        template.Spec.Containers[0].Env = append(template.Spec.Containers[0].En
v, corev1.EnvVar{
            Name: "MY_AWESOME_VAR",
            Value: "MY_AWESOME_VALUE",
        })
        return []string{"awesome-envs-convention"}, nil
    }
    return []string{}, nil
...
}
```

Matching criteria by image metadata

For each image contained within the `PodTemplateSpec`, the convention controller fetches the OCI image metadata and known **bill of materials (BOMs)**, providing it to the convention server as `ImageConfig`. This metadata is introspected to make decisions about how to configure the `PodTemplateSpec`.

Configure and install the convention server

The `server.yaml` defines the Kubernetes components that enable the convention server in the cluster. The next definitions are within the file.

1. A `namespace` is created for the convention server components and has the required objects to run the server. It is used in the `ClusterPodConvention` section to indicate to the controller where the server is.

```

...
---
apiVersion: v1
kind: Namespace
metadata:
  name: awesome-convention
---
...

```

2. (Optional) A certificate manager **Issuer** is created to issue the certificate needed for TLS communication.

```

...
---
# The following manifests contain a self-signed issuer CR and a certificate CR.
# More document can be found at https://docs.cert-manager.io
apiVersion: cert-manager.io/v1
kind: Issuer
metadata:
  name: awesome-selfsigned-issuer
  namespace: awesome-convention
spec:
  selfSigned: {}
---
...

```

3. (Optional) A self-signed **Certificate** is created.

```

...
---
apiVersion: cert-manager.io/v1
kind: Certificate
metadata:
  name: awesome-webhook-cert
  namespace: awesome-convention
spec:
  subject:
    organizations:
      - vmware
    organizationalUnits:
      - tanzu
  commonName: awesome-webhook.awesome-convention.svc
  dnsNames:
    - awesome-webhook.awesome-convention.svc
    - awesome-webhook.awesome-convention.svc.cluster.local
  issuerRef:
    kind: Issuer
    name: awesome-selfsigned-issuer
  secretName: awesome-webhook-cert
  revisionHistoryLimit: 10
---
...

```

4. A Kubernetes **Deployment** is created to run the webhook from. The Service uses the container port defined by the **Deployment** to expose the server.

```

...
---
apiVersion: apps/v1
kind: Deployment
metadata:
  name: awesome-webhook
  namespace: awesome-convention

```

```

spec:
  replicas: 1
  selector:
    matchLabels:
      app: awesome-webhook
  template:
    metadata:
      labels:
        app: awesome-webhook
    spec:
      containers:
        - name: webhook
          # Set the prebuilt image of the convention or use ko to build an image
          # from code.
          # see https://github.com/google/ko
          image: ko://awesome-repo/awesome-user/awesome-convention
          env:
            - name: PORT
              value: "8443"
          ports:
            - containerPort: 8443
              name: webhook
          livenessProbe:
            httpGet:
              scheme: HTTPS
              port: webhook
              path: /healthz
          readinessProbe:
            httpGet:
              scheme: HTTPS
              port: webhook
              path: /healthz
          volumeMounts:
            - name: certs
              mountPath: /config/certs
              readOnly: true
          volumes:
            - name: certs
              secret:
                defaultMode: 420
                secretName: awesome-webhook-cert
---
...

```

5. A Kubernetes `Service` to expose the convention deployment is created. For this example, the exposed port is the default `443`. If you change the port, the `ClusterPodConvention` must be updated.

```

...
---
apiVersion: v1
kind: Service
metadata:
  name: awesome-webhook
  namespace: awesome-convention
  labels:
    app: awesome-webhook
spec:
  selector:
    app: awesome-webhook
  ports:
    - protocol: TCP
      port: 443
      targetPort: webhook

```

```
---
...
```

- The `ClusterPodConvention` adds the convention to the cluster to make it available for the convention controller:

```
...
---
apiVersion: conventions.carto.run/v1alpha1
kind: ClusterPodConvention
metadata:
  name: awesome-convention
  annotations:
    conventions.carto.run/inject-ca-from: "awesome-convention/awesome-webhook-c
ert"
spec:
  webhook:
    clientConfig:
      service:
        name: awesome-webhook
        namespace: awesome-convention
        # path: "/" # default
        # port: 443 # default
```



Important

The `annotations` block is only needed if you use a self-signed certificate. See the [cert-manager documentation](#).

Deploy a convention server

To deploy a convention server:

- Build and install the convention:

ko tool

To build and deploy the convention, use the [ko tool](#) on GitHub. Use the `ko` tool to compile your Go code into a Docker image and push it to the registry

`KO_DOCKER_REGISTRY`.

```
ko apply -f dist/server.yaml
```

Other tool

If a different tool builds the image, the configuration is also applied by using either `kubectl` or `kapp`, setting the correct image in the deployment descriptor.

For `kubectl`, run:

```
kubectl apply -f server.yaml
```

For `kapp`, run:

```
kapp deploy -y -a awesome-convention -f server.yaml
```

- If the server is running, `kubectl get all -n awesome-convention` returns output such as:

NAME	READY	STATUS	RESTARTS	AGE
pod/awesome-webhook-1234567890-12345	1/1	Running	0	8h

NAME	TYPE	CLUSTER-IP	EXTERNAL-IP	PORT(S)
service/awesome-webhook	ClusterIP	10.56.12.49	<none>	443/TCP

NAME	READY	UP-TO-DATE	AVAILABLE	AGE
deployment.apps/awesome-webhook	1/1	1	1	28h

NAME	DESIRED	CURRENT	READY	AGE
replicaset.apps/awesome-webhook-1234563213h	0	0	0	23h
replicaset.apps/awesome-webhook-5b79d5cb59h	0	0	0	28h
replicaset.apps/awesome-webhook-5bf557c9f8h	1	1	1	20h
replicaset.apps/awesome-webhook-77c647c987h	0	0	0	23h
replicaset.apps/awesome-webhook-79d9c6f74ch	0	0	0	23h
replicaset.apps/awesome-webhook-7d9d667b8d	0	0	0	9h
replicaset.apps/awesome-webhook-8668664d75h	0	0	0	23h
replicaset.apps/awesome-webhook-9b6957476h	0	0	0	24h

- To verify that the conventions are applied, ensure that the `PodIntent` of a workload that matches the convention criteria:

```
kubectl -o yaml get podintents.conventions.apps.tanzu.vmware.co awesome-app
```

Example YAML:

```
apiVersion: conventions.carto.run/v1alpha1
kind: PodIntent
metadata:
  creationTimestamp: "2021-10-07T13:30:00Z"
  generation: 1
  labels:
    app.kubernetes.io/component: intent
    carto.run/cluster-supply-chain-name: awesome-supply-chain
    carto.run/cluster-template-name: convention-template
    carto.run/component-name: config-provider
    carto.run/template-kind: ClusterConfigTemplate
    carto.run/workload-name: awesome-app
    carto.run/workload-namespace: default
  name: awesome-app
  namespace: default
ownerReferences:
- apiVersion: carto.run/v1alpha1
  blockOwnerDeletion: true
  controller: true
  kind: Workload
  name: awesome-app
  uid: "*****"
resourceVersion: "*****"
uid: "*****"
spec:
  imagePullSecrets:
  - name: registry-credentials
    serviceAccountName: default
```

```

template:
  metadata:
    annotations:
      developer.conventions/target-containers: workload
    labels:
      app.kubernetes.io/component: run
      app.kubernetes.io/part-of: awesome-app
      carto.run/workload-name: awesome-app
  spec:
    containers:
      - image: awesome-repo.com/awesome-project/awesome-app@sha256:*****
        name: workload
        resources: {}
        securityContext:
          runAsUser: 1000
status:
  conditions:
    - lastTransitionTime: "2021-10-07T13:30:00Z"
      status: "True"
      type: ConventionsApplied
    - lastTransitionTime: "2021-10-07T13:30:00Z"
      status: "True"
      type: Ready
observedGeneration: 1
template:
  metadata:
    annotations:
      awesome-annotation: awesome-value
      conventions.carto.run/applied-conventions: |-
        awesome-label-convention
        awesome-annotation-convention
        awesome-envs-convention
        awesome-image-convention
      developer.conventions/target-containers: workload
    labels:
      awesome-label: awesome-value
      app.kubernetes.io/component: run
      app.kubernetes.io/part-of: awesome-app
      carto.run/workload-name: awesome-app
      conventions.carto.run/framework: go
  spec:
    containers:
      - env:
          - name: MY_AWESOME_VAR
            value: "MY_AWESOME_VALUE"
        image: awesome-repo.com/awesome-project/awesome-app@sha256:*****
        name: workload
        ports:
          - containerPort: 8080
            protocol: TCP
        resources: {}
        securityContext:
          runAsUser: 1000

```

Next Steps

Consider using different matching criteria for the conventions or enhance the supply chain with multiple conventions.

Troubleshoot Cartographer Conventions

This topic describes how you can troubleshoot Cartographer Conventions.

No server in the cluster

Symptoms

When a `PodIntent` is submitted, no `convention` is applied.

Cause

When there are no `convention servers` (`ClusterPodConvention`) deployed in the cluster or none of the existing convention servers applied any conventions, the `PodIntent` is not mutating.

Solution

Deploy a `convention server` (`ClusterPodConvention`) in the cluster.

Server with wrong certificates configured

Symptoms

- When a `PodIntent` is submitted, the `conventions` are not applied.
- The `convention-controller` logs report an error `failed to get CABundle` as follows:

```
{
  "level": "error",
  "ts": 1638222343.6839523,
  "logger": "controllers.PodIntent.PodIntent.ResolveConventions",
  "msg": "failed to get CABundle",
  "ClusterPodConvention": "base-convention",
  "error": "unable to find valid certificaterequests for certificate \"convention-template/webhook-certificate\"",
  "stacktrace": "reflect.Value.Call\n\treflect/value.go:339\ngithub.com/vmware-labs/reconciler-runtime/reconcilers.(*SyncReconciler).sync\n\tgithub.com/vmware-labs/reconciler-runtime@v0.3.0/reconcilers/reconcilers.go:287\ngithub.com/vmware-labs/reconciler-runtime/reconcilers.(*SyncReconciler).Reconcile\n\tgithub.com/vmware-labs/reconciler-runtime@v0.3.0/reconcilers/reconcilers.go:276\ngithub.com/vmware-labs/reconciler-runtime/reconcilers.Sequence.Reconcile\n\tgithub.com/vmware-labs/reconciler-runtime@v0.3.0/reconcilers/reconcilers.go:815\ngithub.com/vmware-labs/reconciler-runtime/reconcilers.(*ParentReconciler).reconcile\n\tgithub.com/vmware-labs/reconciler-runtime@v0.3.0/reconcilers/reconcilers.go:146\ngithub.com/vmware-labs/reconciler-runtime/reconcilers.(*ParentReconciler).Reconcile\n\tgithub.com/vmware-labs/reconciler-runtime@v0.3.0/reconcilers/reconcilers.go:120\nsig.s.k8s.io/controller-runtime/pkg/internal/controller.(*Controller).Reconcile\n\ttsigs.k8s.io/controller-runtime@v0.10.3/pkg/internal/controller/controller.go:114\nsig.s.k8s.io/controller-runtime/pkg/internal/controller.(*Controller).reconcileHandler\n\ttsigs.k8s.io/controller-runtime@v0.10.3/pkg/internal/controller/controller.go:311\nsig.s.k8s.io/controller-runtime/pkg/internal/controller.(*Controller).processNextWorkItem\n\ttsigs.k8s.io/controller-runtime@v0.10.3/pkg/internal/controller/controller.go:266\nsig.s.k8s.io/controller-runtime/pkg/internal/controller.(*Controller).Start.func2.2\n\ttsigs.k8s.io/controller-runtime@v0.10.3/pkg/internal/controller/controller.go:227"
```

Cause

`convention server` (`ClusterPodConvention`) is configured with the wrong certificates. The `convention-controller` cannot figure out the CA Bundle to perform the request to the server.

Solution

Ensure that the `convention server` (`ClusterPodConvention`) is configured with the correct certificates. To do so, verify the value of annotation `conventions.carto.run/inject-ca-from` which

must be set to the used Certificate.



Important

Do not set annotation `conventions.carto.run/inject-ca-from` if no certificate is used.

Server fails when processing a request

Symptoms

- When a `PodIntent` is submitted, the `convention` is not applied.
- The `convention-controller` logs report `failed to apply convention` error like this.

```
{ "level": "error", "ts": 1638205387.8813763, "logger": "controllers.PodIntent.PodInt
ent.ApplyConventions", "msg": "failed to apply convention", "Convention": { "Nam
e": "base-convention", "Selectors": null, "Priority": "Normal", "ClientConfig": { "serv
ice": { "namespace": "convention-template", "name": "webhook", "port": 443 }, "caBundl
e": "..."} }, "error": "Post \"https://webhook.convention-template.svc:443/?timeout
=30s\": EOF", "stacktrace": "reflect.Value.call\n\treflect/value.go:543\nreflect.
Value.Call\n\treflect/value.go:339\ngithub.com/vmware-labs/reconciler-runtime/r
econcilers.(*SyncReconciler).sync\n\tgithub.com/vmware-labs/reconciler-runtime@
v0.3.0/reconcilers/reconcilers.go:287\ngithub.com/vmware-labs/reconciler-runtim
e/reconcilers.(*SyncReconciler).Reconcile\n\tgithub.com/vmware-labs/reconciler-
runtime@v0.3.0/reconcilers/reconcilers.go:276\ngithub.com/vmware-labs/reconcile
r-runtime/reconcilers.Sequence.Reconcile\n\tgithub.com/vmware-labs/reconciler-r
untime@v0.3.0/reconcilers/reconcilers.go:815\ngithub.com/vmware-labs/reconciler
-runtime/reconcilers.(*ParentReconciler).reconcile\n\tgithub.com/vmware-labs/re
conciler-runtime@v0.3.0/reconcilers/reconcilers.go:146\ngithub.com/vmware-labs/
reconciler-runtime/reconcilers.(*ParentReconciler).Reconcile\n\tgithub.com/vmwa
re-labs/reconciler-runtime@v0.3.0/reconcilers/reconcilers.go:120\nsig.s.k8s.io/c
ontroller-runtime/pkg/internal/controller.(*Controller).Reconcile\n\tsig.s.k8s.i
o/controller-runtime@v0.10.0/pkg/internal/controller/controller.go:114\nsig.s.k8
s.io/controller-runtime/pkg/internal/controller.(*Controller).reconcileHandler
\n\tsig.s.k8s.io/controller-runtime@v0.10.0/pkg/internal/controller/controller.g
o:311\nsig.s.k8s.io/controller-runtime/pkg/internal/controller.(*Controller).pro
cessNextWorkItem\n\tsig.s.k8s.io/controller-runtime@v0.10.0/pkg/internal/control
ler/controller.go:266\nsig.s.k8s.io/controller-runtime/pkg/internal/controller.
(*Controller).Start.func2.2\n\tsig.s.k8s.io/controller-runtime@v0.10.0/pkg/inter
nal/controller/controller.go:227" }
```

- When a `PodIntent` status message is updated with `failed to apply convention` from source `base-convention: Post "https://webhook.convention-template.svc:443/?timeout=30s": EOF`.

Cause

An unmanaged error occurs in the `convention server` when processing a request.

Solution

Identify the error and deploy a fixed version of `convention server`:

1. Inspect the `convention server` logs to identify the cause of the error. Retrieve the `convention server` logs by running:

```
kubectl -n convention-template logs deployment/webhook
```

Where:

- o The convention server was deployed as a `Deployment`
 - o `webhook` is the name of the convention server `Deployment`.
 - o `convention-template` is the namespace where the convention server is deployed.
2. Identify the error and deploy a fixed version of `convention server`.

The new deployment is not applied to the existing `PodIntents`. It is only applied to the new `PodIntent` resources. To apply a new deployment to an existing `PodIntent`, update the `PodIntent` so that the reconciler applies if it matches the criteria.

Connection refused because of an unsecured connection

Symptoms

- When a `PodIntent` is submitted, the `convention` is not applied.
- The `convention-controller` logs report a connection-refused error as follows:

```
{ "level": "error", "ts": 1638202791.5734537, "logger": "controllers.PodIntent.PodInt
ent.ApplyConventions", "msg": "failed to apply convention", "Convention": {"Nam
e": "base-convention", "Selectors": null, "Priority": "Normal", "ClientConfig": {"serv
ice": {"namespace": "convention-template", "name": "webhook", "port": 443}, "caBundl
e": "..."}}, "error": "Post \"https://webhook.convention-template.svc:443/?timeout
=30s\": dial tcp 10.56.13.206:443: connect: connection refused", "stacktrace": "r
eflect.Value.call\n\treflect/value.go:543\nreflect.Value.Call\n\treflect/value.
go:339\ngithub.com/vmware-labs/reconciler-runtime/reconcilers.(*SyncReconcile
r).sync\n\tgithub.com/vmware-labs/reconciler-runtime@v0.3.0/reconcilers/reconci
lers.go:287\ngithub.com/vmware-labs/reconciler-runtime/reconcilers.(*SyncReconc
iler).Reconcile\n\tgithub.com/vmware-labs/reconciler-runtime@v0.3.0/reconciler
s/reconcilers.go:276\ngithub.com/vmware-labs/reconciler-runtime/reconcilers.Seq
uence.Reconcile\n\tgithub.com/vmware-labs/reconciler-runtime@v0.3.0/reconciler
s/reconcilers.go:815\ngithub.com/vmware-labs/reconciler-runtime/reconcilers.(*P
arentReconciler).reconcile\n\tgithub.com/vmware-labs/reconciler-runtime@v0.3.0/
reconcilers/reconcilers.go:146\ngithub.com/vmware-labs/reconciler-runtime/recon
cilers.(*ParentReconciler).Reconcile\n\tgithub.com/vmware-labs/reconciler-runti
me@v0.3.0/reconcilers/reconcilers.go:120\nsig.s.k8s.io/controller-runtime/pkg/in
ternal/controller.(*Controller).Reconcile\n\tsig.s.k8s.io/controller-runtime@v0.
10.0/pkg/internal/controller/controller.go:114\nsig.s.k8s.io/controller-runtime/
pkg/internal/controller.(*Controller).reconcileHandler\n\tsig.s.k8s.io/controlle
r-runtime@v0.10.0/pkg/internal/controller/controller.go:311\nsig.s.k8s.io/contro
ller-runtime/pkg/internal/controller.(*Controller).processNextWorkItem\n\tsig.s.
k8s.io/controller-runtime@v0.10.0/pkg/internal/controller/controller.go:266\nsi
gs.k8s.io/controller-runtime/pkg/internal/controller.(*Controller).Start.func2.
2\n\tsig.s.k8s.io/controller-runtime@v0.10.0/pkg/internal/controller/controller.
go:227" }
```

- The `convention server` fails to start because `server gave HTTP response to HTTPS client`. See the `convention server` events by running:

```
kubectl -n convention-template describe pod webhook-594d75d69b-4w4s8
```

Where:

- o The convention server was deployed as a `Deployment`
- o `webhook-594d75d69b-4w4s8` is the name of the `convention server` Pod
- o `convention-template` is the namespace where the convention server is deployed

For example:

```
Name:          webhook-594d75d69b-4w4s8
Namespace:    convention-template
```

```

...
Containers:
  webhook:
    ...
Events:
Type      Reason      Age                From              Message
----      -
Normal    Scheduled   14m                default-scheduler Successfully assigned convention-template/webhook-594d75d69b-4w4s8 to pool
Normal    Pulling     14m                kubelet           Pulling image "awesome-repo/awesome-user/awesome-convention-..."
Normal    Pulled      14m                kubelet           Successfully pulled image "awesome-repo/awesome-user/awesome-convention..." in 1.06032653s
Normal    Created     13m (x2 over 14m)  kubelet           Created container webhook
Normal    Started     13m (x2 over 14m)  kubelet           Started container webhook
Warning   Unhealthy   13m (x9 over 14m)  kubelet           Readiness probe failed: Get "https://10.52.2.74:8443/healthz": http: server gave HTTP response to HTTPS client
Warning   Unhealthy   13m (x6 over 14m)  kubelet           Liveness probe failed: Get "https://10.52.2.74:8443/healthz": http: server gave HTTP response to HTTPS client
Normal    Pulled      9m13s (x6 over 13m) kubelet           Container image "awesome-repo/awesome-user/awesome-convention" already present on machine
Warning   BackOff     4m22s (x32 over 11m) kubelet           Back-off restarting failed container

```

Cause

When a `convention server` is provided without using Transport Layer Security (TLS) but the `Deployment` is configured to use TLS, Kubernetes fails to deploy the `Pod` because of the `liveness probe`.

Solution

Create a differently configured `ClusterPodConvention` resource:

1. Deploy a `convention server` with TLS enabled.
2. Create `ClusterPodConvention` resource for the convention server with annotation `conventions.carto.run/inject-ca-from` as a pointer to the deployed `Certificate` resource.

A self-signed certificate authority (CA) is not propagated to Convention Service

Symptoms

The self-signed CA for a registry is not propagated to Convention Service.

Cause

When you provide the self-signed CA for a registry through `convention-controller.ca_cert_data`, the self-signed CA cannot be propagated to the Convention Service.

Solution

Define the CA by using the available `.shared.ca_cert_data` top-level key to supply the CA to the Convention Service.

No imagePullSecrets configured

Symptoms

When a `PodIntent` is submitted:

- No convention is applied.
- You see an `unauthorized to access repository OR fetching metadata for Images failed` error when you inspect the workload.

Cause

The errors appear when a `workload` is created in a developer namespace where `imagePullSecrets` are not defined on the `default` serviceAccount or on the preferred serviceAccount.

Solution

Add the `imagePullSecrets` name to the default serviceAccount or the preferred serviceAccount.

For example:

```
kind: ServiceAccount
metadata:
  name: default
  namespace: my-workload-namespace
imagePullSecrets:
  - name: registry-credentials # ensure this secret is defined
secrets:
  - name: registry-credentials
```

Convention Service Resources for Cartographer Conventions

This reference topic describes Convention Service resources you can use with Cartographer Conventions.

Overview

There are several resources involved in the application of conventions to workloads. Platform developers and operators typically consume these resources, not application developers.

ClusterPodConvention

The following is an example `conventions.carto.run/v1alpha1` type:

```
---
apiVersion: conventions.carto.run/v1alpha1
kind: ClusterPodConvention
metadata:
  name: sample
spec:
  selectorTarget: PodTemplateSpec # optional field with options, defaults to PodTemplateSpec
  selectors: # optional, defaults to match all workloads
  - <metav1.LabelSelector>
  webhook:
    certificate:
      name: sample-cert
      namespace: sample-conventions
```

```
clientConfig:
  <admissionregistrationv1.WebhookClientConfig>
```

A `ClusterPodConvention` can target one or more workloads of different types. You can apply multiple conventions to a single workload. The conventions author governs how a convention is applied.

To list available conventions in your cluster, run:

```
kubectl get clusterpodconventions.conventions.carto.run
```

For example:

```
$ kubectl get clusterpodconventions.conventions.carto.run
```

NAME	AGE
appliveview-sample	23h
developer-conventions	23h
spring-boot-convention	23h

PodIntent

The following is an example `conventions.carto.run/v1alpha1` resource:

```
apiVersion: conventions.carto.run/v1alpha1
kind: PodIntent
metadata:
  name: sample
spec:
  imagePullSecrets: <[[]corev1.LocalObjectReference> # optional
  serviceAccountName: <string> # optional, defaults to 'default'
  template:
    <corev1.PodTemplateSpec>
status:
  observedGeneration: 1 # reflected from .metadata.generation
  conditions:
  - <metav1.Condition>
  template: # enriched PodTemplateSpec
    <corev1.PodTemplateSpec>
```

List available `PodIntent` resources in your cluster by running:

```
kubectl get podintents.conventions.carto.run -n MY-APPS
```

Where `MY-APPS` are your applications.

For example:

```
# specify relevant namespace
$ kubectl get podintents.conventions.carto.run -n my-apps
```

NAME	READY	REASON	AGE
spring-sample	True	ConventionsApplied	8m5s

When a `PodIntent` is created, the `PodIntent` reconciler lists all `ClusterPodConventions` resources and applies them serially. To ensure the consistency of the enriched `PodTemplateSpec`, the list of `ClusterPodConventions` is sorted alphabetically by name before applying the conventions.

You can use strategic naming to control the order in which the conventions are applied.

After the conventions are applied, the `Ready` status condition on the `PodIntent` resource indicates whether it is applied. A list of all applied conventions is stored under the annotation `conventions.carto.run/applied-conventions`.

There are a few other resources available to the conventions author that are not persisted in your cluster, including:

- [ImageConfig](#)
- [PodConventionContextSpec](#)
- [PodConventionContextStatus](#)
- [PodConventionContext](#)
- [BOM](#)

Collecting Logs from the Controller

A successful deployment of Convention Service creates its resources on the following `cartographer-system` namespace:

```
$ kubectl get all -n cartographer-system
```

NAME	READY	STATUS
pod/cartographer-conventions-controller-manager-76fd86789f-lzh86	1/1	Running

NAME	TYPE	CL
service/cartographer-conventions-controller-manager-metrics-service	ClusterIP	1
service/cartographer-conventions-webhook-service	ClusterIP	1

NAME	READY	UP-TO-DATE	A
deployment.apps/cartographer-conventions-controller-manager	1/1	1	1

NAME	DESIRED	C
replicaset.apps/cartographer-conventions-controller-manager-76fd86789f	1	1

To examine logs from the cartographer conventions controller to help identify issues, inspect the cartographer conventions controller manager pod by running:

```
kubectl -n cartographer-system logs -l control-plane=controller-manager
```

```
...
{"level":"info","ts":"2023-02-06T20:49:19.855086032Z","logger":"MetricsReconciler","msg":"reconciling builders configmap","controller":"configmap","controllerGroup":"","controllerKind":"ConfigMap","ConfigMap":{"name":"controller-manager-metrics-data","namespace":"cartographer-system"},"namespace":"cartographer-system","name":"controller-manager-metrics-data","reconcileID":"6f5e38c7-0ce0-4c74-aff3-f938fb742dab","diff":" map[string]string{\n- \t\"clusterpodconventions_names\": \"appliveview-sample\",\n+ \t\"clusterpodconventions_names\": \"appliveview-sample\nspring-boot-convention\",\n \t\"podintents_count\":\n \t\"0\",\n }\n"}
{"level":"info","ts":"2023-02-06T20:49:20.101742252Z","logger":"MetricsReconcile
```

```
r", "msg": "reconciling builders configmap", "controller": "configmap", "controllerGroup": "", "controllerKind": "ConfigMap", "ConfigMap": {"name": "controller-manager-metrics-data", "namespace": "cartographer-system"}, "namespace": "cartographer-system", "name": "controller-manager-metrics-data", "reconcileID": "3a1950bc-4c55-47bb-8380-2de574bd5d5e", "diff": " map[string]string{\n  \t\"clusterpodconventions_names\": strings.Join({\n  \t\t\"appliveview-sample\n\", \n+ \t\t\"developer-conventions\n\", \n  \t\t\"spring-boot-convention\n\", \n  \t}, \t\"\"), \n  \t\"podintents_count\": \"0\", \n } \n"}
...
service/cartographer-conventions-controller-manager-metrics-service      ClusterIP  10.0.250.231  <none>      8443/TCP  20h
service/cartographer-conventions-webhook-service                        ClusterIP  10.0.6.254    <none>      443/TCP    20h
...

NAME                                                                    READY  UP-TO-DATE  AVAILABLE  AGE
deployment.apps/cartographer-conventions-controller-manager            1/1    1            1          20h

NAME                                                                    DESIRED  CURRENT
replicaset.apps/cartographer-conventions-controller-manager-76fd86789f  1        1
1                                                                    20h
```

In order to examine logs from the cartographer conventions controller to help identify issues, inspect the cartographer conventions controller manager pod as follows

```
kubectl -n conventions-system logs -l control-plane=controller-manager
```

For example:

```
$ kubectl -n conventions-system logs -l control-plane=controller-manager
...
{"level": "info", "ts": "2023-02-06T20:49:19.855086032Z", "logger": "MetricsReconciler", "msg": "reconciling builders configmap", "controller": "configmap", "controllerGroup": "", "controllerKind": "ConfigMap", "ConfigMap": {"name": "controller-manager-metrics-data", "namespace": "conventions-system"}, "namespace": "conventions-system", "name": "controller-manager-metrics-data", "reconcileID": "6f5e38c7-0ce0-4c74-aff3-f938fb742dab", "diff": " map[string]string{\n  \t\"clusterpodconventions_names\": \"appliveview-sample\n\", \n+ \t\t\"clusterpodconventions_names\": \"appliveview-sample\nspring-boot-convention\n\", \n  \t\t\"podintents_count\": \"0\", \n } \n"}
{"level": "info", "ts": "2023-02-06T20:49:20.101742252Z", "logger": "MetricsReconciler", "msg": "reconciling builders configmap", "controller": "configmap", "controllerGroup": "", "controllerKind": "ConfigMap", "ConfigMap": {"name": "controller-manager-metrics-data", "namespace": "conventions-system"}, "namespace": "conventions-system", "name": "controller-manager-metrics-data", "reconcileID": "3a1950bc-4c55-47bb-8380-2de574bd5d5e", "diff": " map[string]string{\n  \t\"clusterpodconventions_names\": strings.Join({\n  \t\t\"appliveview-sample\n\", \n+ \t\t\"developer-conventions\n\", \n  \t\t\"spring-boot-convention\n\", \n  \t}, \t\"\"), \n  \t\"podintents_count\": \"0\", \n } \n"}
...
```

Convention Service Resources for Cartographer Conventions

This reference topic describes Convention Service resources you can use with Cartographer Conventions.

Overview

There are several resources involved in the application of conventions to workloads. Platform developers and operators typically consume these resources, not application developers.

ClusterPodConvention

The following is an example `conventions.carto.run/v1alpha1` type:

```
---
apiVersion: conventions.carto.run/v1alpha1
kind: ClusterPodConvention
metadata:
  name: sample
spec:
  selectorTarget: PodTemplateSpec # optional field with options, defaults to PodTemplateSpec
  selectors: # optional, defaults to match all workloads
  - <metav1.LabelSelector>
  webhook:
    certificate:
      name: sample-cert
      namespace: sample-conventions
    clientConfig:
      <admissionregistrationv1.WebhookClientConfig>
```

A `ClusterPodConvention` can target one or more workloads of different types. You can apply multiple conventions to a single workload. The conventions author governs how a convention is applied.

To list available conventions in your cluster, run:

```
kubectl get clusterpodconventions.conventions.carto.run
```

For example:

```
$ kubectl get clusterpodconventions.conventions.carto.run
```

NAME	AGE
appliveview-sample	23h
developer-conventions	23h
spring-boot-convention	23h

PodIntent

The following is an example `conventions.carto.run/v1alpha1` resource:

```
apiVersion: conventions.carto.run/v1alpha1
kind: PodIntent
metadata:
  name: sample
spec:
  imagePullSecrets: <[[]corev1.LocalObjectReference> # optional
  serviceAccountName: <string> # optional, defaults to 'default'
  template:
    <corev1.PodTemplateSpec>
status:
  observedGeneration: 1 # reflected from .metadata.generation
  conditions:
  - <metav1.Condition>
  template: # enriched PodTemplateSpec
    <corev1.PodTemplateSpec>
```

List available `PodIntent` resources in your cluster by running:

```
kubectl get podintents.conventions.carto.run -n MY-APPS
```

Where **MY-APPS** are your applications.

For example:

```
# specify relevant namespace
$ kubectl get podintents.conventions.carto.run -n my-apps
```

NAME	READY	REASON	AGE
spring-sample	True	ConventionsApplied	8m5s

When a **PodIntent** is created, the **PodIntent** reconciler lists all **ClusterPodConventions** resources and applies them serially. To ensure the consistency of the enriched **PodTemplateSpec**, the list of **ClusterPodConventions** is sorted alphabetically by name before applying the conventions.

You can use strategic naming to control the order in which the conventions are applied.

After the conventions are applied, the **Ready** status condition on the **PodIntent** resource indicates whether it is applied. A list of all applied conventions is stored under the annotation **conventions.carto.run/applied-conventions**.

There are a few other resources available to the conventions author that are not persisted in your cluster, including:

- [ImageConfig](#)
- [PodConventionContextSpec](#)
- [PodConventionContextStatus](#)
- [PodConventionContext](#)
- [BOM](#)

Collecting Logs from the Controller

A successful deployment of Convention Service creates its resources on the following **cartographer-system** namespace:

```
$ kubectl get all -n cartographer-system
```

NAME	READY	STATUS
pod/cartographer-conventions-controller-manager-76fd86789f-lzh86	1/1	Running

NAME	TYPE	CL
service/cartographer-conventions-controller-manager-metrics-service	ClusterIP	1
service/cartographer-conventions-webhook-service	ClusterIP	1

NAME	READY	UP-TO-DATE	A
deployment.apps/cartographer-conventions-controller-manager	1/1	1	1

NAME	DESIRED	C
deployment.apps/cartographer-conventions-controller-manager	1	1

```
...
replicaset.apps/cartographer-conventions-controller-manager-76fd86789f 1 1
1 20h
```

To examine logs from the cartographer conventions controller to help identify issues, inspect the cartographer conventions controller manager pod by running:

```
kubect1 -n cartographer-system logs -l control-plane=controller-manager
...
{"level":"info","ts":"2023-02-06T20:49:19.855086032Z","logger":"MetricsReconciler","msg":"reconciling builders configmap","controller":"configmap","controllerGroup":"","controllerKind":"ConfigMap","ConfigMap":{"name":"controller-manager-metrics-data","namespace":"cartographer-system"},"namespace":"cartographer-system","name":"controller-manager-metrics-data","reconcileID":"6f5e38c7-0ce0-4c74-aff3-f938fb742dab","diff":" map[string]string{\n- \t\"clusterpodconventions_names\": \"appliveview-sample\", \n+ \t\"clusterpodconventions_names\": \"appliveview-sample\nspring-boot-convention\", \n \t\"podintents_count\": \"0\", \n } \n"}
{"level":"info","ts":"2023-02-06T20:49:20.101742252Z","logger":"MetricsReconciler","msg":"reconciling builders configmap","controller":"configmap","controllerGroup":"","controllerKind":"ConfigMap","ConfigMap":{"name":"controller-manager-metrics-data","namespace":"cartographer-system"},"namespace":"cartographer-system","name":"controller-manager-metrics-data","reconcileID":"3a1950bc-4c55-47bb-8380-2de574bd5d5e","diff":" map[string]string{\n \t\"clusterpodconventions_names\": strings.Join({\n \t\t\"appliveview-sample\n\", \n+ \t\t\"developer-conventions\n\", \n \t\t\"spring-boot-convention\n\", \n \t}, \"\"), \n \t\"podintents_count\": \"0\", \n } \n"}
...
service/cartographer-conventions-controller-manager-metrics-service ClusterIP 10.0.250.231 <none> 8443/TCP 20h
service/cartographer-conventions-webhook-service ClusterIP 10.0.6.254 <none> 443/TCP 20h
...
NAME                                     READY   UP-TO-DATE   AVA
ILABLE   AGE
...
deployment.apps/cartographer-conventions-controller-manager 1/1     1             1
20h
NAME                                     DESIRED   CUR
RENT   READY   AGE
...
replicaset.apps/cartographer-conventions-controller-manager-76fd86789f 1 1
1 20h
```

In order to examine logs from the cartographer conventions controller to help identify issues, inspect the cartographer conventions controller manager pod as follows

```
kubect1 -n conventions-system logs -l control-plane=controller-manager
```

For example:

```
$ kubect1 -n conventions-system logs -l control-plane=controller-manager
...
{"level":"info","ts":"2023-02-06T20:49:19.855086032Z","logger":"MetricsReconciler","msg":"reconciling builders configmap","controller":"configmap","controllerGroup":"","controllerKind":"ConfigMap","ConfigMap":{"name":"controller-manager-metrics-data","namespace":"conventions-system"},"namespace":"conventions-system","name":"controller-manager-metrics-data","reconcileID":"6f5e38c7-0ce0-4c74-aff3-f938fb742dab","diff":" map[string]string{\n- \t\"clusterpodconventions_names\": \"appliveview-sample\", \n+ \t\"clusterpodconventions_names\": \"appliveview-sample\nspring-boot-convention\", \n \t\"podintents_count\": \"0\", \n } \n"}
{"level":"info","ts":"2023-02-06T20:49:20.101742252Z","logger":"MetricsReconciler","msg":"reconciling builders configmap","controller":"configmap","controllerGroup":"","controllerKind":"ConfigMap","ConfigMap":{"name":"controller-manager-metrics-data","namesp
```

```

ace": "conventions-system"}, "namespace": "conventions-system", "name": "controller-manager
-metrics-data", "reconcileID": "3a1950bc-4c55-47bb-8380-2de574bd5d5e", "diff": " map[string]
string{\n \t\"clusterpodconventions_names\": strings.Join({\n \t\t\"applianceview-s
ample\n\", \n+ \t\t\"developer-conventions\n\", \n \t\t\"spring-boot-convention\", \n
\t}, \"\\\"), \n \t\"podintents_count\": \"0\", \n } \n\"}
...

```

ImageConfig for Cartographer Conventions

This reference topic describes the `ImageConfig` object you can use with Cartographer Conventions.

Overview

The image configuration object holds the name of the image, the [BOM](#), and the [OCI image configuration](#) with image metadata from the repository.

[OCI image configuration](#) contains the metadata from the image repository.

The [BOM](#) represents the content of the image and can be zero or more per image.

```

{
  "name": "oci-image-name",
  "boms": [{
    "name": "bom-name",
    "raw": "`a byte array`"
  }],
  "config": {
    {
      "created": "2015-10-31T22:22:56.015925234Z",
      "author": "Alyssa P. Hacker <alyspdev@example.com>",
      "architecture": "amd64",
      "os": "linux",
      "config": {
        "User": "alice",
        "ExposedPorts": {
          "8080/tcp": {}
        },
        "Env": [
          "PATH=/usr/local/sbin:/usr/local/bin:/usr/sbin:/usr/bin:/sbin:/bin",
          "FOO=oci_is_a",
          "BAR=well_written_spec"
        ],
        "Entrypoint": [
          "/bin/my-app-binary"
        ],
        "Cmd": [
          "--foreground",
          "--config",
          "/etc/my-app.d/default.cfg"
        ],
        "Volumes": {
          "/var/job-result-data": {},
          "/var/log/my-app-logs": {}
        },
        "WorkingDir": "/home/alice",
        "Labels": {
          "com.example.project.git.url": "https://example.com/project.git",
          "com.example.project.git.commit": "45a939b2999782a3f005621a8d0f29aa387
e1d6b"
        }
      }
    },
    "rootfs": {
      "diff_ids": [
        "sha256:c6f988f4874bb0add23a778f753c65efe992244e148a1d2ec2a8b664fb66bbd1",

```

```

        "sha256:5f70bf18a086007016e948b04aed3b82103a36bea41755b6cddfaf10ace3c6ef"
    ],
    "type": "layers"
  },
  "history": [
    {
      "created": "2015-10-31T22:22:54.690851953Z",
      "created_by": "/bin/sh -c #(nop) ADD file:a3bc1e842b69636f9df5256c49c5374fb4eef1e281fe3f282c65fb853ee171c5 in /"
    },
    {
      "created": "2015-10-31T22:22:55.613815829Z",
      "created_by": "/bin/sh -c #(nop) CMD [\"sh\"]",
      "empty_layer": true
    },
    {
      "created": "2015-10-31T22:22:56.329850019Z",
      "created_by": "/bin/sh -c apk add curl"
    }
  ]
}
}
}

```

PodConventionContextSpec for Cartographer Conventions

This reference topic describes the `PodConventionContextSpec` you can use with Cartographer Conventions.

The Pod convention context specification is a wrapper of the `PodTemplateSpec` and the `ImageConfig` provided in the request body of the server. It represents the original `PodTemplateSpec`. For more information about `PodTemplateSpec`, see the [Kubernetes documentation](#).

For example:

```

{
  "template": {
    "metadata": {
      ...
    },
    "spec": {
      ...
    }
  },
  "imageConfig": {
    ...
    "name": "oci-image-name",
    "config": {
      ...
    }
  }
}

```

PodConventionContextStatus for Cartographer Conventions

This reference topic describes the `PodConventionContextStatus` status type that you can use with Cartographer Conventions.

Overview

The Pod convention context status type is used to represent the current status of the context retrieved by the request. It holds the applied conventions by the server and the modified version of the `PodTemplateSpec`. For more information about `PodTemplateSpec`, see the [Kubernetes documentation](#).

The field `.template` is populated with the enriched `PodTemplateSpec`. The field `.appliedConventions` is populated with the names of any applied conventions.

For example:

```
{
  "template": {
    "metadata": {
      ...
    },
    "spec": {
      ...
    }
  },
  "appliedConventions": [
    "convention-1",
    "convention-2",
    "convention-4"
  ]
}
```

YAML version:

```
---
apiVersion: webhooks.conventions.carto.run/v1alpha1
kind: PodConventionContext
metadata:
  name: sample # the name of the ClusterPodConvention
spec: # the request
  imageConfig:
  template:
    <corev1.PodTemplateSpec>
status: # the response
  appliedConventions: # list of names of conventions applied
  - my-convention
  template:
  spec:
    containers:
    - name : workload
      image: helloworld-go-mod
```

PodConventionContext for Cartographer Conventions

This reference topic describes the `PodConventionContext` that you can use with Cartographer Conventions.

Overview

The Pod convention context is the body of the webhook request and response. The convention controller provides the specification. The convention server sets the status.

The context consists of:

- A wrapper of the individual object description in an API (`TypeMeta`)
- The persistent metadata of a resource (`ObjectMeta`)
- The `PodConventionContextSpec`

- The [PodConventionContextStatus](#)

PodConventionContext Objects

In the [PodConventionContext](#) API resource:

- The object path `.spec.template` field defines the [PodTemplateSpec](#) to be enriched by conventions. For more information about [PodTemplateSpec](#), see the [Kubernetes documentation](#).
- The object path `.spec.imageConfig[]` field defines [ImageConfig](#). Each entry is populated with the name of the image (`.spec.imageConfig[].image`) and its OCI metadata (`.spec.imageConfig[].config`). These entries are generated for each image referenced in [PodTemplateSpec](#) (`.spec.template`).

The following snippet is an example of a [PodConventionContext](#) resource request that the convention server receives. This resource is generated for a [Go language-based application image](#) in GitHub. It is built with Cloud Native Paketo Buildpacks that use Go mod for dependency management.

```
---
apiVersion: webhooks.conventions.carto.run/v1alpha1
kind: PodConventionContext
metadata:
  name: sample # the name of the ClusterPodConvention
spec: # the request
  imageConfig: # one entry per image referenced by the PodTemplateSpec
  - image: sample/go-based-image
    boms:
    - name: cnb-app:.../sbom.cdx.json
      raw: ...
    config:
      entrypoint:
      - "/cnb/process/web"
      domainname: ""
      architecture: "amd64"
      image: "sha256:05b698a4949db54fdb36ea431477867abf51054abd0cbfcfd1bb81cda1842288"
      labels:
        "io.buildpacks.stack.distro.version": "18.04"
        "io.buildpacks.stack.homepage": "https://github.com/paketo-buildpacks/stacks"
        "io.buildpacks.stack.id": "io.buildpacks.stacks.bionic"
        "io.buildpacks.stack.maintainer": "Paketo Buildpacks"
        "io.buildpacks.stack.distro.name": "Ubuntu"
        "io.buildpacks.stack.metadata": `{"app": [{"sha": "sha256:ea4ec23266a3af1204fd64
3de0f3572dd8dbb5697a5ef15bdae844777c19bf8f"}]`,
        "buildpacks": [{"key": "paketo-buildpac`...
        "io.buildpacks.build.metadata": `{"bom": [{"name": "go", "metadata": {"licenses":
[], "name": "Go", "sha256": "7fef8ba6a0786143efcce66b0bbfbfbab02afeef522b4e09833c5b550d7
`...
    template:
      spec:
        containers:
        - name : workload
          image: helloworld-go-mod
```

PodConventionContext Structure

This section introduces more information about the image configuration in [PodConventionContext](#). The convention controller passes this information for each image in good faith. The convention controller is not the source of the metadata, and there is no guarantee that the information is correct.

The `config` field in the image configuration passes through the [OCI Image metadata in GitHub](#) loaded from the registry for the image.

The `boms` field in the image configuration passes through the [BOMs](#) of the image. Conventions might parse the BOMs they want to inspect. There is no guarantee that an image contains a BOM or that the BOM is in a specific format.

ClusterPodConvention for Cartographer Conventions

This reference topic describes the `ClusterPodConvention` that you can use with Cartographer Conventions.

Overview

A `ClusterPodConvention` defines how to connect to convention servers. It provides a way to apply a set of conventions to a `PodTemplateSpec` and artifact metadata. A convention typically focuses on a particular application framework, but might be cross-cutting. Applied conventions must be pure functions.

Define conventions

Webhook servers are the only way to define conventions.

```
apiVersion: conventions.carto.run/v1alpha1
kind: ClusterPodConvention
metadata:
  name: base-convention
  annotations:
    conventions.carto.run/inject-ca-from: "convention-template/webhook-cert"
spec:
  selectorTarget: PodTemplateSpec # optional, defaults to PodTemplateSpec; field options include PodTemplateSpec|PodIntent
  webhook:
    clientConfig:
      service:
        name: webhook
        namespace: convention-template
```

PodIntent for Cartographer Conventions

This reference topic describes `PodIntent` that you can use with Cartographer Conventions.

The conditional criteria governing the application of a convention is customizable and is based on the evaluation of a custom Kubernetes resource called `PodIntent`.

`PodIntent` applies conventions to a workload. A `PodIntent` is created, or updated, when a workload is run by using a Tanzu Application Platform supply chain.

The `.spec.template PodTemplateSpec` is enriched by the conventions and exposed as the `.status.template PodTemplateSpec`. A log of which sources and conventions are applied is captured with the `conventions.carto.run/applied-conventions` annotation on the `PodTemplateSpec`.

For example:

```
apiVersion: conventions.carto.run/v1alpha1
kind: PodIntent
metadata:
  name: sample
spec:
```

```
template:
  spec:
    containers:
      - name: workload
        image: ubuntu
```

BOM for Cartographer Conventions

This reference topic describes the [BOM](#) structure you can use with Cartographer Conventions.

Overview

The [BOM](#) is a structure wrapping a Software Bill of Materials (SBOM) that describes the software components and their dependencies.

Structure

The structure of the [BOM](#) is defined as follows:

```
{
  "name": "BOM-NAME",
  "raw": "BYTE-ARRAY"
}
```

Where:

- [BOM-NAME](#) is the prefix `cnb-sbom:` followed by the location of the [BOM](#) definition in the layer for a Cloud Native Buildpack (CNB) SBOM. For example: `cnb-sbom:/layers/sbom/launch/paketo-buildpacks_executable-jar/sbom.cdx.json`. For a non-CN BOM, the value of `name` might be different.
- [BYTE-ARRAY](#) is the content of the BOM. The content can be in any format or encoding. Read the name to learn how the content is structured.

The convention controller forwards BOMs to the convention servers that it can detect from known sources, including [CNB-SBOM](#).

Overview of cert-manager

`cert-manager` adds certificates and certificate issuers as resource types to Kubernetes clusters. It also helps you to obtain, renew, and use those certificates. For more information about `cert-manager`, see [cert-manager documentation](#).

The `cert-manager` package allows you to, optionally, configure a number of `ClusterIssuer`. When you install Tanzu Application Platform by using profiles, a self-signed `ClusterIssuer` is included by default.

As of `cert-manager.tanzu.vmware.com/2.0.0`, versioning departs from the upstream, open-source project's version. The contained `cert-manager` version is reflected in `Package.spec.includedSoftware`. You can identify the version of `cert-manager` as follows:

```
kubectl get package -n tap-install cert-manager.tanzu.vmware.com.2.0.0 -ojsonpath='{.spec.includedSoftware}' | jq
[
  {
    "description": "X.509 certificate management for Kubernetes and OpenShift",
    "displayName": "cert-manager",
    "version": "1.9.1"
```

```
}
]
```

**Caution**

ACME HTTP01 challenges can fail under certain conditions. For more information, see [ACME challenges](#).

Overview of cert-manager

cert-manager adds certificates and certificate issuers as resource types to Kubernetes clusters. It also helps you to obtain, renew, and use those certificates. For more information about cert-manager, see [cert-manager documentation](#).

The cert-manager package allows you to, optionally, configure a number of `ClusterIssuer`. When you install Tanzu Application Platform by using profiles, a self-signed `ClusterIssuer` is included by default.

As of `cert-manager.tanzu.vmware.com/2.0.0`, versioning departs from the upstream, open-source project's version. The contained cert-manager version is reflected in `Package.spec.includedSoftware`. You can identify the version of cert-manager as follows:

```
kubect1 get package -n tap-install cert-manager.tanzu.vmware.com.2.0.0 -ojsonpath='{.spec.includedSoftware}' | jq
[
  {
    "description": "X.509 certificate management for Kubernetes and OpenShift",
    "displayName": "cert-manager",
    "version": "1.9.1"
  }
]
```

**Caution**

ACME HTTP01 challenges can fail under certain conditions. For more information, see [ACME challenges](#).

Install cert-manager

This topic tells you how to install cert-manager from the Tanzu Application Platform (commonly known as TAP) package repository.

**Note**

Follow the steps in this topic if you do not want to use a profile to install cert-manager. For more information about profiles, see [Components and installation profiles](#).

The cert-manager package installs cert-manager and, optionally, a number of `ClusterIssuer`.

To install cert-manager with a self-signed `ClusterIssuer` from the Tanzu Application Platform package repository:

1. List version information for the package by running:

```
tanzu package available list cert-manager.tanzu.vmware.com -n tap-install
```

For example:

```
$ tanzu package available list cert-manager.tanzu.vmware.com -n tap-install
/ Retrieving package versions for cert-manager.tanzu.vmware.com...
NAME                                VERSION      RELEASED-AT
cert-manager.tanzu.vmware.com      2.0.0       ...
```

2. Discover available configuration for the package by running:

```
tanzu package available get cert-manager.tanzu.vmware.com/2.0.0 --namespace tap
-install --values-schema
```

For example:

```
$ tanzu package available get cert-manager.tanzu.vmware.com/2.0.0 --namespace t
ap-install --values-schema

KEY                                DEFAULT  TYPE      DESCRIPTION
certManager.pspNames              []       array     PodSecurityPolicy names which cert-manag
er is allowed to use
issuers                            []       array     The ClusterIssuers to install - default:
[]
namespace                          string   Cert-manager's namespace - also used as
its cluster resource namespace
https://cert-manager.io/v1.9-docs/faq/cluster-resource/
```

3. Create a file named `cert-manager-rbac.yaml` by using the following sample:

```
apiVersion: rbac.authorization.k8s.io/v1
kind: ClusterRole
metadata:
  name: cert-manager-tap-install-cluster-admin-role
rules:
- apiGroups:
  - '*'
  resources:
  - '*'
  verbs:
  - '*'
---
apiVersion: rbac.authorization.k8s.io/v1
kind: ClusterRoleBinding
metadata:
  name: cert-manager-tap-install-cluster-admin-role-binding
roleRef:
  apiGroup: rbac.authorization.k8s.io
  kind: ClusterRole
  name: cert-manager-tap-install-cluster-admin-role
subjects:
- kind: ServiceAccount
  name: cert-manager-tap-install-sa
  namespace: tap-install
---
apiVersion: v1
kind: ServiceAccount
metadata:
  name: cert-manager-tap-install-sa
  namespace: tap-install
```

Apply the configuration:

```
kubectl apply -f cert-manager-rbac.yaml
```

4. Create a file named `cert-manager-install.yaml` by using the following sample:

```
---
apiVersion: packaging.carvel.dev/v1alpha1
kind: PackageInstall
metadata:
  name: cert-manager
  namespace: tap-install
spec:
  serviceAccountName: cert-manager-tap-install-sa
  packageRef:
    refName: cert-manager.tanzu.vmware.com
    versionSelection:
      constraints: "VERSION-NUMBER"
      prereleases: {}
  values:
    - secretRef:
        name: cert-manager-values
---
apiVersion: v1
kind: Secret
metadata:
  name: cert-manager-values
  namespace: tap-install
stringData:
  values.yaml: |
    issuers:
      - name: tap-ingress-selfsigned
        self_signed: {}
```

Where:

- `VERSION-NUMBER` is the version of the package listed earlier.
- Secret `cert-manager-values` contains your configuration of the cert-manager package.

Apply the configuration:

```
kubectl apply -f cert-manager-install.yaml
```

5. Verify the package installation:

```
tanzu package installed get cert-manager -n tap-install
```

For example:

```
$ tanzu package installed get cert-manager -n tap-install
/ Retrieving installation details for cert-manager...
NAME:                cert-manager
PACKAGE-NAME:        cert-manager.tanzu.vmware.com
PACKAGE-VERSION:     2.0.0
STATUS:              Reconcile succeeded
CONDITIONS:          [{"ReconcileSucceeded True}]
USEFUL-ERROR-MESSAGE:
```

Verify that `STATUS` is `Reconcile succeeded`

6. Verify that cert-manager is up and running:

```
kubectl get deployment -n cert-manager
```

For example:

```
$ kubectl get deployment -n cert-manager
NAME                    READY   UP-TO-DATE   AVAILABLE   AGE
cert-manager            1/1     1             1           5m
cert-manager-cainjector 1/1     1             1           5m
cert-manager-webhook    1/1     1             1           5m
```

7. Verify that the self-signed `ClusterIssuer` is present:

```
kubectl get clusterissuer
```

For example:

```
$ kubectl get clusterissuer
NAME                                READY   AGE
tap-ingress-selfsigned              True    5m
tap-ingress-selfsigned-bootstrap    True    5m
...
```

ACME challenges

cert-manager.io provides APIs for managing certificates on Kubernetes. It is one of the most popular extensions for Kubernetes and has found ubiquitous adoption. Automatic Certificate Management Environment (commonly called ACME) is a protocol for automatically obtaining certificates from certificate authorities. LetsEncrypt has designed and pioneered ACME and is one of the most-popular ACME-style, public CA.

You can use ACME with either an HTTP01 or a DNS01 challenge. In both cases the certificate requester must prove ownership of the domain either by answering a plain HTTP request or by setting a DNS record.

When using cert-manager's `(Cluster)Issuer` with an ACME HTTP01 challenge solver, a `Pod` is run and exposed to the network by using ingress. The `Pod` receives the challenge from the CA and responds. If the challenge is solved successfully, the certificate is issued.

When using cert-manager's `(Cluster)Issuer` with an ACME DNS01 challenge solver, the owner of the domain answers the challenge by setting a `TXT` record under the domain name. If the challenge is solved successfully, the certificate is issued.

Working with DNS01 challenges is harder than with HTTP01 challenges, but can work in situations where HTTP01 can't.

HTTP01 challenges can fail

All of components' images of Tanzu Application Platform are relocated to and pulled from a private registry. This also applies to `cert-manager.tanzu.vmware.com`, including the ACME HTTP01 solver `Pod`'s image.

Due to the design of cert-manager's `(Cluster)Issuer` resources, it is not easy to provide them with credentials to your private registry in a way that works consistently across all namespaces in your cluster.

You can deeply integrate a cluster with a private registry so that image pull secrets don't have to be provided explicitly. This is a common practice with popular cloud-based Kubernetes providers such as GKE, AKS and EKS.

As a result, ACME HTTP01 challenges can fail when your cluster is not deeply integrated with your private registry. In that case VMware recommends the following workarounds:

- (Recommended) Use [DNS01 challenges](#)
- Provide your [\(Cluster\) Issuer](#) with a [ServiceAccount](#) by using its [pod template](#) so that it can pull from your registry. For example:

```

---
apiVersion: v1
kind: ServiceAccount
metadata:
  name: tap-acme-http01-solver
  namespace: #! ...
imagePullSecrets:
  - registry-credentials
---
apiVersion: cert-manager.io/v1
kind: ClusterIssuer
metadata: #! ...
spec:
  #! ...
  acme:
    solvers:
      - http01:
          ingress:
            podTemplate:
              spec:
                serviceAccountName: tap-acme-http01-solver

```

The challenge lies in ensuring that the same [ServiceAccount](#) is available in every namespace that obtains [Certificates](#) from the [ClusterIssuer](#).

Overview of Cloud Native Runtimes

Cloud Native Runtimes for Tanzu is a serverless application runtime for Kubernetes that is based on Knative and runs on a single Kubernetes cluster.

To learn more about Cloud Native Runtimes, see [Cloud Native Runtimes for VMware Tanzu](#).

Overview of Cloud Native Runtimes

Cloud Native Runtimes for Tanzu is a serverless application runtime for Kubernetes that is based on Knative and runs on a single Kubernetes cluster.

To learn more about Cloud Native Runtimes, see [Cloud Native Runtimes for VMware Tanzu](#).

Install Cloud Native Runtimes

This topic describes how you can install Cloud Native Runtimes from the Tanzu Application Platform package repository.



Note

Follow the steps in this topic if you do not want to use a profile to install Cloud Native Runtimes. For information about profiles, see [Components and installation profiles](#).

Prerequisites

Before installing Cloud Native Runtimes:

- Complete all prerequisites for Tanzu Application Platform. See [Prerequisites](#).
- Ensure that Contour v1.24.4 or later is installed. Tanzu Application Platform includes a correctly versioned package of Contour.

Install

To install Cloud Native Runtimes:

1. List version information for the package by running:

```
tanzu package available list cnrs.tanzu.vmware.com --namespace tap-install
```

For example:

```
$ tanzu package available list cnrs.tanzu.vmware.com --namespace tap-install
```

NAME	VERSION	RELEASED-AT
cnrs.tanzu.vmware.com	2.3.1	2023-06-05 19:00:00 -0500 -05

2. (Optional) Make changes to the default installation settings:

1. Gather values schema.

```
tanzu package available get cnrs.tanzu.vmware.com/2.3.1 --values-schema -n tap-install
```

For example:

```
$ tanzu package available get cnrs.tanzu.vmware.com/2.3.1 --values-schema -n tap-install
```

KEY	DEFAULT	TYPE
DESCRIPTION		
domain_config	<nil>	<nil>
> Optional. Overrides the Knative Serving "config-domain" ConfigMap, allowing you to map Knative Services to specific domains. Must be valid YAML and conform to the "config-domain" specification.		
namespace_selector		string
string Specifies a LabelSelector which determines which namespaces should have a wildcard certificate provisioned. Set this property only if the Cluster issuer is type DNS-01 challenge.		
pdb.enable	true	<nil>
> Optional. Set to true to enable a PodDisruptionBudget for the Knative Serving activator and webhook deployments.		
domain_name		string
string Optional. Default domain name for Knative Services.		
ingress.external.namespace	tanzu-system-ingress	string
string Required. Specify a namespace where an existing Contour is installed on your cluster. CNRs will use this Contour instance for external services.		
ingress.internal.namespace	tanzu-system-ingress	string
string Required. Specify a namespace where an existing Contour is installed on your cluster. CNRs will use this Contour instance for internal services.		
lite.enable	false	<nil>
> Optional. Set to "true" to enable lite mode. Reduces CPU and Memory resource requests for all cnrs Deployments, Daemonsets, and StatefulSets by half. Not recommended for production.		

```

domain_template          {{.Name}}.{{.Namespace}}.{{.Domain}}  string
Optional. Specifies the goolang text template string to use when constructing the DNS name for a Knative Service.
kubernetes_distribution  <nil>                                <nil>
Optional. Type of K8s infrastructure being used. Supported Values: openshift
kubernetes_version       0.0.0                                <nil>
Optional. Version of K8s infrastructure being used. Supported Values: valid Kubernetes major.minor.patch versions
allow_manual_configmap_update true                          boolean
Specifies how updates to some CNRs ConfigMaps can be made. Set to True, CNRs allows updates to those ConfigMaps to be made only manually. Set to False, updates to those CNRs ConfigMaps can be made only using overlays. Supported Values: True, False.
ca_cert_data             string
Optional. PEM Encoded certificate data to trust TLS connections with a private CA.
default_external_scheme  <nil>                                string
Optional. Specifies the default scheme to use for Knative Service URLs, regardless of other TLS configurations. Supports either http or https. Cannot be set along with default_tls_secret
default_tls_secret       string
Optional. Specify a fallback TLS Certificate for use by Knative Services if autoTLS is disabled. Will set default external scheme for Knative Service URLs to "https". Requires either "domain_name" or "domain_config" to be set and cannot be set along with "default_external_scheme".
https_redirection        true                          boolean
CNRs ingress will send a 301 redirect for all http connections, asking the clients to use HTTPS
ingress_issuer           string
Cluster issuer to be used in CNRs. To use this property the domain_name or domain_config must be set. Under the hood, when this property is set auto-tls is Enabled.

```

2. Create a `cnr-values.yaml` by using the following sample as a guide:

```

---
domain_name: example.com
ingress:
external:
  namespace: tanzu-system-ingress
internal:
  namespace: tanzu-system-ingress

```



Note

For most installations, you can leave the `cnr-values.yaml` empty, and use the default values.

If you are running on a single-node cluster, such as kind or minikube, set the `lite.enable: true` option. This option reduces resources requests for Cloud Native Runtimes deployments.

Cloud Native Runtimes uses the existing Contour installation in the `tanzu-system-ingress` namespace by default for external and internal access.

If your environment has Contour installed already, and it is not provided by Tanzu Application Platform, you can configure Cloud Native Runtimes to use it. See [Installing Cloud Native Runtimes for Tanzu with an Existing Contour Installation](#) in the Cloud Native Runtimes documentation.

3. Install the package by running:

```
tanzu package install cloud-native-runtimes \
  --package cnrs.tanzu.vmware.com \
  --version 2.3.1 \
  --namespace tap-install \
  --values-file cnr-values.yaml \
  --poll-timeout 30m
```

For example:

```
$ tanzu package install cloud-native-runtimes \
  --package cnrs.tanzu.vmware.com \
  --version 2.3.1 \
  --namespace tap-install \
  --values-file cnr-values.yaml \
  --poll-timeout 30m

| Installing package 'cnrs.tanzu.vmware.com'
| Getting package metadata for 'cnrs.tanzu.vmware.com'
| Creating service account 'cloud-native-runtimes-tap-install-sa'
| Creating cluster admin role 'cloud-native-runtimes-tap-install-cluster-role'
| Creating cluster role binding 'cloud-native-runtimes-tap-install-cluster-role
binding'
- Creating package resource
- Package install status: Reconciling

Added installed package 'cloud-native-runtimes' in namespace 'tap-install'
```

Use an empty file for `cnr-values.yaml` if you want the default installation configuration. Otherwise, see the earlier step to learn more about setting installation configuration values.

4. Verify the package install by running:

```
tanzu package installed get cloud-native-runtimes -n tap-install
```

For example:

```
tanzu package installed get cloud-native-runtimes -n tap-install

Retrieving installation details for cloud-native-runtimes...
NAME:                cloud-native-runtimes
PACKAGE-NAME:        cnrs.tanzu.vmware.com
PACKAGE-VERSION:     2.3.1
STATUS:              Reconcile succeeded
CONDITIONS:          [{ReconcileSucceeded True  }]
USEFUL-ERROR-MESSAGE:
```

Verify that `STATUS` is `Reconcile succeeded`

5. Configure a namespace to use Cloud Native Runtimes:



Important

This step covers configuring a namespace to run Knative services. If you rely on a SupplyChain to deploy Knative services into your cluster, skip this step because namespace configuration is covered in [Set up developer namespaces to use your installed packages](#). Otherwise, you must follow these steps for each namespace where you create Knative services.

Service accounts that run workloads using Cloud Native Runtimes need access to the image pull secrets for the Tanzu package. This includes the `default` service account in a

namespace, which is created automatically but not associated with any image pull secrets. Without these credentials, attempts to start a service fail with a timeout and the pods report that they are unable to pull the `queue-proxy` image.

1. Create an image pull secret in the current namespace and fill it from the `tap-registry` secret mentioned in [Add the Tanzu Application Platform package repository](#). Run these commands to create an empty secret and annotate it as a target of the secretgen controller:

```
kubectl create secret generic pull-secret --from-literal=.dockerconfigjson={ } --type=kubernetes.io/dockerconfigjson
kubectl annotate secret pull-secret secretgen.carvel.dev/image-pull-secret=""
```

2. After you create a `pull-secret` secret in the same namespace as the service account, run the following to add the secret to the service account:

```
kubectl patch serviceaccount default -p '{"imagePullSecrets": [{"name": "pull-secret"}]}'
```

3. Verify that a service account is correctly configured by running:

```
kubectl describe serviceaccount default
```

For example:

```
kubectl describe sa default
Name:                default
Namespace:           default
Labels:              <none>
Annotations:         <none>
Image pull secrets:  pull-secret
Mountable secrets:   default-token-xh6p4
Tokens:              default-token-xh6p4
Events:              <none>
```



Note

The service account has access to the `pull-secret` image pull secret.

Overview of Contour

Contour is an ingress controller for Kubernetes that supports dynamic configuration updates and multi-team ingress delegation. It provides the control plane for the Envoy edge and service proxy. For more information about Contour, see [Contour documentation](#).

Overview of Contour

Contour is an ingress controller for Kubernetes that supports dynamic configuration updates and multi-team ingress delegation. It provides the control plane for the Envoy edge and service proxy. For more information about Contour, see [Contour documentation](#).

Install Contour

This topic tells you how to install Contour from the Tanzu Application Platform (commonly known as TAP) package repository.



Note

Follow the steps in this topic if you do not want to use a profile to install Contour. For more information about profiles, see [Components and installation profiles](#).

To install Contour from the Tanzu Application Platform package repository without a profile:

1. [Install cert-manager](#).
2. List version information for the package by running:

```
tanzu package available list contour.tanzu.vmware.com -n tap-install
```

For example:

```
$ tanzu package available list contour.tanzu.vmware.com -n tap-install
NAME                                VERSION      RELEASED-AT
contour.tanzu.vmware.com            1.24.4      2023-05-22 19:00:00 -0500 -05
```

3. Create a file named `contour-rbac.yaml` by using the following sample and apply the configuration:

```
apiVersion: rbac.authorization.k8s.io/v1
kind: ClusterRole
metadata:
  name: contour-tap-install-cluster-admin-role
rules:
- apiGroups:
  - '*'
  resources:
  - '*'
  verbs:
  - '*'
---
apiVersion: rbac.authorization.k8s.io/v1
kind: ClusterRoleBinding
metadata:
  name: contour-tap-install-cluster-admin-role-binding
roleRef:
  apiGroup: rbac.authorization.k8s.io
  kind: ClusterRole
  name: contour-tap-install-cluster-admin-role
subjects:
- kind: ServiceAccount
  name: contour-tap-install-sa
  namespace: tap-install
---
apiVersion: v1
kind: ServiceAccount
metadata:
  name: contour-tap-install-sa
  namespace: tap-install
```

4. Apply the configuration by running:

```
kubectl apply -f contour-rbac.yaml
```

5. Create a file named `contour-install.yaml` by using the following sample and apply the configuration:



Note

The following configuration installs the Contour package with default options. To make changes to the default installation settings, go to the next step.

```
apiVersion: packaging.carvel.dev/v1alpha1
kind: PackageInstall
metadata:
  name: contour
  namespace: tap-install
spec:
  serviceAccountName: contour-tap-install-sa
  packageRef:
    refName: contour.tanzu.vmware.com
    versionSelection:
      constraints: "VERSION-NUMBER"
      prereleases: {}
```

Where `VERSION-NUMBER` is the version of the package listed earlier.

6. (Optional) Make changes to the default installation settings:

1. Gather values schema by running:

```
tanzu package available get contour.tanzu.vmware.com/1.24.4 --values-schema -n tap-install
```

For example:

```
$ tanzu package available get contour.tanzu.vmware.com/1.24.4 --values-schema -n tap-install
```

KEY	DESCRIPTION	DEFAULT
kubernetes_distribution	The distribution of Kubernetes, used to determine if distributions-specific configurations need to be applied. Options are empty and openshift. If running on an Openshift cluster, this must be set to openshift. When set to openshift, a Role and RoleBinding are created to associate Contour's controllers with the appropriate Openshift Security Context Constraint resource.	
kubernetes_version	The version of Kubernetes being used, for enabling version-specific behaviors. Accept any valid major.minor.patch version of Kubernetes. This field is optional. Currently only has effect when kubernetes_distribution is set to openshift.	0.0.0

```

namespace                                tanzu-system-
ingress      string    The namespace in which to deploy Contour and Envoy.
registry_secret_names [contour-reg-
creds]      array     The names of the placeholder secrets that will cont
ain registry credentials to

pull the Contour and Envoy images.
certificates.duration                                8760h
string    How long the certificates should be valid for.
certificates.renewBefore                            360h
string    How long before expiration the certificates should be renewed.
contour.pspNames                                vmware-system
-restricted string    Pod security policy names to apply to Contour.
contour.replicas                                2
integer   How many Contour pod replicas to have.
contour.resources.contour.requests.memory
string    Memory request to apply to the contour container.
contour.resources.contour.requests.cpu
string    CPU request to apply to the contour container.
contour.resources.contour.limits.cpu
string    CPU limit to apply to the contour container.
contour.resources.contour.limits.memory
string    Memory limit to apply to the contour container.
contour.useProxyProtocol                            false
boolean   Whether to enable PROXY protocol for all Envoy listeners.
contour.configFileContents                          <nil>
<nil>     The YAML contents of the Contour config file. See

https://projectcontour.io/docs/1.24/configuration/#configuration-file for
more

information.
contour.logLevel                                info
string    The Contour log level. Valid options are 'info' and 'debug'.
envoy.pspNames
string    Pod security policy names to apply to Envoy.
envoy.service.externalTrafficPolicy
string    The external traffic policy for the Envoy service. If type is 'C
lusterIP', this

field is ignored. Otherwise, defaults to 'Cluster' for vsphere and 'Loca
l' for

others.
envoy.service.loadBalancerIP
string    The desired load balancer IP. If type is not 'LoadBalancer', thi
s field is

ignored. It is up to the cloud provider whether to honor this request. If
not

specified, then load balancer IP will be assigned by the cloud provider.
envoy.service.nodePorts.http                                0
integer   The node port number to expose Envoy's HTTP listener on. If not
specified, a

node port will be auto-assigned by Kubernetes.
envoy.service.nodePorts.https                            0
integer   The node port number to expose Envoy's HTTPS listener on. If not
specified, a

node port will be auto-assigned by Kubernetes.
envoy.service.type
string    The type of Kubernetes service to provision for Envoy. Valid val
ues are

```

```

'LoadBalancer', 'NodePort', and 'ClusterIP'. If not specified, will default to

'NodePort' for vsphere and 'LoadBalancer' for others.
  envoy.service.annotations                                <nil>
<nil> Annotations to set on the Envoy service.
  envoy.service.aws.LBType                                classic
string The type of AWS load balancer to provision. Options are 'classic' and 'nlb'.
  envoy.service.disableWait                               false
boolean This setting is no longer supported and is included in the schema for backwards
compatibility only.
  envoy.terminationGracePeriodSeconds                     300
integer The termination grace period, in seconds, for the Envoy pods.
  envoy.workload.replicas                                 2
integer The number of Envoy replicas to deploy when 'type' is set to 'Deployment'. If
not specified, it will default to '2'.
  envoy.workload.resources.envoy.limits.cpu               string CPU limit to apply to the envoy container.
  envoy.workload.resources.envoy.limits.memory            string Memory limit to apply to the envoy container.
  envoy.workload.resources.envoy.requests.cpu             string CPU request to apply to the envoy container.
  envoy.workload.resources.envoy.requests.memory          string Memory request to apply to the envoy container.
  envoy.workload.resources.shutdownManager.limits.cpu     string CPU limit to apply to the shutdown-manager container.
  envoy.workload.resources.shutdownManager.limits.memory  string Memory limit to apply to the shutdown-manager container.
  envoy.workload.resources.shutdownManager.requests.cpu   string CPU request to apply to the shutdown-manager container.
  envoy.workload.resources.shutdownManager.requests.memory string Memory request to apply to the shutdown-manager container.
  envoy.workload.type                                     DaemonSet
string The type of Kubernetes workload Envoy is deployed as. Options are 'Deployment'
or 'DaemonSet'. If not specified, will default to 'DaemonSet'.
  envoy.hostNetwork                                       false
boolean Whether to enable host networking for the Envoy pods.
  envoy.hostPorts.https                                   443
integer If enable == true, the host port number to expose Envoy's HTTPS listener on.
  envoy.hostPorts.enable                                  true
boolean Whether to enable host ports. If false, http & https are ignored.
  envoy.hostPorts.http                                    80
integer If enable == true, the host port number to expose Envoy's HTTP listener on.
  envoy.logLevel                                          info
string The Envoy log level.
  infrastructure_provider                                 vsphere
string The underlying infrastructure provider. Options are vsphere, aws, and azure.

This field is not required, but enables better validation and defaulting if
provided.

```

2. Create a `contour-install.yaml` file by using the following sample as a guide:

**Note**

This sample is for installation in an AWS public cloud with [LoadBalancer](#) services.

```

apiVersion: packaging.carvel.dev/v1alpha1
kind: PackageInstall
metadata:
  name: contour
  namespace: tap-install
spec:
  serviceAccountName: contour-tap-install-sa
  packageRef:
    refName: contour.tanzu.vmware.com
    versionSelection:
      constraints: 1.24.4
      prereleases: {}
  values:
  - secretRef:
      name: contour-values
---
apiVersion: v1
kind: Secret
metadata:
  name: contour-values
  namespace: tap-install
stringData:
  values.yaml: |
    envoy:
      service:
        type: LoadBalancer
    infrastructure_provider: aws

```

The `LoadBalancer` type is appropriate for most installations, but local clusters such as `kind` or `minikube` can fail to complete the package install if `LoadBalancer` services are not supported.

For local clusters, you can configure `contour.envoy.service.type` to be `NodePort`. If your local cluster is set up with extra port mappings on the nodes, you might also need configure `envoy.service.nodePorts.http` and `envoy.service.nodePorts.https` to match the port mappings from your local machine into one of the nodes of your local cluster. This pattern is seen when using the [Learning Center on Kind](#).

Contour provides an Ingress implementation by default. If you have another Ingress implementation in your cluster, you must explicitly specify an `IngressClass` to select a particular implementation.

[Cloud Native Runtimes](#) programs Contour HTTPRoutes are based on the installed namespace. The default installation of Cloud Native Runtimes uses a single Contour to provide internet-visible services. You can install a second Contour instance with service type `ClusterIP` if you want to expose some services to only the local cluster. The second instance must be installed in a separate namespace. You must set the Cloud Native Runtimes value `ingress.internal.namespace` to point to this namespace.

7. Install the package by running:

```
kubectl apply -f contour-install.yaml
```

8. Verify the package install by running:

```
tanzu package installed get contour -n tap-install
```

For example:

```
$ tanzu package installed get contour -n tap-install

NAME:                contour
PACKAGE-NAME:        contour.tanzu.vmware.com
PACKAGE-VERSION:     1.24.4
STATUS:              Reconcile succeeded
CONDITIONS:          [{ReconcileSucceeded True  }]
USEFUL-ERROR-MESSAGE:
```

Verify that `STATUS` is `Reconcile succeeded`

9. Verify the installation by running:

```
kubectl get po -n tanzu-system-ingress
```

For example:

```
$ kubectl get po -n tanzu-system-ingress
NAME                                READY   STATUS    RESTARTS   AGE
contour-689789679f-cl8cg            1/1     Running   0           6d16h
contour-689789679f-g2xjn            1/1     Running   0           6d16h
envoy-2b1kl                         2/2     Running   0           6d16h
envoy-2rjtb                         2/2     Running   0           6d16h
envoy-9sljz                         2/2     Running   0           6d16h
envoy-cv5fc                         2/2     Running   0           6d16h
envoy-gvt1f                         2/2     Running   0           6d16h
envoy-qtrxd                         2/2     Running   0           6d16h
```

Ensure that all pods are `Running` with all containers ready.

Configure Cipher Suites and TLS version in Contour

This topic tells you how to configure TLS options for Contour in Tanzu Application Platform (commonly known as TAP).

Contour provides configuration options for TLS version and Cipher Suites. Rather than directly exposed through a top level key in the package, they fall into the category of advanced Contour configurations by using the `contour.configFileContents` key. For more information about these configuration options, see [Contour documentation](#).

To configure TLS options for Contour in Tanzu Application Platform, edit the `contour` section of your TAP values file as follows:

```
contour:
  # ... there maybe some configuration already here
  contour:
    configFileContents:
      tls:
        minimum-protocol-version: "1.2"
        cipher-suites:
          - '[ECDHE-ECDSA-AES128-GCM-SHA256|ECDHE-ECDSA-CHACHA20-POLY1305]'
          - '[ECDHE-RSA-AES128-GCM-SHA256|ECDHE-RSA-CHACHA20-POLY1305]'
          - 'ECDHE-ECDSA-AES256-GCM-SHA384'
          - 'ECDHE-RSA-AES256-GCM-SHA384'
```

Expect to see the following Cipher Suites and TLS version data in the Contour configmap:

```
$ kubectl -n tanzu-system-ingress get configmap contour -oyaml
apiVersion: v1
data:
  contour.yaml: |
    tls:
      minimum-protocol-version: "1.2"
      cipher-suites:
      - '[ECDHE-ECDSA-AES128-GCM-SHA256|ECDHE-ECDSA-CHACHA20-POLY1305]'
      - '[ECDHE-RSA-AES128-GCM-SHA256|ECDHE-RSA-CHACHA20-POLY1305]'
      - ECDHE-ECDSA-AES256-GCM-SHA384
      - ECDHE-RSA-AES256-GCM-SHA384
kind: ConfigMap
metadata:
  ...
```



Important

To update the configmap, you must configure it through Tanzu Application Platform values file. If you change it directly in the configmap, kapp-controller reverts all the changes you made.

Configure Contour to suit your cluster size

This topic tells you how to configure Contour to best suit your cluster size.

By default, Contour installs with the Controllers as a [Deployment](#) and the Envoy's as a [DaemonSet](#). In most cases, this is sufficient. However, VMware recommends running Envoy as a [Deployment](#) in the following scenarios:

- [Smaller Clusters](#)
- [Larger Clusters](#)

Smaller Clusters

On most clusters, a [DaemonSet](#) works without any issues. However, if you limit resources per node and the nodes are heavily used, deploying Envoy as a [DaemonSet](#) might consume unnecessary resources on every node. In this case, VMware recommends using [Deployment](#) with a fixed number of replicas.

Larger Clusters

On larger clusters, running Envoy as a [DaemonSet](#) might be inefficient. The more Envoy's in the cluster, the more resources the Contour controller needs to keep them updated. If the Contour controllers use lots of resources, VMware recommends running Envoy as a [Deployment](#).

Configuring Envoy as a Deployment

To configure Envoy as a [Deployment](#), update your Contour values file as follows:

```
envoy:
  workload:
    type: Deployment
    replicas: N
```

If you use a Tanzu Application Platform values file, you can add these configurations to the [contour](#) section.

Configure Contour to propagate header with Domain Mapping

This topic tells you how to configure Contour for header propagation with Knative Domain Mapping and autoTLS certs.

After `autoTLS` is enabled, a request for a Knative service with Domain Mapping might not maintain the `x-forwarded-proto` header. This can cause issues when the request is forwarded to a system expecting this header to be set to `https`, for example, Spring Security SSO.

You can solve this issue by configuring Contour with `num-trusted-hops: 1`. This allows the header to correctly propagate by using Domain Mapping.



Important

To update the configmap, you must configure it in the Tanzu Application Platform values file. If you change it directly in the configmap, kapp-controller reverts all the changes you made.

Example configuration for Contour by using the Tanzu Application Platform values file (commonly called `tap-values.yaml`):

```
contour:
  contour:
    configFileContents:
      num-trusted-hops: 1
```

Overview of Crossplane

Crossplane is an open source, Cloud Native Computing Foundation (CNCF) project built on the foundation of Kubernetes. Tanzu Application Platform (commonly known as TAP) uses Crossplane to power a number of capabilities, such as dynamic provisioning of services instances with [Services Toolkit](#) and the [Bitnami Services](#).



Note

If installing Tanzu Application Platform to a cluster that already has Crossplane installed, see [Use your existing Crossplane installation](#).

Crossplane with Tanzu Application Platform

Tanzu Application Platform includes a Carvel package named `crossplane.tanzu.vmware.com`, which is included by default in the full, iterate, and run profiles. The package installs [Upbound Universal Crossplane \(UXP\)](#).

In addition, the package includes two pre-configured Crossplane providers: `provider-helm` and `provider-kubernetes`. Both of providers provide useful [Managed Resources](#) that you can use as part of [Composition](#). These are both used by Tanzu Application Platform's [Bitnami Services](#).

The package installs UXP and the providers to the `crossplane-system` namespace.

Getting started

To learn about working with Crossplane in general, see the [Crossplane documentation](#). To learn about how Tanzu Application Platform integrates with Crossplane, see one of the following tutorials to get started.

For apps teams:

- Tutorial: [Working with Bitnami Services](#)

For ops teams:

- Tutorial: [Setup Dynamic Provisioning of Service Instances](#)
- How-to guide: [Use your existing Crossplane installation](#)
- How-to guide: [Delete Crossplane resources when you uninstall Tanzu Application Platform](#)

Alternatively, see the [reference material](#).

Overview of Crossplane

Crossplane is an open source, Cloud Native Computing Foundation (CNCF) project built on the foundation of Kubernetes. Tanzu Application Platform (commonly known as TAP) uses Crossplane to power a number of capabilities, such as dynamic provisioning of services instances with [Services Toolkit](#) and the [Bitnami Services](#).



Note

If installing Tanzu Application Platform to a cluster that already has Crossplane installed, see [Use your existing Crossplane installation](#).

Crossplane with Tanzu Application Platform

Tanzu Application Platform includes a Carvel package named `crossplane.tanzu.vmware.com`, which is included by default in the full, iterate, and run profiles. The package installs [Upbound Universal Crossplane \(UXP\)](#).

In addition, the package includes two pre-configured Crossplane providers: [provider-helm](#) and [provider-kubernetes](#). Both of providers provide useful [Managed Resources](#) that you can use as part of [Composition](#). These are both used by Tanzu Application Platform's [Bitnami Services](#).

The package installs UXP and the providers to the `crossplane-system` namespace.

Getting started

To learn about working with Crossplane in general, see the [Crossplane documentation](#). To learn about how Tanzu Application Platform integrates with Crossplane, see one of the following tutorials to get started.

For apps teams:

- Tutorial: [Working with Bitnami Services](#)

For ops teams:

- Tutorial: [Setup Dynamic Provisioning of Service Instances](#)
- How-to guide: [Use your existing Crossplane installation](#)
- How-to guide: [Delete Crossplane resources when you uninstall Tanzu Application Platform](#)

Alternatively, see the [reference material](#).

Install Crossplane

This topic tells you how to install Crossplane from the Tanzu Application Platform (commonly known as TAP) package repository.



Note

Follow the steps in this topic if you do not want to use a profile to install Crossplane. For more information about profiles, see [Components and installation profiles](#).

If installing Tanzu Application Platform to a cluster that already has Crossplane installed, see [Use your existing Crossplane installation](#).

Prerequisites

Before installing Crossplane:

- Complete all prerequisites to install Tanzu Application Platform. For more information, see [Prerequisites](#).

Install Crossplane

To install Crossplane:

1. See what versions of Crossplane are available to install by running:

```
tanzu package available list -n tap-install crossplane.tanzu.vmware.com
```

For example:

```
$ tanzu package available list -n tap-install crossplane.tanzu.vmware.com
NAME                                VERSION    RELEASED-AT
crossplane.tanzu.vmware.com        0.1.1     2023-03-10 14:24:35 +000
0 UTC
```

2. Install Crossplane by running:

```
tanzu package install crossplane \
  --package crossplane.tanzu.vmware.com \
  --version VERSION-NUMBER \
  --namespace tap-install
```

Where `VERSION-NUMBER` is the Crossplane version you want to install. For example, `0.1.1`.

3. Verify that the package installed by running:

```
tanzu package installed get crossplane -n tap-install
```

In the output, confirm that the `STATUS` value is `Reconcile succeeded`.

For example:

```
$ tanzu package installed get crossplane -n tap-install
NAMESPACE:      tap-install
NAME:           crossplane
PACKAGE-NAME:   crossplane.tanzu.vmware.com
PACKAGE-VERSION: 0.1.1
STATUS:         Reconcile succeeded
CONDITIONS:    - type: ReconcileSucceeded
```

```
status: "True"
reason: ""
message: ""
```

Crossplane how-to guides

This section contains how-to guides for Crossplane.

In this section:

- [Use your existing Crossplane installation](#)
- [Delete Crossplane resources when you uninstall Tanzu Application Platform](#)
- [Troubleshoot Crossplane](#)

Use your existing Crossplane installation

This topic describes how to install Tanzu Application Platform (commonly known as TAP) to a cluster that already has Crossplane installed. This also applies if you want to install Crossplane without using the Tanzu application Platform package, for example, through Helm install.

About installing the Crossplane package

The `crossplane.tanzu.vmware.com` package is included with the Full, Iterate and Run profiles. By default, any installation of Tanzu Application Platform using one of these profiles installs Crossplane to the cluster through the package. In most cases, this is desirable because Crossplane is necessary to support many of the service related capabilities that Tanzu Application Platform offers.

There are some cases where installing the Crossplane package by default is not desirable. For example, if you plan to install Tanzu Application Platform to a cluster that already has Crossplane installed on it, or if you want to install Crossplane by some other means.

Exclude the Crossplane package from the installation

If you want to install Crossplane by other means, exclude the Crossplane package from the Tanzu Application Platform installation.

To do so, add the `crossplane.tanzu.vmware.com` package to the `excluded_packages` array in the `tap-values.yaml` file as follows:

```
# tap-values.yaml

excluded_packages:
- crossplane.tanzu.vmware.com
```



Important

Other Tanzu Application Platform components might depend on the the Crossplane package, for example, [Bitnami Services](#). If you exclude the Crossplane package, you must also exclude any other Tanzu Application Platform package that depends on it.

Delete Crossplane resources when you uninstall Tanzu Application Platform

This topic describes how to configure the Crossplane package to either retain or delete Crossplane resources when you uninstall Tanzu Application Platform.

About deleting Crossplane resources

By default, the `crossplane.tanzu.vmware.com` package is configured to retain all Crossplane CRDs, providers, and managed resources when the package is uninstalled. This is in the interest of caution in relation to accidental deletion of stateful data.

Consider the following scenario. An organization is using Tanzu Application Platform. They have installed the AWS Provider for Crossplane and are offering development teams self-serve access to AWS RDS databases through [Dynamic Provisioning](#). Development teams have created a number of AWS RDS databases and have bound them to their application workloads. The AWS RDS databases now contain stateful data for the applications. If an operator decides to uninstall Tanzu Application Platform, what happens to the AWS RDS databases?

The answer depends on whether you view the life cycle of external services provisioned through the platform to be tied to the life cycle of the platform itself. By default, Tanzu Application Platform does not tie the life cycle of the platform to the life cycle of external services. This means that you must delete any external resources after deleting Tanzu Application Platform. However, Tanzu Application Platform provides the package value `orphan_resources` to override this default behavior.

Override the default retention behavior

You can configure Tanzu Application Platform to delete Crossplane resources to avoid orphaned resources. To do so, update the `tap-values.yaml` as follows:

```
# tap-values.yaml

crossplane:
  orphan_resources: false
```

Troubleshoot Crossplane

This topic explains how you troubleshoot issues related to Crossplane on Tanzu Application Platform (commonly known as TAP).

For the limitations of Crossplane, see [Crossplane limitations](#).

Resource already exists error when installing Crossplane

Symptom:

Installation of Crossplane, or a Tanzu Application Platform profile that includes Crossplane, fails with the error:

```
Resource already exists
```

Explanation:

Crossplane is already installed on the cluster. You cannot install the Crossplane package on a cluster that already has Crossplane installed on it by using another method, such as Helm install.

Solution:

Exclude the Crossplane package in the `tap-values.yaml` file. For more information, see [Use your existing Crossplane installation](#).

Crossplane Providers cannot communicate with systems using a custom CA

Symptom:

A known issue occurs when a Crossplane Provider needs to communicate with systems that are set up with a custom CA. For example, when the Crossplane Helm Provider uses `releases.helm.crossplane.io` to try to pull a Helm chart from a registry that uses a custom CA, you see that:

- The `releases.helm.crossplane.io` never reports the status condition `Ready=True`.
- The `releases.helm.crossplane.io` shows a certificate verification error either:
 - Under the status condition of type `SYNCED`.
 - For the event on the `release.helm.crossplane.io`.

To confirm whether you are affected by this issue:

1. Verify the status by running:

```
kubectl get releases.helm.crossplane.io
```

Example output if you are affected by the issue:

NAME	CHART	VERSION	SYNCED	READY	STATE	REVISION	DESCR
wordpress-example		15.2.5	False	False			
							7m37s

2. Find out more about the reason by running the following command, or similar:

```
kubectl get event --namespace default --field-selector involvedObject.name=wordpress-example,involvedObject.kind=Release,type!=Normal | grep -e 'LAST SEEN' -e 'failed to login'
```

Example output if you are affected by the issue:

LAST SEEN	TYPE	REASON	OBJECT
3m41s	Warning	CannotCreateExternalResource	release/wordpress-example
		failed to install release: failed to login to registry: Get "https://insecure-registry:443/v2/": tls: failed to verify certificate: x509: certificate signed by unknown authority	

Cause:

This issue occurs because the Providers are installed by Crossplane itself rather than directly by the Tanzu Application Platform [Crossplane Package](#). CA certificate data configured through the `tap-values.yaml` file is not passed down to Crossplane Providers. Therefore, the Providers are unable to connect to the systems they need to communicate with, such as, the Helm Provider connecting to a registry hosting the Helm charts or the Kubernetes Provider connecting to a Kubernetes APIServer.

Solution:

Use admission control that allows you to mutate objects, in this case pods, and injects the appropriate CA certificates. You can use any system that can mutate objects at admission to mutate the Crossplane Provider pods. For example, to inject CA certificates you can use this sample in the [Kyverno documentation](#).

**Note**

From Tanzu Application Platform v1.7, the Crossplane Package will inherit this data through `shared.ca_cert_data` of `tap-values.yaml` and configure the Crossplane Providers accordingly. This workaround will no longer be needed.

The `validatingwebhookconfiguration` is not removed when you uninstall the Crossplane Package

Symptom:

The Crossplane Package deploys a `validatingwebhookconfiguration` named `crossplane` during installation. This resource is not deleted when you uninstall the Package.

Solution:

Delete the `validatingwebhookconfiguration` manually by running:

```
kubectl delete validatingwebhookconfiguration crossplane
```

Crossplane component fails to reconcile during upgrade

Symptom:

The Crossplane package fails to reconcile when upgrading the package. The providers and `function-patch-and-transform` fail with error message:

```
cannot resolve package dependencies: missing node in tree
```

You can see the error message if you run these commands:

```
kubectl get provider.pkg -n crossplane-system -o yaml
kubectl get functions -n crossplane-system -o yaml
```

Explanation:

When upgrading the Crossplane package, this issue can occur if the source of the package has changed without changing its version.

Solution:

As a workaround:

1. Edit the `lock` and update the package source for `provider-helm`, `provider-kubernetes`, and `function-patch-and-transform` with the new package source as follows:

```
kubectl edit locks.pkg.crossplane.io lock

packages:
- dependencies: []
  name: provider-helm-919772e449f3
  source: tanzu.packages.broadcom.com/tanzu-application-platform/tap-packages:provider-helm
  type: Provider
  version: ...
- dependencies: []
  name: function-patch-and-transform-7799bf5e4e7f
  source: tanzu.packages.broadcom.com/tanzu-application-platform/tap-packages:f
```

```

unction-patch-and-transform
  type: Function
  version: ...
- dependencies: []
  name: provider-kubernetes-28e95f897554
  source: tanzu.packages.broadcom.com/tanzu-application-platform/tap-packages:provider-kubernetes
  type: Provider
  version: ...

```

2. Verify that the providers and functions are healthy, and that Crossplane package has reconciled by running:

```

kubectl get provider.pkg -n crossplane-system
kubectl get functions -n crossplane-system
kubectl get packageinstall crossplane -n tap-install

```

Crossplane reference

This section provides reference documentation for Crossplane.

In this section:

- [Package values](#)
- [Version matrix](#)
- [Crossplane limitations](#)

Package values for Crossplane

This topic lists the keys and values you can use to configure the behavior of the Crossplane package. Configuration is split between configuration specific to Crossplane in Tanzu Application Platform (commonly known as TAP) and configuration of the Upbound Universal Crossplane (UXP) Helm Chart.

If you are applying configuration to Tanzu Application Platform through the use of profiles and the `tap-values.yaml`, all configuration must exist under the `crossplane` top-level key.

For example:

```

crossplane:
  replicas: 3

```

Tanzu Application Platform configuration

The following table lists configuration specific to Crossplane in Tanzu Application Platform.

KEY	DEFAULT	TYPE	DESCRIPTION
kubernetes_version	""	string	Optional: The Kubernetes version. Valid values are '' or take the form '1.25.0'
kubernetes_distribution	""	string	Optional: The Kubernetes distribution. Valid values are '' or 'openshift'
orphan_resources	true	boolean	Optional: Whether to orphan Crossplane CRDs, providers, and managed resources when the package is uninstalled. If false the resources are deleted.
adopt_resources	false	boolean	Optional: Whether to adopt existing Crossplane CRDs and resources when the package is installed.

KEY	DEFAULT	TYPE	DESCRIPTION
ca_cert_data	""	string	Optional: PEM-encoded certificate data for Crossplane to trust TLS connections with a custom CA certificate.

Standard Crossplane configuration

The following table lists configuration for the UXP Helm Chart.

KEY	DEFAULT	TYPE	DESCRIPTION
replicas	1	integer	
serviceAccount.customAnnotations	'{}'	object	
bootstrapper.resources	'{}'	object	
bootstrapper.config.args		array	
bootstrapper.config.debugMode	false	boolean	
bootstrapper.config.envVars	'{}'	object	
bootstrapper.image.pullPolicy	IfNotPresent	string	
bootstrapper.image.repository	xpkg.upbound.io/upbound/uxp-bootstrapper	string	
bootstrapper.image.tag	v1.11.0-up.1	string	
maxReconcilateRate	""	string	How frequently Crossplane reconciles its resources in seconds.
metrics.enabled	false	boolean	
securityContextCrossplane.allowPrivilegeEscalation	false	boolean	
securityContextCrossplane.readOnlyRootFilesystem	true	boolean	
securityContextCrossplane.runAsGroup	65532	integer	
securityContextCrossplane.runAsUser	65532	integer	

KEY	DEFAULT	TYPE	DESCRIPTION
xfn.securityCont ext.allowPrivile geEscalation	false	boole an	
xfn.securityCont ext.capabilities. add		array	
xfn.securityCont ext.readOnlyRo otFilesystem	true	boole an	
xfn.securityCont ext.runAsGroup	65532	integ er	
xfn.securityCont ext.runAsUser	65532	integ er	
xfn.securityCont ext.seccompPr ofile.type	Unconfined	string	
xfn.args	'{}'	objec t	
xfn.cache.conf igMap	''	string	
xfn.cache.medi um	''	string	
xfn.cache.pvc	''	string	
xfn.cache.sizeLi mit	1Gi	string	
xfn.enabled	false	boole an	
xfn.extraEnvVar s	'{}'	objec t	
xfn.image.pullP olicy	IfNotPresent	string	
xfn.image.repos itory	crossplane/xfn	string	
xfn.image.tag	v1.11.0-up.1	string	
xfn.resources.re quests.cpu	1000m	string	
xfn.resources.re quests.memory	1Gi	string	
xfn.resources.li mits.memory	2Gi	string	
xfn.resources.li mits.cpu	2000m	string	
resourcesCross plane.limits.cpu	500m	string	

KEY	DEFAULT	TYPE	DESCRIPTION
resourcesCrossplane.limits.memory	1Gi	string	
resourcesCrossplane.requests.cpu	250m	string	
resourcesCrossplane.requests.memory	768Mi	string	
resourcesRBACManager.limits.memory	768Mi	string	
resourcesRBACManager.limits.cpu	100m	string	
resourcesRBACManager.requests.cpu	100m	string	
resourcesRBACManager.requests.memory	512Mi	string	
configuration.packages		array	
deploymentStrategy	RollingUpdate	string	
extraEnvVarsCrossplane	'{}'	object	List of extra environment variables to set in the Crossplane deployment. For example, <code>extraEnvironmentVars: sample.key: value1 ANOTHER.KEY: value2</code> results with <code>- name: sample_key value: "value1" - name: ANOTHER_KEY value: "value2"</code>
registryCaBundleConfig	'{}'	object	
billing.awsMarketplace.iamRoleARN	arn:aws:iam::ACCOUNT-ID>:role/ROLE-NAME	string	
billing.awsMarketplace.enabled	false	boolean	
image.pullPolicy	IfNotPresent	string	
image.repository	upbound/crossplane	string	
image.tag	v1.11.0-up.1	string	
packageCache.configMap	""	string	
packageCache.medium	""	string	
packageCache.pvc	""	string	

KEY	DEFAULT	TYPE	DESCRIPTION
packageCache.sizeLimit	5Mi	string	
securityContext.RBACManager.allowPrivilegeEscalation	false	boolean	
securityContext.RBACManager.readOnlyRootFilesystem	true	boolean	
securityContext.RBACManager.runAsGroup	65532	integer	
securityContext.RBACManager.runAsUser	65532	integer	
rbacManager.managementPolicy	Basic	string	
rbacManager.nodeSelector	'{}'	object	
rbacManager.afinity	'{}'	object	
rbacManager.args	'{}'	object	
rbacManager.deploy	true	boolean	
rbacManager.leaderElection	true	boolean	
rbacManager.replicas	1	integer	
rbacManager.skipAggregatedClusterRoles	true	boolean	
rbacManager.tolerations		array	
customAnnotations	'{}'	object	Custom annotations to add to the Crossplane deployment and pod.
customLabels	'{}'	object	Custom labels to add into metadata.
leaderElection	true	boolean	
nodeSelector	'{}'	object	
podSecurityContextCrossplane	'{}'	object	
webhooks.enabled	false	boolean	

KEY	DEFAULT	TYPE	DESCRIPTION
args	'{}'	object	
podSecurityContextRBACManager	'{}'	object	
provider.packages		array	
tolerations		array	
upbound.controlPlane.permission	edit	string	
affinity	'{}'	object	
extraEnvVarsRBACManager	'{}'	object	List of extra environment variables to set in the Crossplane RBAC manager deployment. For example, <code>extraEnvironmentVars: sample.key: value1 ANOTHER.KEY: value2</code> results with <code>- name: sample_key value: "value1" - name: ANOTHER_KEY value: "value2"</code>
nameOverride	crossplane	string	
priorityClassName	""	string	

Version matrix for Crossplane

This topic provides you with a version matrix for the Crossplane package and its open source components in Tanzu Application Platform v1.6 (commonly known as TAP).

To view this information for another Tanzu Application Platform version, select the version from the drop-down menu at the top of this page.

The following table has the component versions for the Crossplane package.

Component	Version
Crossplane package	<ul style="list-style-type: none"> TAP v1.6.11 and earlier: 0.2.1 TAP v1.6.12 and later: 0.2.2
UXP	1.12.1-up.1
Upbound Crossplane	1.12.1-up.2
provider-helm	0.15.0
provider-kubernetes	0.8.0



Note

Tanzu Application Platform patch releases are only added to the table when there is a change to one or more of the other versions in the table. Otherwise, the corresponding versions remain the same for each Tanzu Application Platform patch release.

Crossplane limitations

This topic tells you about the limitations related to Crossplane on Tanzu Application Platform (commonly known as TAP).

For troubleshooting guidance, see [Troubleshoot Crossplane](#).

Cluster performance degradation due to a large number of CRDs

Take care before installing extra Crossplane Providers into Tanzu Application Platform. Some Providers install hundreds of additional CRDs into the cluster.

This is particularly true of the Providers for AWS, Azure, and GCP. For the number of CRDs installed with these Providers, see:

- [provider-aws CRDs](#)
- [provider-azure CRDs](#)
- [provider-gcp CRDs](#)

You must ensure that your cluster has sufficient resource to support this number of additional CRDs if you choose to install them.

Workaround:

To address this issue, Upbound have released a new feature named Provider Families. For more information, see the [Crossplane blog](#).

Overview of Developer Conventions

Developer Conventions is a set of conventions that enable your workloads to support live-update and debug operations in Tanzu Application Platform (commonly known as TAP).

Prerequisites

- [Tanzu CLI Apps plug-in](#)
- [Tanzu Dev Tools for VSCode](#) IDE extension.

Features

Enabling Live Updates

Developer Conventions modifies your workload to enable live updates in either of the following situations:

- You deploy a workload by using the Tanzu CLI Apps plug-in and include the flag `--live-update=true`. For more information about how to deploy a workload with the CLI, see [Tanzu apps workload apply](#).
- You deploy a workload by using the `Tanzu: Live Update Start` option through the Tanzu Developer Tools for VS Code extension. For more information about live updating with the extension, see [Overview of Tanzu Developer Tools for Visual Studio Code](#).

When either of the preceding actions take place, the convention behaves as follows:

1. Looks for the `apps.tanzu.vmware.com/live-update=true` annotation on a PodTemplateSpec associated with a workload.

2. Verifies that the image to which conventions are applied contains a process that can be live updated.
3. Adds annotations to the PodTemplateSpec to modify the Knative properties `minScale` & `maxScale` such that the minimum and maximum number of pods is 1. This ensures the eventual running pod is not scaled down to 0 during a live update session.

After these changes are made, you can use the Tanzu Dev Tools extension or the Tilt CLI to make live update changes to source code directly on the cluster.

Enabling debugging

Developer Conventions modifies your workload to enable debugging in either of the following situations:

- You deploy a workload by using the Tanzu CLI Apps plug-in and include the flag `--debug=true`. For more information about how to deploy a workload with the CLI, see [Tanzu apps workload apply](#).
- You deploy a workload by using the `Tanzu Java Debug Start` option through the Tanzu Developer Tools for VS Code extension. For more information about debugging with the extension, see [Overview of Tanzu Developer Tools for Visual Studio Code](#).

When either of the preceding actions take place, the convention behaves as follows:

1. It looks for the `apps.tanzu.vmware.com/debug=true` annotation on a PodTemplateSpec associated with a workload.
2. It checks for the `debug-8` or `debug-9` labels on the image configuration's bill of materials (BOM).
3. It sets the TimeoutSeconds of the Liveness, Readiness, and Startup probes to 600 if currently set to a lower number.
4. It adds annotations to the PodTemplateSpec to modify the Knative properties `minScale` & `maxScale` such that the minimum and maximum number of pods is 1. This ensures the eventual running pod won't be scaled down to 0 during a debug session.

After these changes are made, you can use the Tanzu Dev Tools extension or other CLI-based debuggers to debug your workload directly on the cluster.



Note

Currently, Developer Conventions only supports debug operations for Java applications.

Next steps

- [Install Developer Conventions](#)

Overview of Developer Conventions

Developer Conventions is a set of conventions that enable your workloads to support live-update and debug operations in Tanzu Application Platform (commonly known as TAP).

Prerequisites

- [Tanzu CLI Apps plug-in](#)

- [Tanzu Dev Tools for VSCode IDE extension](#).

Features

Enabling Live Updates

Developer Conventions modifies your workload to enable live updates in either of the following situations:

- You deploy a workload by using the Tanzu CLI Apps plug-in and include the flag `--live-update=true`. For more information about how to deploy a workload with the CLI, see [Tanzu apps workload apply](#).
- You deploy a workload by using the `Tanzu: Live Update Start` option through the Tanzu Developer Tools for VS Code extension. For more information about live updating with the extension, see [Overview of Tanzu Developer Tools for Visual Studio Code](#).

When either of the preceding actions take place, the convention behaves as follows:

1. Looks for the `apps.tanzu.vmware.com/live-update=true` annotation on a PodTemplateSpec associated with a workload.
2. Verifies that the image to which conventions are applied contains a process that can be live updated.
3. Adds annotations to the PodTemplateSpec to modify the Knative properties `minScale` & `maxScale` such that the minimum and maximum number of pods is 1. This ensures the eventual running pod is not scaled down to 0 during a live update session.

After these changes are made, you can use the Tanzu Dev Tools extension or the Tilt CLI to make live update changes to source code directly on the cluster.

Enabling debugging

Developer Conventions modifies your workload to enable debugging in either of the following situations:

- You deploy a workload by using the Tanzu CLI Apps plug-in and include the flag `--debug=true`. For more information about how to deploy a workload with the CLI, see [Tanzu apps workload apply](#).
- You deploy a workload by using the `Tanzu Java Debug Start` option through the Tanzu Developer Tools for VS Code extension. For more information about debugging with the extension, see [Overview of Tanzu Developer Tools for Visual Studio Code](#).

When either of the preceding actions take place, the convention behaves as follows:

1. It looks for the `apps.tanzu.vmware.com/debug=true` annotation on a PodTemplateSpec associated with a workload.
2. It checks for the `debug-8` or `debug-9` labels on the image configuration's bill of materials (BOM).
3. It sets the TimeoutSeconds of the Liveness, Readiness, and Startup probes to 600 if currently set to a lower number.
4. It adds annotations to the PodTemplateSpec to modify the Knative properties `minScale` & `maxScale` such that the minimum and maximum number of pods is 1. This ensures the eventual running pod won't be scaled down to 0 during a debug session.

After these changes are made, you can use the Tanzu Dev Tools extension or other CLI-based debuggers to debug your workload directly on the cluster.

**Note**

Currently, Developer Conventions only supports debug operations for Java applications.

Next steps

- [Install Developer Conventions](#)

Install Developer Conventions

This document tells you how to install Developer Conventions from the Tanzu Application Platform (commonly known as TAP) package repository.

**Note**

Follow the steps in this topic if you do not want to use a profile to install Developer Conventions. For more information about profiles, see [About Tanzu Application Platform components and profiles](#).

Prerequisites

Before installing Developer Conventions:

- Complete all prerequisites to install Tanzu Application Platform. For more information, see [Prerequisites](#).
- Install [Supply Chain Choreographer](#).

Install

To install Developer Conventions:

1. Get the exact name and version information for the Developer Conventions package to be installed by running:

```
tanzu package available list developer-conventions.tanzu.vmware.com --namespace tap-install
```

For example:

```
$ tanzu package available list developer-conventions.tanzu.vmware.com --namespace tap-install
- Retrieving package versions for developer-conventions.tanzu.vmware.com
NAME                                VERSION    RELEASED-AT
developer-conventions.tanzu.vmware.com 0.3.0     2021-10-19T00:00:00Z
```

2. Install the package by running:

```
tanzu package install developer-conventions \
  --package developer-conventions.tanzu.vmware.com \
  --version 0.3.0 \
  --namespace tap-install
```

3. Verify the package install by running:

```
tanzu package installed get developer-conventions --namespace tap-install
```

For example:

```
tanzu package installed get developer-conventions -n tap-install
| Retrieving installation details for developer-conventions...
NAME:                developer-conventions
PACKAGE-NAME:        developer-conventions.tanzu.vmware.com
PACKAGE-VERSION:     0.3.0
STATUS:              Reconcile succeeded
CONDITIONS:          [{ReconcileSucceeded True  }]
USEFUL-ERROR-MESSAGE:
```

Verify that `STATUS` is `Reconcile succeeded`

Resource limits

The following resource limits are set on the Developer Conventions service:

```
resources:
  limits:
    cpu: 100m
    memory: 256Mi
  requests:
    cpu: 100m
    memory: 20Mi
```

Uninstall

To uninstall Developer Conventions, follow the guide for [Uninstall Tanzu Application Platform packages](#). The package name for developer conventions is `developer-conventions`.

Run Developer Conventions on an OpenShift cluster

This topic tells you about considerations for running Developer Conventions on OpenShift.

On OpenShift clusters, Developer Conventions must run with a custom SecurityContextConstraint (SCC) to enable compliance with restricted Kubernetes pod security standards. Tanzu Application Platform configures the following SCC for the Developer Convention's webhook when you configure the `kubernetes_distribution: openshift` key in the `tap-values.yaml` file.

Specification follows:

```
---
apiVersion: security.openshift.io/v1
kind: SecurityContextConstraints
metadata:
  name: developer-conventions-scc
allowHostDirVolumePlugin: false
allowHostIPC: false
allowHostNetwork: false
allowHostPID: false
allowHostPorts: false
allowPrivilegeEscalation: false
allowPrivilegedContainer: false
defaultAddCapabilities: null
fsGroup:
  type: RunAsAny
priority: null
readOnlyRootFilesystem: false
```

```
requiredDropCapabilities: null
runAsUser:
  type: MustRunAsNonRoot
seLinuxContext:
  type: MustRunAs
supplementalGroups:
  type: RunAsAny
volumes:
- secret
seccompProfiles: []
groups:
- system:serviceaccounts:developer-conventions
```

Overview of Eventing



Important

Eventing is deprecated and marked for removal in Tanzu Application Platform v1.7.0.

Eventing in Tanzu Application Platform (commonly known as TAP) is a collection of APIs based on [Knative Eventing](#) that allows the use of an event-driven architecture with your applications.

Overview of Eventing



Important

Eventing is deprecated and marked for removal in Tanzu Application Platform v1.7.0.

Eventing in Tanzu Application Platform (commonly known as TAP) is a collection of APIs based on [Knative Eventing](#) that allows the use of an event-driven architecture with your applications.

Install Eventing

This topic tells you how to install the Eventing package from the Tanzu Application Platform (commonly known as TAP) package repository.



Note

Follow the steps in this topic if you do not want to use a profile to install Eventing. For more information about profiles, see [Components and installation profiles](#).

Prerequisites

Before installing Eventing:

- Complete all prerequisites to install Tanzu Application Platform. For more information, see [Prerequisites](#).

Install

To install Eventing:

1. List version information for the package by running:

```
tanzu package available list eventing.tanzu.vmware.com --namespace tap-install
```

For example:

```
$ tanzu package available list eventing.tanzu.vmware.com --namespace tap-install
- Retrieving package versions for eventing.tanzu.vmware.com...
NAME                                VERSION  RELEASED-AT
eventing.tanzu.vmware.com          2.0.1   2022-10-11T00:00:00Z
```

2. (Optional) Make changes to the default installation settings:

1. Gather values schema.

```
tanzu package available get eventing.tanzu.vmware.com/2.0.1 --values-schema -n tap-install
```

For example:

```
$ tanzu package available get eventing.tanzu.vmware.com/2.0.1 --values-schema -n tap-install
| Retrieving package details for eventing.tanzu.vmware.com/2.0.1...
KEY          DEFAULT  TYPE      DESCRIPTION
lite.enable  false    boolean   Optional: Not recommended for production. Set to "true" to reduce CPU and Memory resource requests for all Eventing Deployments, Daemonsets, and Statefulsets by half. On by default when "provider" is set to "local".
pdb.enable   true     boolean   Optional: Set to true to enable Pod Disruption Budget. If provider local is set to "local", the PDB will be disabled automatically.
provider     <nil>   string    Optional: Kubernetes cluster provider. To be specified if deploying Eventing on a local Kubernetes cluster provider.
```

2. Create a `eventing-values.yaml` by using the following sample `eventing-values.yaml` as a guide:

```
---
lite:
  enable: true
```



Note

For most installations, you can leave the `eventing-values.yaml` empty, and use the default values.

If you run on a single-node cluster, such as kind or minikube, set the `lite.enable:` property to `true`. This option reduces resources requests for Eventing deployments.

3. Install the package by running:

```
tanzu package install eventing -p eventing.tanzu.vmware.com -v 2.0.1 -n tap-install -f eventing-values.yaml --poll-timeout 30m
```

For example:

```
$ tanzu package install eventing -p eventing.tanzu.vmware.com -v 2.0.1 -n tap-install -f eventing-values.yaml --poll-timeout 30m
```

```

- Installing package 'eventing.tanzu.vmware.com'
| Getting package metadata for 'eventing.tanzu.vmware.com'
| Creating service account 'eventing-tap-install-sa'
| Creating cluster admin role 'eventing-tap-install-cluster-role'
| Creating cluster role binding 'eventing-tap-install-cluster-rolebinding'
| Creating secret 'eventing-tap-install-values'
| Creating package resource
| Waiting for 'PackageInstall' reconciliation for 'eventing'
| 'PackageInstall' resource install status: Reconciling

Added installed package 'eventing'

```

Use an empty file for `eventing-values.yaml` to enable default installation configuration. Otherwise, see the previous step to set installation configuration values.

4. Verify the package install by running:

```
tanzu package installed get eventing -n tap-install
```

For example:

```

tanzu package installed get eventing -n tap-install
| Retrieving installation details for eventing...
NAME:                eventing
PACKAGE-NAME:        eventing.tanzu.vmware.com
PACKAGE-VERSION:     2.0.1
STATUS:              Reconcile succeeded
CONDITIONS:          [{"ReconcileSucceeded True  }]
USEFUL-ERROR-MESSAGE:

```

Verify that `STATUS` is `Reconcile succeeded`.

Overview of Flux CD Source Controller

Flux CD Source Controller provides you with APIs for acquiring resources such as Git, Helm repositories and S3 buckets on the cluster. For more information, see [Flux CD Source Controller documentation](#).

The source-controller implements the `source.toolkit.fluxcd.io` API in GitHub and is a core component of the [GitOps toolkit](#).

Overview of Flux CD Source Controller

Flux CD Source Controller provides you with APIs for acquiring resources such as Git, Helm repositories and S3 buckets on the cluster. For more information, see [Flux CD Source Controller documentation](#).

The source-controller implements the `source.toolkit.fluxcd.io` API in GitHub and is a core component of the [GitOps toolkit](#).

Install Flux CD Source Controller

This topic tells you how to install Flux CD Source Controller from the Tanzu Application Platform (commonly known as TAP) package repository.



Note

Follow the steps in this topic if you do not want to use a profile to install Flux CD Source Controller. For more information about profiles, see [Components and installation profiles](#).

Prerequisites

Before installing Flux CD Source Controller:

- Complete all prerequisites to install Tanzu Application Platform. For more information, see [Prerequisites](#).
- Install cert-manager on the cluster. For more information, see [Install cert-manager](#).

Configuration

The Flux CD Source Controller package has no configuration values.

Installation

To install Flux CD Source Controller from the Tanzu Application Platform package repository:

1. List version information for the package by running:

```
tanzu package available list fluxcd.source.controller.tanzu.vmware.com -n tap-install
```

For example:

```
$ tanzu package available list fluxcd.source.controller.tanzu.vmware.com -n tap-install
\ Retrieving package versions for fluxcd.source.controller.tanzu.vmware.com...
m...
      NAME                                     VERSION  RELEASED-AT
      fluxcd.source.controller.tanzu.vmware.com 0.16.0   2021-10-27 19:00:00 -0500 -05
```

2. Install the package by running:

```
tanzu package install fluxcd-source-controller -p fluxcd.source.controller.tanzu.vmware.com -v VERSION-NUMBER -n tap-install
```

Where:

- `VERSION-NUMBER` is the version of the package listed in step 1.

For example:

```
tanzu package install fluxcd-source-controller -p fluxcd.source.controller.tanzu.vmware.com -v 0.16.0 -n tap-install
\ Installing package 'fluxcd.source.controller.tanzu.vmware.com'
| Getting package metadata for 'fluxcd.source.controller.tanzu.vmware.com'
| Creating service account 'fluxcd-source-controller-tap-install-sa'
| Creating cluster admin role 'fluxcd-source-controller-tap-install-cluster-role'
| Creating cluster role binding 'fluxcd-source-controller-tap-install-cluster-rolebinding'
| Creating package resource
- Waiting for 'PackageInstall' reconciliation for 'fluxcd-source-controller'
| 'PackageInstall' resource install status: Reconciling
```

```
Added installed package 'fluxcd-source-controller'
```

This package creates a new namespace called `flux-system`. This namespace hosts all the elements of fluxcd.

3. Verify the package install by running:

```
tanzu package installed get fluxcd-source-controller -n tap-install
```

For example:

```
tanzu package installed get fluxcd-source-controller -n tap-install
\ Retrieving installation details for fluxcd-source-controller...
NAME:                fluxcd-source-controller
PACKAGE-NAME:        fluxcd.source.controller.tanzu.vmware.com
PACKAGE-VERSION:     0.16.0
STATUS:              Reconcile succeeded
CONDITIONS:          [{"ReconcileSucceeded True  "}]
USEFUL-ERROR-MESSAGE:
```

Verify that `STATUS` is `Reconcile succeeded`.

```
kubectl get pods -n flux-system
```

For example:

```
$ kubectl get pods -n flux-system
NAME                                READY   STATUS    RESTARTS   AGE
source-controller-69859f545d-1l8fj  1/1     Running   0           3m38s
```

Verify that `STATUS` is `Running`.

Try fluxcd-source-controller

1. Verify the main components of `fluxcd-source-controller` were installed by running:

```
kubectl get all -n flux-system
```

Expect to see the following outputs or similar:

```
NAME                                READY   STATUS    RESTARTS   AGE
pod/source-controller-7684c85659-2zfxb  1/1     Running   0           40m

NAME                                TYPE                CLUSTER-IP      EXTERNAL-IP    PORT(S)
AGE
service/source-controller             ClusterIP           10.108.138.74   <none>         80/TCP
40m

NAME                                READY   UP-TO-DATE   AVAILABLE   AGE
deployment.apps/source-controller     1/1     1             1           40m

NAME                                DESIRED   CURRENT   READY   AGE
replicaset.apps/source-controller-7684c85659  1         1         1       40m
```

2. Verify all the CRD were installed by running:

```
kubectl get crds -n flux-system | grep ".fluxcd.io"
buckets.source.toolkit.fluxcd.io      2022-03-07T19:20:14Z
gitrepositories.source.toolkit.fluxcd.io 2022-03-07T19:20:14Z
```

helmcharts.source.toolkit.fluxcd.io	2022-03-07T19:20:14Z
helmrepositories.source.toolkit.fluxcd.io	2022-03-07T19:20:14Z

**Note**

You will communicate with `fluxcd-source-controller` through its CRDs.

- If you are using a Git repository with a custom CA certificate, provide this certificate to the Flux CD Source Controller directly by including the CA in the service account used by the supply chain.

The Tanzu Application Platform distribution of Flux CD Source Controller does not support the Tanzu Application Platform `shared.ca_cert_data` field. For more information about setting the CA in the service account, see [Use Git authentication with Supply Chain Choreographer](#).

- Follow these steps to consume a `GitRepository` object:

1. Create the following `gitrepository-sample.yaml` file:

```
apiVersion: source.toolkit.fluxcd.io/v1beta1
kind: GitRepository
metadata:
  name: gitrepository-sample
spec:
  interval: 1m
  url: https://github.com/vmware-tanzu/application-accelerator-samples
  ref:
    branch: main
```

2. Apply the created conf:

```
kubectl apply -f gitrepository-sample.yaml
gitrepository.source.toolkit.fluxcd.io/gitrepository-sample created
```

3. Verify the git-repository was fetched correctly:

```
kubectl get GitRepository
NAME                                URL
READY STATUS                        AGE
gitrepository-sample               https://github.com/vmware-tanzu/application-accele
rator-samples True Fetched revision: main/132f4e719209eb10b9485302f8
593fc0e680f4fc 4s
```

For more examples, see the samples directory on [fluxcd/source-controller/samples](#) in GitHub.

Documentation

For documentation specific to `fluxcd-source-controller`, see the main repository [fluxcd/source-controller](#) in GitHub.

Use Flux CD Source Controller

To build workload by using the `GitRepository` API of Flux CD Source Controller, see [Building from source with Supply Chain Choreographer](#).

For authenticating to Git repositories by using Flux CD Source Controller in Supply Chain Choreographer, see [Git authentication with Supply Chain Choreographer](#).

Overview of Learning Center for Tanzu Application Platform



Important

Learning Center is deprecated and marked for removal in Tanzu Application Platform v1.7.0. Use [Tanzu Academy](#) instead for all Tanzu Application Platform learning and education needs.

Learning Center provides a platform for creating and self-hosting workshops. It allows you to create workshops from markdown files that are displayed to the learner in a terminal shell environment with an instructional wizard UI.

The UI can embed slide content, an integrated development environment (IDE), a web console for accessing the Kubernetes cluster, and other custom web applications.

Although Learning Center requires Kubernetes to run, and is used to teach users about Kubernetes, you can use it to host training for other purposes as well. For example, you can use it to help train users in web-based applications, use of databases, or programming languages, where the user has no interest or need for Kubernetes.

Use cases

Use case scenarios that Learning Center supports include:

- Supervised workshops. For example, a workshop run at a conference, at a customer site, or online. The workshop has a set time period and you know the maximum number of users to expect. After the training is complete, the Kubernetes cluster created for the workshop is destroyed.
- Temporary learning portal. This is for when you must provide access to a small set of workshops for a short duration for hands on demos at a conference vendor booth. Users select which topic they want to learn about and do that workshop. The workshop instance is created on demand. When they have finished the workshop, that workshop instance is destroyed to free up resources. After the conference has finished, the Kubernetes cluster is destroyed.
- Permanent learning portal. Similar to the temporary learning portal, but runs on an extended basis as a public website where anyone can come and learn at any time.
- Personal training or demos. This is where anyone who wants to run a workshop on their own Kubernetes cluster to learn that topic, or where a product demo was packaged up as a workshop and they want to use it to demonstrate the product to a customer. You can destroy the workshop environment when complete, but there is no need for the cluster to be destroyed.

When running workshops, wherever possible a shared Kubernetes cluster reduces the amount of setup required. This works for developer-focused workshops, because it is usually not necessary to provide elevated access to the Kubernetes cluster, and you can use role-based access controls (RBAC) to prevent users from interfering with each other. You can also set quotas so users are restricted as to how much resources they can use.

When you run workshops that deal with cluster operations, for which users need cluster admin access, create a separate cluster for each user. Learning Center doesn't deal with provisioning

clusters, only with deploying a workshop environment in a cluster after it exists.

Use case requirements

In implementing to the preceding scenarios, the primary requirements related to creation of workshop content, and what you can do at runtime, are as follows:

- You must store everything for the workshop in a Git repository, with no dependency on using a special web application or service to create a workshop.
- Use GitHub as a means to distribute workshop content. Alternatively, you can distribute the workshop as a container image. The latter is necessary if special tools must be installed for use in a workshop.
- Provide instructions to the user to complete the workshop as Markdown or AsciiDoc files.
- You can annotate instructions as executable commands so that when clicked in the workshop dashboard, they execute for the user in the appropriate terminal to avoid mistakes when commands are entered manually.
- You can annotate text as copyable so when clicked in the workshop dashboard, it is copied into the browser paste buffer ready for pasting into the terminal or other web application.
- Provide each user access to one or more namespaces in the Kubernetes cluster unique to their session. For Kubernetes based workshops, this is where applications are deployed as part of the workshop.
- You can create additional Kubernetes resources specific to a workshop session in advance of the session. This enables the deployment of applications for each user session.
- You can deploy additional Kubernetes resources common to all workshop sessions when the workshop environment is first created. This enables deployment of applications shared by all users.
- Apply resource quotas on each workshop session to control how much resources users can consume.
- Apply role-based access control (RBAC) on each workshop session to control what users can do.
- Provide access to an editor (IDE) in the workshop dashboard in the web browser for users to edit files during the workshop.
- Provide access to a web-based console for accessing the Kubernetes cluster. Use of the Kubernetes dashboard or Octant is supported.
- Ability to integrate additional web-based applications into the workshop dashboard specific to the topic of the workshop.
- Ability for the workshop dashboard to display slides used by an instructor in support of the workshop.

Platform architectural overview

The Learning Center relies on a Kubernetes Operator to perform the bulk of the work. The actions of the operator are controlled by using a set of custom resources specific to the Learning Center.

There are multiple ways of using the custom resources to deploy workshops. The primary way is to create a training portal, which in turn then triggers the setup of one or more workshop environments, one for each distinct workshop. When users access the training portal and select the workshop they want to do, the training portal allocates to that user a workshop session (creating

one if necessary) against the appropriate workshop environment, and the user is redirected to that workshop session instance.

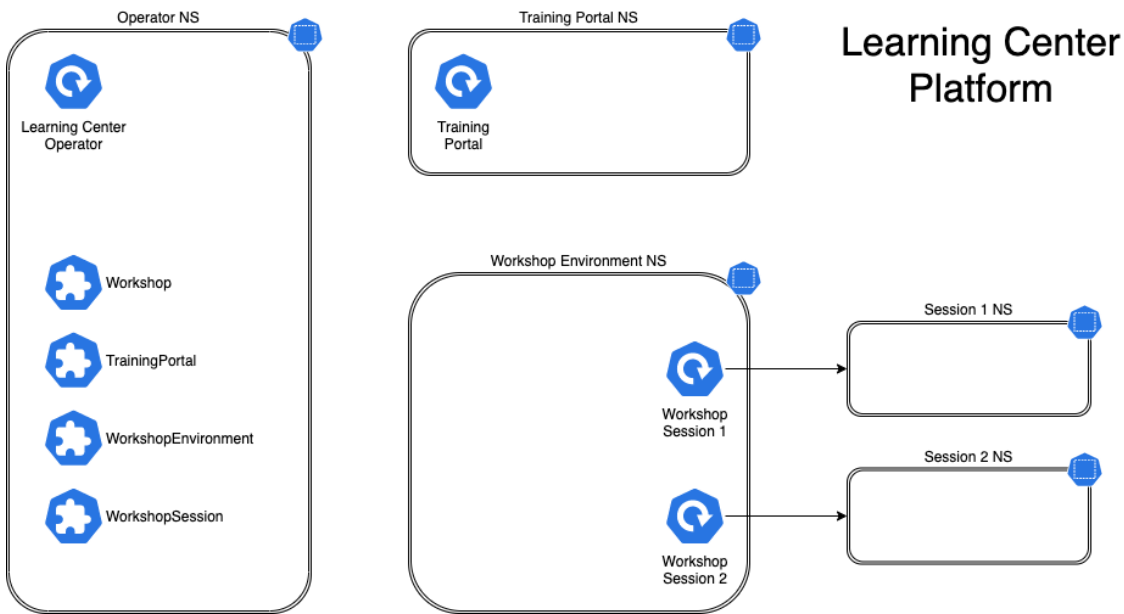

You can associate each workshop session with one or more Kubernetes namespaces specifically for use during that session. Role-Based Access Control (RBAC) applied to the unique Kubernetes service account for that session ensures that the user can only access the namespaces and other resources that they are allowed to for that workshop.

In this scenario, the custom resource types that come into play are:

- **Workshop** - Provides the definition of a workshop. Preloaded by an admin into the cluster, it defines where the workshop content is hosted, or the location of a container image which bundles the workshop content and any additional tools required for the workshop. The definition also lists additional resources that must be created which are to be shared between all workshop sessions, or for each session, with details of resources quotas and access roles required by the workshop.
- **TrainingPortal** - Created by an admin in the cluster to trigger the deployment of a training portal. The training portal can provide access to one or more distinct workshops defined by a **Workshop** resource. The training portal provides a web based interface for registering for workshops and accessing them. It also provides a REST API for requesting access to workshops, allowing custom front ends to be created which integrate with separate identity providers and which provide an alternate means for browsing and accessing workshops.
- **WorkshopEnvironment** - Used by the training portal to trigger the creation of a workshop environment for a workshop. This causes the operator to set up a namespace for the workshop into which shared resources are deployed, and where the workshop sessions are run.
- **WorkshopSession** - Used by the training portal to trigger the creation of a workshop session against a specific workshop environment. This causes the operator to set up any namespaces specific to the workshop session and pre-create additional resources required for a workshop session. Workshop sessions can either be created up front in reserve, to be handed out when requested, or created on demand.

Next steps

Learn more about:

- [Workshops](#)

- [Get started with Learning Center](#)
- [Installing Learning Center](#)
- [Local install guides](#)
- [Air-gapped environment requirements](#)
- [Known issues](#)

Overview of Learning Center for Tanzu Application Platform



Important

Learning Center is deprecated and marked for removal in Tanzu Application Platform v1.7.0. Use [Tanzu Academy](#) instead for all Tanzu Application Platform learning and education needs.

Learning Center provides a platform for creating and self-hosting workshops. It allows you to create workshops from markdown files that are displayed to the learner in a terminal shell environment with an instructional wizard UI.

The UI can embed slide content, an integrated development environment (IDE), a web console for accessing the Kubernetes cluster, and other custom web applications.

Although Learning Center requires Kubernetes to run, and is used to teach users about Kubernetes, you can use it to host training for other purposes as well. For example, you can use it to help train users in web-based applications, use of databases, or programming languages, where the user has no interest or need for Kubernetes.

Use cases

Use case scenarios that Learning Center supports include:

- Supervised workshops. For example, a workshop run at a conference, at a customer site, or online. The workshop has a set time period and you know the maximum number of users to expect. After the training is complete, the Kubernetes cluster created for the workshop is destroyed.
- Temporary learning portal. This is for when you must provide access to a small set of workshops for a short duration for hands on demos at a conference vendor booth. Users select which topic they want to learn about and do that workshop. The workshop instance is created on demand. When they have finished the workshop, that workshop instance is destroyed to free up resources. After the conference has finished, the Kubernetes cluster is destroyed.
- Permanent learning portal. Similar to the temporary learning portal, but runs on an extended basis as a public website where anyone can come and learn at any time.
- Personal training or demos. This is where anyone who wants to run a workshop on their own Kubernetes cluster to learn that topic, or where a product demo was packaged up as a workshop and they want to use it to demonstrate the product to a customer. You can destroy the workshop environment when complete, but there is no need for the cluster to be destroyed.

When running workshops, wherever possible a shared Kubernetes cluster reduces the amount of setup required. This works for developer-focused workshops, because it is usually not necessary to

provide elevated access to the Kubernetes cluster, and you can use role-based access controls (RBAC) to prevent users from interfering with each other. You can also set quotas so users are restricted as to how much resources they can use.

When you run workshops that deal with cluster operations, for which users need cluster admin access, create a separate cluster for each user. Learning Center doesn't deal with provisioning clusters, only with deploying a workshop environment in a cluster after it exists.

Use case requirements

In implementing the preceding scenarios, the primary requirements related to creation of workshop content, and what you can do at runtime, are as follows:

- You must store everything for the workshop in a Git repository, with no dependency on using a special web application or service to create a workshop.
- Use GitHub as a means to distribute workshop content. Alternatively, you can distribute the workshop as a container image. The latter is necessary if special tools must be installed for use in a workshop.
- Provide instructions to the user to complete the workshop as Markdown or AsciiDoc files.
- You can annotate instructions as executable commands so that when clicked in the workshop dashboard, they execute for the user in the appropriate terminal to avoid mistakes when commands are entered manually.
- You can annotate text as copyable so when clicked in the workshop dashboard, it is copied into the browser paste buffer ready for pasting into the terminal or other web application.
- Provide each user access to one or more namespaces in the Kubernetes cluster unique to their session. For Kubernetes based workshops, this is where applications are deployed as part of the workshop.
- You can create additional Kubernetes resources specific to a workshop session in advance of the session. This enables the deployment of applications for each user session.
- You can deploy additional Kubernetes resources common to all workshop sessions when the workshop environment is first created. This enables deployment of applications shared by all users.
- Apply resource quotas on each workshop session to control how much resources users can consume.
- Apply role-based access control (RBAC) on each workshop session to control what users can do.
- Provide access to an editor (IDE) in the workshop dashboard in the web browser for users to edit files during the workshop.
- Provide access to a web-based console for accessing the Kubernetes cluster. Use of the Kubernetes dashboard or Octant is supported.
- Ability to integrate additional web-based applications into the workshop dashboard specific to the topic of the workshop.
- Ability for the workshop dashboard to display slides used by an instructor in support of the workshop.

Platform architectural overview

The Learning Center relies on a Kubernetes Operator to perform the bulk of the work. The actions of the operator are controlled by using a set of custom resources specific to the Learning Center.

There are multiple ways of using the custom resources to deploy workshops. The primary way is to create a training portal, which in turn then triggers the setup of one or more workshop environments, one for each distinct workshop. When users access the training portal and select the workshop they want to do, the training portal allocates to that user a workshop session (creating one if necessary) against the appropriate workshop environment, and the user is redirected to that workshop session instance.

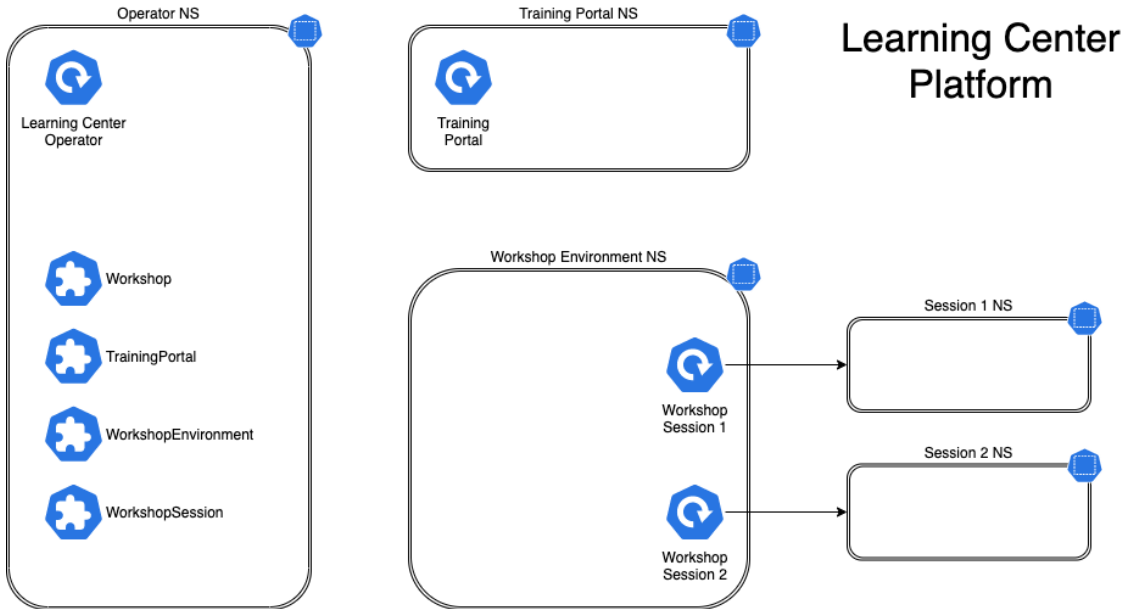

You can associate each workshop session with one or more Kubernetes namespaces specifically for use during that session. Role-Based Access Control (RBAC) applied to the unique Kubernetes service account for that session ensures that the user can only access the namespaces and other resources that they are allowed to for that workshop.

In this scenario, the custom resource types that come into play are:

- **Workshop** - Provides the definition of a workshop. Preloaded by an admin into the cluster, it defines where the workshop content is hosted, or the location of a container image which bundles the workshop content and any additional tools required for the workshop. The definition also lists additional resources that must be created which are to be shared between all workshop sessions, or for each session, with details of resources quotas and access roles required by the workshop.
- **TrainingPortal** - Created by an admin in the cluster to trigger the deployment of a training portal. The training portal can provide access to one or more distinct workshops defined by a **Workshop** resource. The training portal provides a web based interface for registering for workshops and accessing them. It also provides a REST API for requesting access to workshops, allowing custom front ends to be created which integrate with separate identity providers and which provide an alternate means for browsing and accessing workshops.
- **WorkshopEnvironment** - Used by the training portal to trigger the creation of a workshop environment for a workshop. This causes the operator to set up a namespace for the workshop into which shared resources are deployed, and where the workshop sessions are run.
- **WorkshopSession** - Used by the training portal to trigger the creation of a workshop session against a specific workshop environment. This causes the operator to set up any namespaces specific to the workshop session and pre-create additional resources required for a workshop session. Workshop sessions can either be created up front in reserve, to be handed out when requested, or created on demand.

Next steps

Learn more about:

- [Workshops](#)
- [Get started with Learning Center](#)
- [Installing Learning Center](#)
- [Local install guides](#)
- [Air-gapped environment requirements](#)
- [Known issues](#)

Install Learning Center

This topic describes how to install Learning Center from the Tanzu Application Platform (commonly known as TAP) package repository.



Note

Follow the steps in this topic if you do not want to use a profile to install Learning Center. For more information about profiles, see [Components and installation profiles](#).

To install Tanzu Learning Center, see the following sections.

For general information about Learning Center, see [Learning Center](#). For information about deploying Learning Center operator, see [Install and configure the Learning Center operator](#).

Prerequisites

Before installing Learning Center:

- Complete all prerequisites to install Tanzu Application Platform. For more information, see [Prerequisites](#).
- The cluster must have an ingress router configured. If you have installed Learning Center through a profile, it already deploys a Contour ingress controller.
- The operator, when deploying instances of the workshop environments, must be able to expose them through an external URL for access. For the custom domain you are using, DNS must have been configured with a wildcard domain to forward all requests for sub-domains of the custom domain to the ingress router of the Kubernetes cluster.
- By default, the workshop portal and workshop sessions are accessible over HTTP connections. If you wish to use secure HTTPS connections, you must have access to a wildcard SSL certificate for the domain under which you want to host the workshops. You cannot use a self-signed certificate.
- Any ingress routes created use the default ingress class if you have multiple ingress class types available and you must override which is used.

Install Learning Center

To install Learning Center:

1. List version information for the package by running:

```
tanzu package available list learningcenter.tanzu.vmware.com --namespace tap-in
stall
```

Example output:

NAME	VERSION	RELEASED-AT
learningcenter.tanzu.vmware.com	0.1.0	2021-12-01 08:18:48 -0500 EDT

- (Optional) See all the configurable parameters on this package by running:

Remember to change the 0.x.x version

```
tanzu package available get learningcenter.tanzu.vmware.com/0.x.x --values-sche
ma --namespace tap-install
```

- Create a config file named `learning-center-config.yaml`.
- To override the `shared.ingress_domain` in the values file of Tanzu Application Platform, add the parameter `ingressDomain` to `learning-center-config.yaml`. For example:

```
ingressDomain: YOUR-INGRESS-DOMAIN
```

Where `YOUR-INGRESS-DOMAIN` is the domain name for your Kubernetes cluster.

When deploying workshop environment instances, the operator must be able to expose the instances through an external URL. You need this access to discover the domain name that can be used as a suffix to host names for instances.

For the custom domain you are using, DNS must have been configured with a wildcard domain to forward all requests for sub-domains of the custom domain to the ingress router of the Kubernetes cluster.

If you are running Kubernetes on your local machine using a system such as `minikube` and you don't have a custom domain name that maps to the IP address for the cluster, you can use a `nip.io` address. For example, if `minikube ip` returns `192.168.64.1`, you can use the `192.168.64.1.nip.io` domain. You cannot use an address of form `127.0.0.1.nip.io` or `subdomain.localhost`. This causes a failure. Internal services needing to connect to each other connect to themselves instead, because the address resolves to the host loopback address of `127.0.0.1`.

- Add the `ingressSecret` to `learning-center-config.yaml`, as in this example:

```
ingressSecret:
certificate: |
  -----BEGIN CERTIFICATE-----
  MIIFLTCCBBWgAwIBAgASAYS/V2NCTG9uXa9aAiYt7WJ3MA0GCSqGSIb3DQEBCwUA
  . . .
  dHa6Ly9yMy5vamxlbmNyLm9yZzAiBggrBgEFBQawAoYWAHR0cDoaL3IzLmkubGVu
  -----END CERTIFICATE-----
privateKey: |
  -----BEGIN PRIVATE KEY-----
  MIIEvQIBADAABgkqhkiG9wBAQEFAASCBKcwggSjAgEAAoIBAAcX4nyc2xwaVOzf
  . . .
  IY/9SatMcJZivH3F1a7SXL98PawPIOSR7986P7rLFHzNjaQQ0DWTaXBRt+oUDxpN
  -----END PRIVATE KEY-----
```

If you already have a TLS secret, follow these steps **before deploying any workshop**: - Create the `learningcenter` namespace manually or the one you defined - Copy the TLS secret to the `learningcenter` namespace or the one you defined and use the `secretName` property as in this example:

```
ingressSecret:
  secretName: workshops.example.com-tls
```

By default, the workshop portal and workshop sessions are accessible over HTTP connections.

To use secure HTTPS connections, you must have access to a wildcard SSL certificate for the domain under which you want to host the workshops. You cannot use a self-signed certificate.

You can create wildcard certificates by using letsencrypt <https://letsencrypt.org/>. After you have the certificate, you can define the `certificate` and `privateKey` properties under the `ingressSecret` property to specify the certificate on the configuration YAML.

- Any ingress routes created use the default ingress class. If you have multiple ingress class types available, and you need to override which is used, define the `ingressClass` property in `learning-center-config.yaml` **before deploying any workshop**:

```
ingressClass: contour
```

- Install Learning Center operator by running:

Remember to change the 0.x.x version

```
tanzu package install learning-center --package-name learningcenter.tanzu.vmware.com --version 0.x.x -f learning-center-config.yaml
```

The preceding command creates a default namespace in your Kubernetes cluster called `learningcenter`, and the operator, and any required namespaced resources, are created in it. A set of custom resource definitions and a global cluster role binding are also created.

You can confirm that the operator deployed successfully by running:

```
kubectl get all -n learningcenter
```

The pod for the operator should be marked as running.

Install the Self-Guided Tour Training Portal and Workshop

To install the Self-Guided Tour Training Portal and Workshop:

- Confirm you have the workshop package installed by running:

```
tanzu package available list workshops.learningcenter.tanzu.vmware.com --namespace tap-install
```

- Install the Learning Center Training Portal with the Self-Guided Tour Workshop by running:

Remember to change the 0.x.x version

```
tanzu package install learning-center-workshop --package-name workshops.learningcenter.tanzu.vmware.com --version 0.x.x -n tap-install
```

- Check for the Training Portals available in your environment by running:

```
kubectl get trainingportals
```

Example output:

NAME	URL	ADMINU
SERNAME	ADMINPASSWORD	STATUS
learningcenter-tutorials	http://learningcenter-tutorials.example.com	le
arningcenter	ExamplePasswordABCdefg123456789	Running

4. Open the URL in a browser and use the ADMINUSERNAME and ADMINPASSWORD to login.

Supported Learning Center Values Configuration

Admins are provided the following sample learning-center-config.yaml file to see the possible configurations supported by Learning Center. These configurations are additional ones that admins can provide to the operator resource but are by no means necessary for Learning Center to work. It is enough to follow the previous instructions on this page for Learning Center to run.

It is important to note that Learning Center has default values in place for the learning-center-config.yaml file. Admins only need to provide the values they want to override. As in the example above, overriding the ingressDomain property is enough to get Learning Center to work.

```

#! The namespace in which to deploy Learning Center. For now this must be "learningcenter" as
namespace: learningcenter
#! DNS parent subdomain used for training portal and workshop ingresses.
ingressDomain: workshops.example.com
#! Ingress class for where multiple ingress controllers exist and need to
#! use that which is not marked as the default.
ingressClass: null
#! SSL certificate for secure ingress. This must be a wildcard certificate for
#! children of DNS parent ingress subdomain.
ingressSecret:
  certificate: null
  privateKey: null
  secretName: null
#! Configuration for persistent volumes. The default storage class specified
#! by the cluster is used if not defined. You might need to set storage group
#! where a cluster has pod security policies enabled, usually
#! to one. Set storage user and storage group in exceptional cases
#! where storage class uses maps to NFS storage and storage server requires
#! that a specific user and group always be used.
storageClass: null
storageUser: null
storageGroup: null
#! Credentials for accessing training portal instances. If not specified,
#! random passwords are generated that you can obtain from the custom resource
#! for the training portal.
portalCredentials:
  systemAdmin:
    username: learningcenter
    password: null
  clientAccess:
    username: robot@learningcenter
    password: null
#! Container image versions for various components of Learning Center. The Learning Ce
n
ter
#! operator needs to be modified to read names of images for the registry
#! and docker-in-docker from config map to enable disconnected install.
#! Prepull images to nodes in cluster. Should be an empty list if no images
#! should be prepulled. Normally you would only want to prepull workshop
#! images. This is done to reduce start-up times for sessions.
prepullImages: ["base-environment"]
#! Docker daemon settings when building docker images in a workshop is
#! enabled. Proxy cache provides a way of partially getting around image
#! pull limits for Docker Hub image registry, with the remote URL being

```

```

#! set to "https://registry-1.docker.io".
dockerDaemon:
  networkMTU: 1500
  proxyCache:
    remoteURL: null
    username: null
    password: null
#! Used to restrict access to IP addresses or IP subnets. This must be a CIDR block ra
nge corresponding to the subnet or a portion of a
#! subnet you want to block. A Kubernetes `NetworkPolicy` is used to enforce the restr
iction. So the
#! Kubernetes cluster must use a network layer supporting network policies, and the ne
cessary Kubernetes
#! controllers supporting network policies must be enabled when the cluster is install
ed.
network:
  blockCIDRs:
    - 169.254.169.254/32
    - fd00:ec2::254/128

#! The security policy enforcement used by Learning Center. For pod security policies
and pod security standards, these both
#! need to be enabled in the Kubernetes cluster at the time the cluster is created, it
is not something that can be
#! enabled afterwards. Values: pod-security-policies, pod-security-standards, security
-context-constraints or
#! security-context-constraints-v2
clusterSecurity:
  policyEngine: pod-security-policies

```

See [Restricting Network Access](#) for more information on blocking CIDRs.

About Learning Center workshops

This topic gives you an overview of Learning Center workshops.

The Learning Center workshop dashboard comprises a set of workshop instructions on the left-hand side and a series of tabbed views on the right-hand side. For workshops that require users to run commands, one or more terminal shells are provided. For more information about workshops including creating your own, see [Create workshops](#).

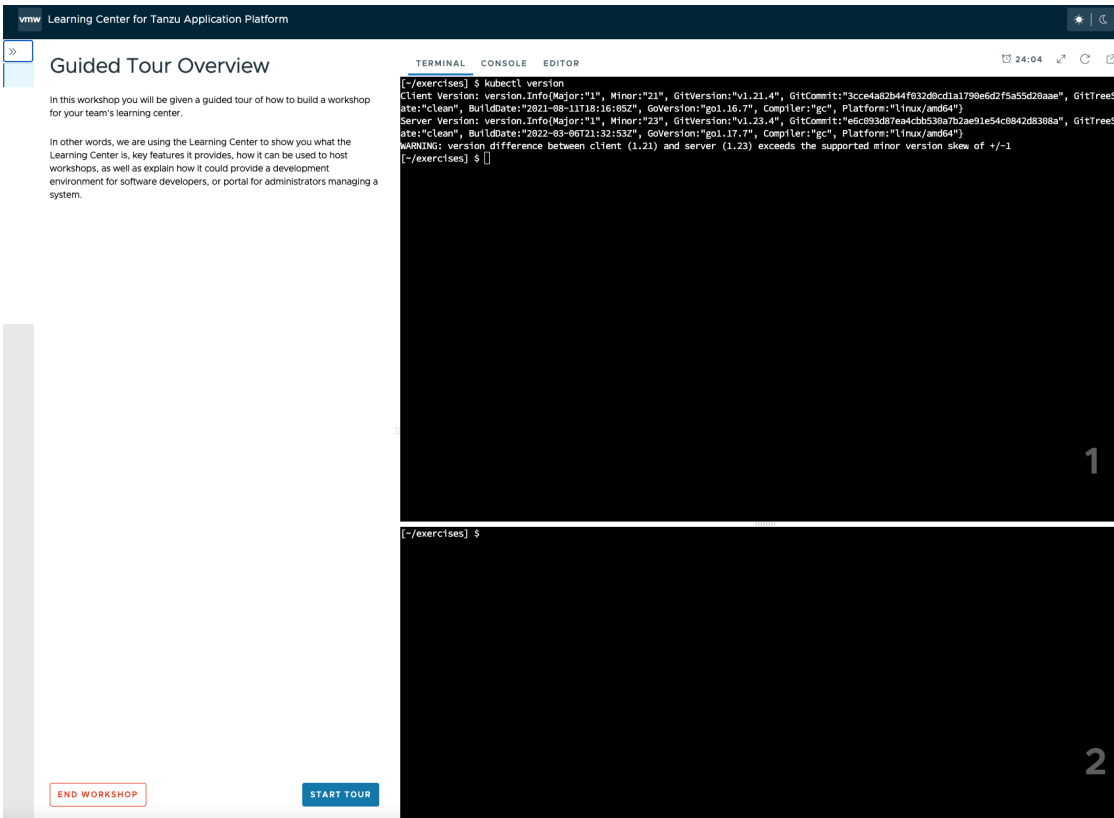

The terminals provide access to the editors `vi` and `nano`. To provide a UI based editor, you can enable the embedded editor view and use the embedded IDE based on VS Code.

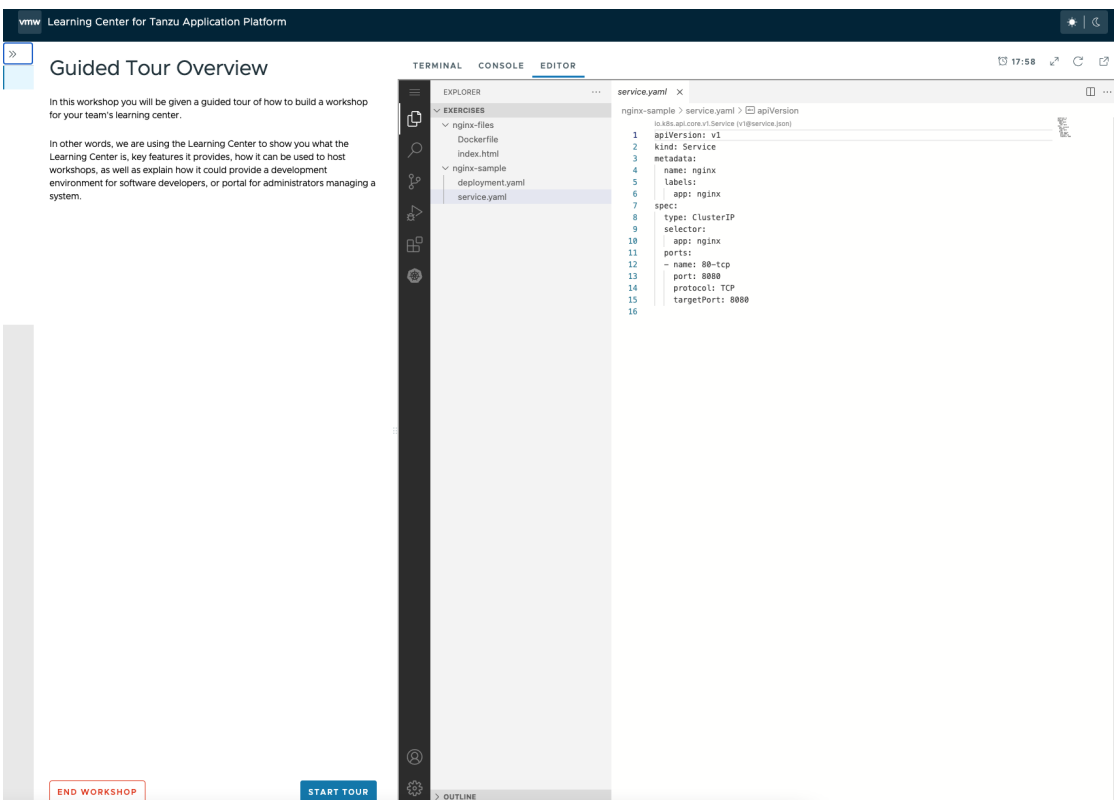

To complement the workshop instructions, or to be available for use by the instructor, you can include slides with a workshop. For slides you can use HTML based slide presentation tools such as `reveal.js`, or you can embed a PDF file.

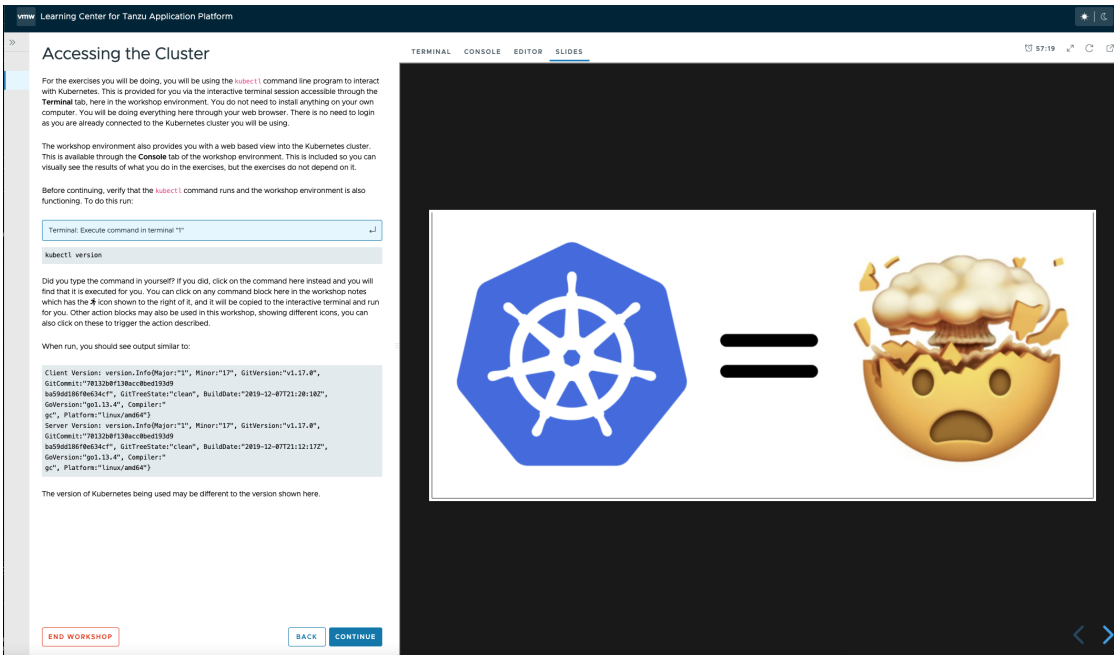

If the workshop involves working with Kubernetes, you can enable a web console for accessing the Kubernetes cluster. The default web console uses the Kubernetes dashboard.

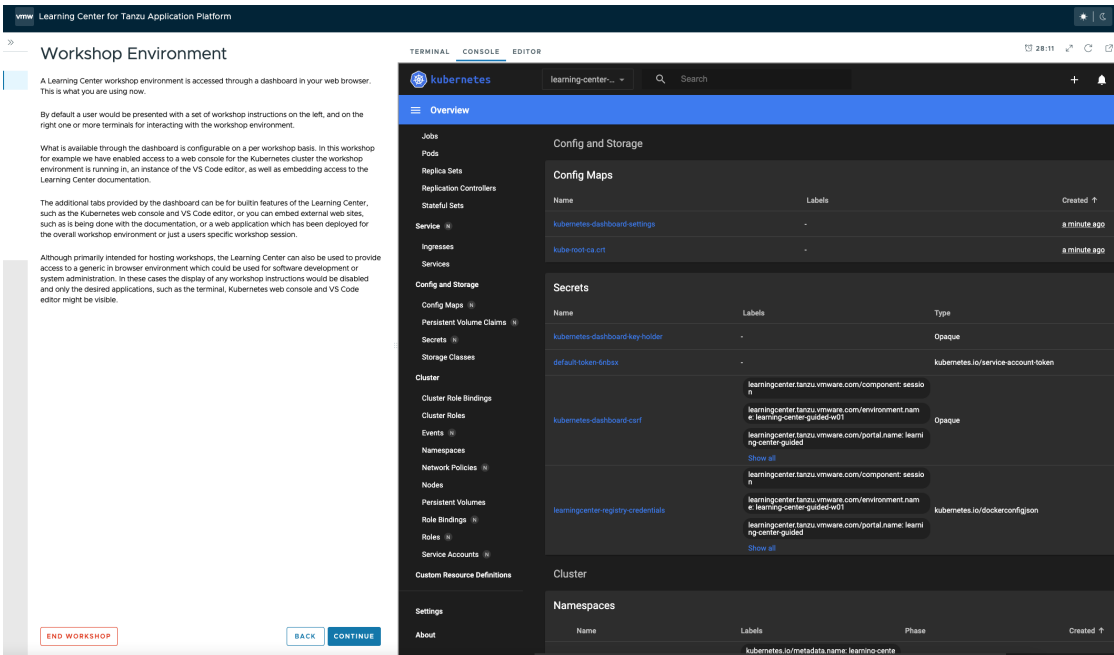

Alternatively, you can enable Octant as the web console.

Workshop Environment

A Learning Center workshop environment is accessed through a dashboard in your web browser. This is what you are using now.

By default a user would be presented with a set of workshop instructions on the left, and on the right one or more terminals for interacting with the workshop environment.

What is available through the dashboard is configurable on a per workshop basis. In this workshop for example we have enabled access to a web console for the Kubernetes cluster the workshop environment is running in, an instance of the VS Code editor, as well as embedding access to the Learning Center documentation.

The additional tabs provided by the dashboard can be for built-in features of the Learning Center, such as the Kubernetes web console and VS Code editor, or you can embed external web sites, such as is being done with the documentation, or a web application which has been deployed for the overall workshop environment or just a users specific workshop session.

Although primarily intended for hosting workshops, the Learning Center can also be used to provide access to a generic in browser environment which could be used for software development or system administration. In these cases the display of any workshop instructions would be disabled and only the desired applications, such as the terminal, Kubernetes web console and VS Code editor might be visible.

Overview

Network Policies

Name	Labels	Data	Age
learningcenter-network-credentials	learningcenter.tanzu.vmware.com/component=...	learningcenter.tanzu.vmware.com/Environment=...	5Bs

ConfigMaps

Name	Labels	Data	Age
kube-root-ca.crt		1	5Bs

Secrets

Name	Labels	Type	Data	Age
default-token-dqgk		kubernetes.io/service-account-token	3	5Bs
learningcenter-registry-credentials	learningcenter.tanzu.v...	kubernetes.io/dockerconfigjson	1	5Bs

Service Accounts

Name	Labels	Secrets	Age
default		1	5Bs

Role Bindings

Name	Age	Role kind	Role name
learningcenter	5Bs	ClusterRole	learningcenter-session-admin
learningcenter-policy	5Bs	ClusterRole	learningcenter-guided-w02-nonroot

Get started with Learning Center

This topic describes how you can get started with Learning Center for Tanzu Application Platform. For information about Learning Center and its use cases, see [Learning Center for Tanzu Application Platform](#).

Installing Learning Center

Before deploying workshops, you must install a Kubernetes operator for Learning Center. The operator manages the setup of the environment for each workshop and deploys instances of a workshop for each person.

For basic information about installing the Learning Center operator, see [Install Learning Center](#).

Get started

See the following useful information about getting started with Learning Center:

- [Install and configure the Learning Center operator](#)
- [Get started with workshops](#)
- [Get started with training portals](#)
- [Delete an operator](#)

Get started with Learning Center

This topic describes how you can get started with Learning Center for Tanzu Application Platform. For information about Learning Center and its use cases, see [Learning Center for Tanzu Application Platform](#).

Installing Learning Center

Before deploying workshops, you must install a Kubernetes operator for Learning Center. The operator manages the setup of the environment for each workshop and deploys instances of a

workshop for each person.

For basic information about installing the Learning Center operator, see [Install Learning Center](#).

Get started

See the following useful information about getting started with Learning Center:

- [Install and configure the Learning Center operator](#)
- [Get started with workshops](#)
- [Get started with training portals](#)
- [Delete an operator](#)

Install and configure the Learning Center operator

This topic gives you information about installing and configuring the Learning Center operator.

Before deploying workshops, you must install a Kubernetes operator for Learning Center. The operator manages the setup of the environment for each workshop and deploys instances of a workshop for each person.

For basic information about installing the operator, see [Install Learning Center](#).

Installing and setting up Learning Center operator

You can deploy the Learning Center operator to any Kubernetes cluster supporting custom resource definitions and the concept of operators. The cluster must have an ingress router configured, though only a basic deployment of the ingress controller is usually required. You do not need to configure the ingress controller to handle cluster wide edge termination of secure HTTP connections. Learning Center creates Kubernetes Ingress resources and supplies any secret for use with secure HTTP connections for each ingress.

For the ingress controller, VMware recommends the use of Contour over alternatives such as nginx. An nginx-based ingress controller has a less than optimal design. Every time a new ingress is created or deleted, the nginx config is reloaded. This causes websocket connections to terminate after a period of time. Learning Center terminals reconnect automatically in the case of the websocket connection being lost. However, not all applications you might use with specific workshops can handle loss of websocket connections so gracefully, and they might be impacted due to the use of an nginx ingress controller. This problem is not specific to Learning Center. It can impact any application when an nginx ingress controller is used frequently and ingresses are created or deleted frequently.

You can use a hosted Kubernetes solution from an IaaS provider such as Google, AWS, or Azure. If you do, as needed increase any HTTP request timeout specified on the inbound load balancer for the ingress controller so that you can use long-lived websocket connections. In some cases, load balancers of hosted Kubernetes solutions only have a 30-second timeout. If possible, configure the timeout applying to websockets to be 1 hour.

If you deploy the web-based training portal, the cluster must have available persistent volumes of type `ReadWriteOnce (RWO)`. A default storage class must be defined so that persistent volume claims do not need to specify a storage class. For some Kubernetes distributions, including from IBM, you must configure Learning Center as to what user and group must be used for persistent volumes. If no default storage class is specified, or a specified storage class is required, you can configure Learning Center with the name of the storage class.

To install the Learning Center operator, you must have cluster admin access.

Cluster pod security policies

The Learning Center operator defines pod security policies to limit what users can do from workshops when deploying workloads to the cluster. The default policy prohibits running of images as the `root` user or using a privileged pod. Specified workshops can relax these restrictions and apply a policy that enables additional privileges required by the workshop.

To enforce a security policy around what a user can do, different mechanisms have been provided with standard Kubernetes distributions and derivatives such as OpenShift. These are:

- Pod security policies (Kubernetes <= 1.25)
- Pod security standards (Kubernetes >= 1.22)
- Security context constraints (OpenShift)

For pod security policies and pod security standards, these both must be enabled in the Kubernetes cluster at the time the cluster is created. They cannot be enabled afterwards. For some Kubernetes distributions, such as Tanzu Community Edition, it is not possible to enable pod security policies. Because pod security standards are new, they might also not be supported.

VMware recommends that the pod security policy admission controller be enabled for the cluster to ensure that the pod security policies are applied. If the admission controller is not enabled, users can deploy workloads that run as the `root` user in a container, or run privileged pods.

If you are unable to enable the pod security policy admission controller, you should only provide access to workshops deployed using the Learning Center operator to users you trust.

Whether the absence of the pod security policy admission controller causes issues with access to persistent volumes depends on the cluster. Although minikube does not enable the pod security policy admission controller, it works as persistent volumes when mounted to give write permissions to all users.

No matter whether pod security policies are enabled, individual workshops must be reviewed as to what added privileges they grant before allowing their use in a cluster.

Specifying the ingress domain

When deploying instances of workshop environments, the operator must expose the instances by using an external URL for access to define the domain name that is used as a suffix to host names for instances.



Note

For the custom domain you are using, configure your DNS with a wildcard domain to forward all requests for subdomains of the custom domain to the ingress router of the Kubernetes cluster.

VMware recommends that you avoid using a `.dev` or `.app` domain name, because such domain names require browsers to use HTTPS and not HTTP. Although you can provide a certificate for secure connections under the domain name for use by Learning Center, this doesn't extend to what a workshop may do. If workshop instructions require that you create ingresses in Kubernetes using HTTP only, a `.dev` or `.app` domain name cannot work in the browser.



Note

If you are running Kubernetes on your local machine using a system such as `minikube` and you don't have a custom domain name that maps to the IP address

for the cluster, you can use a `nip.io` address. For example, if `minikube ip` returned `192.168.64.1`, you can use the `192.168.64.1.nip.io` domain. You cannot use an address of form `127.0.0.1.nip.io` or `subdomain.localhost`. This causes a failure as internal services needing to connect to each other end up connecting to themselves instead, because the address resolves to the host loopback address of `127.0.0.1`.

If needed, you can override the `shared.ingress_domain` in the values file of Tanzu Application Platform with the `ingressDomain` parameter of `learning center`:

```
ingressDomain: learningcenter.my-domain.com
```

Set the environment variable manually

Set the `INGRESS_DOMAIN` environment variable on the operator deployment. To set the `INGRESS_DOMAIN` environment variable, run:

```
kubectl set env deployment/learningcenter-operator -n learningcenter INGRESS_DOMAIN=test
```

Where `test` is the domain name for your Kubernetes cluster.

Or if using a `nip.io` address:

```
kubectl set env deployment/learningcenter-operator -n learningcenter INGRESS_DOMAIN=192.168.64.1.nip.io
```

Use of environment variables to configure the operator is a shortcut for a simple use. VMware recommends using Tanzu CLI, or for more complicated scenarios, you can use the `SystemProfile` custom resource.

Enforcing secure connections

By default, the workshop portal and workshop sessions are accessible over HTTP connections. To use secure HTTPS connections, you must have access to a wildcard SSL certificate for the domain under which you want to host the workshops. You cannot use a self-signed certificate.

You can create wildcard certificates by using `letsencrypt` <<https://letsencrypt.org/>>. After you have the certificate, you can define it as follows.

Configuration YAML

The easiest way to define the certificate is with the configuration passed to Tanzu CLI. So define the `certificate` and `privateKey` properties under the `ingressSecret` property to specify the certificate on the configuration YAML passed to Tanzu CLI:

```
ingressSecret:
  certificate: |
    -----BEGIN CERTIFICATE-----
    MIIFLTCCBBWgAwIBAgSAys/V2NCTG9uXa9aAiYt7WJ3MA0GCSqGSIb3DQEBwUUA
    .
    .
    .
    dHa6Ly9yMy5vamxlbmNyLm9yZzAiBggrBgEFBQawAoYWaHR0cDoaL3IzLmkubGVu
    -----END CERTIFICATE-----
  privateKey: |
    -----BEGIN PRIVATE KEY-----
    MIIEvQIBADAaBgkqhkiG9wBAQEFAASCBCwggSjAgEAAoIBAAcX4nyc2xwaVOzf
    .
    .
    .
```

```
IY/9SatMcJZivH3F1a7SXL98PawPIOSR7986P7rLFHzNjaQQ0DWTaXBrt+oUDxpN
-----END PRIVATE KEY-----
```

If you already have a TLS secret, follow these steps **before deploying any workshops**:

1. Create the `learningcenter` namespace manually or the one you defined.
2. Copy the TLS secret to the `learningcenter` namespace or to the one you defined, and use the `secretName` property as in this example:

```
ingressSecret:
  secretName: workshops.example.com-tls
```

Create the TLS secret manually

To add the certificate as a secret in the `learningcenter` namespace or in the one you defined, the secret must be of type `tls`. You can create it using the `kubectl create secret tls` command:

```
kubectl create secret tls -n learningcenter workshops.example.com-tls --cert=workshop
s.example.com/fullchain.pem --key=workshops.example.com/privkey.pem
```

Having created the secret, if it is the secret corresponding to the default ingress domain you specified earlier, set the `INGRESS_SECRET` environment variable. This way you do not use the configuration passed to Tanzu CLI on the operator deployment. This ensures the secret is applied automatically to any ingress created:

```
kubectl set env deployment/learningcenter-operator -n learningcenter INGRESS_SECRET=wo
rkshops.example.com-tls
```

If the certificate isn't that of the default ingress domain, you can supply the domain name and name of the secret when creating a workshop environment or training portal. In either case, you must create secrets for the wildcard certificates in the `learningcenter` namespace or the one that you defined.

Specifying the ingress class

Any ingress routes created use the default ingress class. If you have multiple ingress class types available, and you must override which is used, you can define the `ingressClass` property on the configuration YAML as follows.

Configuration YAML

Define the `ingressClass` property on the configuration YAML passed to Tanzu CLI:

```
ingressClass: contour
```

Set the environment variable manually

Set the `INGRESS_CLASS` environment variable for the learningcenter operator:

```
kubectl set env deployment/learningcenter-operator -n learningcenter INGRESS_CLASS=con
tour
```

This applies only to the ingress created for the training portal and workshop sessions. It does not apply to any ingress created from a workshop as part of the workshop instructions.

This can be necessary when a specific ingress provider is not reliable in maintaining websocket connections. For example, in the case of the nginx ingress controller when there are frequent

creation or deletions of ingresses occurring in the cluster. See the earlier section, [Installing and setting up Learning Center operator](#).

Trusting unsecured registries

One of the options available for workshops is to automatically deploy a container image registry each workshop session. When the Learning Center operator is configured to use a secure ingress with a valid wildcard certificate, the image registry works out of the box.

If the Learning Center operator is not set up to use secure ingress, the image registry is accessed over HTTP and is regarded as not secure.

When using the optional support for building container images using `docker`, the `docker` daemon deployed for the workshop session is configured for the image registry being not secure yet pushing images to the image registry still works.

In this case of an image registry that is not secure, deploying images from the image registry to the Kubernetes cluster does not work unless the Kubernetes cluster is configured to trust the registry that is not secure.

How you configure a Kubernetes cluster to trust an unsecured registry varies based on how the Kubernetes cluster is deployed and what container runtime it uses.

If you are using `minikube` with `dockerd`, to ensure that the registry is trusted, you must set up the trust the first time you create the `minikube` instance.

To do this, first determine which IP subnet `minikube` uses for the inbound ingress router of the cluster. If you already have a `minikube` instance running, you can determine this by running `minikube ip`. If, for example, this reported `192.168.64.1`, the subnet used is `129.168.64.0/24`.

With this information, when you create a fresh `minikube` instance, you must supply the `--insecure-registry` option with the subnet:

```
minikube start --insecure-registry="129.168.64.0/24"
```

This option tells `dockerd` to regard as not secure any image registry deployed in the Kubernetes cluster and accessed through a URL exposed using an ingress route of the cluster itself.

Currently, there is no way to configure `containerd` to treat as not secure image registries that match a wildcard subdomain or reside in a subnet. It is therefore not possible to run workshops that must deploy images from the per session image registry when using `containerd` as the underlying Kubernetes cluster container runtime. This is a limitation of `containerd`, and there are no known plans for `containerd` to support this ability. This limits your ability to use Kubernetes clusters deployed with a tool such as `kind`, which relies on using `containerd`.

Get started with Learning Center workshops

This topic helps you to get started working with Learning Center workshops. Workshops are where you create your content. You can create a workshop for individual use or group multiple workshops together with a [Training Portal](#).

For more detailed instructions, go to [Working with Learning Center Workshops](#)

Creating the workshop environment

With the definition of a workshop already in existence, the first step to deploying a workshop is to create the workshop environment.

To create the workshop environment run:

```
kubectl apply -f {YOUR-GIT-REPO-URL}/lab-k8s-fundamentals/main/resources/workshop-environment.yaml
```

This results in a custom resource being created called `WorkshopEnvironment`:

```
workshopenvironment.learningcenter.tanzu.vmware.com/lab-k8s-fundamentals created
```

The custom resource created is cluster-scoped, and the command needs to be run as a cluster admin or other appropriate user with permission to create the resource.

The Learning Center Operator reacts to the creation of this custom resource and initializes the workshop environment.

For each distinct workshop environment, a separate namespace is created. This namespace is used to hold the workshop instances. The namespace may also be used to provision any shared application services the workshop definition describes which would be used across all workshop instances. Such shared application services are automatically provisioned by the Learning Center Operator when the workshop environment is created.

You can list the workshop environments which have been created by running:

```
kubectl get workshopenvironments
```

This results in the output:

NAME URL	NAMESPACE	WORKSHOP	IMAGE
lab-k8s-fundamentals	lab-k8s-fundamentals	lab-k8s-fundamentals	{YOUR-REGISTRY-URL}/lab-k8s-fundamentals:main
	{YOUR-GIT-REPO-URL}/lab-k8s-fundamentals		

Additional fields give the name of the workshop environment, the namespace created for the workshop environment, and the name of the workshop the environment was created from.

Requesting a workshop instance

To request a workshop instance, a custom resource of type `WorkshopRequest` needs to be created.

This is a namespaced resource allowing who can create them to be delegated using role-based access controls. Further, in order to be able to request an instance of a specific workshop, you need to know the secret token specified in the description of the workshop environment. If necessary, raising requests against a specific workshop environment can also be constrained to a specific set of namespaces on top of any defined role-based access control (RBAC) rules.

In the context of an appropriate namespace, run:

```
kubectl apply -f {YOUR-GIT-REPO-URL}/lab-k8s-fundamentals/main/resources/workshop-request.yaml
```

This should result in the output:

```
workshoprequest.learningcenter.tanzu.vmware.com/lab-k8s-fundamentals created
```

You can list the workshop requests in a namespace by running:

```
kubectl get workshoprequests
```

This displays output similar to:

NAME	URL	USERNAME	PASSWORD
lab-k8s-fundamentals OgZvfHM7m	http://lab-k8s-fundamentals-cvh51.test	learningcenter	buQ

The additional fields provide the URL where the workshop instance can be accessed and the username and password for you to provide when prompted by your web browser.

The user name and password only come into play when you use the lower-level resources to set up workshops. If you use the [TrainingPortal](#) custom resource, you will see that these fields are empty. This is because, for that case, the workshop instances are deployed so that they rely on user registration and access mediated by the web-based training portal. Visiting the URL for a workshop instance directly when using [TrainingPortal](#), redirects you back to the web portal in order to log in if necessary.

You can monitor the progress of this workshop deployment by listing the deployments in the namespace created for the workshop environment:

```
kubectl get all -n lab-k8s-fundamentals
```

For each workshop instance a separate namespace is created for the session. This is linked to the workshop instance, and is where any applications are deployed as part of the workshop. If the definition of the workshop includes a set of resources that should be automatically created for each session namespace, they are created by the Learning Center Operator. It is therefore possible to pre-deploy applications for each session.

In this case, we used [WorkshopRequest](#); whereas when using [TrainingPortal](#), we created a [WorkshopSession](#). The workshop request does result in creating a [WorkshopSession](#), but [TrainingPortal](#) skips the workshop request and directly creates a [WorkshopSession](#).

The purpose of having [WorkshopRequest](#) as a separate custom resource is to allow RBAC and other controls to be used to allow non-cluster administrators to create workshop instances.

Deleting the workshop instance

When you have finished with the workshop instance, you can delete it by deleting the custom resource for the workshop request:

```
kubectl delete workshoprequest/lab-k8s-fundamentals
```

Deleting the workshop environment

If you want to delete the whole workshop environment, it is recommended to first delete all workshop instances. Once this has been done, you can then delete the custom resource for the workshop environment:

```
kubectl delete workshopenvironment/lab-k8s-fundamentals
```

If you don't delete the custom resources for the workshop requests, the workshop instances are still cleaned up and removed when the workshop environment is removed. The custom resources for the workshop requests still remain, however, and need to be deleted separately.

Get started with Learning Center training portals

This topic describes how you configure and use a [TrainingPortal](#), which deploys a set of workshops for attendees.

Working with multiple workshops

The quickest way to deploy a set of workshops to use in a training session is to deploy a [TrainingPortal](#). This deploys a set of workshops with one instance of each workshop for each attendee. A web-based portal is provided for registering attendees and allocating them to workshops.

The [TrainingPortal](#) custom resource provides a high-level mechanism for creating a set of workshop environments and populating it with workshop instances. When the Learning Center operator processes this custom resource, it creates other custom resources to trigger the creation of the workshop environment and the workshop instances. If you want more control, you can use these latter custom resources directly instead.

Loading the workshop definition

A custom resource of type [Workshop](#) describes each workshop. Before you can create a workshop environment, you must load the definition of the workshop.

Here is an example [Workshop](#) custom resource:

```
apiVersion: learningcenter.tanzu.vmware.com/v1beta1
kind: Workshop
metadata:
  name: lab-k8s-fundamentals
spec:
  title: Kubernetes Fundamentals
  description: Workshop on getting started with Kubernetes
  url: {YOUR-GIT-REPO-URL}/lab-k8s-fundamentals
  vendor: learningcenter.io
  authors:
    - Graham Dumpleton
  difficulty: intermediate
  duration: 1h
  tags:
    - kubernetes
  content:
    image: projects.registry.vmware.com/learningcenter/lab-k8s-fundamentals:latest
  session:
    namespaces:
      budget: medium
    applications:
      terminal:
        enabled: true
        layout: split
      console:
        enabled: true
      editor:
        enabled: true
```

To load the definition of the workshop, run:

```
kubectl apply -f {YOUR-GIT-REPO-URL}/lab-k8s-fundamentals/main/resources/workshop.yaml
```

The custom resource created is cluster-scoped. The command must be run as a cluster admin or other appropriate user with permission to create the resource.

If successfully loaded, the command outputs:

```
workshop.learningcenter.tanzu.vmware.com/lab-k8s-fundamentals created
```

To list the workshop definitions that have been loaded and that can be deployed, run:

```
kubectl get workshops
```

For this workshop, this outputs:

NAME	IMAGE	FILES	URL
lab-k8s-fundamentals	{YOUR-REGISTRY-URL}/lab-k8s-fundamentals:main		{YOUR-GIT-REPO-URL}/lab-k8s-fundamentals

The added fields in this case give:

- The name of the custom workshop container image deployed for the workshop.
- A URL for more information about the workshop.

The definition of a workshop is loaded as a step of its own, rather than referring to a remotely hosted definition. This allows a cluster admin to audit the workshop definition to ensure it isn't doing something the cluster admin doesn't want to allow. After the cluster admin approves the workshop definition, it can be used to create instances of the workshop.

Creating the workshop training portal

To deploy a workshop for one or more users, use the `TrainingPortal` custom resource. This custom resource specifies a set of workshops to be deployed and the number of people taking the workshops.

The `TrainingPortal` custom resource we use in this example is:

```
apiVersion: learningcenter.tanzu.vmware.com/v1beta1
kind: TrainingPortal
metadata:
  name: lab-k8s-fundamentals
spec:
  workshops:
  - name: lab-k8s-fundamentals
    capacity: 3
    reserved: 1
    expires: 1h
    orphaned: 5m
```

To create the custom resource, run:

```
kubectl apply -f {YOUR-GIT-REPO-URL}/lab-k8s-fundamentals/main/resources/training-portal.yaml
```

The custom resource created is cluster-scoped. The command must be run as a cluster admin or other appropriate user with permission to create the resource.

This results in the output:

```
trainingportal.learningcenter.tanzu.vmware.com/lab-k8s-fundamentals created
```

There is actually much more going on than this. To see all the resources created, run:

```
kubectl get learningcenter-training -o name
```

You should see:

```
workshop.learningcenter.tanzu.vmware.com/lab-k8s-fundamentals
trainingportal.learningcenter.tanzu.vmware.com/lab-k8s-fundamentals
workshopenvironment.learningcenter.tanzu.vmware.com/lab-k8s-fundamentals-w01
workshopsession.learningcenter.tanzu.vmware.com/lab-k8s-fundamentals-w01-s001
```

In addition to the original `Workshop` custom resource providing the definition of the workshop, and the `TrainingPortal` custom resource you just created, you've also created the `WorkshopEnvironment` and `WorkshopSession` custom resources.

The `WorkshopEnvironment` custom resource sets up the environment for a workshop, including deploying any application services that must exist and are shared by all workshop instances.

The `WorkshopSession` custom resource results in the creation of a single workshop instance.

To see a list of the workshop instances created and their details, run:

```
kubect1 get workshopsessions
```

This yields output similar to:

NAME	URL	USERNAME
lab-k8s-fundamentals-w01-s001	http://lab-k8s-fundamentals-w01-s001.test	

Only one workshop instance is created. Though the maximum capacity is set to three, the reserved number of instances (hot spares) is defined as one. Additional workshops instances are only created as workshop sessions are allocated to users. One reserved instance is always maintained until capacity is reached.

If you need a different number of workshop instances, set the `portal.capacity` field of the `TrainingPortal` custom resource YAML input file before creating the resource. Changing the values after the resource is created has no effect.

In this case, only one workshop is listed to be hosted by the training portal. You can deploy more than one workshop at the same time by adding the names of other workshops to `workshops`.

The first time you deploy the workshop, it can take a few moments to pull down the workshop image and start.

To access the workshops, attendees of a training session need to visit the web-based portal for the training session. Find the URL for the web portal by running:

```
kubect1 get trainingportals
```

This should yield output similar to:

NAME	URL	ADMINUSERNAME	ADMINPASSWORD
lab-k8s-fundamentals-2C1TkHEBoFgKiZetxMnwAldRU80aN	https://lab-k8s-fundamentals-ui.test	learningcenter	mGI

Attendees should only be given the URL. The password listed is only for use by the instructor of the training session if required.

Accessing workshops via the web portal

Attendees can access workshops through the web portal by following two steps:

1. The attendee visits the web-based portal for the training session and is presented with a login page. However, before logging in, the attendee must register for an account. The attendee clicks the link to the registration page and fills it in.

Workshops

Create an account

The purpose of the account is to allow you to attach back to the same workshop session if your web browser exits or you need to change web browsers. Unless indicated by the instructor, personal details are not retained and are deleted at the end of the training. If you have already registered, or were supplied with login credentials, use the [login page](#).

Username*

Required. 150 characters or fewer. Letters, digits and @/./+/-/_ only.

Email address*

Password*

- Your password can't be too similar to your other personal information.
- Your password must contain at least 8 characters.
- Your password can't be a commonly used password.
- Your password can't be entirely numeric.

Password confirmation*

Enter the same password as before, for verification.

[Register](#)

Registration is required so if the attendee's web browser exits or the attendee needs to switch web browsers, the attendee can log in again and access the same workshop instance.

2. Upon registering, the attendee is presented with a list of workshops available for the training session.
 - o An orange dot beside a workshop means that no instance for that workshop has been allocated to the user as yet, but that some are available.
 - o A red dot indicates there are no more workshop instances available.
 - o A green dot indicates a workshop instance has already been reserved by the attendee.

The attendee clicks the "Start workshop" button. This allocates a workshop instance if one hasn't yet been reserved and redirects the attendee to that workshop instance.

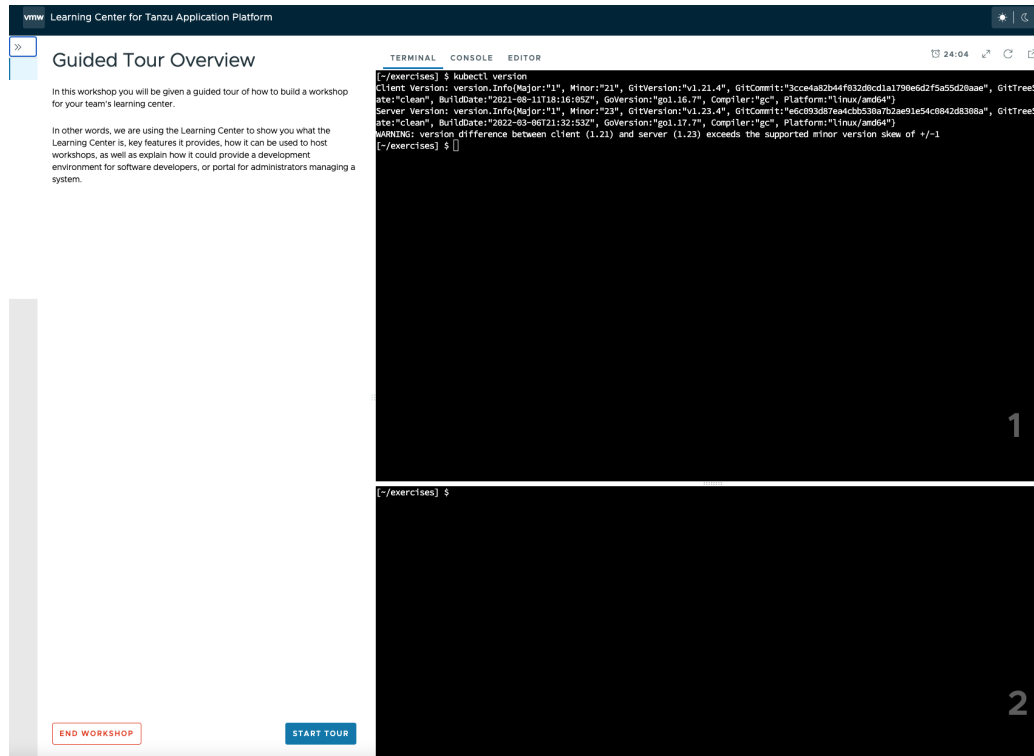

Deleting the workshop training portal

The workshop training portal is intended for running workshops with a fixed time period where all workshop instances are deleted when complete.

To delete all workshop instances and the web-based portal, run:

```
kubectl delete trainingportal/lab-k8s-fundamentals
```

Delete Learning Center

This topic describes how you can delete Learning Center.

1. Delete all current workshop environments by running:

```
kubectl delete workshops,trainingportals,workshoprequests,workshopsessions,workshopenvironments --all
```

Ensure the Learning Center operator is still running when running this command.

2. Verify you have deleted all current workshop environments by running:

```
kubectl get workshops,trainingportals,workshoprequests,workshopsessions,workshopenvironments --all-namespaces
```

This command does not delete the workshops in the `workshops.learningcenter.tanzu.vmware.com` package.

3. Uninstall the Learning Center package by running:

```
tanzu package installed delete {NAME_OF_THE_PACKAGE} -n tap-install
```

This command also removes the added custom resource definitions and the `learningcenter` namespace.

**Note**

If you have installed the Tanzu Application Platform package, Learning Center will be recreated.

- To remove the Learning Center package, add the following lines to your `tap-values` file.

```
excluded_packages:
- learningcenter.tanzu.vmware.com
- workshops.learningcenter.tanzu.vmware.com
```

Local install guides

The following topics describe how you install Learning Center on your local environment:

- [Install on Kind](#)
- [Install on Minikube](#)

Local install guides

The following topics describe how you install Learning Center on your local environment:

- [Install on Kind](#)
- [Install on Minikube](#)

Install Learning Center on Kind

This topic describes how you install Learning Center on you local machine with Kind.

Kind was developed as a means to support development and testing of Kubernetes. Though it exists primarily for that purpose, Kind clusters are often used for local development of user applications as well. For Learning Center, you can use a local Kind cluster to develop workshop content or self-learning when deploying other people's workshops.

Because you are deploying to a local machine, you are unlikely to have access to your own custom domain name and certificate you can use with the cluster. If you don't, you can be restricted as to the sorts of workshops you can develop or run using the Learning Center in Kind. Kind uses `containerd`, which lacks certain features that allow you to trust any image registries hosted within a subnet. This means you cannot readily run workshops that use a local container image registry for each workshop session. If you must run workshops on your local computer that uses an image registry for each session, VMware recommends you use minikube with `dockerd` instead. For more information, see [Install on Minikube](#).

Also, since Kind has limited memory resources available, you may be prohibited from running workshops that have large memory requirements. Workshops that demonstrate the use of third-party applications requiring a multinode cluster also do not work unless the Kind cluster is specifically configured to be multinode rather than single node.

Requirements and setup instructions specific to Kind are detailed in this document. Otherwise, follow normal installation instructions for the Learning Center operator.

Prerequisites

You must complete the following installation prerequisites as a user prior to installation:

- Create a [Broadcom Support](#) account and have access to its credentials.

- Install Kind on your local machine.
- Install Tanzu CLI on your local machine.
- Install Kubernetes command-line tool (kubectl) on your local machine.

Kind cluster creation

When initially creating the Kind cluster, you must [configure](#) it so that the ingress controller is exposed. The Kind documentation provides the following command to do this, but check the documentation in case the details have changed.

```
cat <<EOF | kind create cluster --config=-
kind: Cluster
apiVersion: kind.x-k8s.io/v1alpha4
nodes:
- role: control-plane
  kubeadmConfigPatches:
  - |
    kind: InitConfiguration
    nodeRegistration:
      kubeletExtraArgs:
        node-labels: "ingress-ready=true"
  extraPortMappings:
  - containerPort: 80
    hostPort: 80
    protocol: TCP
  - containerPort: 443
    hostPort: 443
    protocol: TCP
EOF
```

Once you have the Kind cluster up and running, you must install an ingress controller.

Ingress controller with DNS

The Kind documentation provides instructions for installing Ambassador, Contour, and Nginx-based ingress controllers.

VMware recommends that you use [Contour](#) rather than Nginx, because Nginx drops websocket connections whenever new ingresses are created. The Learning Center workshop environments do include a workaround to re-establish websocket connections for the workshop terminals without losing terminal state, but other applications used with workshops might not, such as terminals available through Visual Studio Code.

Avoid using the Ambassador ingress controller, because it requires all ingresses created to be annotated explicitly with an ingress class of “ambassador.” The Learning Center operator can be configured to do this automatically for ingresses created for the training portal and workshop sessions. However, any workshops that create ingresses as part of the workshop instructions do not work unless they are written to have the user manually add the ingress class when required due to the use of Ambassador.

If you have created a contour ingress controller, verify all pods have a running status. Run:

```
kubectl get pods -n projectcontour -o wide
```

For information about installing Contour, which comes with Tanzu Application Platform, see [Install cert-manager, Contour](#).

Install carvel tools

You must install the kapp controller and secret-gen controller carvel tools in order to properly install VMware Tanzu packages.

To install kapp controller, run:

```
kapp deploy -a kc -f https://github.com/vmware-tanzu/carvel-kapp-controller/releases/latest/download/release.yml
```

To install secret-gen controller, run:

```
kapp deploy -a sg -f https://github.com/vmware-tanzu/carvel-secretgen-controller/releases/latest/download/release.yml
```



Note

Type “y” and enter to continue when prompted during installation of both kapp and secret-gen controllers.

Install Tanzu package repository

Follow these steps to install the Tanzu package repository:

1. To create a namespace, run:

```
kubectl create ns tap-install
```

2. Create a registry secret:

```
tanzu secret registry add tap-registry \
  --username "BROADCOM-USER" --password "BROADCOM-PASSWORD" \
  --server tanzu.packages.broadcom.com \
  --export-to-all-namespaces --yes --namespace tap-install
```

Where **BROADCOM-USER** and **BROADCOM-PASSWORD** are your credentials for Broadcom Support.

3. Add a vpackage repository to your cluster:

```
tanzu package repository add tanzu-tap-repository \
  --url tanzu.packages.broadcom.com/tanzu-application-platform/tap-packages:VERSION-NUMBER \
  --namespace tap-install
```

Where **VERSION-NUMBER** is your Tanzu Application Platform version. For example, **1.6.13**.



Note

We are currently on build 7. If this changes, we need to update the command with the correct build version after the `-url` flag.

4. To check the package repository install status, run:

```
tanzu package repository get tanzu-tap-repository --namespace tap-install
```

Wait for a reconciled successful status before attempting to install any other packages.

Create a configuration YAML file for Learning Center package

To create a configuration YAML file:

See [Supported yaml file configurations](#) to see a list of configurations you can provide to Learning Center.

1. Create a file called `learningcenter-value.yaml` in your current directory with the following data:

```
ingressDomain: workshops.example.com
```

Where:

- `ingressDomain` is `<your-local-ip>.nip.io` if you are using a `nip.io` DNS address. Details about this are provided in the following section.
- `workshops.example.com` with is `<your-local-ip>.nip.io`.

Using a `nip.io` DNS address

Before you can start deploying workshops, you must configure the operator to tell it what domain name can be used to access anything deployed by the operator.

Being a local cluster that isn't exposed to the Internet with its own custom domain name, you can use a `nip.io` address.

To calculate the `nip.io` address to use, first work out the IP address for the ingress controller exposed by Kind. This is usually the IP address of the local machine itself, even when you use Docker for Mac.

How you get the IP address for your local machine depends on the operating system you are using.

For example on a Mac, you can find your IP address by searching for network using spotlight and selecting the network option under system preferences. Here you can see your IP address under status.

After you have the IP address, add this as a prefix to the domain name `nip.io`. For example, if the address was `192.168.1.1`, use the domain name of `192.168.1.1.nip.io`.

To configure the Learning Center operator with this cluster domain, run:

```
kubectl set env deployment/learningcenter-operator -n eduk8s INGRESS_DOMAIN=192.168.1.1.nip.io
```

This causes the Learning Center operator to redeploy with the new configuration. You can now deploy workshops.



Note

Some home Internet gateways implement what is called rebind protection. These gateways do not allow DNS names from the public Internet bind to local IP address ranges inside the home network. If your home Internet gateway has such a feature and it is enabled, it blocks `nip.io` addresses from working. In this case, you must configure your home Internet gateway to allow `*.nip.io` names to be bound to local addresses. Also, you cannot use an address of form `127.0.0.1.nip.io` or `subdomain.localhost`. This causes a failure, because when internal services need to

connect to each other, they connect to themselves instead. This happens because the address resolves to the host loopback address of `127.0.0.1`.

Install Learning Center package onto a Kubernetes cluster

To install Learning Center on a Kubernetes cluster:

```
tanzu package install learningcenter --package-name learningcenter.tanzu.vmware.com --version 0.1.0 -f ./learningcenter-value.yaml --namespace tap-install
```

This package installation uses the installed Package repository with a configuration `learningcenter-value.yaml` to install our Learning Center package.

Install workshop tutorial package onto a Kubernetes cluster

To install a workshop tutorial on a Kubernetes cluster:

```
tanzu package install learningcenter-tutorials --package-name workshops.learningcenter.tanzu.vmware.com --version 0.1.0 --namespace tap-install
```

Make sure you install the workshop package after the Learning Center package has reconciled and successfully installed onto your cluster. In case of new versioning, to obtain package version numbers, run:

```
kubectl get packages -n tap-install
```

Run the workshop

To get the training portal URL, run:

```
kubectl get trainingportals
```

You get a URL that you can paste into your browser.

Congratulations, you are now running our tutorial workshop using the Learning Center operator.

Trusting insecure registries

Workshops can optionally deploy a container image registry for a workshop session. This image registry is secured with a password specific to the workshop session and is exposed through a Kubernetes ingress so it can be accessed from the workshop session.

In a typical scenario, Kind uses insecure ingress routes. Even were you to generate a self-signed certificate to use for ingress, it is not trusted by `containerd` that runs within Kind. You must tell Kind to trust any insecure registry running inside of Kind.

You must configure Kind to trust insecure registries when you first create the cluster. Kind, however, is that it uses `containerd` and not `dockerd`. The `containerd` runtime doesn't provide a way to trust any insecure registry hosted within the IP subnet used by the Kubernetes cluster. Instead, `containerd` requires that you enumerate every single host name or IP address on which an insecure registry is hosted. Because each workshop session created by the Learning Center for a workshop uses a different host name, this becomes cumbersome.

If you must use Kind, find out the image registry host name for a workshop deployment and configure `containerd` to trust a set of host names corresponding to low-numbered sessions for that workshop. This allows Kind to work, but once the host names for sessions go beyond the range of

host names you set up, you need to delete the training portal and recreate it, so you can use the same host names again.

For example, if the host name for the image registry were of the form:

```
lab-docker-testing-wMM-sNNN-registry.192.168.1.1.nip.io
```

where **NNN** changes per session, you must use a command to create the Kind cluster. For example:

```
cat <<EOF | kind create cluster --config=-
kind: Cluster
apiVersion: kind.x-k8s.io/v1alpha4
nodes:
- role: control-plane
  kubeadmConfigPatches:
  - |
    kind: InitConfiguration
    nodeRegistration:
      kubeletExtraArgs:
        node-labels: "ingress-ready=true"
  extraPortMappings:
  - containerPort: 80
    hostPort: 80
    protocol: TCP
  - containerPort: 443
    hostPort: 443
    protocol: TCP
containerdConfigPatches:
- |
  [plugins."io.containerd.grpc.v1.cri".registry.mirrors."lab-docker-testing-w01-s001-r
egistry.192.168.1.1.nip.io"]
    endpoint = ["http://lab-docker-testing-w01-s001-registry.192.168.1.1.nip.io"]
  [plugins."io.containerd.grpc.v1.cri".registry.mirrors."lab-docker-testing-w01-s002-r
egistry.192.168.1.1.nip.io"]
    endpoint = ["http://lab-docker-testing-w01-s002-registry.192.168.1.1.nip.io"]
  [plugins."io.containerd.grpc.v1.cri".registry.mirrors."lab-docker-testing-w01-s003-r
egistry.192.168.1.1.nip.io"]
    endpoint = ["http://lab-docker-testing-w01-s003-registry.192.168.1.1.nip.io"]
  [plugins."io.containerd.grpc.v1.cri".registry.mirrors."lab-docker-testing-w01-s004-r
egistry.192.168.1.1.nip.io"]
    endpoint = ["http://lab-docker-testing-w01-s004-registry.192.168.1.1.nip.io"]
  [plugins."io.containerd.grpc.v1.cri".registry.mirrors."lab-docker-testing-w01-s005-r
egistry.192.168.1.1.nip.io"]
    endpoint = ["http://lab-docker-testing-w01-s005-registry.192.168.1.1.nip.io"]
EOF
```

This allows you to run five workshop sessions before you have to delete the training portal and recreate it.

If you use this, you can use the feature of the training portal to automatically update when a workshop definition is changed. This is because the **wMM** value identifying the workshop environment changes any time you update the workshop definition.

There is no other known workaround for this limitation of **containerd**. As such, VMware recommends you use minikube with **dockerd** instead. For more information, see [Install on Minikube](#).

Install Learning Center on Minikube

This topic describes how you install Learning Center on your local machine with Minikube.

Minikube enables local deployment of Kubernetes for developing workshop content or for self-learning when deploying other people's workshops.

Because you are deploying to a local machine, you are unlikely to have access to your own custom domain name and certificate you can use with the cluster. You must take extra steps over a standard install of Minikube to ensure you can run certain types of workshops.

Also, because Minikube generally has limited memory resources available and is only a single-node cluster, you might be restricted from running workshops that have large memory requirements or that demonstrate the use of third-party applications requiring a multinode cluster.

Requirements and setup instructions specific to Minikube are detailed in this document. Otherwise, you can follow normal installation instructions for the Learning Center operator.

Trusting insecure registries

Workshops can optionally deploy a container image registry for a workshop session. This image registry is secured with a password specific to the workshop session and is exposed through a Kubernetes ingress so it can be accessed from the workshop session.

In a typical scenario, Minikube uses insecure ingress routes. Even were you to generate a self-signed certificate to use for ingress, it is not trusted by `dockerd` that runs within Minikube. You must tell Minikube to trust any insecure registry running inside of Minikube.

You must configure Minikube to trust insecure registries the first time you start a new cluster with it. That is, you must supply the details to `minikube start`, which means you must know the IP subnet Minikube uses.

If you already have a cluster running using Minikube, run `minikube ip` to discover the IP address it uses. From that you can discover the trusted subnet. For example, if `minikube ip` returned `192.168.64.1`, the trusted subnet is `192.168.64.0/24`.

With this information, when you start a new cluster with Minikube, run:

```
minikube start --insecure-registry=192.168.64.0/24
```

If you already have a cluster started with Minikube, you cannot stop it and then provide this option when it is restarted. You can only use this option for a completely new cluster.

You must also use `dockerd`, not `containerd`, in the Minikube cluster. `containerd` does not accept an IP subnet when defining insecure registries to be trusted. It allows only specific hosts or IP addresses. Because you don't know what IP address Minikube will use in advance, you can't provide the IP address on the command line when starting Minikube to create the cluster.

Prerequisites

You must complete the following installation prerequisites as a user prior to installation:

- Create a tanzunet account and have access to your tanzunet credentials.
- Install miniKube on your local machine.
- Install tanzuCLI on your local machine.
- Install kubectlCLI on your local machine.

Ingress controller with DNS

After the Minikube cluster is running, you must enable the `ingress` and `ingress-dns` add-ons for Minikube. These deploy the nginx ingress controller along with support for integrating into DNS.

To enable these after the cluster has been created, run:

```
minikube addons enable ingress
minikube addons enable ingress-dns
```

You are now ready to install the Learning Center package.



Note

The ingress add-ons for Minikube do not work when using Minikube on top of Docker for Mac or Docker for Windows. On macOS you must use the Hyperkit VM driver. On Windows you must use the Hyper-V VM driver.

Install carvel tools

You must install the kapp controller and secret-gen controller carvel tools in order to properly install VMware Tanzu packages.

To install kapp controller, run:

```
kapp deploy -a kc -f https://github.com/vmware-tanzu/carvel-kapp-controller/releases/latest/download/release.yml
```

To install secret-gen controller, run:

```
kapp deploy -a sg -f https://github.com/vmware-tanzu/carvel-secretgen-controller/releases/latest/download/release.yml
```

Type “y” and enter to continue when prompted during installation of both kapp and secret-gen controllers.

Install Tanzu package repository

Follow these steps to install the Tanzu package repository:

1. To create a namespace, run:

```
kubectl create ns tap-install
```

2. Create a registry secret:

```
tanzu secret registry add tap-registry \
  --username "TANZU-NET-USER" --password "TANZU-NET-PASSWORD" \
  --server tanzu.packages.broadcom.com \
  --export-to-all-namespaces --yes --namespace tap-install
```

Where:

- `BROADCOM-USER` and `BROADCOM-PASSWORD` are your credentials for Broadcom Support.

3. Add a package repository to your cluster:

```
tanzu package repository add tanzu-tap-repository \
  --url tanzu.packages.broadcom.com/tanzu-application-platform/tap-packages:VERSION-NUMBER \
  --namespace tap-install
```

Where `VERSION-NUMBER` is your Tanzu Application Platform version. For example, `1.6.13`.



Note

We are currently on build 7; if this changes, we need to update the command with the correct build version after the `-url` flag.

- To check the package repository install status, run:

```
tanzu package repository get tanzu-tap-repository --namespace tap-install
```

Wait for a reconciled successful status before attempting to install any other packages.

Create a configuration YAML file for the Learning Center package

Create a file called `learningcenter-value.yaml` in your current directory with the following data:

See [Supported yaml file configurations](#) to see a list of configurations you can provide to Learning Center.

```
ingressDomain: workshops.example.com
```

Where:

- `ingressDomain` is `<your-local-ip>.nip.io` if you are using a `nip.io` DNS address. Details about this are provided in the following section.
- `workshops.example.com` is `<your-local-ip>.nip.io`

Using a `nip.io` DNS address

After the Learning Center operator is installed, before you can start deploying workshops, you must configure the operator to tell it what domain name can be used to access anything deployed by the operator.

Being a local cluster that isn't exposed to the Internet with its own custom domain name, you can use a `nip.io` address.

To calculate the `nip.io` address to use, first work out the IP address of the cluster created by Minikube by running `minikube ip`. Add this as a prefix to the domain name `nip.io`. For example, if `minikube ip` returns `192.168.64.1`, use the domain name of `192.168.64.1.nip.io`.

To configure the Learning Center operator with this cluster domain, run:

```
kubectl set env deployment/learningcenter-operator -n learningcenter INGRESS_DOMAIN=192.168.64.1.nip.io
```

This causes the Learning Center operator to redeploy with the new configuration. You should now be able to start deploying workshops.



Note

Some home Internet gateways implement what is called rebind protection. These gateways do not let DNS names from the public Internet bind to local IP address ranges inside the home network. If your home Internet gateway has such a feature and it is enabled, it blocks `nip.io` addresses from working. In this case, you must configure your home Internet gateway to allow `*.nip.io` names to be bound to local addresses.

Install Learning Center package onto a minikube cluster

To install the Learning Center package onto a minikube cluster, run:

```
tanzu package install learningcenter --package-name learningcenter.tanzu.vmware.com --version 0.1.0 -f ./learningcenter-value.yaml --namespace tap-install
```

This package installation uses the installed Package repository with a configuration `learningcenter-value.yaml` to install the Learning Center package.

Install workshop tutorial package onto a minikube cluster

To install the workshop tutorial package onto a minikube cluster, run:

```
tanzu package install learningcenter-tutorials --package-name workshops.learningcenter.tanzu.vmware.com --version 0.1.0 --namespace tap-install
```

Make sure you install the workshop package after the Learning Center package has reconciled and successfully installed onto your cluster. In case of new versioning, to obtain package version numbers, run:

```
kubectl get packages -n tap-install
```

Run the workshop

To get the training portal URL, run:

```
kubectl get trainingportals
```

You get a URL that you can paste into your browser.

Congratulations, you are now running the tutorial workshop using the Learning Center operator.

Working with large images

If you create or run workshops that work with the image registry created for a workshop session, and you push images to that image registry that have large layers, you must configure the version of nginx deployed for the ingress controller and increase the allowed size of request data for a HTTP request.

To do this, run:

```
kubectl edit configmap nginx-load-balancer-conf -n kube-system
```

To the config map resource, add the following property under `data`:

```
proxy-body-size: 1g
```

If you don't increase this, `docker push` fails when trying to push container images with large layers.

Limited resource availability

When deploying a cluster, by default Minikube only configures support for 2Gi of memory. This usually isn't adequate.

To view how much memory is available when a custom amount has been set as a default, run:

```
minikube config get memory
```

VMware recommends you configure Minikube to use 4Gi or more. This must be specified when the cluster is first created. Do this by using the `--memory` option to `minikube start` or by specifying a default memory value beforehand by using `minikube config set memory`.

In addition to increasing the memory available, you can increase the disk size, because fat container images can quickly use disk space within the cluster.

Storage provisioner issue

v1.12.3 of Minikube introduced a [bug](#) in the storage provisioner that causes potential corruption of data in persistent volumes where the same persistent volume claim name is used in two different namespaces. This affects Learning Center when:

- You deploy multiple training portals at the same time.
- You run multiple workshops at the same time that have docker or image registry support enabled.
- The workshop session itself is backed by persistent storage and multiple sessions run at the same time.

This issue is supposed to be fixed in Minikube v1.13.0; however, you can still encounter issues when deleting a training portal instance and recreating it immediately with the same name. This occurs because reclaiming of the persistent volume by the Minikube storage provisioner can be slow, and the new instance can grab the same original directory on disk with old data in it. After deleting a training portal instance, wait before recreating one with the same name to allow the storage provisioner to delete the old persistent volume.

Create workshops for Learning Center

This section provides information about how you create Learning Center workshops.

- [Workshop configuration](#)
- [Workshop images](#)
- [Workshop content](#)
- [Build an image](#)
- [Workshop instructions](#)
- [Workshop runtime](#)
- [Workshop slides](#)
- [Air-gapped environment requirements](#)

Create workshops for Learning Center

This section provides information about how you create Learning Center workshops.

- [Workshop configuration](#)
- [Workshop images](#)
- [Workshop content](#)
- [Build an image](#)
- [Workshop instructions](#)

- [Workshop runtime](#)
- [Workshop slides](#)
- [Air-gapped environment requirements](#)

Configure your Learning Center workshop

This topic describes the two main steps required to configure your Learning Center workshop. The first specifies the structure of the workshop content and the second defines the runtime requirements for deploying the workshop.

Specifying structure of the content

There are multiple ways you can configure a workshop to specify the structure of the content. The sample workshops use YAML files.

The `workshop/modules.yaml` file provides details about the list of available modules that make up your workshop and data variables for use in content.

The list of available modules represents all of the modules available to you. You might not use all of them. You might want to run variations of your workshop, such as for different programming languages. As such, which modules are active and are used for a specific workshop are listed in the separate `workshop/workshop.yaml` file. The active modules are listed with the name to be given to that workshop.

By default the `workshop.yaml` file specifies what modules are used. When you want to deliver different variations of the workshop content, you can provide multiple workshop files with different names. For example, you can name the workshop files `workshop-java.yaml` and `workshop-python.yaml`.

Where you have multiple workshop files and don't have the default `workshop.yaml` file, you can specify the default workshop file by setting the `WORKSHOP_FILE` environment variable in the runtime configuration.

The format for listing the available modules in the `workshop/modules.yaml` file is:

```
modules:
  workshop-overview:
    name: Workshop Overview
    exit_sign: Setup Environment
  setup-environment:
    name: Setup Environment
    exit_sign: Start Workshop
  exercises/01-sample-content:
    name: Sample Content
  workshop-summary:
    name: Workshop Summary
    exit_sign: Finish Workshop
```

Each available module is listed under `modules`, where the name used corresponds to the path to the file containing the content for that module. Any extension identifying the content type is left off.

For each module, set the `name` field to the page title to be displayed for that module. If no fields are provided and `name` is not set, the title for the module is derived from the name of the module file.

The corresponding `workshop/workshop.yaml` file, where all available modules are used, would have the format:

```

name: Markdown Sample
modules:
  activate:
    - workshop-overview
    - setup-environment
    - exercises/01-sample-content
    - workshop-summary

```

The top-level `name` field in this file is the name of this variation of the workshop content.

The `modules.activate` field is a list of modules to be used for the workshop. The names in this list must match the names as they appear in the modules file.

The order in which modules are listed under the `modules.activate` field in the workshop configuration file dictates the order pages are traversed. The order in which modules appear in the modules configuration file is not relevant.

At the bottom of each page, a **Continue** button is displayed to allow the user to go to the next page in sequence. You can customize the label on this button by setting the `exit_sign` field in the entry for the module in the modules configuration file.

In the last module in the workshop, a button is displayed, but where the user goes after clicking it varies. If you want the user to go to a different website upon completion, you can set the `exit_link` field of the final module to an external URL. Alternatively, you can set the `RESTART_URL` environment variable in a workshop environment to control where the user goes. If a destination for the final page is not provided, the user is redirected back to the starting page of the workshop.

When the user uses the training portal, the training portal overrides this environment variable so, at the completion of a workshop, the user returns to the training portal.

VMware recommends that for the last page, the `exit_sign` be set to “Finish Workshop” and `exit_link` not be specified. This enables the destination to be controlled from the workshop environment or training portal.

Specifying the runtime configuration

You can deploy workshop images directly to a container runtime. The Learning Center Operator is provided to manage deployments into a Kubernetes cluster. You define the configuration for the Learning Center Operator with a `Workshop` CRD in the `resources/workshop.yaml` file:

```

apiVersion: learningcenter.tanzu.vmware.com/v1beta1
kind: Workshop
metadata:
  name: lab-markdown-sample
spec:
  vendor: learningcenter.tanzu.vmware.com
  title: Markdown Sample
  description: A sample workshop using Markdown
  url: YOUR-GIT-URL-FOR-LAB-MARKDOWN-SAMPLE
  content:
    image: {YOUR-REGISTRY-URL}/lab-markdown-sample:main
  duration: 15m
  session:
    namespaces:
      budget: small
    applications:
      console:
        enabled: true
      editor:
        enabled: true

```

Where `YOUR-GIT-URL-FOR-LAB-MARKDOWN-SAMPLE` is the Git repository URL for `lab-markdown-sample`. For example, `{YOUR-GIT-REPO-URL}/lab-markdown-sample`.

In this sample, a custom workshop image bundles the workshop content into its own container image. The `content.image` setting specifies this. To instead download workshop content from a GitHub repository at runtime, use:

```
apiVersion: learningcenter.tanzu.vmware.com/v1beta1
kind: Workshop
metadata:
  name: lab-markdown-sample
spec:
  vendor: learningcenter.tanzu.vmware.com
  title: Markdown Sample
  description: A sample workshop using Markdown
  url: YOUR-GIT-URL-FOR-LAB-MARKDOWN-SAMPLE
  content:
    files: YOUR-GIT-URL-FOR-LAB-MARKDOWN-SAMPLE
  duration: 15m
  session:
    namespaces:
      budget: small
    applications:
      console:
        enabled: true
      editor:
        enabled: true
```

Where:

- `YOUR-GIT-URL-FOR-LAB-MARKDOWN-SAMPLE` is the Git repository URL for `lab-markdown-sample`. For example, `{YOUR-GIT-REPO-URL}/lab-markdown-sample`.

The difference is the use of the `content.files` setting. Here, the workshop content is overlaid on top of the standard workshop base image. To use an alternate base image with additional applications or packages installed, specify the alternate image against the `content.image` setting at the same time you set `content.files`.

Next steps

- Learn about configuration options for the `workshop.yaml` custom resource definitions (CRD) in [Workshop resource](#).

Create the image for your Learning Center workshop

The workshop environment for the Learning Center is packaged as a container image. This topic describes how you create the Learning Center workshop image.

You can execute the image with remote content pulled down from GitHub or a web server. Alternatively, you can bundle your workshop content, including any extra tools required, in a new container image derived from the workshop environment base image.

Templates for creating a workshop

To get you started with your own workshop content, VMware provides a number of sample workshops. Different templates in Markdown or AsciiDoc are available to use depending on the syntax you use to create the workshop. These templates are available in a zip file called `learning-center-workshop-samples.zip` on the [Broadcom Support Portal](#). The zip file contains the following projects that you can upload to your own Git repository:

- lab-markdown-sample
- lab-asciidoc-sample

When creating your own workshops, a suggested convention is to prefix the directory name with the Git repository name where it is hosted. For example, you can make the prefix `lab-`. This way it stands out as a workshop or lab when you have a number of Git repositories on the same Git hosting service account or organization.



Important

Do not make the name you use for a workshop too long. The DNS host name used for applications deployed from the workshop, when using certain methods of deployment, might exceed the 63 character limit. This is because the workshop deployment name is used as part of the namespace for each workshop session. This in turn is used in the DNS host names generated for the ingress host name. VMware suggests keeping the workshop name, and so your repository name, to 25 characters or less.

Workshop content directory layout

After creating a copy of the sample workshop content, you can see a number of files located in the top-level directory and a number of subdirectories forming a hierarchy. The files in the top-level directory are:

- `README.md` - A file stating what the workshop in your Git repository is about and how to deploy it. Replace the current content provided in the sample workshop with your own.
- `LICENSE` - A license file so people are clear about how they can use your workshop content. Replace this with what license you want to apply to your workshop content.
- `Dockerfile` - Steps to build your workshop into an image ready for deployment. Leave this as is, unless you want to customize it to install additional system packages or tools.
- `kustomization.yaml` - A kustomize resource file for loading the workshop definition. The Learning Center operator must be deployed before using this file.
- `.dockerignore` - List of files to ignore when building the workshop content into an image.
- `.educ8signore` - List of files to ignore when downloading workshop content into the workshop environment at runtime.

Key subdirectories and the files contained within them are:

- `workshop` - Directory under which your workshop files reside.
- `workshop/modules.yaml` - Configuration file with details of available modules that make up your workshop and data variables for use in content.
- `workshop/workshop.yaml` - Configuration file that gives the name of the workshop, the list of active modules for the workshop, and any overrides for data variables.
- `workshop/content` - Directory under which your workshop content resides, including images to be displayed in the content.
- `resources` - Directory under which Kubernetes custom resources are stored for deploying the workshop using the Learning Center.
- `resources/workshop.yaml` - The custom resources for the Learning Center, which describe your workshop and requirements for deployment.

- `resources/training-portal.yaml` - A sample custom resource for the Learning Center for creating a training portal for the workshop, encompassing the workshop environment and a workshop instance.

A workshop can include other configuration files and directories with other types of content, but this is the minimal set of files to get you started.

Directory for workshop exercises

The number of files and directories can quickly add up at the top level of your repository. The same is true of the home directory for the user when running the workshop environment. To help with this proliferation of files, you can push files required for exercises during the workshop into the `exercises` subdirectory under the root of the repository.

With an `exercises` subdirectory, the initial working directory for the embedded terminal when created is set to `$HOME/exercises` instead of `$HOME`. If the embedded editor is enabled, the subdirectory is opened as the workspace for the editor. Only directories and files in that subdirectory are visible through the default view of the editor.

However, the `exercises` directory isn't set as the home directory of the user. This means if a user inadvertently runs `cd` with no arguments from the terminal, they go back to the home directory.

To avoid confusion and help a user return to where they must be, VMware recommends that when you instruct users to change directories, provide a full path relative to the home directory. For example, use a path of the form `~/exercises/example-1` rather than `example-1` for the `cd` command when changing directories. By using a full path, users can execute the command and be assured of going to the required location.

Working on your Learning Center workshop content

This topic tells you about the best practices for speeding up the iterative loop of editing and testing a Learning Center workshop when developing the content.

Workshop content is either embedded in a custom workshop image or downloaded from a Git repository or web server when the workshop session is created.

Deactivating reserved sessions

Deactivate the reserved sessions by setting the `reserved` field to `0` in your training portal instance:

```
apiVersion: learningcenter.tanzu.vmware.com/v1beta1
kind: TrainingPortal
metadata:
  name: lab-sample-workshop
spec:
  portal:
    sessions:
      maximum: 1
  workshops:
  - name: lab-sample-workshop
    reserved: 0
    expires: 120m
    orphaned: 15m
```

If you do not deactivate reserved sessions, a new session is always created ready for the next workshop session when there is available capacity to do so. If you modify workshop content while testing the current workshop session, terminate the session and start a new one, the workshop picks up the reserved session. The reserved session has a copy of the old content.

By deactivating reserved sessions, a new workshop session is always created on demand. This ensures the latest workshop content is used.

Because you might have to wait to create a new workshop, shut down the existing workshop session first. The new workshop session might also take some time to start if an updated version of the workshop image also has to be pulled down.

Live updates to the content

If you download workshop content from a Git repository or web server, and you are only doing simple updates to workshop instructions, scripts, or files bundled with the workshop, you can update the content in place without needing to restart the workshop session. To perform an update, download the workshop content after you have pushed back any changes to the hosted Git repository or updated the content available through the web server. From the workshop session terminal, run:

```
update-workshop
```

This command downloads any workshop content from the Git repository or web server, unpacks it into the live workshop session, and re-runs any script files found in the `workshop/setup.d` directory.

Find the location where the workshop content is downloading by viewing the file:

```
cat ~/.eduk8s/workshop-files.txt
```

You can change the location saved in this file if, for example, it references a specific version of the workshop content and you want to test with a different version.

Once the workshop content has been updated, reload the current page of the workshop instructions by clicking the reload icon on the dashboard while holding down the shift key.

If additional pages are added to the workshop instructions or pages are renamed, you must restart the workshop renderer process by running:

```
restart-workshop
```

If you didn't rename the current pager or if the name changed, you can trigger a reload of the current page. Click the home icon or refresh the webpage if the name of the first page didn't change.

If action blocks within the workshop instructions are broken, to change and test the workshop instructions within the live workshop session, you can edit the appropriate page under `/opt/workshop/content`. Navigate to the modified page or reload it to verify the change.

To change set up scripts that create files specific to a workshop session, edit the script under `/opt/workshop/setup.d` directory.

To trigger running of any setup scripts, run:

```
rebuild-workshop
```

If local changes to the workshop session take effect, you can restore the file in the original Git repository.

Updating workshop content in a live session in this way does not undo any deployments or changes you make in the Kubernetes cluster for that session. To retest parts of the workshop instructions, you might have to manually undo the changes in the cluster to replay them. This depends on your specific workshop content.

Custom workshop image changes

If your workshop uses a custom workshop image to provide additional tools and you have included the workshop instructions as part of the workshop image, you must use an image tag of `main`, `develop`, or `latest` during the development of workshop content. Do not use a version image reference.

For example:

```
apiVersion: learningcenter.tanzu.vmware.com/v1beta1
kind: Workshop
metadata:
  name: lab-sample-workshop
spec:
  title: Sample Workshop
  description: A sample workshop
  content:
    image: {YOUR-GIT-REPO-URL}/lab-sample-workshop:main
```

When you use an image tag of `main`, `develop`, or `latest`, the image pull policy is set to `Always` to ensure that the custom workshop image is pulled down again for a new workshop session if the remote image changes. If the image tag is for a specific version, you must change the workshop definition every time when the workshop image changes.

Custom workshop image overlay

For a custom workshop image, you can set up the workshop definition to pull down the workshop content from the hosted Git repository or web server as the follows:

```
apiVersion: learningcenter.tanzu.vmware.com/v1beta1
kind: Workshop
metadata:
  name: lab-sample-workshop
spec:
  title: Sample Workshop
  description: A sample workshop
  content:
    image: {YOUR-REGISTRY-URL}/lab-sample-workshop:main
    files: {YOUR-GIT-REPO-URL}/lab-sample-workshop
```

By pulling down the workshop content as an overlay of the custom workshop image when the workshop session starts, you only need to rebuild the custom workshop image when you need to make changes such as to include additional tools or to ensure the latest workshop instructions are included in the final custom workshop image.

Because the location of the workshop files is known, you can live update the workshop content in the session by following [Live updates to the content](#).

If the additional set of tools required for a workshop is not specific to a workshop, VMware recommends that you create a standalone workshop base image where you can add the tools. You can always pull down content for a specific workshop from a Git repository or web server when the workshop session starts.

```
apiVersion: learningcenter.tanzu.vmware.com/v1beta1
kind: Workshop
metadata:
  name: lab-sample-workshop
spec:
  title: Sample Workshop
  description: A sample workshop
```

```
content:
  image: {YOUR-REGISTRY-URL}/custom-environment:main
  files: {YOUR-GIT-REPO-URL}/lab-sample-workshop
```

This separates generic tooling from specific workshops and so you can use the custom workshop base image for multiple workshops on different, but related topics that require the same tooling.

Changes to workshop definition

By default, to modify the definition for a workshop, you need to delete the training portal instance, update the workshop definition in the cluster, and recreate the training portal.

During the workshop content development, to change resource allocations, role access, or to specify what resource objects to be automatically created for the workshop environment or a specific workshop session, you can enable automatic updates in the training portal definition by setting `updates.workshop` field as `true`:

```
apiVersion: learningcenter.tanzu.vmware.com/v1beta1
kind: TrainingPortal
metadata:
  name: lab-sample-workshop
spec:
  portal:
    sessions:
      maximum: 1
    updates:
      workshop: true
  workshops:
  - name: lab-sample-workshop
    expires: 120m
    orphaned: 15m
```

With automatic updates enabled, if the workshop definition in the cluster is modified, the existing workshop environment managed by the training portal for that workshop is shut down and replaced with a new workshop environment by using the updated workshop definition.

When an active workshop session is running, the actual deletion of the old workshop environment is delayed until that workshop session is terminated.

Local build of workshop image

If you do not package a workshop into a custom workshop image, VMware recommends to build a custom workshop image locally on your own machine by using `docker` to avoid keeping pushing changes to a hosted Git repository and using a Kubernetes cluster for local workshop content development.

Furthermore, to avoid pushing the image to a public image registry on the Internet, you must deploy an image registry to your local Kubernetes cluster where you run the Learning Center. In most cases, a basic deployment of an image registry in a local cluster access is not secure. As a result, you have to configure the Kubernetes cluster to trust the registry that is not secure. This can be difficult to do depending on the Kubernetes cluster you use, but it can enable quicker turnaround because you do not have to push or pull the custom workshop image across the public Internet.

After pushing the custom workshop image built locally to the local image registry, you can set the image reference in the workshop definition to pull the custom workshop from the local registry in the same cluster. To ensure that the custom workshop image is always pulled for a new workshop session after update, use the `latest` tag when tagging and pushing the image to the local registry.

Build an image for your Learning Center workshop

This topic describes how you include an extra system, third-party tool, or configuration in your image by bundling workshop content from the Learning Center workshop base image.

The following sample workshop template provides a [Dockerfile](#).

Structure of the Dockerfile

The structure of the [Dockerfile](#) in the sample workshop template is:

```
FROM tanzu.packages.broadcom.com/tanzu-application-platform/tap-packages@sha256:xxxxxx
xxxxxxxxxxxxxxxxxxxxx

COPY --chown=1001:0 . /home/educ8s/

RUN mv /home/educ8s/workshop /opt/workshop

RUN fix-permissions /home/educ8s
```

The default [Dockerfile](#) action is to:

- Copy all files from a registry to the `/home/educ8s` directory.
 - You must build the custom workshop images on the base environment image according to the version of Tanzu Application Platform. To get the image ID, run:

```
kubectl get ds -n learningcenter learningcenter-prepare -o=jsonpath="{.spec.template.spec.initContainers[0].image}"
```

Example image ID:

```
tanzu.packages.broadcom.com/tanzu-application-platform/tap-packages@sha256:a8870aa60b45495d298df5b65c69b3d7972608da4367bd6e69d6e392ac969dd4
```

- You can build the workshop images directly on the base environment image, or you can create an intermediate base image to install extra packages required by a number of different workshops.
- The `--chown=1001:0` option ensures that files are owned by the appropriate user and group.
- The `workshop` subdirectory is moved to `/opt/workshop` so that it is not visible to the user. This subdirectory is in an area searchable for workshop content, in addition to `/home/educ8s/workshop`.

To customize your [Dockerfile](#):

- You can ignore other files or directories from the repository, by listing them in the `.dockerignore` file.
- You can include `RUN` statements in the [Dockerfile](#) to run custom-build steps, but the `USER` inherited from the base image has user ID `1001` and is not the `root` user.

Custom workshop base images

The `base-environment` workshop images include language run times for Node.js and Python. If you need a different language runtime or a different version of a language runtime, you must create a custom workshop base image which includes the environment you need. This custom workshop image is derived from `base-environment` but includes extra runtime components.

The following Dockerfile example creates a Java JDK11-customized image:

```
ARG IMAGE_REPOSITORY=tanzu.packages.broadcom.com/learning-center
FROM ${IMAGE_REPOSITORY}/pkgs-java-tools as java-tools
FROM tanzu.packages.broadcom.com/tanzu-application-platform/tap-packages@sha256:xxxxxx
xxxxxxxxxxxxx
COPY --from=java-tools --chown=1001:0 /opt/jdk11 /opt/java
COPY --from=java-tools --chown=1001:0 /opt/gradle /opt/gradle
COPY --from=java-tools --chown=1001:0 /opt/maven /opt/maven
COPY --from=java-tools --chown=1001:0 /opt/code-server/extensions/. /opt/code-server/
extensions/
COPY --from=java-tools --chown=1001:0 /home/educ8s/. /home/educ8s/
COPY --from=java-tools --chown=1001:0 /opt/educ8s/. /opt/educ8s/
ENV PATH=/opt/java/bin:/opt/gradle/bin:/opt/maven/bin:$PATH \
    JAVA_HOME=/opt/java \
    M2_HOME=/opt/maven
```

Installing extra system packages

Installing extra system packages requires that you run the installation as `root`. You must switch the user commands before running the command, and then switch the user back to user ID of `1001`.

```
USER root

RUN ... commands to install system packages

USER 1001
```

VMware recommends that you only use the `root` user to install extra system packages. Don't use the `root` user when adding anything under `/home/educ8s`. Otherwise, you must ensure the user ID and group for directories and files are set to `1001:0` and then run the `fix-permissions` command if necessary.

When you run any command as `root`, you must temporarily override the value of the `HOME` environment variable and set it to `/root`.

If you don't do this the `root` user drops configuration files in `/home/educ8s`, thinking it is the `root` home directory, because the `HOME` environment variable is by default set to `/home/educ8s`. This can cause commands run later during the workshop to fail if they try to update the configuration files as they have wrong permissions.

Fixing the file and group ownership and running `fix-permissions` can help with this problem, but not in every case, because of permissions the `root` user may apply and how container image layers work. VMware recommends that you use the following:

```
USER root

RUN HOME=/root && \
    ... commands to install system packages

USER 1001
```

Installing third-party packages

If you are not using system packaging tools to install extra packages, but are manually downloading packages and optionally compiling them to binaries, it is better to do this as the default user and not `root`.

If compiling packages, VMware recommends working in a temporary directory under `/tmp` and removing the directory as part of the same `RUN` statement when done.

If you are installing a binary, you can install it in `/home/educ8s/bin`. This directory is in the application search path defined by the `PATH` environment variable for the image.

To install a directory hierarchy of files, create a separate directory under `/opt` to install everything. You can override the `PATH` environment variable in the `Dockerfile` to add an extra directory for application binaries and scripts. You can override the `LD_LIBRARY_PATH` environment variable for the location of shared libraries.

If installing any files from a `RUN` instruction into `/home/educ8s`, VMware recommends that you run `fix-permissions` as part of the same instruction to avoid copies of files being made into a new layer, which applies to the case where `fix-permissions` is only run in a later `RUN` instruction. You can still leave the final `RUN` instruction for `fix-permissions` as it is smart enough not to apply changes if the file permissions are already set correctly and so it does not trigger a copy of a file when run more than once.

Writing instructions for your Learning Center workshop

This topic describes how you write and format the instructions for a Learning Center workshop. You can use either [Markdown](#) with file extension `.md` or [AsciiDoc](#) with file extension `.adoc` as the markup format for the individual module files that comprise the workshop instructions.

Annotation of executable commands

In conjunction with the standard Markdown and AsciiDoc, you can apply additional annotations to code blocks. The annotations indicate that a user can click the code block and have it copied to the terminal and executed.

If using Markdown, to annotate a code block so it is copied to the terminal and executed, use:

```
```execute
echo "Execute command."
```
```

When the user clicks the code block, the command is executed in the first terminal of the workshop dashboard.

If using AsciiDoc, you can instead use the `role` annotation in an existing code block:

```
[source,bash,role=execute]
----
echo "Execute command."
----
```

When the workshop dashboard is configured to display multiple terminals, you can qualify which terminal the command must be executed in by adding a suffix to the `execute` annotation. For the first terminal, use `execute-1`, for the second terminal `execute-2`, and so on:

```
```execute-1
echo "Execute command."
```

```execute-2
echo "Execute command."
```
```

To execute a command in all terminal sessions on the terminals tab of the dashboard, you can use `execute-all`:

```
```execute-all
clear
```
```

In most cases, a command the user executes completes immediately. To run a command that never returns, with the user needing to interrupt it to stop it, you can use the special string `<ctrl+c>` in a subsequent code block.

```
```execute
<ctrl+c>
```
```

When the user clicks on this code block, the command running in the corresponding terminal is interrupted.



Note

Using the special string `<ctrl+c>` is deprecated, and you must use the `terminal:interrupt` clickable action instead.

Annotation of text to be copied

To copy the content of the code block into the paste buffer instead of running the command, you can use:

```
```copy
echo "Text to copy."
```
```

After the user clicks this code block, they can then paste the content into another window.

If you have a situation where the text being copied must be modified before use, you can denote this special case by using `copy-and-edit` instead of `copy`. The text is still copied to the paste buffer, but is displayed in the browser in a way to highlight that it must be changed before use.

```
```copy-and-edit
echo "Text to copy and edit."
```
```

For AsciiDoc, similar to `execute`, you can add the `role` of `copy` or `copy-and-edit`:

```
[source,bash,role=copy]
----
echo "Text to copy."
----

[source,bash,role=copy-and-edit]
----
echo "Text to copy and edit."
----
```

For `copy` only, to mark an inline code section within a paragraph of text as copyable when clicked, you can append the special data variable reference `{{copy}}` immediately after the inline code block:

```
Text to `copy`{{copy}}.
```

Extensible clickable actions

The preceding means to annotate code blocks were the original methods used to indicate code blocks to be executed or copied when clicked. To support a growing number of clickable actions with different customizable purposes, annotation names are now name-spaced. The preceding annotations are still supported, but the following are now recommended, with additional options available to customize the way the actions are presented.

For code execution, instead of:

```
```execute
echo "Execute command."
```
```

you can use:

```
```terminal:execute
command: echo "Execute command."
```
```

The contents of the code block is YAML. The executable command must be set as the `command` property. By default when the user clicks the command, it is executed in terminal session 1. To select a different terminal session, you can set the `session` property.

```
```terminal:execute
command: echo "Execute command."
session: 1
```
```

To define a command the user clicks that executes in all terminal sessions on the terminals tab of the dashboard, you can also use:

```
```terminal:execute-all
command: echo "Execute command."
```
```

For `terminal:execute` or `terminal:execute-all`, to clear the terminal before the command is executed, set the `clear` property to `true`:

```
```terminal:execute
command: echo "Execute command."
clear: true
```
```

This clears the full terminal buffer and not just the displayed portion of the buffer.

With the new clickable actions, to indicate that a running command in a terminal session must be interrupted, use:

```
```terminal:interrupt
session: 1
```
```

(Optional) Set the `session` property within the code block to indicate an alternate terminal session to session 1.

To allow the user to send an interrupt to all terminals sessions on the terminals tab of the dashboard, use:

```
``terminal:interrupt-all
```
```

Where you want the user to enter input into a terminal rather than a command, such as when a running command prompts for a password, use:

```
``terminal:input
text: password
```
```

To allow the user to run commands or interrupt a command, set the `session` property to indicate a specific terminal to send it to if you don't want to send it to terminal session 1:

```
``terminal:input
text: password
session: 1
```
```

When providing terminal input in this way, the text by default still has a newline appended to the end, making it behave the same as using `terminal:execute`. If you do not want a newline appended, set the `endl` property to `false`.

```
``terminal:input
text: input
endl: false
```
```

To allow the user to clear all terminal sessions on the terminals tab of the dashboard, use:

```
``terminal:clear-all
```
```

This clears the full terminal buffer and not just the displayed portion of the terminal buffer. It does not have any effect when an application is running in the terminal using visual mode. To clear only the displayed portion of the terminal buffer when a command dialog box is displayed, use `terminal:execute` and run the `clear` command.

To allow the user to copy content to the paste buffer, use:

```
``workshop:copy
text: echo "Text to copy."
```
```

or:

```
``workshop:copy-and-edit
text: echo "Text to copy and edit."
```
```

A benefit of using these over the original methods is that by using the appropriate YAML syntax, you can control whether:

- A multiline string value is concatenated into one line.
- Line breaks are preserved.
- Initial or terminating new lines are included.

In the original methods, the string was always trimmed before use. By using the different forms as appropriate, you can annotate the displayed code block with a different message letting the user know what will happen.

The method for using AsciiDoc is similar, using the `role` for the name of the annotation and YAML as the content:

```
[source,bash,role=terminal:execute]

command: echo "Execute command."

```

## Supported workshop editor

Learning Center currently **only** supports the code-server v4.4.0 of VS Code as an editor in workshops.

## Clickable actions for the dashboard

In addition to the clickable actions related to the terminal and copying of text to the paste buffer, other actions are available for controlling the dashboard and opening URL links.

To allow the user to click in the workshop content to open a URL in a new browser, use:

```
```dashboard:open-url
url: https://www.example.com/
```
```

To allow the user to click in the workshop content to display a specific dashboard tab if hidden, use:

```
```dashboard:open-dashboard
name: Terminal
```
```

To allow the user to click in the workshop content to display the console tab, use:

```
```dashboard:open-dashboard
name: Console
```
```

To allow the user to click in the workshop content to display a specific view within the Kubernetes web console by using a clickable action block, rather than requiring the user to find the correct view, use:

```
```dashboard:reload-dashboard
name: Console
prefix: Console
title: List pods in namespace {{session_namespace}}
url: {{ingress_protocol}}://{{session_namespace}}-console.{{ingress_domain}}/#/pod?namespace={{session_namespace}}
description: ""
```
```

To allow the user to create a new dashboard tab with a specific URL, use:

```
```dashboard:create-dashboard
name: Example
url: https://www.example.com/
```
```

To allow the user to create a new dashboard tab with a new terminal session, use:

```
```dashboard:create-dashboard
name: Example
url: terminal:example
```
```

The value must be of the form `terminal:<session>`, where `<session>` is replaced with the name you want to give the terminal session. The terminal session name must be restricted to lowercase letters, numbers, and `-`. You must avoid using numeric terminal session names such as `"1"`, `"2"`, and `"3"`, because these are used for the default terminal sessions.

To allow the user to reload an existing dashboard, using the URL it is currently targeting, use:

```
```dashboard:reload-dashboard
name: Example
```
```

If the dashboard is for a terminal session, there is no effect unless the terminal session was disconnected, in which case it is reconnected.

To allow the user to change the URL target of an existing dashboard by entering the new URL when reloading a dashboard, use:

```
```dashboard:reload-dashboard
name: Example
url: https://www.example.com/
```
```

The user cannot change the target of a dashboard that includes a terminal session.

To allow the user to delete a dashboard, use:

```
```dashboard:delete-dashboard
name: Example
```
```

The user cannot delete dashboards corresponding to builtin applications provided by the workshop environment, such as the default terminals, console, editor, or slides.

Deleting a custom dashboard including a terminal session does not destroy the underlying terminal session, and the user can reconnect it by creating a new custom dashboard for the same terminal session name.

## Clickable actions for the editor

If the embedded editor is enabled, special actions are available that control the editor.

To allow the user to open an existing file you can use:

```
```editor:open-file
file: ~/exercises/sample.txt
```
```

You can use `~/` prefix to indicate the path relative to the home directory of the session. When the user opens the file, if you want the insertion point left on a specific line, provide the `line` property. Lines numbers start at `1`.

```
```editor:open-file
file: ~/exercises/sample.txt
line: 1
```
```



To allow the user to highlight certain lines of a file based on an exact string match, use:

```
```editor:select-matching-text
file: ~/exercises/sample.txt
text: "int main()"
```
```

The region of the match is highlighted by default. To allow the user to highlight any number of lines before or after the line with the match, you can set the `before` and `after` properties:

```
```editor:select-matching-text
file: ~/exercises/sample.txt
text: "int main()"
before: 1
after: 1
```
```

Setting both `before` and `after` to `0` causes the complete line that matched to be highlighted instead of a region within the line.

To match based on a regular expression, rather than an exact match, set `isRegex` to `true`:

```
```editor:select-matching-text
file: ~/exercises/sample.txt
text: "image: (.*)"
isRegex: true
```
```

When a regular expression is used, and subgroups are specified within the pattern, you can indicate which subgroup is selected:

```
```editor:select-matching-text
file: ~/exercises/sample.txt
text: "image: (.*)"
isRegex: true
group: 1
```
```

Where there are multiple possible matches in a file, and the one you want to match is not the first, you can set a range of lines to search:

```
```editor:select-matching-text
file: ~/exercises/sample.txt
text: "image: (.*)"
isRegex: true
start: 8
stop: 12
```
```

Absence of `start` means start at the beginning of the file. Absence of `stop` means stop at the end of the file. The line number given by `stop` is not included in the search.

For both an exact match and regular expression, the text to be matched must all be on one line. It is not possible to match text that spans across lines.

To allow the user to replace text within the file, first match it exactly or use a regular expression so it is marked as selected, then use:

```
```editor:replace-text-selection
file: ~/exercises/sample.txt
```

```
text: nginx:latest
...

```

To allow the user to append lines to the end of a file, use:

```
``editor:append-lines-to-file
file: ~/exercises/sample.txt
text: |
  Lorem ipsum dolor sit amet, consectetur adipiscing elit, sed
  do eiusmod tempor incididunt ut labore et dolore magna aliqua.
...

```

If the user runs the action `editor:append-lines-to-file` and the file doesn't exist, it is created. You can use this to create new files for the user.

To allow the user to insert lines before a specified line in the file, use:

```
``editor:insert-lines-before-line
file: ~/exercises/sample.txt
line: 8
text: |
  Lorem ipsum dolor sit amet, consectetur adipiscing elit, sed
  do eiusmod tempor incididunt ut labore et dolore magna aliqua.
...

```

To allow the user to insert lines after matching a line containing a specified string, use:

```
``editor:append-lines-after-match
file: ~/exercises/sample.txt
match: Lorem ipsum
text: |
  Lorem ipsum dolor sit amet, consectetur adipiscing elit, sed
  do eiusmod tempor incididunt ut labore et dolore magna aliqua.
...

```

Where the file contains YAML, to allow the user to insert a new YAML value into an existing structure, use:

```
``editor:insert-value-into-yaml
file: ~/exercises/deployment.yaml
path: spec.template.spec.containers
value:
- name: nginx
  image: nginx:latest
...

```

To allow the user to execute a registered VS code command, use:

```
``editor:execute-command
command: spring.initializr.maven-project
args:
- language: Java
  dependencies: [ "actuator", "webflux" ]
  artifactId: demo
  groupId: com.example
...

```

Clickable actions for file download

If file downloads are enabled for the workshop, you can use the `files:download-file` clickable action:

```

```files:download-file
path: .kube/config
```

```

The action triggers saving the file to the user's local computer, and the file is not displayed in the user's web browser.

Clickable actions for the examiner

If the test examiner is enabled, special actions are available to run verification checks to verify whether a workshop user has performed a required step. You can trigger these verification checks by clicking on the action, or you can configure them to start running when the page loads.

For a single verification check that the user must click to run, use:

```

```examiner:execute-test
name: test-that-pod-exists
title: Verify that pod named "one" exists.
args:
- one
```

```

The `title` field is displayed as the title of the clickable action and must describe the nature of the test. If required, you can provide a `description` field for a longer explanation of the test. This is displayed in the body of the clickable action but is shown as preformatted text.

There must be an executable program (script or compiled application) in the `workshop/examiner/tests` directory with name matching the value of the `name` field.

The list of program arguments against the `args` field is passed to the test program.

The executable program for the test must exit with a status of 0 if the test is successful and nonzero if the test is a failure. The test should aim to return as quickly as possible and should not be a persistent program.

```

#!/bin/bash

kubectl get pods --field-selector=status.phase=Running -o name | egrep -e "^pod/$1$"

if [ "$?" != "0" ]; then
    exit 1
fi

exit 0

```

By default, the program for a test is stopped after a timeout of 15 seconds, and the test is deemed to have failed. To adjust the timeout, you can set the `timeout` value, which is in seconds. A value of 0 causes the default 15 seconds timeout to be applied. It is not possible to deactivate stopping the test program after running for the default or a specified `timeout` value.

```

```examiner:execute-test
name: test-that-pod-exists
title: Verify that pod named "one" exists
args:
- one
timeout: 5
```

```

To apply the test multiple times, you can enable the retry when a failure occurs. For this you must set the number of times to retry and the delay between retries. The value for the delay is in

seconds.

```

```examiner:execute-test
name: test-that-pod-exists
title: Verify that pod named "one" exists
args:
- one
timeout: 5
retries: 10
delay: 1
```

```

When you use retries, the testing stops as soon as the test program returns that it was successful.

To have retries continue for as long as the page of the workshop instructions displays, set `retries` to the special YAML value of `.INF`:

```

```examiner:execute-test
name: test-that-pod-exists
title: Verify that pod named "one" exists
args:
- one
timeout: 5
retries: .INF
delay: 1
```

```

Rather than require a workshop user to click the action to run the test, you can have the test start as soon as the page is loaded, or when a section the page is contained in is expanded. Do this by setting `autostart` to `true`:

```

```examiner:execute-test
name: test-that-pod-exists
title: Verify that pod named "one" exists
args:
- one
timeout: 5
retries: .INF
delay: 1
autostart: true
```

```

When a test succeeds, to immediately start the next test in the same page, set `cascade` to `true`.

```

```examiner:execute-test
name: test-that-pod-exists
title: Verify that pod named "one" exists
args:
- one
timeout: 5
retries: .INF
delay: 1
autostart: true
cascade: true
```

```examiner:execute-test
name: test-that-pod-does-not-exist
title: Verify that pod named "one" does not exist
args:
- one
retries: .INF
```

```

```
delay: 1
...
```

Clickable actions for sections

For optional instructions, or instructions you want to hide until the workshop user is ready for them, you can designate sections to be hidden. When the user clicks the appropriate action, the section expands to show its content. You can use this for examples that initially hide a set of questions or a test at the end of each workshop page.

In order to designate a section of content as hidden, you must use two separate action code blocks marking the beginning and end of the section:

```
```section:begin
title: Questions
...

To show you understand ...

```section:end
...
```

The `title` must be set to the text you want to include in the banner for the clickable action.

A clickable action is only shown for the beginning of the section, and the action for the end is always hidden. Clicking the action for the beginning expands the section. The user can collapse the section again by clicking the action.

To create nested sections, you must name the action blocks for the beginning and end so they are correctly matched:

```
```section:begin
name: questions
title: Questions
...

To show you understand ...

```section:begin
name: question-1
prefix: Question
title: 1
...

...

```section:end
name: question-1
...

```section:end
name: questions
...`
```

The `prefix` attribute allows you to override the default `Section` prefix used on the title for the action.

If a collapsible section includes an examiner action block set to automatically run, it only starts when the user expands the collapsible section.

In case you want a section header showing in the same style as other clickable actions, you can use:

```
```section:heading
title: Questions
```
```

When the user clicks on this, the action is still marked as completed, but it does not trigger any other action.

Overriding title and description

Clickable action blocks default to use a title with the prefix dictated by what the action block does. The body of the action block also defaults to use a value commensurate with the action.

Especially for complicated scenarios involving editing of files, the defaults might not be the most appropriate and be confusing, so you can override them. To override these defaults, set the `prefix`, `title`, and `description` fields of a clickable action block:

```
```action:name
prefix: Prefix
title: Title
description: Description
```
```

The banner of the action block in this example displays “Prefix: Title”, with the body showing “Description”.



Note

The description is always displayed as pre-formatted text within the rendered page.

Escaping of code block content

Because the [Liquid](#) template engine is applied to workshop content, you must escape content in code blocks that conflict with the syntactic elements of the Liquid template engine. To escape such elements, you can suspend processing by the template engine for that section of workshop content to ensure it is rendered correctly. Do this by using a Liquid `{% raw %}...{% endraw %}` block.

```
{% raw %}
```execute
echo "Execute command."
```
{% endraw %}
```

This has the side effect of preventing interpolation of data variables, so restrict it to only the required scope.

Interpolation of data variables

When creating page content, you can reference a number of predefined data variables. The values of the data variables are substituted into the page when rendered in the user’s browser.

The workshop environment provides the following built-in data variables:

- `workshop_name`: The name of the workshop.
- `workshop_namespace`: The name of the namespace used for the workshop environment.

- `session_namespace`: The name of the namespace the workshop instance is linked to and into which any deployed applications run.
- `training_portal`: The name of the training portal the workshop is hosted by.
- `ingress_domain`: The host domain must be used in the any generated host name of ingress routes for exposing applications.
- `ingress_protocol`: The protocol (http/https) used for ingress routes created for workshops.

To use a data variable within the page content, surround it by matching pairs of brackets:

```
{{ session_namespace }}
```

Do this inside of code blocks, including clickable actions, as well as in URLs:

```
http://myapp-{{ session_namespace }}.{{ ingress_domain }}
```

When the workshop environment is hosted in Kubernetes and provides access to the underlying cluster, the following data variables are also available.

- `kubernetes_token`: The Kubernetes access token of the service account the workshop session is running as.
- `kubernetes_ca_cert`: The contents of the public certificate required when accessing the Kubernetes API URL.
- `kubernetes_api_url`: The URL for accessing the Kubernetes API. This is only valid when used from the workshop terminal.



Note

An older version of the rendering engine required that data variables be surrounded on each side with the character `%`. This is still supported for backwards compatibility, but VMware recommends you use matched pairs of brackets instead.

Adding custom data variables

You can introduce your own data variables by listing them in the `workshop/modules.yaml` file. A data variable is defined as having a default value, but the value is overridden if an environment variable of the same name is defined.

The field under which the data variables must be specified is `config.vars`:

```
config:
  vars:
    - name: LANGUAGE
      value: undefined
```

To use a name for a data variable that is different from the environment variable name, add a list of `aliases`:

```
config:
  vars:
    - name: LANGUAGE
      value: undefined
      aliases:
        - PROGRAMMING_LANGUAGE
```

The environment variables with names in the list of aliases are checked first, then the environment variable with the same name as the data variable. If no environment variables with those names are set, the default value is used.

You can override the default value for a data variable for a specific workshop by setting it in the corresponding workshop file. For example, `workshop/workshop-python.yaml` might contain:

```
vars:
  LANGUAGE: python
```

For more control over setting the values of data variables, you can provide the file `workshop/config.js`. The form of this file is:

```
function initialize(workshop) {
  workshop.load_workshop();

  if (process.env['WORKSHOP_FILE'] == 'workshop-python.yaml') {
    workshop.data_variable('LANGUAGE', 'python');
  }
}

exports.default = initialize;

module.exports = exports.default;
```

This JavaScript code is loaded and the `initialize()` function called to set up the workshop configuration. You can then use the `workshop.data_variable()` function to set up any data variables.

Because it is JavaScript, you can write any code to query process environment variables and set data variables based on those. This might include creating composite values constructed from multiple environment variables. You can even download data variables from a remote host.

Passing environment variables

You can pass environment variables, including remapping of variable names, by setting your own custom data variables. If you don't need to set default values or remap the name of an environment variable, you can instead reference the name of the environment variable directly. You must prefix the name with `ENV_` when using it.

For example, to display the value of the `KUBECTL_VERSION` environment variable in the workshop content, use `ENV_KUBECTL_VERSION`, as in:

```
{{ ENV_KUBECTL_VERSION }}
```

Handling embedded URL links

You can include URLs in workshop content. This can be the literal URL, or the Markdown or AsciiDoc syntax for including and labelling a URL. What happens when a user clicks on a URL depends on the specific URL.

In the case of the URL being an external website, when the URL is clicked, the URL opens in a new browser tab or window. When the URL is a relative page referring to another page that is part of the workshop content, the page replaces the current workshop page.

You can define a URL where components of the URL are provided by data variables. Data variables useful for this are `session_namespace` and `ingress_domain`, because they can be used to create a URL to an application deployed from a workshop:

```
https://myapp-{{ session_namespace }}.{{ ingress_domain }}
```

Conditional rendering of content

Rendering pages is in part handled by the [Liquid](#) template engine. So you can use any constructs the template engine supports for conditional content:

```
{% if LANGUAGE == 'java' %}
....
{% endif %}
{% if LANGUAGE == 'python' %}
....
{% endif %}
```

Embedding custom HTML content

Custom HTML can be embedded in the workshop content by using the appropriate mechanism provided by the content rendering engine used.

If using Markdown, HTML can be embedded directly without being marked as HTML:

```
Lorem ipsum dolor sit amet, consectetur adipiscing elit. Proin justo.

<div>
<table style="width:100%">
  <tr>
    <th>Firstname</th>
    <th>Lastname</th>
    <th>Age</th>
  </tr>
  <tr>
    <td>Jill</td>
    <td>Smith</td>
    <td>50</td>
  </tr>
  <tr>
    <td>Eve</td>
    <td>Jackson</td>
    <td>94</td>
  </tr>
</table>
</div>
```

```
Lorem ipsum dolor sit amet, consectetur adipiscing elit. Proin justo.
```

If using AsciiDoc, HTML can be embedded by using a passthrough block:

```
Lorem ipsum dolor sit amet, consectetur adipiscing elit. Proin justo.

++++
<div>
<table style="width:100%">
  <tr>
    <th>Firstname</th>
    <th>Lastname</th>
    <th>Age</th>
  </tr>
  <tr>
    <td>Jill</td>
    <td>Smith</td>
    <td>50</td>
```

```

</tr>
<tr>
  <td>Eve</td>
  <td>Jackson</td>
  <td>94</td>
</tr>
</table>
</div>
++++

Lorem ipsum dolor sit amet, consectetur adipiscing elit. Proin justo.

```

In both cases, VMware recommends that the HTML consist of only a single HTML element. If you have more than one, include them all in a `div` element. The latter is necessary if any of the HTML elements are marked as hidden and the embedded HTML is a part of a collapsible section. If you don't ensure the hidden HTML element is placed under the single top-level `div` element, the hidden HTML element is visible when the collapsible section is expanded.

In addition to visual HTML elements, you can also include elements for embedded scripts or style sheets.

If you have HTML markup that must be added to multiple pages, extract it into a separate file and use the include file mechanism of the Liquid template engine. You can also use the partial render mechanism of Liquid as a macro mechanism for expanding HTML content with supplied values.

Automate your Learning Center workshop runtime

Your workshop content can script the steps a user must run for a workshop. This topic tells you how to set this up.

In some cases, you must parameterize that content with information from the runtime environment. Data variables in workshop content allow this to a degree, but you can automate this by using scripts executed in the workshop container to set up configuration files.

Do this by supplying setup scripts that run when the container is started. You can also run persistent background processes in the container that perform extra work for you while a workshop is being run.

Predefined environment variables

When you create the workshop content, you can use data variables to automatically insert values corresponding to the specific workshop session or environment. For example: the name of the namespace used for the session and the ingress domain when creating an ingress route.

These data variables can display a YAML/JSON resource file in the workshop content with values already filled out. You can have executable commands that have the data variables substituted with values given as arguments to the commands.

For commands run in the shell environment, you can also reference a number of predefined environment variables.

Key environment variables are:

- `WORKSHOP_NAMESPACE` - The name of the namespace used for the workshop environment.
- `SESSION_NAMESPACE` - The name of the namespace the workshop instance is linked to and into which any deployed applications run.
- `INGRESS_DOMAIN` - The host domain that must be used in any generated host name of ingress routes for exposing applications.
- `INGRESS_PROTOCOL` - The protocol (http/https) used for ingress routes created for workshops.

Instead of having an executable command in the workshop content, use:

```
```execute
kubectl get all -n %session_namespace%
```
```

With the value of the session namespace filled out when the page is rendered, you can use:

```
```execute
kubectl get all -n $SESSION_NAMESPACE
```
```

The shell inserts the value of the environment variable.

Running steps on container start

To run a script that makes use of the earlier environment variables when the container is started, and to perform tasks such as pre-create YAML/JSON resource definitions with values filled out, you can add an executable shell script to the `workshop/setup.d` directory. The name of the executable shell script must have a `.sh` suffix to be recognized and run.

If the container is restarted, the setup script runs again in the new container. If the shell script is performing actions against the Kubernetes REST API using `kubectl` or by using another means, the actions it performs must be tolerant of running more than once.

When using a setup script to fill out values in resource files, a useful utility is `envsubst`. You can use this in a setup script as follows:

```
#!/bin/bash

envsubst < frontend/ingress.yaml.in > frontend/ingress.yaml
```

A reference of the form `${INGRESS_DOMAIN}` in the input file is replaced with the value of the `INGRESS_DOMAIN` environment variable.

Setup scripts have the `/home/educ8s` directory as the current working directory.

If you are creating or updating files in the file system and using a custom workshop image, ensure that the workshop image is created with correct file permissions to allow updates.

Running background applications

The setup scripts run once on container startup. You can use the script to start a background application needed to run in the container for the life of the workshop, but if that application stops, it does not restart.

If you must run a background application, you can integrate the management of the background application with the supervisor daemon run within the container. To have the supervisor daemon manage the application for you, add a configuration file snippet for the supervisor daemon in the `workshop/supervisor` directory. This configuration file must have a `.conf` extension.

The form of the configuration file snippet must be:

```
[program:myapplication]
process_name=myapplication
command=/opt/myapplication/sbin/start-myapplication
stdout_logfile=/proc/1/fd/1
stdout_logfile_maxbytes=0
redirect_stderr=true
```

The application must send any logging output to `stdout` or `stderr`, and the configuration snippet must direct log output to `/proc/1/fd/1` so it is captured in the container log file. If you must restart or shut down the application within the workshop interactive terminal, you can use the `supervisorctl` control script.

Terminal user shell environment

Neither the setup scripts that run when the container starts nor background applications affect the user environment of the terminal shell. The shell environment makes use of `bash` and the `$HOME/.bash_profile` script is read to perform added setup for the user environment. Because some default setup is included in `$HOME/.bash_profile`, you must not replace it, because you can lose that configuration.

To provide commands to initialize each shell environment, you can provide the file `workshop/profile`. When this file exists, it is sourced at the end of the `$HOME/.bash_profile` file when it is processed.

Overriding terminal shell command

The user starts each terminal session by using the `bash` terminal shell. A terminal prompt dialog box displays, allowing the user to manually enter commands or perform clickable actions targeting the terminal session.

To specify the command to run for a terminal session, you can supply an executable shell script file in the `workshop/terminal` directory.

The name of the shell script file for a terminal session must be of the form `<session>.sh`, where `<session>` is replaced with the name of the terminal session. The session names of the default terminals configured to be displayed with the dashboard are `1`, `2`, and `3`.

The shell script file might be used to run a terminal-based application such as `k9s`, or to create an SSH session to a remote system.

```
#!/bin/bash

exec k9s
```

If the command that is run exits, the terminal session is marked as exited and you need to reload that terminal session to start over again. Alternatively, you could write the shell script file as a loop so it restarts the command you want to run if it ever exits.

```
#!/bin/bash

while true; do
    k9s
    sleep 1
done
```

If you want to run an interactive shell and output a banner at the start of the session with special information for the user, use a script file to output the banner and then run the interactive shell:

```
#!/bin/bash

echo
echo "Your session namespace is "$SESSION_NAMESPACE".
echo

exec bash
```

Add presenter slides to your Learning Center workshop

If your workshop includes a presentation, include slides by placing them in the `workshop/slides` directory. Anything in this directory is served up as static files through a HTTP web server. The default webpage must be provided as `index.html`.

Use reveal.js presentation tool

To support the use of `reveal.js`, static media assets for that package are already bundled and available at the standard URL paths that the package expects. You can drop your slide presentation using `reveal.js` into the `workshop/slides` directory and it will work with no additional setup.

If you are using `reveal.js` for the slides and you have history enabled or are using section IDs to support named links, you can use an anchor to a specific slide and that slide will be opened when clicked on:

```
%slides_url%#/questions
```

When using embedded links to the slides in workshop content, if the workshop content is displayed as part of the dashboard, the slides open in the tab to the right rather than as a separate browser window or tab.

Use a PDF file for presenter slides

For slides bundled as a PDF file, add the PDF file to `workshop/slides` and then add an `index.html` which displays the PDF `embedded` in the page.

Requirements for Learning Center in an air-gapped environment

This topic gives you the list of configurations required for Learning Center to properly function in an air-gapped environment.

Learning Center can run in an air-gapped environment but workshops do not have this capability by default. Users must therefore take the following steps to ensure Learning Center functions as expected.

Workshop yaml changes

In an air-gapped environment a user has no Internet access, so workshop yamls should be `modified` to use:

1. Private container registries.
2. Private Maven, NPM, Python, Go, or any other language repository.

For example, in NPM you can modify the `npmrc` file to use:

```
// .npmrc
registry=https://myregistry-url
```

Self-signed certificates

Air-gapped environments normally use private Certificate Authorities (CA) that may require the use of self-signed certificates. You can allow the injection of CAs by:

1. Setting the env variable `NODE_EXTRA_CA_CERTS` to the path of the file that contains one or more trusted certificates in PEM format.
2. Add the following to your workshop definition:

```
spec:
  session:
    env:
      - name: NODE_EXTRA_CA_CERTS
        value: "$my-cert-pathway"
```

Internet dependencies

If the workshop requires the installation of any Internet dependency, such as a Linux Tool or any other tool, it must be done in the workshop image. See [Build an image](#)

Define custom resources for Learning Center

This topic describes how you define custom resources for Learning Center workshops and training portals.

You can deploy workshop images directly to a container runtime. The Learning Center Operator enables managing the deployments into a Kubernetes cluster. A set of Kubernetes custom resource definitions (CRDs) controls the operation of the Learning Center Operator.



Note

The examples do not show all the possible fields of each custom resource type. Later documentation may go in-depth on possible fields and their definitions.

Workshop definition resource

The `Workshop` custom resource defines a workshop. It specifies the title and description of the workshop, the location of the workshop content or container image that you deploy, any resources that you pre-create in the workshop environment or for each instance of the workshop.

You can also define environment variables for the workshop image, the amount of CPU and memory resources for the workshop instance, any overall quota you will apply to the created namespaces and what the workshop uses.

A minimal example of the `Workshop` custom resource looks like this:

```
apiVersion: learningcenter.tanzu.vmware.com/v1beta1
kind: Workshop
metadata:
  name: lab-markdown-sample
spec:
  title: Markdown Sample
  description: A sample workshop using Markdown
  content:
    files: {YOUR-GIT-REPO-URL}/lab-markdown-sample
  session:
    namespaces:
      budget: small
    applications:
      console:
        enabled: true
```

```
editor:
  enabled: true
```

When you create an instance of the `Workshop` custom resource, the Learning Center Operator does not take any immediate action. This custom resource exists only to define the workshop.

You create the `Workshop` custom resource at the cluster scope.

Workshop environment resource

You must create a workshop environment first to deploy the instances of a workshop. The `WorkshopEnvironment` custom resource defines the configuration of the workshop environment and the details of the workshop that you deploy.

A minimal example of the `WorkshopEnvironment` custom resource looks like this:

```
apiVersion: learningcenter.tanzu.vmware.com/v1beta1
kind: WorkshopEnvironment
metadata:
  name: lab-markdown-sample
spec:
  workshop:
    name: lab-markdown-sample
  request:
    token: lab-markdown-sample
  session:
    username: learningcenter
```

When you create an instance of the `WorkshopEnvironment` custom resource, the Learning Center Operator responds by creating a namespace to host the workshop instances. The `Workshop` resource defines the workshop instance and the `spec.workshop.name` field specifies the name of the `Workshop` resource. The namespace you create uses the same name as that of the `metadata.name` field in the `WorkshopEnvironment` resource.

The `spec.request.token` field defines a token with which you must supply a request to create an instance of a workshop in this workshop environment. If necessary, you can also specify the namespaces from which a request for a workshop instance to initiate.

The `Workshop` defines a set of common resources that must exist for the workshop. Learning Center Operator creates these common resources after you created the namespace for the workshop environment. If necessary, these resources can include creation of separate namespaces with specific resources that you create in those namespaces instead.

You create the `WorkshopEnvironment` custom resource at the cluster scope.

Workshop request resource

To create an instance of the workshop under the workshop environment, the typical path is to create an instance of the `WorkshopRequest` custom resource.

The `WorkshopRequest` custom resource is namespaced to allow who can create it. Role-based access control (RBAC) controls the request to create a workshop instance. This means you can allow non-privileged users to create workshops, although the deployment of the workshop instance might require elevated privileges.

A minimal example of the `WorkshopRequest` custom resource looks like this:

```
apiVersion: learningcenter.tanzu.vmware.com/v1beta1
kind: WorkshopRequest
metadata:
  name: lab-markdown-sample
```

```
spec:
  environment:
    name: lab-markdown-sample
    token: lab-markdown-sample
```

Apart from appropriate access from RBAC, the user requesting a workshop instance must know the name of the workshop environment and the secret token that permits workshop requests against that specific workshop environment.

You do not need to create the `WorkshopRequest` resource when you use the `TrainingPortal` resource to provide a web interface for accessing workshops. You only need to create the `WorkshopRequest` resource when you create the `WorkshopEnvironment` resource manually and do not use the training portal.

Workshop session resource

Although `WorkshopRequest` is the typical way to request workshop instances, the Learning Center Operator itself creates an instance of a `WorkshopSession` custom resource when the request is granted.

The `WorkshopSession` custom resource is the expanded definition of what the workshop instance is. It combines details from `Workshop` and `WorkshopEnvironment`, and also links back to the `WorkshopRequest` resource object that triggered the request. The Learning Center Operator reacts to an instance of `WorkshopSession` and creates the workshop instance based on that definition.

You create the `WorkshopSession` custom resource at the cluster scope.

Training portal resource

The `TrainingPortal` custom resource provides a high-level mechanism for creating a set of workshop environments and populating them with workshop instances.

A minimal example of the `TrainingPortal` custom resource looks like this:

```
apiVersion: learningcenter.tanzu.vmware.com/v1beta1
kind: TrainingPortal
metadata:
  name: lab-markdown-sample
spec:
  workshops:
  - name: lab-markdown-sample
    capacity: 1
```

You can set the capacity of the training room, which dictates how many workshop instances are created for each workshop.

You create the `TrainingPortal` custom resource at the cluster scope.

System profile resource

The `SystemProfile` custom resource provides a mechanism for configuring the Learning Center Operator. This provides additional features that use environment variables to configure the operator.

A minimal example of the `SystemProfile` custom resource looks like this:

```
apiVersion: learningcenter.tanzu.vmware.com/v1beta1
kind: SystemProfile
metadata:
  name: default-system-profile
```



```
spec:
  ingress:
    domain: learningcenter.tanzu.vmware.com
    secret: learningcenter-tanzu-vmware-com-tls
    class: nginx
  environment:
    secrets:
      pull:
        - cluster-image-registry-pull
```

The operator, by default, looks for a default system profile called `default-system-profile`. Setting the `SYSTEM_PROFILE` environment variable on the deployment for the operator or using the `system.profile` setting on `TrainingPortal`, `WorkshopEnvironment`, or `WorkshopSession` custom resources for specific deployments can override the default name globally.

As only a global deployment of the operator is supported, the `SystemProfile` custom resource is created at cluster scope.

You can make changes to instances of the `SystemProfile` custom resource. The Learning Center Operator uses these changes without needing to redeploy the custom resource.

You create the `SystemProfile` custom resource at the cluster scope.

Loading the workshop CRDs

The custom resource definitions for the custom resource described earlier are created in the Kubernetes cluster when you deploy the Learning Center operator by using the Tanzu CLI.

This is because `v1` versions of CRDs are only supported from Kubernetes `v1.17`. If you want to use the `v1` versions of the CRDs, you must create a copy of the Learning Center operator deployment resources and override the configuration.

Define custom resources for Learning Center

This topic describes how you define custom resources for Learning Center workshops and training portals.

You can deploy workshop images directly to a container runtime. The Learning Center Operator enables managing the deployments into a Kubernetes cluster. A set of Kubernetes custom resource definitions (CRDs) controls the operation of the Learning Center Operator.



Note

The examples do not show all the possible fields of each custom resource type. Later documentation may go in-depth on possible fields and their definitions.

Workshop definition resource

The `Workshop` custom resource defines a workshop. It specifies the title and description of the workshop, the location of the workshop content or container image that you deploy, any resources that you pre-create in the workshop environment or for each instance of the workshop.

You can also define environment variables for the workshop image, the amount of CPU and memory resources for the workshop instance, any overall quota you will apply to the created namespaces and what the workshop uses.

A minimal example of the `Workshop` custom resource looks like this:

```

apiVersion: learningcenter.tanzu.vmware.com/v1beta1
kind: Workshop
metadata:
  name: lab-markdown-sample
spec:
  title: Markdown Sample
  description: A sample workshop using Markdown
  content:
    files: {YOUR-GIT-REPO-URL}/lab-markdown-sample
  session:
    namespaces:
      budget: small
    applications:
      console:
        enabled: true
      editor:
        enabled: true

```

When you create an instance of the `Workshop` custom resource, the Learning Center Operator does not take any immediate action. This custom resource exists only to define the workshop.

You create the `Workshop` custom resource at the cluster scope.

Workshop environment resource

You must create a workshop environment first to deploy the instances of a workshop. The `WorkshopEnvironment` custom resource defines the configuration of the workshop environment and the details of the workshop that you deploy.

A minimal example of the `WorkshopEnvironment` custom resource looks like this:

```

apiVersion: learningcenter.tanzu.vmware.com/v1beta1
kind: WorkshopEnvironment
metadata:
  name: lab-markdown-sample
spec:
  workshop:
    name: lab-markdown-sample
  request:
    token: lab-markdown-sample
  session:
    username: learningcenter

```

When you create an instance of the `WorkshopEnvironment` custom resource, the Learning Center Operator responds by creating a namespace to host the workshop instances. The `Workshop` resource defines the workshop instance and the `spec.workshop.name` field specifies the name of the `Workshop` resource. The namespace you create uses the same name as that of the `metadata.name` field in the `WorkshopEnvironment` resource.

The `spec.request.token` field defines a token with which you must supply a request to create an instance of a workshop in this workshop environment. If necessary, you can also specify the namespaces from which a request for a workshop instance to initiate.

The `Workshop` defines a set of common resources that must exist for the workshop. Learning Center Operator creates these common resources after you created the namespace for the workshop environment. If necessary, these resources can include creation of separate namespaces with specific resources that you create in those namespaces instead.

You create the `WorkshopEnvironment` custom resource at the cluster scope.

Workshop request resource

To create an instance of the workshop under the workshop environment, the typical path is to create an instance of the `WorkshopRequest` custom resource.

The `WorkshopRequest` custom resource is namespaced to allow who can create it. Role-based access control (RBAC) controls the request to create a workshop instance. This means you can allow non-privileged users to create workshops, although the deployment of the workshop instance might require elevated privileges.

A minimal example of the `WorkshopRequest` custom resource looks like this:

```
apiVersion: learningcenter.tanzu.vmware.com/v1beta1
kind: WorkshopRequest
metadata:
  name: lab-markdown-sample
spec:
  environment:
    name: lab-markdown-sample
    token: lab-markdown-sample
```

Apart from appropriate access from RBAC, the user requesting a workshop instance must know the name of the workshop environment and the secret token that permits workshop requests against that specific workshop environment.

You do not need to create the `WorkshopRequest` resource when you use the `TrainingPortal` resource to provide a web interface for accessing workshops. You only need to create the `WorkshopRequest` resource when you create the `WorkshopEnvironment` resource manually and do not use the training portal.

Workshop session resource

Although `WorkshopRequest` is the typical way to request workshop instances, the Learning Center Operator itself creates an instance of a `WorkshopSession` custom resource when the request is granted.

The `WorkshopSession` custom resource is the expanded definition of what the workshop instance is. It combines details from `Workshop` and `WorkshopEnvironment`, and also links back to the `WorkshopRequest` resource object that triggered the request. The Learning Center Operator reacts to an instance of `WorkshopSession` and creates the workshop instance based on that definition.

You create the `WorkshopSession` custom resource at the cluster scope.

Training portal resource

The `TrainingPortal` custom resource provides a high-level mechanism for creating a set of workshop environments and populating them with workshop instances.

A minimal example of the `TrainingPortal` custom resource looks like this:

```
apiVersion: learningcenter.tanzu.vmware.com/v1beta1
kind: TrainingPortal
metadata:
  name: lab-markdown-sample
spec:
  workshops:
    - name: lab-markdown-sample
      capacity: 1
```

You can set the capacity of the training room, which dictates how many workshop instances are created for each workshop.

You create the `TrainingPortal` custom resource at the cluster scope.

System profile resource

The `SystemProfile` custom resource provides a mechanism for configuring the Learning Center Operator. This provides additional features that use environment variables to configure the operator.

A minimal example of the `SystemProfile` custom resource looks like this:

```
apiVersion: learningcenter.tanzu.vmware.com/v1beta1
kind: SystemProfile
metadata:
  name: default-system-profile
spec:
  ingress:
    domain: learningcenter.tanzu.vmware.com
    secret: learningcenter-tanzu-vmware-com-tls
    class: nginx
  environment:
    secrets:
      pull:
        - cluster-image-registry-pull
```

The operator, by default, looks for a default system profile called `default-system-profile`. Setting the `SYSTEM_PROFILE` environment variable on the deployment for the operator or using the `system.profile` setting on `TrainingPortal`, `WorkshopEnvironment`, or `WorkshopSession` custom resources for specific deployments can override the default name globally.

As only a global deployment of the operator is supported, the `SystemProfile` custom resource is created at cluster scope.

You can make changes to instances of the `SystemProfile` custom resource. The Learning Center Operator uses these changes without needing to redeploy the custom resource.

You create the `SystemProfile` custom resource at the cluster scope.

Loading the workshop CRDs

The custom resource definitions for the custom resource described earlier are created in the Kubernetes cluster when you deploy the Learning Center operator by using the Tanzu CLI.

This is because `v1` versions of CRDs are only supported from Kubernetes v1.17. If you want to use the `v1` versions of the CRDs, you must create a copy of the Learning Center operator deployment resources and override the configuration.

Configure the Workshop resource

This topic describes how you configure the `Workshop` custom resource, which defines a Learning Center workshop.

Workshop title and description

Each workshop must have the `title` and `description` fields. If you do not supply these fields, the `Workshop` resource is rejected when you attempt to load it into the Kubernetes cluster.

```
apiVersion: learningcenter.tanzu.vmware.com/v1beta1
kind: Workshop
metadata:
  name: lab-markdown-sample
spec:
  title: Markdown Sample
```

```
description: A sample workshop using Markdown
content:
  files: {YOUR-GIT-REPO-URL}/lab-markdown-sample
```

Where:

- The `title` field has a single-line value specifying the subject of the workshop.
- The `description` field has a longer description of the workshop.

You can also supply the following optional information for the workshop:

```
apiVersion: learningcenter.tanzu.vmware.com/v1beta1
kind: Workshop
metadata:
  name: lab-markdown-sample
spec:
  title: Markdown Sample
  description: A sample workshop using Markdown
  url: YOUR-GIT-URL-FOR-LAB-MARKDOWN-SAMPLE
  difficulty: beginner
  duration: 15m
  vendor: learningcenter.tanzu.vmware.com
  authors:
  - John Smith
  tags:
  - template
  logo: data:image/png;base64,...
  content:
    files: YOUR-GIT-URL-FOR-LAB-MARKDOWN-SAMPLE
```

Where:

- The `url` field is the Git repository URL for `lab-markdown-sample`. For example, `{YOUR-GIT-REPO-URL}/lab-markdown-sample`. It must be a URL you can use to get more information about the workshop.
- The `difficulty` field indicates the target audiences of the workshop. The value can be `beginner`, `intermediate`, `advanced`, or `extreme`.
- The `duration` field gives the maximum amount of time the workshop takes to complete. This field provides informational value and does not guarantee how long a workshop instance lasts. The field format is an integer number with `s`, `m`, or `h` suffix.
- The `vendor` field must be a value that identifies the company or organization with which the authors are affiliated. This is a company or organization name or a DNS host name under the control of whoever has created the workshop.
- The `authors` field must list the people who create the workshop.
- The `tags` field must list labels identifying what the workshop is about. This is used in a searchable catalog of workshops.
- The `logo` field must be an image provided in embedded data URI format that depicts the topic of the workshop. The image must be 400 by 400 pixels. You can use it in a searchable catalog of workshops.
- The `files` field is the Git repository URL for `lab-markdown-sample`. For example, `{YOUR-GIT-REPO-URL}/lab-markdown-sample`.

When referring to a workshop definition after you load it into a Kubernetes cluster, use the value of the `name` field given in the metadata. To experiment with different variations of a workshop, copy the original workshop definition YAML file and change the value of `name`. Make your changes and load it into the Kubernetes cluster.

Downloading workshop content

You can download workshop content when you create the workshop instance. If the amount of content is moderate, the download doesn't increase startup time for the workshop instance. The alternative is to bundle the workshop content in a container image you build from the Learning Center workshop base image.

To download workshop content at the time the workshop instance starts, set the `content.files` field to the location of the workshop content:

```
apiVersion: learningcenter.tanzu.vmware.com/v1beta1
kind: Workshop
metadata:
  name: lab-markdown-sample
spec:
  title: Markdown Sample
  description: A sample workshop using Markdown
  content:
    files: {YOUR-GIT-REPO-URL}/lab-markdown-sample
```

The location is a GitHub or GitLab repository, a URL to a tarball hosted on a HTTP server, or a reference to an OCI image artifact on a registry.

For a GitHub or GitLab repository, do not prefix the location with `https://` as it uses symbolic reference and is not a URL.

The format of the reference to a GitHub or GitLab repository is similar to what you use with Kustomize when referencing remote repositories. For example:

- `github.com/organisation/project?ref=develop` or `github.com/organisation/project?ref=main`: Use the workshop content you host at the root of the GitHub repository. Use the `develop` or `main` branch. Be sure to specify the ref branch, because not specifying the branch may lead to content download errors.
- `github.com/organisation/project/subdir?ref=develop`: Use the workshop content you host at `subdir` of the GitHub repository. Use the `develop` branch.
- `gitlab.com/organisation/project`: Use the workshop content you host at the root of the GitLab repository. Use the `main` branch.
- `gitlab.com/organisation/project/subdir?ref=develop`: Use the workshop content you host at `subdir` of the GitLab repository. Use the `develop` branch.

For a URL to a tarball hosted on a HTTP server, the URL is in the following formats:

- `https://example.com/workshop.tar` - Use the workshop content from the top-level directory of the unpacked tarball.
- `https://example.com/workshop.tar.gz` - Use the workshop content from the top-level directory of the unpacked tarball.
- `https://example.com/workshop.tar?path=subdir` - Use the workshop content from the subdirectory path of the unpacked tarball.
- `https://example.com/workshop.tar.gz?path=subdir` - Use the workshop content from the subdirectory path of the unpacked tarball.

The tarball referenced by the URL is either uncompressed or compressed.

For GitHub, instead of referencing the Git repository containing the workshop content, use a URL to refer directly to the downloadable tarball for a specific version of the Git repository:

- `https://github.com/organization/project/archive/develop.tar.gz?path=project-develop`

You must reference the `.tar.gz` download and cannot use the `.zip` file. The base name of the tarball file is the branch or commit name. You must enter the `path` query string parameter where the argument is the name of the project and branch or project and commit. You must supply the path because the contents of the repository are not returned at the root of the archive.

GitLab also provides a means of downloading a package as a tarball:

- `https://gitlab.com/organization/project/-/archive/develop/project-develop.tar.gz?path=project-develop`

If the GitHub or GitLab repository is private, you can generate a personal access token providing read-only access to the repository and include the credentials in the URL:

- `https://username@token:github.com/organization/project/archive/develop.tar.gz?path=project-develop`

With this method, you supply a full URL to request a tarball of the repository and it does not refer to the repository itself. You can also reference private enterprise versions of GitHub or GitLab and the repository doesn't need to be on the public `github.com` or `gitlab.com` sites.

The last case is a reference to an OCI image artifact stored on a registry. This is not a full container image with the operating system, but an image containing only the files making up the workshop content. The URI formats for this are:

- `imgpkg+https://harbor.example.com/organisation/project:version` - Use the workshop content from the top-level directory of the unpacked OCI artifact. The registry in this case must support `https`.
- `imgpkg+https://harbor.example.com/organisation/project:version?path=subdir` - Use the workshop content from the subdirectory path of the unpacked OCI artifact you specify. The registry in this case must support `https`.
- `imgpkg+http://harbor.example.com/organisation/project:version` - Use the workshop content from the top-level directory of the unpacked OCI artifact. The registry in this case can only support `http`.
- `imgpkg+http://harbor.example.com/organisation/project:version?path=subdir` - Use the workshop content from the subdirectory path of the unpacked OCI artifact you specify. The registry in this case can only support `http`.

You can use `imgpkg://` instead of the prefix `imgpkg+https://`. The registry in this case must still support `https`.

For any of the formats, you can supply credentials as part of the URI:

- `imgpkg+https://username:password@harbor.example.com/organisation/project:version`

Access to the registry using a secure connection of `https` must have a valid certificate.

You can create the OCI image artifact by using `imgpkg` from the Carvel tool set. For example, from the top-level directory of the Git repository containing the workshop content, run:

```
imgpkg push -i harbor.example.com/organisation/project:version -f .
```

In all cases for downloading workshop content, the `workshop` subdirectory holding the actual workshop content is relocated to `/opt/workshop` so that it is not visible to a user. If you want to ignore other files so the user can not see them, you can supply a `.eduk8signore` file in your repository or tarball and list patterns for the files in it.

The contents of the `.eduk8signore` file are processed as a list of patterns and each is applied recursively to subdirectories. To ensure that a file is only ignored if it resides in the root directory, prefix it with `./`:

```

./.dockerignore
./.gitignore
./Dockerfile
./LICENSE
./README.md
./kustomization.yaml
./resources

```

Container image for the workshop

When you bundle the workshop content into a container image, the `content.image` field must specify the image reference identifying the location of the container image that you will deploy for the workshop instance:

```

apiVersion: learningcenter.tanzu.vmware.com/v1beta1
kind: Workshop
metadata:
  name: lab-markdown-sample
spec:
  title: Markdown Sample
  description: A sample workshop using Markdown
  content:
    image: {YOUR-REGISTRY-URL}/lab-markdown-sample:main

```

Even though you can download workshop content when the workshop environment starts, you might still want to override the workshop image that is used as a base. You can do this when you have a custom workshop base image that includes added language runtimes or tools that the specialized workshops require.

For example, if running a Java workshop, you can enter the `jdk11-environment` for the workshop image. The workshop content is still downloaded from GitHub:

```

apiVersion: learningcenter.tanzu.vmware.com/v1beta1
kind: Workshop
metadata:
  name: lab-spring-testing
spec:
  title: Spring Testing
  description: Playground for testing Spring development
  content:
    image: tanzu.packages.broadcom.com/learning-center/jdk11-environment:latest
    files: {YOUR-GIT-REPO-URL}/lab-spring-testing

```

If you want to use the latest version of an image, always include the `:latest` tag. This is important because the Learning Center Operator looks for version tags `:main`, `:main`, `:develop` and `:latest`. When using these tags, the Operator sets the image pull policy to `Always` to ensure that a newer version is always pulled if available. Otherwise, the image is cached on the Kubernetes nodes and only pulled when it is initially absent. Any other version tags are always assumed to be unique and are never updated. Be aware of image registries that use a content delivery network (CDN) as front end. When using these image tags, the CDN can still regard them as unique and not do pull through requests to update an image even if it uses a tag of `:latest`.

When special custom workshop base images are available as part of the Learning Center project, instead of specifying the full location for the image, including the image registry, you can specify a short name. The Learning Center Operator then fills in the rest of the details:

```

apiVersion: learningcenter.tanzu.vmware.com/v1beta1
kind: Workshop
metadata:

```



```

name: lab-spring-testing
spec:
  title: Spring Testing
  description: Playground for testing Spring development
  content:
    image: jdk11-environment:latest
    files: github.com/educ8s-tests/lab-spring-testing

```

The supported short versions of the names are:

- `base-environment:*`: A tagged version of the `base-environment` workshop image matched with the current version of the Learning Center Operator.

The `*` variants of the short names map to the most up-to-date version of the image available when the version of the Learning Center Operator was released. That version is guaranteed to work with that version of the Learning Center Operator. The `latest` version can be newer, with possible incompatibilities.

If required, you can remap the short names in the `SystemProfile` configuration of the Learning Center Operator. You can map additional short names to your own custom workshop base images for your own deployment of the Learning Center Operator, and with any of your own workshops.

Setting environment variables

To set or override environment variables for the workshop instance, you can supply the `session.env` field:

```

apiVersion: learningcenter.tanzu.vmware.com/v1beta1
kind: Workshop
metadata:
  name: lab-markdown-sample
spec:
  title: Markdown Sample
  description: A sample workshop using Markdown
  content:
    files: {YOUR-GIT-REPO-URL}/lab-markdown-sample
  session:
    env:
      - name: REPOSITORY-URL
        value: YOUR-GIT-URL-FOR-LAB-MARKDOWN-SAMPLE

```

Where:

- The `session.env` field is a list of dictionaries with the `name` and `value` fields.
- The `value` field is the Git repository for `lab-markdown-sample`. For example, `{YOUR-GIT-REPO-URL}/lab-markdown-sample`.

Values of fields in the list of resource objects can reference a number of predefined parameters.

The available parameters are:

- `session_id`: A unique ID for the workshop instance within the workshop environment.
- `session_namespace`: The namespace you create for and bind to the workshop instance. This is the namespace unique to the session. A workshop can create its own resources.
- `environment_name`: The name of the workshop environment. Its current value is the name of the namespace for the workshop environment and subject to change.
- `workshop_namespace`: The namespace for the workshop environment. This is the namespace where you create all deployments of the workshop instances. It is also the namespace where the service account that the workshop instance runs.

- `service_account`: The name of the service account that the workshop instance runs as. It has access to the namespace you create for that workshop instance.
- `ingress_domain`: The host domain under which you can create host names when creating ingress routes.
- `ingress_protocol`: The protocol (http/https) you use for ingress routes and create for workshops.

The syntax for referencing the parameters is `$(parameter_name)`.

Use the `session.env` field to override environment variables only when they are required for the workshop. To set or override an environment for a specific workshop environment, set environment variables in the `WorkshopEnvironment` custom resource for the workshop environment instead.

Overriding the memory available

By default the container the workshop environment runs in is allocated 512Mi. If the editor is enabled, a total of 1Gi is allocated.

The memory allocation is sufficient for the workshop that is mainly aimed at deploying workloads into the Kubernetes cluster. If you run workloads in the workshop environment container and need more memory, you can override the default by setting `memory` under `session.resources`:

```
apiVersion: learningcenter.tanzu.vmware.com/v1beta1
kind: Workshop
metadata:
  name: lab-markdown-sample
spec:
  title: Markdown Sample
  description: A sample workshop using Markdown
  content:
    image: {YOUR-REGISTRY-URL}/lab-markdown-sample:main
  session:
    resources:
      memory: 2Gi
```

Mounting a persistent volume

In circumstances where a workshop needs persistent storage to ensure no loss of work, you can request a persistent volume be mounted into the workshop container after the workshop environment container is stopped and restarted:

```
apiVersion: learningcenter.tanzu.vmware.com/v1beta1
kind: Workshop
metadata:
  name: lab-markdown-sample
spec:
  title: Markdown Sample
  description: A sample workshop using Markdown
  content:
    image: {YOUR-REGISTRY-URL}/lab-markdown-sample:main
  session:
    resources:
      storage: 5Gi
```

The persistent volume is mounted on top of the `/home/educ8s` directory. Because this hides any workshop content bundled with the image, an init container is automatically configured and run,

which copies the contents of the home directory to the persistent volume before the persistent volume is mounted on top of the home directory.

Resource budget for namespaces

In conjunction with each workshop instance, a namespace is created during the workshop. From the terminal of the workshop, you can deploy dashboard applications into the namespace through the Kubernetes REST API by using tools such as kubectl.

By default, this namespace has all the limit ranges and resource quotas the Kubernetes cluster can enforce. In most cases, this means there are no limits or quotas.

To control how much resources you can use when you set no limit ranges and resource quotas, or override any default limit ranges and resource quotas, you can set a resource budget for any namespace of the workshop instance in the `session.namespaces.budget` field:

```
apiVersion: learningcenter.tanzu.vmware.com/v1beta1
kind: Workshop
metadata:
  name: lab-markdown-sample
spec:
  title: Markdown Sample
  description: A sample workshop using Markdown
  content:
    image: {YOUR-REGISTRY-URL}/lab-markdown-sample:main
  session:
    namespaces:
      budget: small
```

The resource budget sizings and quotas for CPU and memory are:

| Budget | CPU | Memory |
|-----------|-------|--------|
| small | 1000m | 1Gi |
| medium | 2000m | 2Gi |
| large | 4000m | 4Gi |
| x-large | 8000m | 8Gi |
| xx-large | 8000m | 12Gi |
| xxx-large | 8000m | 16Gi |

A value of 1000m is equivalent to 1 CPU.

Separate resource quotas for CPU and memory are applied for terminating and non-terminating workloads.

Only the CPU and memory quotas are listed in the preceding table, but limits also apply to the number of resource objects of certain types you can create, such as:

- persistent volume claims
- replication controllers
- services
- secrets

For each budget type, a limit range is created with fixed defaults. The limit ranges for CPU usage on a container are as follows:

| Budget | Minimum | Maximum | Request | Limit |
|-----------|---------|---------|---------|-------|
| small | 50m | 1000m | 50m | 250m |
| medium | 50m | 2000m | 50m | 500m |
| large | 50m | 4000m | 50m | 500m |
| x-large | 50m | 8000m | 50m | 500m |
| xx-large | 50m | 8000m | 50m | 500m |
| xxx-large | 50m | 8000m | 50m | 500m |

The limit ranges for memory are as follows:

| Budget | Minimum | Maximum | Request | Limit |
|-----------|---------|---------|---------|-------|
| small | 32Mi | 1Gi | 128Mi | 256Mi |
| medium | 32Mi | 2Gi | 128Mi | 512Mi |
| large | 32Mi | 4Gi | 128Mi | 1Gi |
| x-large | 32Mi | 8Gi | 128Mi | 2Gi |
| xx-large | 32Mi | 12Gi | 128Mi | 2Gi |
| xxx-large | 32Mi | 16Gi | 128Mi | 2Gi |

The request and limit values are the defaults of a container when there is no resources specification in a pod specification.

You can supply overrides in `session.namespaces.limits` to override the limit ranges and defaults for request and limit values when a budget sizing for CPU and memory is sufficient and there is no resources specification in a pod specification:

```
apiVersion: learningcenter.tanzu.vmware.com/v1beta1
kind: Workshop
metadata:
  name: lab-markdown-sample
spec:
  title: Markdown Sample
  description: A sample workshop using Markdown
  content:
    image: {YOUR-REGISTRY-URL}/lab-markdown-sample:main
  session:
    namespaces:
      budget: medium
      limits:
        min:
          cpu: 50m
          memory: 32Mi
        max:
          cpu: 1
          memory: 1Gi
      defaultRequest:
        cpu: 50m
        memory: 128Mi
      default:
        cpu: 500m
        memory: 1Gi
```

Although all the configurable properties are listed in this example, you only need to supply the property for the value that you want to override.

If you need more control over the limit ranges and resource quotas, you can set the resource budget to `custom`. This removes any default limit ranges and resource quota that might be applied to the namespace. You can enter your own `LimitRange` and `ResourceQuota` resources as part of the list of resources created for each session.

Before disabling the quota and limit ranges or contemplating any switch to using a custom set of `LimitRange` and `ResourceQuota` resources, consider if that is what is really required.

The default requests defined by these for memory and CPU are fallbacks only. In most cases, instead of changing the defaults, you can enter the memory and CPU resources in the pod template specification of your deployment resources used in the workshop to indicate what the application requires. This allows you to control exactly what the application can use and so fit into the minimum quota required for the task.

This budget setting and the memory values are distinct from the amount of memory the container the workshop environment runs in. To change how much memory is available to the workshop container, set the `memory` setting under `session.resources`.

Patching workshop deployment

In order to set or override environment variables, you can provide `session.env`. To make other changes to the Pod template for the deployment used to create the workshop instance, provide an overlay patch. You can use this patch to override the default CPU and memory limit applied to the workshop instance or to mount a volume.

The patches are provided by setting `session.patches`. The patch is applied to the `spec` field of the pod template:

```
apiVersion: learningcenter.tanzu.vmware.com/v1beta1
kind: Workshop
metadata:
  name: lab-resource-testing
spec:
  title: Resource testing
  description: Play area for testing memory resources
  content:
    files: github.com/educ8s-tests/lab-resource-testing
  session:
    patches:
      containers:
        - name: workshop
          resources:
            requests:
              memory: "1Gi"
            limits:
              memory: "1Gi"
```

In this example, the default memory limit of “512Mi” is increased to “1Gi”. Although memory is set using a patch in this example, the `session.resources.memory` field is the preferred way to override the memory allocated to the container the workshop environment is running in.

The patch works differently than overlay patches that you can find elsewhere in Kubernetes. Specifically, when patching an array and the array contains a list of objects, a search is performed on the destination array. If an object already exists with the same value for the `name` field, the item in the source array is overlaid on top of the existing item in the destination array.

If there is no matching item in the destination array, the item in the source array is added to the end of the destination array.

This means an array doesn’t outright replace an existing array, but a more intelligent merge is performed of elements in the array.

Creation of session resources

When a workshop instance is created, the deployment running the workshop dashboard is created in the namespace for the workshop environment. When more than one workshop instance is created under that workshop environment, all those deployments are in the same namespace.

For each workshop instance, a separate empty namespace is created with name corresponding to the workshop session. The workshop instance is configured so that the service account that the workshop instance runs under can access and create resources in the namespace created for that workshop instance. Each separate workshop instance has its own corresponding namespace and cannot see the namespace for another instance.

To pre-create additional resources within the namespace for a workshop instance, you can supply a list of the resources against the `session.objects` field within the workshop definition. You might use this to add additional custom roles to the service account for the workshop instance when working in that namespace or to deploy a distinct instance of an application for just that workshop instance, such as a private image registry:

```
apiVersion: learningcenter.tanzu.vmware.com/v1beta1
kind: Workshop
metadata:
  name: lab-registry-testing
spec:
  title: Registry Testing
  description: Play area for testing image registry
  content:
    files: github.com/educ8s-tests/lab-registry-testing
  session:
    objects:
      - apiVersion: apps/v1
        kind: Deployment
        metadata:
          name: registry
        spec:
          replicas: 1
          selector:
            matchLabels:
              deployment: registry
          strategy:
            type: Recreate
          template:
            metadata:
              labels:
                deployment: registry
            spec:
              containers:
                - name: registry
                  image: registry.hub.docker.com/library/registry:2.6.1
                  imagePullPolicy: IfNotPresent
                  ports:
                    - containerPort: 5000
                      protocol: TCP
                  env:
                    - name: REGISTRY_STORAGE_DELETE_ENABLED
                      value: "true"
      - apiVersion: v1
        kind: Service
        metadata:
          name: registry
        spec:
          type: ClusterIP
          ports:
            - port: 80
```

```
targetPort: 5000
selector:
  deployment: registry
```

For namespaced resources, it is not necessary to enter the `namespace` field of the resource `metadata`. When the `namespace` field is not present, the resource is created within the session namespace for that workshop instance.

When resources are created, owner references are added, making the `WorkshopSession` custom resource corresponding to the workshop instance the owner. This means that when the workshop instance is deleted, any resources are deleted.

Values of fields in the list of resource objects can reference a number of predefined parameters. The available parameters are:

- `session_id`: A unique ID for the workshop instance within the workshop environment.
- `session_namespace`: The namespace you create for and bound to the workshop instance. This is the namespace unique to the session and where a workshop can create its own resources.
- `environment_name`: The name of the workshop environment. Its current value is the name of the namespace for the workshop environment and subject to change.
- `workshop_namespace`: The namespace for the workshop environment. This is the namespace where you create all deployments of the workshop instances. It is also the namespace where the service account that the workshop instance runs.
- `service_account`: The name of the service account the workshop instance runs as and which has access to the namespace you create for that workshop instance.
- `ingress_domain`: The host domain under which you can create host names when creating ingress routes.
- `ingress_protocol`: The protocol (http/https) you use for ingress routes and create for workshops.

The syntax for referencing the parameter is `$(parameter_name)`.

For cluster-scoped resources, you must set the name of the created resource so that it embeds the value of `$(session_namespace)`. This way the resource name is unique to the workshop instance, and you do not get a clash with a resource for a different workshop instance.

For examples of making use of the available parameters, see the following sections.

Overriding default role-based access control (RBAC) rules

By default the service account created for the workshop instance has `admin` role access to the session namespace created for that workshop instance. This enables the service account to be used to deploy applications to the session namespace and manage secrets and service accounts.

Where a workshop doesn't require `admin` access for the namespace, you can reduce the level of access it has to `edit` or `view` by setting the `session.namespaces.role` field:

```
apiVersion: learningcenter.tanzu.vmware.com/v1beta1
kind: Workshop
metadata:
  name: lab-role-testing
spec:
  title: Role Testing
  description: Play area for testing roles
  content:
    files: github.com/educ8s-tests/lab-role-testing
```

```

session:
  namespaces:
    role: view

```

To add additional roles to the service account, such as working with custom resource types added to the cluster, you can add the appropriate `Role` and `RoleBinding` definitions to the `session.objects` field described previously:

```

apiVersion: learningcenter.tanzu.vmware.com/v1beta1
kind: Workshop
metadata:
  name: lab-kpack-testing
spec:
  title: Kpack Testing
  description: Play area for testing kpack
  content:
    files: github.com/educ8s-tests/lab-kpack-testing
  session:
    objects:
      - apiVersion: rbac.authorization.k8s.io/v1
        kind: Role
        metadata:
          name: kpack-user
        rules:
          - apiGroups:
              - kpack.io
            resources:
              - builds
              - builders
              - images
              - sourceresolvers
            verbs:
              - get
              - list
              - watch
              - create
              - delete
              - patch
              - update
      - apiVersion: rbac.authorization.k8s.io/v1
        kind: RoleBinding
        metadata:
          name: kpack-user
        roleRef:
          apiGroup: rbac.authorization.k8s.io
          kind: Role
          name: kpack-user
        subjects:
          - kind: ServiceAccount
            namespace: $(workshop_namespace)
            name: $(service_account)

```

Because the subject of a `RoleBinding` must specify the service account name and namespace it is contained within, both of which are unknown in advance, references to parameters for the workshop namespace and service account for the workshop instance are used when defining the subject.

You can add additional resources with `session.objects` to grant cluster-level roles and the service account `cluster-admin` role:

```

apiVersion: learningcenter.tanzu.vmware.com/v1beta1
kind: Workshop
metadata:
  name: lab-admin-testing

```



```
spec:
  title: Admin Testing
  description: Play area for testing cluster admin
  content:
    files: github.com/educ8s-tests/lab-admin-testing
  session:
    objects:
      - apiVersion: rbac.authorization.k8s.io/v1
        kind: ClusterRoleBinding
        metadata:
          name: $(session_namespace)-cluster-admin
        roleRef:
          apiGroup: rbac.authorization.k8s.io
          kind: ClusterRole
          name: cluster-admin
        subjects:
          - kind: ServiceAccount
            namespace: $(workshop_namespace)
            name: $(service_account)
```

In this case, the name of the cluster role binding resource embeds `$(session_namespace)` so that its name is unique to the workshop instance and doesn't overlap with a binding for a different workshop instance.

Running user containers as root

In addition to RBAC, which controls what resources a user can create and work with, Pod security policies are applied to restrict what Pods/containers a user deploys can do.

By default the deployments that a workshop user can create are allowed only to run containers as a non-root user. This means that many container images available on registries such as Docker Hub cannot be used.

If you are creating a workshop where a user must run containers as the root user, you must override the default `nonroot` security policy and select the `anyuid` security policy by using the `session.namespaces.security.policy` setting:

```
apiVersion: learningcenter.tanzu.vmware.com/v1beta1
kind: Workshop
metadata:
  name: lab-policy-testing
spec:
  title: Policy Testing
  description: Play area for testing security policies
  content:
    files: github.com/educ8s-tests/lab-policy-testing
  session:
    namespaces:
      security:
        policy: anyuid
```

This setting applies to the primary session namespace and any secondary namespaces created.

Creating additional namespaces

For each workshop instance, a primary session namespace is created. You can deploy or pre-deploy applications into this namespace as part of the workshop.

If you need more than one namespace per workshop instance, you can create secondary namespaces in a couple of ways.

If the secondary namespaces are to be created empty, you can list the details of the namespaces under the property `session.namespaces.secondary`:

```
apiVersion: learningcenter.tanzu.vmware.com/v1beta1
kind: Workshop
metadata:
  name: lab-namespace-testing
spec:
  title: Namespace Testing
  description: Play area for testing namespaces
  content:
    files: github.com/educ8s-tests/lab-namespace-testing
  session:
    namespaces:
      role: admin
      budget: medium
      secondary:
        - name: $(session_namespace)-apps
          role: edit
          budget: large
          limits:
            default:
              memory: 512mi
```

When secondary namespaces are created, by default, the role, resource quotas, and limit ranges are set the same as the primary session namespace. Each namespace has a separate resource budget and it is not shared.

If required, you can override what `role`, `budget`, and `limits` are applied within the entry for the namespace.

Similarly, you can override the security policy for secondary namespaces on a case-by-case basis by adding the `security.policy` setting under the entry for the secondary namespace.

To create resources in the namespaces you create, create the namespaces by adding an appropriate `Namespace` resource to `session.objects` with the definitions of the resources you want to create in the namespaces:

```
apiVersion: learningcenter.tanzu.vmware.com/v1beta1
kind: Workshop
metadata:
  name: lab-namespace-testing
spec:
  title: Namespace Testing
  description: Play area for testing namespaces
  content:
    files: github.com/educ8s-tests/lab-namespace-testing
  session:
    objects:
      - apiVersion: v1
        kind: Namespace
        metadata:
          name: $(session_namespace)-apps
```

When listing any other resources to be created within the added namespace, such as deployments, ensure that the `namespace` is set in the `metadata` of the resource. For example, `$(session_namespace)-apps`.

To override what role the service account for the workshop instance has in the added namespace, you can set the `learningcenter.tanzu.vmware.com/session.role` annotation on the `Namespace` resource:

```

apiVersion: learningcenter.tanzu.vmware.com/v1beta1
kind: Workshop
metadata:
  name: lab-namespace-testing
spec:
  title: Namespace Testing
  description: Play area for testing namespaces
  content:
    files: github.com/educ8s-tests/lab-namespace-testing
  session:
    objects:
      - apiVersion: v1
        kind: Namespace
        metadata:
          name: $(session_namespace)-apps
          annotations:
            learningcenter.tanzu.vmware.com/session.role: view

```

To have a different resource budget set for the additional namespace, you can add the annotation `learningcenter.tanzu.vmware.com/session.budget` in the `Namespace` resource metadata and set the value to the required resource budget:

```

apiVersion: learningcenter.tanzu.vmware.com/v1beta1
kind: Workshop
metadata:
  name: lab-namespace-testing
spec:
  title: Namespace Testing
  description: Play area for testing namespaces
  content:
    files: github.com/educ8s-tests/lab-namespace-testing
  session:
    objects:
      - apiVersion: v1
        kind: Namespace
        metadata:
          name: $(session_namespace)-apps
          annotations:
            learningcenter.tanzu.vmware.com/session.budget: large

```

To override the limit range values applied corresponding to the budget applied, you can add annotations starting with `learningcenter.tanzu.vmware.com/session.limits`. for each entry:

```

apiVersion: learningcenter.tanzu.vmware.com/v1beta1
kind: Workshop
metadata:
  name: lab-namespace-testing
spec:
  title: Namespace Testing
  description: Play area for testing namespaces
  content:
    files: github.com/educ8s-tests/lab-namespace-testing
  session:
    objects:
      - apiVersion: v1
        kind: Namespace
        metadata:
          name: $(session_namespace)-apps
          annotations:
            learningcenter.tanzu.vmware.com/session.limits.min.cpu: 50m
            learningcenter.tanzu.vmware.com/session.limits.min.memory: 32Mi
            learningcenter.tanzu.vmware.com/session.limits.max.cpu: 1
            learningcenter.tanzu.vmware.com/session.limits.max.memory: 1Gi
            learningcenter.tanzu.vmware.com/session.limits.defaultrequest.cpu: 50m

```

```
learningcenter.tanzu.vmware.com/session.limits.defaultrequest.memory: 128Mi
learningcenter.tanzu.vmware.com/session.limits.request.cpu: 500m
learningcenter.tanzu.vmware.com/session.limits.request.memory: 1Gi
```

You only must supply annotations for the values you want to override.

If you need more fine-grained control over the limit ranges and resource quotas, set the value of the annotation for the budget to `custom` and add the `LimitRange` and `ResourceQuota` definitions to `session.objects`.

In this case you must set the `namespace` for the `LimitRange` and `ResourceQuota` resource to the name of the namespace, e.g., `$(session_namespace)-apps` so they are only applied to that namespace.

To set the security policy for a specific namespace other than the primary session namespace, you can add the annotation `learningcenter.tanzu.vmware.com/session.security.policy` in the `Namespace` resource metadata and set the value to `nonroot`, `anyuid`, or `custom` as necessary.

Shared workshop resources

Adding a list of resources to `session.objects` causes the given resources to be created for each workshop instance, whereas namespaced resources default to being created in the session namespace for a workshop instance.

If instead you want to have one common shared set of resources created once for the whole workshop environment, that is, used by all workshop instances, you can list them in the `environment.objects` field.

This might, for example, be used to deploy a single container image registry used by all workshop instances, with a Kubernetes job used to import a set of images into the container image registry, which are then referenced by the workshop instances.

For namespaced resources, it is not necessary to enter the `namespace` field of the resource `metadata`. When the `namespace` field is not present, the resource is created within the workshop namespace for that workshop environment.

When resources are created, owner references are added, making the `WorkshopEnvironment` custom resource correspond to the workshop environment of the owner. This means that when the workshop environment is deleted, any resources are also deleted.

Values of fields in the list of resource objects can reference a number of predefined parameters. The available parameters are:

- `workshop_name`: The name of the workshop. This is the name of the `Workshop` definition the workshop environment was created against.
- `environment_name`: The name of the workshop environment. Its current value is the name of the namespace for the workshop environment and subject to change.
- `environment_token`: The value of the token that must be used in workshop requests against the workshop environment.
- `workshop_namespace`: The namespace for the workshop environment. This is the namespace where all deployments of the workshop instances, and their service accounts, are created. It is the same namespace that shared workshop resources are created.
- `service_account`: The name of a service account you can use when creating deployments in the workshop namespace.
- `ingress_domain`: The host domain under which you can create host names when creating ingress routes.
- `ingress_protocol`: The protocol (http/https) used for ingress routes created for workshops.

- `ingress_secret`: The name of the ingress secret stored in the workshop namespace when secure ingress is used.

To create additional namespaces associated with the workshop environment, embed a reference to `$(workshop_namespace)` in the name of the additional namespaces with an appropriate suffix. Be careful that the suffix doesn't overlap with the range of session IDs for workshop instances.

When creating deployments in the workshop namespace, set the `serviceAccountName` of the `Deployment` resource to `$(service_account)`. This ensures the deployment makes use of a special Pod security policy set up by the Learning Center. If this isn't used and the cluster imposes a more strict default Pod security policy, your deployment might not work, especially if any image runs as `root`.

Workshop pod security policy

The pod for the workshop session is set up with a pod security policy that restricts what you can do from containers in the pod. The nature of the applied pod security policy is adjusted when enabling support for doing Docker builds. This in turn enables Docker builds inside the sidecar container attached to the workshop container.

If you are customizing the workshop by patching the pod specification using `session.patches` to add your own sidecar container, and that sidecar container must run as the root user or needs a custom pod security policy, you must override the default security policy for the workshop container.

To allow a sidecar container to run as the root user with no extra privileges required, you can override the default `nonroot` security policy and set it to `anyuid`:

```
apiVersion: learningcenter.tanzu.vmware.com/v1beta1
kind: Workshop
metadata:
  name: lab-policy-testing
spec:
  title: Policy Testing
  description: Play area for testing security policies
  content:
    files: github.com/educ8s-tests/lab-policy-testing
  session:
    security:
      policy: anyuid
```

This is a different setting than described previously for changing the security policy for deployments made by a workshop user to the session namespaces. This setting applies only to the workshop container itself.

If you need more fine-grained control of the security policy, you must provide your own resources for defining the Pod security policy and map it so it is used. The details of the pod security policy must be in `environment.objects` and mapped by definitions added to `session.objects`. For this to be used, you must deactivate the application of the inbuilt pod security policies. You can do this by setting `session.security.policy` to `custom`:

```
apiVersion: learningcenter.tanzu.vmware.com/v1beta1
kind: Workshop
metadata:
  name: lab-policy-testing
spec:
  title: Policy Testing
  description: Play area for testing policy override
  content:
    files: github.com/educ8s-tests/lab-policy-testing
```

```

session:
  security:
    policy: custom
  objects:
  - apiVersion: rbac.authorization.k8s.io/v1
    kind: RoleBinding
    metadata:
      namespace: $(workshop_namespace)
      name: $(session_namespace)-podman
    roleRef:
      apiGroup: rbac.authorization.k8s.io
      kind: ClusterRole
      name: $(workshop_namespace)-podman
    subjects:
    - kind: ServiceAccount
      namespace: $(workshop_namespace)
      name: $(service_account)
environment:
  objects:
  - apiVersion: policy/v1beta1
    kind: PodSecurityPolicy
    metadata:
      name: aa-$(workshop_namespace)-podman
    spec:
      privileged: true
      allowPrivilegeEscalation: true
      requiredDropCapabilities:
      - KILL
      - MKNOD
      hostIPC: false
      hostNetwork: false
      hostPID: false
      hostPorts: []
      runAsUser:
        rule: MustRunAsNonRoot
      seLinux:
        rule: RunAsAny
      fsGroup:
        rule: RunAsAny
      supplementalGroups:
        rule: RunAsAny
      volumes:
      - configMap
      - downwardAPI
      - emptyDir
      - persistentVolumeClaim
      - projected
      - secret
  - apiVersion: rbac.authorization.k8s.io/v1
    kind: ClusterRole
    metadata:
      name: $(workshop_namespace)-podman
    rules:
    - apiGroups:
      - policy
      resources:
      - podsecuritypolicies
      verbs:
      - use
      resourceNames:
      - aa-$(workshop_namespace)-podman

```

By overriding the pod security policy, you are responsible for limiting what you can do from the workshop pod. In other words, add only the extra capabilities you need. The pod security policy is applied only to the pod the workshop session runs in. It does not change any pod security policy

applied to service accounts that exist in the session namespace or other namespaces you have created.

There is a better way to set the priority of applied Pod security policies when a default Pod security policy is applied globally by mapping it to the `system:authenticated` group. This causes priority falling back to the order of the names of the Pod security policies. VMware recommends you use `aa-` as a prefix to the custom Pod security name you create. This ensures it takes precedence over any global default Pod security policy such as `restricted`, `pks-restricted` or `vmware-system-tmc-restricted`, no matter what the name of the global policy default.

Custom security policies for user containers

You can also set the value of the `session.namespaces.security.policy` setting as `custom`. This gives you more fine-grained control of the security policy applied to the pods and containers that a user deploys during a session. In this case you must provide your own resources that define and map the pod security policy.

For example:

```
apiVersion: learningcenter.tanzu.vmware.com/v1beta1
kind: Workshop
metadata:
  name: lab-policy-testing
spec:
  title: Policy Testing
  description: Play area for testing policy override
  content:
    files: github.com/educ8s-tests/lab-policy-testing
  session:
    namespaces:
      security:
        policy: custom
    objects:
      - apiVersion: rbac.authorization.k8s.io/v1
        kind: RoleBinding
        metadata:
          namespace: $(workshop_namespace)
          name: $(session_namespace)-security-policy
        roleRef:
          apiGroup: rbac.authorization.k8s.io
          kind: ClusterRole
          name: $(workshop_namespace)-security-policy
        subjects:
          - kind: Group
            namespace: $(workshop_namespace)
            name: system:serviceaccounts:$(workshop_namespace)
  environment:
    objects:
      - apiVersion: policy/v1beta1
        kind: PodSecurityPolicy
        metadata:
          name: aa-$(workshop_namespace)-security-policy
        spec:
          privileged: true
          allowPrivilegeEscalation: true
          requiredDropCapabilities:
            - KILL
            - MKNOD
          hostIPC: false
          hostNetwork: false
          hostPID: false
          hostPorts: []
          runAsUser:
```

```

    rule: MustRunAsNonRoot
  seLinux:
    rule: RunAsAny
  fsGroup:
    rule: RunAsAny
  supplementalGroups:
    rule: RunAsAny
  volumes:
  - configMap
  - downwardAPI
  - emptyDir
  - persistentVolumeClaim
  - projected
  - secret
- apiVersion: rbac.authorization.k8s.io/v1
  kind: ClusterRole
  metadata:
    name: $(workshop_namespace)-security-policy
  rules:
- apiGroups:
  - policy
  resources:
  - podsecuritypolicies
  verbs:
  - use
  resourceNames:
  - aa-$(workshop_namespace)-security-policy

```

You can also do this on secondary namespaces by either changing the `session.namespaces.secondary.security.policy` setting to `custom` or using the learningcenter.tanzu.vmware.com/session.security.policy: custom annotation.

Defining additional ingress points

If running additional background applications, by default they are only accessible to other processes within the same container. For an application to be accessible to a user through their web browser, an ingress must be created mapping to the port for the application.

You can do this by supplying a list of the ingress points and the internal container port they map to by setting the `session.ingresses` field in the workshop definition:

```

apiVersion: learningcenter.tanzu.vmware.com/v1beta1
kind: Workshop
metadata:
  name: lab-application-testing
spec:
  title: Application Testing
  description: Play area for testing my application
  content:
    image: {YOUR-REGISTRY-URL}/lab-application-testing:main
  session:
    ingresses:
    - name: application
      port: 8080

```

The form of the host name used in the URL to access the service is:

```
$(session_namespace)-application.$(ingress_domain)
```

This name cannot be `terminal`, `console`, `slides`, `editor`, or the name of any built-in dashboard. These values are reserved for the corresponding built-in capabilities providing those features.

In addition to specifying ingresses for proxying to internal ports within the same Pod, you can enter a `host`, `protocol` and `port` corresponding to a separate service running in the Kubernetes cluster:

```
apiVersion: learningcenter.tanzu.vmware.com/v1beta1
kind: Workshop
metadata:
  name: lab-application-testing
spec:
  title: Application Testing
  description: Play area for testing my application
  content:
    image: {YOUR-REGISTRY-URL}/lab-application-testing:main
  session:
    ingresses:
      - name: application
        protocol: http
        host: service.namespace.svc.cluster.local
        port: 8080
```

You can use variables providing information about the current session within the `host` property if required:

```
apiVersion: learningcenter.tanzu.vmware.com/v1beta1
kind: Workshop
metadata:
  name: lab-application-testing
spec:
  title: Application Testing
  description: Play area for testing my application
  content:
    image: {YOUR-REGISTRY-URL}/lab-application-testing:main
  session:
    ingresses:
      - name: application
        protocol: http
        host: service.${session_namespace}.svc.cluster.local
        port: 8080
```

Available variables are:

- `session_namespace`: The namespace you create for and bind to the workshop instance. This is the namespace unique to the session and where a workshop can create its own resources.
- `environment_name`: The name of the workshop environment. Its current value is the name of the namespace for the workshop environment and subject to change.
- `workshop_namespace`: The namespace for the workshop environment. This is the namespace where you create all deployments of the workshop instances and where the service account that the workshop instance runs.
- `ingress_domain`: The host domain under which you can create host names when creating ingress routes.

If the service uses standard `http` or `https` ports, you can leave out the `port` property, and the port is set based on the value of `protocol`.

When a request is proxied, you can specify additional request headers that must be passed to the service:

```
apiVersion: learningcenter.tanzu.vmware.com/v1beta1
kind: Workshop
metadata:
  name: lab-application-testing
```

```
spec:
  title: Application Testing
  description: Play area for testing my application
  content:
    image: {YOUR-REGISTRY-URL}/lab-application-testing:main
  session:
    ingresses:
      - name: application
        protocol: http
        host: service.${session_namespace}.svc.cluster.local
        port: 8080
        headers:
          - name: Authorization
            value: "Bearer ${kubernetes_token}"
```

The value of a header can reference the following variable:

- `kubernetes_token`: The access token of the service account for the current workshop session, used for accessing the Kubernetes REST API.

Access controls enforced by the workshop environment or training portal protect accessing any service through the ingress. If you use the training portal, this must be transparent. Otherwise, supply any login credentials for the workshop again when prompted by your web browser.

External workshop instructions

In place of using workshop instructions provided with the workshop content, you can use externally hosted instructions instead. To do this set `sessions.applications.workshop.url` to the URL of an external web site:

```
apiVersion: learningcenter.tanzu.vmware.com/v1beta1
kind: Workshop
metadata:
  name: lab-application-testing
spec:
  title: Application Testing
  description: Play area for testing my application
  content:
    image: {YOUR-REGISTRY-URL}/lab-application-testing:main
  session:
    applications:
      workshop:
        url: https://www.example.com/instructions
```

The external web site must be displayed in an HTML iframe, is shown as is and must provide its own page navigation and table of contents if required.

The URL value can reference a number of predefined parameters. The available parameters are:

- `session_namespace`: The namespace you create for and bind to the workshop instance. This is the namespace unique to the session and where a workshop can create its own resources.
- `environment_name`: The name of the workshop environment. Its current value is the name of the namespace for the workshop environment and subject to change.
- `workshop_namespace`: The namespace for the workshop environment. This is the namespace where you create all deployments of the workshop instances and where the service account that the workshop instance runs.
- `ingress_domain`: The host domain under which you can create host names when creating ingress routes.

- `ingress_protocol`: The protocol (http/https) used for ingress routes that you create for workshops.

These could be used, for example, to reference workshops instructions hosted as part of the workshop environment:

```
apiVersion: learningcenter.tanzu.vmware.com/v1beta1
kind: Workshop
metadata:
  name: lab-application-testing
spec:
  title: Application Testing
  description: Play area for testing my application
  content:
    image: {YOUR-REGISTRY-URL}/lab-application-testing:main
  session:
    applications:
      workshop:
        url: $(ingress_protocol)://$(workshop_namespace)-instructions.$(ingress_domain)
  environment:
    objects:
      - ...
```

In this case `environment.objects` of the workshop `spec` must include resources to deploy the application hosting the instructions and expose it through an appropriate ingress.

Deactivating workshop instructions

The aim of the workshop environment is to provide instructions for a workshop that users can follow. If you want instead to use the workshop environment as a development environment or as an administration console that provides access to a Kubernetes cluster, you can deactivate the display of workshop instructions provided with the workshop content. In this case, only the work area with the terminals, console, and so on, is displayed. To deactivate display of workshop instructions, add a `session.applications.workshop` section and set the `enabled` property to `false`:

```
apiVersion: learningcenter.tanzu.vmware.com/v1beta1
kind: Workshop
metadata:
  name: lab-application-testing
spec:
  title: Application Testing
  description: Play area for testing my application
  content:
    image: {YOUR-REGISTRY-URL}/lab-application-testing:main
  session:
    applications:
      workshop:
        enabled: false
```

Enabling the Kubernetes console

By default the Kubernetes console is not enabled. To enable it and make it available through the web browser when accessing a workshop, add a `session.applications.console` section to the workshop definition, and set the `enabled` property to `true`:

```
apiVersion: learningcenter.tanzu.vmware.com/v1beta1
kind: Workshop
metadata:
  name: lab-application-testing
```

```
spec:
  title: Application Testing
  description: Play area for testing my application
  content:
    image: {YOUR-REGISTRY-URL}/lab-application-testing:main
  session:
    applications:
      console:
        enabled: true
```

The Kubernetes dashboard provided by the Kubernetes project is used. To use Octant as the console, you can set the `vendor` property to `octant`:

```
apiVersion: learningcenter.tanzu.vmware.com/v1beta1
kind: Workshop
metadata:
  name: lab-application-testing
spec:
  title: Application Testing
  description: Play area for testing my application
  content:
    image: {YOUR-REGISTRY-URL}/lab-application-testing:main
  session:
    applications:
      console:
        enabled: true
        vendor: octant
```

When `vendor` is not set, `kubernetes` is assumed.

Enabling the integrated editor

By default the integrated web based editor is not enabled. To enable it and make it available through the web browser when accessing a workshop, add a `session.applications.editor` section to the workshop definition, and set the `enabled` property to `true`:

```
apiVersion: learningcenter.tanzu.vmware.com/v1beta1
kind: Workshop
metadata:
  name: lab-application-testing
spec:
  title: Application Testing
  description: Play area for testing my application
  content:
    image: {YOUR-REGISTRY-URL}/lab-application-testing:main
  session:
    applications:
      editor:
        enabled: true
```

The integrated editor used is based on Visual Studio Code. For more information about the editor, see <https://github.com/cdr/code-server> in GitHub.

To install additional VS Code extensions, do this from the editor. Alternatively, if building a custom workshop, you can install them from your `Dockerfile` into your workshop image by running:

```
code-server --install-extension vendor.extension
```

Replace `vendor.extension` with the name of the extension, where the name identifies the extension on the VS Code extensions marketplace used by the editor or provide a path name to a local `.vsix` file.

This installs the extensions into `$HOME/.config/code-server/extensions`.

If downloading extensions yourself and unpacking them or extensions are part of your Git repository, you can instead locate them in the `workshop/code-server/extensions` directory.

Enabling workshop downloads

You can provide a way for a workshop user to download files as part of the workshop content. Enable this by adding the `session.applications.files` section to the workshop definition and setting the `enabled` property to `true`:

```
apiVersion: learningcenter.tanzu.vmware.com/v1beta1
kind: Workshop
metadata:
  name: lab-application-testing
spec:
  title: Application Testing
  description: Play area for testing my application
  content:
    image: {YOUR-REGISTRY-URL}/lab-application-testing:main
  session:
    applications:
      files:
        enabled: true
```

The recommended way of providing access to files from workshop instructions is using the `files:download-file` clickable action block. This action ensures any file is downloaded to the local machine and is not displayed in the browser in place of the workshop instructions.

By default the user can access any files located under the home directory of the workshop user account. To restrict where the user can download files from, set the `directory` setting:

```
apiVersion: learningcenter.tanzu.vmware.com/v1beta1
kind: Workshop
metadata:
  name: lab-application-testing
spec:
  title: Application Testing
  description: Play area for testing my application
  content:
    image: {YOUR-REGISTRY-URL}/lab-application-testing:main
  session:
    applications:
      files:
        enabled: true
        directory: exercises
```

When the specified directory is a relative path, it is evaluated relative to the home directory of the workshop user.

Enabling the test examiner

The test examiner is a feature that allows a workshop to have verification checks that the workshop instructions can trigger. The test examiner is deactivated by default. To enable it, add a `session.applications.examiner` section to the workshop definition and set the `enabled` property to `true`:

```
apiVersion: learningcenter.tanzu.vmware.com/v1beta1
kind: Workshop
metadata:
  name: lab-application-testing
```

```
spec:
  title: Application Testing
  description: Play area for testing my application
  content:
    image: {YOUR-REGISTRY-URL}/lab-application-testing:main
  session:
    applications:
      examiner:
        enabled: true
```

You must provide any executable test programs for verification checks in the `workshop/examiner/tests` directory.

The test programs must return an exit status of 0 if the test is successful and nonzero if it fails. Test programs must not be persistent programs that can run forever.

Clickable actions for the test examiner are used within the workshop instructions to trigger the verification checks. You can configure them to start when the page of the workshop instructions is loaded.

Enabling session image registry

Workshops using tools such as `kpack` or `tekton` and which need a place to push container images when built can enable a container image registry. A separate registry is deployed for each workshop session.

The container image registry is currently fully usable only if workshops are deployed under a Learning Center Operator configuration that uses secure ingress. This is because a registry that is not secure is not trusted by the Kubernetes cluster as the source of container images when doing deployments.

To enable the deployment of a registry per workshop session, add a `session.applications.registry` section to the workshop definition and set the `enabled` property to `true`:

```
apiVersion: learningcenter.tanzu.vmware.com/v1beta1
kind: Workshop
metadata:
  name: lab-application-testing
spec:
  title: Application Testing
  description: Play area for testing my application
  content:
    image: {YOUR-REGISTRY-URL}/lab-application-testing:main
  session:
    applications:
      registry:
        enabled: true
```

The registry mounts a persistent volume for storing of images. By default the size of that persistent volume is 5Gi. To override the size of the persistent volume, add the `storage` property under the `registry` section:

```
apiVersion: learningcenter.tanzu.vmware.com/v1beta1
kind: Workshop
metadata:
  name: lab-application-testing
spec:
  title: Application Testing
  description: Play area for testing my application
  content:
    image: {YOUR-REGISTRY-URL}/lab-application-testing:main
```

```

session:
  applications:
    registry:
      enabled: true
      storage: 20Gi

```

The amount of memory provided to the registry defaults to 768Mi. To increase this, add the `memory` property under the `registry` section.

```

apiVersion: learningcenter.tanzu.vmware.com/v1beta1
kind: Workshop
metadata:
  name: lab-application-testing
spec:
  title: Application Testing
  description: Play area for testing my application
  content:
    image: {YOUR-REGISTRY-URL}/lab-application-testing:main
  session:
    applications:
      registry:
        enabled: true
        memory: 1Gi

```

The registry is secured with a user name and password unique to the workshop session, and must be accessed over a secure connection.

To allow access from the workshop session, the file `$(HOME)/.docker/config.json` containing the registry credentials are injected into the workshop session. This is used by tools such as `docker`.

For deployments in Kubernetes, a secret of type `kubernetes.io/dockerconfigjson` is created in the namespace and applied to the `default` service account in the namespace. This means deployments made using the default service account can pull images from the registry without additional configuration. If creating deployments using other service accounts, add configuration to the service account or deployment to add the registry secret for pulling images.

If you need access to the raw registry host details and credentials, they are provided as environment variables in the workshop session. The environment variables are:

- `REGISTRY_HOST`: Contains the host name for the registry for the workshop session.
- `REGISTRY_AUTH_FILE`: Contains the location of the `docker` configuration file. Must be the equivalent of `$(HOME)/.docker/config.json`.
- `REGISTRY_USERNAME`: Contains the user name for accessing the registry.
- `REGISTRY_PASSWORD`: Contains the password for accessing the registry. This is different for each workshop session.
- `REGISTRY_SECRET`: Contains the name of a Kubernetes secret of type `kubernetes.io/dockerconfigjson` added to the session namespace, which contains the registry credentials.

The URL for accessing the registry adopts the HTTP protocol scheme inherited from the environment variable `INGRESS_PROTOCOL`. This is the same HTTP protocol scheme the workshop sessions use.

To use any of the variables as data variables in workshop content, use the same variable name but in lowercase: `registry_host`, `registry_auth_file`, `registry_username`, `registry_password` and `registry_secret`.

Enabling ability to use Docker

To build container images in a workshop using `docker`, first enable it. Each workshop session is provided with its own separate Docker daemon instance running in a container.

Enabling support for running `docker` requires the use of a privileged container for running the Docker daemon. Because of the security implications of providing access to Docker with this configuration, VMware recommends that if you don't trust the people taking the workshop, any workshops that require Docker only be hosted in a disposable Kubernetes cluster that is destroyed at the completion of the workshop. You must not enable Docker for workshops hosted on a public service that is always kept running and where arbitrary users can access the workshops.

To enable support for using `docker` add a `session.applications.docker` section to the workshop definition and set the `enabled` property to `true`:

```
apiVersion: learningcenter.tanzu.vmware.com/v1beta1
kind: Workshop
metadata:
  name: lab-application-testing
spec:
  title: Application Testing
  description: Play area for testing my application
  content:
    image: {YOUR-REGISTRY-URL}/lab-application-testing:main
  session:
    applications:
      docker:
        enabled: true
```

The container that runs the Docker daemon mounts a persistent volume for storing of images which are pulled down or built locally. By default the size of that persistent volume is 5Gi. To override the size of the persistent volume, add the `storage` property under the `docker` section:

```
apiVersion: learningcenter.tanzu.vmware.com/v1beta1
kind: Workshop
metadata:
  name: lab-application-testing
spec:
  title: Application Testing
  description: Play area for testing my application
  content:
    image: {YOUR-REGISTRY-URL}/lab-application-testing:main
  session:
    applications:
      docker:
        enabled: true
        storage: 20Gi
```

The amount of memory provided to the container running the Docker daemon defaults to 768Mi. To increase this, add the `memory` property under the `registry` section:

```
apiVersion: learningcenter.tanzu.vmware.com/v1beta1
kind: Workshop
metadata:
  name: lab-application-testing
spec:
  title: Application Testing
  description: Play area for testing my application
  content:
    image: {YOUR-REGISTRY-URL}/lab-application-testing:main
  session:
    applications:
      docker:
```



```
enabled: true
memory: 1Gi
```

Access to the Docker daemon from the workshop session uses a local UNIX socket shared with the container running the Docker daemon. If it uses a local tool to access the socket connection for the Docker daemon directly rather than by running `docker`, it must use the `DOCKER_HOST` environment variable to set the location of the socket.

The Docker daemon is only available from within the workshop session and cannot be accessed outside of the pod by any tools deployed separately to Kubernetes.

Enabling WebDAV access to files

You can access or update local files within the workshop session from the terminal command line or editor of the workshop dashboard. The local files reside in the file system of the container the workshop session is running in.

To access the files remotely, you can enable WebDAV support for the workshop session.

To enable support for accessing files over WebDAV, add a `session.applications.webdav` section to the workshop definition, and set the `enabled` property to `true`:

```
apiVersion: learningcenter.tanzu.vmware.com/v1beta1
kind: Workshop
metadata:
  name: lab-application-testing
spec:
  title: Application Testing
  description: Play area for testing my application
  content:
    image: {YOUR-REGISTRY-URL}/lab-application-testing:main
  session:
    applications:
      webdav:
        enabled: true
```

This causes a WebDAV server running within the workshop session environment. A set of credentials is also generated and are available as environment variables. The environment variables are:

- `WEBDAV_USERNAME`: Contains the user name that must be used when authenticating over WebDAV.
- `WEBDAV_PASSWORD`: Contains the password that must be used when authenticating over WebDAV.

To use any of the environment variables related to the container image registry as data variables in workshop content, declare this in the `workshop/modules.yaml` file in the `config.vars` section:

```
config:
  vars:
    - name: WEBDAV_USERNAME
    - name: WEBDAV_PASSWORD
```

The URL endpoint for accessing the WebDAV server is the same as the workshop session, with `/webdav/` path added. This can be constructed from the terminal using:

```
$INGRESS_PROTOCOL://$SESSION_NAMESPACE.$INGRESS_DOMAIN/webdav/
```

In workshop content it can be constructed using:

```
{{ingress_protocol}}://{{session_namespace}}.{{ingress_domain}}/webdav/
```

You can use WebDAV client support provided by your operating system or by using a standalone WebDAV client, such as [CyberDuck](#).

Using WebDAV can make it easier to transfer files to or from the workshop session.

Customizing the terminal layout

By default a single terminal is provided in the web browser when accessing the workshop. If required, you can enable alternate layouts which provide additional terminals. To set the layout, add the `session.applications.terminal` section and include the `layout` property with the desired layout:

```
apiVersion: learningcenter.tanzu.vmware.com/v1beta1
kind: Workshop
metadata:
  name: lab-application-testing
spec:
  title: Application Testing
  description: Play area for testing my application
  content:
    image: {YOUR-REGISTRY-URL}/lab-application-testing:main
  session:
    applications:
      terminal:
        enabled: true
        layout: split
```

The options for the `layout` property are:

- `default`: Single terminal.
- `split`: Two terminals stacked above each other in ratio 60/40.
- `split/2`: Three terminals stacked above each other in ratio 50/25/25.
- `lower`: A single terminal is placed below any dashboard tabs, rather than being a tab of its own. The ratio of dashboard tab to terminal is 70/30.
- `none`: No terminal is displayed but can still be created from the drop down menu.

When adding the `terminal` section, you must include the `enabled` property and set it to `true` as it is a required field when including the section.

If you don't want a terminal displayed and also want to deactivate the ability to create terminals from the drop-down menu, set `enabled` to `false`.

Adding custom dashboard tabs

Exposed applications, external sites and additional terminals, can be given their own custom dashboard tab. This is done by specifying the list of dashboard panels and the target URL:

```
apiVersion: learningcenter.tanzu.vmware.com/v1beta1
kind: Workshop
metadata:
  name: lab-application-testing
spec:
  title: Application Testing
  description: Play area for testing my application
  content:
    image: {YOUR-REGISTRY-URL}/lab-application-testing:main
```

```

session:
  ingresses:
  - name: application
    port: 8080
  dashboards:
  - name: Internal
    url: "${(ingress_protocol)}://${(session_namespace)-application.${(ingress_domain)}"
  - name: External
    url: http://www.example.com

```

The URL values can reference a number of predefined parameters. The available parameters are:

- `session_namespace`: The namespace you create for and bind to the workshop instance. This is the namespace unique to the session and where a workshop can create its own resources.
- `environment_name`: The name of the workshop environment. Its current value is the name of the namespace for the workshop environment and subject to change.
- `workshop_namespace`: The namespace for the workshop environment. This is the namespace where all deployments of the workshop instances you create and where the service account that the workshop instance runs.
- `ingress_domain`: The host domain under which you can create host names when creating ingress routes.
- `ingress_protocol`: The protocol (http/https) used for ingress routes that you create for workshops.

The URL can reference an external web site, however, that web site must not prohibit being embedded in an HTML iframe.

In the case of wanting to have a custom dashboard tab provide an additional terminal, the `url` property must use the form `terminal:<session>`, where `<session>` is replaced with the name of the terminal session. The name of the terminal session can be any name you choose, but must be restricted to lowercase letters, numbers, and dashes. You should avoid using numeric terminal session names such as “1”, “2”, and “3” as these are used for the default terminal sessions.

```

apiVersion: learningcenter.tanzu.vmware.com/v1beta1
kind: Workshop
metadata:
  name: lab-application-testing
spec:
  title: Application Testing
  description: Play area for testing my application
  content:
    image: {YOUR-REGISTRY-URL}/lab-application-testing:main
  session:
    dashboards:
    - name: Example
      url: terminal:example

```

Configure the WorkshopEnvironment resource

This topic describes how you configure the `WorkshopEnvironment` custom resource, which defines a Learning Center workshop environment.

Specifying the workshop definition

Creating a workshop environment is performed as a separate step to loading the workshop definition. This allows multiple distinct workshop environments using the same workshop definition

to be created if necessary.

To specify which workshop definition is to be used for a workshop environment, set the `workshop.name` field of the specification for the workshop environment.

```
apiVersion: learningcenter.tanzu.vmware.com/v1beta1
kind: WorkshopEnvironment
metadata:
  name: lab-markdown-sample
spec:
  workshop:
    name: lab-markdown-sample
```

The workshop environment name specified in the workshop environment metadata does not need to be the same. It has to be different if you create multiple workshop environments from the same workshop definition.

When the workshop environment is created, the namespace created for the workshop environment uses the `name` specified in the `metadata`. This name is also used in the unique names of each workshop instance created under the workshop environment.

Overriding environment variables

A workshop definition can set a list of environment variables that must be set for all workshop instances. To override an environment variable specified in the workshop definition, or one defined in the container image, you can supply a list of environment variables as `session.env`.

```
apiVersion: learningcenter.tanzu.vmware.com/v1beta1
kind: WorkshopEnvironment
metadata:
  name: lab-markdown-sample
spec:
  workshop:
    name: lab-markdown-sample
  session:
    env:
      - name: REPOSITORY-URL
        value: YOUR-GIT-URL-FOR-LAB-MARKDOWN-SAMPLE
```

Where `YOUR-GIT-URL-FOR-LAB-MARKDOWN-SAMPLE` is the Git repository URL for `lab-markdown-sample`. For example, `{YOUR-GIT-REPO-URL}/lab-markdown-sample`.

You can use this to set the location of a back-end service, such as an image registry, used by the workshop.

Values of fields in the list of resource objects can reference several predefined parameters. The available parameters are:

- `session_` - A unique ID for the workshop instance within the workshop environment.
- `session_` - The namespace created for and bound to the workshop instance. This is the namespace unique to the session and where a workshop can create its own resources.
- `environment_` - The name of the workshop environment. Currently, this is the same as the name of the namespace for the workshop environment. It is suggested that you do not rely on workshop environment name and namespace being the same, and use the most appropriate to cope with any future change.
- `workshop_` - The namespace for the workshop environment. This is the namespace where all deployments of the workshop instances are created and where the workshop instance runs the service account exists.

- `service_` - The workshop instance service account's name and access to the namespace created for that workshop instance.
- `ingress_` - The host domain under which host names are created when creating ingress routes.
- `ingress_` - The protocol (http/https) used for ingress routes created for workshops.

The syntax for referencing one of the parameters is `$(parameter_name)`.

Overriding the ingress domain

To access a workshop instance using a public URL, you must specify an ingress domain. If an ingress domain is not specified, the default ingress domain that the Learning Center operator configured with is used.

When setting a custom domain, DNS must be configured with a wildcard domain to forward all requests for subdomains of the custom domain to the ingress router of the Kubernetes cluster.

To provide the ingress domain, you can set the `session.ingress.domain` field.

```
apiVersion: learningcenter.tanzu.vmware.com/v1beta1
kind: WorkshopEnvironment
metadata:
  name: lab-markdown-sample
spec:
  workshop:
    name: lab-markdown-sample
  session:
    ingress:
      domain: training.learningcenter.tanzu.vmware.com
```

By default, the workshop session is exposed using an HTTP connection if overriding the domain. If you require a secure HTTPS connection, you must have access to a wildcard SSL certificate for the domain. A secret of type `tls` must be created for the certificate in the `learningcenter` namespace or the namespace where the Learning Center Operator is deployed. The name of that secret must then be set in the `session.ingress.secret` field.

```
apiVersion: learningcenter.tanzu.vmware.com/v1beta1
kind: WorkshopEnvironment
metadata:
  name: lab-markdown-sample
spec:
  workshop:
    name: lab-markdown-sample
  session:
    ingress:
      domain: training.learningcenter.tanzu.vmware.com
      secret: training.learningcenter.tanzu.vmware.com-tls
```

If HTTPS connections are terminated using an external load balancer and not by specifying a secret for ingresses managed by the Kubernetes ingress controller, then routing traffic into the Kubernetes cluster as HTTP connections, you can override the ingress protocol without specifying an ingress secret by setting the `session.ingress.protocol` field.

```
apiVersion: learningcenter.tanzu.vmware.com/v1beta1
kind: WorkshopEnvironment
metadata:
  name: lab-markdown-sample
spec:
  workshop:
    name: lab-markdown-sample
```

```

session:
  ingress:
    domain: training.learningcenter.tanzu.vmware.com
    protocol: https

```

To override or set the ingress class, which dictates which ingress router is used when more than one option is available, you can add `session.ingress.class`.

```

apiVersion: learningcenter.tanzu.vmware.com/v1beta1
kind: WorkshopEnvironment
metadata:
  name: lab-markdown-sample
spec:
  workshop:
    name: lab-markdown-sample
  session:
    ingress:
      domain: training.learningcenter.tanzu.vmware.com
      secret: training.learningcenter.tanzu.vmware.com-tls
      class: nginx

```

Controlling access to the workshop

By default, requesting a workshop using the `WorkshopRequest` custom resource is deactivated and must be enabled for a workshop environment by setting `request.enabled` to `true`.

```

apiVersion: learningcenter.tanzu.vmware.com/v1beta1
kind: WorkshopEnvironment
metadata:
  name: lab-markdown-sample
spec:
  workshop:
    name: lab-markdown-sample
  request:
    enabled: true

```

With this enabled, anyone who can create a `WorkshopRequest` custom resource can request the creation of a workshop instance for the workshop environment.

To further control who can request a workshop instance in the workshop environment, you can first set an access token, which a user must know and supply with the workshop request. This is done by setting the `request.token` field.

```

apiVersion: learningcenter.tanzu.vmware.com/v1beta1
kind: WorkshopEnvironment
metadata:
  name: lab-markdown-sample
spec:
  workshop:
    name: lab-markdown-sample
  request:
    enabled: true
    token: lab-markdown-sample

```

The same name as the workshop environment is used in this example, which is probably not a good practice. Use a random value instead. The token value may be multiline.

As a second control measure, you can specify what namespaces the `WorkshopRequest` must be created. This means a user must have the specific ability to create `WorkshopRequest` resources in one of those namespaces.

You can specify the list of namespaces from which workshop requests for the workshop environment by setting `request.namespaces`.

```
apiVersion: learningcenter.tanzu.vmware.com/v1beta1
kind: WorkshopEnvironment
metadata:
  name: lab-markdown-sample
spec:
  workshop:
    name: lab-markdown-sample
  request:
    enabled: true
    token: lab-markdown-sample
    namespaces:
      - default
```

To add the workshop namespace in the list, rather than list the literal name, you can reference a predefined parameter specifying the workshop namespace by including `$(workshop_namespace)`.

```
apiVersion: learningcenter.tanzu.vmware.com/v1beta1
kind: WorkshopEnvironment
metadata:
  name: lab-markdown-sample
spec:
  workshop:
    name: lab-markdown-sample
  request:
    enabled: true
    token: lab-markdown-sample
    namespaces:
      - $(workshop_namespace)
```

Overriding the login credentials

When requesting a workshop using `WorkshopRequest`, a login dialog box is presented to the user when accessing the workshop instance URL. By default, the user name is `learningcenter`. The password is a random value the user must query from the `WorkshopRequest` status after creating the custom resource.

To override the user name, you can set the `session.username` field. To set the same fixed password for all workshop instances, you can set the `session.password` field.

```
apiVersion: learningcenter.tanzu.vmware.com/v1beta1
kind: WorkshopEnvironment
metadata:
  name: lab-markdown-sample
spec:
  workshop:
    name: lab-markdown-sample
  session:
    username: workshop
    password: lab-markdown-sample
```

Additional workshop resources

The workshop definition defined by the `Workshop` custom resource already declares a set of resources to be created with the workshop environment. You can use this when you have shared service applications the workshop needs, such as a container image registry or a Git repository server.

To deploy additional applications related to a specific workshop environment, you can declare them by adding them into the `environment.objects` field of the `WorkshopEnvironment` custom resource. You might use this to deploy a web application used by attendees of a workshop to access their workshop instances.

For namespaced resources, it is not necessary to set the `namespace` field of the resource `metadata`. When the `namespace` field is not present, the resource is created within the workshop namespace for that workshop environment.

When resources are created, owner references are added, making the `WorkshopEnvironment` custom resource correspond to the owner of the workshop environment. This means that any resources are also deleted when the workshop environment is deleted.

Values of fields in the list of resource objects can reference several predefined parameters. The available parameters are:

- `workshop_` - The name of the workshop. This is the name of the `Workshop` definition the workshop environment was created against.
- `environment_` - The name of the workshop environment. Currently, this is the same as the name of the namespace for the workshop environment. Do not rely on the name and the workshop environment being the same, and use the most appropriate to cope with any future change.
- `environment_` - The token value must be used against the workshop environment in workshop requests.
- `workshop_` - The namespace for the workshop environment. This is the namespace where all deployments of the workshop instances and their service accounts are created. It is the same namespace that shared workshop resources are created.
- `service_` - The service account name is used when creating deployments in the workshop namespace.
- `ingress_` - The host domain under which host names are created when creating ingress routes.
- `ingress_` - The protocol (http/https) used for ingress routes created for workshops.
- `ingress_` - The name of the ingress secret stored in the workshop namespace when secure ingress is being used.

To create additional namespaces associated with the workshop environment, embed a reference to `$(workshop_namespace)` in the name of the additional namespaces, with an appropriate suffix. Be mindful that the suffix doesn't overlap with the range of session IDs for workshop instances.

When creating deployments in the workshop namespace, set the `serviceAccountName` of the `Deployment` resource to `$(service_account)`. This ensures the deployment uses a special Pod security policy set up by the Learning Center. If this isn't used and the cluster imposes a more strict default Pod security policy, your deployment might not work, especially if any image expects to run as `root`.

Creation of workshop instances

After a workshop environment is created, you can create the workshop instances. You can request a workshop instance by using the `WorkshopRequest` custom resource. This can be a separate step, or you can add them as resources under `environment.objects`.

```
apiVersion: learningcenter.tanzu.vmware.com/v1beta1
kind: WorkshopEnvironment
metadata:
```



```

name: lab-markdown-sample
spec:
  workshop:
    name: lab-markdown-sample
  request:
    token: lab-markdown-sample
    namespaces:
      - $(workshop_namespace)
  session:
    username: learningcenter
    password: lab-markdown-sample
  environment:
    objects:
      - apiVersion: learningcenter.tanzu.vmware.com/v1beta1
        kind: WorkshopRequest
        metadata:
          name: user1
        spec:
          environment:
            name: $(environment_name)
            token: $(environment_token)
      - apiVersion: learningcenter.tanzu.vmware.com/v1beta1
        kind: WorkshopRequest
        metadata:
          name: user2
        spec:
          environment:
            name: $(environment_name)
            token: $(environment_token)

```

Using this method, the workshop environment is populated with workshop instances. You can query the workshop requests from the workshop namespace to discover the URLs for accessing each and the password if you didn't set one and a random password was assigned.

If you need more control over how the workshop instances were created using this method, you can use the [WorkshopSession](#) custom resource instead.

Configure the WorkshopRequest resource

This topic describes how you configure the [WorkshopRequest](#) custom resource, which defines a Learning Center workshop request.

Specifying workshop environment

The [WorkshopRequest](#) custom resource is used to request a workshop instance. It does not provide details needed to perform the deployment of the workshop instance. That information is sourced by the Learning Center Operator from the [WorkshopEnvironment](#) and [Workshop](#) custom resources.

The minimum required information in the workshop request is the name of the workshop environment. You supply this by setting the `environment.name` field.

For example:

```

apiVersion: learningcenter.tanzu.vmware.com/v1beta1
kind: WorkshopRequest
metadata:
  name: lab-markdown-sample
spec:
  environment:
    name: lab-markdown-sample

```

A request is successful only if requesting a workshop instance for a workshop environment is enabled for that workshop. You can enable requests in the `WorkshopEnvironment` custom resource for the workshop environment.

If multiple workshop requests, for the same workshop environment or different ones, are created in the same namespace, the `name` defined in the `metadata` for the workshop request must be different for each. The value of this name is not used to name workshop instances. You need the `name` value to delete the workshop instance, which is done by deleting the workshop request.

Specifying required access token

If a workshop environment is configured to require an access token when making a workshop request against that environment, you can specify the token by setting the `environment.token` field.

For example:

```
apiVersion: learningcenter.tanzu.vmware.com/v1beta1
kind: WorkshopRequest
metadata:
  name: lab-markdown-sample
spec:
  environment:
    name: lab-markdown-sample
    token: lab-markdown-sample
```

Even with the token, the request fails if the following is true:

- The workshop environment has restricted the namespaces from which a workshop request was made
- The workshop request was not created in one of the permitted namespaces

Configure the TrainingPortal resource

This topic describes how you configure the `TrainingPortal` custom resource, which triggers the deployment of a set of Learning Center workshop environments and a set number of workshop instances.

Specifying the workshop definitions

You run multiple workshop instances to perform training to a group of people by creating the workshop environment and then creating each workshop instance. The `TrainingPortal` workshop resource bundles that up as one step.

Before creating the training environment, you must load the workshop definitions as a separate step.

To specify the names of the workshops to be used for the training, list them under the `workshops` field of the training portal specification. Each entry needs to define a `name` property, matching the name of the `Workshop` resource you created.

```
apiVersion: learningcenter.tanzu.vmware.com/v1beta1
kind: TrainingPortal
metadata:
  name: sample-workshops
spec:
  portal:
    sessions:
      maximum: 8
```

```
workshops:
- name: lab-asciidoc-sample
- name: lab-markdown-sample
```

When the training portal is created, it:

- Sets up the underlying workshop environments.
- Creates any workshop instances required to be created initially for each workshop.
- Deploys a web portal for attendees of the training to access their workshop instances.

Limit the number of sessions

When defining the training portal, you can set a limit on the workshop sessions that can be run concurrently. Set this limit by using the `portal.sessions.maximum` property:

```
apiVersion: learningcenter.tanzu.vmware.com/v1beta1
kind: TrainingPortal
metadata:
  name: sample-workshops
spec:
  portal:
    sessions:
      maximum: 8
  workshops:
  - name: lab-asciidoc-sample
  - name: lab-markdown-sample
```

When you specify this, the maximum capacity of each workshop is set to the maximum value for the training portal as a whole. This means that any one workshop can have as many sessions running as specified by the maximum for the portal. However, to achieve this maximum for a given workshop, only instances of that workshop can be created. In other words, the maximum capacity can be spread across a number of workshops or it can be used in its entirety by a single workshop.

If you do not set `portal.sessions.maximum`, you must set the capacity for each individual workshop as detailed in the following section. In only setting the capacities of each workshop and not an overall maximum for sessions, you cannot share the overall capacity of the training portal across multiple workshops.

Capacity of individual workshops

When you have more than one workshop, you can want to limit how many instances of each workshop you can have so that they cannot grow to the maximum number of sessions for the whole training portal. This means you can stop a specific workshop from using all of the capacity of the training portal. To do this, set the `capacity` field under the entry for the workshop:

```
apiVersion: learningcenter.tanzu.vmware.com/v1beta1
kind: TrainingPortal
metadata:
  name: sample-workshops
spec:
  portal:
    sessions:
      maximum: 8
  workshops:
  - name: lab-asciidoc-sample
    capacity: 4
  - name: lab-markdown-sample
    capacity: 6
```

The value of `capacity` limits the number of workshop sessions for a specific workshop to that value. It must be less than or equal to the maximum number of workshops sessions for the portal, because the latter always sets the absolute limit.

Set reserved workshop instances

By default one instance of each of the listed workshops is created so when the initial user requests that workshop, it's available for use immediately.

When such a reserved instance is allocated to a user, provided that the workshop capacity hasn't been reached, a new instance of the workshop is created as a reserve ready for the next user. When a user ends a workshop and the workshop is at capacity, when the instance is deleted, a new reserve is created. The total of allocated and reserved sessions for a workshop cannot exceed the capacity for that workshop.

To override for a specific workshop how many reserved instances are kept on standby ready for users, you can set the `reserved` setting against the workshop:

```
apiVersion: learningcenter.tanzu.vmware.com/v1beta1
kind: TrainingPortal
metadata:
  name: sample-workshops
spec:
  portal:
    sessions:
      maximum: 8
  workshops:
  - name: lab-asciidoc-sample
    capacity: 4
    reserved: 2
  - name: lab-markdown-sample
    capacity: 6
    reserved: 4
```

You can set the value of `reserved` to 0 if you never want any reserved instances for a workshop and only want instances of that workshop created on demand when required for a user. Creating instances of a workshop on demand can result in a user waiting longer to access a workshop session.

When workshop instances are always created on demand, the oldest reserved instance is terminated to allow a new session of a desired workshop to be created. This also happens when reserved instances tie up capacity that could be used for a new session of another workshop. This occurs if any caps for specific workshops are met.

Override initial number of sessions

The initial number of workshop instances created for each workshop is specified by `reserved` or 1 if the setting hasn't been provided.

In the case where `reserved` is set in order to keep workshop instances on standby, you can indicate that initially you want more than the reserved number of instances created. This is useful when running a workshop for a set period of time. You might create up-front instances of the workshop corresponding to 75% of the expected number of attendees but with a smaller reserve number. With this configuration, new reserve instances only start to be created when the total number approaches 75% and all extra instances created up front have been allocated to users. This ensures you have enough instances ready for when most people come, but you can also create other instances later if necessary:

```

apiVersion: learningcenter.tanzu.vmware.com/v1beta1
kind: TrainingPortal
metadata:
  name: kubernetes-fundamentals
spec:
  portal:
    sessions:
      maximum: 100
  workshops:
  - name: lab-kubernetes-fundamentals
    initial: 75
    reserved: 5

```

Setting defaults for all workshops

If you have a list of workshops, and they all must be set with the same values for `capacity`, `reserved`, and `initial`, rather than add settings to each, you can set defaults to apply to all workshops under the `portal` section:

```

apiVersion: learningcenter.tanzu.vmware.com/v1beta1
kind: TrainingPortal
metadata:
  name: sample-workshops
spec:
  portal:
    sessions:
      maximum: 10
    capacity: 6
    reserved: 2
    initial: 4
  workshops:
  - name: lab-asciidoc-sample
  - name: lab-markdown-sample

```

Set caps on individual users

By default a single user can run more than one workshop at a time. You can cap this to ensure that workshops run only one at a time. This prevents a user from wasting resources by starting more than one workshop and only working on one without shutting the other down.

To apply a limit on how many concurrent workshop sessions a user can start, use the `portal.sessions.registered` setting:

```

apiVersion: learningcenter.tanzu.vmware.com/v1beta1
kind: TrainingPortal
metadata:
  name: sample-workshops
spec:
  portal:
    sessions:
      maximum: 8
      registered: 1
  workshops:
  - name: lab-asciidoc-sample
    capacity: 4
    reserved: 2
  - name: lab-markdown-sample
    capacity: 6
    reserved: 4

```

This limit also applies to anonymous users when anonymous access is enabled through the training portal web interface or if sessions are being created through the REST API. To set a limit on anonymous users, you can set `portal.sessions.anonymous` instead:

```
apiVersion: learningcenter.tanzu.vmware.com/v1beta1
kind: TrainingPortal
metadata:
  name: sample-workshops
spec:
  portal:
    sessions:
      maximum: 8
      anonymous: 1
  workshops:
  - name: lab-asciidoc-sample
    capacity: 4
    reserved: 2
  - name: lab-markdown-sample
    capacity: 6
    reserved: 4
```

Expiration of workshop sessions

After you reach the maximum capacity, no more workshops sessions can be created. After a workshop session is allocated to a user, it cannot be reassigned to another user.

If you are running a supervised workshop, set the capacity higher than the anticipated number of users in case you have more users than you expect. Use the setting for the reserved number of instances. This way, even if you set a higher capacity than needed, workshop sessions are only created as required and not all up front.

In supervised workshops, when the training is over, delete the whole training environment. All workshop sessions are then deleted.

To host a training portal over an extended period but don't know when users want to do a workshop, you can set up workshop sessions to expire after a set time. When expired, the workshop session is deleted and a new workshop session can be created in its place.

The maximum capacity is therefore the maximum at any one point in time, while the number can grow and shrink over time. So over an extended time, you can handle many more sessions than the set maximum capacity. The maximum capacity ensures you don't try to allocate more workshop sessions than you have resources for at a given time.

To set a maximum time allowed for a workshop session, use the `expires` setting:

```
apiVersion: learningcenter.tanzu.vmware.com/v1beta1
kind: TrainingPortal
metadata:
  name: lab-markdown-sample
spec:
  workshops:
  - name: lab-markdown-sample
    capacity: 8
    reserved: 1
    expires: 60m
```

The value needs to be an integer, followed by a suffix of 's', 'm' or 'h', corresponding to seconds, minutes, or hours.

The time period is calculated from when the workshop session is allocated to a user. When the time period is up, the workshop session is automatically deleted.

When an expiration period is specified, or when a user finishes a workshop or restarts the workshop, the workshop is also deleted.

To cope with users who claim a workshop session, but leave and don't use it, you can set a time period for when a workshop session with no activity is deemed orphaned and so is deleted. Do this using the `orphaned` setting:

```
apiVersion: learningcenter.tanzu.vmware.com/v1beta1
kind: TrainingPortal
metadata:
  name: lab-markdown-sample
spec:
  workshops:
  - name: lab-markdown-sample
    capacity: 8
    reserved: 1
    expires: 60m
    orphaned: 5m
```

Avoid this setting for supervised workshops where the whole event only lasts a certain length of time. This prevents a user's session from being deleted when the user takes breaks and the computer goes to sleep.

The `expires` and `orphaned` settings can also be set against `portal` to apply them to all workshops.

Updates to workshop environments

The list of workshops for an existing training portal can be changed by modifying the training portal definition applied to the Kubernetes cluster.

If you remove a workshop from the list of workshops, the workshop environment is marked as stopping and is deleted when all active workshop sessions have completed.

If you add a workshop to the list of workshops, a new workshop environment for it is created.

Changes to settings, such as the maximum number of sessions for the training portal or capacity settings for individual workshops, are applied to existing workshop environments.

By default a workshop environment is left unchanged if the corresponding workshop definition is changed. So in the default configuration, you must explicitly delete the workshop from the list of workshops managed by the training portal and then add it back again if the workshop definition changed.

If you prefer that workshop environments be replaced when the workshop definition changes, enable this by using the `portal.updates.workshop` setting:

```
apiVersion: learningcenter.tanzu.vmware.com/v1beta1
kind: TrainingPortal
metadata:
  name: lab-markdown-sample
spec:
  portal:
    sessions:
      maximum: 8
    updates:
      workshop: true
  workshops:
  - name: lab-markdown-sample
    reserved: 1
    expires: 60m
    orphaned: 5m
```

When using this option, use the `portal.sessions.maximum` setting to limit the number of workshop sessions that can be run for the training portal as a whole. When replacing the workshop environment, the old workshop environment is retained if there is still an active workshop session being used. If the limit isn't set, the new workshop environment is still able to grow to its specific capacity and is not limited by how many workshop sessions are running against old instances of the workshop environment.

Overall, VMware recommends updating workshop environments when workshop definitions change only in development environments when working on workshop content. This is an especially good practice until you are familiar with how the training portal replaces existing workshop environments, and the resource implications of having old and new instances of a workshop environment running at the same time.

Override the ingress domain

To access a workshop instance using a public URL, specify an ingress domain. If an ingress domain isn't specified, the default ingress domain that the Learning Center Operator is configured with is used.

When setting a custom domain, DNS must have been configured with a wildcard domain to forward all requests for sub-domains of the custom domain to the ingress router of the Kubernetes cluster.

To provide the ingress domain, set the `portal.ingress.domain` field:

```
apiVersion: learningcenter.tanzu.vmware.com/v1beta1
kind: TrainingPortal
metadata:
  name: lab-markdown-sample
spec:
  portal:
    ingress:
      domain: learningcenter.tanzu.vmware.com
  workshops:
  - name: lab-markdown-sample
    capacity: 3
    reserved: 1
```

If overriding the domain, by default the workshop session is exposed using a HTTP connection. For a secure HTTPS connection, you must have access to a wildcard SSL certificate for the domain. A secret of type `tls` should be created for the certificate in the `learningcenter` namespace or the namespace where the Learning Center Operator is deployed. The name of that secret must be set in the `portal.ingress.secret` field:

```
apiVersion: learningcenter.tanzu.vmware.com/v1beta1
kind: TrainingPortal
metadata:
  name: lab-markdown-sample
spec:
  portal:
    ingress:
      domain: learningcenter.tanzu.vmware.com
      secret: learningcenter.tanzu.vmware.com-tls
  workshops:
  - name: lab-markdown-sample
    capacity: 3
    reserved: 1
```

You can terminate HTTPS connections by using an external load balancer instead of specifying a secret for ingresses managed by the Kubernetes ingress controller. In that case, when routing

traffic into the Kubernetes cluster as HTTP connections, you can override the ingress protocol without specifying an ingress secret. Instead, set the `portal.ingress.protocol` field:

```
apiVersion: learningcenter.tanzu.vmware.com/v1beta1
kind: TrainingPortal
metadata:
  name: lab-markdown-sample
spec:
  portal:
    ingress:
      domain: learningcenter.tanzu.vmware.com
      protocol: https
  workshops:
  - name: lab-markdown-sample
    capacity: 3
    reserved: 1
```

To override or set the ingress class, which dictates which ingress router is used when more than one option is available, you can add `portal.ingress.class`:

```
apiVersion: learningcenter.tanzu.vmware.com/v1beta1
kind: TrainingPortal
metadata:
  name: lab-markdown-sample
spec:
  portal:
    ingress:
      domain: learningcenter.tanzu.vmware.com
      secret: learningcenter.tanzu.vmware.com-tls
      class: nginx
  workshops:
  - name: lab-markdown-sample
    capacity: 3
    reserved: 1
```

Override the portal host name

The default host name given to the training portal is the name of the resource with `-ui` suffix, followed by the domain specified by the resource or the default inherited from the configuration of the Learning Center Operator.

To override the generated host name, you can set `portal.ingress.hostname`:

```
apiVersion: learningcenter.tanzu.vmware.com/v1beta1
kind: TrainingPortal
metadata:
  name: lab-markdown-sample
spec:
  portal:
    ingress:
      hostname: labs
      domain: learningcenter.tanzu.vmware.com
      secret: learningcenter.tanzu.vmware.com-tls
  workshops:
  - name: lab-markdown-sample
    capacity: 3
    reserved: 1
```

This causes the host name to be `labs.learningcenter.tanzu.vmware.com` rather than the default generated name for this example of `lab-markdown-sample-ui.learningcenter.tanzu.vmware.com`.

Set extra environment variables

To override any environment variables for workshop instances created for a specific work, provide the environment variables in the `env` field of that workshop:

```
apiVersion: learningcenter.tanzu.vmware.com/v1beta1
kind: TrainingPortal
metadata:
  name: lab-markdown-sample
spec:
  workshops:
  - name: lab-markdown-sample
    capacity: 3
    reserved: 1
    env:
    - name: REPOSITORY-URL
      value: YOUR-GIT-URL-FOR-LAB-MARKDOWN-SAMPLE
```

Where `YOUR-GIT-URL-FOR-LAB-MARKDOWN-SAMPLE` is the Git repository URL for `lab-markdown-sample`. For example, `{YOUR-GIT-REPO-URL}/lab-markdown-sample`.

Values of fields in the list of resource objects can reference a number of predefined parameters. The available parameters are:

- `session_id` - A unique ID for the workshop instance within the workshop environment.
- `session_namespace` - The namespace created for and bound to the workshop instance. This is the namespace unique to the session and where a workshop can create its own resources.
- `environment_name` - The name of the workshop environment. For now this is the same as the name of the namespace for the workshop environment. Don't rely on them being the same, and use the most appropriate to cope with any future change.
- `workshop_namespace` - The namespace for the workshop environment. This is the namespace where all deployments of the workshop instances are created and where the service account that the workshop instance runs as exists.
- `service_account` - The name of the service account the workshop instance runs as and which has access to the namespace created for that workshop instance.
- `ingress_domain` - The host domain under which host names can be created when creating ingress routes.
- `ingress_protocol` - The protocol (http/https) used for ingress routes created for workshops.

The syntax for referencing one of the parameters is `$(parameter_name)`.

Override portal credentials

When a training portal is deployed, the user name for the admin and robot accounts uses the defaults of `learningcenter` and `robot@learningcenter`. The passwords for each account are randomly set.

For the robot account, the OAuth application client details used with the REST API are also randomly generated.

You can see what the credentials and client details are by running `kubectl describe` against the training portal resource. This will yield output that includes:

```
Status:
  learningcenter:
    Clients:
```

```

Robot:
  Id:      ACZpcaLIT3qr725YWmXu8et9REl4HBg1
  Secret:  t5IfXbGZQThAKR43apoc9usOFVDv2BLE
Credentials:
  Admin:
    Password: 0kGmM1Yw46BZT2vCntyrRuFf1gQq5ohi
    Username: learningcenter
  Robot:
    Password: QrnY67ME9yGasNhq20TbgWA4RzipUvo5
    Username: robot@learningcenter

```

To override any of these values to set them to a predetermined value, you can add `credentials` and `clients` sections to the training portal specification.

To overload the credentials for the admin and robot accounts user:

```

apiVersion: learningcenter.tanzu.vmware.com/v1beta1
kind: TrainingPortal
metadata:
  name: lab-markdown-sample
spec:
  portal:
    credentials:
      admin:
        username: admin-user
        password: top-secret
      robot:
        username: robot-user
        password: top-secret
  workshops:
  - name: lab-markdown-sample
    capacity: 3
    reserved: 1

```

To override the application client details for OAuth access by the robot account user:

```

apiVersion: learningcenter.tanzu.vmware.com/v1beta1
kind: TrainingPortal
metadata:
  name: lab-markdown-sample
spec:
  portal:
    clients:
      robot:
        id: application-id
        secret: top-secret
  workshops:
  - name: lab-markdown-sample
    capacity: 3
    reserved: 1

```

Control registration type

By default the training portal web interface presents a registration page for users to create an account before selecting a workshop. If you want to allow only the administrator to log in, you can deactivate the registration page. Do this if you are using the REST API to create and allocate workshop sessions from a separate application:

```

apiVersion: learningcenter.tanzu.vmware.com/v1beta1
kind: TrainingPortal
metadata:
  name: lab-markdown-sample
spec:

```

```
portal:
  registration:
    type: one-step
    enabled: false
workshops:
- name: lab-markdown-sample
  capacity: 3
  reserved: 1
```

If rather than requiring users to register, you want to allow anonymous access, you can switch the registration type to anonymous:

```
apiVersion: learningcenter.tanzu.vmware.com/v1beta1
kind: TrainingPortal
metadata:
  name: lab-markdown-sample
spec:
  portal:
    registration:
      type: anonymous
  workshops:
  - name: lab-markdown-sample
    capacity: 3
    reserved: 1
```

When a user visits the training portal home page in anonymous mode, an account for that user is automatically created and the user is logged in.

Specify an event access code

When deploying the training portal with anonymous access or open registration, anyone who knows the URL can access workshops. To at least restrict access to those who know a common event access code or password, you can set `portal.password`:

```
apiVersion: learningcenter.tanzu.vmware.com/v1beta1
kind: TrainingPortal
metadata:
  name: lab-markdown-sample
spec:
  portal:
    password: workshops-2020-07-01
  workshops:
  - name: lab-markdown-sample
    capacity: 3
    reserved: 1
```

When anonymous access is enabled and the training portal URL is accessed, users are asked to enter an event access code before they are redirected to the list of workshops or to the login page.

Make a list of workshops public

By default the index page providing the catalog of available workshop images is only available after a user has logged in, either through a registered account or as an anonymous user.

To make the catalog of available workshops public so they can be viewed before logging in, set the `portal.catalog.visibility` property:

```
apiVersion: learningcenter.tanzu.vmware.com/v1beta1
kind: TrainingPortal
metadata:
  name: lab-markdown-sample
```

```
spec:
  portal:
    catalog:
      visibility: public
  workshops:
  - name: lab-markdown-sample
    capacity: 3
    reserved: 1
```

By default the catalog has visibility set to `private`. Use `public` to expose it.

This also makes it possible to access the list of available workshops from the catalog through the REST API, without authenticating against the REST API.

Use an external list of workshops

If you are using the training portal with registration deactivated, and you are using the REST API from a separate website to control creation of sessions, you can specify an alternate URL for providing the list of workshops.

This helps when the REST API creates a session and cookies are deleted or a session URL is shared with a different user. This means the value for the `index_url` supplied with the REST API request is lost.

To set the URL for the external site, use the `portal.index` property:

```
apiVersion: learningcenter.tanzu.vmware.com/v1beta1
kind: TrainingPortal
metadata:
  name: lab-markdown-sample
spec:
  portal:
    index: https://www.example.com/
    registration:
      type: one-step
      enabled: false
  workshops:
  - name: lab-markdown-sample
    capacity: 3
    reserved: 1
```

If you supply this property, passing the `index_url` when creating a workshop session using the REST API is optional, and the value of this property is used. You can still supply `index_url` when using the REST API for a user to be redirected back to a sub-category of workshops on the site. The URL provided in the training portal definition then acts only as a fallback. That is, when the redirect URL becomes unavailable, it directs the user back to the top-level page for the external list of workshops.

If a user has logged into the training portal as the admin user, the user is not redirected to the external site and still sees the training portal's list of workshops.

Override portal title and logo

By default the web interface for the training portal displays a generic Learning Center logo and a page title of "Workshops." To override these, you can set `portal.title` and `portal.logo`:

```
apiVersion: learningcenter.tanzu.vmware.com/v1beta1
kind: TrainingPortal
metadata:
  name: lab-markdown-sample
spec:
```

```
portal:
  title: Workshops
  logo: data:image/png;base64,...
workshops:
- name: lab-markdown-sample
  capacity: 3
  reserved: 1
```

The `logo` field should be a graphical image provided in embedded data URI format. The image is displayed with a fixed height of “40px”. The field can also be a URL for an image stored on a remote web server.

Allow the portal in an iframe

By default it is prohibited to display the web interface for the training portal in an iframe of another web site, because of content security policies applying to the training portal website.

To enable the ability to iframe the full training portal web interface or even a specific workshop session created using the REST API, provide the host name of the site that embeds it. Do this by using the `portal.theme.frame.ancestors` property:

```
apiVersion: learningcenter.tanzu.vmware.com/v1beta1
kind: TrainingPortal
metadata:
  name: lab-markdown-sample
spec:
  portal:
    theme:
      frame:
        ancestors:
          - https://www.example.com
  workshops:
  - name: lab-markdown-sample
    capacity: 3
    reserved: 1
```

The property is a list of hosts, not a single value. To use a URL for the training portal in an iframe of a page, which, in turn, is embedded in another iframe of a page on a different site, list the host names of all sites.

Because the sites that embed iframes must be secure and use HTTPS, they cannot use plain HTTP. Browser policies prohibit promoting cookies to an insecure site when embedding using an iframe. If cookies cannot be stored, a user cannot authenticate against the workshop session.

Collect analytics on workshops

To collect analytics data on usage of workshops, supply a webhook URL. When you supply a webhook URL, events are posted to the webhook URL, including:

- Workshops started
- Pages of a workshop viewed
- Expiration of a workshop
- Completion of a workshop
- Termination of a workshop

For example:

```
apiVersion: learningcenter.tanzu.vmware.com/v1beta1
kind: TrainingPortal
```

```

metadata:
  name: lab-markdown-sample
spec:
  analytics:
    webhook:
      url: https://metrics.learningcenter.tanzu.vmware.com/?client=name&token=password
  workshops:
  - name: lab-markdown-sample
    capacity: 3
    reserved: 1

```

At present there is no metrics collection service compatible with the portal webhook reporting mechanism, so create a custom service or integrate it with any existing web front end for the portal REST API service.

If the collection service needs to be provided with a client ID or access token, it must accept using query string parameters set in the webhook URL.

Include the details of the event as HTTP POST data by using the `application/json` content type:

```

{
  "portal": {
    "name": "lab-markdown-sample",
    "uid": "91dfa283-fb60-403b-8e50-fb30943ae87d",
    "generation": 3,
    "url": "https://lab-markdown-sample-ui.learningcenter.tanzu.vmware.com"
  },
  "event": {
    "name": "Session/Started",
    "timestamp": "2021-03-18T02:50:40.861392+00:00",
    "user": "c66db34e-3158-442b-91b7-25391042f037",
    "session": "lab-markdown-sample-w01-s001",
    "environment": "lab-markdown-sample-w01",
    "workshop": "lab-markdown-sample",
    "data": {}
  }
}

```

When an event has associated data, it is included in the `data` dictionary:

```

{
  "portal": {
    "name": "lab-markdown-sample",
    "uid": "91dfa283-fb60-403b-8e50-fb30943ae87d",
    "generation": 3,
    "url": "https://lab-markdown-sample-ui.learningcenter.tanzu.vmware.com"
  },
  "event": {
    "name": "Workshop/View",
    "timestamp": "2021-03-18T02:50:44.590918+00:00",
    "user": "c66db34e-3158-442b-91b7-25391042f037",
    "session": "lab-markdown-sample-w01-s001",
    "environment": "lab-markdown-sample-w01",
    "workshop": "lab-markdown-sample",
    "data": {
      "current": "workshop-overview",
      "next": "setup-environment",
      "step": 1,
      "total": 4
    }
  }
}

```

The `user` field is the same portal user identity returned by the REST API when creating workshop sessions.

The event stream only produces events for things as they happen. For a snapshot of all current workshop sessions, use the REST API to request the catalog of available workshop environments, enabling the inclusion of current workshop sessions.

Track using Google Analytics

To record analytics data on usage of workshops by using Google Analytics, enable tracking by supplying a tracking ID for Google Analytics:

```
apiVersion: learningcenter.tanzu.vmware.com/v1beta1
kind: TrainingPortal
metadata:
  name: lab-markdown-sample
spec:
  analytics:
    google:
      trackingId: UA-XXXXXXX-1
  workshops:
  - name: lab-markdown-sample
    capacity: 3
    reserved: 1
```

Custom dimensions are used in Google Analytics to record details about the workshop a user is taking, including through which training portal and cluster it was accessed. So you can use the same Google Analytics tracking ID for multiple training portal instances running on different Kubernetes clusters.

To support use of custom dimensions in Google Analytics, configure the Google Analytics property with the following custom dimensions. They must be added in the order shown, because Google Analytics doesn't allow you to specify the index position for a custom dimension. It allocates them for you. You can't already have custom dimensions defined for the property, as the new custom dimensions must start at index of 1.

| Custom Dimension Name | Index |
|-----------------------|-------|
| workshop_name | 1 |
| session_namespace | 2 |
| workshop_namespace | 3 |
| training_portal | 4 |
| ingress_domain | 5 |
| ingress_protocol | 6 |

In addition to custom dimensions against page accesses, events are also generated. These include:

- Workshop/Start
- Workshop/Finish
- Workshop/Expired

If you provide a Google Analytics tracking ID with the `TrainingPortal` resource definition, it takes precedence over the `SystemProfile` resource definition.



Note

Google Analytics is not a reliable way to collect data. Individuals or corporate firewalls can block the reporting of Google Analytics data. For more precise statistics, use the webhook URL for collecting analytics with a custom data collection platform.

Configure the SystemProfile resource

This topic describes how you use the `SystemProfile` custom resource to configure the Learning Center operator.

You can use the default system profile to set defaults for ingress and image pull secrets. You can also select an alternate profile for specific deployments if required.



Important

Changes made to the `SystemProfile` custom resource, or changes made by means of environment variables, don't take effect on already deployed `TrainingPortals`. You must recreate those for the changes to be applied. You only need to recreate the `TrainingPortal` resources, because this resource takes care of recreating the `WorkshopEnvironments` with the new values.

Operator default system profile

The Learning Center Operator, by default, uses an instance of the `SystemProfile` custom resource if it exists, named `default-system-profile`. You can override the name of the resource used by the Learning Center Operator as the default by setting the `SYSTEM_PROFILE` environment variable on the deployment for the Learning Center Operator. For example:

```
kubectl set env deployment/learningcenter-operator -e SYSTEM_PROFILE=default-system-profile -n learningcenter
```

The Learning Center Operator automatically detects and uses any changes to an instance of the `SystemProfile` custom resource. You do not need to redeploy the operator when changes are made.

Defining configuration for ingress

The `SystemProfile` custom resource replaces the use of environment variables to configure details such as the ingress domain, secret, and class.

Instead of setting `INGRESS_DOMAIN`, `INGRESS_SECRET`, and `INGRESS_CLASS` environment variables, create an instance of the `SystemProfile` custom resource named `default-system-profile`:

```
apiVersion: learningcenter.tanzu.vmware.com/v1beta1
kind: SystemProfile
metadata:
  name: default-system-profile
spec:
  ingress:
    domain: learningcenter.tanzu.vmware.com
    secret: learningcenter.tanzu.vmware.com-tls
    class: nginx
```

If you terminate HTTPS connections by using an external load balancer and not by specifying a secret for ingresses managed by the Kubernetes ingress controller, then routing traffic into the

Kubernetes cluster as HTTP connections, you can override the ingress protocol without specifying an ingress secret:

```
apiVersion: learningcenter.tanzu.vmware.com/v1beta1
kind: SystemProfile
metadata:
  name: default-system-profile
spec:
  ingress:
    domain: learningcenter.tanzu.vmware.com
    protocol: https
    class: nginx
```

Defining container image registry pull secrets

To work with custom workshop images stored in a private image registry, the system profile can define a list of image pull secrets. Add this to the service accounts used to deploy and run the workshop images. Set the `environment.secrets.pull` property to the list of secret names:

```
apiVersion: learningcenter.tanzu.vmware.com/v1beta1
kind: SystemProfile
metadata:
  name: default-system-profile
spec:
  environment:
    secrets:
      pull:
        - private-image-registry-pull
```

The secrets containing the image registry credentials must exist within the `learningcenter` namespace or the namespace where the Learning Center Operator is deployed. The secret resources must be of type `kubernetes.io/dockerconfigjson`.

The secrets are added to the workshop namespace and are not visible to a user. No secrets are added to the namespace created for each workshop session.

Some container images are used as part of Learning Center itself, such as the container image for the training portal web interface and the builtin base workshop images. If you have copied these from the public image registries and stored them in a local private registry, use the `registry` section instead of the above setting. For example:

```
apiVersion: learningcenter.tanzu.vmware.com/v1beta1
kind: SystemProfile
metadata:
  name: default-system-profile
spec:
  registry:
    secret: learningcenter-image-registry-pull
```

The `registry.secret` is the name of the secret containing the image registry credentials. This must be present in the `learningcenter` namespace or the namespace where the Learning Center Operator is deployed.

Defining storage class for volumes

Deployments of the training portal web interface and the workshop sessions make use of persistent volumes. By default the persistent volume claims do not specify a storage class for the volume. Instead, they rely on the Kubernetes cluster to specify a default storage class that works. If the

Kubernetes cluster doesn't define a suitable default storage class or you need to override it, you can set the `storage.class` property. For example:

```
apiVersion: learningcenter.tanzu.vmware.com/v1beta1
kind: SystemProfile
metadata:
  name: default-system-profile
spec:
  storage:
    class: default
```

This only applies to persistent volume claims setup by the Learning Center Operator. If a user executes steps in a workshop that include making persistent volume claims, these are not automatically adjusted.

Defining storage group for volumes

The cluster must apply pod security policies where persistent volumes are used by Learning Center for the training portal web interface and workshop environments. These security policies ensure that permissions of persistent volumes are set correctly so they can be accessed by containers mounting the persistent volume. When the pod security policy admission controller is not enabled, the cluster institutes a fallback to enable access to volumes by enabling group access using the group ID of 0.

In situations where the only class of persistent storage available is NFS or similar, you might have to override the group ID applied and set it to an alternate ID dictated by the file system storage provider. If this is required, you can set the `storage.group` property. For example:

```
apiVersion: learningcenter.tanzu.vmware.com/v1beta1
kind: SystemProfile
metadata:
  name: default-system-profile
spec:
  storage:
    group: 1
```

Overriding the group ID to match the persistent storage relies on the group having write permission to the volume. If only the owner of the volume has permission, this does not work.

In this case, change the owner/group and permissions of the persistent volume such that the owner matches the user ID a container runs at. Alternatively, set the group to a known ID that is added as a supplemental group for the container and update the persistent volume to be writable to this group. This must be done by an `init` container running in the pod mounting the persistent volume.

To trigger this change of ownership and permissions, set the `storage.user` property. For example:

```
apiVersion: learningcenter.tanzu.vmware.com/v1beta1
kind: SystemProfile
metadata:
  name: default-system-profile
spec:
  storage:
    user: 1
    group: 1
```

This results in:

- The `init` container running as the root user.
- The owner of the mount directory of the persistent volume being set to `storage.user`.

- The group being set to `storage.group`.
- The directory made group-writable.

The group is then added as the supplemental group to containers using the persistent volume. So they can write to the persistent volume, regardless of what user ID the container runs as. To that end, the specific value of `storage.user` doesn't matter, but you might need to set it to a specific user ID based on requirements of the storage provider.

Both these variations on the settings only apply to the persistent volumes used by Learning Center itself. If a workshop asks users to create persistent volumes, those instructions, or the resource definitions used, might need to be modified to work where the available storage class requires access as a specific user or group ID.

Further, the second method using the `init` container to fix permissions does not work if pod security policies are enforced. The ability to run a container as the root user is blocked in that case due to the restricted PSP, which is applied to workshop instances.

Restricting network access

Any processes running from the workshop container, and any applications deployed to the session namespaces associated with a workshop instance, can contact any network IP addresses accessible from the cluster. To restrict access to IP addresses or IP subnets, set `network.blockCIDRs`. This must be a CIDR block range corresponding to the subnet or a portion of a subnet you want to block. A Kubernetes `NetworkPolicy` is used to enforce the restriction. So the Kubernetes cluster must use a network layer supporting network policies, and the necessary Kubernetes controllers supporting network policies must be enabled when the cluster is installed.

If deploying to AWS, it is important to block access to the AWS endpoint for querying EC2 metadata, because it can expose sensitive information that workshop users should not have access to. By default Learning Center will block the AWS endpoint on the TAP SystemProfile. If you need to replicate this block to other SystemProfiles, the configuration is as follows:

```
apiVersion: learningcenter.tanzu.vmware.com/v1beta1
kind: SystemProfile
metadata:
  name: default-system-profile
spec:
  network:
    blockCIDRs:
      - 169.254.169.254/32
      - fd00:ec2::254/128
```

Running Docker daemon rootless

If `docker` is enabled for workshops, Docker-in-Docker is run using a sidecar container. Because of the current state of running Docker-in-Docker and portability across Kubernetes environments, the `docker` daemon by default runs as `root`. Because a privileged container is also being used, this represents a security risk. Only run workshops requiring `docker` in disposable Kubernetes clusters or for users whom you trust.

You can partly mediate the risks of running `docker` in the Kubernetes cluster by running the `docker` daemon in rootless mode. However, not all Kubernetes clusters can support this due to the Linux kernel configuration or other incompatibilities.

To enable rootless mode, you can set the `dockerd.rootless` property to `true`:

```
apiVersion: learningcenter.tanzu.vmware.com/v1beta1
kind: SystemProfile
```

```

metadata:
  name: default-system-profile
spec:
  dockerd:
    rootless: true

```

Use of `docker` can be made even more secure by avoiding the use of a privileged container for the `docker` daemon. This requires that you set up a specific configuration for nodes in the Kubernetes cluster. With this configuration, you can disallow the use of a privileged container by setting `dockerd.privileged` to `false`:

```

apiVersion: learningcenter.tanzu.vmware.com/v1beta1
kind: SystemProfile
metadata:
  name: default-system-profile
spec:
  dockerd:
    rootless: true
    privileged: false

```

For further details about the requirements for running rootless Docker-in-Docker and using a non-privileged container, see the [Docker documentation](#).

Overriding network packet size

When you enable support for building container images using `docker` for workshops, because of network layering that occurs when doing `docker build` or `docker run`, you must adjust the network packet size (MTU) used for containers run from `dockerd` hosted inside the workshop container.

The default MTU size for networks is 1500, but, when containers are run in Kubernetes, the size available to containers is often reduced. To deal with this possibility, the MTU size used when `dockerd` is run for a workshop is set as 1400 instead of 1500.

You might need to override this value to an even lower value if you experience problems building or running images with `docker` support. These problems could include errors or timeouts in pulling images or when pulling software packages such as PyPi, npm, and so on.

To lower the value, set the `dockerd.mtu` property:

```

apiVersion: learningcenter.tanzu.vmware.com/v1beta1
kind: SystemProfile
metadata:
  name: default-system-profile
spec:
  dockerd:
    mtu: 1400

```

To discover the maximum viable size, access the `docker` container run with a workshop and run `ifconfig eth0`. This yields something similar to:

```

eth0      Link encap:Ethernet  HWaddr 02:42:AC:11:00:07
          inet addr:172.17.0.7  Bcast:172.17.255.255  Mask:255.255.0.0
          UP BROADCAST RUNNING MULTICAST  MTU:1350  Metric:1
          RX packets:270018  errors:0  dropped:0  overruns:0  frame:0
          TX packets:283882  errors:0  dropped:0  overruns:0  carrier:0
          collisions:0 txqueuelen:0
          RX bytes:86363656 (82.3 MiB)  TX bytes:65183730 (62.1 MiB)

```

If the `MTU` size is less than 1400, use the value given, or a smaller value, for the `dockerd.mtu` setting.

Image registry pull through cache

When running or building container images with `docker`, if the container image is hosted on Docker Hub, it is pulled down directly from the Docker Hub for each separate workshop session of that workshop.

Because the image is pulled from Docker Hub, this can be slow for all users, especially for large images. With Docker Hub introducing limits on how many images can be pulled anonymously from an IP address within a set period, this also can result in the cap on image pulls being reached. This prevents the workshop from being used until the period expires.

Docker Hub has a higher limit when pulling images as an authenticated user, but with the limit applied to the user rather than by IP address. For authenticated users with a paid plan on Docker Hub, there is no limit.

To attempt to avoid the impact of the limit, the first thing you can do is enable an image registry mirror with image pull-through. This is enabled globally and results in an instance of an image registry mirror being created in the workshop environment of workshops that enable `docker` support. This mirror is used for all workshops sessions created against that workshop environment. When the first user attempts to pull an image, it is pulled down from Docker Hub and cached in the mirror. Subsequent users are served up from the image registry mirror, avoiding the need to pull the image from Docker Hub again. Subsequent users also see a speed up in pulling the image, because the mirror is deployed to the same cluster.

To enable the use of an image registry mirror against Docker Hub, use:

```
apiVersion: learningcenter.tanzu.vmware.com/v1beta1
kind: SystemProfile
metadata:
  name: default-system-profile
spec:
  dockerd:
    mirror:
      remote: https://registry-1.docker.io
```

For authenticated access to Docker Hub, create an access token under your Docker Hub account. Then set the `username` and `password` using the access token as the `password`. Do not use the password for the account itself. Using an access token makes it easier to revoke the token if necessary.

```
apiVersion: learningcenter.tanzu.vmware.com/v1beta1
kind: SystemProfile
metadata:
  name: default-system-profile
spec:
  dockerd:
    mirror:
      remote: https://registry-1.docker.io
      username: username
      password: access-token
```

An access token provides write access to Docker Hub. It is therefore also recommended you use a separate robot account in Docker Hub that is not used to host images and doesn't have write access to any other organizations. In other words, use it purely for reading images from Docker Hub.

If this is a free account, the higher limit on image pulls then applies. If the account is paid, there might be higher limits or no limit at all.

The image registry mirror is only used when running or building images using support for running `docker`. The mirror does not come into play when creating deployments in Kubernetes, which make use of images hosted on Docker Hub. Use of images from Docker Hub in deployments is still subject to the limit for anonymous access, unless you supply image registry credentials for the deployment so an authenticated user is used.

Setting default access credentials

When deploying a training portal using the `TrainingPortal` custom resource, the credentials for accessing the portal are unique for each instance. Find the details of the credentials by viewing status information added to the custom resources by using `kubectl describe`.

To override the credentials for the portals so the same set of credentials are used for each, add the desired values to the system profile.

To override the user name and password for the admin and robot accounts, use `portal.credentials`:

```
apiVersion: learningcenter.tanzu.vmware.com/v1beta1
kind: SystemProfile
metadata:
  name: default-system-profile
spec:
  portal:
    credentials:
      admin:
        username: learningcenter
        password: admin-password
      robot:
        username: robot@learningcenter
        password: robot-password
```

To override the client ID and secret used for OAuth access by the robot account, use `portal.clients`:

```
apiVersion: learningcenter.tanzu.vmware.com/v1beta1
kind: SystemProfile
metadata:
  name: default-system-profile
spec:
  portal:
    clients:
      robot:
        id: robot-id
        secret: robot-secret
```

If the `TrainingPortal` has specified credentials or client information, they still take precedence over the values specified in the system profile.

Overriding the workshop images

When a workshop does not define a workshop image to use and instead downloads workshop content from GitHub or a web server, it uses the `base-environment` workshop image. The workshop content is then added to the container, overlaid on this image.

The version of the `base-environment` workshop image used is the most up-to-date, compatible version of the image available for that version of the Learning Center Operator when it was released.

If necessary you can override the version of the `base-environment` workshop image used by defining a mapping under `workshop.images`. For workshop images supplied as part of the Learning Center project, you can override the short names used to refer to them.

The short versions of the recognized names are:

- `base-environment:*` is a tagged version of the `base-environment` workshop image matched with the current version of the Learning Center Operator.

To override the version of the `base-environment` workshop image mapped to by the `*` tag, use:

```
apiVersion: learningcenter.tanzu.vmware.com/v1beta1
kind: SystemProfile
metadata:
  name: default-system-profile
spec:
  workshop:
    images:
      "base-environment:*": "tanzu.packages.broadcom.com/learning-center/base-environment:latest"
```

It is also possible to override where images are pulled from for any arbitrary image. This could be used where you want to cache the images for a workshop in a local image registry and avoid going outside of your network, or the cluster, to get them. This means you wouldn't need to override the workshop definitions for a specific workshop to change it. For example:

```
apiVersion: learningcenter.tanzu.vmware.com/v1beta1
kind: SystemProfile
metadata:
  name: default-system-profile
spec:
  workshop:
    images:
      "{YOUR-REGISTRY-URL}/lab-k8s-fundamentals:main": "registry.test/lab-k8s-fundamentals:main"
```

Tracking using Google Analytics

If you want to record analytics data on usage of workshops using Google Analytics, you can enable tracking by supplying a tracking ID for Google Analytics. For example:

```
apiVersion: learningcenter.tanzu.vmware.com/v1beta1
kind: SystemProfile
metadata:
  name: default-system-profile
spec:
  analytics:
    google:
      trackingId: UA-XXXXXXX-1
```

Custom dimensions are used in Google Analytics to record details about the workshop a user is taking and through which training portal and cluster it was accessed. You can therefore use the same Google Analytics tracking ID with Learning Center running on multiple clusters.

To support use of custom dimensions in Google Analytics, you must configure the Google Analytics property with the following custom dimensions. They must be added in the order shown, because Google Analytics doesn't allow you to specify the index position for a custom dimension and allocates them for you. You can't already have defined custom dimensions for the property, because the new custom dimensions must start at index of 1.

| Custom Dimension Name | Index |
|-----------------------|-------|
| workshop_name | 1 |
| session_namespace | 2 |
| workshop_namespace | 3 |
| training_portal | 4 |
| ingress_domain | 5 |
| ingress_protocol | 6 |

In addition to custom dimensions against page accesses, events are also generated. These include:

- Workshop/Start
- Workshop/Finish
- Workshop/Expired

However, Google Analytics is not a reliable way to collect data. This is because individuals or corporate firewalls can block the reporting of Google Analytics data. For more precise statistics, use the webhook URL for collecting analytics with a custom data collection platform. Configuration of a webhook URL for analytics can only be specified on the [TrainingPortal](#) definition and cannot be specified globally on the [SystemProfile](#) configuration.

Overriding styling of the workshop

If using the REST API to create/manage workshop sessions, and the workshop dashboard is then embedded into an iframe of a separate site, you can perform minor styling changes of the dashboard, workshop content, and portal to match the separate site. To do this, provide CSS styles under [theme.dashboard.style](#), [theme.workshop.style](#) and [theme.portal.style](#). For dynamic styling or for adding hooks to report on progress through a workshop to a separate service, supply JavaScript as part of the theme under [theme.dashboard.script](#), [theme.workshop.script](#), and [theme.portal.script](#). For example:

```
apiVersion: learningcenter.tanzu.vmware.com/v1beta1
kind: SystemProfile
metadata:
  name: default-system-profile
spec:
  theme:
    dashboard:
      script: |
        console.log("Dashboard theme overrides.");
      style: |
        body {
          font-family: "Comic Sans MS", cursive, sans-serif;
        }
    workshop:
      script: |
        console.log("Workshop theme overrides.");
      style: |
        body {
          font-family: "Comic Sans MS", cursive, sans-serif;
        }
    portal:
      script: |
        console.log("Portal theme overrides.");
      style: |
        body {
```

```
font-family: "Comic Sans MS", cursive, sans-serif;
}
```

Additional custom system profiles

If the default system profile is specified, it is used by all deployments managed by the Learning Center Operator, unless it was overridden by the system profile to use for a specific deployment. You can set the name of the system profile for deployments by setting the `system.profile` property of `TrainingPortal`, `WorkshopEnvironment`, and `WorkshopSession` custom resources. For example:

```
apiVersion: learningcenter.tanzu.vmware.com/v1beta1
kind: TrainingPortal
metadata:
  name: lab-markdown-sample
spec:
  system:
    profile: learningcenter-tanzu-vmware-com-profile
  workshops:
  - name: lab-markdown-sample
    capacity: 1
```

Configure the WorkshopSession resource

This topic describes how you configure the `WorkshopSession` custom resource, which defines a Learning Center workshop session.

Specifying the session identity

When running training for multiple people, typically you'll use the `TrainingPortal` custom resource to set up a training environment. Alternatively, you can set up a workshop environment by using the `WorkshopEnvironment` custom resource, and then create requests for workshop instances by using the `WorkshopRequest` custom resource. If you're creating requests for workshop instances, and you need more control over how the workshop instances are set up, you can use `WorkshopSession` custom resource instead of `WorkshopRequest`.

To specify the workshop environment the workshop instance is created against, set the `environment.name` field of the specification for the workshop session. You must also specify the session ID for the workshop instance. For example:

```
apiVersion: learningcenter.tanzu.vmware.com/v1beta1
kind: WorkshopSession
metadata:
  name: lab-markdown-sample-user1
spec:
  environment:
    name: lab-markdown-sample
  session:
    id: user1
```

The `name` of the workshop specified in the `metadata` of the training environment must be globally unique for the workshop instance you're creating. You must create a separate `WorkshopSession` custom resource for each workshop instance.

The session ID must be unique within the workshop environment that you're creating the workshop instance against.

Specifying the login credentials

You can control access to each workshop instance using login credentials. This ensures one workshop attendee cannot interfere with another.

To set login credentials for a workshop instance, set the `session.username` and `session.password` fields. For example:

```
apiVersion: learningcenter.tanzu.vmware.com/v1beta1
kind: WorkshopSession
metadata:
  name: lab-markdown-sample
spec:
  environment:
    name: lab-markdown-sample-user1
  session:
    username: learningcenter
    password: lab-markdown-sample
```

If you do not specify login credentials, the workshop instance has no access controls and anyone can access it.

Specifying the ingress domain

To access the workshop instance by using a public URL, you must specify an ingress domain. If an ingress domain isn't specified, use the default ingress domain that the Learning Center operator was configured with.

When setting a custom domain, configure DNS with a wildcard domain to forward all requests for sub-domains of the custom domain to the ingress router of the Kubernetes cluster.

To provide the ingress domain, you can set the `session.ingress.domain` field. For example:

```
apiVersion: learningcenter.tanzu.vmware.com/v1beta1
kind: WorkshopSession
metadata:
  name: lab-markdown-sample
spec:
  environment:
    name: lab-markdown-sample-user1
  session:
    ingress:
      domain: training.learningcenter.tanzu.vmware.com
```

You can create a full host name for the session by prefixing the ingress domain with a host name constructed from the name of the workshop environment and the session ID.

If overriding the domain, by default, the workshop session is exposed by using a HTTP connection. If you require a secure HTTPS connection, you must have access to a wildcard SSL certificate for the domain.

You must create a secret of type `tls` for the certificate in the `learningcenter` namespace or in the namespace where the Learning Center operator is deployed. You must then set the name of that secret in the `session.ingress.secret` field. For example:

```
apiVersion: learningcenter.tanzu.vmware.com/v1beta1
kind: WorkshopSession
metadata:
  name: lab-markdown-sample
spec:
  environment:
    name: lab-markdown-sample-user1
```

```

session:
  ingress:
    domain: training.learningcenter.tanzu.vmware.com
    secret: training.learningcenter.tanzu.vmware.com-tls

```

You can terminate HTTPS connections by using an external load balancer rather than by specifying a secret for ingresses managed by the Kubernetes ingress controller. When routing traffic into the Kubernetes cluster as HTTP connections, you can override the ingress protocol without specifying an ingress secret by setting the `session.ingress.protocol` field.

For example:

```

apiVersion: learningcenter.tanzu.vmware.com/v1beta1
kind: WorkshopSession
metadata:
  name: lab-markdown-sample
spec:
  environment:
    name: lab-markdown-sample-user1
  session:
    ingress:
      domain: training.learningcenter.tanzu.vmware.com
      protocol: https

```

To override or set the ingress class, add `session.ingress.class`. This dictates which ingress router is used when more than one option is available.

For example:

```

apiVersion: learningcenter.tanzu.vmware.com/v1beta1
kind: WorkshopSession
metadata:
  name: lab-markdown-sample
spec:
  environment:
    name: lab-markdown-sample-user1
  session:
    ingress:
      domain: training.learningcenter.tanzu.vmware.com
      secret: training.learningcenter.tanzu.vmware.com-tls
      class: nginx

```

Setting the environment variables

To set the environment variables for the workshop instance, provide the environment variables in the `session.env` field.

```

apiVersion: learningcenter.tanzu.vmware.com/v1beta1
kind: WorkshopSession
metadata:
  name: lab-markdown-sample
spec:
  environment:
    name: lab-markdown-sample
  session:
    id: user1
    env:
      - name: REPOSITORY-URL
        value: YOUR-GIT-URL-FOR-LAB-MARKDOWN-SAMPLE

```

Where `YOUR-GIT-URL-FOR-LAB-MARKDOWN-SAMPLE` is the Git repository URL for `lab-markdown-sample`. For example, `{YOUR-GIT-REPO-URL}/lab-markdown-sample`.

Values of fields in the list of resource objects can reference a number of predefined parameters. Available parameters are:

- `session_id` is a unique ID for the workshop instance within the workshop environment.
- `session_namespace` is the namespace created for and bound to the workshop instance. This is the namespace unique to the session and where a workshop can create their own resources.
- `environment_name` is the name of the workshop environment. For now this is the same as the name of the namespace for the workshop environment. Don't rely on them being the same, and use the most appropriate to cope with any future change.
- `workshop_namespace` is the namespace for the workshop environment. This is the namespace where all deployments of the workshop instances are created, and where the service account that the workshop instance runs as exists.
- `service_account` is the name of the service account the workshop instance runs as, and which has access to the namespace created for that workshop instance.
- `ingress_domain` is the host domain under which host names can be created when creating ingress routes.
- `ingress_protocol` is the protocol (http/https) used for ingress routes created for workshops.

The syntax for referencing one of the parameters is `$(parameter_name)`.

If the workshop environment had specified a set of extra environment variables to be set for workshop instances, it is up to you to incorporate those in the set of environment variables you list under `session.env`. That is, anything listed in `session.env` of the `WorkshopEnvironment` custom resource of the workshop environment is ignored.

Enable anonymous access to a Learning Center training portal

This topic describes how you enable anonymous access to a Learning Center training portal. The REST API with client authentication provides a means to have the portal create and manage workshop sessions on your behalf but allow a separate system handle user authentication.

If you do not need to authenticate users but still want to provide your own front end from which users select a workshop, such as when integrating workshops into an existing web property, you can enable anonymous mode and redirect users to a URL for workshop session creation.



Note

Anonymous mode is only recommended for temporary deployments and not for a permanent web site providing access to workshops.

Enabling anonymous access

Set the registration type to `anonymous` to enable full anonymous access to the training portal:

```
apiVersion: learningcenter.tanzu.vmware.com/v1beta1
kind: TrainingPortal
metadata:
  name: lab-markdown-sample
spec:
  portal:
    registration:
```

```

type: anonymous
workshops:
...

```



Note

Users can still visit the training portal directly and view the catalog of available workshops, so instead of linking to the main page of the training portal, link from your custom index page to the individual links for creating each workshop.

Triggering workshop creation

Direct users' browsers to a URL that is specific to a workshop to trigger creation and allocation of the workshop.

The URL format looks like this:

```

TRAINING-PORTAL-URL/workshops/environment/NAME/create/?index_url=INDEX

```

Where:

- **NAME** is the name of the workshop environment corresponding to the workshop that you creates.
- **INDEX** is the URL of your custom index page that contains the workshops.

The user is redirected back to this index page when:

- a user completes the workshop
- an error occurs

When a user is redirected back to the index page, a query string parameter is supplied to display a banner or other indication about why the user was returned.

The name of the query string parameter is `notification` and the possible values are:

- `session-deleted` - Used when the workshop session is completed or restarted.
- `workshop-invalid` - Used when the name of the workshop environment created is invalid.
- `session-unavailable` - Used when capacity is reached and a workshop session cannot be created.
- `session-invalid` - Used when an attempt is made to access a session that doesn't exist. This can occur when the workshop dashboard is refreshed after the workshop session is expired and deleted.

Enable anonymous access to a Learning Center training portal

This topic describes how you enable anonymous access to a Learning Center training portal. The REST API with client authentication provides a means to have the portal create and manage workshop sessions on your behalf but allow a separate system handle user authentication.

If you do not need to authenticate users but still want to provide your own front end from which users select a workshop, such as when integrating workshops into an existing web property, you can enable anonymous mode and redirect users to a URL for workshop session creation.



Note

Anonymous mode is only recommended for temporary deployments and not for a permanent web site providing access to workshops.

Enabling anonymous access

Set the registration type to `anonymous` to enable full anonymous access to the training portal:

```
apiVersion: learningcenter.tanzu.vmware.com/v1beta1
kind: TrainingPortal
metadata:
  name: lab-markdown-sample
spec:
  portal:
    registration:
      type: anonymous
  workshops:
    ...
```



Note

Users can still visit the training portal directly and view the catalog of available workshops, so instead of linking to the main page of the training portal, link from your custom index page to the individual links for creating each workshop.

Triggering workshop creation

Direct users' browsers to a URL that is specific to a workshop to trigger creation and allocation of the workshop.

The URL format looks like this:

```
TRAINING-PORTAL-URL/workshops/environment/NAME/create/?index_url=INDEX
```

Where:

- `NAME` is the name of the workshop environment corresponding to the workshop that you creates.
- `INDEX` is the URL of your custom index page that contains the workshops.

The user is redirected back to this index page when:

- a user completes the workshop
- an error occurs

When a user is redirected back to the index page, a query string parameter is supplied to display a banner or other indication about why the user was returned.

The name of the query string parameter is `notification` and the possible values are:

- `session-deleted` - Used when the workshop session is completed or restarted.
- `workshop-invalid` - Used when the name of the workshop environment created is invalid.
- `session-unavailable` - Used when capacity is reached and a workshop session cannot be created.
- `session-invalid` - Used when an attempt is made to access a session that doesn't exist. This can occur when the workshop dashboard is refreshed after the workshop session is

expired and deleted.

Use the Learning Center workshop catalog

A single training portal can host one or more workshops. This topic describes how you use the workshop catalog to list the available workshops and get information about them using the REST API.

Listing available workshops

The URL sub path for accessing the list of available workshop environments is `/workshops/catalog/environments/`. When making the request, you must supply the access token in the HTTP `Authorization` header with type set as `Bearer`:

```
curl -v -H "Authorization: Bearer <access-token>" \
<training-portal-url>/workshops/catalog/environments/
```

The JSON response looks like this:

```
{
  "portal": {
    "name": "learningcenter-tutorials",
    "uid": "9b82a7b1-97db-4333-962c-97be6b5d7ee0",
    "generation": 451,
    "url": "<training_portal_url>",
    "sessions": {
      "maximum": 10,
      "registered": 0,
      "anonymous": 0,
      "allocated": 0
    }
  },
  "environments": [
    {
      "name": "learningcenter-tutorials-w01",
      "state": "RUNNING",
      "workshop": {
        "name": "lab-et-self-guided-tour",
        "id": "15e5f1a569496f335049bb00c370ee20",
        "title": "Workshop Building Tutorial",
        "description": "A guided tour of how to build a workshop for your team's learn
ing center.",
        "vendor": "",
        "authors": [],
        "difficulty": "",
        "duration": "",
        "tags": [],
        "logo": "",
        "url": "<workshop_repository_url>"
      },
      "duration": 1800,
      "capacity": 10,
      "reserved": 0,
      "allocated": 0,
      "available": 0
    }
  ]
}
```

For each workshop listed under `environments`, where a field listed under `workshop` has the same name as appears in the `Workshop` custom resource, it has the same meaning. The `id` field is an

additional field that can uniquely identify a workshop based on the name of the workshop image, the Git repository for the workshop, or the website hosting the workshop instructions. The value of the `id` field does not rely on the name of the `Workshop` resource and must be the same if the same workshop details are used but the name of the `Workshop` resource is different.

The `duration` field provides the time in seconds after which the workshop environment expires. The value is `null` if there is no expiration time for the workshop.

The `capacity` field is the maximum number of workshop sessions that you can create for the workshop.

The `reserved` field indicates how many instances of the workshop are reserved as hot spares. These are used to service requests for a workshop session. If no reserved instances are available and capacity has not been reached, a new workshop session is created on demand.

The `allocated` field indicates how many workshop sessions are active and currently allocated to a user.

The `available` field indicates how many workshop sessions are available for immediate allocation. This is never more than the number of reserved instances.

Under `portal.sessions`, the `allocated` field indicates the total number of allocated sessions across all workshops hosted by the portal.

Where `maximum`, `registered`, and `anonymous` are nonzero, they are the limit on the number of workshops run.

- The `maximum` is the total number of workshop sessions that can be run by the portal across all workshops. If `allocated` for the whole portal has reached `maximum`, no more workshop sessions are created.
- The value of `registered` when nonzero indicates a cap on the number of workshop sessions a single registered portal user can have running at the one time.
- The value of `anonymous` when nonzero indicates a cap on the number of workshop sessions an anonymous user can have running at the one time. Anonymous users are users created as a result of the REST API being used or if anonymous access is enabled when the user accesses the portal through the web interface.

By default, only workshop environments currently marked with a `state` of `RUNNING` are returned, that is, those workshop environments which are taking new workshop session requests. If you also want to see the workshop environments which are currently in the process of being shut down, you must provide the `state` query string parameter to the REST API call and indicate which states workshop environments to return for.

```
curl -v -H "Authorization: Bearer <access-token>" \
https://lab-markdown-sample-ui.test/workshops/catalog/environments/?state=RUNNING&state=STOPPING
```

You can include the `state` query string parameter more than once to see workshop environments in both `RUNNING` and `STOPPING` states.

If anonymous access to the list of workshop environments is enabled and you are not authenticated when using the REST API endpoint, only workshop environments in a running state are returned.

Use session management for your Learning Center workshops

This topic describes how you use the REST API endpoints for session management, which allows you to request a workshop session to be allocated.

Deactivating portal user registration

When you use the REST API to trigger creation of workshop sessions, VMware recommends that you deactivate user registration through the training portal web interface. This means that only the admin user is able to directly access the web interface for the training portal.

```
apiVersion: learningcenter.tanzu.vmware.com/v1beta1
kind: TrainingPortal
metadata:
  name: learningcenter-tutorials
spec:
  portal:
    registration:
      type: one-step
      enabled: false
  workshops:
  ...
```

Requesting a workshop session

The form of the URL sub path for requesting the allocation of a workshop environment by using the REST API is `/workshops/environment/<name>/request/`. The name segment must be replaced with the name of the workshop environment. When making the request, the access token must be supplied in the HTTP `Authorization` header with type set as `Bearer`:

```
curl -v -H "Authorization: Bearer <access-token>" \
<training-portal-url>/workshops/environment/<name>/request/?index_url=https://hub.test/
```

You can supply a query string parameter, `index_url`. When you restart the workshop session from the workshop environment web interface, the session is deleted and the user is redirected to the supplied URL. This URL is that of your front end web application that has requested the workshop session, allowing users to select a different workshop.

The value of the `index_url` is not available if session cookies are cleared or a session URL is shared with another user. In this case, a user is redirected back to the training portal URL instead. You can override the global default for this case by specifying the index URL as part of the `TrainingPortal` configuration.

When successful, the JSON response from the request is of the form:

```
{
  "name": "educaes-tutorials-w01-s001",
  "user": "8d2d0c8b-6ff5-4244-b136-110fd8d8431a",
  "url": "/workshops/session/learningcenter-tutorials-w01-s001/activate/?token=6UIW4D8Bhf0egVmsEKYlaOcTywrpQJGi&index_url=https%3A%2F%2Fhub.test%2F",
  "workshop": "learningcenter-tutorials",
  "environment": "learningcenter-tutorials-w01",
  "namespace": "learningcenter-tutorials-w01-s001"
}
```

This includes the name of the workshop session, an ID for identifying the user, and both a URL path with an activation token and an index URL included as query string parameters.

Redirect the user's browser to this URL path on the training portal host. Accessing the URL activates the workshop session and then redirects the user to the workshop dashboard.

If the workshop session is not activated, which confirms allocation of the session, the session is deleted after 60 seconds.

When a user is redirected back to the URL for the index page, a query string parameter is supplied to give the reason the user is being returned. You can use this to display a banner or other indication as to why the user was returned.

The name of the query string parameter is `notification` and the possible values are:

- `session-deleted` - Used when the workshop session is completed or restarted.
- `workshop-invalid` - Used when the name of the workshop environment supplied while attempting to create the workshop is invalid.
- `session-unavailable` - Used when capacity is reached, and a workshop session cannot be created.
- `session-invalid` - Used when an attempt is made to access a session that doesn't exist. This can occur when the workshop dashboard is refreshed sometime after the workshop session expired and was deleted.

In prior versions, the name of the session was returned through the “session” property, whereas the “name” property is now used. To support older code using the REST API, the “session” property is still returned, but it is deprecated.

Associating sessions with a user

When the workshop session is requested, a unique user account is created in the training portal each time. You can identify this account by using the `user` identifier, which is returned in the response.

The front end using the REST API to create workshop sessions can track user activity so that the training portal associates all workshop sessions created by the same user. Supply the `user` identifier with subsequent requests by the same user in the request parameter:

```
curl -v -H "Authorization: Bearer <access-token>" \
https://lab-markdown-sample-ui.test/workshops/environment/<name>/request/?index_url=https://hub.test/&user=<user>
```

If the supplied ID matches a user in the training portal, the training portal uses it internally and returns the same value for `user` in the response.

When the user does match, and if there is already a workshop session allocated to the user for the workshop being requested, the training portal returns a link to the existing workshop session, rather than requesting that the user create a new workshop session.

If the user is not a match, possibly because the training portal was completely redeployed since the last time it was accessed, the training portal returns a new user identifier.

The first time you make a request to create a workshop session for a user where `user` is not supplied, you can optionally supply request parameters for the following to set these as the user details in the training portal.

- `email` - The email address of the user.
- `first_name` - The first name of the user.
- `last_name` - The last name of the user.

These details will be accessible through the admin pages of the training portal.

When sessions are associated with a user, you can query all active sessions for that user across the different workshops hosted by the instance of the training portal:

```
curl -v -H "Authorization: Bearer <access-token>" \
<training-portal-url>/workshops/user/<user>/sessions/
```

The response is of the form:

```
{
  "user": "8d2d0c8b-6ff5-4244-b136-110fd8d8431a",
  "sessions": [
    {
      "name": "learningcenter-tutorials-w01-s001",
      "workshop": "learningcenter-tutorials",
      "environment": "learningcenter-tutorials-w01",
      "namespace": "learningcenter-tutorials-w01-s001",
      "started": "2020-07-31T03:57:33.942Z",
      "expires": "2020-07-31T04:57:33.942Z",
      "countdown": 3353,
      "extendable": false
    }
  ]
}
```

After a workshop has expired or has otherwise been shut down, the training portal no longer returns an entry for the workshop.

Listing all workshop sessions

To get a list of all running workshops sessions allocated to users, provide the `sessions=true` flag to the query string parameters of the REST API call. This lists the workshop environments available through the training portal.

```
curl -v -H "Authorization: Bearer <access-token>" |
<training-portal-url>/workshops/catalog/environments/?sessions=true
```

The JSON response is of the form:

```
{
  "portal": {
    "name": "learningcenter-tutorials",
    "uid": "9b82a7b1-97db-4333-962c-97be6b5d7ee0",
    "generation": 476,
    "url": "<training-portal-url>",
    "sessions": {
      "maximum": 10,
      "registered": 0,
      "anonymous": 0,
      "allocated": 1
    }
  },
  "environments": [
    {
      "name": "learningcenter-tutorials-w01",
      "state": "RUNNING",
      "workshop": {
        "name": "lab-et-self-guided-tour",
        "id": "15e5f1a569496f335049bb00c370ee20",
        "title": "Workshop Building Tutorial",
        "description": "A guided tour of how to build a workshop for your team's learning center.",
        "vendor": "",
        "authors": [],
        "difficulty": "",
        "duration": "",
        "tags": [],
        "logo": "",
        "url": "<workshop-repository-url>"
      }
    }
  ]
}
```

```

"duration": 1800,
"capacity": 10,
"reserved": 0,
"allocated": 1,
"available": 0,
"sessions": [
  {
    "name": "learningcenter-tutorials-w01-s002",
    "state": "RUNNING",
    "namespace": "learningcenter-tutorials-w01-s002",
    "user": "672338f3-4085-4782-8d9b-ae1637e1c28c",
    "started": "2021-11-05T15:50:04.824Z",
    "expires": "2021-11-05T16:20:04.824Z",
    "countdown": 1737,
    "extendable": false
  }
]
}
]
}
}

```

No workshop sessions are returned if anonymous access to this REST API endpoint is enabled and you are not authenticated against the training portal.

Only workshop environments with a `state` of `RUNNING` are returned by default. To see workshop environments that are shut down and any workshop sessions that still haven't been completed, supply the `state` query string parameter with value `STOPPING`.

```

curl -v -H "Authorization: Bearer <access-token>" \
<training-portal-url>/workshops/catalog/environments/?sessions=true&state=RUNNING&state=STOPPING

```

Include the `state` query string parameter more than once to see workshop environments in both `RUNNING` and `STOPPING` states.

Use client authentication for Learning Center

This topic describes how you can use the portal REST API to integrate access to workshops into an existing website or to create a custom web interface for accessing workshops hosted across one or more training portals.

The training portal web interface is a quick way of providing access to a set of workshops when running a supervised training workshop. The REST API gives you access to the list of workshops hosted by a training portal instance and allow you to request and access workshop sessions. This bypasses the training portal's own user registration and log in so you can implement whatever access controls you need. This can include anonymous access or access integrated into an organization's single sign-on system.

Querying the credentials

To provide access to the REST API, a robot account is automatically provisioned. Obtain the login credentials and details of the OAuth client endpoint used for authentication by querying the resource definition for the training portal after it is created and the deployment completed. If using `kubectl describe`, use:

```

kubectl describe trainingportal.learningcenter.tanzu.vmware.com/<training-portal-name>

```

The status section of the output reads:

```

Status:
  learningcenter:
    Clients:
      Robot:
        Id:      ACZpcaLIT3qr725YWmXu8et9REl4HBg1
        Secret:  t5IfXbGZQThAKR43apoc9usOFVDv2BLE
      Credentials:
        Admin:
          Password:  0kGmMlYw46BZT2vCntyrRuFflgQq5ohi
          Username:  learningcenter
        Robot:
          Password:  QrnY67ME9yGasNhq20TbgWA4RzipUvo5
          Username:  robot@learningcenter

```

Use the admin login credentials when you log in to the training portal web interface to access admin pages.

Use the robot login credentials if you want to access the REST API.

Requesting an access token

Before you can make requests against the REST API to query details about workshops or request a workshop session, you must log in through the REST API to get an access token.

This is done from any front-end web application or provisioning system, but the step is equivalent to making a REST API call by using `curl` of:

```

curl -v -X POST -H \
"Content-Type: application/x-www-form-urlencoded" \
-d "grant_type=password&username=robot@learningcenter&password=<robot-password>" \
-u "<robot-client-id>:<robot-client-secret>" \
<training-portal-url>/oauth2/token/

```

The URL sub path is `/oauth2/token/`.

Upon success, the output is a JSON response consisting of:

```

{
  "access_token": "tg31ied56f0o4axuhuZLHj5JpUYCEL",
  "expires_in": 36000,
  "token_type": "Bearer",
  "scope": "user:info",
  "refresh_token": "1ryXhXbNA9RsTRuCE8fDAyZToJmp30"
}

```

Refreshing the access token

The access token that is provided expires: it needs to be refreshed before it expires if in use by a long-running application.

To refresh the access token, use the equivalent of:

```

curl -v -X POST -H \
"Content-Type: application/x-www-form-urlencoded" \
-d "grant_type=refresh_token&refresh_token=<refresh-token>& \client_id=<robot-client-id>&client_secret=<robot-client-secret>" \
https://lab-markdown-sample-ui.test/oauth2/token/

```

As with requesting the initial access token, the URL sub path is `/oauth2/token/`.

The JSON response is of the same format as if a new token was requested.

Troubleshoot Learning Center

This topic gives you troubleshooting and recovery steps for Learning Center known issues.

Training portal stays in pending state

The training portal stays in a “pending” state.

The Training Portal custom resource (CR) has a status property. To see the status, run:

```
kubectl get trainingportals.learningcenter.tanzu.vmware.com
```

Explanation

If the status stays in a pending state, the TLS secret `tls` might not be available. Other errors can also cause the status to stay in a pending state, so it is important to check the operator and portal logs to execute the right steps.

Solution

1. Access the operator logs by running:

```
kubectl logs deployment/learningcenter-operator -n learningcenter
```

Access the portal logs by running:

```
kubectl logs deployment/learningcenter-portal -n {PORTAL_NAMESPACE}
```

2. Check whether the TLS secret `tls` is available. The TLS secret must be on the Learning Center operator namespace (by default `learningcenter`). If the TLS secret is not on the Learning Center operator namespace, the operator logs contain the following error:

```
ERROR:kopf.objects:Handler 'learningcenter' failed temporarily: TLS secret tls is not available
```

3. Follow the steps in [Enforcing Secure Connections in Learning Center Operator](#) to create the TLS secret.
4. Redeploy the `trainingPortal` resource.

image-policy-webhook-service not found

You are installing a Tanzu Application Platform profile and you get this error:

```
Internal error occurred: failed calling webhook "image-policy-webhook.signing.run.tanzu.vmware.com": failed to call webhook: Post "https://image-policy-webhook-service.image-policy-system.svc:443/signing-policy-check?timeout=10s": service "image-policy-webhook-service" not found
```

Explanation

This is a race condition error among some Tanzu Application Platform packages.

Solution

To recover from this error you only need to redeploy the `trainingPortal` resource.

Updates to Tanzu Application Platform values file not reflected in Learning Center Training Portal

If you installed Learning Center through Tanzu profiles, then your installation made use of a `tap-values.yml` file where configurations were specified for Learning Center. If you make updates to these configurations using this command:

```
tanzu package installed update tap --package-name tap.tanzu.vmware.com --version {VERSION} -f tap-values.yml -n tap-install
```

then the changes are not reflected in the deployed Learning Center Training Portal resource. Tap package updates currently **DO NOT** update running Learning Center Training Portal resources.

Run one of these commands to validate changes made to parameters provided to the Learning Center Operator. These parameters include `ingressDomain`, `TLS secret`, `ingressClass`, and others.

Command:

```
kubectl describe systemprofile
```

Command:

```
kubectl describe pod -n learningcenter
```

Explanation

By design, the training portal resources do not react to any changes on the parameters provided when the training portals were created. This prevents any change on the `trainingportal` resource from affecting any online user running a workshop.

Solution

You must restart the operator resource by first deleting the operator pod:

```
kubectl delete pod -n learningcenter learningcenter-operator-$OPERATOR_POD_NAME
```

Then delete the training portal resource. Redeploy `trainingportal` in a maintenance window where Learning Center is unavailable while the `systemprofile` is updated.

Increase your cluster's resources

If you don't have enough nodes or enough resources on nodes for deploying the workloads, node pressure might occur. In this case, follow your cloud provider's instructions on how to scale out or scale up your cluster.

Kubernetes Api Timeout error

The following operator error log means there is a connection error with the Kubernetes API server:

```
operator-log: unexpected error occurred. Read timed out.
```

This error has been found when running Learning Center with the Azure AkS cloud provider.

Solution

To fix this error:

1. Delete the operator pod on the learningcenter namespace.
2. Delete the training portal once the operator is running again by using:

```
kubectl delete trainingportals $PORTAL_NAME
```

1. Redeploy the `trainingPortal` resource.

No URL returned to your trainingportal

After deploying the Learning Center Operator and Trainingportal resources, the following command can yield the resource with no URL, even though your resources deployed correctly and are running:

```
kubectl get trainingportals
```

You also already specified `learningcenter.mydomain.com` in your tap values YAML file if installed through Tanzu Application Platform. See [specifying ingress domain](#)

Solution

Learning center requires that you use a wildcard domain (Wildcard DNS entry) to access your training portal in the browser. This configuration must be done in your DNS provider with a rule that points your wildcard domain to your IP/Load balancer.

For example, if using the default workshop on an Elastic Kubernetes Service (EKS) cluster, your URL could look something like:

```
learning-center-guided.learningcenter.yourdomain.com
```

Where `learningcenter.yourdomain.com` needs a DNS configuration made to point to your default ingress controller.

In this case, the wildcard domain configuration needed is `*.learningcenter.yourdomain.com`.

After this configuration is made, you might need to restart your operator resource by deleting and redeploying to see the URL update.

Known issues for Learning Center

This topic gives you information about known issues for Learning Center and how to mitigate them.

Mitigation for CVE-2023-26114

Critical: [CVE-2023-26114](#) (GHSA ID: [GHSA-frjg-g767-7363](#))

Description:

Versions of the package `code-server` before `v4.10.1` are vulnerable to Missing Origin Validation in WebSocket handshakes. This affects those who use older browsers that do not support SameSite cookies and those who access `code-server` under a shared domain with other users on separate sub-domains. Exploiting this vulnerability might allow an adversary to access data from, and connect to, the `code-server` instance.

Learning Center Context:

Learning Center includes VS Code server as an IDE for the workshop session, giving users the ability to create and edit workshop files. Each time there is a new session, the operator deploys a new VS Code instance that is used only for that specific session for a single user. This VS Code server is an ephemeral instance used only for the amount of time that is declared in the workshop definition. After that amount of time, the Learning Center operator removes the workshop resources and the VS Code instance.

Mitigation:

You can mitigate this issue in the following ways:

- If you don't require an IDE for your workshop, deactivate the VS Code editor in the workshop definition. For more information, see [Enabling the integrated editor](#).

- Enable an event access code on the portal, so there is no way to consume the VS Code instance without the access code. For more information, see [Specify an event access code](#)
- Reduce the exposition by setting up workshop sessions to expire after a set time. After it has expired, the workshop session is deleted. [Expiration of workshop sessions](#)
- Some load balancers allow access only from specific IPs. If this is an available option, configure the load balancer to limit access to the company network or specific IPs.

Overview of Local Source Proxy

Local Source Proxy (LSP) offers developers a secure and user-friendly approach to seamlessly upload their local source code to a Tanzu Application Platform cluster. This enables developers to navigate their code smoothly through a predefined production pathway using supply chains.

With Local Source Proxy, developers can:

- Interact with external registries without needing to know registry specifics, such as endpoints, credentials, and certificates. This eliminates the burden of platform and app operators having to distribute registry credentials to developer workstations.
- Deploy their workloads from a local source through any mechanism, including IDE extensions, without providing the source image location. Developers can seamlessly deploy their applications without managing registry credentials on their local machines or keeping track of where their local source is uploaded.

Consequently, the `--source-image` flag in the Apps CLI becomes optional, and there is no longer a need for Docker registry credentials on the developer's local machine. Local Source Proxy abstracts these details, making deployment more streamlined and user-friendly for developers.

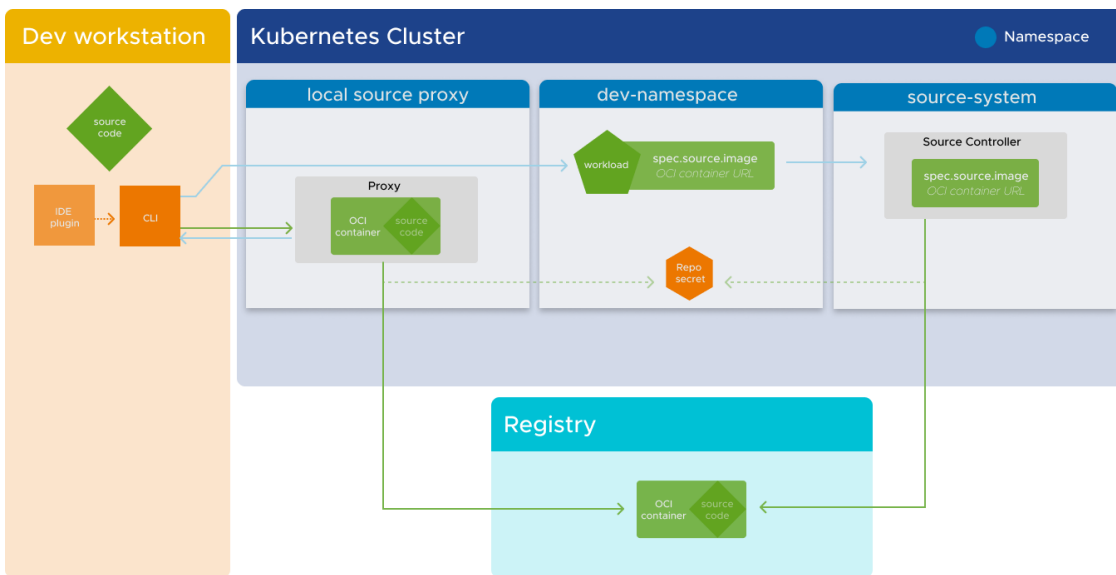

By removing the necessity for specific registry information and credentials, Local Source Proxy simplifies the developer experience. This enables developers to focus on developing their applications instead of managing registry-related complexities.

Overview of Local Source Proxy

Local Source Proxy (LSP) offers developers a secure and user-friendly approach to seamlessly upload their local source code to a Tanzu Application Platform cluster. This enables developers to navigate their code smoothly through a predefined production pathway using supply chains.

With Local Source Proxy, developers can:

- Interact with external registries without needing to know registry specifics, such as endpoints, credentials, and certificates. This eliminates the burden of platform and app operators having to distribute registry credentials to developer workstations.
- Deploy their workloads from a local source through any mechanism, including IDE extensions, without providing the source image location. Developers can seamlessly deploy their applications without managing registry credentials on their local machines or keeping track of where their local source is uploaded.

Consequently, the `--source-image` flag in the Apps CLI becomes optional, and there is no longer a need for Docker registry credentials on the developer’s local machine. Local Source Proxy abstracts these details, making deployment more streamlined and user-friendly for developers.

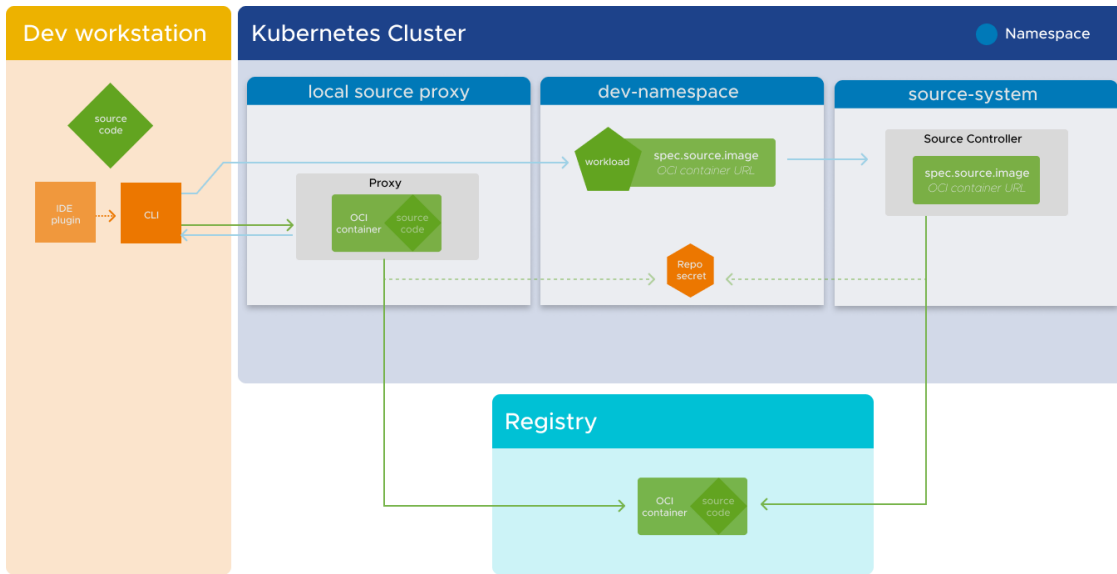

By removing the necessity for specific registry information and credentials, Local Source Proxy simplifies the developer experience. This enables developers to focus on developing their applications instead of managing registry-related complexities.

Design of Local Source Proxy

Local Source Proxy (LSP) serves as a proxy registry server with OCI (Open Container Initiative) compatibility. Its main purpose is to handle image push requests by forwarding them to an external registry server, which is configured through the `tap-values.yaml` file.

Local Source Proxy takes care of authentication and authorization against the external registry provider internally. This ensures that the external registry remains transparent to the user.

By functioning as a proxy registry server, Local Source Proxy simplifies the process of interacting with external registry servers. Local Source Proxy provides a centralized and transparent approach for image push requests, handling authentication and authorization seamlessly.

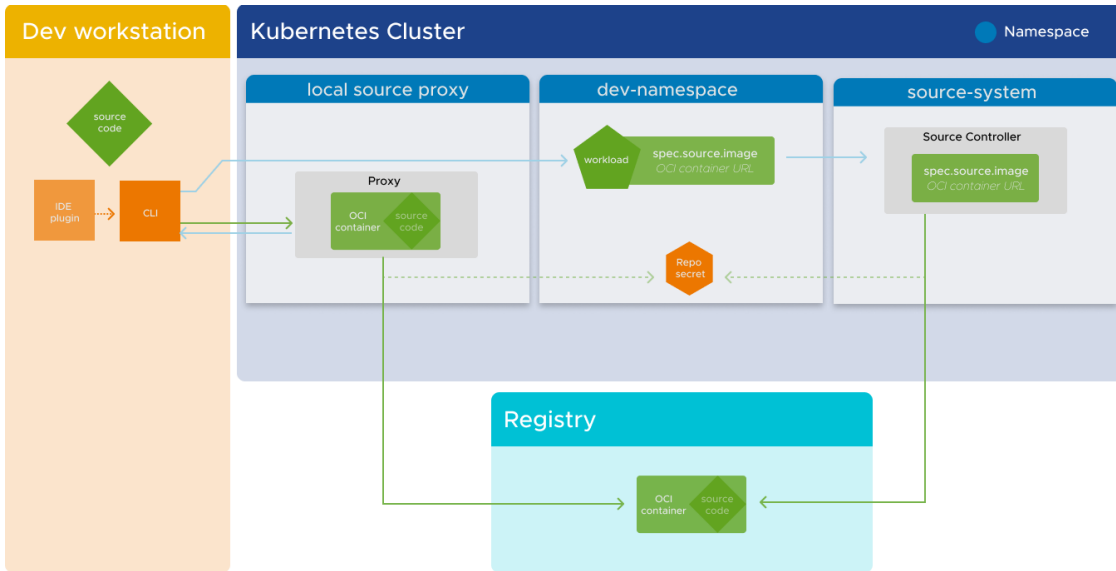

If you don't use Local Source Proxy, your developer workstation requires more configuration, and the process of interacting with external registry servers is more complicated.

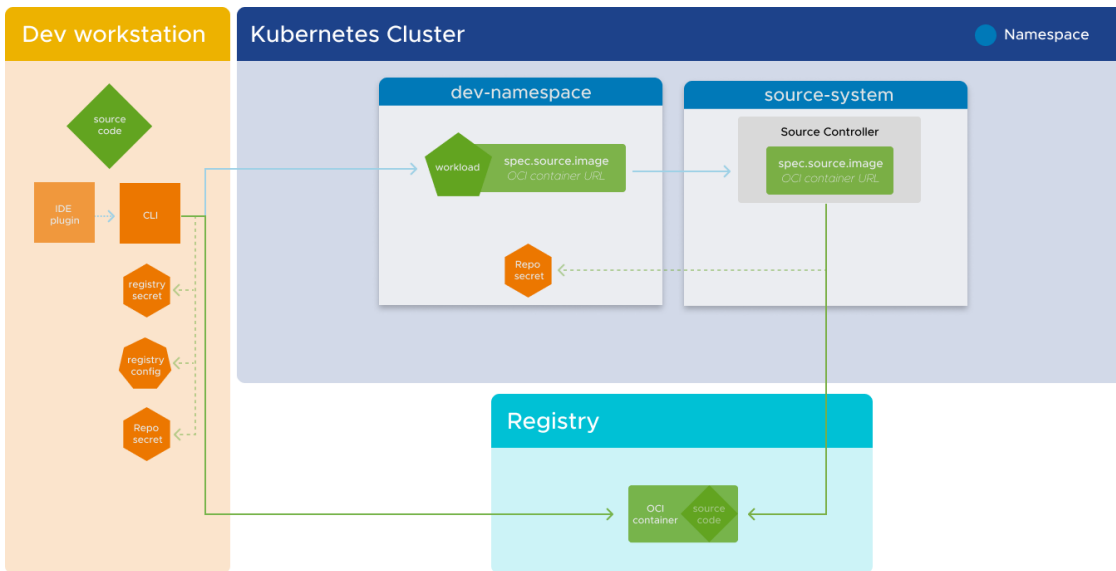

The Apps CLI generates requests that adhere to the OCI distribution standard to push artifacts to Local Source Proxy instances. The Kubernetes API server handles user authentication and authorization.

Consequently this default mechanism becomes the primary way to push a developer's local source code to the Tanzu Application Platform cluster. This renders the `--source-image` flag optional. By leveraging Local Source Proxy, developers can seamlessly deploy their code without explicitly specifying the source image.

However, the system remains backward-compatible to accommodate different scenarios.

The `local-source-proxy` mechanism is completely bypassed if either of the following is true:

- The `--source-image` flag is provided
- The workload has a defined source image that Local Source Proxy didn't set

This ensures compatibility with existing workflows and allows developers to continue using their preferred methods for deployment.

By default, the `iterate` and `full` profiles include the installation of this package. To suppress this behavior, exclude the package by adding `local-source-proxy.apps.tanzu.vmware.com` to the list of

excluded packages. For how to do so, see [Exclude packages from a Tanzu Application Platform profile](#).

Prerequisites for Local Source Proxy

You need the following prerequisites before you can install Local Source Proxy (LSP):

- The Tanzu Application Platform profile `full` or `iterate`. For more information, see [Components and installation profiles for Tanzu Application Platform](#).
- A registry server with a repository capable of accepting and hosting OCI artifacts, such as Google Artifact Registry, JFrog Artifactory, Harbor, Elastic Container Registry, and so on.
- Either IaaS-specific trust for Kubernetes service accounts to access the registry, or a secret with sufficient privileges to push and pull artifacts from that repository.
- If you install Local Source Proxy on a Kubernetes cluster that a cloud provider manages (such as EKS, AKS, or GKE), ensure that TCP port 5002 is open between control plane nodes and your worker nodes.

The rest of this topic tells you how to obtain these prerequisites.

Using Tanzu CLI

All registries except ECR can use the following code:

```
tanzu secret registry add lsp-push-credentials \
--username USERNAME-VALUE --password PASSWORD-VALUE \
--server REGISTRY-SERVER \
--namespace tap-install --yes
```

Declarative syntax

For declarative syntax:

```
---
apiVersion: v1
kind: Secret
metadata:
  name: lsp-push-credentials
  namespace: tap-install
type: kubernetes.io/dockerconfigjson
stringData:
  .dockerconfigjson: BASE64-ENCODED-DOCKER-CONFIG-JSON
```

The `dockerconfigjson` structure is as follows:

```
{"auths":{"REGISTRY-SERVER":{"username":"USERNAME-VALUE","password":"PASSWORD-VALUE"}}
```

If you're using the Tanzu Application Platform GitOps installer using Secrets OperationS (SOPS), after using SOPS to encrypt the secret put the secret in the `clusters/CLUSTER-NAME/cluster-config/config/lsp` directory in your GitOps repository.

If you're using the Tanzu Application Platform GitOps installer using ESO, create a secret as follows:

```
#@ load("@ytt:data", "data")
#@ load("@ytt:json", "json")

#@ def config():
#@   return {
#@     "auths": {
```

```

#@     data.values.tap_value.{path-to-registry-host}: {
#@     "username": data.values.tap_values.{path-to-registry-username},
#@     "password": data.values.tap_values.{path-to-registry-password}
#@     }
#@   }
#@ }
#@ end
---
apiVersion: v1
kind: Secret
metadata:
  name: lsp-push-credentials
  namespace: tap-install
type: kubernetes.io/dockerconfigjson
stringData:
  .dockerconfigjson: #@ json.encode(config())

```

The procedure you use to obtain a secret with sufficient privileges depends on whether your registry is Elastic Container Registry (ECR) or something else.

Using AWS

If you're using Elastic Container Registry as your registry, you must create the container repository ahead of time. Additionally you require an AWS Identity Access and Management (IAM) role Amazon Resource Name (ARN) that possesses the necessary privileges to push and pull artifacts to the ECR repository. This is limited in scope to the service account for Local Source Proxy.

1. Export the variables by running:

```

export AWS_ACCOUNT_ID=012345678901 # Your AWS account ID
export AWS_REGION=us-west-2       # The AWS region you are going to deploy
to
export EKS_CLUSTER_NAME=tap-on-aws # The name of your Elastic Kubernetes Ser
vice Cluster

```

2. Create the repository by running:

```
aws ecr create-repository --repository-name tap-lsp --region $AWS_REGION
```

3. Output the files, and then use the policy documents to create the IAM roles, by running:

```

export OIDCPROVIDER=$(aws eks describe-cluster --name $EKS_CLUSTER_NAME --reg
ion $AWS_REGION \
--output json | jq '.cluster.identity.oidc.issuer' | tr -d '"' | sed 's/http
s://\\\\/')

cat << EOF > local-source-proxy-trust-policy.json
{
  "Version": "2012-10-17",
  "Statement": [
    {
      "Effect": "Allow",
      "Principal": {
        "Federated": "arn:aws:iam::${AWS_ACCOUNT_ID}:oidc-provider/${OI
DCPROVIDER}"
      },
      "Action": "sts:AssumeRoleWithWebIdentity",
      "Condition": {
        "StringEquals": {
          "${OIDCPROVIDER}:aud": "sts.amazonaws.com"
        },
        "StringLike": {

```

```

        "${OIDCPROVIDER}:sub": [
            "system:serviceaccount:tap-local-source-system:proxy-manager"
        ]
    }
}
EOF

cat << EOF > local-source-proxy-policy.json
{
    "Version": "2012-10-17",
    "Statement": [
        {
            "Action": [
                "ecr:GetAuthorizationToken"
            ],
            "Resource": "*",
            "Effect": "Allow",
            "Sid": "TAPLSPGlobal"
        },
        {
            "Effect": "Allow",
            "Action": [
                "ecr:BatchCheckLayerAvailability",
                "ecr:GetDownloadUrlForLayer",
                "ecr:GetRepositoryPolicy",
                "ecr:DescribeRepositories",
                "ecr:ListImages",
                "ecr:DescribeImages",
                "ecr:BatchGetImage",
                "ecr:GetLifecyclePolicy",
                "ecr:GetLifecyclePolicyPreview",
                "ecr:ListTagsForResource",
                "ecr:DescribeImageScanFindings",
                "ecr:InitiateLayerUpload",
                "ecr:UploadLayerPart",
                "ecr:CompleteLayerUpload",
                "ecr:PutImage"
            ],
            "Resource": [
                "arn:aws:ecr:${AWS_REGION}:${AWS_ACCOUNT_ID}:repository/tap-ls
p"
            ],
            "Sid": "TAPLSPScoped"
        }
    ]
}
EOF

# Create the TAP Local Source Proxy Role
aws iam create-role --role-name tap-local-source-proxy --assume-role-policy-document \
file://local-source-proxy-trust-policy.json
# Attach the Policy to the tap-local-source-proxy Role created above
aws iam put-role-policy --role-name tap-local-source-proxy --policy-name tapLocalSourcePolicy \
--policy-document file://local-source-proxy-policy.json

```

Using a secret with pull privileges only

You can use a secret with only pull privileges if you prefer to have a dedicated credential with a least-privilege policy, specifically for downloading artifacts instead of reusing credentials with higher privileges.

The secret containing this credential is distributed across developer namespaces by using the Secretgen `SecretExport` resource. Namespace Provisioner automatically imports it to the developer namespace. However, for development purposes, you can skip this step and use the same secret for both pushing and pulling artifacts.

To use a secret with pull privileges only, run:

```
# For all registries except ECR
tanzu secret registry add lsp-pull-credentials \
--username USERNAME-VALUE --password 'PASSWORD-VALUE' \
--server REGISTRY-SERVER \
--namespace tap-install --yes
```

Install Local Source Proxy

This topic tells you how to install and customize Local Source Proxy (LSP).

Prerequisites

Meet the [prerequisites](#) before attempting to install Local Source Proxy.

Install

Install Local Source Proxy by updating `tap-values.yaml` with the following details:

```
local_source_proxy:
  repository: REGISTRY-SERVER/REPOSITORY-PATH

  push_secret:
    name: lsp-push-credentials
    namespace: tap-install
    create_export: true

  pull_secret:
    name: lsp-pull-credentials
    namespace: tap-install
    create_export: true
```

Where:

- `local_source_proxy.repository` is required. This is the repository where all your source code will be uploaded. Examples of commonly used repositories include:
 - Harbor, which has the form `my-harbor.io/my-project/local-source`.
 - Docker Hub, which has the form `my-dockerhub-user/local-source` or `index.docker.io/my-user/local-source`.
 - Google Artifact Registry, which has the form `MY-REGISTRY-REGION-docker.pkg.dev/my-project/local-source/image`.
 - Google Cloud Registry, which has the form `gcr.io/my-project/local-source`.

You are not restricted to using a repository from this list.

- `local_source_proxy.push_secret` is required. This is the push secret reference that has the permission to push artifacts to the repository mentioned in `local_source_proxy.repository`.
- `local_source_proxy.push_secret.create_export` is `false` by default. Set it as `true` to tell Local Source Proxy to create a `SecretExport` for the referenced secret and own it. Do one

of the following if you're reusing the secret that already existed in your cluster:

- o Ensure that it's not exported by any other process
 - o Set this flag to `false` and ensure that it is exportable to the `tap-local-source-system` namespace by using a `SecretExport` resource
- `local_source_proxy.pull_secret` is optional, but recommended for production. Use the credential that has pull permissions. You can re-use `lsp-push-credentials` that have pull access if you chose not to create a separate request for pulling.
- `local_source_proxy.pull_secret.create_export` is `false` by default. Set it as `true` to tell Local Source Proxy to create a `SecretExport` for the referenced secret and own it.

In a production installation of Tanzu Application Platform, do not share the registry secret that has write access across developer namespaces. Instead, distribute a separate registry secret that only has read access.

In such cases, `pull_secret` can be specified, and `source-controller` uses the `pull_secret` to pull source artifacts for deployment.

The `pull_secret` uses a Docker registry credentials secret referenced by its `name` and `namespace`.

To enable the Tanzu Application Platform installer to automatically create a `SecretExport` resource in the specified `namespace` for exporting the secret to developer namespaces, set `pull_secret.create_export` to `true`.

Alternatively, if `create_export` is set to `false`, you must manually create the `SecretExport` resource in the referenced `namespace`.

Do one of the following if you're reusing the secret that already existed in your cluster:

- Ensure that it's not exported by any other process
- Set this flag to `false` and ensure that it is exportable to developer namespaces by using a `SecretExport` resource

Create the SecretExport resource

If you left `create_export` as `true` in `tap-values.yaml`, skip this procedure. If you set the `create_export` to `false`, apply the following YAML in `tap-values.yaml` to create the `SecretExport` resource:

Use this YAML for `push-secret`:

```
---
apiVersion: secretgen.carvel.dev/v1alpha1
kind: SecretExport
metadata:
  name: lsp-push-credentials
  namespace: tap-install
spec:
  toNamespace: tap-local-source-system
```

Use this YAML for `pull-secret`:

```
---
apiVersion: secretgen.carvel.dev/v1alpha1
kind: SecretExport
metadata:
  name: lsp-pull-credentials
  namespace: tap-install
spec:
  toNamespace: *
```

Customize the installation

You can configure specific Local Source Proxy resources by using the following properties in `tap-values.yaml`, as described in the following sections.

Override default RBAC permissions to access the proxy service

When this section is not provided, the default behavior is to employ the `system:authenticated` group as the chosen option.

```
local_source_proxy:
  rbac_subjects_for_proxy_access:
  - kind: "Group"
    name: "system:authenticated"
    apiGroup: "rbac.authorization.k8s.io"
```

To grant access for a specific user or group to push images through Local Source Proxy, use the `rbac_subjects_for_proxy_access` property in the `local_source_proxy` configuration:

- Set `rbac_subjects_for_proxy_access.kind` to either "User" or "Group".
- Set `rbac_subjects_for_proxy_access.name` to the user name or group name that requires authorization.
- Set `rbac_subjects_for_proxy_access.apiGroup` to either `rbac.authorization.k8s.io` or the custom `apiGroup` associated with the specified kind.

For more information about RoleBinding, see the [Kubernetes documentation](#). These settings enable you to customize RBAC permissions for accessing the proxy service according to your specific user or group requirements.



Important

If you define the `rbac_subjects_for_proxy_access` configuration in the `tap-values.yaml` file, it supersedes the default `system:authenticated` role binding with the one specified in `tap-values.yaml`. This allows platform operators to restrict access to the proxy server exclusively to a predefined set of groups, users, or service accounts.

For example:

```
local_source_proxy:
  rbac_subjects_for_proxy_access:
  - kind: "Group"
    name: "alpha-group"
    apiGroup: "rbac.authorization.k8s.io"
```

Override default CPU and memory limits for controller pods

To configure the compute resource limits for the Local Source Proxy server, you can use the `proxy_configuration` section within the `local_source_proxy` configuration in `tap-values.yaml`.

Specify the following properties to set the resource limits:

- `proxy_configuration.limits.cpu`: Set the maximum CPU limit for the Local Source Proxy server.
- `proxy_configuration.limits.memory`: Configure the maximum memory limit available for the Local Source Proxy server.

For example:

```
local_source_proxy:
  proxy_configuration:
    limits:
      cpu: 500m
      memory: 100Mi
```

Use AWS Identity and Access Management (IAM) roles for ECR

If your Tanzu Application Platform installation is both

- On AWS with Amazon Elastic Kubernetes Service (EKS)
- Using the AWS Elastic Container Registry (ECR) for storing local source code

then write the IAM role that has push and pull permissions for `aws_iam_role_arn`. For example:

```
local_source_proxy:
  repository: 123456789012.dkr.ecr.us-east-1.amazonaws.com/local-source
  push_secret:
    aws_iam_role_arn: arn:aws:iam::123456789012:role/tap-local-source-proxy
```

You specify this IAM role in `aws_iam_role_arn` to assign it to the Kubernetes service account that the Local Source Proxy server uses. For the steps to create an IAM role and add the Amazon Resource Name (ARN) to the Kubernetes service account used by Local Source Proxy, see [Prerequisites for Local Source Proxy](#).

Doing this allows the Local Source Proxy server to handle incoming image push requests with the appropriate IAM role-based permissions.

Increase or decrease the number of replicas

By default, the Local Source Proxy instance is configured with one replica in the deployment. You can increase or decrease the number of replicas by changing the `proxy_configuration.replicas` value.

For example:

```
local_source_proxy:
  proxy_configuration:
    replicas: 3
```

Specify CA certificate data for registries that use self-signed certificates

If you have a custom TLS certificate or a self-signed certificate for your registry server, and it uses a private certificate authority, you can set up the public CA certificate data by providing the necessary configuration under `local_source_proxy.ca_cert_data` in the `tap.values.yaml` file.

This allows you to provide the necessary certificate information for secure communication with the registry server. For example:

```
local_source_proxy:
  ca_cert_data: |
    -----BEGIN CERTIFICATE-----
    ...
    -----END CERTIFICATE-----
```

Local Source Proxy detects when `shared.ca_cert_data` is provided in `tap-values.yaml` and imports the CA certificate data from that key.

Troubleshoot Local Source Proxy

This topic helps you troubleshoot issues you might encounter with Local Source Proxy (LSP).

View Local Source Proxy server logs

Symptom

You encounter an error and need to view the Local Source Proxy server logs to investigate it.

Solution

Run

```
kubectl -n tap-local-source-system logs deployments/local-source-proxy
```

Use `-f` to follow the log output.

View Apps CLI health messages

Symptom

You need to read the Apps CLI health messages to assess the status of Local Source Proxy and its connectivity with the upstream repository.

Solution

Run

```
tanzu apps lsp health
```

Example:

```
$ tanzu apps lsp health
user_has_permission: true
reachable: true
upstream_authenticated: true
overall_health: true
message: All health checks passed
```

User does not have RBAC permission to list services

Symptom

You encounter any of these error messages:

```
$ tanzu apps workload apply
Error: Either Local Source Proxy is not installed on the Cluster or you don't have per
missions to access it
Reason: The current user does not have permission to access the local source proxy.
Messages:
- services "http:local-source-proxy:5001" is forbidden: User "abc@example.com" cannot
get resource "services/proxy" in API group "" in the namespace "tap-local-source-syste
m": requires one of ["container.services.proxy"] permission(s).
```

```
$ tanzu apps lsp health
user_has_permission: false
```

```

reachable: false
upstream_authenticated: false
overall_health: false
message: |-
  The current user does not have permission to access the local source proxy.
Messages:
  - services "http:local-source-proxy:5001" is forbidden: User "abc@example.com" cannot get resource "services/proxy" in API group "" in the namespace "tap-local-source-system": requires one of ["container.services.proxy"] permission(s).

```

Cause

Typically, this situation arises when a custom user or group is specified within the `rbac_subjects_for_proxy_access` section of `tap-values.yaml`.

Solution

Ensure that the user or group listed is valid. For more information about overriding default RBAC permissions to access the proxy service, see [Override default RBAC permissions to access the proxy service](#).

Missing repository in Tanzu Application Platform values

Symptom

You encounter one of these error messages:

```

$ tanzu apps workload apply
Error: Local source proxy failed to upload source to the repository
Reason: Local source proxy is not healthy.
Messages:
- registry server configuration in the cluster is invalid

```

```

$ tanzu apps lsp health
user_has_permission: true
reachable: true
upstream_authenticated: false
overall_health: false
message: |
  Local source proxy is not healthy.
Messages:
- registry server configuration in the cluster is invalid

```

Cause

The cause might be that `tap-values.yaml` lacks a valid value for the repository.

Solution

Add a valid repository value to `tap-values.yaml` and wait for the app reconciliation to complete.

Missing or misconfigured registry secret

Symptom

You encounter one of these error messages:

```

$ tanzu apps workload apply
Error: Local source proxy failed to upload source to the repository

```

```
Reason: Local source proxy was unable to authenticate against the target registry.
Messages:
- GET https://gcr.io/v2/token?scope=repository:abc-playground/lsp-source:pull,push&service=gcr.io: UNAUTHORIZED: You don't have the needed permissions to perform this operation, and you may have invalid credentials. To authenticate your request, follow the steps in: https://cloud.google.com/container-registry/docs/advanced-authentication
```

```
$ tanzu apps lsp health
user_has_permission: true
reachable: true
upstream_authenticated: false
overall_health: false
message: |-
  Local source proxy was unable to authenticate against the target registry.
  Messages:
  - GET https://gcr.io/v2/token?scope=repository:abc-playground/lsp-source:pull,push&service=gcr.io: UNAUTHORIZED: You don't have the needed permissions to perform this operation, and you may have invalid credentials. To authenticate your request, follow the steps in: https://cloud.google.com/container-registry/docs/advanced-authentication
```

Cause

Potential causes include:

- A missing registry secret:
 - `push_secret` information is not available in the `local_source_proxy` section of `tap-values.yaml`.
 - `image_registry.secret` information is not available in the `shared` section of `tap-values.yaml`.
- If `push_secret` is used, the secret was not exported to the Local Source Proxy namespace. The credentials used in the secret do not match the configured external registry.

Solution

1. Ensure that at least one of the following entries is found in `tap-values.yaml`:
 - `push_secret` information in the `local_source_proxy` section
 - `image_registry.secret` information in the `shared` section
2. If `push_secret` is used, make sure that it can be exported to the Local Source Proxy namespace.
3. Ensure that the credentials used in the secret match the configured external registry.

Invalid credentials

Symptom

You encounter one of these error messages:

```
$ tanzu apps workload apply
Error: Local source proxy failed to upload source to the repository
Reason: Local source proxy was unable to authenticate against the target registry.
Messages:
- GET https://gcr.io/v2/token?scope=repository:abc-playground/lsp-source:pull,push&service=gcr.io: UNAUTHORIZED: Not Authorized.
```

```
$ tanzu apps lsp health # when using Harbor
user_has_permission: true
reachable: true
upstream_authenticated: false
overall_health: false
message: |-
  Local source proxy was unable to authenticate against the target registry.
Messages:
- 401 Unauthorized
```

```
$ tanzu apps lsp health # when using GCR
user_has_permission: true
reachable: true
upstream_authenticated: false
overall_health: false
message: |-
  Local source proxy was unable to authenticate against the target registry.
Messages:
- GET https://gcr.io/v2/token?scope=repository:abc-playground/lsp-source:pull,push&service=gcr.io: UNAUTHORIZED: Not Authorized.
```

Cause

The cause is the use of invalid credentials.

Solution

Change the credentials used in the secret to match those in the configured external registry.

Local Source Proxy doesn't automatically detect changes to `podspec`

Symptom

Local Source Proxy doesn't automatically detect changes to `podspec`.

Cause

AWS Elastic Container Registry (ECR) is configured as the external registry in `tap-values.yaml`.

Solution

Delete the old pods so that the new pods can mount the expected `podspec`, enabling access to the registry through the Identity and Access Management (IAM) role Amazon Resource Name (ARN).

Error: unknown command "lsp" for "apps"

Symptom

When running `tanzu apps lsp health` the CLI returns the error message

```
Error: unknown command "lsp" for "apps"
```

Cause

Tanzu CLI and the apps plug-in are out of date.

Solution

1. Install [Tanzu CLI v0.12.0 or later](#).
2. Upgrade the apps plug-in by running:

```
tanzu plugin upgrade apps
```

Error: i/o timeout

Symptom

When you run `tanzu apps lsp health` or `tanzu apps workload apply`, after a few minutes the CLI returns the following error message:

```
connect: i/o timeout
```

Cause

TCP port 5002 is not open between your control plane nodes and your worker nodes.

Solution

1. Open the port.
2. Run the command again.

Reference for Local Source Proxy

This topic gives you reference information for Local Source Proxy (LSP).

Default resources

Local Source Proxy comes with the standard `iterate` and `full` Tanzu Application Platform installation profiles. The default set of resources provisioned in a namespace is mostly predefined. However, certain resources are defined based on the configuration entries in `tap-values.yaml` under the `local_source_proxy` section.

For more information about installation profiles, see [Installation profiles in Tanzu Application Platform](#).

The following table shows the list of resources that are templated in the installation of applicable profiles:

| Namespace | Kind | Name | Reconcile |
|--|--------------|-------------------------------------|-----------|
| tap-local-source-system | Service | local-source-proxy | No |
| tap-local-source-system | Secret | local-source-proxy-values | Yes |
| local_source_proxy.push_secret.namespace (tap-values.yaml) | SecretExport | local_source_proxy.push_secret.name | Yes |
| tap-local-source-system | SecretImport | local_source_proxy.push_secret.name | Yes |
| tap-local-source-system | Deployment | local-source-proxy | No |
| tap-local-source-system | Role | local-source-proxy-manager | No |
| tap-local-source-system | RoleBinding | proxy-manager | No |

| Namespace | Kind | Name | Reconcile |
|-------------------------|----------------|----------------------------|-----------|
| tap-local-source-system | ServiceAccount | proxy-manager | No |
| tap-local-source-system | Role | push-artifact | No |
| tap-local-source-system | RoleBinding | service-proxy-role-binding | Yes |

Overview of Namespace Provisioner

Namespace Provisioner provides a secure, automated way for you to provision namespaces with the resources and namespace-level privileges required for your workloads to function as intended in Tanzu Application Platform (commonly known as TAP).

Description

Namespace Provisioner enables platform operators to add additional customized namespace-scoped resources using GitOps to meet their organization’s requirements and provides continuous reconciliation using the kapp-controller to maintain the desired state of the namespace-scoped resources.

Namespace Provisioner enables operators that are new to Kubernetes to automate the provisioning of multiple developer namespaces in a shared cluster. For organizations that have already adopted Kubernetes, Namespace Provisioner is also compatible with existing Kubernetes tooling.

Modes

Use Namespace Provisioner with one of the following modes:

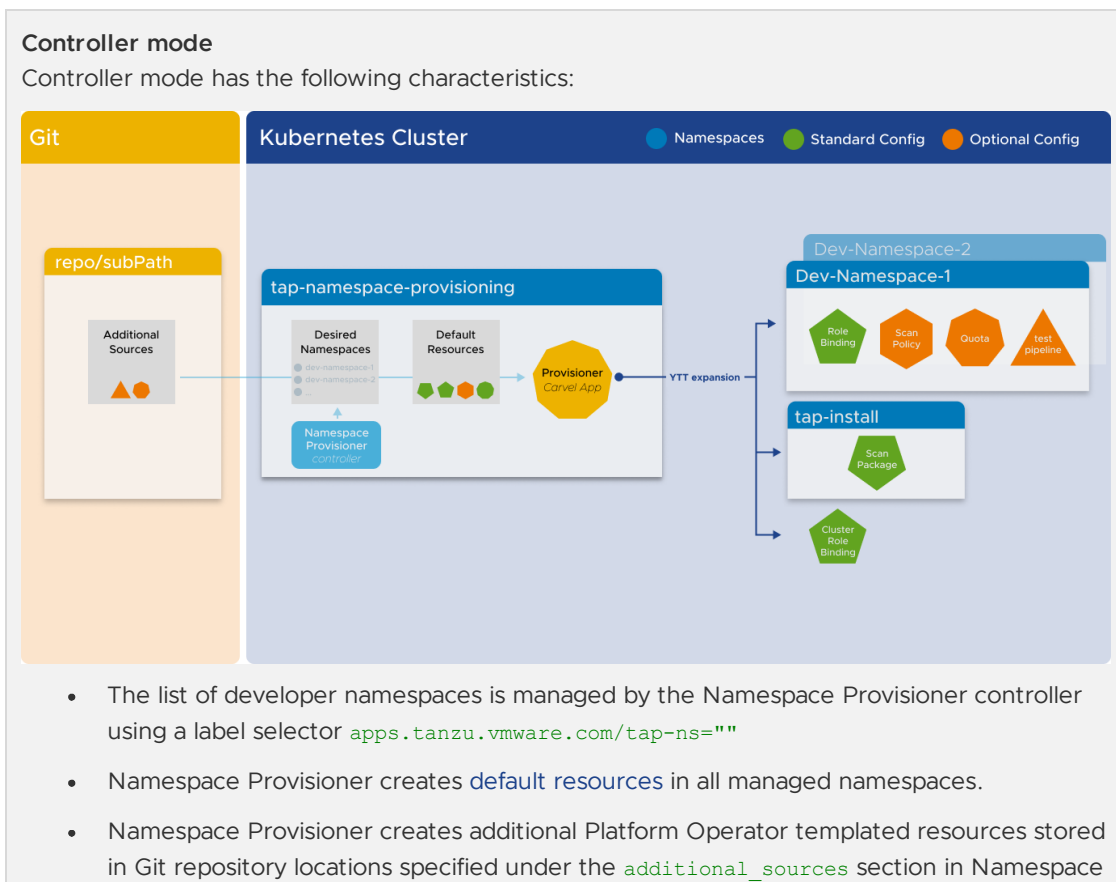

Provisioner configuration. For more information, see [Customize Installation of Namespace Provisioner](#).

GitOps mode

Gitops mode has the following characteristics

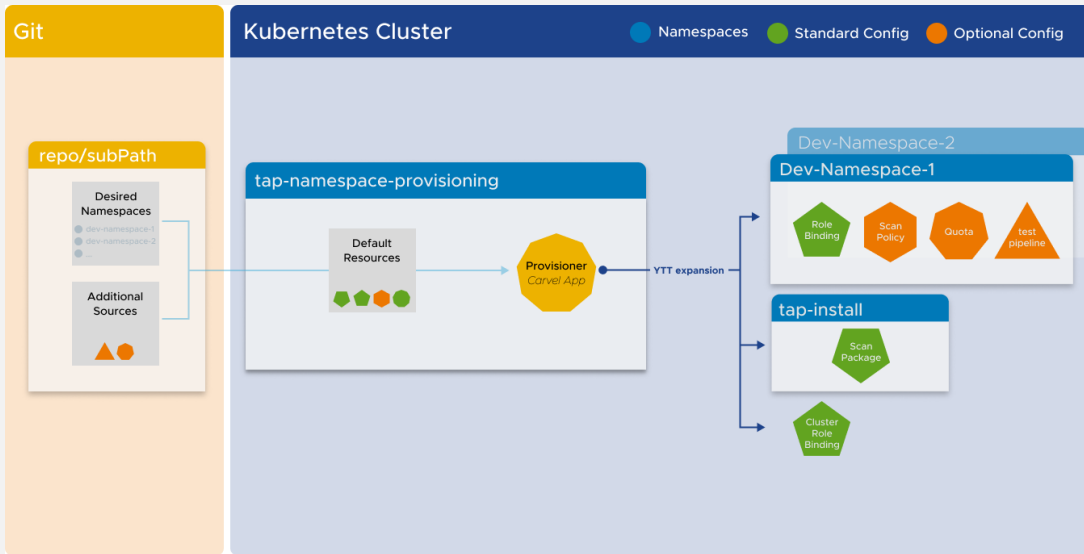

- The list of developer namespaces is managed in a Git repository that is specified in the `gitops_install` section of the Namespace Provisioner configuration.
- Namespace Provisioner creates **default resources** that are shipped Out of the Box in all managed namespaces.
- Namespace Provisioner creates additional Platform Operator templated resources stored in Git repositories specified under `additional_sources` in Namespace Provisioner configuration. For more information, see [Customize Installation of Namespace Provisioner](#).

Provisioner Carvel application



Namespace Provisioner consists of a Carvel application called `provisioner` that facilitates the creation of resources in the managed developer namespaces. The `provisioner` application uses ytt

to templize a set of resources into installations in multiple namespaces.

Desired namespaces

The following section describes how the list of desired developer namespaces is managed in controller and GitOps modes.

Controller mode

In controller mode, the list of desired namespaces used by the `provisioner` application to create resources in, is maintained in the `desired-namespaces` ConfigMap. This ConfigMap is managed by the `Namespace Provisioner controller` and it provides a declarative way to indicate which namespaces should be populated with resources. The ConfigMap consists of a list of namespace objects, with a required `name` parameter, and optional additional parameters which are used as `data.values` for customizing defined resources.

For example,

```
---
apiVersion: v1
kind: ConfigMap
metadata:
  name: desired-namespaces
  namespace: tap-namespace-provisioning
  annotations:
    kapp.k14s.io/create-strategy: fallback-on-update
    namespace-provisioner.apps.tanzu.vmware.com/no-override: "" #! This annotation tells the provisioner app to not override this configMap as this is your desired state.
data:
  namespaces.yaml: |
    #@data/values
    ---
    namespaces:
    - name: dev-ns1
      # additional parameters about dev-ns1 added via label/annotations or GitOps
    - name: dev-ns2
      # additional parameters about dev-ns1 added via label/annotations or GitOps
```

GitOps mode

In the GitOps mode, the list of desired namespaces used by the `provisioner` application to create resources in, is maintained in a Git repository as a ytt data values file as shown in [this sample file](#). This file provides a declarative way to indicate which namespaces should be populated with resources. For more information, see the [Options if using GitOps](#) section in [Customize Install](#).

Namespace Provisioner controller

The Namespace Provisioner controller (controller) is installed by default and manages the content contained in the `desired-namespaces` ConfigMap. The controller watches namespaces in the cluster and updates the `desired-namespaces` ConfigMap with a list of all namespaces that match the namespace label selector. The default namespace label selector is `apps.tanzu.vmware.com/tap-ns`. For more information, see [Use a different label selector than default](#).

Overview of Namespace Provisioner

Namespace Provisioner provides a secure, automated way for you to provision namespaces with the resources and namespace-level privileges required for your workloads to function as intended in Tanzu Application Platform (commonly known as TAP).

Description

Namespace Provisioner enables platform operators to add additional customized namespace-scoped resources using GitOps to meet their organization’s requirements and provides continuous reconciliation using the kapp-controller to maintain the desired state of the namespace-scoped resources.

Namespace Provisioner enables operators that are new to Kubernetes to automate the provisioning of multiple developer namespaces in a shared cluster. For organizations that have already adopted Kubernetes, Namespace Provisioner is also compatible with existing Kubernetes tooling.

Modes

Use Namespace Provisioner with one of the following modes:



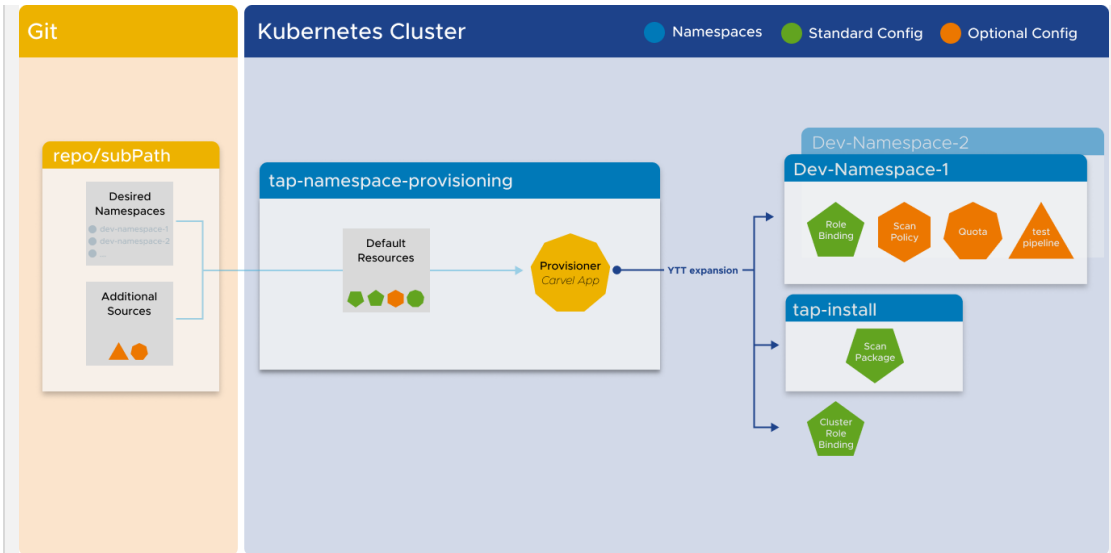

- The list of developer namespaces is managed in a Git repository that is specified in the `gitops_install` section of the Namespace Provisioner configuration.
- Namespace Provisioner creates **default resources** that are shipped Out of the Box in all managed namespaces.
- Namespace Provisioner creates additional Platform Operator templated resources stored in Git repositories specified under `additional_sources` in Namespace Provisioner configuration. For more information, see [Customize Installation of Namespace Provisioner](#).

Provisioner Carvel application



Namespace Provisioner consists of a Carvel application called `provisioner` that facilitates the creation of resources in the managed developer namespaces. The `provisioner` application uses ytt to templatize a set of resources into installations in multiple namespaces.

Desired namespaces

The following section describes how the list of desired developer namespaces is managed in controller and GitOps modes.

Controller mode

In controller mode, the list of desired namespaces used by the `provisioner` application to create resources in, is maintained in the `desired-namespaces` ConfigMap. This ConfigMap is managed by the `Namespace Provisioner controller` and it provides a declarative way to indicate which namespaces should be populated with resources. The ConfigMap consists of a list of namespace objects, with a required `name` parameter, and optional additional parameters which are used as `data.values` for customizing defined resources.

For example,

```
---
apiVersion: v1
kind: ConfigMap
metadata:
  name: desired-namespaces
  namespace: tap-namespaces-provisioning
  annotations:
    kapp.k14s.io/create-strategy: fallback-on-update
    namespace-provisioner.apps.tanzu.vmware.com/no-override: "" #! This annotation tells the provisioner app to not override this configMap as this is your desired state.
data:
  namespaces.yaml: |
    #@data/values
    ---
    namespaces:
    - name: dev-ns1
      # additional parameters about dev-ns1 added via label/annotations or GitOps
    - name: dev-ns2
      # additional parameters about dev-ns1 added via label/annotations or GitOps
```

GitOps mode

In the GitOps mode, the list of desired namespaces used by the `provisioner` application to create resources in, is maintained in a Git repository as a ytt data values file as shown in [this sample file](#). This file provides a declarative way to indicate which namespaces should be populated with resources. For more information, see the [Options if using GitOps](#) section in [Customize Install](#).

Namespace Provisioner controller

The Namespace Provisioner controller (controller) is installed by default and manages the content contained in the `desired-namespaces` ConfigMap. The controller watches namespaces in the cluster and updates the `desired-namespaces` ConfigMap with a list of all namespaces that match the namespace label selector. The default namespace label selector is `apps.tanzu.vmware.com/tap-ns`. For more information, see [Use a different label selector than default](#).

Get started with Namespace Provisioner

This topic provides a list of topics to help you get started with Namespace Provisioner.

[Provision Developer Namespaces](#)

[Customize Installation of Namespace Provisioner](#)

Setup for OOTB Supply Chains

Provision developer namespaces in Namespace Provisioner

This topic tells you how to use Namespace Provisioner to provision developer namespaces in Tanzu Application Platform (commonly known as TAP).

Prerequisite

- The Namespace Provisioner package is installed and reconciled.
- The registry-credential secret referenced by the Supply chain components for pulling and pushing images is added to **tap-install** and exported to all namespaces.

Example secret creation, exported to all namespaces:

```
tanzu secret registry add registry-credentials --server REGISTRY-SERVER --username REGISTRY-USERNAME --password REGISTRY-PASSWORD --export-to-all-namespaces --yes --namespace tap-install
```



Important

Namespace Provisioner creates a secret called registries-credentials in each managed namespace which is a placeholder secret filled indirectly by [secretgen-controller](#) with all the registry credentials exported for that managed namespace.

Manage a list of developer namespaces

There are two ways to manage the list of developer namespaces that are managed by Namespace Provisioner.

Using Namespace Provisioner Controller

`tap-values.yaml` configuration example:

```
namespace_provisioner:
  controller: true
```

The imperative way is to create the namespace using `kubectl` or using other means and label it using the default selector.

1. Create a namespace using `kubectl` or any other means

```
kubectl create namespace YOUR-NEW-DEVELOPER-NAMESPACE
```

2. Label your new developer namespace with the default `namespace_selector`

`apps.tanzu.vmware.com/tap-ns=""`.

```
kubectl label namespaces YOUR-NEW-DEVELOPER-NAMESPACE apps.tanzu.vmware.com/tap-ns=""
```

- This label tells the Namespace Provisioner controller to add this namespace to the [desired-namespaces](#) ConfigMap.
- By default, the label's value can be anything, including "".

- If required, you can change the default label selector, see [Customize Installation of Namespace Provisioner](#).

3. Run the following command to verify the [default resources](#) have been created in the namespace:

```
kubectl get secrets,serviceaccount,rolebinding,pods,workload,configmap,limitrange -n YOUR-NEW-DEVELOPER-NAMESPACE
```

For example:

```
NAME                                     TYPE                                DATA  AGE
secret/app-tls-cert                     kubernetes.io/tls                  3      19s
secret/registries-credentials           kubernetes.io/dockerconfigjson    1      26s
secret/scanner-secret-ref               kubernetes.io/dockerconfigjson    1      20s

NAME                                     SECRETS  AGE
serviceaccount/default                  1        4h7m
serviceaccount/grype-scanner            2        20s

NAME                                     ROLE
AGE
rolebinding.rbac.authorization.k8s.io/default-permit-deliverable  ClusterRole
e/deliverable  26s
rolebinding.rbac.authorization.k8s.io/default-permit-workload    ClusterRole
e/workload      26s

NAME          DATA  AGE
configmap/kube-root-ca.crt  1      38h

NAME          CREATED AT
limitrange/dev-lr  2023-03-08T04:18:58Z
```

Using GitOps

The GitOps approach provides a fully declarative way to create developer namespaces managed by Namespace Provisioner.

`tap-values.yaml` configuration example:

```
namespace_provisioner:
  controller: false
  gitops_install:
    ref: origin/main
    subPath: ns-provisioner-samples/gitops-install
    url: https://github.com/vmware-tanzu/application-accelerator-samples.git
```

This GitOps configuration does the following things:

`controller: false` - the Namespace Provisioner package does not install the controller. The list of namespaces is managed in a GitOps repository instead.

The `gitops-install` directory specified as the `subPath` value includes two files:

- `desired-namespace.yaml` contains the list of developer namespaces in a ytt data.values format.
- `namespaces.yaml` contains a Kubernetes namespace object.

If you have another tool like Tanzu Mission Control or some other process that is taking care of creating namespaces for you, and you don't want a Namespace Provisioner to create the namespaces, you can delete this file from your GitOps install repository.

The `tap-values.yaml` configuration example above creates the following two namespaces: `dev` and `qa`. If these namespaces already exist in your cluster, remove them or rename the namespaces in your GitOps repository so they do not conflict with existing resources.

Run the following command to verify the `default resources` are created in the namespace:

```
kubectl get secrets,serviceaccount,rolebinding,pods,workload,configmap,limitrange -n dev
```

For example:

```
NAME                                     TYPE                                DATA  AGE
secret/app-tls-cert                     kubernetes.io/tls                  3      52s
secret/registries-credentials           kubernetes.io/dockerconfigjson    1      59s
secret/scanner-secret-ref               kubernetes.io/dockerconfigjson    1      53s

NAME          SECRETS  AGE
serviceaccount/default      1        59s
serviceaccount/grype-scanner 2        53s

NAME                                     ROLE
AGE
rolebinding.rbac.authorization.k8s.io/default-permit-deliverable  ClusterRole/deliverable  59s
rolebinding.rbac.authorization.k8s.io/default-permit-workload     ClusterRole/workload     59s

NAME          DATA  AGE
configmap/kube-root-ca.crt  1      59s

NAME          CREATED AT
limitrange/dev-lr  2023-03-08T04:22:20Z
```

For more information, see the GitOps section of [Customize Installation of Namespace Provisioner](#).

Enable additional users with Kubernetes RBAC

Namespace Provisioner does not support enabling additional users with Kubernetes RBAC. Support is planned for an upcoming release. Until Namespace Provisioner support is provided, follow the instructions in [Enable additional users with Kubernetes RBAC](#).

Customize Namespace Provisioner installation

This topic tells you how to customize a standard installation of Namespace Provisioner in Tanzu Application Platform (commonly known as TAP).

Namespace Provisioner is packaged and distributed using a set of Carvel tools. The Namespace Provisioner package is installed as part of all the standard installation profiles except the View profile. For more information about installation profiles, see [Installation profiles in Tanzu Application Platform](#).

The default set of resources provisioned in a namespace is based on a combination of the Tanzu Application Platform installation profile employed and the supply chain that is installed on the cluster. For a list of what resources are created for different profile and supply chain combinations, see the [Default Resources](#) mapping table.

To see the Namespace Provisioner Package Schema for all configurable values, run:

```
tanzu package available get namespace-provisioner.apps.tanzu.vmware.com/0.3.0 --values
-schema -n tap-install
```

Different package customization options are available depending on what method you use to manage the list of developer namespaces:

Add additional resources to your namespaces from your GitOps repository

- `additional_sources`: This is an array of Git repository locations that contain Platform Operator templated resources to create in the provisioned namespaces, in addition to the default resources. The format of the Git repository locations must follow the “fetch” section of the [kapp controller App](#) specification, and only the Git type fetch is supported.
- `additional_sources[].git` This entry can include a `secretRef` specified for providing authentication details for connecting to a private Git repository. For more information, see [Git Authentication for Private repository](#). The following parameters are available:
 - `name`: The name of the secret to be imported and used as `valuesFrom` in `kapp`.
 - `namespace`: The namespace where the secret exists.
 - `create_export`: A Boolean flag that controls the creation of a `SecretExport` resource in the namespace. The default value is `false`. If the secret is already exported, make sure that it is exported to the `tap-namespace-provisioning` namespace.
 - `path`: (**Optional**) This must start with the prefix `_ytt_lib/`. Namespace Provisioner mounts all the additional sources as a `ytt library` so it can expand the manifests in the additional sources for all managed namespaces using the logic in the expansion template. The path after the `_ytt_lib` prefix can be any string value, and must be unique across all additional sources. If you do not provide a `path`, Namespace Provisioner generates a `path` using `url` and `subPath`.



Important

Namespace Provisioner relies on `kapp-controller` for any tasks involving communication with external services, such as registries or Git repositories. When operating in air-gapped environments or other scenarios where external services are secured by a Custom CA certificate, you must configure `kapp-controller` with the CA certificate data to prevent X.509 certificate errors. For more information, see [Deploy onto Cluster](#) in the Cluster Essentials for VMware Tanzu documentation.

If the additional sources contain a resource that is scoped to a specific namespace, it is created in that namespace with a modified name that includes the developer namespace name. For example, the resource name will be “{resource name}-{developer namespace name}”.

If the additional sources include resources without any specified namespaces, and these resources are not cluster-scoped, Namespace Provisioner creates those resources in all of the namespaces it manages. However, if the resource is cluster-scoped, only a single instance of the resource is created.

Sample `tap-values.yaml` configuration:

Using Namespace Provisioner Controller

The Git repository is configured under `additional_sources`.

```
namespace_provisioner:
  controller: true
  additional_sources:
  - git:
      ref: origin/main
      subPath: ns-provisioner-samples/testing-scanning-supplychain
      url: https://github.com/vmware-tanzu/application-accelerator-samples.git
      # secretRef section is only needed if connecting to a Private Git repo
      secretRef:
        name: git-auth
        namespace: tap-install
        create_export: true
      path: _ytt_lib/testing-scanning-supplychain-setup
```

Using GitOps

The Git repository is configured under `additional_sources`.

```
namespace_provisioner:
  controller: false
  additional_sources:
  - git:
      ref: origin/main
      subPath: ns-provisioner-samples/testing-scanning-supplychain
      url: https://github.com/vmware-tanzu/application-accelerator-samples.git
      # secretRef section is only needed if connecting to a Private Git repo
      secretRef:
        name: git-auth
        namespace: tap-install
        create_export: true
      path: _ytt_lib/testing-scanning-supplychain-setup
  gitops_install:
    ref: origin/main
    subPath: ns-provisioner-samples/gitops-install
    url: https://github.com/vmware-tanzu/application-accelerator-samples.git
```

If a path is not specified in the `additional_sources` configuration, Namespace Provisioner automatically generates a path as follows: `_ytt_lib/application-accelerator-samples-git-ns-provisioner-samples-testing-scanning-supplychain-0`

For more information, see [Git Authentication for Private repository](#).

Adjust sync period of Namespace Provisioner

The `sync_period` parameter is the interval at which the Namespace Provisioner reconciles. It must be specified in the format of time + unit. The minimum allowed `sync_period` is 30 seconds. If a value lower than 30 seconds is specified in the `tap-values.yaml` file, Namespace Provisioner automatically sets the `sync_period` to 30 seconds. If no value is specified, the default `sync_period` is `1m0s`.

Sample `tap-values.yaml` configuration:

Using Namespace Provisioner Controller

Use the `sync_period` key.

```
namespace_provisioner:
  sync_period: 2m0s
```

Using GitOps

Use the `sync_period` key.

```
namespace_provisioner:
  controller: false
  sync_period: 1m0s
  gitops_install:
    ref: origin/main
    subPath: ns-provisioner-samples/gitops-install
    url: https://github.com/vmware-tanzu/application-accelerator-samples.git
```

Import user defined secrets in YAML format as ytt data.values

The `import_data_values_secrets` is an array of additional secrets in YAML format that can be imported into the Namespace Provisioner as `data.values.imported` key. Namespace Provisioner creates a `SecretImport` for each secret listed in the array in the `tap-namespace-provisioning` namespace. Alternatively, you can manually create a `SecretExport` for the same secrets and export them to the `tap-namespace-provisioning` namespace. The following parameters are available:

- `name`: The name of the secret to be imported to use as `valuesFrom` in kapp.
- `namespace`: The namespace where the secret exists.
- `create_export`: A Boolean flag that indicates whether a `SecretExport` resource is created in the namespace. The default value is `false`. If the secret is already exported, ensure that it is exported to the `tap-namespace-provisioning` namespace.



Note

The `stringData` key of the secret must have `.yaml` or `.yml` suffix.

Example secret:

```
# Format of the secret that is importable under data.values.imported
apiVersion: v1
kind: Secret
metadata:
  name: user-defined-secrets
type: Opaque
stringData:
  # Key needs to have .yaml or .yml at the end
  content.yaml: |
    key1: value1
    key2: value2
```

Sample `tap-values.yaml` configuration:

Using Namespace Provisioner Controller

The list of secrets are imported under `import_data_values_secrets`.

```
namespace_provisioner:
  controller: true
  import_data_values_secrets:
    - name: user-defined-secrets
      namespace: tap-install
      create_export: true
```

Using GitOps

The list of secrets are imported under `import_data_values_secrets`.

```
namespace_provisioner:
  controller: false
  import_data_values_secrets:
  - name: user-defined-secrets
    namespace: tap-install
    create_export: true
  gitops_install:
    ref: origin/main
    subPath: ns-provisioner-samples/gitops-install
    url: https://github.com/vmware-tanzu/application-accelerator-samples.git
```

Use AWS IAM roles

If you are installing Tanzu Application Platform on Amazon Elastic Kubernetes Service (EKS), you can use the IAM Role specified in `aws_iam_role_arn` to configure the Kubernetes service account used by the workload and the supply chain components.

Sample `tap-values.yaml` configuration:

Using Namespace Provisioner Controller

Add the AWS IAM Role to `aws_iam_role_arn`.

```
namespace_provisioner:
  controller: yes
  aws_iam_role_arn: "arn:aws:iam::123456789012:role/EKSIAMRole"
```

Using GitOps

Add the AWS IAM Role to `aws_iam_role_arn`.

```
namespace_provisioner:
  controller: false
  aws_iam_role_arn: "arn:aws:iam::123456789012:role/EKSIAMRole"
  gitops_install:
    ref: origin/main
    subPath: ns-provisioner-samples/gitops-install
    url: https://github.com/vmware-tanzu/application-accelerator-samples.git
```

Apply default parameters to all namespaces

The `default_parameters` is an array of parameters that are applied to all namespaces. Use these parameters as ytt, such as `data.values.default_parameters` for templating default and additional resources.

Sample `tap-values.yaml` configuration:

Using Namespace Provisioner Controller

Use the `default_parameters` with the desired parameter.

```
namespace_provisioner:
  controller: yes
  default_parameters:
    limits:
      default:
        cpu: 1.7
        memory: 1Gi
```

```
defaultRequest:
  cpu: 100m
  memory: 1Gi
```

Using GitOps

Use the `default_parameters` with the desired parameter.

```
namespace_provisioner:
  controller: false
  default_parameters:
    limits:
      default:
        cpu: 1.7
        memory: 1Gi
      defaultRequest:
        cpu: 100m
        memory: 1Gi
  gitops_install:
    ref: origin/main
    subPath: ns-provisioner-samples/gitops-install
    url: https://github.com/vmware-tanzu/application-accelerator-samples.git
```

Import overlay secrets

The `overlay_secrets` is a list of secrets that contains [Carvel ytt overlay](#) definitions. These overlays are applied to the resources created by the Namespace Provisioner. If the secrets are located in a different namespace, they are imported to the `namespace-provisioner` namespace.



Note

The `stringData` key of the secret must have `.yaml` or `.yml` suffix.

Sample secret with overlay to be used:

```
```yaml
cat << EOF | kubectl apply -f -
apiVersion: v1
kind: Secret
metadata:
 name: grype-package-overlay
 namespace: tap-install
 annotations:
 kapp.k14s.io/change-rule: "delete after deleting tap"
stringData:
 grype-package-overlay.yaml: |
 #@ load("@ytt:overlay", "overlay")
 #@
 #@ def matchGrypeScanners(index, left, right):
 #@ if left["apiVersion"] != "packaging.carvel.dev/v1alpha1" or left["kind"] !=
"PackageInstall":
 #@ return False
 #@ end
 #@ return "metadata" in left and "name" in left["metadata"] and left["metadat
a"]["name"].startswith("grype-scanner")
 #@ end

 #@overlay/match by=matchGrypeScanners, expects="0+"

 metadata:
 annotations:
```

```

#@overlay/match expects="0+"
ext.packaging.carvel.dev/ytt-paths-from-secret-name.0: my-grype-overlay-secret
EOF
...

```

Sample `tap-values.yaml` configuration:

### Using Namespace Provisioner Controller

The list of secrets with the overlay are set under `overlay_secrets`.

```

namespace_provisioner:
 controller: true
 overlay_secrets:
 - name: grype-package-overlay
 namespace: tap-install
 create_export: true

```

### Using GitOps

The list of secrets with the overlay are set under `overlay_secrets`.

```

namespace_provisioner:
 controller: false
 overlay_secrets:
 - name: grype-package-overlay
 namespace: tap-install
 create_export: true
 gitops_install:
 ref: origin/main
 subPath: ns-provisioner-samples/gitops-install
 url: https://github.com/vmware-tanzu/application-accelerator-samples.git

```

Furthermore, you have the following options for customization:

### Options if using Controller

If you are using the controller to manage the list of developer namespaces, you have the following additional customization options available:

- [Use a different label selector than default](#)
- [Override the default CPU and memory limits for controller pods](#)
- [Customize the label and annotation prefixes that controller watches](#)

#### Use a different label selector than default

Use the `namespace_selector` to specify the [label selector](#) used by the [controller](#) to identify the namespaces that will be included in the [desired-namespaces](#) ConfigMap.

Sample `tap-values.yaml` configuration:

```

namespace_provisioner:
 controller: true
 namespace_selector:
 matchExpressions:
 - key: apps.tanzu.vmware.com/tap-ns
 operator: Exists

```

#### Override the default CPU and memory limits for controller pods

To configure the compute resources for the Namespace Provisioner controllers, you can use the `controller_resources` section in the Namespace Provisioner configuration in `tap-values.yaml`.

To set the maximum CPU and memory limits for the controllers, edit the `controller_resources.resources.limits.cpu` and `controller_resources.resources.limits.memory` values.

Similarly, you can configure the minimum CPU capacity and memory requests for the controllers by adjusting the `controller_resources.resources.requests.cpu` and `controller_resources.resources.requests.memory` settings.

Sample `tap-values.yaml` configuration:

```
namespace_provisioner:
 controller: true
 controller_resources:
 resources:
 limits:
 cpu: 500m
 memory: 100Mi
 requests:
 cpu: 100m
 memory: 20Mi
```

### Customize the label and annotation prefixes that controller watches

The `parameter_prefixes` is an array of label and annotation prefixes that the Namespace Provisioner controller uses to identify and include namespace-specific parameters in the `desired-namespaces` ConfigMap. These parameters can then be used as `ytt data.values` for templating both default and additional resources.

For example, if the value `tap.tanzu.vmware.com` is specified in `parameter_prefixes`, the Namespace Provisioner controller searches for annotations or labels in a provisioned namespace that begin with the prefix `tap.tanzu.vmware.com/`. It extracts those annotations or labels and uses them as parameters for further configuration and customization.

Sample `tap-values.yaml` configuration:

```
namespace_provisioner:
 controller: yes
 parameter_prefixes:
 - tmc.cloud.vmware.com
 - tap.tanzu.vmware.com
```

### Options if using GitOps

If you are using GitOps to manage the list of developer namespaces, you have the following customization option:

#### Use GitOps to manage developer namespaces list

`gitops_install` is a Git repository configuration with the list of namespaces to be provisioned.

Only use the `gitops_install` section when `controller: false` is set. If this section is used in conjunction with `controller: true`, the Namespace Provisioner package fails to reconcile, resulting in an error message stating `controller: false when using 'gitops_install' in provided values`.

Files in the Git repository must have a `.yaml` or `.yml` extension.

The `gitops_install` section can have the following entries:

- `url`: The Git repository URL (required)
- `subPath`: The Git repository subpath where the file is
- `ref`: The Git repository reference, the default is `origin/main`



- `secretRef`: If the repository needs authentication, the reference to the secret is set here
  - `name`: The name of the secret to be used for the repository authentication, see [Git Authentication for Private repository](#).
  - `namespace`: The namespace where the secret is created. Namespace Provisioner creates a Carvel secretgen [SecretImport](#) from this namespace to the Namespace Provisioner namespace.
  - `create_export`: A Boolean flag to create a Carvel secretgen [SecretExport](#) from the given namespace to Namespace Provisioner namespace. The default value is `false`.

Sample `gitops_install` repository file:



#### Note

The Carvel data header (`#@data/values`) is required in this file.

```
#@data/values

namespaces:
- name: dev
- name: qa
```

```
#@ load("@ytt:data", "data")
#! This loop will now loop over the namespace list in
#! in ns.yaml and will create those namespaces.
#@ for ns in data.values.namespaces:

apiVersion: v1
kind: Namespace
metadata:
name: #@ ns.name
#@ end
```

This file in the sample repository creates the namespaces in the namespaces list so no manual intervention is required.

Sample `tap-values.yaml` configuration:

```
namespace_provisioner:
 controller: false
 gitops_install:
 ref: origin/main
 subPath: ns-provisioner-samples/gitops-install
 url: https://github.com/vmware-tanzu/application-accelerator-samples.git
```

## Set up Out of the Box Supply Chains in Namespace Provisioner

This topic tells you how to set up Namespace Provisioner to automate resource creation needed for workloads to run on Out of the Box Supply Chain Basic and Out of the Box Supply Chain with Testing.

### Out of the Box Supply Chain Basic

To create a developer namespace, see [Provision Developer Namespaces](#).

Namespace Provisioner creates a set of **default resources** in all managed namespaces which are sufficient to run a workload through the Out of the Box Supply Chain Basic.

Run the following Tanzu CLI command to create a workload in your developer namespace.

Using the Tanzu CLI:

- Create workload using Tanzu apps CLI command:

```
tanzu apps workload apply tanzu-java-web-app \
--git-repo https://github.com/sample-accelerators/tanzu-java-web-app \
--git-branch main \
--type web \
--app tanzu-java-web-app \
--namespace DEVELOPER-NAMESPACE \
--tail \
--yes
```

Using a workload YAML:

- Create a `workload.yaml` file:

```
apiVersion: carto.run/v1alpha1
kind: Workload
metadata:
 labels:
 app.kubernetes.io/part-of: tanzu-java-web-app
 apps.tanzu.vmware.com/workload-type: web
 name: tanzu-java-web-app
 namespace: DEVELOPER-NAMESPACE
spec:
 source:
 git:
 ref:
 branch: main
 url: https://github.com/sample-accelerators/tanzu-java-web-app
```

## Out of the Box Supply Chain with Testing

The Out of the Box Supply Chain with Testing adds the **source-tester** step in the supply chain which tests the source code pulled by the supply chain. For source code testing to work in the supply chain, Tekton Pipelines must exist in the same namespace as the Workload so that the Tekton PipelineRun object that is created to run the tests can reference the developer-provided Pipeline.

By default, the workload is matched to the corresponding pipeline to run using labels. Pipelines must have the label `apps.tanzu.vmware.com/pipeline: test`. This provides a default match if no other labels are provided, but you can add additional labels. The pipeline expects two parameters:

- `source-url` is an HTTP address with a `.tar.gz` file containing all the source code to test.
- `source-revision` is the revision of the commit or image reference, such as setting `workload.spec.source.image` instead of `workload.spec.source.git`.

For example:

```
apiVersion: tekton.dev/v1beta1
kind: Pipeline
metadata:
 name: tekton-pipeline-java
 labels:
 apps.tanzu.vmware.com/pipeline: test # (!) required
spec:
```

```

params:
 - name: source-url # (!) required
 - name: source-revision # (!) required
tasks:
 - name: test
 params:
 - name: source-url
 value: $(params.source-url)
 - name: source-revision
 value: $(params.source-revision)
 taskSpec:
 params:
 - name: source-url
 - name: source-revision
 steps:
 - name: test
 image: gradle
 script: |-
 cd `mktemp -d`
 wget -qO- $(params.source-url) | tar xvz -m
 ./mvnw test

```

## Add Java Tekton Pipelines to your developer namespace

To create a developer namespace, see the [Provision Developer Namespaces](#).

Namespace Provisioner can automate the creation of a Tekton pipeline needed for the workload to run on an Out of the Box Supply Chain with Testing. You can create an example pipeline in your GitOps repository and add your GitOps repository as an additional source in Namespace Provisioner configuration in `tap-values.yaml`. See [Customize Installation of Namespace Provisioner](#).

Add the following configuration to `tap-values.yaml` to add [this example java pipeline](#) to your developer namespace:

Using Namespace Provisioner Controller:

- Example `tap-values.yaml` configuration:

```

namespace_provisioner:
 controller: true
 additional_sources:
 - git:
 ref: origin/main
 subPath: ns-provisioner-samples/testing-supplychain
 url: https://github.com/vmware-tanzu/application-accelerator-samples.git

```

Using GitOps:

- Example `tap-values.yaml` configuration:

```

namespace_provisioner:
 controller: false
 additional_sources:
 - git:
 ref: origin/main
 subPath: ns-provisioner-samples/testing-supplychain
 url: https://github.com/vmware-tanzu/application-accelerator-samples.git
 gitops_install:
 ref: origin/main
 subPath: ns-provisioner-samples/gitops-install
 url: https://github.com/vmware-tanzu/application-accelerator-samples.git

```

The example pipeline resource has the following ytt logic which creates this pipeline only if the following conditions are met:

- `supply_chain` in your `tap-values.yaml` file is either `testing` or `testing_scanning`
- `profile` in your `tap-values.yaml` file is either `full`, `iterate`, or `build`.

```

#@ load("@ytt:data", "data")
#@ def in_list(key, list):
#@ return hasattr(data.values.tap_values, key) and (data.values.tap_values[key] in list)
#@ end
#@ if/end in_list('supply_chain', ['testing', 'testing_scanning']) and in_list('profile', ['full', 'iterate', 'build']):

```

After adding the additional source to your `tap-values.yaml` file, you can see the `tekton-pipeline-java` created in your developer namespace. To verify that the pipeline is created correctly:

```
kubectl get pipeline.tekton.dev -n DEVELOPER-NAMESPACE
```

Where `DEVELOPER-NAMESPACE` is the name of the new developer namespace you want to use.

Run the following Tanzu CLI command to create a workload in your developer namespace:

Using the Tanzu CLI:

- Create workload using Tanzu apps CLI command.

```

tanzu apps workload apply tanzu-java-web-app \
--git-repo https://github.com/sample-accelerators/tanzu-java-web-app \
--git-branch main \
--type web \
--app tanzu-java-web-app \
--label apps.tanzu.vmware.com/has-tests="true" \
--namespace DEVELOPER-NAMESPACE \
--tail \
--yes

```

Using workload YAML:

- Create a `workload.yaml` file:

```

apiVersion: carto.run/v1alpha1
kind: Workload
metadata:
 labels:
 app.kubernetes.io/part-of: tanzu-java-web-app
 apps.tanzu.vmware.com/has-tests: "true"
 apps.tanzu.vmware.com/workload-type: web
 name: tanzu-java-web-app
 namespace: DEVELOPER-NAMESPACE
spec:
 source:
 git:
 ref:
 branch: main
 url: https://github.com/sample-accelerators/tanzu-java-web-app

```

## Out of the Box Supply Chain with Testing and Scanning

The Out of the Box Supply Chain with Testing and Scanning adds the `source-tester`, `source-scanner`, and `image-scanner` steps in the supply chain. See [Scan Types for Supply Chain Security Tools - Scan](#). These steps test the source code pulled by the supply chain and scans for CVEs on

the source and the image built by the supply chain. For these new testing and scanning steps to work, the following additional resources must exist in the same namespace as the workload:

- **Pipeline**: defines how to run the tests on the source code pulled by the supply chain and which image to use that has the tools to run those tests.
- **ScanTemplate**: defines how to run a scan, you can change how the scan is run, either for images or source code.
  - A ScanTemplate defines the PodTemplateSpec used by a Job to run a particular scan, such as an image or source. When the supply chain initiates an ImageScan or SourceScan, they reference these templates which must be in the same namespace as the workload.
  - Although you can customize the templates, VMware recommends that you follow the installation of the `grype.scanning.apps.tanzu.vmware.com` package. This is automatically created in all the namespaces managed by Namespace Provisioner. For more information, see [About Source and Image Scans](#).
- **ScanPolicy** defines how to evaluate whether the artifacts scanned are compliant. For example, allowing one to be restrictive about particular vulnerabilities found.
  - When an ImageScan or a SourceScan is created to run a scan, they reference a policy, the policy name must match the following [example ScanPolicy](#).
  - See [Writing Policy Templates](#).

## Add Java Tekton Pipelines Grype Scan Policy to your developer namespace

To create a developer namespace, see [Provision Developer Namespaces](#).

Namespace Provisioner can automate the creation of a Tekton pipeline and a ScanPolicy that is needed for the workload to run on an Out of the Box Supply Chain with Testing and Scanning. Create an example Pipeline and a ScanPolicy in your GitOps repository and add your GitOps repository as an additional source in Namespace Provisioner configuration in `tap-values.yaml`. See [Customize Installation of Namespace Provisioner](#).

Add the following configuration to your `tap-values.yaml` file to add the example java pipeline and grype scan policy to your developer namespace. See [application-accelerator-samples](#) in GitHub.

Using Namespace Provisioner Controller:

- Sample `tap-values.yaml` configuration:

```
namespace_provisioner:
 controller: true
 additional_sources:
 - git:
 ref: origin/main
 subPath: ns-provisioner-samples/testing-scanning-supplychain
 url: https://github.com/vmware-tanzu/application-accelerator-samples.git
```

Using GitOps:

- Example `tap-values.yaml` configuration:

```
namespace_provisioner:
 controller: false
 additional_sources:
 - git:
 ref: origin/main
 subPath: ns-provisioner-samples/testing-scanning-supplychain
```

```

url: https://github.com/vmware-tanzu/application-accelerator-samples.git
gitops_install:
 ref: origin/main
 subPath: ns-provisioner-samples/gitops-install
url: https://github.com/vmware-tanzu/application-accelerator-samples.git

```

The example Pipeline resource have the following ytt logic which creates this pipeline only if

- `supply_chain` in your `tap-values.yaml` file is either `testing` or `testing_scanning`
- `profile` in your `tap-values.yaml` file is either `full`, `iterate`, or `build`.

```

#@ load("@ytt:data", "data")
#@ def in_list(key, list):
#@ return hasattr(data.values.tap_values, key) and (data.values.tap_values[key] in list)
#@ end
#@ if/end in_list('supply_chain', ['testing', 'testing_scanning']) and in_list('profile', ['full', 'iterate', 'build']):

```

The example ScanPolicy resource have the following ytt logic which creates this pipeline only if

- `supply_chain` in your `tap-values.yaml` file is `testing_scanning`
- `profile` in your `tap-values.yaml` file is either `full` or `build`.

After adding the additional source to your `tap-values.yaml` file, you can see the `tekton-pipeline-java` and `scan-policy` created in your developer namespace. To verify that the pipeline is created correctly:

```
kubectl get pipeline.tekton.dev,scanpolicies -n DEVELOPER-NAMESPACE
```

Where `DEVELOPER-NAMESPACE` is the name of the new developer namespace you want to use.

Run the following Tanzu CLI command to create a workload in your developer namespace:

Using the Tanzu CLI:

- Create workload using Tanzu apps CLI command.

```

tanzu apps workload apply tanzu-java-web-app \
--git-repo https://github.com/sample-accelerators/tanzu-java-web-app \
--git-branch main \
--type web \
--app tanzu-java-web-app \
--label apps.tanzu.vmware.com/has-tests="true" \
--namespace DEVELOPER-NAMESPACE \
--tail \
--yes

```

Using a workload YAML:

- Create a workload.yaml file:

```

apiVersion: carto.run/v1alpha1
kind: Workload
metadata:
 labels:
 app.kubernetes.io/part-of: tanzu-java-web-app
 apps.tanzu.vmware.com/has-tests: "true"
 apps.tanzu.vmware.com/workload-type: web
 name: tanzu-java-web-app
 namespace: DEVELOPER-NAMESPACE
spec:
 source:
 git:

```

```
ref:
 branch: main
 url: https://github.com/sample-accelerators/tanzu-java-web-app
```

## Namespace Provisioner use cases and examples

Review the following Namespace Provisioner uses cases:

[Use multiple tekton pipelines and Scan policies in the same namespace in Namespace Provisioner](#)

[Add Tekton pipelines and scan policies using namespace parameters in Namespace Provisioner](#)

[Working with private Git repositories in Namespace Provisioner](#)

[Customize default resources in Namespace Provisioner](#)

[Install multiple scanners in the developer namespace in Namespace Provisioner](#)

[Apply ScanTemplate overlays in air-gapped environments in Namespace Provisioner](#)

## Use multiple Tekton pipelines and scan policies in the same namespace in Namespace Provisioner

This topic tells you how to use Namespace Provisioner to configure developer namespaces to include multiple Tekton pipelines and ScanPolicies in Tanzu Application Platform (commonly known as TAP).

For information about, how to create a developer namespace, see [Provision Developer Namespaces](#).

This [sample GitOps location](#) has a Java, Python and a Golang testing pipeline as well as a Strict and a Lax grype ScanPolicy.

### Using Namespace Provisioner Controller

Add the following configuration to your `tap-values.yaml` file to add multiple tekton pipelines and scan policies to your developer namespace:

```
namespace_provisioner:
 controller: true
 additional_sources:
 - git:
 ref: origin/main
 subPath: ns-provisioner-samples/testing-scanning-supplychain-polyglot
 url: https://github.com/vmware-tanzu/application-accelerator-samples.git
```

### Using GitOps

Add the following configuration to your `tap-values.yaml` file to add multiple tekton pipelines and scan policies to your developer namespace:

```
namespace_provisioner:
 controller: false
 additional_sources:
 - git:
 ref: origin/main
 subPath: ns-provisioner-samples/testing-scanning-supplychain-polyglot
 url: https://github.com/vmware-tanzu/application-accelerator-samples.git
 gitops_install:
 ref: origin/main
 subPath: ns-provisioner-samples/gitops-install
 url: https://github.com/vmware-tanzu/application-accelerator-samples.git
```

The sample Pipeline resource have the following ytt logic which creates this pipeline only if

- `supply_chain` in your `tap-values.yaml` file is either `testing` or `testing_scanning`
- `profile` in your `tap-values.yaml` file is either `full`, `iterate` or `build`.

```
#@ load("@ytt:data", "data")
#@ def in_list(key, list):
#@ return hasattr(data.values.tap_values, key) and (data.values.tap_values[key] in list)
#@ end
#@ if/end in_list('supply_chain', ['testing', 'testing_scanning']) and in_list('profile', ['full', 'iterate', 'build']):
```

All pipelines have an additional label `apps.tanzu.vmware.com/language` to differentiate between them.

The sample ScanPolicy resource have the following ytt logic which creates this pipeline only if

- `supply_chain` in your `tap-values.yaml` file is `testing_scanning`
- `profile` in your `tap-values.yaml` file is either `full` or `build`.

The `strict ScanPolicy` does not allow any workloads that have Critical and High vulnerabilities to pass through the supply chain whereas the `lax ScanPolicy` allows the workloads to pass regardless of CVEs detected. The allowed severity level is configured using the `notAllowedSeverities := []` part of the rego file section of ScanPolicy.



### Caution

The lax ScanPolicy is just added for tutorial purposes but it is not advised to use such a policy in Production workloads.

After adding the additional source to your `tap-values.yaml` file, you should be able to see the `tekton-pipeline-java`, `tekton-pipeline-golang`, `tekton-pipeline-python`, `scan-policy` and `lax-scan-policy` created in your developer namespace. Run the following command to see if the pipelines are created correctly.

```
kubectl get pipeline.tekton.dev,scanpolicies -n YOUR-NEW-DEVELOPER-NAMESPACE
```

Run the following Tanzu CLI command to create a workload in your developer namespace:

### Using Tanzu CLI

Create workload using tanzu apps CLI command

```
tanzu apps workload apply tanzu-java-web-app \
--git-repo https://github.com/sample-accelerators/tanzu-java-web-app \
--git-branch main \
--type web \
--app tanzu-java-web-app \
--label apps.tanzu.vmware.com/has-tests="true" \
--param-yaml testing_pipeline_matching_labels='{"apps.tanzu.vmware.com/language": "java"}' \
--param scanning_source_policy="lax-scan-policy" \
--param scanning_image_policy="lax-scan-policy" \
--namespace YOUR-NEW-DEVELOPER-NAMESPACE \
--tail \
--yes
```

### Using workload yaml



Create a workload.yaml file with the details as below.

```

apiVersion: carto.run/v1alpha1
kind: Workload
metadata:
 generation: 1
 labels:
 app.kubernetes.io/part-of: tanzu-java-web-app
 apps.tanzu.vmware.com/has-tests: "true"
 apps.tanzu.vmware.com/workload-type: web
 name: tanzu-java-web-app
 namespace: YOUR-NEW-DEVELOPER-NAMESPACE
spec:
 params:
 - name: scanning_source_policy
 value: lax-scan-policy
 - name: scanning_image_policy
 value: lax-scan-policy
 - name: testing_pipeline_matching_labels
 value:
 apps.tanzu.vmware.com/language: java
 source:
 git:
 ref:
 branch: main
 url: https://github.com/sample-accelerators/tanzu-java-web-app

```



#### Note

`--param-yaml testing_pipeline_matching_labels` tells the supply chain to use the selector that matches the Java pipeline. To use the Python or Golang pipelines, use the selector that matches the language label in those resources. `--param scanning_source_policy="lax-scan-policy"` tells the supply chain to use the lax ScanPolicy for the workload.

## Add Tekton pipelines and scan policies using namespace parameters in Namespace Provisioner

This topic tells you how to use Namespace Provisioner to parameterize your additional resources and pass those parameters to namespaces in Tanzu Application Platform (commonly known as TAP).

Instead of creating all the pipelines in all provisioned namespaces, create a Tekton pipeline and ScanPolicy that is bespoke to namespaces that are running workloads using a specific language stack.

For information about, how to create a developer namespace, see [Provision Developer Namespaces](#).

This use case looks at the pipelines and ScanPolicies in this [sample GitOps location](#).

### Using Namespace Provisioner controller

Use controller to pass the parameters to a namespace via labels and annotations on the namespace. To enable this, set the `parameter_prefixes` in `tap-values.yaml`. The controller looks for labels and annotations starting with that prefix to populate parameters for a given

namespace. For more information, see [Customize the label and annotation prefixes that controller watches](#).

Add the following configuration to your `tap-values.yaml` file to add parameterized Tekton pipelines and scan policies to your developer namespace:

```
namespace_provisioner:
 controller: true
 additional_sources:
 - git:
 ref: origin/main
 subPath: ns-provisioner-samples/testing-scanning-supplychain-parameterized
 url: https://github.com/vmware-tanzu/application-accelerator-samples.git
 parameter_prefixes:
 - tap.tanzu.vmware.com
```



#### Note

This example adds `tap.tanzu.vmware.com` as a `parameter_prefixes` in Namespace Provisioner configuration. This tells the Namespace Provisioner controller to look for the annotations and labels on a provisioned namespace that start with the prefix `tap.tanzu.vmware.com` and use those as parameters.

The sample pipelines have the following ytt logic which creates this pipeline only if

- `supply_chain` in your `tap-values.yaml` file is either `testing` or `testing_scanning`
- `profile` in your `tap-values.yaml` file is either `full`, `iterate` or `build.pipeline` parameter that matches the language for which the pipeline is for.

```
#@ load("@ytt:data", "data")
#@ def in_list(key, list):
#@ return hasattr(data.values.tap_values, key) and (data.values.tap_values[key] in list)
#@ end
#@ if/end in_list('supply_chain', ['testing', 'testing_scanning']) and in_list('profile', ['full', 'iterate', 'build']) and hasattr(data.values, 'pipeline') and data.values.pipeline == 'java':
```

The sample ScanPolicy resource have the following ytt logic which creates this pipeline only if

- `supply_chain` in your `tap-values.yaml` file is `testing_scanning`
- `profile` in your `tap-values.yaml` file is either `full` or `build`.
- `scanpolicy` parameter matches either `strict` or `lax`

```
#@ load("@ytt:data", "data")
#@ def in_list(key, list):
#@ return hasattr(data.values.tap_values, key) and (data.values.tap_values[key] in list)
#@ end
#@ if/end in_list('supply_chain', ['testing_scanning']) and in_list('profile', ['full', 'build']) and hasattr(data.values, 'scanpolicy') and data.values.scanpolicy == 'lax':
```

Label your developer namespace using the `parameter_prefixes` with the `parameter` to be used in the `additional_sources` as follows:

```
kubectl label namespaces YOUR-NEW-DEVELOPER-NAMESPACE tap.tanzu.vmware.com/scanpolicy=lax
```

```
kubectl label namespaces YOUR-NEW-DEVELOPER-NAMESPACE tap.tanzu.vmware.com/pipeline=java
```

## Using GitOps

Pass the parameters to a namespace by adding them to the `data.values` file located in the GitOps repository. Use [this sample file](#) as an example.

Add the following configuration to your `tap-values.yaml` file to add parameterized Tekton pipelines and scan policies to your developer namespace:

```
namespace_provisioner:
 controller: false
 additional_sources:
 - git:
 ref: origin/main
 subPath: ns-provisioner-samples/testing-scanning-supplychain-parameterized
 url: https://github.com/vmware-tanzu/application-accelerator-samples.git
 gitops_install:
 ref: origin/main
 subPath: ns-provisioner-samples/gitops-install-with-params
 url: https://github.com/vmware-tanzu/application-accelerator-samples.git
```

`gitops_install` uses this [sample GitOps location](#) to create the namespaces and manage the desired namespaces from GitOps. For more information, see GitOps section of [Customize Installation of Namespace Provisioner](#).

Sample of `gitops_install` files:

```
##@data/values

namespaces:
- name: dev
 scanpolicy: lax
 pipeline: java
- name: qa
 scanpolicy: strict
 pipeline: java
```

```
##@ load("@ytt:data", "data")
##! This loop will now loop over the namespace list in
##! in ns.yaml and will create those namespaces.
##@ for ns in data.values.namespaces:

apiVersion: v1
kind: Namespace
metadata:
 name: #@ ns.name
##@ end
```

The sample pipelines have the following ytt logic which creates this pipeline only if the following conditions are met:

- `supply_chain` in your `tap-values.yaml` file is either `testing` or `testing_scanning`
- `profile` in your `tap-values.yaml` file is either `full`, `iterate` or `build`.
- `pipeline` parameter that matches the language for which the pipeline is for.

```
##@ load("@ytt:data", "data")
##@ def in_list(key, list):
##@ return hasattr(data.values.tap_values, key) and (data.values.tap_values[key] in list)
##@ end
```

```
#@ if/end in_list('supply_chain', ['testing', 'testing_scanning']) and in_list('profile', ['full', 'iterate', 'build']) and hasattr(data.values, 'pipeline') and data.values.pipeline == 'java':
```

The sample ScanPolicy resource have the following ytt logic which creates this pipeline only if the following conditions are met:

- `supply_chain` in your `tap-values.yaml` file is `testing_scanning`
- `profile` in your `tap-values.yaml` file is either `full` or `build`.
- `scanpolicyparameter` matches either `strict` or `lax`

```
#@ load("@ytt:data", "data")
#@ def in_list(key, list):
#@ return hasattr(data.values.tap_values, key) and (data.values.tap_values[key] in list)
#@ end
#@ if/end in_list('supply_chain', ['testing_scanning']) and in_list('profile', ['full', 'build']) and hasattr(data.values, 'scanpolicy') and data.values.scanpolicy == 'lax':
```

Run the following Tanzu CLI command to create a workload in your developer namespace:

### Using Tanzu CLI

Create a workload using Tanzu Apps CLI command

```
tanzu apps workload apply tanzu-java-web-app \
--git-repo https://github.com/sample-accelerators/tanzu-java-web-app \
--git-branch main \
--type web \
--app tanzu-java-web-app \
--label apps.tanzu.vmware.com/has-tests="true" \
--namespace YOUR-NEW-DEVELOPER-NAMESPACE \
--tail \
--yes
```

### Using workload yaml

Create a workload.yaml file with the details as below.

```

apiVersion: carto.run/v1alpha1
kind: Workload
metadata:
 labels:
 app.kubernetes.io/part-of: tanzu-java-web-app
 apps.tanzu.vmware.com/has-tests: "true"
 apps.tanzu.vmware.com/workload-type: web
 name: tanzu-java-web-app
 namespace: YOUR-NEW-DEVELOPER-NAMESPACE
spec:
 source:
 git:
 ref:
 branch: main
 url: https://github.com/sample-accelerators/tanzu-java-web-app
```

Run the following command to verify the resources have been created in the namespace:

```
kubectl get secrets,serviceaccount,rolebinding,pods,workload,configmap,limitrange,pipe
line,scanpolicies -n YOUR-NEW-DEVELOPER-NAMESPACE
```

## Work with private Git repositories in Namespace Provisioner

This topic tells you how to configure Namespace Provisioner to use private Git repositories for storing GitOps based installation files, and platform operator templated resources that you want to create in your developer namespace in Tanzu Application Platform (commonly known as TAP).

### Git Authentication for using a private Git repository

Authentication is provided using a secret in the `tap-namespace-provisioning` namespace, or an existing secret in another namespace referred to in the `secretRef` in the `additional_sources`. For more details, see [Customize Installation of Namespace Provisioner](#).

### Create the Git Authentication secret in tap-namespace-provisioning namespace

The secrets for Git authentication allow the following keys: `ssh-privatekey`, `ssh-knownhosts`, `username`, and `password`. If `ssh-knownhosts` is not specified, Git does not perform strict host checking.



#### Important

Namespace Provisioner relies on kapp-controller for any tasks involving communication with external services, such as registries or Git repositories. When operating in air-gapped environments or other scenarios where external services are secured by a Custom CA certificate, you must configure kapp-controller with the CA certificate data to prevent X.509 certificate errors. For more information, see [Deploy onto Cluster](#) in the Cluster Essentials for VMware Tanzu documentation.

1. Create the Git secret:

#### Using HTTP(s) based Authentication

If you are using Username and Password for authentication:

```
cat << EOF | kubectl apply -f -
apiVersion: v1
kind: Secret
metadata:
 name: git-auth
 namespace: tap-namespace-provisioning
type: Opaque
stringData:
 username: GIT-USERNAME
 password: GIT-PASSWORD
EOF
```

#### Using SSH based Authentication

If you are using SSH private key for authentication:

```
cat << EOF | kubectl apply -f -
apiVersion: v1
kind: Secret
metadata:
 name: git-auth
 namespace: tap-namespace-provisioning
type: Opaque
```

```
stringData:
 ssh-privatekey: |
 -----BEGIN OPENSSSH PRIVATE KEY-----
 ..
 -----END OPENSSSH PRIVATE KEY-----
EOF
```

2. Add the `secretRef` section to the `additional_sources` and the `gitops_install` section of your `tap-values.yaml` file:

### Using Namespace Provisioner Controller

#### Description

```
namespace_provisioner:
 controller: true
 additional_sources:
 - git:
 ref: origin/main
 subPath: sources
 # This example URL is for SSH auth. Use https:// path if using HTTPS au
 th
 url: git@github.com:private-repo-org/repo.git
 secretRef:
 name: git-auth
```

### Using GitOps

#### Description

In this example, the location where the list of namespaces resides is also a private repository. So you must create a secret named `git-auth-install` with the same authentication details.

```
namespace_provisioner:
 controller: false
 additional_sources:
 - git:
 ref: origin/main
 subPath: tekton-pipelines
 # This example URL is for SSH auth. Use https:// path if using HTTPS au
 th
 url: git@github.com:private-repo-org/repo.git
 secretRef:
 name: git-auth
 gitops_install:
 ref: origin/main
 subPath: gitops-install
 # This example URL is for SSH auth. Use https:// path if using HTTPS auth
 url: git@github.com:private-repo-org/repo.git
 secretRef:
 name: git-auth-install
```

## Import from another namespace

If you already have a Git secret created in a namespace other than `tap-namespace-provisioning` namespace and you want to refer to that, the `secretRef` section should have the namespace mentioned with the `create_export` flag. The default value for `create_export` is `false` as it assumes the Secret is already exported for `tap-namespace-provisioning` namespace, but allows you to specify if you want the Namespace Provisioner to create a `Carvel SecretExport` for that secret.

The example refers to `git-auth` secret from `tap-install` in the `secretRef` section.

### Using Namespace Provisioner Controller

#### Description

```
namespace_provisioner:
 controller: true
 additional_sources:
 - git:
 ref: origin/main
 subPath: sources
 #! This example URL is for SSH auth. Use https:// path if using HTTPS auth
 url: git@github.com:private-repo-org/repo.git
 secretRef:
 name: git-auth
 namespace: tap-install
 #! If this secret is already exported for this namespace, you can ignore the
 create_export key as it defaults to false
 create_export: true
```

### Using GitOps

#### Description

```
namespace_provisioner:
 controller: false
 additional_sources:
 - git:
 ref: origin/main
 subPath: tekton-pipelines
 #! This example URL is for SSH auth. Use https:// path if using HTTPS auth
 url: git@github.com:private-repo-org/repo.git
 secretRef:
 name: git-auth
 namespace: tap-install
 #! If this secret is already exported for this namespace, you can ignore the
 create_export key as it defaults to false
 create_export: true
 gitops_install:
 ref: origin/main
 subPath: gitops-install
 #! This example URL is for SSH auth. Use https:// path if using HTTPS auth
 url: git@github.com:private-repo-org/repo.git
 secretRef:
 name: git-auth-install
 namespace: tap-install
 #! If this secret is already exported for this namespace, you can ignore the c
 reate_export key as it defaults to false
 create_export: true
```

After reconciling, Namespace Provisioner creates:

- [SecretExport](#) for the secret in the provided namespace (`tap-install` in the above example) to the Namespace Provisioner namespace.
- [SecretImport](#) for the secret in Namespace Provisioning namespace (`tap-namespace-provisioning`) so Carvel [secretgen-controller](#) can create the required secret for the Namespace Provisioner to connect to the private Git repository.

## Git Authentication for Private Repository for Workloads and Supply chain

To either fetch or push source code from or to a repository that requires credentials, you must provide those through a Kubernetes secret object referenced by the intended Kubernetes object created for performing the action. The following sections provide details about how to appropriately set up Kubernetes secrets for carrying those credentials forward to the proper resources.

This section provides instructions on how to configure the `default` service account to work with private Git repositories for workloads and supply chain using Namespace Provisioner.

To configure the service account to work with private Git repositories, follow the steps below:

1. Create a secret in the `tap-install` namespace or any namespace of your preference, that contains the Git credentials in YAML format.
  - `host`, `username`, and `password`, or `personal access token` values for HTTP based Git Authentication.
  - `ssh-privatekey`, `identity`, `identity_pub`, and `known_hosts` for SSH based Git Authentication.



#### Note

The `stringData` key of the secret must have `.yaml` or `.yml` suffix at the end.

### Using HTTP(s) based Authentication

If using Username and Password for authentication.

```
cat << EOF | kubectl apply -f -
apiVersion: v1
kind: Secret
metadata:
 name: workload-git-auth
 namespace: tap-install
type: Opaque
stringData:
 content.yaml: |
 git:
 #! For HTTP Auth. Recommend using https:// for the git server.
 host: GIT-SERVER
 username: GIT-USERNAME
 password: GIT-PASSWORD
EOF
```

### Using SSH based Authentication

If you are using SSH private key for authentication, create the Git secret with authentication details as follows:

```
cat << EOF | kubectl apply -f -
apiVersion: v1
kind: Secret
metadata:
 name: workload-git-auth
 namespace: tap-install
type: Opaque
stringData:
 content.yaml: |
 git:
 host: GIT-SERVER
 #! For SSH Auth
 ssh_privatekey: SSH-PRIVATE-KEY
 identity: SSH-PRIVATE-KEY
 identity_pub: SSH-PUBLIC-KEY
```



```
known_hosts: GIT-SERVER-PUBLIC-KEYS
EOF
```

- To create a secret that will be added to the service account in the developer namespace within the GitOps repository, use this [example](#) or follow the example provided below.

Instead of directly including the actual user name and password in the Git repository secret, use the `data.values.imported` keys to add references to the values from the git-auth secret created in Step 1.

This secret represents the actual Git secret that will be created by the Namespace Provisioner in each managed namespace. It should be included in your Git repository linked in the `additional_sources` section of `tap-values.yaml` mentioned in Step 4.

### Using HTTP(s) based Authentication

If using Username and Password for authentication.

```
#@ load("@ytt:data", "data")

apiVersion: v1
kind: Secret
metadata:
 name: git
 annotations:
 tekton.dev/git-0: #@ data.values.imported.git.host
type: kubernetes.io/basic-auth
stringData:
 username: #@ data.values.imported.git.username
 password: #@ data.values.imported.git.token
```

### Using SSH based Authentication

If using SSH private key for authentication:

```
#@ load("@ytt:data", "data")

apiVersion: v1
kind: Secret
metadata:
 name: git
 annotations:
 tekton.dev/git-0: #@ data.values.imported.git.host
type: kubernetes.io/ssh-auth
stringData:
 identity: #@ data.values.imported.git.identity
 identity.pub: #@ data.values.imported.git.identity_pub
 known_hosts: #@ data.values.imported.git.known_hosts
 ssh-privatekey: #@ data.values.imported.git.ssh_privatekey
```

- Combine this `tap-values.yaml`:

### Using Namespace Provisioner Controller

Add the following configuration to `tap-values.yaml`:

```
namespace_provisioner:
 controller: true
 additional_sources:
 - git:
 ref: origin/main
 subPath: ns-provisioner-samples/credentials
 url: https://github.com/vmware-tanzu/application-accelerator-samples.gi
```

```
t
import_data_values_secrets:
- name: workload-git-auth
 namespace: tap-install
 create_export: true
default_parameters:
 supply_chain_service_account:
 secrets:
 - git
```

### Using GitOps

Add the following configuration to `tap-values.yaml`:

```
namespace_provisioner:
 controller: false
 additional_sources:
 - git:
 ref: origin/main
 subPath: ns-provisioner-samples/credentials
 url: https://github.com/vmware-tanzu/application-accelerator-samples.git
t
gitops_install:
 ref: origin/main
 subPath: ns-provisioner-samples/gitops-install
 url: https://github.com/vmware-tanzu/application-accelerator-samples.git
import_data_values_secrets:
- name: workload-git-auth
 namespace: tap-install
 create_export: true
default_parameters:
 supply_chain_service_account:
 secrets:
 - git
```

- o First additional source points to the location where the templated Git secret resides which will be created in all developer namespaces.
- o Import the newly created `workload-git-auth` secret into Namespace Provisioner to use in `data.values.imported` by adding the secret to the `import_data_values_secrets`.
- o Add the secret to be added to the ServiceAccount in the `default_parameters`. For more information, see [Customize service accounts](#).



#### Note

`create_export` is set to `true` in `import_data_values_secrets`, as a result, a `SecretExport` is created for the `workload-git-auth` secret in the `tap-install` namespace automatically by Namespace Provisioner. After the changes are reconciled, the secret named `git` is in all provisioned namespaces and is also added to the default service account of those namespaces.

4. In your `tap-values.yaml` file, in the `ootb_supply_chain_*.gitops.ssh_secret` section, specify the name of the Git secret that contains the credentials. This is necessary for the supply chain to include the `secretRef` when creating the Flux `GitRepository` resource. Here is an example:

```
ootb_supply_chain_testing_scanning:
 gitops:
```

```
ssh_secret: git # Replace with the actual name of your Git secret for the
workload, if different
```

By providing this configuration, the supply chain associates the created GitRepository resource with the specified Git secret managed by the Namespace Provisioner.

## Customize default resources in Namespace Provisioner

This topic tells you how to deactivate Grype in Namespace Provisioner and how to configure the `default` service account to work with private Git repositories in Tanzu Application Platform (commonly known as TAP).

### Deactivate Grype install

Grype is installed with Namespace Provisioner by default. If you prefer to use a different scanner for namespaces instead of Grype, you can deactivate the installation of the default Grype scanner.

### DeDeactivate Grype for all namespaces

To deactivate the default installation of Grype for all namespaces managed by the Namespace Provisioner, set the `skip_grype` parameter to `true` in the `default_parameters` section of the `tap-values.yaml`:

```
namespace_provisioner:
 default_parameters:
 skip_grype: true
```

By enabling the `skip_grype: true` setting, the `PackageInstall` and the secret `grype-scanner-{namespace}` are not generated in the `tap-install` namespace for any namespaces that are managed by the Namespace Provisioner.

### DeDeactivate Grype for a specific namespace

#### Using Namespace Provisioner Controller

To deactivate the installation of Grype for a specific namespace, annotate or label the namespace by setting the reserved parameter `skip_grype` to `true`. Use the default or customized `parameter_prefixes`. For more information, see [Customize the label and annotation prefixes that controller watches](#).

```
kubectl annotate ns YOUR-NEW-DEVELOPER-NAMESPACE param.nsp.tap/skip_grype=true
```

#### Using GitOps

Add the parameter `skip_grype` with the value `true` in the namespaces file in the GitOps repository.

```
##data/values

namespaces:
- name: dev
 skip_grype: true
- name: qa
```

## Customize service accounts

This section provides instructions on how to configure the `default` service account to work with private Git repositories for workloads and supply chain using Namespace Provisioner.

To configure the service account to work with private Git repositories, follow the steps below:

1. Create a secret in the `tap-install` namespace, or any namespace that contains the Git credentials in the YAML format.
  - `host`, `username`, and `password` values for HTTP based Git Authentication.
  - `ssh-privatekey`, `identity`, `identity_pub`, and `known_hosts` for SSH based Git Authentication.



#### Note

stringData key of the secret must have `.yaml` or `.yml` suffix at the end.

```

#! Example shows HTTP as well as SSH based authentication
cat << EOF | kubectl apply -f -
apiVersion: v1
kind: Secret
metadata:
 name: workload-git-auth
 namespace: tap-install
type: Opaque
stringData:
 content.yaml: |
 git:
 #! For HTTP Auth. Recommend using https:// for the git server.
 host: GIT-SERVER
 username: GIT-USERNAME
 token: GIT-PASSWORD
 #! For SSH Auth
 ssh_privatekey: SSH-PRIVATE-KEY
 identity: SSH-PRIVATE-KEY
 identity_pub: SSH-PUBLIC-KEY
 known_hosts: GIT-SERVER-PUBLIC-KEYS
EOF

```

2. Create a scaffolding of a Git secret, this must be added to the service account in your developer namespace in your GitOps repository. A [sample secret](#) is available in the `vmware-tanzu/application-accelerator-samples` Git repository. Instead of putting the user name and password in the secret in your Git repository, use the `data.values.imported` keys to put the reference to the values in the `git-auth` secret created in step 1. For example:

```

#@ load("@ytt:data", "data")
#@ load("@ytt:base64", "base64")

apiVersion: v1
kind: Secret
metadata:
 name: git
 annotations:
 tekton.dev/git-0: #@ data.values.imported.git.host
type: kubernetes.io/basic-auth
stringData:
 username: #@ base64.encode(data.values.imported.git.username)
 password: #@ base64.encode(data.values.imported.git.token)

```

3. Complete the process by customizing the SupplyChain ServiceAccount for all or specific namespaces as described in the following sections.

## Update ServiceAccount for all namespaces

Customize the SupplyChain ServiceAccount by adding additional `secrets` or `imagePullSecrets` for all namespaces managed by the Namespace Provisioner. Edit the `supply_chain_service_account` parameter in the `default_parameters` section of the `tap-values.yaml` file. If you have a separate Service Account for delivery purposes, configure it using the `delivery_service_account` parameter. For example:

```
namespace_provisioner:
 controller: true
 additional_sources:
 - git:
 ref: origin/main
 subPath: ns-provisioner-samples/credentials
 url: https://github.com/vmware-tanzu/application-accelerator-samples.git
 import_data_values_secrets:
 - name: workload-git-auth
 namespace: tap-install
 create_export: true
 default_parameters:
 supply_chain_service_account:
 secrets:
 - git
 imagePullSecrets: [] #! optional
 delivery_service_account: #! Not required, specify only if the Service account is
different from the Supply chain service account.
 secrets: [] #! optional
 imagePullSecrets: [] #! optional
```

- This adds the `git` secret to the Service Account mentioned in `ootb_supply_chain_*.service_account`. If not specified, it takes the `default` service account.
- `additional_sources` points to the location where the templated Git secret resides which will be created in all developer namespaces.
- Import the newly created `workload-git-auth` secret into Namespace Provisioner to use in `data.values.imported` by adding the secret to the `import_data_values_secrets`.
- Add the secret to be added to the ServiceAccount in the `default_parameters`

## Update ServiceAccount for a specific namespace

To customize the SupplyChain ServiceAccount for a specific namespace managed by the Namespace Provisioner and include additional `secrets` or `imagePullSecrets`, use the `supply_chain_service_account` parameter. This `parameter` allows you to edit the ServiceAccount and add any required `secrets` or `imagePullSecrets`.

If you have a separate ServiceAccount for delivery purposes, you can also configure it using the `delivery_service_account` parameter.

### Using Namespace Provisioner Controller

Add the following configuration to your `tap-values.yaml` file:

```
namespace_provisioner:
 controller: true
 additional_sources:
 - git:
 ref: origin/main
 subPath: ns-provisioner-samples/credentials
 url: https://github.com/vmware-tanzu/application-accelerator-samples.git
 import_data_values_secrets:
```

```
- name: workload-git-auth
 namespace: tap-install
 create_export: true
```

- `additional_sources` points to the location where the templated Git secret resides which will be created in all developer namespaces.
- Import the newly created `workload-git-auth` secret into Namespace Provisioner to use in `data.values.imported` by adding the secret to the `import_data_values_secrets`.

Annotate the namespace with the `parameter` so the ServiceAccount is updated

```
kubectl annotate ns dev param.nsp.tap/supply_chain_service_account.secrets='["git"]'
```

The `desired-namespaces` ConfigMap will look like:

```
##@data/values

namespaces:
- name: dev
 supply_chain_service_account:
 secrets:
 - git
```

If the ServiceAccount for delivery is different, then:

```
kubectl annotate ns dev param.nsp.tap/delivery_service_account.secrets='["git"]'
```

The `desired-namespaces` ConfigMap will look like:

```
##@data/values

namespaces:
- name: dev
 supply_chain_service_account:
 secrets:
 - git
 delivery_service_account:
 secrets:
 - git
```

## Using GitOps

Add the following configuration to your `tap-values.yaml` file:

```
namespace_provisioner:
 controller: false
 additional_sources:
 - git:
 ref: origin/main
 subPath: ns-provisioner-samples/credentials
 url: https://github.com/vmware-tanzu/application-accelerator-samples.git
 gitops_install:
 ref: origin/main
 subPath: ns-provisioner-samples/gitops-install-params-sa
 url: https://github.com/vmware-tanzu/application-accelerator-samples.git
 import_data_values_secrets:
 - name: workload-git-auth
 namespace: tap-install
 create_export: true
```

- `additional_sources` points to the location where the templated Git secret resides which will be created in all developer namespaces.

- Configure the desired namespaces yaml in the GitOps repository with the [parameter](#) in the namespace. Check the sample [file](#) where you are adding the `git` secret to the supply chain service account.
- Import the newly created `workload-git-auth` secret into Namespace Provisioner to use in `data.values.imported` by adding the secret to the `import_data_values_secrets`.



#### Note

`create_export` is set to `true` in `import_data_values_secrets` meaning that a `SecretExport` is created for the `workload-git-auth` secret in the `tap-install` namespace automatically by Namespace Provisioner. After the changes are reconciled, the secret named `git` is in all provisioned namespaces and is also added to the default service account of those namespaces.

## Customize Limit Range defaults

Namespace Provisioner creates the [LimitRange](#) resources on Run clusters in all Namespace Provisioner managed namespaces. For more information, see [Default Resources](#).

You can opt-in to have the `LimitRange` resource created on Full and Iterate clusters. For more information, see [Set/Update LimitRange defaults for all namespaces](#) and [Set/Update LimitRange defaults for a specific namespace](#).

Namespace Provisioner does not create `LimitRange` resource in Build and View clusters.

Default values in `LimitRange` resource are as follows:

```
limits:
 default:
 cpu : 1500m
 memory : 1Gi
 defaultRequest:
 cpu : 100m
 memory : 1Gi
```

## Set or Update LimitRange defaults for all namespaces

To update the values in `LimitRange` for all Namespace Provisioner managed namespaces, specify the `default_parameters` configuration in `tap-values.yaml` as follows:

```
namespace_provisioner:
 default_parameters:
 # overwrite default limits set by the OOTB LimitRange (in Run Cluster) for all namespaces
 # set default limits for Full and Iterate Cluster in all namespaces
 limits:
 default:
 cpu: 1000m
 memory: 1Gi
 defaultRequest:
 cpu: 200m
 memory: 500Mi
```

## Set or Update LimitRange defaults for a specific namespace

Override the `LimitRange` for specific namespaces as follows:

## Using Namespace Provisioner Controller

Annotate or label a namespace using the default `parameter_prefix` `param.nsp.tap/` followed by the YAML path to CPU or memory limits as follows:

```
kubectl annotate ns YOUR-NEW-DEVELOPER-NAMESPACE param.nsp.tap/limits.default.cpu=1100m

kubectl annotate ns YOUR-NEW-DEVELOPER-NAMESPACE param.nsp.tap/limits.default.memory=2Gi

kubectl annotate ns YOUR-NEW-DEVELOPER-NAMESPACE param.nsp.tap/limits.defaultRequest.cpu=1500m

kubectl annotate ns YOUR-NEW-DEVELOPER-NAMESPACE param.nsp.tap/limits.defaultRequest.memory=1Gi
```

- The controller detects the annotations and labels with the `param.nsp.tap/` prefix, and adds the keys and values in the desired-namespace ConfigMaps as parameters for that namespace.
- If you want the controller to search for a custom prefix, instead of the default `param.nsp.tap`, prefix, use the `parameter_prefixes` configuration option in the `tap-values.yaml` file. For more information, see [Customize the label and annotation prefixes that controller watches](#).



### Note

Labels take precedence over annotations if the same key is provided in both.

## Using GitOps

Add the following configuration to your `tap-values.yaml` file to add parameterized limits to your developer namespace:

```
namespace_provisioner:
 controller: false
 gitops_install:
 ref: origin/main
 subPath: ns-provisioner-samples/gitops-install-with-params
 url: https://github.com/vmware-tanzu/application-accelerator-samples.git
```

This adds `gitops_install` with this [sample GitOps location](#) to create the namespaces and manage the desired namespaces from GitOps. For more information, see the GitOps tab in [Customize Installation of Namespace Provisioner](#).

Sample of `gitops_install` files:

```
##@data/values

namespaces:
- name: dev
 limits:
 default:
 cpu: 1200m
 memory: 1.5Gi
 defaultRequest:
 cpu: 300m
 memory: 30Mi
- name: qa
```



```

#@ load("@ytt:data", "data")
#! This loop will now loop over the namespace list in
#! in ns.yaml and will create those namespaces.
#@ for ns in data.values.namespaces:

apiVersion: v1
kind: Namespace
metadata:
 name: #@ ns.name
#@ end

```

The Namespace Provisioner creates a LimitRange with default values for `qa` namespace and with the given values for `dev` namespace.

## Deactivate LimitRange Setup

The Namespace Provisioner generates a Kubernetes LimitRange object as a [default resource](#) in the namespaces it manages within the Run profile clusters. Additionally, the Namespace Provisioner offers the capability for Platform operators to enable LimitRange object stamping in Full and Iterate profile clusters using namespace parameters. The following options are available to deactivate the installation of the default LimitRange object:

### Deactivate for all namespaces

To exclude the installation of the default LimitRange, set the `skip_limit_range` parameter to `true` in the `default_parameters` section of the `tap-values.yaml` file as shown here:

```

namespace_provisioner:
 default_parameters:
 skip_limit_range: true

```

### Deactivate for a specific namespace

#### Using Namespace Provisioner Controller

To deactivate the LimitRange for a specific developer namespace, annotate or label the namespace using the [parameter](#) `skip_grype` and set its value to `true`. Use the default or customized [parameter\\_prefixes](#), for more information, as explained in the [Customize the label and annotation prefixes that controller watches](#) section.

```
kubectl annotate ns YOUR-NEW-DEVELOPER-NAMESPACE param.nsp.tap/skip_limit_range=true
```

#### Using GitOps

Add the parameter `skip_limit_range` with the value `true` in the namespaces file in the GitOps repository as shown below:

```

#@data/values

namespaces:
- name: dev
 skip_limit_range: true
 limits:
 default:
 cpu: 1200m
 memory: 1.5Gi
 defaultRequest:
 cpu: 300m

```

```
memory: 30Mi
- name: qa
```

## Install multiple scanners in the developer namespace in Namespace Provisioner

This topic tells you how to use Namespace Provisioner to automate multiple scanner installations in the developer namespace in Tanzu Application Platform (commonly known as TAP).

Grype scanner is installed by default in all namespaces managed by Namespace Provisioner.

The following steps describe how to install Snyk scanner and Grype in the developer namespace and use both together in the supply chain. Grype is used for Source scans and Snyk is used for Image scans.

For information about, how to create a developer namespace, see [Provision Developer Namespaces](#).

1. Create a secret in the `tap-install` namespace or any namespace of your preference that contains the Snyk token in YAML format. It must have `.yaml` or `.yml` in the key as shown here:

```
cat << EOF | kubectl apply -f -
apiVersion: v1
kind: Secret
metadata:
 name: scanner-auth
 namespace: tap-install
type: Opaque
stringData:
 content.yaml: |
 scanners:
 snyk_api_token: "" # Paste your snyk API token here
EOF
```

2. Add the following configuration to your `tap-values.yaml` file to create the supply-chain and scanners:

### Using Namespace Provisioner Controller

Add the following configuration to your `tap-values.yaml` file:

```
namespace_provisioner:
 controller: true
 additional_sources:
 - git:
 ref: origin/main
 subPath: ns-provisioner-samples/testing-scanning-supplychain-multiple-scanners
 url: https://github.com/vmware-tanzu/application-accelerator-samples.git
 import_data_values_secrets:
 - name: scanner-auth
 namespace: tap-install
 create_export: true
```

### Using GitOps

Add the following configuration to your `tap-values.yaml` file:

```
namespace_provisioner:
 controller: false
 additional_sources:
 - git:
```

```

 ref: origin/main
 subPath: ns-provisioner-samples/testing-scanning-supplychain-multiple-scanners
 url: https://github.com/vmware-tanzu/application-accelerator-samples.git
import_data_values_secrets:
- name: scanner-auth
 namespace: tap-install
 create_export: true
gitops_install:
 ref: origin/main
 subPath: ns-provisioner-samples/gitops-install
 url: https://github.com/vmware-tanzu/application-accelerator-samples.git

```

Additional source points to the location of the [sample GitOps repo](#) which has the following custom resources:

- `tekton-pipeline-java.yaml`: Use this to create a Tekton pipeline for running tests on the Java workload.
- `scanpolicy-grype.yaml` and `scanpolicy-snyk.yaml`: Use to create Scan policies for Grype and Snyk scanners.
- `snyk-token-secret.yaml`: This is a Snyk token secret that must be created in the developer namespace. Instead of putting the actual Snyk token in the secret in the Git repository, put the reference to the values in the scanner-auth secret created in Step 1 by using the `data.values.imported` keys.
- `snyk-scanner-install.yaml`: This contains the PackageInstall for installing the Snyk package for the developer namespace. The namespace `tap-install` is mentioned in the PackageInstall resource. This causes Namespace Provisioner to create a PackageInstall resource for all provisioned namespaces in the same namespace and add-`{namespace}` as the suffix in the name to avoid name collisions.

Run the following command to apply a workload in your developer namespace that uses Grype for source scan and Snyk for Image scan:

### Using Tanzu CLI

Create workload using tanzu apps CLI command

```

tanzu apps workload apply tanzu-java-web-app \
--git-repo https://github.com/sample-accelerators/tanzu-java-web-app \
--git-branch main \
--type web \
--app tanzu-java-web-app \
--label apps.tanzu.vmware.com/has-tests="true" \
--param scanning_image_policy=snyk-scan-policy \
--param scanning_image_template=snyk-private-image-scan-template \
--namespace YOUR-NEW-DEVELOPER-NAMESPACE \
--tail \
--yes

```

### Using workload yaml

Create a `workload.yaml` file:

```

apiVersion: carto.run/v1alpha1
kind: Workload
metadata:
 labels:
 app.kubernetes.io/part-of: tanzu-java-web-app
 apps.tanzu.vmware.com/has-tests: "true"
 apps.tanzu.vmware.com/workload-type: web
 name: tanzu-java-web-app

```

```

namespace: YOUR-NEW-DEVELOPER-NAMESPACE
spec:
 params:
 - name: scanning_image_policy
 value: snyk-scan-policy
 - name: scanning_image_template
 value: snyk-private-image-scan-template
 source:
 git:
 ref:
 branch: main
 url: https://github.com/sample-accelerators/tanzu-java-web-app

```

## Apply ScanTemplate overlays in air-gapped environments in Namespace Provisioner

This topic tells you how to use Namespace Provisioner to customize the ScanTemplates created by the `grype-scanner` PackageInstall in Namespace Provisioner. Use annotations to apply an overlay to the ScanTemplates in Tanzu Application Platform (commonly known as TAP).

Namespace Provisioner includes a pre-configured `grype-scanner` PackageInstall for each developer namespace. For more information about default resources, see [Default resources](#).

If you require customization of the ScanTemplate created by the PackageInstall, you must apply overlays to the ScanTemplate through package customization as Namespace Provisioner does not directly create the ScanTemplate. For more information on how to customize a package installation, see [Customize a package](#).

For information about potential customizations of the `grype-scanner` and troubleshooting tips, see [Use Grype in offline and air-gapped environments](#).

1. To enable updates to the ScanTemplates, create an overlay specifically designed for this purpose. When the package is processed, the overlay is applied to the ScanTemplate. It is done by the reference to this overlay in the annotation `ext.packaging.carvel.dev/ytt-paths-from-secret-name:`

```

cat << EOF | kubectl apply -f -
apiVersion: v1
kind: Secret
metadata:
 name: grype-airgap-override-stale-db-overlay
 namespace: tap-install #! namespace where tap is installed
stringData:
 patch.yaml: |
 #@ load("@ytt:overlay", "overlay")

 #@overlay/match by=overlay.subset({"kind": "ScanTemplate"}), expects="1+"

 spec:
 template:
 initContainers:
 #@overlay/match by=overlay.subset({"name": "scan-plugin"}), expects
 ="1+"
 - name: scan-plugin
 #@overlay/match missing_ok=True
 env:
 #@overlay/append
 - name: GRYPE_DB_MAX_ALLOWED_BUILT_AGE #! see note on best practi
 ces
 value: "240h"
EOF

```

- To enhance the functionality of the `grype-scanner` `PackageInstall` created by the Namespace Provisioner, create an overlay that adds the `ext.packaging.carvel.dev/ytt-paths-from-secret-name` annotation. This annotation enables the `PackageInstall` to retrieve information from the created secret with the overlay and apply it to the `ScanTemplate`.

```
cat << EOF | kubectl apply -f -
apiVersion: v1
kind: Secret
metadata:
 name: grype-airgap-override-stale-db-overlay-for-nsp
 namespace: tap-install # or any other namespaces from where nsp will import the secret
stringData:
 patch-grype-install-in-nsp.yaml: |
 #@ load("@ytt:overlay", "overlay")
 #@ def matchGrypeScanners(index, left, right):
 #@ if left["apiVersion"] != "packaging.carvel.dev/v1alpha1" or left["kind"] != "PackageInstall":
 #@ return False
 #@ end #@ return left["metadata"]["name"].startswith("grype-scanner")
 #@ end
 #@overlay/match by=matchGrypeScanners, expects="0+"

 metadata:
 annotations:
 #@overlay/match missing_ok=True
 ext.packaging.carvel.dev/ytt-paths-from-secret-name.0: grype-airgap-override-stale-db-overlay
 #! The value of the above annotation is the name of the secret that contains the grype overlay
EOF
```

- Update the `tap-values.yaml` file as follows so the overlay is applied to the `PackageInstall`. For more information, see [Import overlay secrets](#).

```
namespace_provisioner:
 overlay_secrets:
 - create_export: true
 name: grype-airgap-override-stale-db-overlay-for-nsp
 namespace: tap-install # or any other namespaces from where nsp will import the secret
```

## Work with Git repositories in air-gapped environments with Namespace Provisioner

This topic provides instructions for configuring Namespace Provisioner to use air-gapped Git repositories. This allows you to store GitOps-based installation files and platform operator-templated resources intended for creation in your developer namespace in Tanzu Application Platform (TAP).

### Git authentication

Authentication is established through a secret in the `tap-namespace-provisioning` namespace or an existing secret in another namespace referenced in the `secretRef` in `additional_sources`. For more details, refer to [Customize Installation of Namespace Provisioner](#).

### Create the Git authentication secret in `tap-namespace-provisioning` namespace

The Git authentication secrets support the following keys: `ssh-privatekey`, `ssh-knownhosts`, `username`, and `password`. If `ssh-knownhosts` is not specified, Git does not perform strict host checking.



### Important

In air-gapped environments or other scenarios where external services are secured by a Custom CA certificate, configure kapp-controller with the CA certificate data to prevent X.509 certificate errors. For more information, see [Deploy onto Cluster](#) in the Cluster Essentials for VMware Tanzu documentation.

1. Create the Git secret:

#### Using HTTP(s) based authentication

If you are using user name and password for authentication:

```
cat << EOF | kubectl apply -f -
apiVersion: v1
kind: Secret
metadata:
 name: git-auth
 namespace: tap-namespace-provisioning
type: Opaque
stringData:
 username: GIT-USERNAME
 password: GIT-PASSWORD
EOF
```

#### Using SSH based authentication

If you are using SSH private key for authentication:

```
cat << EOF | kubectl apply -f -
apiVersion: v1
kind: Secret
metadata:
 name: git-auth
 namespace: tap-namespace-provisioning
type: Opaque
stringData:
 ssh-privatekey: |
 -----BEGIN OPENSSSH PRIVATE KEY-----
 ...
 -----END OPENSSSH PRIVATE KEY-----
EOF
```

2. Add the `secretRef` section to the `additional_sources` and the `gitops_install` section of your `tap-values.yaml` file:

#### Using Namespace Provisioner Controller

Description

```
namespace_provisioner:
 controller: true
 additional_sources:
 - git:
 ref: origin/main
 subPath: sources
```

```

This example URL is for SSH auth. Use https:// path if using HTTPS au
th
url: git@git-airgap-server:private-repo-org/repo.git
secretRef:
 name: git-auth

```

### Using GitOps

#### Description

**Caution** In kapp-controller v0.46.0 and earlier, there is a limitation that prevents the reuse of the same Git secret multiple times. If you have multiple additional sources using repositories with identical credentials, you must create distinct secrets, each with the same authentication details.

In this example, the list of namespaces resides in a repository. Therefore, you must create a secret named `git-auth-install` with the same authentication details for this location.

```

namespace_provisioner:
 controller: false
 additional_sources:
 - git:
 ref: origin/main
 subPath: tekton-pipelines
 # This example URL is for SSH auth. Use https:// path if using HTTPS au
th
 url: git@git-airgap-server:private-repo-org/repo.git
 secretRef:
 name: git-auth
 gitops_install:
 ref: origin/main
 subPath: gitops-install
 # This example URL is for SSH auth. Use https:// path if using HTTPS auth
url: git@git-airgap-server:private-repo-org/repo.git
secretRef:
 name: git-auth-install

```

## Import from another namespace

If you already have a Git secret created in a namespace other than the `tap-namespace-provisioning` namespace and you want to refer to it, the `secretRef` section must include the namespace and the `create_export` flag. The default value for `create_export` is `false`, assuming the secret is already exported for the `tap-namespace-provisioning` namespace. However, you can specify if you want Namespace Provisioner to create a Carvel `SecretExport` for that secret.

In this example, the `secretRef` section refers to the `git-auth` secret from the `tap-install` namespace.

### Using Namespace Provisioner Controller

#### Description

```

namespace_provisioner:
 controller: true
 additional_sources:
 - git:
 ref: origin/main
 subPath: sources
 #! This example URL is for SSH auth. Use https:// path if using HTTPS auth
url: git@git-airgap-server:private-repo-org/repo.git

```

```
secretRef:
 name: git-auth
 namespace: tap-install
 #! If this secret is already exported for this namespace, you can ignore the
 create_export key as it defaults to false
 create_export: true
```

## Using GitOps

### Description

```
namespace_provisioner:
 controller: false
 additional_sources:
 - git:
 ref: origin/main
 subPath: tekton-pipelines
 #! This example URL is for SSH auth. Use https:// path if using HTTPS auth
 url: git@git-airgap-server:private-repo-org/repo.git
 secretRef:
 name: git-auth
 namespace: tap-install
 #! If this secret is already exported for this namespace, you can ignore the
 create_export key as it defaults to false
 create_export: true
 gitops_install:
 ref: origin/main
 subPath: gitops-install
 #! This example URL is for SSH auth. Use https:// path if using HTTPS auth
 url: git@git-airgap-server:private-repo-org/repo.git
 secretRef:
 name: git-auth-install
 namespace: tap-install
 #! If this secret is already exported for this namespace, you can ignore the
 create_export key as it defaults to false
 create_export: true
```

After reconciliation, Namespace Provisioner creates:

- [SecretExport](#) for the secret in the provided namespace, exporting it to the Namespace Provisioner namespace, for example, `tap-install`
- [SecretImport](#) for the secret in the `tap-namespace-provisioning` namespace. This enables Carvel [secretgen-controller](#) to create the required secret, allowing Namespace Provisioner to connect to the Git repository.

## Git authentication for workloads and supply chain

When fetching or pushing source code to a repository that requires credentials, it's essential to provide those credentials through a Kubernetes secret object referenced by the corresponding Kubernetes object created for the action. The following sections describe setting up Kubernetes secrets to securely pass these credentials to the relevant resources. This procedure provides the steps to configure the `default` service account to interact with Git repositories for workloads and supply chain using Namespace Provisioner.

Set up the service account to interact with Git repositories:

1. Create a secret in the `tap-install` namespace or any preferred namespace, containing Git credentials in YAML format.
  - `host`, `username`, `caFile` and `password` or `personal access token` values for HTTP-based Git authentication.



- `ssh-privatekey`, `identity`, `identity_pub`, and `known_hosts` for SSH-based Git authentication.



### Note

The `stringData` key of the secret must end with either the `.yaml` or `.yml` suffix.

### Using HTTP(s) based authentication

If using user name and password for authentication.

In this configuration for an air-gapped environment, the Git repository server has a custom certificate of authority that cannot be verified against public issuers, so you must provide the `caFile` content to log in against it.

```
cat << EOF | kubectl apply -f -
apiVersion: v1
kind: Secret
metadata:
 name: workload-git-auth
 namespace: tap-install
type: Opaque
stringData:
 content.yaml: |
 git:
 #! For HTTP Auth. Recommend using https:// for the git server.
 host: GIT-SERVER
 username: GIT-USERNAME
 password: GIT-PASSWORD
 caFile: |
 -----BEGIN CERTIFICATE-----
 ...
 -----END CERTIFICATE-----
EOF
```

### Using SSH based authentication

To use an SSH private key for authentication, create the Git secret with the authentication details as follows:

```
cat << EOF | kubectl apply -f -
apiVersion: v1
kind: Secret
metadata:
 name: workload-git-auth
 namespace: tap-install
type: Opaque
stringData:
 content.yaml: |
 git:
 host: GIT-SERVER
 #! For SSH Auth
 ssh_privatekey: SSH-PRIVATE-KEY
 identity: SSH-PRIVATE-KEY
 identity_pub: SSH-PUBLIC-KEY
 known_hosts: GIT-SERVER-PUBLIC-KEYS
EOF
```

2. To create a secret to be added to the service account in the developer namespace in the GitOps repository, use this [example](#) for HTTP-based or this [example](#) for `settings.xml`-based,

or follow the example below.

Rather than directly including the actual user name and password in the Git repository secret, use the `data.values.imported` keys to add references to the values from the `git-auth` secret created in the previous step.

This secret represents the Git secret that is created by the Namespace Provisioner in each managed namespace. It must be included in your Git repository linked in the `additional_sources` section of `tap-values.yaml` mentioned in the next step.

### Using HTTP(s) based authentication

If using user name and password for authentication.

In this configuration for an air-gapped environment, the Git repository server has a custom certificate of authority that cannot be verified against public issuers, so you must provide the `caFile` content to log in against it.

```
#@ load("@ytt:data", "data")

apiVersion: v1
kind: Secret
metadata:
 name: git
 annotations:
 tekton.dev/git-0: #@ data.values.imported.git.host
type: kubernetes.io/basic-auth
stringData:
 username: #@ data.values.imported.git.username
 password: #@ data.values.imported.git.token
 caFile: #@ data.values.imported.git.caFile
```

### Using settings.xml based authentication for Java applications

If using user name and password for authentication.

```
#@ load("@ytt:data", "data")

apiVersion: v1
kind: Secret
metadata:
 name: settings-xml
type: service.binding/maven
stringData:
 type: maven
 provider: sample
 #@yaml/text-templated-strings
 settings.xml: |
 <settings xmlns="http://maven.apache.org/SETTINGS/1.0.0" xmlns:xsi="http://www.w3.org/2001/XMLSchema-instance"
 xsi:schemaLocation="http://maven.apache.org/SETTINGS/1.0.0 https://maven.apache.org/xsd/settings-1.0.0.xsd">
 <mirrors>
 <mirror>
 <id>reposilite</id>
 <name>Accelerator samples</name>
 <url>{@= data.values.imported.git.host @} /vmware-tanzu/application-accelerator-samples</url>
 <mirrorOf>*</mirrorOf>
 </mirror>
 </mirrors>
 <servers>
 <server>
 <id>reposilite</id>
 <username>{@= data.values.imported.git.username @}</username>
```

```

 <password>{@= data.values.imported.git.password @}</password>
 </server>
</servers>
</settings>

```

### Using SSH based authentication

If using SSH private key for authentication:

```

#@ load("@ytt:data", "data")

apiVersion: v1
kind: Secret
metadata:
 name: git
 annotations:
 tekton.dev/git-0: #@ data.values.imported.git.host
type: kubernetes.io/basic-auth
stringData:
 identity: #@ data.values.imported.git.identity
 identity.pub: #@ data.values.imported.git.identity_pub
 known_hosts: #@ data.values.imported.git.known_hosts
 ssh-privatekey: #@ data.values.imported.git.ssh_privatekey

```

- Combine this `tap-values.yaml`:

### Using Namespace Provisioner Controller

Add the following configuration to `tap-values.yaml`:

```

namespace_provisioner:
 controller: true
 additional_sources:
 - git:
 ref: origin/main
 subPath: ns-provisioner-samples/credentials
 url: https://git-airgap-server/application-accelerator-samples.git
 import_data_values_secrets:
 - name: workload-git-auth
 namespace: tap-install
 create_export: true
 default_parameters:
 supply_chain_service_account:
 secrets:
 - git

```

Where `https://git-airgap-server/application-accelerator-samples.git` is a fork of the `application-accelerator-samples` repository.

### Using GitOps

Add the following configuration to `tap-values.yaml`:

```

namespace_provisioner:
 controller: false
 additional_sources:
 - git:
 ref: origin/main
 subPath: ns-provisioner-samples/credentials
 url: https://git-airgap-server/vmware-tanzu/application-accelerator-sam
ples.git
 gitops_install:
 ref: origin/main
 subPath: ns-provisioner-samples/gitops-install
 url: https://git-airgap-server/vmware-tanzu/application-accelerator-sampl

```

```

es.git
 import_data_values_secrets:
 - name: workload-git-auth
 namespace: tap-install
 create_export: true
 default_parameters:
 supply_chain_service_account:
 secrets:
 - git

```

Where <https://git-airgap-server/application-accelerator-samples.git> is a fork of the [application-accelerator-samples](#) repository.

- `additional_sources` points to the location where the templated Git secret resides, which is created in all developer namespaces.
- Import the newly created `workload-git-auth` secret into Namespace Provisioner to use in `data.values.imported` by adding the secret to `import_data_values_secrets`.
- Add the secret to be included in the ServiceAccount in the `default_parameters`. For more information, see [Customize service accounts](#).



#### Note

`create_export` is set to `true` in `import_data_values_secrets`. As a result, a `SecretExport` is automatically created for the `workload-git-auth` secret in the `tap-install` namespace by Namespace Provisioner. After the changes are reconciled, the secret named `git` is present in all provisioned namespaces and is also added to the default service account of those namespaces.

4. In your `tap-values.yaml` file, in the `ootb_supply_chain_*.gitops.ssh_secret` section, specify the name of the Git secret containing the credentials. This is necessary for the supply chain to include the `secretRef` when creating the Flux `GitRepository` resource. For example:

```

ootb_supply_chain_testing_scanning:
 gitops:
 ssh_secret: git # Replace with the actual name of your Git secret for the
 workload, if different

```

By providing this configuration, the supply chain associates the created `GitRepository` resource with the specified Git secret managed by Namespace Provisioner.

5. Create the workload:

#### Using HTTP/HTTPS or SSH-based

If using user name and password for authentication.

```

tanzu apps workload apply APP-NAME \
--git-repo GIT-REPO \
--git-branch BRANCH \
--type web \
--app APP-NAME \
--label apps.tanzu.vmware.com/has-tests="true" \
--namespace DEV-NAMESPACE \
--tail \
--yes

```

#### Using settings.xml based authentication for Java applications

If using user name and password for authentication.

```
tanzu apps workload apply APP-NAME \
--git-repo GIT_REPO \
--git-branch BRANCH \
--type web \
--app APP-NAME \
--label apps.tanzu.vmware.com/has-tests="true" \
--namespace DEV-NAMESPACE \
--param-yaml buildServiceBindings='[{"name": "settings-xml", "kind": "Secret"}]'
```

## Troubleshoot Namespace Provisioner

This topic tells you how to troubleshoot Namespace Provisioner in Tanzu Application Platform (commonly known as TAP).

### Air-gapped installation

Namespace Provisioner relies on kapp-controller for any tasks involving communication with external services, such as registries or Git repositories. When operating in air-gapped environments or other scenarios where external services are secured by a Custom CA certificate, you must configure kapp-controller with the CA certificate data to prevent X.509 certificate errors. For more information, see [Deploy onto Cluster](#) in the Cluster Essentials for VMware Tanzu documentation.

### View controller logs

To get the logs when using the [controller](#) workflow, run the following kubectl command:

```
kubectl -n tap-namespace-provisioning logs deployments/controller-manager
```

Use `-f` to follow the log output.

### Provisioner application error

After the Namespace Provisioner is installed in the Tanzu Application Platform cluster, the main resource to check is the [provisioner](#) Carvel Application in the `tap-namespace-provisioning` namespace. To check for the status of the Application, run the following kubectl command:

```
kubectl -n tap-namespace-provisioning get app/provisioner --template={{.status.usefulErrorMessage}}
```

## Common errors

You might encounter one of the following errors:

### Namespace selector malformed

When using the [controller](#) and customizing the `namespace_selector` from `tap_values.yaml`, the match expression must be compliant with the [Kubernetes label selector](#). If it is not compliant, the Namespace Provisioner controller fails and log an error message in the controller logs.

For example, if the configured `namespace_selector` is as follows:

```
namespace_provisioner:
 controller: true
 namespace_selector:
 matchExpressions:
 - key: apps.tanzu.vmware.com/tap-ns
 operator: exists
```

This is not compliant as the operator must be `Exist` instead of `exists`. When labeling the namespace `dev` with `apps.tanzu.vmware.com/tap-ns`, the `controller` produces an error message similar to the following, (followed by some reconciliation messages)

```
{"level":"error","ts":"2022-12-14T15:41:44.639402794Z","logger":".0.1.NamespaceSelectorReconciler","msg":"unable to sync","controller":"namespace","controllerGroup":"","controllerKind":"Namespace","Namespace":{"name":"dev"},"namespace":"","name":"dev","reconcileID":"26395d34-418b-446d-9b5e-a4a73cc657ed","resourceType":"/v1, Kind=Namespace","error":"\"exists\" is not a valid pod selector operator","stacktrace":"..."}
```

## Debugging ytt templating errors in additional sources

When working with ytt, templating errors in the additional sources in your GitOps repository can cause the Provisioner Carvel application to go into `Reconcile Failed` state. To debug the Application, run the following command:

```
kubectl -n tap-namespace-provisioning get app/provisioner --template={{.status.usefulErrorMessage}}
```

Sample Error message from Application when there is a ytt templating error:

```
ytt: Error:
- library.eval: Evaluating library 'witherror':
 in <toplevel>
 template.yaml:155 | #@ instances = overlay.apply(instance.eval(), customize())
 reason:
 - struct has no .gl_secret_user field or method
 in <toplevel>
 _ytt_lib/witherror/secrets.yaml:12 | username: #@ data.values.gl_secret_user
```

## Unable to delete namespace

When a user tries to delete a namespace that was managed by Namespace Provisioner, it gets stuck in the `Terminating` status.

**Possible Cause 1:** When a provisioned namespace that has a Cartographer Workload in it is deleted, the namespace will likely remain in the Terminating state because some resources can not be deleted. One of the causes of this behavior is that the Cartographer Workload using the Out of the Box supply chains and delivery creates a Carvel Kapp App for the workload that references the ServiceAccount in the namespace. Deleting the namespace deletes the Service Account that Kapp relies on before the App itself is deleted. As a result, the Carvel App blocks the namespace termination while waiting for the ServiceAccount to exist with a `finalizer` (`finalizers.kapp-ctrl.k14s.io/delete`) message.

**Solution:** Remove the Kapp App finalizer in the Kapp App

**Possible Cause 2:** If you try to delete a namespace that was previously managed by the `controller`, and the namespace was not cleaned up before disabling the controller, it gets stuck in the `Terminating` state. This happens because the controller adds a `finalizer` to the namespaces

([namespace-provisioner.apps.tanzu.vmware.com/finalizer](https://namespace-provisioner.apps.tanzu.vmware.com/finalizer)) it manages, and is no longer there to clean up that finalizer as it was deactivated by the user.

**Solution:** Remove manually the finalizer in the namespace

## Namespace Provisioner reference

This section tells you about known issues and limitations, default resources, and parameters in Namespace Provisioner.

[Known limitations and issues](#)

[Default resources](#)

[Parameters](#)

## Known limitations and issues in Namespace Provisioner

This topic tells you about the known issues and limitations for Namespace Provisioner in Tanzu Application Platform (commonly known as TAP).

- If you are using a GitOps repository to manage the list of namespaces, all the namespaces in the list must exist in the cluster. The provisioner application fails to reconcile if the namespaces do not exist on the cluster.
- To use different private repositories, the secret used for each entry must be a unique name, for example, `gitops_install`, or `additional_sources`. Reusing the same secret is not supported due to a limitation in kapp-controller.
- Before performing any operations, such as uninstalling the Namespace Provisioner or changing from Controller mode to GitOps mode, ensure that you edit the namespaces managed by the Namespace Provisioner in the `namespace-provisioner.apps.tanzu.vmware.com/finalizer` finalizer. Either remove the label used to set the namespaces as managed or edit the namespace manifest and remove the finalizer entry. For more information, see [Manage a list of developer namespaces](#).

## Default resources

This topic tells you about the resources that are templated in the default-resources secret for the different installation profile and supply chain value combinations in Tanzu Application Platform (commonly known as TAP).

Namespace Provisioner is installed as part of the full, iterate, build, and run installation profiles. The default set of resources provisioned in a namespace is based on a combination of the installation profile employed and the supply chain that is installed on the cluster. For more information about installation profiles, see [Installation profiles in Tanzu Application Platform](#).

The following table shows the list of resources that are templated in the default-resources secret for each installation profile and supply chain value combination:

Namespace	Kind	Name	supply_chain	Install Profile	Reconcile
tap-install	PackageInstallation	grype-scanner-{ns}	testing_scanning	full, build	Yes
tap-install	Secret	grype-scanner-{ns}	testing_scanning	full, build	Yes
Developer Namespace	Secret	registries-credentials	n/a	full, iterate, build, run	Yes

Namespace	Kind	Name	supply_chain	Install Profile	Reconcile
Developer Namespace	ServiceAccount	From: ootb_supply_chain_{supply_chain}.service_account (default: "default")	n/a	full, iterate, build, run	No
Developer Namespace	ServiceAccount	From: ootb_delivery_basic.service_account (default: "default")	n/a	full, iterate, run	No
Developer Namespace	RoleBinding	default-permit-deliverable	n/a	full, iterate, run	Yes
Developer Namespace	RoleBinding	default-permit-workload	n/a	full, iterate, build	Yes
Developer Namespace	LimitRange	{namespace}-lr	n/a	run	Yes

For installing additional resources for OOTB Supply Chain with Testing and Scanning, see [Supply Chain Security Tools - Scan](#).

## Customize namespaces in Namespace Provisioner

This topic tells you how to use Namespace Provisioner to customize namespaces in controller mode in Tanzu Application Platform (commonly known as TAP).

When managing multiple developer namespaces in a cluster, it is often necessary to customize each namespace individually. To customize a namespace in controller mode, add parameters to a namespace through labels and annotations using either the default prefix or a custom-defined prefix.

In GitOps mode, you can configure these parameters in the GitOps file. For more information, see [Customize the label and annotation prefixes that controller watches](#).



### Caution

If a parameter is initially created through annotations and later a label with the same key is used, the annotation is overwritten.

## Parameter key

- The format for specifying the parameter is: `<prefix>/<parameter-key>=<parameter-value>`.
- The parameter key can be a single string or a pseudo JSON-path structure, for example, `key1.inner-key1.inner-key3.inner-key4`. This is translated into a structured format in the values.
- The label value can only be a string.
- If you need to pass a list or another object as the parameter value, annotations should be used instead. Annotations support using `[]` to define lists and `{}` to define objects
- All parameters created with labels and annotations can be utilized when using templates for resources in `ytt additional_sources` from `data.values`.

Examples:

1. To define a list of tools used by the namespace:

```
kubectl annotate ns dev param.nsp.tap/project.tools='["git", "maven"]'
```



The `desired-namespaces` ConfigMap will look like:

```
#@data/values

namespaces:
- name: dev
 project:
 tools:
 - git
 - maven
```

2. To add a list of objects:

```
kubectl annotate ns dev param.nsp.tap/volume.claims='[{"name": "logs", "mountPath": "/var/logs/app"}, {"name": "truststore", "mountPath": "/opt/app/ssl"}]
```

The `desired-namespaces` ConfigMap will look like:

```
#@data/values

namespaces:
- name: dev
 volume:
 claims:
 - name: logs
 mountPath: /var/logs/app
 - name: truststore
 mountPath: /opt/app/ssl
```

3. Simple key-value:

```
kubectl annotate ns dev param.nsp.tap/scanpolicy=relaxed
```

The `desired-namespaces` ConfigMap will look like:

```
#@data/values

namespaces:
- name: dev
 scanpolicy: relaxed
```

4. Object as value:

```
kubectl annotate ns dev param.nsp.tap/maven.values='{"username": "user", "password": "my-pass", "repo": "myrepo", "version": "0.1.1-alpha.0"}'
```

The `desired-namespaces` ConfigMap will look like:

```
#@data/values

namespaces:
- name: dev
 maven:
 values:
 username: user
 password: my-pass
 repo: myrepo
 Version: 0.1.1-alpha.0
```

## Reserved Namespace Parameters

Namespace Provisioner reserves certain parameters for its use. The following is a list of parameters used by the Namespace Provisioner, which apply to both the `default_parameters` in `tap-values.yaml` and the namespace parameters through labels and annotations:

- `limits` (object): Use to configure the LimitRange. For more information, see [Customize Limit Range defaults](#).
- `skip_limit_range` (boolean): Use to determine if the LimitRange should be created. For more information, see [Customize Limit Range defaults](#).
- `skip_grype` (boolean): Use to determine if Grype scanner resources are going to be created. For more information, see [Deactivate Grype install](#).
- `supply_chain_service_account` (object): Contains the secrets and imagePullSecrets to be added to the Supply Chain ServiceAccount. For more information, see [Customize service accounts](#).
- `delivery_service_account` (object): Contains the secrets and imagePullSecrets to be added to the delivery ServiceAccount. For more information, see [Customize service accounts](#).

## Overview of Service Bindings

This topic tells you about using Service Bindings in Tanzu Application Platform (commonly know as TAP).

### Supported service binding specifications

Service Bindings packages the [Service Binding for Kubernetes](#) open source project.

It implements the [Service Binding Specification for Kubernetes v1.0](#).

This implementation provides support for:

- [Provisioned Service](#)
- [Workload Projection](#)
- [Service Binding](#)
- [Direct Secret Reference](#)
- [Role-Based Access Control \(RBAC\)](#)

The following are not supported:

- [Workload Resource Mapping](#)
- Extensions including:
  - [Binding Secret Generation Strategies](#)

## Overview of Service Bindings

This topic tells you about using Service Bindings in Tanzu Application Platform (commonly know as TAP).

### Supported service binding specifications

Service Bindings packages the [Service Binding for Kubernetes](#) open source project.

It implements the [Service Binding Specification for Kubernetes v1.0](#).

This implementation provides support for:

- [Provisioned Service](#)
- [Workload Projection](#)
- [Service Binding](#)
- [Direct Secret Reference](#)
- [Role-Based Access Control \(RBAC\)](#)

The following are not supported:

- [Workload Resource Mapping](#)
- Extensions including:
  - [Binding Secret Generation Strategies](#)

## Install Service Bindings

This topic tells you how to install Service Bindings from the Tanzu Application Platform (commonly known as TAP) package repository.



### Note

Follow the steps in this topic if you do not want to use a profile to install Service Bindings. For more information about profiles, see [Components and installation profiles](#).

## Prerequisites

Before installing Service Bindings:

- Complete all prerequisites to install Tanzu Application Platform (commonly known as TAP). For more information, see [Prerequisites](#).

## Install Service Bindings

Use the following procedure to install Service Bindings:

1. List version information for the package by running:

```
tanzu package available list service-bindings.labs.vmware.com --namespace tap-
install
```

For example:

```
$ tanzu package available list service-bindings.labs.vmware.com --namespace tap
-install
- Retrieving package versions for service-bindings.labs.vmware.com...
NAME VERSION RELEASED-AT
service-bindings.labs.vmware.com 0.5.0 2021-09-15T00:00:00Z
```

2. Install the package by running:

```
tanzu package install service-bindings -p service-bindings.labs.vmware.com -v
0.5.0 -n tap-install
```

Example output:

```

/ Installing package 'service-bindings.labs.vmware.com'
| Getting namespace 'tap-install'
- Getting package metadata for 'service-bindings.labs.vmware.com'
| Creating service account 'service-bindings-tap-install-sa'
| Creating cluster admin role 'service-bindings-tap-install-cluster-role'
| Creating cluster role binding 'service-bindings-tap-install-cluster-rolebinding'
\ Creating package resource
| Package install status: Reconciling

Added installed package 'service-bindings' in namespace 'tap-install'

```

3. Verify the package install by running:

```
tanzu package installed get service-bindings -n tap-install
```

Example output:

```

- Retrieving installation details for service-bindings...
NAME: service-bindings
PACKAGE-NAME: service-bindings.labs.vmware.com
PACKAGE-VERSION: 0.5.0
STATUS: Reconcile succeeded
CONDITIONS: [{ReconcileSucceeded True }]
USEFUL-ERROR-MESSAGE:

```

4. Run the following command:

```
kubectl get pods -n service-bindings
```

For example:

```

$ kubectl get pods -n service-bindings
NAME READY STATUS RESTARTS AGE
manager-6d85ffffbcd-j4gvs 1/1 Running 0 22s

```

Verify that **STATUS** is **Running**

## Troubleshoot Service Bindings

This topic tells you how to troubleshoot Service Bindings in Tanzu Application Platform (commonly known as TAP).

### Collect logs

To help identify issues when troubleshooting, you can retrieve and examine logs from the service binding manager.

To retrieve pod logs from the **manager** running in the **service-bindings** namespace, run:

```
kubectl -n service-bindings logs -l role=manager
```

For example:

```

$ kubectl -n service-bindings logs -l role=manager

2021/11/05 15:25:28 Registering 3 clients
2021/11/05 15:25:28 Registering 3 informer factories
2021/11/05 15:25:28 Registering 7 informers
2021/11/05 15:25:28 Registering 8 controllers

```

```

{"severity":"INFO","timestamp":"2021-11-05T15:25:28.483823208Z","caller":"logging/nfi
g.go:116","message":"Successfully created the logger."}
{"severity":"INFO","timestamp":"2021-11-05T15:25:28.48392361Z","caller":"logging/confi
g.go:117","message":"Logging level set to: info"}
{"severity":"INFO","timestamp":"2021-11-05T15:25:28.483999911Z","caller":"logging/conf
ig.go:79","message":"Fetch GitHub commit ID from kodata failed","error":"open /var/ru
n/ko/HEAD: no such file or directory"}
{"severity":"INFO","timestamp":"2021-11-05T15:25:28.484035711Z","logger":"webhook","ca
ller":"profiling/server.go:64","message":"Profiling enabled: false"}
{"severity":"INFO","timestamp":"2021-11-05T15:25:28.522884909Z","logger":"webhook","ca
ller":"leaderelection/context.go:46","message":"Running with Standard leader electio
n"}
{"severity":"INFO","timestamp":"2021-11-05T15:25:28.523358615Z","logger":"webhook","ca
ller":"provisionedservice/controller.go:31","message":"Setting up event handlers."}
...
{"severity":"ERROR","timestamp":"2021-11-17T12:30:24.557178813Z","logger":"webhook","c
aller":"controller/controller.go:548","message":"Reconcile error","duration":"276.504µ
s","error":"deployments.apps \"spring-petclinic\" not found","stacktrace":"knative.de
v/pkg/controller.(*Impl).handleErr\n\tknative.dev/pkg/v0.0-20210331065221-952fdd90db
b0/controller/controller.go:548\nknative.dev/pkg/controller.(*Impl).processNextWorkIte
m\n\tknative.dev/pkg/v0.0-20210331065221-952fdd90dbb0/controller/controller.go:531\n
knative.dev/pkg/controller.(*Impl).RunContext.func3\n\tknative.dev/pkg/v0.0-20210331
065221-952fdd90dbb0/controller/controller.go:468"}
{"severity":"ERROR","timestamp":"2021-11-17T12:47:04.558217679Z","logger":"webhook","c
aller":"controller/controller.go:548","message":"Reconcile error","duration":"249.103µ
s","error":"deployments.apps \"spring-petclinic\" not found","stacktrace":"knative.de
v/pkg/controller.(*Impl).handleErr\n\tknative.dev/pkg/v0.0-20210331065221-952fdd90db
b0/controller/controller.go:548\nknative.dev/pkg/controller.(*Impl).processNextWorkIte
m\n\tknative.dev/pkg/v0.0-20210331065221-952fdd90dbb0/controller/controller.go:531\n
knative.dev/pkg/controller.(*Impl).RunContext.func3\n\tknative.dev/pkg/v0.0-20210331
065221-952fdd90dbb0/controller/controller.go:468"}
{"severity":"ERROR","timestamp":"2021-11-17T13:03:44.558683121Z","logger":"webhook","c
aller":"controller/controller.go:548","message":"Reconcile error","duration":"177.403µ
s","error":"deployments.apps \"spring-petclinic\" not found","stacktrace":"knative.de
v/pkg/controller.(*Impl).handleErr\n\tknative.dev/pkg/v0.0-20210331065221-952fdd90db
b0/controller/controller.go:548\nknative.dev/pkg/controller.(*Impl).processNextWorkIte
m\n\tknative.dev/pkg/v0.0-20210331065221-952fdd90dbb0/controller/controller.go:531\n
knative.dev/pkg/controller.(*Impl).RunContext.func3\n\tknative.dev/pkg/v0.0-20210331
065221-952fdd90dbb0/controller/controller.go:468"}
{"severity":"ERROR","timestamp":"2021-11-17T13:20:24.559192644Z","logger":"webhook","c
aller":"controller/controller.go:548","message":"Reconcile error","duration":"223.203µ
s","error":"deployments.apps \"spring-petclinic\" not found","stacktrace":"knative.de
v/pkg/controller.(*Impl).handleErr\n\tknative.dev/pkg/v0.0-20210331065221-952fdd90db
b0/controller/controller.go:548\nknative.dev/pkg/controller.(*Impl).processNextWorkIte
m\n\tknative.dev/pkg/v0.0-20210331065221-952fdd90dbb0/controller/controller.go:531\n
knative.dev/pkg/controller.(*Impl).RunContext.func3\n\tknative.dev/pkg/v0.0-20210331
065221-952fdd90dbb0/controller/controller.go:468"}
{"severity":"ERROR","timestamp":"2021-11-17T13:37:04.559648412Z","logger":"webhook","c
aller":"controller/controller.go:548","message":"Reconcile error","duration":"173.003µ
s","error":"deployments.apps \"spring-petclinic\" not found","stacktrace":"knative.de
v/pkg/controller.(*Impl).handleErr\n\tknative.dev/pkg/v0.0-20210331065221-952fdd90db
b0/controller/controller.go:548\nknative.dev/pkg/controller.(*Impl).processNextWorkIte
m\n\tknative.dev/pkg/v0.0-20210331065221-952fdd90dbb0/controller/controller.go:531\n
knative.dev/pkg/controller.(*Impl).RunContext.func3\n\tknative.dev/pkg/v0.0-20210331
065221-952fdd90dbb0/controller/controller.go:468"}
{"severity":"ERROR","timestamp":"2021-11-17T13:53:44.56010516Z","logger":"webhook","ca
ller":"controller/controller.go:548","message":"Reconcile error","duration":"182.402µ
s","error":"deployments.apps \"spring-petclinic\" not found","stacktrace":"knative.de
v/pkg/controller.(*Impl).handleErr\n\tknative.dev/pkg/v0.0-20210331065221-952fdd90db
b0/controller/controller.go:548\nknative.dev/pkg/controller.(*Impl).processNextWorkIte
m\n\tknative.dev/pkg/v0.0-20210331065221-952fdd90dbb0/controller/controller.go:531\n
knative.dev/pkg/controller.(*Impl).RunContext.func3\n\tknative.dev/pkg/v0.0-20210331
065221-952fdd90dbb0/controller/controller.go:468"}
{"severity":"ERROR","timestamp":"2021-11-17T14:10:24.560536033Z","logger":"webhook","c
aller":"controller/controller.go:548","message":"Reconcile error","duration":"155.603µ
s","error":"deployments.apps \"spring-petclinic\" not found","stacktrace":"knative.de

```

```
v/pkg/controller.(*Impl).handleErr\n\tknative.dev/pkg/v0.0.0-20210331065221-952fdd90dbb0/controller/controller.go:548\nknative.dev/pkg/controller.(*Impl).processNextWorkItem\n\tknative.dev/pkg/v0.0.0-20210331065221-952fdd90dbb0/controller/controller.go:531\nknative.dev/pkg/controller.(*Impl).RunContext.func3\n\tknative.dev/pkg/v0.0.0-20210331065221-952fdd90dbb0/controller/controller.go:468"}
{"severity":"ERROR","timestamp":"2021-11-17T14:27:04.560960243Z","logger":"webhook","caller":"controller/controller.go:548","message":"Reconcile error","duration":"171.002µs","error":"deployments.apps \"spring-petclinic\" not found","stacktrace":"knative.dev/pkg/controller.(*Impl).handleErr\n\tknative.dev/pkg/v0.0.0-20210331065221-952fdd90dbb0/controller/controller.go:548\nknative.dev/pkg/controller.(*Impl).processNextWorkItem\n\tknative.dev/pkg/v0.0.0-20210331065221-952fdd90dbb0/controller/controller.go:531\nknative.dev/pkg/controller.(*Impl).RunContext.func3\n\tknative.dev/pkg/v0.0.0-20210331065221-952fdd90dbb0/controller/controller.go:468"}
{"severity":"ERROR","timestamp":"2021-11-17T14:43:44.56142548Z","logger":"webhook","caller":"controller/controller.go:548","message":"Reconcile error","duration":"179.203µs","error":"deployments.apps \"spring-petclinic\" not found","stacktrace":"knative.dev/pkg/controller.(*Impl).handleErr\n\tknative.dev/pkg/v0.0.0-20210331065221-952fdd90dbb0/controller/controller.go:548\nknative.dev/pkg/controller.(*Impl).processNextWorkItem\n\tknative.dev/pkg/v0.0.0-20210331065221-952fdd90dbb0/controller/controller.go:531\nknative.dev/pkg/controller.(*Impl).RunContext.func3\n\tknative.dev/pkg/v0.0.0-20210331065221-952fdd90dbb0/controller/controller.go:468"}
{"severity":"ERROR","timestamp":"2021-11-17T15:00:24.561881861Z","logger":"webhook","caller":"controller/controller.go:548","message":"Reconcile error","duration":"167.902µs","error":"deployments.apps \"spring-petclinic\" not found","stacktrace":"knative.dev/pkg/controller.(*Impl).handleErr\n\tknative.dev/pkg/v0.0.0-20210331065221-952fdd90dbb0/controller/controller.go:548\nknative.dev/pkg/controller.(*Impl).processNextWorkItem\n\tknative.dev/pkg/v0.0.0-20210331065221-952fdd90dbb0/controller/controller.go:531\nknative.dev/pkg/controller.(*Impl).RunContext.func3\n\tknative.dev/pkg/v0.0.0-20210331065221-952fdd90dbb0/controller/controller.go:468"}

```

## Service Bindings resource specification

This topic tells you about the Service Bindings resource specification in Tanzu Application Platform (commonly known as TAP).

The `ServiceBinding` resource shape and behavior is defined by the following specification:

```
apiVersion: servicebinding.io/v1alpha3
kind: ServiceBinding
metadata:
 name: account-db
spec:
 service:
 apiVersion: mysql.example/v1alpha1
 kind: MySQL
 name: account-db
 workload:
 apiVersion: apps/v1
 kind: Deployment
 name: account-service

```

## Overview of Services Toolkit

Services Toolkit is responsible for backing many of the most powerful service capabilities in Tanzu Application Platform (commonly known as TAP).

From the integration of an extensive list of cloud-based and on-prem services, through to the offering and discovery of those services, and finally to the claiming and binding of service instances to application workloads, Services Toolkit has the tools you need to make working with services on Tanzu Application Platform simple, easy, and effective.

**Note**

These docs apply to Services Toolkit v0.10 and later. To view the Services Toolkit documentation for v0.9 and earlier, see the previous [Services Toolkit site](#).

## Capabilities

The main capabilities on offer in Tanzu Application Platform through Services Toolkit are:

1. The classes and claims abstraction: provides a simple, but powerful, user experience to apps teams, while promoting a strong separation of concerns between apps teams and ops teams.
2. Dynamic provisioning of service instances: enables apps teams to create service instances that adhere to company policy. Apps teams can create instances on-demand as needed.
3. Seamless integration of almost any service, cloud-based or on-prem, into Tanzu Application Platform with minimal configuration overhead: provides a near-limitless range of services to help boost developer productivity.

## Getting started

If this is your first time working with services on Tanzu Application Platform, you might want to start with [Claim services on Tanzu Application Platform](#) and [Consume services on Tanzu Application Platform](#) in the getting started guide. These guides run through the basics, after which you can return here to the Services Toolkit component documentation to continue your services journey on Tanzu Application Platform.

## How this documentation is organized

The Services Toolkit component documentation consists of the following sections that relate to what you are want to achieve:

- [Concepts](#): To gain a deeper understanding of Services Toolkit.
- [Tutorials](#): To learn through following examples.
- [How-to guides](#): To find a set of steps to solve a specific problem.
- [Reference material](#): To find specific information such as Services Toolkit's APIs, the Tanzu Service CLI plug-in, and troubleshooting information.

Tutorials and concepts are of most relevance when studying, while how-to guides and reference material are of most use while working.

The following is a selection of useful topics on offer:

**For apps teams:**

- Tutorial: [Working with Bitnami Services](#)

**For ops teams:**

- Tutorial: [Setup Dynamic Provisioning of Service Instances](#)
- Tutorial: [Integrating Cloud Services \(AWS, Azure, GCP, etc.\) into Tanzu Application Platform](#)
- How-to guide: [Configure Dynamic Provisioning of AWS RDS Service Instances](#)

**For everyone:**

- Concept: [Four Levels of Service Consumption in Tanzu Application Platform](#)

## Overview of Services Toolkit

Services Toolkit is responsible for backing many of the most powerful service capabilities in Tanzu Application Platform (commonly known as TAP).

From the integration of an extensive list of cloud-based and on-prem services, through to the offering and discovery of those services, and finally to the claiming and binding of service instances to application workloads, Services Toolkit has the tools you need to make working with services on Tanzu Application Platform simple, easy, and effective.



### Note

These docs apply to Services Toolkit v0.10 and later. To view the Services Toolkit documentation for v0.9 and earlier, see the previous [Services Toolkit site](#).

## Capabilities

The main capabilities on offer in Tanzu Application Platform through Services Toolkit are:

1. The classes and claims abstraction: provides a simple, but powerful, user experience to apps teams, while promoting a strong separation of concerns between apps teams and ops teams.
2. Dynamic provisioning of service instances: enables apps teams to create service instances that adhere to company policy. Apps teams can create instances on-demand as needed.
3. Seamless integration of almost any service, cloud-based or on-prem, into Tanzu Application Platform with minimal configuration overhead: provides a near-limitless range of services to help boost developer productivity.

## Getting started

If this is your first time working with services on Tanzu Application Platform, you might want to start with [Claim services on Tanzu Application Platform](#) and [Consume services on Tanzu Application Platform](#) in the getting started guide. These guides run through the basics, after which you can return here to the Services Toolkit component documentation to continue your services journey on Tanzu Application Platform.

## How this documentation is organized

The Services Toolkit component documentation consists of the following sections that relate to what you are want to achieve:

- [Concepts](#): To gain a deeper understanding of Services Toolkit.
- [Tutorials](#): To learn through following examples.
- [How-to guides](#): To find a set of steps to solve a specific problem.
- [Reference material](#): To find specific information such as Services Toolkit's APIs, the Tanzu Service CLI plug-in, and troubleshooting information.

Tutorials and concepts are of most relevance when studying, while how-to guides and reference material are of most use while working.

The following is a selection of useful topics on offer:

### For apps teams:



- Tutorial: [Working with Bitnami Services](#)

#### For ops teams:

- Tutorial: [Setup Dynamic Provisioning of Service Instances](#)
- Tutorial: [Integrating Cloud Services \(AWS, Azure, GCP, etc.\) into Tanzu Application Platform](#)
- How-to guide: [Configure Dynamic Provisioning of AWS RDS Service Instances](#)

#### For everyone:

- Concept: [Four Levels of Service Consumption in Tanzu Application Platform](#)

## Install Services Toolkit

This topic tells you how to install Services Toolkit from the Tanzu Application Platform (commonly known as TAP) package repository.



### Note

Follow the steps in this topic if you do not want to use a profile to install Services Toolkit. For more information about profiles, see [Components and installation profiles](#).

## Prerequisites

Before installing Services Toolkit:

- Complete all prerequisites to install Tanzu Application Platform. For more information, see [Prerequisites](#).
- Install cert-manager. For more information, see [Install cert-manager](#).

## Install Services Toolkit

To install Services Toolkit:

1. See what versions of Services Toolkit are available to install by running:

```
tanzu package available list -n tap-install services-toolkit.tanzu.vmware.com
```

For example:

```
$ tanzu package available list -n tap-install services-toolkit.tanzu.vmware.com
- Retrieving package versions for services-toolkit.tanzu.vmware.com...
NAME VERSION RELEASED-AT
services-toolkit.tanzu.vmware.com 0.9.0 2022-09-08T00:00:00Z
```

2. Install Services Toolkit by running:

```
tanzu package install services-toolkit \
 --package services-toolkit.tanzu.vmware.com \
 --version VERSION-NUMBER \
 --namespace tap-install
```

Where `VERSION-NUMBER` is the Services Toolkit version you want to install. For example, `0.9.0`.

3. Verify that the package installed by running:

```
tanzu package installed get services-toolkit -n tap-install
```

In the output, confirm that the `STATUS` value is `Reconcile succeeded`.

For example:

```
$ tanzu package installed get services-toolkit -n tap-install
| Retrieving installation details for services-toolkit...
NAME: services-toolkit
PACKAGE-NAME: services-toolkit.tanzu.vmware.com
PACKAGE-VERSION: 0.9.0
STATUS: Reconcile succeeded
CONDITIONS: [{ReconcileSucceeded True }]
USEFUL-ERROR-MESSAGE:
```

## Services Toolkit concepts

This section introduces you to Services Toolkit concepts.

In this section:

- [The four levels of service consumption in Tanzu Application Platform](#)
- [Class claims vs resource claims](#)

## The four levels of service consumption in Tanzu Application Platform

This topic describes the different levels of abstraction when using Services Toolkit and explains when and why you might choose to use one level over the other.

As Tanzu Application Platform has evolved, so has the way to offer and consume services on the platform. In this topic, the progress of this evolution is charted in terms of four levels of service consumption.

The introduction of a higher level does not automatically mean that all lower levels are made obsolete. In most cases, the higher levels build upon the foundations laid by the lower levels, and represent an abstraction that is higher-level and more opinionated.

### Level 1 - direct bindings

Tanzu Application Platform v1.0 included support for service bindings, which back the level 1 concept of direct bindings.

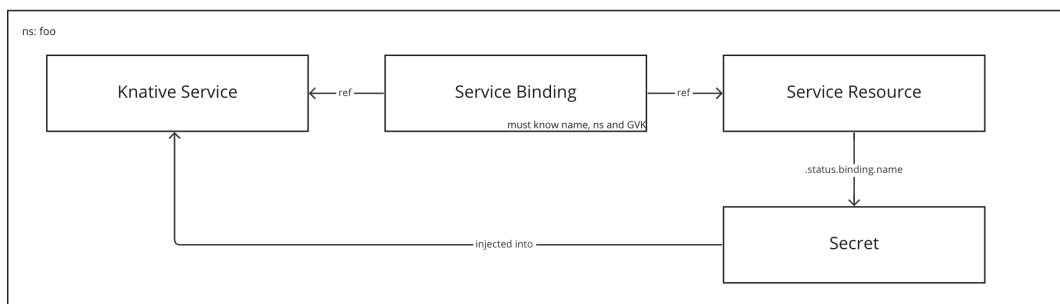

For example, if you deploy an application workload to Tanzu Application Platform, this results in a Knative service in a namespace. An API resource in the same namespace that represents a service, such as a database or a cache, is called a service resource.

Using a service binding you can bind that service resource with the Knative service. This injects the credentials for the service resource into the Knative service, so that the application workload can consume it.

In this relatively straightforward scenario, there are only a few resources involved and they directly reference each other. In fact, users are not even directly exposed to the service binding. The service binding is created automatically as part of the Out of the Box Supply Chains whenever an application workload is configured to refer to a service.

However, there are a number of limitations with this setup. The first is that the service resource must be bindable and which means it must adhere to the provisioned services definition in the service binding specification for Kubernetes. For more information, see [Provisioned Service](#). There are some resources that adhere to this specification, primarily resources offered by VMware Tanzu's data services, but the overwhelming majority of resources don't.

The second limitation is that all resources have to be in the same namespace.

The third limitation is that the service binding must have detailed and specific information about the service resource, including its name, namespace, and API group, version, and kind. This is not a clear separation of concerns as it introduces tight coupling between app teams, who create the application workloads, and ops teams, who create the service resources.

## Level 2 - resource claims

Level 2 addresses some limitations of direct bindings through the Services Toolkit feature resource claims. This feature coincided with the release of Tanzu Application Platform v1.0.

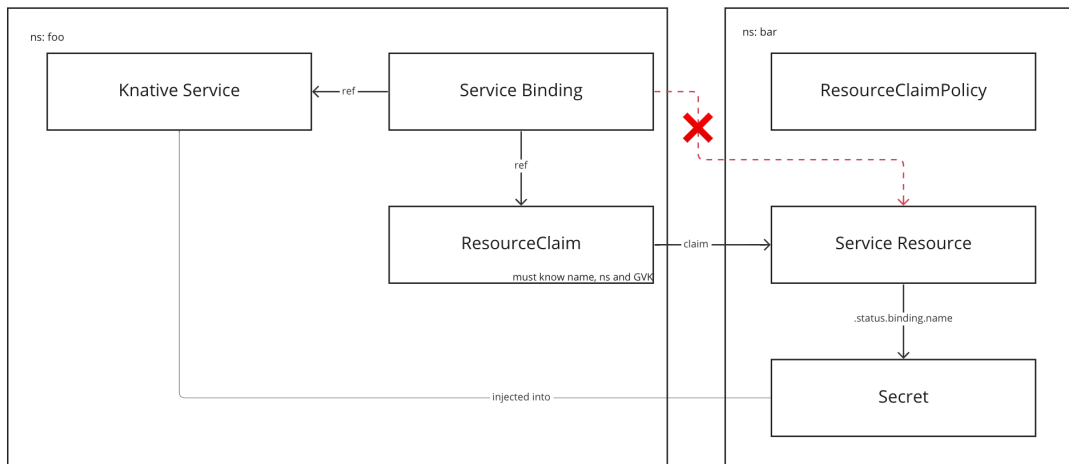

For example, if you have the same setup as in [Level 1 - direct bindings](#), but you want the service resource to be in a separate namespace from the Knative service you cannot use direct bindings. This is because the [schema](#) for ServiceBinding provides no option to configure a [namespace](#) for the service.

Resource claims allow you to claim a bindable service resource that exists in another namespace, and to then bind the application workload to the resource claim instead of to the service resource directly. Because you are now crossing namespace tenancy boundaries, you are only permitted to claim the service resource if you create a corresponding resource claim policy.

The advantage of level 2 over level 1 is that now the application workload and the service resource do not have to exist in the same namespace. This helps to promote a better separation of concerns. It is now possible for apps teams and ops teams to manage the life cycles of apps and services independently.

However, it's still not an ideal solution, and some limitations from level 1 still exist in level 2. The service resource still must be bindable, and apps teams still must know the name, namespace, and API group, version, and kind of the service resource. In addition, ops teams must ensure that the service resources exist. These resources must be manually provisioned and permitted to be claimed through policy, otherwise resource claims created by the apps teams remain in a pending state indefinitely.

## Level 3 - class claims and pool-based classes

Level 3 introduces class claims and pool-based classes. Originally released with Tanzu Application Platform v1.4, class claims and pool-based classes help to alleviate the issue of apps teams having to know detailed information about service resources.

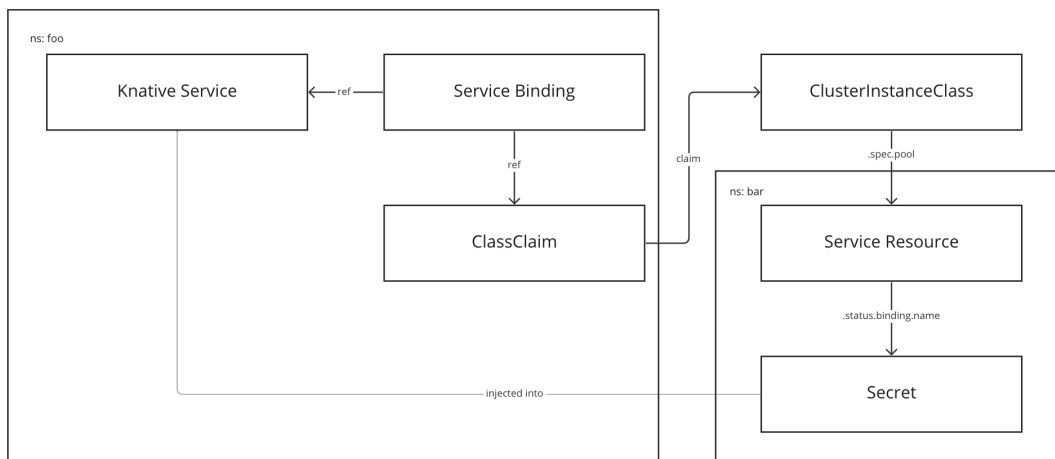

Level 3 builds on the example in level 2, which has an application workload in a namespace `foo` and a service resource in a namespace `bar`. Rather than relying on resource claim and resource claim policy, level 3 introduces a class claim and a pool-based class.

The pool-based class can pool service resources using label or field selectors from across all namespaces on the cluster. Ops teams create the service resources and then create a class to gather them all together into one logical group that apps teams can discover and claim from.

Apps teams can discover the available classes using the `tanzu service class list` command. Rather than creating a resource claim, they instead create a higher-level abstraction - a class claim. The class claim refers to the name of a class. You only need to create a class claim referring to a class and then bind your application workload to the class claim. There is no longer a need to provide detailed information such as the API group, version, and kind for the service resource behind the class.

Level 3 is much simpler for apps teams to consume services and the separation of concerns is much neater. A few limitations still remain. Service resources must still be bindable and ops teams still must manually provision the service resources to fill the pool.

## Level 4 - class claims and provisioner-based classes (aka “Dynamic Provisioning”)

Level 4 is the current highest level of service consumption in Tanzu Application Platform. Released in Tanzu Application Platform v1.5, it introduces provisioner-based classes, which, together with class claims, power Tanzu Application Platform’s dynamic provisioning capability.

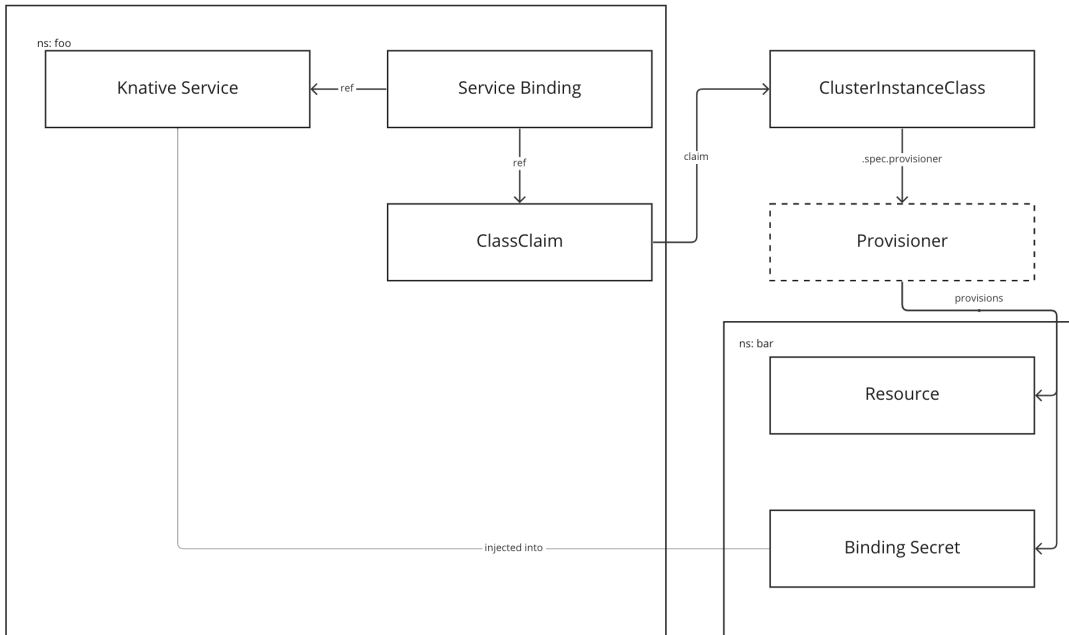

Level 4 builds on the example in level 3, but the class now defines a provisioner rather than a pool. Services Toolkit in Tanzu Application Platform v1.5 supports one provisioner type - [Crossplane](#). Support for new provisioners might be added in the future.

When you create a class claim that refers to a provisioner-based class, the Services Toolkit controller requests the provisioner to provision the resources necessary to create a service instance that can then be bound to application workloads. In this example, the provisioner creates a namespace, a service resource, and a secret that conforms to the binding specification. Then, that secret is wired all the way back through to the application workload.

Two big advantages are realized at level 4. Firstly, ops teams no longer need to manually provision service resources. They are now created on-demand as and when needed. This not only helps to remove unnecessary burden from ops teams, but also helps to provide better use of resources because service resources no longer need to remain in a pool waiting to be claimed. The second advantage is that service resources no longer need to be bindable. The provisioner can act almost like an adapter to bring pretty much any service you can think of into Tanzu Application Platform. The only requirement is that the provisioner create a binding-conforming secret that holds credentials for the provisioned service resources. You can configure this once during the dynamic provisioning setup.

While level 4 is very powerful and seemingly solves the problems mentioned so far, it's not entirely without its drawbacks. The main one being that all this flexibility comes at the cost of added complexity. There are many, many more moving parts involved at level 4 when compared to level 1. However, it might be a price worth paying to benefit from all that is on offer.

## Summary

By now you have seen how each new level builds and improves upon the last. All levels are also valid use cases in their own right.

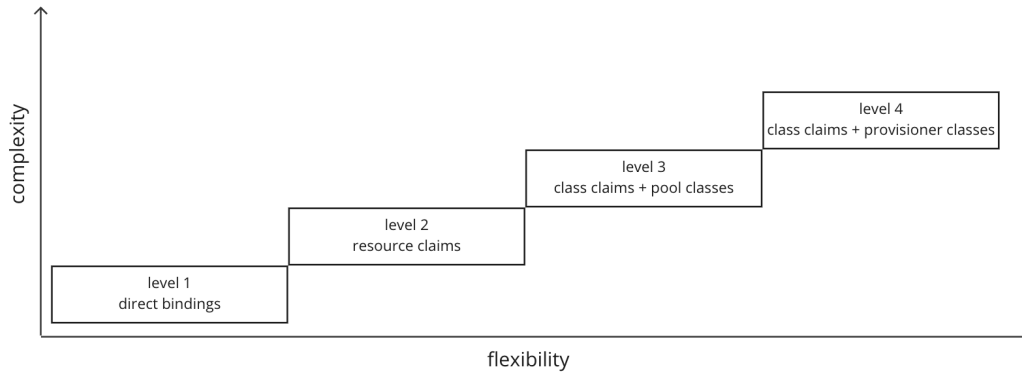

Tanzu Application Platform users can decide which level to operate at. Finding the level that is right for your situation depends on a number of factors, such as, the size of the organization you work for and the layout of apps teams and ops teams within the org.

If you work at a small startup in which there are no strict divides between apps teams and ops teams, level 1 might be suitable for your needs. However, if you work for a large organization with distinct and dedicated apps and ops teams, choosing one of the higher levels in which that separation is better catered to might make more sense. If you are not sure, it's probably best to start with level 4. Level 4 provides the ultimate services experience on Tanzu Application Platform, and as such will hopefully meet all your services needs.

## Class claims compared to resource claims

There are two types of claim you can choose from when working with services on Tanzu Application Platform (commonly known as TAP). These are `ClassClaim` and `ResourceClaim`. This Services Toolkit topic explains the similarities and differences between the two and when using one is preferable over the other.

It is usually advisable to work with a `ClassClaim` where possible as they are easier to create and are more portable across multiple clusters. They are also used as the trigger mechanism for dynamic provisioning of service instances.

## Similarities

- Both APIs express that you want to access to a service instance.
- Both APIs adhere to the `ProvisionedService` duck type. They both have the field `.status.binding.name` in their API. This means that you can target them using a `ServiceBinding` and, therefore, you can feed them into Cartographer's Workload API.
- Both APIs ensure that mutual exclusivity of claims on service instances. After using either a `ClassClaim` or a `ResourceClaim` to claim a service instance, no other `ClassClaim` or a `ResourceClaim` can claim that same service instance.

## Using a ResourceClaim

A `ResourceClaim` targets a specific resource in the Kubernetes cluster. To target that resource, the `ResourceClaim` needs the name, namespace, kind, and API version of the resource.

The specificity of the `ResourceClaim` means it is most useful when you must guarantee which service instance the application workload uses. For example, if the application must connect to the exact same database instance while it advances through development, test, and production

environments. If you do not need this guarantee VMware recommends that you use the ClassClaim API instead.

## Using a ClassClaim

A ClassClaim targets a ClusterInstanceClass in the Kubernetes cluster. To target this class, the ClassClaim only requires the name of the ClusterInstanceClass.

The ClusterInstanceClass can represent any set of service instances and therefore each time you create a new ClassClaim, you can claim any of the service instances represented by that ClusterInstanceClass. After a ClassClaim has claimed a service instance, it never looks for another. This is true even if the ClassClaim's `spec` is updated, or the ClusterInstanceClass is updated. Therefore, the ClassClaim is performing a **point-in-time** lookup at its creation, using the ClusterInstanceClass for that lookup.

The loose coupling between the ClassClaim and the service instances means that a ClassClaim is best in situations where:

- You must inject different service instances into the application workload at different points in its advancement from development to production environments. For more information, see [Abstracting Service Implementations Behind A Class Across Clusters](#).
- The ClassClaim, and also any workload referencing it, must be promoted from one environment to the next without changing their specification.

The ClassClaim is the only type of claim that you can use to dynamically provision service instances.

## Tutorials

In this section:

### For apps teams:

- [Working with Bitnami Services](#)

### For ops teams:

- [Set up dynamic provisioning of service instances](#)
- [Integrating cloud services into Tanzu Application Platform](#)
- [Using direct secret references](#)
- [Abstracting service implementations behind a class across clusters](#)

## Set up dynamic provisioning of service instances

In this Services Toolkit tutorial you learn how [service operators](#) can set up a new, self-serve, and customized service for Tanzu Application Platform (commonly known as TAP). The example uses VMware RabbitMQ for Kubernetes, but the steps and learnings can apply to almost any other service.

## About this tutorial

**Target user role:** Service operator

**Complexity:** Advanced

**Estimated time:** 60 minutes

**Topics covered:** Dynamic provisioning, Crossplane, VMware RabbitMQ for Kubernetes operator

**Learning outcomes:** The ability to offer new, on-demand, and customized services in your Tanzu Application Platform clusters

## Prerequisites

Before you can follow this tutorial, you must have:

- Access to a Tanzu Application Platform cluster v1.5.0 or later.
- A basic familiarity with Crossplane, particularly the concepts of [Composition](#) and [CompositeResourceDefinition](#). To learn about these concepts, see the [Crossplane documentation](#).

## Scenario

This tutorial is centered around the following scenario.

You work at BigCorp and are tasked to provide an on-demand, self-serve RabbitMQ service for BigCorp's development teams who are working with Tanzu Application Platform. You reviewed the RabbitMQ offering that is available with Bitnami Services and discovered that it is an excellent service for testing and quickly getting started, but it is not quite suitable for BigCorp's stringent and specific needs.

In particular, you must comply with BigCorp's auditing and logging policy. You want to enforce that every RabbitMQ cluster in use on the platform adheres to that policy. However, you don't want to be a blocker for the application teams and want to offer them self-serve access to RabbitMQ whenever they need it, without incurring any untoward delays. You have heard about the dynamic provisioning capability in Tanzu Application Platform and want to use it to complete your task.

In this tutorial, you learn how to:

- Install the RabbitMQ Cluster Kubernetes operator
- Create a [CompositeResourceDefinition](#)
- Create a [Composition](#)
- Create a provisioner-based class
- Understand and create the necessary Role-based access control (RBAC) permissions
- Create a claim for the class to test it all out
- Understand how all the pieces fit together to power the dynamic provisioning capability in Tanzu Application Platform

## Concepts

The following diagram provides an overview of the elements of dynamic provisioning and how they fit together.



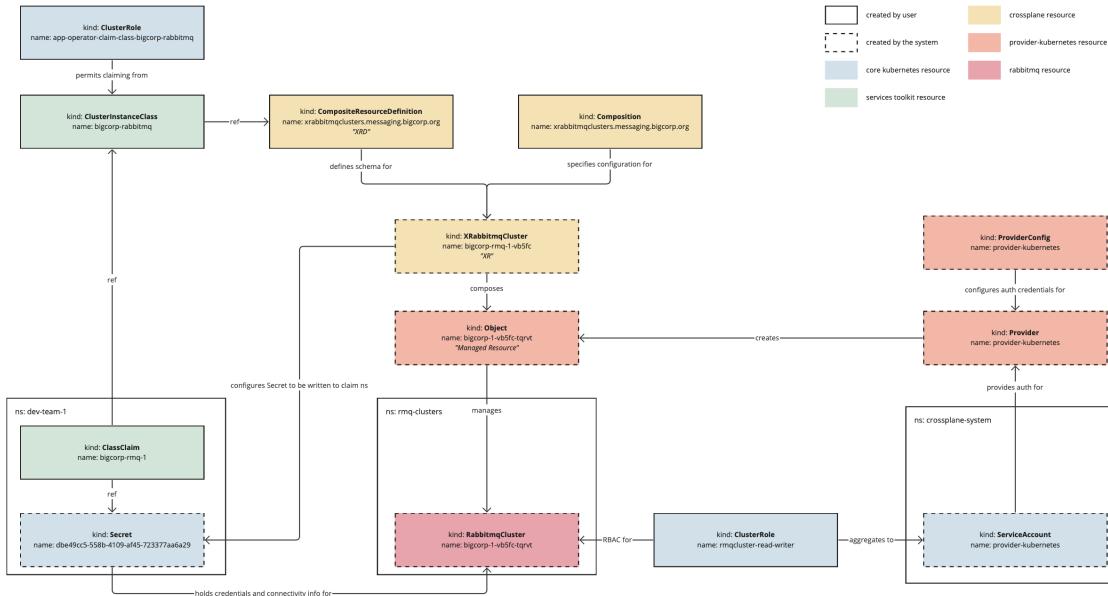

The following is a high-level overview of how the system works:

1. The service operator creates a **CompositeResourceDefinition** and a **Composition**, which together define the configuration of the service instances that will be dynamically provisioned.
2. The service operator creates a class pointing to the **CompositeResourceDefinition**. This informs application development teams that the service is available.
3. The service operator applies necessary RBAC to permit the system to create the necessary resources and authorize application development teams to create claims for the class.
4. The application developer creates a claim referring to the class and optionally passes through parameters to override any default configuration where permissible.
5. The system creates a **CompositeResource** that merges information provided in the claim with default configuration specified by the system and configuration defined in the **Composition**.
6. Crossplane reconciles the **CompositeResource** into a service instance and writes credentials for the instance into a **Secret**.
7. The **Secret** is written back to the application developer’s namespace so that application workloads can use it.

As you follow this tutorial, it will address the parts of this diagram in more detail.

## Procedure

The following steps show you how to configure dynamic provisioning for a service.

### Step 1: Install an operator

When adding a new service to Tanzu Application Platform, ensure that there are a suitable set of APIs available in the cluster from which to construct the service instances. Usually, this involves installing one or more Kubernetes operators into the cluster.

Because the aim of this tutorial is to set up a new RabbitMQ service, install the RabbitMQ Cluster Operator for Kubernetes.

**Note**

The steps in this tutorial use the open source version of the operator. For most real-world deployments, VMware recommends using the official supported version that VMware provides. For more information, see [VMware RabbitMQ for Kubernetes](#).

Install the Kubernetes operator using the kapp CLI by running:

```
kapp -y deploy --app rmq-operator --file https://github.com/rabbitmq/cluster-operator/releases/latest/download/cluster-operator.yml
```

This makes available in the cluster a new API group/version of `rabbitmq.com/v1beta1` and kind named `RabbitmqCluster`. You can now use this API to create RabbitMQ cluster instances as part of the dynamic provisioning setup.

## Step 2: Create a `CompositeResourceDefinition`

The dynamic provisioning capability in Tanzu Application Platform relies on [Crossplane](#). You can find the specific integration point at `.spec.provisioner.crossplane.compositeResourceDefinition` in the `ClusterInstanceClass` API for Tanzu Application Platform.

This field references a `CompositeResourceDefinition`, which you create in this step of the procedure. The `CompositeResourceDefinition` (XRD) defines the shape of a new, custom API type that encompasses the specific set of requirements laid out by the scenario in this tutorial.

To create the `CompositeResourceDefinition`:

1. Configure a `CompositeResourceDefinition` by creating a file named `xrabbitmqclusters.messaging.bigcorp.org.xrd.yaml` with the following contents:

```
xrabbitmqclusters.messaging.bigcorp.org.xrd.yaml

apiVersion: apiextensions.crossplane.io/v1
kind: CompositeResourceDefinition
metadata:
 name: xrabbitmqclusters.messaging.bigcorp.org
spec:
 connectionSecretKeys:
 - host
 - password
 - port
 - provider
 - type
 - username
 group: messaging.bigcorp.org
 names:
 kind: XRabbitmqCluster
 plural: xrabbitmqclusters
 versions:
 - name: v1alpha1
 referenceable: true
 schema:
 openAPIV3Schema:
 properties:
 spec:
 description: The OpenAPIV3Schema of this Composite Resource Definition.
 properties:
 replicas:
 description: The desired number of replicas forming the cluster
 type: integer
 storageGB:
```

```

 description: The desired storage capacity of a single replica,
in GB.
 type: integer
 type: object
 type: object
 served: true

```

2. Apply the file to the Tanzu Application Platform cluster by running:

```
kubectl apply -f xrabbitmqclusters.messaging.bigcorp.org.xrd.yaml
```

3. To verify the status of the XRD you created, run:

```
kubectl get xrds
```

If successful, the `xrabbitmqclusters.messaging.bigcorp.org` is listed with `ESTABLISHED=True`.

You might see some other XRDs listed as well. These are the `*.bitnami.*.tanzu.vmware.com` XRDs. These are part of the `bitnami.services.tanzu.vmware.com` package with Tanzu Application Platform and serve as the basis of the Bitnami Services. You can ignore these other XRDs for now, but to see how they are used in practice, see [Claim services on Tanzu Application Platform](#) and [Consume services on Tanzu Application Platform](#) in the Tanzu Application Platform getting started guide.

4. To inspect the `messaging.bigcorp.org/v1alpha1` API group/version that was created by the XRD, run:

```
kubectl explain --api-version=messaging.bigcorp.org/v1alpha1 xrabbitmqclusters.spec
```

As a result of creating the XRD, a new API group/version of `messaging.bigcorp.org/v1alpha1` and kind named `XRabbitmqCluster` become available in the cluster. When you inspect this API, you can see that the `replicas` and `storageGB` properties configured in the XRD are present in the specification of `XRabbitmqCluster`.

You can also see that Crossplane has injected some other fields into the specification as well.

### About the `CompositeResourceDefinition`

The following is a condensed explanation of parts of the `CompositeResourceDefinition` related to dynamic provisioning in Tanzu Application Platform. For a detailed explanation of `CompositeResourceDefinition`, see the [Crossplane documentation](#).

- `.spec.claimNames:`

The example in this tutorial does not specify `.spec.claimNames` in the XRD. The dynamic provisioning capability in Tanzu Application Platform uses Crossplane's cluster-scoped composite resources, rather than Crossplane's namespace-scoped claims. Claims here refer to the Crossplane concept, not to be confused with Tanzu Application Platform claims. As such, this configuration is not required, although it does not cause any adverse effects if you add it.

- `.spec.connectionKeys:`

This field detects the keys that will exist in the `Secret` resulting from the dynamic provisioning request. You likely want this `Secret` to conform to the [Service Binding Specification for Kubernetes](#) because this helps to enable application workloads in Tanzu

Application Platform to automatically configure service instances. This assumes that the application is using a binding-aware library such as [Spring Cloud Bindings](#). Specific key name requirements vary by service type, but all must provide the `type` key.

- `.spec.properties:`

The `.spec.properties` section in the schema for `v1alpha1` is where you, as the service operator, can set which configuration options you want to expose to application development teams. In the example in this section, there are two configuration options: `replicas` and `storageGB`. By adding these properties to the specification, you give development teams control over these configuration options. For example, you might want to add `storageGB` if the development teams have more knowledge about how much storage their apps require than you do. By adding `storageGB` you can allow them to decide for themselves how much storage they require.

You can choose to add as many or as few configuration options as you like. You can also choose to set default values. In highly regulated environments, you might not want to allow for any configuration by developers at all.

In the scenario at the beginning of this tutorial, it says that you must comply with the auditing and logging policy. You do not specify any configuration related to auditing or logging in the XRD in this step. This is intentional because in this scenario there are strict auditing and logging requirements and cannot permit developers to override those. In the next step you learn how to ensure that those requirements get enforced on the resulting RabbitMQ clusters.

### Step 3: Create a Crossplane `Composition`

You do most of the configuration for dynamic provisioning when you create the `Composition`. This section has the basics you must know to start to create a `Composition` for use in Tanzu Application Platform. For a more detailed explanation about the `Composition`, see the [Crossplane documentation](#).

To create the `Composition`:

1. Configure a `Composition` by creating a file named `xrabbitmqclusters.messaging.bigcorp.org.composition.yaml` with the following contents:

```
xrabbitmqclusters.messaging.bigcorp.org.composition.yaml

apiVersion: apiextensions.crossplane.io/v1
kind: Composition
metadata:
 name: xrabbitmqclusters.messaging.bigcorp.org
spec:
 compositeTypeRef:
 apiVersion: messaging.bigcorp.org/v1alpha1
 kind: XRabbitmqCluster
 resources:
 - base:
 apiVersion: kubernetes.crossplane.io/v1alpha1
 kind: Object
 spec:
 forProvider:
 manifest:
 apiVersion: rabbitmq.com/v1beta1
 kind: RabbitmqCluster
 metadata:
 namespace: rmq-clusters
 spec:
 terminationGracePeriodSeconds: 0
```

```

 replicas: 1
 persistence:
 storage: 1Gi
 resources:
 requests:
 cpu: 200m
 memory: 1Gi
 limits:
 cpu: 300m
 memory: 1Gi
 rabbitmq:
 envConfig: |
 RABBITMQ_LOGS=""
 additionalConfig: |
 log.console = true
 log.console.level = debug
 log.console.formatter = json
 log.console.formatter.json.field_map = verbosity:v time msg d
omain file line pid level:-
 log.console.formatter.json.verbosity_map = debug:7 info:6 not
ice:5 warning:4 error:3 critical:2 alert:1 emergency:0
 log.console.formatter.time_format = epoch_usecs
 connectionDetails:
 - apiVersion: v1
 kind: Secret
 namespace: rmq-clusters
 fieldPath: data.provider
 toConnectionSecretKey: provider
 - apiVersion: v1
 kind: Secret
 namespace: rmq-clusters
 fieldPath: data.type
 toConnectionSecretKey: type
 - apiVersion: v1
 kind: Secret
 namespace: rmq-clusters
 fieldPath: data.host
 toConnectionSecretKey: host
 - apiVersion: v1
 kind: Secret
 namespace: rmq-clusters
 fieldPath: data.port
 toConnectionSecretKey: port
 - apiVersion: v1
 kind: Secret
 namespace: rmq-clusters
 fieldPath: data.username
 toConnectionSecretKey: username
 - apiVersion: v1
 kind: Secret
 namespace: rmq-clusters
 fieldPath: data.password
 toConnectionSecretKey: password
 writeConnectionSecretToRef:
 namespace: rmq-clusters
 connectionDetails:
 - fromConnectionSecretKey: provider
 - fromConnectionSecretKey: type
 - fromConnectionSecretKey: host
 - fromConnectionSecretKey: port
 - fromConnectionSecretKey: username
 - fromConnectionSecretKey: password
 patches:
 - fromFieldPath: metadata.name
 toFieldPath: spec.forProvider.manifest.metadata.name
 type: FromCompositeFieldPath

```

```

- fromFieldPath: spec.replicas
 toFieldPath: spec.forProvider.manifest.spec.replicas
 type: FromCompositeFieldPath
- fromFieldPath: spec.storageGB
 toFieldPath: spec.forProvider.manifest.spec.persistence.storage
 transforms:
 - string:
 fmt: '%dGi'
 type: Format
 type: string
 type: FromCompositeFieldPath
- fromFieldPath: metadata.name
 toFieldPath: spec.writeConnectionSecretToRef.name
 transforms:
 - string:
 fmt: '%s-rmq'
 type: Format
 type: string
 type: FromCompositeFieldPath
- fromFieldPath: metadata.name
 toFieldPath: spec.connectionDetails[0].name
 transforms:
 - string:
 fmt: '%s-default-user'
 type: Format
 type: string
 type: FromCompositeFieldPath
- fromFieldPath: metadata.name
 toFieldPath: spec.connectionDetails[1].name
 transforms:
 - string:
 fmt: '%s-default-user'
 type: Format
 type: string
 type: FromCompositeFieldPath
- fromFieldPath: metadata.name
 toFieldPath: spec.connectionDetails[2].name
 transforms:
 - string:
 fmt: '%s-default-user'
 type: Format
 type: string
 type: FromCompositeFieldPath
- fromFieldPath: metadata.name
 toFieldPath: spec.connectionDetails[3].name
 transforms:
 - string:
 fmt: '%s-default-user'
 type: Format
 type: string
 type: FromCompositeFieldPath
- fromFieldPath: metadata.name
 toFieldPath: spec.connectionDetails[4].name
 transforms:
 - string:
 fmt: '%s-default-user'
 type: Format
 type: string
 type: FromCompositeFieldPath
- fromFieldPath: metadata.name
 toFieldPath: spec.connectionDetails[5].name
 transforms:
 - string:
 fmt: '%s-default-user'
 type: Format
 type: string

```

```

 type: FromCompositeFieldPath
 readinessChecks:
 - type: MatchString
 fieldPath: status.atProvider.manifest.status.conditions[1].status # ClusterAvailable
 matchString: "True"

```

2. Apply the file to the Tanzu Application Platform cluster by running:

```
kubectl apply -f xrabbitmqclusters.messaging.bigcorp.org.composition.yaml
```

### About the `Composition`

The following is a condensed explanation of the most relevant parts of the `Composition`.

#### About `.spec.compositeTypeRef`

The `.spec.compositeTypeRef` is configured to refer to `XRabbitmqCluster` on the `messaging.bigcorp.org/v1alpha1` API group/version.

```

...
spec:
 compositeTypeRef:
 apiVersion: messaging.bigcorp.org/v1alpha1
 kind: XRabbitmqCluster
...

```

This is the API that was created when you applied the XRD in [Step 2: Creating a CompositeResourceDefinition](#). By configuring `.spec.compositeTypeRef` to refer to this API, you are instructing Crossplane to use the configuration contained within this `Composition` to compose subsequent managed resources whenever it observes that a new `XRabbitmqCluster` resource is created in the cluster. Tanzu Application Platform's dynamic provisioning system creates the `XRabbitmqCluster` resources automatically. To visualize how these pieces fit together, see the diagram in [Concepts](#) earlier.

#### About `.spec.resources`

The `.spec.resources` section is where you specify the managed resources to be created. Managed resources are tied to Crossplane's providers. Each provider defines a set of managed resources that can then be used in compositions. Tanzu Application Platform includes two providers with the Crossplane package: `provider-helm` and `provider-kubernetes`. This makes a `Release` managed resource available that manages Helm releases. It also makes an `Object` managed resource available that manages arbitrary Kubernetes resources.

You can install and use any other provider. To find the latest providers, see the [Upbound Marketplace](#). The more providers you install, the more managed resources you can choose from in your compositions.

#### The `Object` managed resource

The goal is to compose the resources required to create service instances and to surface the credentials and connectivity information required to connect to those instances in a known and repeatable way. This tutorial uses the `RabbitmqCluster` resource, which presents one single API to use to create fully functioning RabbitMQ clusters with credentials stored in `Secrets` in the cluster.

However, `RabbitmqCluster` is not a Crossplane managed resource so you cannot refer to this resource directly under `.spec.resources`. To work around this, use `provider-kubernetes` and its

corresponding `Object` managed resource. `Object` enables you to wrap any arbitrary Kubernetes resource, such as `RabbitmqCluster`, into a Crossplane managed resource and then to use them like any other managed resource inside `Compositions`.

```
...
spec:
 resources:
 - base:
 apiVersion: kubernetes.crossplane.io/v1alpha1
 kind: Object
 spec:
 forProvider:
 manifest:
 apiVersion: rabbitmq.com/v1beta1
 kind: RabbitmqCluster
 metadata:
 namespace: rmq-clusters
 spec:
 terminationGracePeriodSeconds: 0
 replicas: 1
 persistence:
 storage: 1Gi
 resources:
 requests:
 cpu: 200m
 memory: 1Gi
 limits:
 cpu: 300m
 memory: 1Gi
 rabbitmq:
 envConfig: |
 RABBITMQ_LOGS=""
 additionalConfig: |
 log.console = true
 log.console.level = debug
 log.console.formatter = json
 log.console.formatter.json.field_map = verbosity:v time msg domain f
 file line pid level:-
 log.console.formatter.json.verbosity_map = debug:7 info:6 notice:5 w
 arning:4 error:3 critical:2 alert:1 emergency:0
 log.console.formatter.time_format = epoch_usec
...

```

The `Object` managed resource is where you configure `RabbitmqCluster` resources. This is the place where you can fine-tune the configuration of the RabbitMQ clusters to your needs.

The scenario mentions that you are particularly concerned about your company's logging policy. The configuration in the `Object` translates that policy into default configuration on the `RabbitmqCluster` resource by specifying `.spec.rabbitmq.additionalConfig` for the resource. This was taken from [one of the examples](#) in the RabbitMQ Cluster Operator GitHub repository. You can configure the resource however you want and to whatever requirements necessary.

### The patches section

The `Object` also sets default values for the number of replicas and the amount of persistent storage for new `RabbitmqClusters` to one replica and 1 Gi. However, you want to allow these two values to be configurable by the application development teams as specified in [Step 2: Creating a CompositeResourceDefinition](#). You can configure this using patches.

```
...
patches:
 - fromFieldPath: metadata.name

```



```

toFieldPath: spec.forProvider.manifest.metadata.name
type: FromCompositeFieldPath
...

```

All of the patches are of type `FromCompositeFieldPath`, which allows you to take values defined on the composite resource (`XRabbitmqCluster` in this case) and to pass them through to the underlying managed resource (an `Object` wrapping `RabbitmqCluster` in this case). The first patch sets the name of the `RabbitmqCluster` to the same name as the name of the composite resource `XRabbitmqCluster`, which were created using `generateName`, thereby ensuring a unique name for each dynamically provisioned `RabbitmqCluster` instance.

```

...
patches:
...
- fromFieldPath: spec.replicas
 toFieldPath: spec.forProvider.manifest.spec.replicas
 type: FromCompositeFieldPath
- fromFieldPath: spec.storageGB
 toFieldPath: spec.forProvider.manifest.spec.persistence.storage
 transforms:
 - string:
 fmt: '%dGi'
 type: Format
 type: string
 type: FromCompositeFieldPath
...

```

The second and third patches pass through configuration for the number of replicas and amount of persistent storage, which overrides the default values already configured.

The remaining patches all do the same thing, which is to patch in the name of the `Secret` for the fields in the `connectionDetails` section.

```

...
- fromFieldPath: metadata.name
 toFieldPath: spec.connectionDetails[0].name
 transforms:
 - string:
 fmt: '%s-default-user'
 type: Format
 type: string
 type: FromCompositeFieldPath
...

```

When creating a `RabbitmqCluster` resource using the RabbitMQ Cluster Kubernetes operator, the operator creates a `Secret` containing credentials and connectivity information used to connect to the cluster. That `Secret` is named `x-default-user`, where `x` is the name of the `RabbitmqCluster` resource. Because the name of the `RabbitmqCluster` cannot be known upfront, you must use patches to ensure that the `connectionDetails` section refers to the correctly-named `Secret`.

The `connectionDetails` sections are where you configure which keys and values to expose in the resulting `Secret`. You must specify the same set of keys as defined in the original XRD.

### The readinessChecks section

Configuring readiness checks helps to keep consumers of dynamic provisioning, that is, the application teams, informed about when the resulting service instances are ready for application workloads to use.

```

...
readinessChecks:

```

```

- type: MatchString
 fieldPath: status.atProvider.manifest.status.conditions[1].status # ClusterAvailable
le
 matchString: "True"

```

Where possible, use the `Ready` condition to verify readiness. However, the `RabbitmqCluster` API doesn't expose a `Ready` condition, so you must configure the ready check on `ClusterAvailable` instead.

### The namespace

One final important decision is the name of the namespace in which to create the dynamically provisioned `RabbitmqCluster` resources. This tutorial uses the `rmq-clusters` namespace.

```

...
spec:
 resources:
 - base:
 apiVersion: kubernetes.crossplane.io/v1alpha1
 kind: Object
 spec:
 forProvider:
 manifest:
 apiVersion: rabbitmq.com/v1beta1
 kind: RabbitmqCluster
 metadata:
 namespace: rmq-clusters
...

```

To make sure that the `rmq-clusters` namespace exists, run:

```
kubectl create namespace rmq-clusters
```

This configuration says that all dynamically provisioned `RabbitmqCluster` resources must be placed in the same `rmq-clusters` namespace. To place each new cluster into a separate namespace, you must create an additional `Object` managed resource to wrap the creation of a `Namespace` and to apply patches to the resources accordingly. For this tutorial you only require one namespace.

## Step 4: Creating a provisioner-based class

After creating the XRD and the `Composition`, you must integrate what you configured into Tanzu Application Platform's classes and claims model so that application teams can use it. The first step is to create a provisioner-based class and to point it at the XRD you created.

To create the provisioner-based class:

1. Configure a `ClusterInstanceClass` by creating a file named `bigcorp-rabbitmq.class.yaml` with the following contents:

```

bigcorp-rabbitmq.class.yaml

apiVersion: services.apps.tanzu.vmware.com/v1alpha1
kind: ClusterInstanceClass
metadata:
 name: bigcorp-rabbitmq
spec:
 description:
 short: On-demand RabbitMQ clusters precision engineered to meet the needs o
f BigCorp!
 provisioner:

```

```
crossplane:
 compositeResourceDefinition: xrabbitmqclusters.messaging.bigcorp.org
```

2. Apply the file to the Tanzu Application Platform cluster:

```
kubectl apply -f bigcorp-rabbitmq.class.yaml
```

This is called a provisioner-based class because you configured `.spec.provisioner`. For more information, see [ClusterInstanceClass](#).

By creating this class you are informing application teams that the service is available. Application teams can discover it by using the `tanzu service class list` command. They can also use `tanzu service class get bigcorp-rabbitmq`, which provides detailed information about the class, including details of the `replicas` and `storageGB` parameters that you configured earlier.

## Step 5: Configure supporting RBAC

There are two parts of RBAC to consider when you set up a new service for dynamic provisioning in Tanzu Application Platform.

The first relates to granting permissions to the providers used in the compositions. The [Composition](#) created earlier uses `Object` managed resources to create `RabbitmqCluster` resources. Therefore, you must grant `provider-kubernetes` permission to create `RabbitmqCluster` resources. You do this by using an aggregating `ClusterRole`.

The second RBAC element detects who is authorized to use the new service. This is important because you are configuring an on-demand service and making it available to application teams. Without any other supporting policy in place, application teams can create as many `RabbitmqClusters` as they like. However, you must be conscious of resource use and might want to control who can create new service instances on-demand.

You grant authorization by using standard Kubernetes RBAC resources. Dynamic provisioning uses a custom RBAC verb, `claim`, which you can apply to classes to permit claiming from them.

To configure RBAC:

1. Configure a `ClusterRole` that grants permissions to the providers used in the compositions by creating a file named `provider-kubernetes-rmqcluster-read-writer.rbac.yaml` with the following contents:

```
provider-kubernetes-rmqcluster-read-writer.rbac.yaml

apiVersion: rbac.authorization.k8s.io/v1
kind: ClusterRole
metadata:
 name: rmqcluster-read-writer
 labels:
 services.tanzu.vmware.com/aggregate-to-provider-kubernetes: "true"
rules:
- apiGroups:
 - rabbitmq.com
 resources:
 - rabbitmqclusters
 verbs:
 - "*"

```

2. Apply the file to the Tanzu Application Platform cluster by running:

```
kubectl apply -f provider-kubernetes-rmqcluster-read-writer.rbac.yaml
```

**Note**

While not necessary here, a corresponding label `services.tanzu.vmware.com/aggregate-to-provider-helm: "true"` exists for aggregating RBAC permissions to `provider-helm` as well.

3. Configure a `ClusterRole` to authorize who can use the service by creating a file named `app-operator-claim-class-bigcorp-rabbitmq.rbac.yaml` with the following contents:

```
app-operator-claim-class-bigcorp-rabbitmq.rbac.yaml

apiVersion: rbac.authorization.k8s.io/v1
kind: ClusterRole
metadata:
 name: app-operator-claim-class-bigcorp-rabbitmq
 labels:
 apps.tanzu.vmware.com/aggregate-to-app-operator-cluster-access: "true"
rules:
- apiGroups:
 - services.apps.tanzu.vmware.com
 resources:
 - clusterinstanceclasses
 resourceNameNames:
 - bigcorp-rabbitmq
 verbs:
 - claim
```

4. Apply the file to the Tanzu Application Platform cluster by running:

```
kubectl apply -f app-operator-claim-class-bigcorp-rabbitmq.rbac.yaml
```

This `ClusterRole` grants anyone with the `app-operator` Tanzu Application Platform user role the permission to claim from the `bigcorp-rabbitmq` class.

## Step 6: Verify your configuration

To test your configuration, create a claim for the class to trigger the dynamic provisioning of a new RabbitMQ cluster. This step is usually performed by the application operator, rather than the service operator, but it is important that you confirm that everything is configured correctly.

To create the claim:

1. Create a `ClassClaim` by creating a file named `bigcorp-rmq-1.claim.yaml` with the following contents:

```
bigcorp-rmq-1.claim.yaml

apiVersion: services.apps.tanzu.vmware.com/v1alpha1
kind: ClassClaim
metadata:
 name: bigcorp-rmq-1
spec:
 classRef:
 name: bigcorp-rabbitmq
 parameters:
 storageGB: 2
 replicas: 3
```

2. Apply the file to the Tanzu Application Platform cluster by running:

```
kubectl apply -f bigcorp-rmq-1.claim.yaml
```

3. After the RabbitMQ service is provisioned, verify that the claim status is ready by running:

```
kubectl get classclaim bigcorp-rmq-1
```

In the output, the claim status will report `Ready=True`.

## Working with Bitnami Services

For the tutorial about working with Bitnami Services, see [Working with Bitnami Services](#).

## Integrate cloud services into Tanzu Application Platform

In this Services Toolkit tutorial you learn how [service operators](#) can integrate the cloud services of their choice into Tanzu Application Platform (commonly known as TAP).

There are a multitude of cloud-based services available on the market for consumers today. AWS, Azure, and GCP all provide support for a wide range of fully-managed, performant, and on-demand services. These services range from databases, to message queues, to storage solutions and beyond. In this tutorial you learn how to integrate any one of these services into Tanzu Application Platform, so that you can offer it for application teams to consume in a simple and effective way.

This tutorial is written at a slightly higher level than the other tutorials in this documentation. This is because it is not feasible to write detailed, step-by-step documentation for integrating every cloud-based service into Tanzu Application Platform. Each service brings a different set of considerations and concerns.

Instead, this tutorial guides you through the general approach to integrating cloud-based services into Tanzu Application Platform. While specific configuration changes between services, the steps in the process remain the same. The aim is to give you enough understanding so that you can integrate any cloud-based service you want into Tanzu Application Platform.

For a more specific and low-level procedure, see [Configure dynamic provisioning of AWS RDS service instances](#), which provides each step in detail for integrating AWS RDS. It might be useful to read through that guide even if you want to integrate with one of the other cloud providers.

## About this tutorial

**Target user role:** Service operator

**Complexity:** Advanced

**Estimated time:** 30 minutes

**Topics covered:** Dynamic provisioning, cloud-based services, AWS, Azure, GCP, Crossplane

**Learning outcomes:** An understanding of the steps involved to integrate cloud-based services into Tanzu Application Platform

## Concepts

The following is a high-level workflow outlining what is required to integrate a cloud-based service into Tanzu Application Platform.

1. [Install a Provider and create a ProviderConfig](#):
  - Follow the official Upbound documentation to install the `Provider` and create a `ProviderConfig`.
2. [Create a CompositeResourceDefinition](#):

- Create a `CompositeResourceDefinition` to define the shape of a new API type representing the service.
  - Choose which configuration parameters to expose to apps teams, if any.
3. **Create a Composition:**
    - Create a `Composition` using managed resources supplied by the `Provider`.
    - You can compose as many or as few managed resources as required to generate a service instance that application workloads can connect to and use over the network.
    - (Optional but recommended) Configure the connection secret to adhere to the service binding specification for Kubernetes.
  4. **Create a provisioner-based ClusterInstanceClass:**
    - Create a provisioner-based `ClusterInstanceClass` pointing to the `CompositeResourceDefinition` created earlier.
  5. **Create the required RBAC:**
    - Create RBAC to allow claiming from the class by using the `claim` verb pointing to the provisioner-based `ClusterInstanceClass`.
  6. **Verify your integration by creating a ClassClaim:**
    - Create a `ClassClaim` pointing to the provisioner-based `ClusterInstanceClass` to begin a dynamic provisioning request.
    - Wait for the `ClassClaim` to report `READY=True`.

## Procedure

This tutorial provides the steps required to integrate cloud services and includes tips and references to example configurations where appropriate.

### Step 1: Install a `Provider`

Install a Crossplane `Provider` for your cloud of choice. Upbound provides support for the three main cloud providers:

- `provider-aws`
- `provider-azure`
- `provider-gcp`



#### Note

These cloud-based `Providers` often install hundreds of additional CRDs onto the cluster. This can have a negative impact on cluster performance. For more information, see [Cluster performance degradation due to a large number of CRDs](#).

Choose the `Provider` you want, and then follow Upbound's official documentation to install the `Provider` and to create a corresponding `ProviderConfig`.



#### Important

The official documentation for the `Provider` includes a step to install Universal Crossplane. You can skip this step because Crossplane is already installed as part of

Tanzu Application Platform.

The `Provider` documentation also assumes Crossplane is installed in the `upbound-system` namespace. However, when working with Crossplane on Tanzu Application Platform, it is installed to the `crossplane-system` namespace by default. Ensure that you use the correct namespace when you create the `Secret` and the `ProviderConfig` with credentials for the `Provider`.

## Step 2: Create a `CompositeResourceDefinition`

Create a `CompositeResourceDefinition`. This defines the shape of a new API type to create the cloud-based resources.

For help creating the `CompositeResourceDefinition`, see the [Crossplane documentation](#) or see [Create a CompositeResourceDefinition](#) in *Configure dynamic provisioning of AWS RDS service instances*.

## Step 3: Create a `Composition`

This step is likely to be the most time-consuming. The `Composition` is where you define the configuration for the resources that make the service instances for app teams to claim. This configures the resources required for service instances that users can connect to and use over the network.

To get started with creating a `Composition`, first read about configuring the composition in the [Upbound documentation](#).

For examples, you can also see [Example Compositions](#).

## Step 4: Create a provisioner-based `ClusterInstanceClass`

Create a provisioner-based `ClusterInstanceClass` that is configured to refer to the `CompositeResourceDefinition` created earlier. For example:

```

apiVersion: services.apps.tanzu.vmware.com/v1alpha1
kind: ClusterInstanceClass
metadata:
 name: cloud-service-foo
spec:
 description:
 short: FooDB by cloud provider Foo!
 provisioner:
 crossplane:
 compositeResourceDefinition: XRD-NAME
```

Where `XRD-NAME` is the name of your `CompositeResourceDefinition`.

For an example, see [Make the service discoverable](#) in *Configure dynamic provisioning of AWS RDS service instances*.

## Step 5: Configure RBAC

Create a Role-Based Access Control (RBAC) rule that uses the `claim` verb and points to the `ClusterInstanceClass` you created. For example:

```
apiVersion: rbac.authorization.k8s.io/v1
kind: ClusterRole
metadata:
 name: app-operator-claim-foo-db
```

```

labels:
 apps.tanzu.vmware.com/aggregate-to-app-operator-cluster-access: "true"
rules:
- apiGroups:
 - "services.apps.tanzu.vmware.com"
 resources:
 - clusterinstanceclasses
 resourceName:
 - cloud-service-foo
 verbs:
 - claim

```

For an example, see [Configure RBAC](#) in *Configure dynamic provisioning of AWS RDS service instances*.

## Step 6: Verify your integration

To test your integration, create a `ClassClaim` that points to the `ClusterInstanceClass` you created. For example:

```

apiVersion: services.apps.tanzu.vmware.com/v1alpha1
kind: ClassClaim
metadata:
 name: claim-1
spec:
 classRef:
 name: cloud-service-foo
 parameters:
 key: value

```

Verify that the `ClassClaim` eventually transitions into a `READY=True` state. If it doesn't, debug the `ClassClaim` using `kubectl`. For how to do this, see [Debug ClassClaim and provisioner-based ClusterInstanceClass](#).

## Abstracting service implementations behind a class across clusters

In this Services Toolkit tutorial you learn how [service operators](#) can configure a class that allows for claims to resolve to different backing implementations of a service, such as PostgreSQL, depending on which cluster the class is claimed in.

This setup allows the configuration for workloads and class claims to remain unchanged as they are promoted through environments. It also enables service operators to change the implementations of the backing services without further configuration.

## About this tutorial

**Target user role:** Service operator

**Complexity:** Medium

**Estimated time:** 60 minutes

**Topics covered:** Classes, claims, claim-by-class, multicluster

**Learning outcomes:** The ability to abstract the implementation (for example, helm, tanzu data service, cloud) of a service (for example, RabbitMQ) across multiple clusters

## Prerequisites



Before you can follow this tutorial, you need access to three separate Tanzu Application Platform clusters v1.5.0 or later. This tutorial refers to the clusters as `iterate`, `run-test`, and `run-production`, but you can use different names if required.

## Scenario

This tutorial is centered around the following scenario.

You work at BigCorp as a service operator. BigCorp uses three separate Tanzu Application Platform clusters: `iterate`, `run-test`, and `run-production`. Application workloads begin on the `iterate` cluster, before being promoted to the `run-test` cluster, and then finally to the `run-production` cluster. The application development team have asked you for a PostgreSQL service to use with their workloads that is available on all three clusters.

The service level objectives (SLOs) for each cluster are different. You want to tailor the implementation of the PostgreSQL service to each of the clusters accordingly:

- The `iterate` cluster has low level SLOs, so you want to offer an unmanaged PostgreSQL service backed by a Helm chart.
- The `run-test` cluster has more robust requirements, so want to offer a PostgreSQL service backed by VMware SQL with Postgres for Kubernetes.
- The `run-production` cluster is critically important, so you want to use a fully managed and cloud-based PostgreSQL implementation.

You want to ensure that the differing implementations are completely opaque to development teams. They do not need to know about the inner workings of the services and must be able to keep their workloads and class claims the same as they are promoted across clusters. You want to use the claims and classes abstractions in Tanzu Application Platform to complete your task.

## Concepts

This section provides a high-level overview of the elements you will use during this tutorial and how these elements fit together.

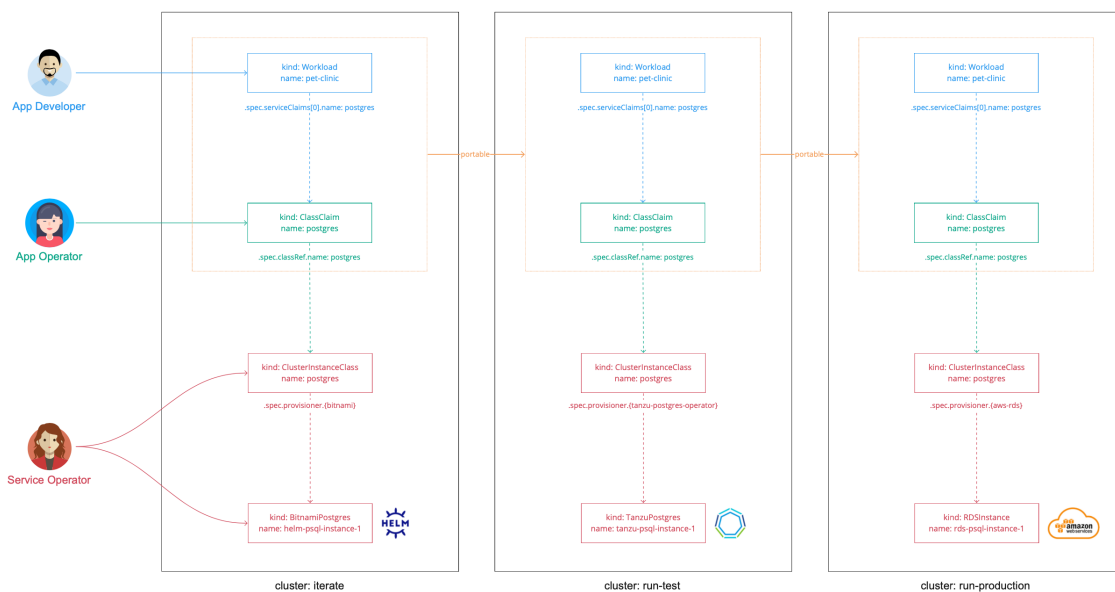

In this diagram:

- There are three clusters: `iterate`, `run-test`, and `run-production`.
- In each cluster, the service operator creates a `ClusterInstanceClass` called `postgres`.

- In the `iterate` cluster, `postgres` is a provisioner-based class that uses Bitnami Services to provision Helm instances of PostgreSQL.
  - In the `run-test` cluster, `postgres` is a provisioner-based class that uses VMware SQL with Postgres for Kubernetes to provision instances of PostgreSQL.
  - In the `run-production` cluster, `postgres` is a provisioner-based class that uses Amazon RDS to provision instances running in Amazon AWS RDS.
- The app operator creates a `ClassClaim`. This is applied with a consuming workload.
  - When it is applied in `iterate` it resolves to a Helm chart instance.
  - When it is promoted to `run-test` it resolves to a VMware PostgreSQL instance.
  - When it is promoted to `run-production` it resolves to an Amazon AWS RDS instance.
- The definition of the `ClassClaim` remains identical across the clusters, which is easier for the application development team.



### Important

The backing service implementations and environment layouts used in this scenario are arbitrary. They are not recommendations or requirements.

Although this tutorial uses provisioner-based classes on all three clusters, you can also use a combination of provisioner-based and pool-based classes across the clusters. You might want to do this in cases where, for example, you want to allow for dynamic provisioning of service instances in the `iterate` cluster, but want to be more considered about the approach in the `run-production` cluster to ensure that workloads only connect to a specific service instance. You can achieve this by using a provisioner-based class on the `iterate` cluster, and an identically named pool-based class on the `run-production` cluster that is configured to select from a pool that consists of one service instance.

## Procedure

The following steps explain how to set up a class that allows for claims to resolve to differing implementations of PostgreSQL depending on the cluster it is in.

### Step 1: Set up the run-test cluster

Configure the `run-test` cluster for dynamic provisioning of VMware PostgreSQL service instances. To do that, see [Configure dynamic provisioning of VMware SQL with Postgres for Kubernetes service instances](#) and complete the steps in the following sections only:

1. [Install the Tanzu VMware Postgres Operator](#)
2. [Set up the namespace](#)
3. [Create a CompositeResourceDefinition](#)
4. [Create a Composition](#)
5. [Configure RBAC](#)

You do not need to follow any other sections in that topic.

### Step 2: Set up the run-production cluster

Configure the `run-production` cluster for dynamic provisioning of AWS RDS PostgreSQL service instances. To do that, see [Configure Dynamic Provisioning of AWS RDS Service Instances](#) and complete the steps in the following sections only:

1. [Install the AWS Provider for Crossplane](#)
2. [Create a CompositeResourceDefinition](#)
3. [Create a Composition](#)
4. [Configure RBAC](#)

You do not need to follow any other sections in that topic.

### Step 3: Create the class

The `ClusterInstanceClass` acts as the abstraction fronting the differing service implementations across the different clusters. You must create a class with the same name on all three of the clusters, but the configuration of each class will be different. The `ClassClaim` refers to classes by name. The fact that the class name remains consistent is what allows for the `ClassClaim`, which the application development team creates, to remain unchanged as it is promoted across the clusters.

To create the class:

1. Configure a `ClusterInstanceClass` for the `iterate` cluster by creating a file named `postgres.class.iterate-cluster.yaml` with the following contents:

```
postgres.class.iterate-cluster.yaml

apiVersion: services.apps.tanzu.vmware.com/v1alpha1
kind: ClusterInstanceClass
metadata:
 name: bigcorp-postgresql
spec:
 description:
 short: PostgreSQL by BigCorp
 provisioner:
 crossplane:
 compositeResourceDefinition: xpostgresqlinstances.bitnami.database.tanzu.
 vmware.com
```

This class refers to the `xpostgresqlinstances.bitnami.database.tanzu.vmware.com CompositeResourceDefinition (XRD)`. This is installed as part of the [Bitnami Services](#) package and powers the PostgreSQL service. You are reusing the underlying XRD from a different class using the class name you want.

2. Apply the file to the `iterate` cluster by running:

```
kubectl apply -f postgres.class.iterate-cluster.yaml
```

3. Configure a `ClusterInstanceClass` for the `run-test` cluster by creating a file named `postgres.class.run-test-cluster.yaml` with the following contents:

```
postgres.class.run-test-cluster.yaml

apiVersion: services.apps.tanzu.vmware.com/v1alpha1
kind: ClusterInstanceClass
metadata:
 name: bigcorp-postgresql
spec:
 description:
```

```

short: PostgreSQL by BigCorp
provisioner:
 crossplane:
 compositeResourceDefinition: xpostgresinstances.database.tanzu.example.
org

```

This class is almost identical to the one for the `iterate` cluster, but this class refers to the `xpostgresinstances.database.tanzu.example.org` XRD.

4. Apply the file to the `run-test` cluster by running:

```
kubectl apply -f postgres.class.run-test-cluster.yaml
```

5. Configure a `ClusterInstanceClass` for the `run-production` cluster by creating a file named `postgres.class.run-production-cluster.yaml` with the following contents:

```

postgres.class.run-production-cluster.yaml

apiVersion: services.apps.tanzu.vmware.com/v1alpha1
kind: ClusterInstanceClass
metadata:
 name: bigcorp-postgresql
spec:
 description:
 short: PostgreSQL by BigCorp
 provisioner:
 crossplane:
 compositeResourceDefinition: xpostgresinstances.database.rds.example.or
g

```

This class is almost identical to the previous two, but this class refers to the `xpostgresinstances.database.rds.example.org` XRD.

6. Apply the file to the `run-production` cluster by running:

```
kubectl apply -f postgres.class.run-production-cluster.yaml
```

## Step 4: Create and promote the workload and class claim

After configuring the clusters and classes, switch roles from service operator to application operator and developer to create the workload and class claim YAML and promote it through the three clusters.

To create and promote the workload and class claim:

1. Create a `ClassClaim` by creating a file named `app-with-postgres.yaml` with the following contents:

```

app-with-postgres.yaml

apiVersion: services.apps.tanzu.vmware.com/v1alpha1
kind: ClassClaim
metadata:
 name: postgres
 namespace: default
spec:
 classRef:
 name: bigcorp-postgresql

apiVersion: carto.run/v1alpha1

```

```

kind: Workload
metadata:
 name: pet-clinic
 namespace: default
 labels:
 apps.tanzu.vmware.com/workload-type: web
 app.kubernetes.io/part-of: pet-clinic
spec:
 params:
 - name: annotations
 value:
 autoscaling.knative.dev/minScale: "1"
 env:
 - name: SPRING_PROFILES_ACTIVE
 value: postgres
 serviceClaims:
 - name: db
 ref:
 apiVersion: services.apps.tanzu.vmware.com/v1alpha1
 kind: ClassClaim
 name: postgres
 source:
 git:
 url: https://github.com/sample-accelerators/spring-petclinic
 ref:
 branch: main
 tag: tap-1.2

```

2. Apply the `app-with-postgres.yaml` file to the `iterate` cluster by running:

```
kubectl apply -f app-with-postgres.yaml
```

3. Wait for the workload to become ready and then inspect the cluster to see that the workload is bound to a Helm-based PostgreSQL service instance. Target the `iterate` cluster then confirm by running:

```
helm list -A
```

4. Apply the `app-with-postgres.yaml` file to the `run-test` cluster by running:

```
kubectl apply -f app-with-postgres.yaml
```

5. Wait for the workload to become ready and then confirm that the workload is bound to a Tanzu-based PostgreSQL service instance. Target the `run-test` cluster then confirm by running:

```
kubectl get postgres -n tanzu-psql-service-instances
```

6. Apply the `app-with-postgres.yaml` file to the `run-production` cluster by running:

```
kubectl apply -f app-with-postgres.yaml
```

7. Wait for the workload to become ready and then confirm that the workload is bound to a RDS-based PostgreSQL service instance. Target the `run-production` cluster then confirm by running:

```
kubectl get RDSInstance -A
```

## Use direct secret references

In this Services Toolkit tutorial you learn how developers can use direct references to Kubernetes `Secret` resources to connect their application workloads to almost any backing service.

This includes backing services that:

- Run external to Tanzu Application Platform
- Do not adhere to `ProvisionedService` in the Service Binding Specification for Kubernetes.

If you are familiar with Cloud Foundry and Tanzu Application Service, this capability is similar to the concept of user-provided service instances. For more information about user-provided service instances in Cloud Foundry, see the [Cloud Foundry documentation](#).

This tutorial demonstrates a procedure to bind a new application on Tanzu Application Platform to a PostgreSQL database in Azure. However, the steps are applicable to any backing service that you want to connect to.

## About this tutorial

**Target user role:** Service operator and application operator

**Complexity:** Easy

**Estimated time:** 10 minutes

**Topics covered:** Service binding, direct secret references

**Learning outcomes:** The ability to bind workloads to almost any backing service using direct secret references

## Prerequisites

Before you can follow this tutorial, you must have:

- Access to a Tanzu Application Platform cluster v1.5.0 or later.
- An Azure PostgreSQL database to connect to.
- Configured networking between the workload and the service endpoint and you must have the credentials for the backing service. Whether this requires extra steps depends on your Kubernetes distribution and the backing service you want to connect your Tanzu Application Platform workloads to.

## Create a binding-compatible secret

1. Create a file named `external-azure-db-binding-compatible.yaml` and enter a Kubernetes `Secret` resource similar to the following example:

```
external-azure-db-binding-compatible.yaml

apiVersion: v1
kind: Secret
metadata:
 name: external-azure-db-binding-compatible
type: Opaque
stringData:
 type: postgresql
 provider: azure
 host: EXAMPLE.DATABASE.AZURE.COM
 port: "5432"
 database: "EXAMPLE-DB-NAME"
 username: "USER@EXAMPLE"
 password: "PASSWORD"
```

Substitute in the values as required.

When using direct secret references, the `Secret` values must follow the [Well-known Secret Entries specification](#) as defined by the Service Binding Specification for Kubernetes. If you plan to bind this secret to a Spring-based application workload and want to take advantage of the auto-wiring feature, this `Secret` must also contain the properties required by [Spring Cloud Bindings](#).

2. Apply the `external-azure-db-binding-compatible.yaml` file. If you are using a multicluster Tanzu Application Platform topology, apply the file to all Run clusters.

Apply the file by running:

```
kubectl apply -f external-azure-db-binding-compatible.yaml
```

3. In a file named `stk-secret-reader.yaml`, grant sufficient Role-Based Access Control (RBAC) permissions to permit Services Toolkit to read the secrets specified by the class:

```
stk-secret-reader.yaml

apiVersion: rbac.authorization.k8s.io/v1
kind: ClusterRole
metadata:
 name: stk-secret-reader
 labels:
 servicebinding.io/controller: "true"
rules:
- apiGroups:
 - ""
 resources:
 - secrets
 verbs:
 - get
 - list
 - watch
```

4. Apply the `stk-secret-reader.yaml` file. If you are using a multicluster Tanzu Application Platform topology, apply the file to all Run clusters.

Apply the file by running:

```
kubectl apply -f stk-secret-reader.yaml
```

5. Create a claim for the newly created secret. If you are using a multicluster Tanzu Application Platform topology, create the claim on the Build cluster.

Create the claim by running:

```
tanzu service resource-claim create external-azure-db-claim \
 --resource-name external-azure-db-binding-compatible \
 --resource-kind Secret \
 --resource-api-version v1
```

6. Obtain the claim reference for the claim. If you are using a multicluster Tanzu Application Platform topology, obtain the claim reference on the Build cluster.

To get the claim reference, run:

```
tanzu service resource-claim list -o wide
```

Expected output:

NAME	READY	REASON	CLAIM REF
external-azure-db-claim	True		services.apps.tanzu.vmware.com/v1alpha

```
1:ResourceClaim:external-azure-db-claim
```

From the output, record the value of `CLAIM REF`.

7. Create an application workload. If you are using a multicluster Tanzu Application Platform topology, create the application workload on the Build cluster. Run a command similar to the following example:

```
tanzu apps workload create WORKLOAD-NAME \
 --git-repo https://github.com/sample-accelerators/spring-petclinic \
 --git-branch main \
 --git-tag tap-1.2 \
 --type web \
 --label app.kubernetes.io/part-of=spring-petclinic \
 --annotation autoscaling.knative.dev/minScale=1 \
 --env SPRING_PROFILES_ACTIVE=postgres \
 --service-ref db=REFERENCE
```

Where:

- `WORKLOAD-NAME` is the name of the application workload, for example, `pet-clinic`.
- `REFERENCE` is the value of the `CLAIM REF` for the newly created claim from the output of the previous step.

## Services Toolkit how-to guides

This section contains how-to guides for Services Toolkit.

In this section:

- [Authorize users and groups to claim from provisioner-based classes](#)
- [Configure dynamic provisioning of AWS RDS service instances](#)
- [Configure dynamic provisioning of VMware SQL with Postgres for Kubernetes service instances](#)
- [Configure private registry and VMware Tanzu Application Catalog integration for Bitnami Services](#)
- [Troubleshoot Services Toolkit](#)

## Authorize users and groups to claim from provisioner-based classes

This Services Toolkit topic for [service operators](#) explains how you configure access control so that the required users and groups have authorization to claim from provisioner-based classes.

By default, only users with `cluster-admin` privileges are authorized to create claims for provisioner-based classes. This is because creating claims for provisioner-based classes creates new service instances, all of which consume resources and might incur monetary cost. As such, you might want to configure some form of access control.

There is one exception to this rule, which is that by default, users with the `app-operator` user role are authorized to create claims for the provisioner-based classes that are part of the [Bitnami Services](#) package. For how-to deactivate this default behavior, see [Revoke default authorization for claiming from the Bitnami Services classes](#) later in this topic.

Access control is implemented through standard Kubernetes Role-Based Access Control (RBAC) with the use of the custom verb `claim`. You must create a rule in a `ClusterRole` which specifies the `claim` verb for one or more `clusterinstanceclasses`, and then bind the `ClusterRole` to the roles



that you want to authorize to create claims for classes with a `ClusterRoleBinding`. This approach is particularly effective when paired with Tanzu Application Platform's aggregated user roles. For more information about user roles in Tanzu Application Platform, see [Role descriptions](#).

## Authorize all users with the app-operator user role to claim from any namespace

Create a `ClusterRole` with a rule that specifies the `claim` verb for one or more `ClusterInstanceClass` resources and apply the relevant label.

For example:

```

apiVersion: rbac.authorization.k8s.io/v1
kind: ClusterRole
metadata:
 name: app-operator-claim-class-bigcorp-rabbitmq
 labels:
 apps.tanzu.vmware.com/aggregate-to-app-operator-cluster-access: "true"
rules:
- apiGroups:
 - services.apps.tanzu.vmware.com
 resources:
 - clusterinstanceclasses
 resourceName:
 - bigcorp-rabbitmq
 verbs:
 - claim
```

This example specifies a `ClusterRole` that permits claiming from a class named `bigcorp-rabbitmq`. The example also includes the `apps.tanzu.vmware.com/aggregate-to-app-operator-cluster-access: "true"` label, which causes this `ClusterRole` to aggregate to Tanzu Application Platform's `app-operator` user role at the cluster scope.

The result is that any user who has the `app-operator` role is now authorized to claim from the `bigcorp-rabbitmq` class. By default, the `app-operator` user role is authorized to create claims for the provisioner-based class.

## Authorize a user to claim from a specific namespace

Create a `ClusterRole` with a rule that specifies the `claim` verb for one or more `ClusterInstanceClass` resource and a corresponding `RoleBinding` to bind it to a user.

For example:

```

apiVersion: rbac.authorization.k8s.io/v1
kind: ClusterRole
metadata:
 name: claim-class-bigcorp-rabbitmq
rules:
- apiGroups:
 - services.apps.tanzu.vmware.com
 resources:
 - clusterinstanceclasses
 resourceName:
 - bigcorp-rabbitmq
 verbs:
 - claim

```

```

apiVersion: rbac.authorization.k8s.io/v1
kind: ClusterRoleBinding
metadata:
 name: alice-claim-class-bigcorp-rabbitmq
roleRef:
 apiGroup: rbac.authorization.k8s.io
 kind: ClusterRole
 name: claim-class-bigcorp-rabbitmq
subjects:
- kind: User
 name: "alice@example.com"
 apiGroup: rbac.authorization.k8s.io

```

This example specifies a `ClusterRole` that permits claiming from a class named `bigcorp-rabbitmq`. The YAML also creates a `ClusterRoleBinding` that binds the user `alice@example.com` to the `ClusterRole`.

The result is that `alice@example.com` is now authorized to claim from `bigcorp-rabbitmq` class.

The user `alice@example.com` still needs permission to create `ClassClaims` in namespaces that they want to consume the services from.

The following example gives `alice@example.com` permission to get, create, update, or delete `ClassClaims` in the `apps` namespace:

```

apiVersion: rbac.authorization.k8s.io/v1
kind: Role
metadata:
 name: create-class-claim-example
 namespace: apps
rules:
- apiGroups:
 - services.apps.tanzu.vmware.com
 resources:
 - classclaims
 verbs:
 - get
 - create
 - update
 - delete

apiVersion: rbac.authorization.k8s.io/v1
kind: RoleBinding
metadata:
 name: rbac-role-binding-role-binding
 namespace: apps
subjects:
- kind: User
 name: "alice@example.com"
 apiGroup: rbac.authorization.k8s.io
roleRef:
 kind: Role
 name: create-class-claim-example
 apiGroup: rbac.authorization.k8s.io

```

## Revoke default authorization for claiming from the Bitnami Services classes

By default, users with the `app-operator` user role are authorized to create claims for the provisioner-based classes which are part of the [Bitnami Services](#) package.

To revoke this authorization:

1. Add the following to your `tap-values.yaml` file:

```
bitnami_services:
 globals:
 create_clusterroles: false
```

2. Update Tanzu Application Platform by running:

```
tanzu package installed update tap -p tap.tanzu.vmware.com --values-file tap-values.yaml -n tap-install
```

The result is that any user who has the `app-operator` role is now not authorized to create claims for any of the Bitnami services in any namespace on the cluster.

## Configure dynamic provisioning of AWS RDS service instances

This Services Toolkit topic for [service operators](#) explains how you set up dynamic provisioning. This enables app development teams to self-serve AWS RDS service instances that are customized.

If you are not already familiar with dynamic provisioning in Tanzu Application Platform, following the tutorial [Set up dynamic provisioning of service instances](#) might help you to understand the steps presented in this topic.

### Prerequisites

Before you configure dynamic provisioning, you must have:

- Access to a Tanzu Application Platform cluster v1.6.1 or later.
- The Tanzu Service CLI plug-in v0.7.0 or later.
- Access to AWS.

## Configure dynamic provisioning

To configure dynamic provisioning for AWS RDS service instances, you must:

1. [Install the AWS Provider for Crossplane](#)
2. [Create a CompositeResourceDefinition](#)
3. [Create a Composition](#)
4. [Make the service discoverable](#)
5. [Configure RBAC](#)
6. [Verify your configuration](#)

### Install the AWS Provider for Crossplane

The first step is to install the AWS `Provider` for Crossplane.

The following variants of AWS `Provider` are available:

- [crossplane-contrib/provider-aws](#)
- [upbound/provider-aws](#)
- [upbound/provider-family-aws](#)

VMware recommends that you use the [upbound/provider-family-aws](#). This variant is both fully supported by Upbound and also gives you more control when installing APIs. This helps to improve performance issues often associated with the more monolithic [upbound/provider-aws](#). For more information about how Crossplane is resolving the Provider CRD scaling problem, see the [Crossplane Blog](#).

You must install both the top-level family Provider and the `provider-aws-rds` Provider. To do so:

1. Create a file named `provider-family-aws.yaml` and copy in the following contents, which configures both Providers:

```
provider-family-aws.yaml

The AWS "family" Provider - manages the ProviderConfig for all other Providers
in the same family.
Does not have to be created explicitly, if not created explicitly it will be
installed by the first Provider created
in the family.
apiVersion: pkg.crossplane.io/v1
kind: Provider
metadata:
 name: upbound-provider-family-aws
spec:
 package: xpkg.upbound.io/upbound/provider-family-aws:v0.36.0
 controllerConfigRef:
 name: upbound-provider-family-aws

The AWS RDS Provider - just one of the many Providers in the AWS family.
You can add as few or as many additional Providers in the same family as you
wish.
apiVersion: pkg.crossplane.io/v1
kind: Provider
metadata:
 name: upbound-provider-aws-rds
spec:
 package: xpkg.upbound.io/upbound/provider-aws-rds:v0.36.0
 controllerConfigRef:
 name: upbound-provider-family-aws

The ControllerConfig applies settings to a Provider Pod.
With family Providers each Provider is a unique Pod running in the cluster.
apiVersion: pkg.crossplane.io/v1alpha1
kind: ControllerConfig
metadata:
 name: upbound-provider-family-aws
```

2. Apply the file to the Tanzu Application Platform cluster by running:

```
kubectl apply -f provider-family-aws.yaml
```

3. Verify that both Providers are installed by running:

```
kubectl get providers
```

From the output, confirm that `INSTALLED=True` and `HEALTHY=TRUE`.

4. Create a `ProviderConfig` for the Providers. For instructions, see the sections *Create a Kubernetes secret for AWS* and *Create a ProviderConfig* in the [Upbound documentation](#).



### Important

The Upbound documentation assumes Crossplane is installed in the `upbound-system` namespace. However, when working with Crossplane on Tanzu Application Platform, it is installed to the `crossplane-system` namespace. Ensure that you use the correct namespace when you create the `Secret` with credentials for the `Provider`. **Note** Depending on the setup of your AWS account, you might also need to include `aws_session_token` in the `Secret`.

## Create a CompositeResourceDefinition

To create the CompositeResourceDefinition (XRD):

1. Create a file named `xpostgresinstances.database.rds.example.org.xrd.yaml` and copy in the following contents:

```
xpostgresinstances.database.rds.example.org.xrd.yaml

apiVersion: apiextensions.crossplane.io/v1
kind: CompositeResourceDefinition
metadata:
 name: xpostgresinstances.database.rds.example.org
spec:
 claimNames:
 kind: PostgreSQLInstance
 plural: postgresinstances
 connectionSecretKeys:
 - type
 - provider
 - host
 - port
 - database
 - username
 - password
 group: database.rds.example.org
 names:
 kind: XPostgreSQLInstance
 plural: xpostgresinstances
 versions:
 - name: v1alpha1
 referenceable: true
 schema:
 openAPIV3Schema:
 properties:
 spec:
 properties:
 storageGB:
 type: integer
 default: 20
 type: object
 type: object
 served: true
```

This XRD configures the parameter `storageGB`. This gives application teams the option to choose a suitable amount of storage for the AWS RDS service instance when they create a claim. You can choose to expose as many or as few parameters to application teams as you like.

2. Apply the file to the Tanzu Application Platform cluster by running:

```
kubectl apply -f xpostgresinstances.database.rds.example.org.xrd.yaml
```

## Create a Composition

To create the composition:

1. Create a file named `xpostgresinstances.database.rds.example.org.composition.yaml` and copy in the following contents:

```
xpostgresinstances.database.rds.example.org.composition.yaml

apiVersion: apiextensions.crossplane.io/v1
kind: Composition
metadata:
 labels:
 provider: "aws"
 vpc: "default"
 name: xpostgresinstances.database.rds.example.org
spec:
 compositeTypeRef:
 apiVersion: database.rds.example.org/v1alpha1
 kind: XPostgreSQLInstance
 publishConnectionDetailsWithStoreConfigRef:
 name: default
 resources:
 - base:
 apiVersion: rds.aws.upbound.io/v1beta1
 kind: Instance
 spec:
 forProvider:
 # NOTE: configure this section to your specific requirements
 instanceClass: db.t3.micro
 autoGeneratePassword: true
 passwordSecretRef:
 key: password
 namespace: crossplane-system
 engine: postgres
 engineVersion: "13.8" # <---- Refer to https://docs.aws.amazon.com/AmazonRDS/latest/PostgreSQLReleaseNotes/postgresql-release-calendar.html for latest
 name: postgres
 username: masteruser
 publiclyAccessible: true # <---- DANGER
 region: us-east-1
 skipFinalSnapshot: true
 writeConnectionSecretToRef:
 namespace: crossplane-system
 connectionDetails:
 - name: type
 value: postgresql
 - name: provider
 value: aws
 - name: database
 value: postgres
 - fromConnectionSecretKey: username
 - fromConnectionSecretKey: password
 - name: host
 fromConnectionSecretKey: endpoint
 - fromConnectionSecretKey: port
 name: instance
 patches:
 - fromFieldPath: metadata.uid
 toFieldPath: spec.forProvider.passwordSecretRef.name
 transforms:
 - string:
 fmt: '%s-postgresql-pw'
 type: Format
```

```

 type: string
 type: FromCompositeFieldPath
- fromFieldPath: metadata.uid
 toFieldPath: spec.writeConnectionSecretToRef.name
 transforms:
- string:
 fmt: '%s-postgresql'
 type: Format
 type: string
 type: FromCompositeFieldPath
- fromFieldPath: spec.storageGB
 toFieldPath: spec.forProvider.allocatedStorage
 type: FromCompositeFieldPath

```

This Composition configures all RDS PostgreSQL instances as follows:

- o All instances are placed in the `us-east-1` region.
  - o All instances use the default Virtual Private Cloud (VPC) for the respective AWS account.
  - o All instances are publicly accessible over the Internet.
2. If you want to keep the instances publicly accessible over the Internet and use the default VPC, add an inbound rule for TCP on port 5432 to the security group of the default VPC to allow connection to the instances.
  3. If you do not want the instances to be publicly accessible over the Internet, edit the Composition as required. Specific requirements vary, but this might include composing a combination of VPCs, Subnets, SubnetGroups, Routes, SecurityGroups, and SecurityGroupRules. Refer to Compositions that are available online for inspiration and guidance.

For example, see [getting-started-with-aws-with-vpc](#) in the [Upbound documentation](#). This example defines a Composition that creates a separate VPC for each RDS PostgreSQL instance and automatically configures inbound rules. If you want to follow this example, you might need to install additional Providers from the AWS Provider Family, such as [upbound/provider-aws-ec2](#).

4. Make any other configuration changes to the Composition so that it meets your specific requirements.
5. Apply the file to the Tanzu Application Platform cluster by running:

```
kubectl apply -f xpostgresqlinstances.database.rds.example.org.composition.yaml
```

## Make the service discoverable

To make the service discoverable to application teams:

1. Create a file named `rds.class.yaml` and copy in the following contents:

```

rds.class.yaml

apiVersion: services.apps.tanzu.vmware.com/v1alpha1
kind: ClusterInstanceClass
metadata:
 name: aws-rds-psql
spec:
 description:
 short: Amazon AWS RDS PostgreSQL
 provisioner:
 crossplane:

```

```
compositeResourceDefinition: xpostgresinstances.database.rds.example.org
```

2. Apply the file to the Tanzu Application Platform cluster by running:

```
kubectl apply -f rds.class.yaml
```

## Configure RBAC

To configure Role-Based Access Control (RBAC) to authorize users with the app-operator role to claim from the class:

1. Create a file named `app-operator-claim-aws-rds-psql.rbac.yaml` and copy in the following contents:

```
app-operator-claim-aws-rds-psql.rbac.yaml

apiVersion: rbac.authorization.k8s.io/v1
kind: ClusterRole
metadata:
 name: app-operator-claim-aws-rds-psql
 labels:
 apps.tanzu.vmware.com/aggregate-to-app-operator-cluster-access: "true"
rules:
- apiGroups:
 - "services.apps.tanzu.vmware.com"
 resources:
 - clusterinstanceclasses
 resourceNameNames:
 - aws-rds-psql
 verbs:
 - claim
```

2. Apply the file to the Tanzu Application Platform cluster by running:

```
kubectl apply -f app-operator-claim-aws-rds-psql.rbac.yaml
```

## Verify your configuration

To verify your configuration, create a claim for an AWS RDS service instance by running:

```
tanzu service class-claim create rds-psql-1 --class aws-rds-psql -p storageGB=30
```



### Note

Whether application workloads can establish network connectivity to the resulting RDS database depends on a number of factors. This includes specifics about the environment you're working in and the configuration in the [Composition](#) file. At a minimum, you can configure a [securityGroup](#) to permit inbound traffic. There might be other requirements as well.

## Configure dynamic provisioning of VMware SQL with Postgres for Kubernetes service instances

This Services Toolkit topic for [service operators](#) explains how you set up dynamic provisioning. This enables app development teams to create self-serve VMware SQL with Postgres for Kubernetes service instances that are customized to meet their needs.



If you are not already familiar with dynamic provisioning in Tanzu Application Platform, following the tutorial [Set up dynamic provisioning of service instances](#). might be help you understand the steps presented in this topic.

## Prerequisites

Before you configure dynamic provisioning, you must have:

- Access to a Tanzu Application Platform cluster v1.5.0 or later.
- The Tanzu Service CLI plug-in v0.6.0 or later.

## Configure dynamic provisioning

To configure dynamic provisioning for VMware SQL with Postgres for Kubernetes services instances, you must:

1. [Install the VMware Postgres Operator](#)
2. [Set up the namespace](#)
3. [Create a CompositeResourceDefinition](#)
4. [Create a Composition](#)
5. [Make the service discoverable](#)
6. [Configure RBAC](#)
7. [Verify your configuration](#)

## Install the VMware Postgres Operator

Install the VMware Postgres Operator by following the steps in [Installing a VMware Postgres Operator](#).

## Set up the namespace

This topic configures dynamic provisioning to provision all PostgreSQL service instances into the same namespace. This namespace is named `tanzu-psql-service-instances`.

To set up the namespace:

1. Ensure that the namespace exists by running the following:

```
kubectl create namespace tanzu-psql-service-instances
```

2. The VMware Postgres Operator also requires that a secret holding registry credentials exists in the same namespace that the service instances will be created in. Ensure that the secret exists in the namespace by running:

```
kubectl create secret --namespace=tanzu-psql-service-instances docker-registry
regsecret \
 --docker-server=MY-REGISTRY \
 --docker-username=`USERNAME` \
 --docker-password=`PASSWORD`
```

Where:

- `MY-REGISTRY` is the registry to which you relocated the VMware Postgres Operator images when you installed the operator.
- `USERNAME` is your registry username.

- o `PASSWORD` is your registry password.

## Create a CompositeResourceDefinition

To create the CompositeResourceDefinition (XRD):

1. Create a file named `xpostgresinstances.database.tanzu.example.org.xrd.yaml` and copy in the following contents:

```
xpostgresinstances.database.tanzu.example.org.xrd.yaml

apiVersion: apiextensions.crossplane.io/v1
kind: CompositeResourceDefinition
metadata:
 name: xpostgresinstances.database.tanzu.example.org
spec:
 connectionSecretKeys:
 - provider
 - type
 - database
 - host
 - password
 - port
 - uri
 - username
 group: database.tanzu.example.org
 names:
 kind: XPostgreSQLInstance
 plural: xpostgresinstances
 versions:
 - name: v1alpha1
 referenceable: true
 schema:
 openAPIV3Schema:
 properties:
 spec:
 properties:
 storageGB:
 type: integer
 default: 20
 type: object
 type: object
 served: true
```

This XRD configures the parameter `storageGB`. This gives application teams the option to choose a suitable amount of storage for the Tanzu Postgres service instance when they create a claim. You can choose to expose as many or as few parameters to application teams as you like.

2. Apply the file to the Tanzu Application Platform cluster by running:

```
kubectl apply -f xpostgresinstances.database.tanzu.example.org.xrd.yaml
```

## Create a Composition

To create the Composition:

1. Create a file named `xpostgresinstances.database.tanzu.example.org.composition.yaml` and copy in the following contents:

```
xpostgresinstances.database.tanzu.example.org.composition.yaml
```

```

apiVersion: apiextensions.crossplane.io/v1
kind: Composition
metadata:
 name: xpostgresinstances.database.tanzu.example.org
spec:
 compositeTypeRef:
 apiVersion: database.tanzu.example.org/v1alpha1
 kind: XPostgreSQLInstance
 publishConnectionDetailsWithStoreConfigRef:
 name: default
 resources:
 - base:
 apiVersion: kubernetes.crossplane.io/v1alpha1
 kind: Object
 spec:
 forProvider:
 manifest:
 apiVersion: sql.tanzu.vmware.com/v1
 kind: Postgres
 metadata:
 name: PATCHED
 namespace: tanzu-psql-service-instances
 spec:
 storageSize: 2G
 connectionDetails:
 - apiVersion: v1
 kind: Secret
 namespace: tanzu-psql-service-instances
 fieldPath: data.provider
 toConnectionSecretKey: provider
 - apiVersion: v1
 kind: Secret
 namespace: tanzu-psql-service-instances
 fieldPath: data.type
 toConnectionSecretKey: type
 - apiVersion: v1
 kind: Secret
 namespace: tanzu-psql-service-instances
 fieldPath: data.host
 toConnectionSecretKey: host
 - apiVersion: v1
 kind: Secret
 namespace: tanzu-psql-service-instances
 fieldPath: data.port
 toConnectionSecretKey: port
 - apiVersion: v1
 kind: Secret
 namespace: tanzu-psql-service-instances
 fieldPath: data.username
 toConnectionSecretKey: username
 - apiVersion: v1
 kind: Secret
 namespace: tanzu-psql-service-instances
 fieldPath: data.password
 toConnectionSecretKey: password
 - apiVersion: v1
 kind: Secret
 namespace: tanzu-psql-service-instances
 fieldPath: data.database
 toConnectionSecretKey: database
 - apiVersion: v1
 kind: Secret
 namespace: tanzu-psql-service-instances
 fieldPath: data.uri
 toConnectionSecretKey: uri

```

```

 writeConnectionSecretToRef:
 namespace: tanzu-psql-service-instances
connectionDetails:
- fromConnectionSecretKey: provider
- fromConnectionSecretKey: type
- fromConnectionSecretKey: host
- fromConnectionSecretKey: port
- fromConnectionSecretKey: username
- fromConnectionSecretKey: password
- fromConnectionSecretKey: database
- fromConnectionSecretKey: uri
patches:
- fromFieldPath: metadata.name
 toFieldPath: spec.forProvider.manifest.metadata.name
 type: FromCompositeFieldPath
- fromFieldPath: spec.storageSize
 toFieldPath: spec.forProvider.manifest.spec.persistence.storage
transforms:
- string:
 fmt: '%dG'
 type: Format
 type: string
 type: FromCompositeFieldPath
- fromFieldPath: metadata.name
 toFieldPath: spec.writeConnectionSecretToRef.name
transforms:
- string:
 fmt: '%s-psql'
 type: Format
 type: string
 type: FromCompositeFieldPath
- fromFieldPath: metadata.name
 toFieldPath: spec.connectionDetails[0].name
transforms:
- string:
 fmt: '%s-app-user-db-secret'
 type: Format
 type: string
 type: FromCompositeFieldPath
- fromFieldPath: metadata.name
 toFieldPath: spec.connectionDetails[1].name
transforms:
- string:
 fmt: '%s-app-user-db-secret'
 type: Format
 type: string
 type: FromCompositeFieldPath
- fromFieldPath: metadata.name
 toFieldPath: spec.connectionDetails[2].name
transforms:
- string:
 fmt: '%s-app-user-db-secret'
 type: Format
 type: string
 type: FromCompositeFieldPath
- fromFieldPath: metadata.name
 toFieldPath: spec.connectionDetails[3].name
transforms:
- string:
 fmt: '%s-app-user-db-secret'
 type: Format
 type: string
 type: FromCompositeFieldPath
- fromFieldPath: metadata.name
 toFieldPath: spec.connectionDetails[4].name
transforms:

```

```

- string:
 fmt: '%s-app-user-db-secret'
 type: Format
 type: string
type: FromCompositeFieldPath
- fromFieldPath: metadata.name
toFieldPath: spec.connectionDetails[5].name
transforms:
- string:
 fmt: '%s-app-user-db-secret'
 type: Format
 type: string
type: FromCompositeFieldPath
- fromFieldPath: metadata.name
toFieldPath: spec.connectionDetails[6].name
transforms:
- string:
 fmt: '%s-app-user-db-secret'
 type: Format
 type: string
type: FromCompositeFieldPath
- fromFieldPath: metadata.name
toFieldPath: spec.connectionDetails[7].name
transforms:
- string:
 fmt: '%s-app-user-db-secret'
 type: Format
 type: string
type: FromCompositeFieldPath
readinessChecks:
- type: MatchString
 fieldPath: status.atProvider.manifest.status.currentState
 matchString: "Running"

```

2. Configure the Composition you just copied to your specific requirements.
3. Apply the file to the Tanzu Application Platform cluster by running:

```
kubectl apply -f xpostgresinstances.database.tanzu.example.org.composition.yaml
```

## Make the service discoverable

To make the service discoverable to application teams:

1. Create a file named `tanzu-psql.class.yaml` and copy in the following contents:

```

tanzu-psql.class.yaml

apiVersion: services.apps.tanzu.vmware.com/v1alpha1
kind: ClusterInstanceClass
metadata:
 name: tanzu-psql
spec:
 description:
 short: VMware SQL with Postgres
 provisioner:
 crossplane:
 compositeResourceDefinition: xpostgresinstances.database.tanzu.example.org

```

2. Apply the file to the Tanzu Application Platform cluster by running:

```
kubectl apply -f tanzu-psql.class.yaml
```

## Configure RBAC

To configure access control with RBAC:

1. Create a file named `provider-kubernetes-tanzu-postgres-read-writer.rbac.yaml` and copy in the following contents:

```
provider-kubernetes-tanzu-postgres-read-writer.rbac.yaml

apiVersion: rbac.authorization.k8s.io/v1
kind: ClusterRole
metadata:
 name: tanzu-postgres-read-writer
 labels:
 services.tanzu.vmware.com/aggregate-to-provider-kubernetes: "true"
rules:
- apiGroups:
 - sql.tanzu.vmware.com
 resources:
 - postgres
 verbs:
 - "*"

```

2. Apply the file to the Tanzu Application Platform cluster by running:

```
kubectl apply -f provider-kubernetes-tanzu-postgres-read-writer.rbac.yaml
```

3. Create a file named `app-operator-claim-tanzu-psql.rbac.yaml` and copy in the following contents:

```
app-operator-claim-tanzu-psql.rbac.yaml

apiVersion: rbac.authorization.k8s.io/v1
kind: ClusterRole
metadata:
 name: app-operator-claim-tanzu-psql
 labels:
 apps.tanzu.vmware.com/aggregate-to-app-operator-cluster-access: "true"
rules:
- apiGroups:
 - "services.apps.tanzu.vmware.com"
 resources:
 - clusterinstanceclasses
 resourceName:
 - tanzu-psql
 verbs:
 - claim

```

4. Apply the file to the Tanzu Application Platform cluster by running:

```
kubectl apply -f app-operator-claim-tanzu-psql.rbac.yaml
```

## Verify your configuration

To verify your configuration, create a claim for a PostgreSQL service instance by running:

```
tanzu service class-claim create tanzu-psql-1 --class tanzu-psql -p storageGB=5
```

## Troubleshoot Services Toolkit

This topic explains how you can troubleshoot issues related to working with services on Tanzu Application Platform (commonly known as TAP).

For the limitations of services on Tanzu Application Platform, see [Services Toolkit limitations](#).

### Debug `ClassClaim` and provisioner-based `ClusterInstanceClass`

This section provides guidance on how to debug issues related to using `ClassClaim` and provisioner-based `ClusterInstanceClass`. The approach starts by inspecting a `ClassClaim` and tracing back through the chain of resources that are created when fulfilling the `ClassClaim`.

#### Prerequisites

To follow the steps in this section, you must have `kubectl` access to the cluster.

#### Step 1: Inspect the `ClassClaim`, `ClusterInstanceClass`, and `CompositeResourceDefinition`

1. Inspect the status of `ClassClaim` by running:

```
kubectl describe classclaim claim-name -n NAMESPACE
```

Where `NAMESPACE` is your namespace.

From the output, check the following:

- Check the status conditions for information that can lead you to the cause of the issue.
- Check `.spec.classRef.name` and record the value.

2. Inspect the status of the `ClusterInstanceClass` by running:

```
kubectl describe clusterinstanceclass CLASS-NAME
```

Where `CLASS-NAME` is the value of `.spec.classRef.name` you retrieved in the previous step.

From the output, check the following:

- Check the status conditions for information that can lead you to the cause of the issue.
- Check that the `Ready` condition has status `"True"`.
- Check `.spec.provisioner.crossplane` and record the value.

3. Inspect the status of the `CompositeResourceDefinition` by running:

```
kubectl describe xrd XRD-NAME
```

Where `XRD-NAME` is the value of `.spec.provisioner.crossplane` you retrieved in the previous step.

From the output, check the following:

- Check the status conditions for information that can lead you to the cause of the issue.
- Check that the `Established` condition has status `"True"`.

- Check events for any errors or warnings that can lead you to the cause of the issue.
- If both the `ClusterInstanceClass` reports `Ready="True"` and the `CompositeResourceDefinition` reports `Established="True"`, move on to the next section.

## Step 2: Inspect the Composite Resource, the Managed Resources and the underlying resources

1. Check `.status.provisionedResourceRef` by running:

```
kubectl describe classclaim claim-name -n NAMESPACE
```

Where `NAMESPACE` is your namespace.

From the output, check the following:

- Check `.status.provisionedResourceRef`, and record the values of `kind`, `apiVersion`, and `name`.

2. Inspect the status of the Composite Resource by running:

```
kubectl describe KIND.API-GROUP NAME
```

Where:

- `KIND` is the value of `kind` you retrieved in the previous step.
- `API-GROUP` is the value of `apiVersion` you retrieved in the previous step without the `/<version>` part.
- `NAME` is the value of `name` you retrieved in the previous step.

From the output, check the following:

- Check the status conditions for information that can lead you to the cause of the issue.
- Check that the `Synced` condition has status `"True"`. If it doesn't then there was an issue creating the Managed Resources from which this Composite Resource is composed. Refer to `.spec.resourceRefs` in the output and for each:
  - Use the values of `kind`, `apiVersion`, and `name` to inspect the status of the Managed Resource.
  - Check the status conditions for information that can lead you to the cause of the issue.
- Check events for any errors or warnings that can lead you to the cause of the issue.
- If all Managed Resources appear healthy, move on to the next section.

## Step 3: Inspect the events log

Inspect the events log by running:

```
kubectl get events -A
```

From the output, check the following:

- Check for any errors or warnings that can lead you to the cause of the issue.
- If there are no errors or warnings, move on to the next section.

## Step 4: Inspect the secret



1. Check `.status.resourceRef` by running:

```
kubectl get classclaim claim-name -n NAMESPACE -o yaml
```

Where `NAMESPACE` is your namespace.

From the output, check the following:

- o Check `.status.resourceRef` and record the values `kind`, `apiVersion`, `name`, and `namespace`

2. Inspect the claimed resource, which is likely a secret, by running:

```
kubectl get secret NAME -n NAMESPACE -o yaml
```

Where:

- o `NAME` is the `name` you retrieved in the previous step.
- o `NAMESPACE` is the `namespace` you retrieved in the previous step.

If the secret is there and has data, then something else must be causing the issue.

## Step 5: Contact support

If you have followed the steps in this section and are still unable to discover the cause of the issue, contact VMware Support for further guidance and help to resolve the issue.

## Unexpected error if `additionalProperties` is `true` in a `CompositeResourceDefinition`

### Symptom:

When creating a `CompositeResourceDefinition`, if you set `additionalProperties: true` in the `openAPIV3Schema` section, an error occurs during the validation step of the creation of any `ClassClaim` that refers to a class that refers to the `CompositeResourceDefinitions`.

The error appears as follows:

```
json: cannot unmarshal bool into Go struct field JSONSchemaProps.AdditionalProperties
of type apiextensions.JSONSchemaPropsOrBool
```

### Solution:

Rather than setting `additionalProperties: true`, you can set `additionalProperties: {}`. This has the same effect, but does not cause unexpected errors.

## Cannot claim from clusterinstanceclass when creating a `ClassClaim`

### Symptom:

Users who were previously able to create a `ClassClaim` now get an admission error similar to:

```
user 'alice@example.com' cannot 'claim' from clusterinstanceclass 'bigcorp-rabbitmq'
```

This occurs even if users were granted the `claim` permission on `ClusterInstanceClasses` through either:

- A `Role` and a `RoleBinding`
- A `ClusterRole` and a `RoleBinding`

**Explanation:**

You now need the cluster-level `claim` permission, granted through a `ClusterRole` and `ClusterRoleBinding`. Namespace-scoped permissions are no longer enough. This is to protect against unexpected access to resources in other namespaces.

This change was introduced with Services Toolkit v0.11.1 in Tanzu Application Platform v1.6.4. For more information about this change, see [The claim verb for ClusterInstanceClass](#).

**Solution:**

To allow users to create `ClassClaims` again, you must:

1. Move from a `Role` to a `ClusterRole` for granting users permission to claim a `ClusterInstanceClass`.
2. Move from a `RoleBinding` to a `ClusterRoleBinding` for binding this permission to a user.

For more information, see [Authorize users and groups to claim from provisioner-based classes](#).

## Services Toolkit reference

This section provides reference documentation for Services Toolkit.

In this section:

- [API documentation](#)
- [Tanzu Service CLI plug-in reference](#)
- [Services Toolkit terminology and user roles](#)
- [Example Compositions](#)
- [Services Toolkit limitations](#)

## Services Toolkit API documentation

This section of the documentation provides detailed information about Services Toolkit's APIs.

- [ClusterInstanceClass and ClassClaim](#)
- [ResourceClaim and ResourceClaimPolicy](#)
- [InstanceQuery](#)
- [RBAC](#)

## ClusterInstanceClass and ClassClaim

This topic provides Services Toolkit API documentation for `ClusterInstanceClass` and `ClassClaim`.

### ClusterInstanceClass

You can configure `ClusterInstanceClass` to one of two variants - either pool-based or provisioner-based.

- Claims for pool-based classes are fulfilled by identifying service instances using the configuration in `.spec.pool`.
- Claims for provisioner-based classes are fulfilled by provisioning new service instances using the configuration in `.spec.provisioner`.

A class can either be a pool-based class or a provisioner-based class, but never both.

The following snippet outlines the `ClusterInstanceClass` YAML:

```

apiVersion: services.apps.tanzu.vmware.com/v1alpha1
kind: ClusterInstanceClass

metadata:
 # A name for the class. The class name is used by consumers (application operators
 # and developers) when creating claims.
 name: mysql-unmanaged

spec:
 # Provide information about the class in the description.
 description:
 # A short description for the class. Aim to provide just enough information
 # to help consumers (application operators and developers) to understand
 # what's on offer by the class.
 short: MySQL by Bitnami

 # (Optional) Configure a provisioner-based class.
 # Must specify one of either `provisioner` or `pool`.
 provisioner:
 # Configure provisioning using Crossplane (https://www.crossplane.io/).
 crossplane:
 # CompositeResourceDefinition refers to the name of a Composite Resource Definition (XRD).
 # For example, "xpostgresinstances.database.example.org".
 compositeResourceDefinition: xmysqlinstances.bitnami.database.tanzu.vmware.com

 # (Optional) The compositionSelector allows you to match a Composition by
 # labels rather than naming one explicitly. It is used to set the compositionRef
 # if none is specified explicitly.
 compositionSelector:
 matchLabels:
 provider: bitnami
 type: mysql

 # (Optional) CompositionRef specifies which Composition this XR will use to
 # compose resources when it is created, updated, or deleted.
 # This can be omitted and is set automatically if the XRD has a default or
 # enforced composition reference, or if the below composition selector is set.
 compositionRef:
 name: composition-name

 # (Optional) CompositionUpdatePolicy specifies how existing XRs should be
 # updated to new revisions of their underlying composition.
 # One of either 'Automatic' or 'Manual'; default=Automatic.
 compositionUpdatePolicy: Manual

 # (Optional) Configure a pool-based class.
 # Must specify one of either `provisioner` or `pool`.
 pool:
 # (Optional) Group specifies the API group for the resources belonging to this class.
 group:

 # Kind specifies the API Kind for the resources belonging to this class.
 kind:

 # (Optional) FieldSelector specifies a set of fields that MUST match certain conditions.
 # See https://kubernetes.io/docs/concepts/overview/working-with-objects/field-selectors/.
 fieldSelector:

 # (Optional) LabelSelector specifies a set of labels that MUST match.
 # See https://kubernetes.io/docs/concepts/overview/working-with-objects/labels/#labels.

```

```

bel-selectors.
 labelSelector:

status is populated by the controller
status:
 # Conditions for the class.
 conditions:
 # The condition type. Currently only 'Ready'.
 - type: Ready
 # status can be either 'True' or 'False'.
 status: "True"
 # reason provides a reason for status: "False" for additional context.
 # One of 'PooledResourceNotFound', 'CompositeResourceDefinitionNotFound',
 # 'CompositeResourceDefinitionNotValid', or 'CompositeResourceDefinitionNotRead
y'.
 # Not set if status: "True".
 reason:

(Optional) claimParameters contains the OpenAPIV3Schema used to configure
claims for this class.
Not set on pool-based classes.
claimParameters:
 openAPIV3Schema:
 description: The OpenAPIV3Schema of this Composite Resource Definition.
 properties:
 storageGB:
 default: 1
 description: The desired storage capacity of the database, in Gigabytes.
 type: integer
 type: object

instanceType holds information about the resource selected by this class.
If using the Crossplane provisioner, this refers to the CompositeResource (XR)
defined by the CompositeResourceDefinition (XRD) referred to in the class.
instanceType:
 # (Optional) Group specifies the API group.
 group: bitnami.database.tanzu.vmware.com
 # Kind specifies the API Kind.
 kind: XMySQLInstance
 # Version specifies the API version.
 version: v1alpha1

Populated based on metadata.generation when controller observes a change to
the resource. If this value is out of date, other status fields do not
reflect latest state.
observedGeneration: 1

```

## ClassClaim

**ClassClaim** refers to a **ClusterInstanceClass** from which service instances are then either selected (for pool-based classes) or provisioned (for provisioner-based classes) to fulfill the claim. **ClassClaim** adheres to **Provisioned Service** as defined by the Service Binding Specification for Kubernetes. You can bind a **ClassClaim** to an application workload by using a reference in the workload's `.spec.serviceClaims` configuration.

The following snippet outlines the **ClassClaims** YAML:

```

apiVersion: services.apps.tanzu.vmware.com/v1alpha1
kind: ClassClaim

metadata:
 # The name for the claim.
 name: mysql-claim-1
 # The namespace in which to create the claim.

```

```

namespace: my-apps

spec:
 # classRef holds a reference to a ClusterInstanceClass.
 classRef:
 # The name of the class from which to claim a service instance.
 # For information about the permissions users must have to claim from the class,
 # see the note below this snippet.
 name: mysql-unmanaged

 # (Optional) parameters are key-value pairs that are configuration inputs to the
 # instance obtained from the referenced ClusterInstanceClass. These parameters
 # only take effect when referring to a provisioner-based class.
 parameters:
 key: value

status:
 # Conditions for the claim.
 conditions:
 # The condition type. Can be one of 'Ready', 'ClassMatched', 'Validated', or
 # 'ResourceClaimCreated'. All condition types are initialized for all claims.
 # The Ready condition reports status: "True" once all other condition types are healthy.
 - type: Ready
 # status can be either 'True' or 'False'.
 status: "True"
 # reason provides a reason for status: "False" for additional context.
 # One of 'UnableToFetchClass', 'ClassDoesNotExist', 'ClassNotReady',
 # 'UnableToQueryClaimableInstances', 'NoClaimableInstances',
 # 'UnableToCreateResourceClaim', 'UnableToCreateClaimableInstance', 'ResourceReady',
 # 'ResourceNotReady', 'ResourceReadyUnsupported', or 'ReasonParametersInvalid'.
 # Not set if status: "True".
 reason:

 # binding holds a reference to a secret, in the same namespace, which contains
 # credentials for accessing the claimed service instance.
 binding:
 # The name of the `Secret`. The presence of the .status.binding.name field
 # marks this resource as a Provisioned Service.
 name: 770845b6-02f0-4c1b-8d0c-3dae81bad35c

 # provisionedResourceRef contains a reference to the provisioned resource.
 # Only set if the claim refers to a provisioner-based class.
 provisionedResourceRef:
 # The API Group/Version of the provisioned resource in the GROUP/VERSION format.
 apiVersion: bitnami.database.tanzu.vmware.com/v1alpha1
 # The API kind of the provisioned resource.
 kind: XMySQLInstance
 # The name of the provisioned resource.
 name: mysql-1-57dr7

 # resourceRef contains a reference to the claimed resource.
 resourceRef:
 # The API Group/Version of the claimed resource in the GROUP/VERSION format.
 apiVersion: v1
 # The API kind of the claimed resource.
 kind: Secret
 # The name of the claimed resource.
 name: 770845b6-02f0-4c1b-8d0c-3dae81bad35c
 # The namespace of the claimed resource.
 namespace: my-apps

 # Populated based on metadata.generation when controller observes a change to
 # the resource. If this value is out of date, other status fields do not reflect

```

```
latest state.
observedGeneration: 1
```



### Note

If you refer to a provisioner-based class in `spec.classref.name`, you must have sufficient RBAC permission to claim from the class. For more information, see [Authorize users and groups to claim from provisioner-based classes](#).

## ResourceClaim and ResourceClaimPolicy

This topic provides Services Toolkit API documentation for [ResourceClaim](#) and [ResourceClaimPolicy](#).

### ResourceClaim

[ResourceClaim](#) is used to claim a specific Kubernetes resource by using a reference. [ResourceClaim](#) adheres to [Provisioned Service](#) as defined by the Service Binding Specification for Kubernetes. you can bind a [ResourceClaim](#) to an application workload by using a reference in the workload's `.spec.serviceClaims` configuration.

A [ResourceClaim](#) is exclusive by nature. This means that after a [ResourceClaim](#) has claimed a resource, no other [ResourceClaim](#) can claim that same resource.

```
apiVersion: services.apps.tanzu.vmware.com/v1alpha1
kind: ResourceClaim

metadata:
 # The name for the claim.
 name: claim-1
 # The namespace in which to create the claim.
 namespace: my-apps
 # Internal finalizers applied by the resource claim controller to ensure
 # resources are cleaned up.
 finalizers:
 - resourceclaims.services.apps.tanzu.vmware.com/finalizer
 - resourceclaims.services.apps.tanzu.vmware.com/lease-finalizer

spec:
 # ref is a reference to the resource to be claimed.
 ref:
 # The API Group/Version of the resource to claim in the GROUP/VERSION format.
 apiVersion: v1
 # The API Kind of the resource to claim.
 kind: Secret
 # The name of the resource to claim.
 name: 770845b6-02f0-4c1b-8d0c-3dae81bad35c
 # (Optional) The namespace of the resource to claim. If the resource exists
 # in a different namespace to the namespace of the claim, then you must configure
 # a corresponding ResourceClaimPolicy to permit claiming of the resource.
 namespace: service-instances

status:
 # Conditions for the claim.
 conditions:
 # The condition type. Can be one of 'Ready', 'ResourceMatched' or 'ResourceMatche
 d'.
 # All condition types are initialized for all claims.
 # The Ready condition reports status: "True" once all other condition types are he
 althy.
```

```

- type: Ready
 # status can be either 'True' or 'False'.
 status: "True"
 # reason provides a reason for status: "False" for additional context.
 # One of 'ResourceNotFound', 'BindingNotCopyable', 'UnableToSetExclusiveClaim',
 # 'ResourceNonBindable', 'NoMatchingResourceClaimPolicy',
 # 'UnableToTrackReferencedResource', 'ResourceAlreadyClaimed',
 # 'UpdatedResourceReference', or 'ClaimMarkedForDeletion'.
 # Not set if status: "True".
 reason:

binding holds a reference to a secret in the same namespace which contains
credentials for accessing the claimed service instance.
binding:
 # The name of the secret. The presence of the .status.binding.name field marks
 # this resource as a Provisioned Service.
 name: 770845b6-02f0-4c1b-8d0c-3dae81bad35c

claimedResourceRef holds a reference to the claimed resource.
claimedResourceRef:
 # The API Group/Version of the claimed resource in the GROUP/VERSION format.
 apiVersion: v1
 # The API kind of the claimed resource.
 kind: Secret
 # The name of the claimed resource.
 name: 770845b6-02f0-4c1b-8d0c-3dae81bad35c
 # The namespace of the claimed resource.
 namespace: service-instances

Populated based on metadata.generation when controller observes a change to
the resource. If this value is out of date, other status fields do not
reflect latest state.
observedGeneration: 1

```

## ResourceClaimPolicy

[ResourceClaimPolicy](#) provides a mechanism to either permit or deny the claiming of resources across namespaces.

```

apiVersion: services.apps.tanzu.vmware.com/v1alpha1
kind: ResourceClaimPolicy

metadata:
 # The name for the policy.
 name: default-ns-can-claim-secret-1
 # The namespace for the policy.
 # ResourceClaimPolicy resources must exist in the same namespace as the resources
 # they are permitting to be claimed.
 namespace: x-namespace-1

spec:
 # consumingNamespaces specifies the source namespace(s) to permit the claiming
 # of the resources from.
 # Use '*' to configure all namespaces.
 consumingNamespaces:
 - default

 # The API group of the resource to permit the claiming of.
 group: rabbitmq.com
 # The API kind of the resource to permit the claiming of.
 kind: RabbitmqCluster
 # (Optional) selector is a labelSelector to match resources to permit the claiming o
 f.
 selector:

```

```
matchLabels:
 "key": "value"
```

## InstanceQuery

This topic provides Services Toolkit API documentation for [InstanceQuery](#).

## InstanceQuery

[InstanceQuery](#) is a create-only API that, given a pool-based [ClusterInstanceClass](#), returns the intersection of the set of service instances represented by that class and the claimable service instances for the namespace of the [InstanceQuery](#).

```
apiVersion: claimable.services.apps.tanzu.vmware.com/v1alpha1
kind: InstanceQuery

metadata:
 # An arbitrary name for the query.
 name: test
 # The namespace from which to run the query. The resulting list of instances is
 # specific to the namespace of the query itself.
 namespace: my-apps

spec:
 # The name of the class to query for claimable instances. Must refer to a
 # pool-based class and not a provisioner-based class.
 class: pooled-class-1
 # (Optional) A limit on the maximum number of instances to return.
 # The default is 50.
 limit: 1

status:
 # A list of service instances that you can claim by using ResourceClaims created
 # in the same namespace as the query.
 instances:
 # The API group/version of the claimable instance in the format GROUP/VERSION.
 - apiVersion: v1
 # The API kind of the claimable instance.
 kind: Secret
 # The name of the claimable instance.
 name: my-secret-two
 # The namespace of the claimable instance.
 namespace: default
```

## RBAC

This topic provides API documentation for Role-Based Access Control (RBAC) relating to Services Toolkit's APIs.

## Aggregation labels

This section describes the following Aggregation labels:

- [servicebinding.io/controller](#): "true"
- [services.tanzu.vmware.com/aggregate-to-provider-kubernetes](#): "true"
- [services.tanzu.vmware.com/aggregate-to-provider-helm](#): "true"

### [servicebinding.io/controller](#): "true"



Use this label to grant the Services Toolkit and service bindings controllers permission to get, list, and watch resources to be claimed and bound in the cluster.

For example, the following `ClusterRole` grants the controllers permission to get, list, and watch `RabbitmqCluster` resources. You cannot create `ClassClaims` or `ResourceClaims` unless the controllers have at least these permissions for each resource type being claimed.

```
apiVersion: rbac.authorization.k8s.io/v1
kind: ClusterRole
metadata:
 name: resource-claims-rmq-role
 labels:
 servicebinding.io/controller: "true"
rules:
- apiGroups:
 - rabbitmq.com
 resources:
 - rabbitmqclusters
 verbs:
 - get
 - list
 - watch
```

### `services.tanzu.vmware.com/aggregate-to-provider-kubernetes: "true"`

Use this label to aggregate RBAC rules to `provider-kubernetes`, which is a Crossplane `Provider` installed by default as part of the `Crossplane` package in Tanzu Application Platform. You must grant relevant RBAC permissions for each API Group/Kind used during the creation of `Compositions` as part of setting up dynamic provisioning.

For example, the following `ClusterRole` grants `provider-kubernetes` full control over `rabbitmqclusters` on the `rabbitmq.com` API Group. This allows you to compose `rabbitmqclusters` in `Compositions`. For a full example, see [Setup Dynamic Provisioning of Service Instances](#).

```

apiVersion: rbac.authorization.k8s.io/v1
kind: ClusterRole
metadata:
 name: rmqcluster-read-writer
 labels:
 services.tanzu.vmware.com/aggregate-to-provider-kubernetes: "true"
rules:
- apiGroups:
 - rabbitmq.com
 resources:
 - rabbitmqclusters
 verbs:
 - "*"

```

### `services.tanzu.vmware.com/aggregate-to-provider-helm: "true"`

Use this label to aggregate RBAC rules to `provider-helm`, which is a Crossplane `Provider` installed by default as part of the `Crossplane` package in Tanzu Application Platform. You must grant relevant RBAC permissions for each API Group/Kind used during the creation of Helm releases when using the `Release` managed resource as part of `Compositions`.

For example, the following `ClusterRole` grants `provider-helm` full control over `rabbitmqclusters` on the `rabbitmq.com` API Group. This allows you to compose Helm `Releases` which themselves eventually deploy `rabbitmqclusters` in your `Compositions`.

```

apiVersion: rbac.authorization.k8s.io/v1
kind: ClusterRole
metadata:
 name: rmqcluster-read-writer
 labels:
 services.tanzu.vmware.com/aggregate-to-provider-helm: "true"
rules:
- apiGroups:
 - rabbitmq.com
 resources:
 - rabbitmqclusters
 verbs:
 - "*"

```

## The claim verb for ClusterInstanceClass

Services Toolkit supports using the `claim` verb for RBAC rules that apply to a `ClusterInstanceClass`. You can use this with relevant aggregating labels or `ClusterRoleBindings` as a form of access control to specify who can claim from which `ClusterInstanceClass`.

For example:

```

apiVersion: rbac.authorization.k8s.io/v1
kind: ClusterRole
metadata:
 name: app-operator-claim-class-bigcorp-rabbitmq
 labels:
 # (Optional) Aggregates this ClusterRole to Tanzu Application Platform's
 # app-operator user role at the cluster scope. You can choose to aggregate
 # this to any of the other standard user roles as well.
 apps.tanzu.vmware.com/aggregate-to-app-operator-cluster-access: "true"
rules:
Permits claiming from the 'bigcorp-rabbitmq' class
- apiGroups:
 - services.apps.tanzu.vmware.com
 resources:
 - clusterinstanceclasses
 resourceName:
 - bigcorp-rabbitmq
 verbs:
 - claim

```

As of Services Toolkit v0.11.1 in Tanzu Application Platform v1.6.4, you must grant the permission to `claim` from a `ClusterInstanceClass` at the cluster level. You now must use a `ClusterRole` and `ClusterRoleBinding`. Namespace-scoped permissions, such as using a `Role` and `RoleBinding` or `ClusterRole` and `RoleBinding`, are not sufficient. If you used `Roles` and `RoleBindings`, or `ClusterRoles` and `RoleBindings` to grant `claim` permissions in specific namespaces only, this change might affect you. For more information, see [Authorize users and groups to claim from provisioner-based classes](#).

Previously, Services Toolkit allowed you to `claim` from a `ClusterInstanceClass` with only namespace-level permissions. However, this allowed users with only namespace-level permissions to obtain or indirectly deploy resources into namespaces that they do not have access to according to the RBAC permissions.

## Tanzu Service CLI plug-in reference

This topic provides reference information about the Tanzu Service CLI plug-in for Services Toolkit. The main use for the plug-in is for [application operators](#) and [application developers](#) to create claims. It aims to offer you a service experience that is consistent with other Tanzu CLI commands.

The reference material in this topic is split by sub-command.

## tanzu service class

Classes, sometimes called instance classes or service instance classes, are a means to discover and describe groupings of similar service instances. They are analogous to the concept of storage classes in Kubernetes.

You can discover the range of services on offer by listing the available classes on a cluster. See `tanzu service class list -h`.

You can create a claim for a service instance of a particular class by running the `tanzu service class-claim create` command.

When you get a class, you can see more detailed information about it, including, where available, a list of parameters that you can pass to the `tanzu service class-claim create` command using the `--parameter` flag.

### tanzu service class list

This command lists the available classes.

```
Usage:
 tanzu service class list [flags]

Examples:
 tanzu service class list

Flags:
 -h, --help help for list

Global Flags:
 --context string name of the kubeconfig context to use (default is current-
context defined by kubeconfig)
 --kubeconfig string kubeconfig file (default is /home/eking/.kube/config)
 --no-color turn off color output in terminals
```

### tanzu service class get

This command gets detailed information for a class.

The output includes more detailed information about the class, including, where available, a list of parameters that you can pass to the `tanzu service class-claim create` command using the `--parameter` flag.

```
Usage:
 tanzu service class get [name] [flags]

Examples:
 tanzu service class get rmq-small

Flags:
 -h, --help help for get

Global Flags:
 --context string name of the kubeconfig context to use (default is current-
context defined by kubeconfig)
```

```
--kubeconfig string kubeconfig file (default is /home/eking/.kube/config)
--no-color turn off color output in terminals
```

## tanzu service class-claim

Class claims allow you to create claims by only referring to a class.

Class claims are an alternative approach to resource claims, which require you to refer to a specific resource by name, namespace, kind and API group/version.

VMware recommends that you work with class claims wherever possible because they are easier to create and are considered more portable across multiple clusters.

### tanzu service class-claim create

This command creates a claim by referring to a class.

You can bind claims for service instances to application workloads.

Claims are mutually exclusive, meaning that after a service instance has been claimed, no other claim can claim it. This prevents unauthorized application workloads from accessing a service instance that your application workloads are using.

You can pass parameters with the `--parameter key.subKey=value` flag. You can provide this flag multiple times. The value must be valid YAML. You can find available parameters for a class by running `tanzu service class get CLASS-NAME`.

```
Usage:
 tanzu service class-claim create [name] [flags]

Examples:
 tanzu service class-claim create psql-claim-1 --class postgres
 tanzu service class-claim create rmq-claim-1 --class rmq --parameter durable=true --
parameter replicas=3

Flags:
 --class string the name of a class to claim an instance of
 -h, --help help for create
 -n, --namespace name kubernetes namespace (defaulted from kube config)
 -p, --parameter stringArray claim parameters

Global Flags:
 --context string name of the kubeconfig context to use (default is current-
context defined by kubeconfig)
 --kubeconfig string kubeconfig file (default is /home/eking/.kube/config)
 --no-color turn off color output in terminals
```

### tanzu service class-claim get

This command gets detailed information for a class claim.

The output includes the name of the class the claim was created for and the claim ref. Pass claim refs to the `--service-ref` flag of the `tanzu apps workload create` command to bind workloads to claimed service instances.

```
Usage:
 tanzu service class-claim get [flags]

Examples:
 tanzu service class-claim get psql-claim-1
 tanzu service class-claim get psql-claim-1 --namespace app-ns-1
```

```

Flags:
 -h, --help help for get
 -n, --namespace name kubernetes namespace (defaulted from kube config)

Global Flags:
 --context string name of the kubeconfig context to use (default is current-
context defined by kubeconfig)
 --kubeconfig string kubeconfig file (default is /home/eking/.kube/config)
 --no-color turn off color output in terminals

```

## tanzu service class-claim delete

This command deletes a class claim.

You will be prompted to confirm the deletion unless you pass the `--yes` flag. Before you delete a claim, you must be aware of the consequences of doing so.

When you create a claim, it signals a that you want a service instance. You usually create a service instance to bind it to one or more application workload. If you delete a claim, it signals that you no longer need the claimed service instance. At this point, other claims created by other users can claim the service instance you previously claimed.

```

Usage:
 tanzu service class-claim delete [flags]

Examples:
 tanzu service class-claim delete psql-claim-1
 tanzu service class-claim delete psql-claim-1 --yes
 tanzu service class-claim delete psql-claim-1 --namespace app-ns-1

Flags:
 -h, --help help for delete
 -n, --namespace name kubernetes namespace (defaulted from kube config)
 -y, --yes skip the confirmation of the deletion

Global Flags:
 --context string name of the kubeconfig context to use (default is current-
context defined by kubeconfig)
 --kubeconfig string kubeconfig file (default is /home/eking/.kube/config)
 --no-color turn off color output in terminals

```

## tanzu service class-claim list

This command lists class claims in a namespace or across all namespaces.

If you run this command with the `-o wide` flag, claim refs for each of the claims are printed. Pass claim refs to the `--service-ref` flag of the `tanzu apps workload create` command to bind workloads to claimed service instances.

```

Usage:
 tanzu service class-claim list [flags]

Examples:
 tanzu service class-claim list
 tanzu service class-claim list --class postgres
 tanzu service class-claim list -o wide
 tanzu service class-claim list -n app-ns-1 -o wide

Flags:
 -A, --all-namespaces list class claims across all namespaces
 -c, --class string list class claims referencing this class
 -h, --help help for list
 -n, --namespace name kubernetes namespace (defaulted from kube config)

```

```

-o, --output string output format (currently the only available option is 'wide')

Global Flags:
--context string name of the kubeconfig context to use (default is current-
context defined by kubeconfig)
--kubeconfig string kubeconfig file (default is /home/eking/.kube/config)
--no-color turn off color output in terminals

```

## tanzu service resource-claim

Resource claims enable you to create claims by referring to a specific resource by name, namespace, kind, and API group or version.

Resource claims are an alternative approach to class claims, which only require you to refer to a class.

VMware recommends that you work with [class claims](#) wherever possible because they are easier to create and are more portable across multiple clusters.

### tanzu service resource-claim create

This command creates a claim for a specific resource.

It is common to create claims for resources that you can bind to application workloads using the claim.

This approach to creating claims differs to that of class claims, in which the system ultimately finds and supplies a claimable resource for you. You only have to work with resource claims if you want full control over which resource is claimed. If not, it is simpler and more convenient to work with class claims. See [tanzu service class-claim --help](#).

Claims are mutually exclusive, meaning that after a service instance has been claimed, no other claim can claim it. This prevents unauthorized application workloads from accessing a resource that your application workloads are using.

To find resources you can create resource claims for, run the [tanzu service claimable list](#) command.

```

Usage:
 tanzu service resource-claim create [name] [flags]

Examples:
 tanzu service resource-claim create psql-claim-1 --resource-name psql-instance-1 --r
esource-kind Postgres --resource-api-version sql.example.com/v1
 tanzu service resource-claim create psql-claim-1 --resource-name psql-instance-1 --r
esource-kind Postgres --resource-api-version sql.example.com/v1 --resource-namespace s
ervice-instances-1
 tanzu service resource-claim create psql-claim-1 --resource-name secret-1 --resource
-kind Secret --resource-api-version v1

Flags:
 -h, --help help for create
 -n, --namespace name kubernetes namespace (defaulted from kube confi
g)
 --resource-api-version string API group and version of the resource to claim
(in the form '<GROUP>/<VERSION>')
 --resource-kind string kind of the resource to claim
 --resource-name string name of the resource to claim
 --resource-namespace string namespace of the resource to claim

Global Flags:
 --context string name of the kubeconfig context to use (default is current-
context defined by kubeconfig)

```

```
--kubeconfig string kubeconfig file (default is /home/eking/.kube/config)
--no-color turn off color output in terminals
```

## tanzu service resource-claim get

This command gets detailed information for a resource claim.

The output includes the name of claimed resource and the claim ref. Pass claim refs to the `--service-ref` flag of the `tanzu apps workload create` command to bind workloads to claimed service instances.

```
Usage:
 tanzu service resource-claim get [name] [flags]

Examples:
 tanzu service resource-claim get psql-claim-1
 tanzu service resource-claim get psql-claim-1 --namespace app-ns-1

Flags:
 -h, --help help for get
 -n, --namespace name kubernetes namespace (defaulted from kube config)

Global Flags:
 --context string name of the kubeconfig context to use (default is current-
context defined by kubeconfig)
 --kubeconfig string kubeconfig file (default is /home/eking/.kube/config)
 --no-color turn off color output in terminals
```

## tanzu service resource-claim delete

This command deletes a resource claim.

You will be prompted to confirm the deletion unless you pass the `--yes` flag. Before you delete a claim, you must be aware of the consequences of doing so.

When you create a claim, it signals a that you want a resource. You usually create a resource to bind it to one or more application workload. If you delete a claim, it signals that you no longer need the claimed resource. At this point, other claims created by other users can claim the resource you previously claimed.

```
Usage:
 tanzu service resource-claim delete [name] [flags]

Examples:
 tanzu service resource-claim delete psql-claim-1
 tanzu service resource-claim delete psql-claim-1 --yes
 tanzu service resource-claim delete psql-claim-1 --namespace app-ns-1

Flags:
 -h, --help help for delete
 -n, --namespace name kubernetes namespace (defaulted from kube config)
 -y, --yes skip the confirmation of the deletion

Global Flags:
 --context string name of the kubeconfig context to use (default is current-
context defined by kubeconfig)
 --kubeconfig string kubeconfig file (default is /home/eking/.kube/config)
 --no-color turn off color output in terminals
```

## tanzu service resource-claim list

This command lists resource claims in a namespace or across all namespaces.

If you run this command with the `-o wide` flag, claim refs for each of the claims are printed. Pass claim refs to the `--service-ref` flag of the `tanzu apps workload create` command to bind workloads to claimed service instances.

```
Usage:
 tanzu service resource-claim list [flags]

Examples:
 tanzu service resource-claim list
 tanzu service resource-claim list -o wide
 tanzu service resource-claim list -n app-ns-1 -o wide

Flags:
 -A, --all-namespaces list resource claims across all namespaces
 -h, --help help for list
 -n, --namespace name kubernetes namespace (defaulted from kube config)
 -o, --output string output format (currently the only available option is 'wide')

Global Flags:
 --context string name of the kubeconfig context to use (default is current-
context defined by kubeconfig)
 --kubeconfig string kubeconfig file (default is /home/eking/.kube/config)
 --no-color turn off color output in terminals
```

## tanzu service claimable

Searches for resources that are available to claim.

### tanzu service claimable list

This command lists resources for a class that you can claim directly using the `tanzu service resource-claim create` command.

```
Usage:
 tanzu service claimable list [flags]

Examples:
 tanzu service claimable list --class postgres
 tanzu service claimable list --class postgres --namespace app-ns-1

Flags:
 --class string name of the class to list claimable resources for
 -h, --help help for list
 -n, --namespace name kubernetes namespace (defaulted from kube config)

Global Flags:
 --context string name of the kubeconfig context to use (default is current-
context defined by kubeconfig)
 --kubeconfig string kubeconfig file (default is /home/eking/.kube/config)
 --no-color turn off color output in terminals
```

## Services Toolkit terminology and user roles

This topic provides descriptions of the terms and user roles used in the Services Toolkit documentation.

### Terminology

The following terms are used in the Services Toolkit documentation.



## Service

Service is broad, high-level term that describes something used in either the development of, or running of application workloads. Often, but not exclusively, synonymous with the concept of a backing service as defined by the Twelve Factor App:

*“... any service the app consumes over the network as part of its normal operation”*

For example:

- A PostgreSQL service (implemented as a Kubernetes Operator provided by Tanzu Data Services)
- A PostgreSQL service (implemented as a process running on an Application Developer’s laptop)
- Object storage (implemented as SaaS running on AWS)
- AppSSO

## Service resource

A service resource is a Kubernetes resource that provides some of the functions related to a Service.

For example:

- A Kubernetes resource with API Kind `PostgreSQL`
- A Kubernetes resource with API Kind `FirewallRule`
- A Kubernetes resource with API Kind `RabbitmqUser`
- A Kubernetes resource with API Kind `ClientRegistration` that provides access to an App SSO service
- A Kubernetes resource with API Kind `Secret` containing credentials and connectivity information for a Service that may or may not be running on the cluster itself.

## Provisioned service

A provisioned service is any service resource that defines a `.status.binding.name` which points to a secret in the same namespace that contains credentials and connectivity information for the resource.

This term is defined in the Service Binding Specification for Kubernetes. For the full definition, see the [Service Binding Specification](#) in GitHub.

## Service binding

A service binding is a mechanism in which service instance credentials and other related connectivity information are automatically communicated to application workloads.

For example:

- The Service binding concept implemented through the `ServiceBinding` service resource provided by [servicebinding](#) in GitHub.

## Service instance

A service instance is an abstraction over one or a group of interrelated service resources that together provide the functions for a particular service.

One of the service resources that make up an instance must either adhere to the definition of provisioned service, or be a secret conforming to the service binding specification for Kubernetes.

This guarantees that you can claim a service and subsequently bind service instances to application workloads.

You make service instances discoverable through service instance classes.

For example:

- The `RabbitmqCluster` service resource provided by the RabbitMQ Cluster Kubernetes operator. This service resource adheres to provisioned service. Therefore, you can consider any `RabbitmqCluster` resource on a Kubernetes cluster to be a service instance.
- A logical grouping of the following service resources form a single AWS RDS service instance:
  - An AWS RDS `DBInstance`
  - An AWS RDS `DBSubnetGroup`
  - A Carvel `SecretTemplate` configured to produce a secret conforming to the Service Binding Specification for Kubernetes
  - A `Role`, `RoleBinding`, and `ServiceAccount`
- A Kubernetes `Secret` conforming to the Service Binding Specification for Kubernetes containing credentials for a Service running external to the cluster.

## Service instance class

A service instance class is more commonly called a “class”. They provide a way to describe classes, that is, categories, of service instances.

A service instance class enables service instances belonging to the class to be discovered. They come in one of two varieties: pool-based or provisioner-based.

- Claims for pool-based classes are fulfilled by selecting a service instance from a pool.
- Claims for provisioner-based classes are fulfilled by provisioning new service instances.

Different classes might map to different services or to different configurations of the same service.

For example:

- A `ClusterInstanceClass` named “rabbitmq-dev” pointing to all `RabbitmqCluster` service resources configured with `.spec.replicas=1` identified by label `class: rmq-dev`.
- A `ClusterInstanceClass` named “rabbitmq-prod” pointing to all `RabbitmqCluster` service resources configured with `.spec.replicas=3` identified by label `class: rmq-prod`.
- A `ClusterInstanceClass` named “aws-rds-postgresql” pointing to secrets that conform with the Binding Specification and identified by label `class: aws-rds`.
- A `ClusterInstanceClass` named “mysql-on-demand” which provisions MySQL service instances.

## Claim

A claim is a mechanism in which requests for service instances can be declared and fulfilled without requiring detailed knowledge of the service instances themselves.

Claims come in one of two varieties - resource claim and class claim:

- Resource claims refer to a specific service instance.
- Class claims refer to a class from which a service instance is then either selected (pool-based) or provisioned (provisioner-based).

For example:

- A resource claim pointing to a `RabbitmqCluster` service instance named `rmq-1` in the namespace `service-instances`.
- A class claim pointing to a class named `on-demand-rabbitmq`.

## Claimable service instance

A claimable service instance is any service instance that you are permitted to claim using a resource claim from a namespace, taking into consideration:

- Location (namespace) of the service instance in relation to the location of the resource claim.
- Any matching resource claim policies.
- Exclusivity of resource claims, that is, you can only claim an instance once.

For example:

- A `RabbitmqCluster` service resource located in the same namespace as a resource claim and that has not already been claimed by another resource claim is a claimable service instance.
- A `RabbitmqCluster` service resource located in a different namespace to a resource claim, for which a matching resource claim policy exists, and has not already been claimed by another resource claim is a claimable service instance.
- A `RabbitmqCluster` service resource located in the same namespace as a resource claim that has already been claimed is not a claimable service instance due to the exclusive nature of Resource Claims.

## Dynamic provisioning

Dynamic provisioning is a capability of Services Toolkit in which class claims that refer to provisioner-based classes are fulfilled automatically through the provisioning of new service instances.

## Service resource life cycle API

A service resource life cycle API is any Kubernetes API that you can use to manage the life cycle—create, read, update and delete (CRUD)—of a service resource.

For example:

- `rabbitmqclusters.rabbitmq.com/v1beta1`

## Service cluster

A service cluster is applicable within the context of Service API Projection and Service Resource Replication. It is a Kubernetes cluster that has Service Resource Lifecycle APIs installed and a corresponding controller managing their life cycle.

## Workload cluster

A workload cluster is applicable within the context of Service API Projection and Service Resource Replication. It is a Kubernetes cluster that has developer-created applications running on it.

## User roles

Services Toolkit caters to the following user roles.

These user roles are not user personas. It is possible, and even expected, that one person can be associated with many user roles at any given time. The user roles align to Tanzu Application Platform's user roles. Services Toolkit is primarily responsible for defining the service operator role. For more information about the user roles, see [Role descriptions](#).

The user roles listed in this section consist of a short description and the tasks required. For detailed information about the corresponding Role-Based Access Control (RBAC) associated with each role, see [Detailed role permissions breakdown](#).

## Application developer (AD)

The application developer role encompasses both app-editor and app-viewer roles as defined by Tanzu Application Platform. For more information about the app-editor and app-viewer roles, see [Role descriptions](#).

Application developers do the following:

- Bind and unbind application workloads to and from resource claims.
- Get, list, and watch ResourceClaims.
- get, list, and watch ClusterInstanceClasses associated with ResourceClaims.

## Application operator (AO)

Encompasses the app-operator role as defined by Tanzu Application Platform. For more information about the app-operator role, see [Role descriptions](#).

Application operators do the following:

- Discover and learn about service instance classes available on a cluster.
- Discover claimable service instances associated with service instance classes.
- Life cycle management (CRUD) of resource claims.

## Service operator (SO)

Service operators do the following:

- Life cycle management (CRUD) of service instances.
- Life cycle management (CRUD) of service instance classes.
- Life cycle management (CRUD) of resource claim policies.
- Identify pending resource claims and, if appropriate, help to fulfil such claims through a combination of the previous tasks.
- Setup and configure dynamic provisioning.

## Example Compositions

This topic gives you example [Composition](#) resources that you can use to help when integrating cloud services into Tanzu Application Platform (commonly known as TAP).

### AWS RDS example [Composition](#)

The following [Composition](#) ensures that all RDS PostgreSQL instances are placed in the `us-east-1` region and use the default VPC for the respective AWS account.

```
apiVersion: apiextensions.crossplane.io/v1
kind: Composition
```

```

metadata:
 labels:
 provider: "aws"
 vpc: "default"
 name: xpostgresinstances.bindable.aws.database.example.org
spec:
 compositeTypeRef:
 apiVersion: bindable.database.example.org/v1alpha1
 kind: XPostgreSQLInstance
 publishConnectionDetailsWithStoreConfigRef:
 name: default
 resources:
 - base:
 apiVersion: database.aws.crossplane.io/v1beta1
 kind: RDSInstance
 spec:
 forProvider:
 dbInstanceClass: db.t2.micro
 engine: postgres
 dbName: postgres
 engineVersion: "12"
 masterUsername: masteruser
 publiclyAccessible: true
 region: us-east-1
 skipFinalSnapshotBeforeDeletion: true
 writeConnectionSecretToRef:
 namespace: crossplane-system
 connectionDetails:
 - name: type
 value: postgresql
 - name: provider
 value: aws
 - name: database
 value: postgres
 - fromConnectionSecretKey: username
 - fromConnectionSecretKey: password
 - name: host
 fromConnectionSecretKey: endpoint
 - fromConnectionSecretKey: port
 name: rdsinstance
 patches:
 - fromFieldPath: metadata.uid
 toFieldPath: spec.writeConnectionSecretToRef.name
 transforms:
 - string:
 fmt: '%s-postgresql'
 type: Format
 type: string
 type: FromCompositeFieldPath
 - fromFieldPath: spec.parameters.storageGB
 toFieldPath: spec.forProvider.allocatedStorage
 type: FromCompositeFieldPath
EOF

```

## Azure Flexible Server example [Composition](#)

The following [Composition](#) makes sure that all [FlexibleServers](#) are placed in the [westeurope](#) region and under the resource group [tap-psql-demo](#).



### Note

Setting the [FlexibleServerFirewallRule](#) to start at [0.0.0.0](#) and end at [255.255.255.255](#) allows access to the PostgreSQL Server from any IP address

and is not recommended in a production environment.

```

apiVersion: apiextensions.crossplane.io/v1
kind: Composition
metadata:
 labels:
 provider: azure
 name: xpostgresinstances.bindable.gcp.database.example.org
spec:
 compositeTypeRef:
 apiVersion: bindable.database.example.org/v1alpha1
 kind: XPostgreSQLInstance
 publishConnectionDetailsWithStoreConfigRef:
 name: default
 resources:
 - name: dbinstance
 base:
 apiVersion: dbforpostgresql.azure.jet.crossplane.io/v1alpha2
 kind: FlexibleServer
 spec:
 forProvider:
 administratorLogin: myPgAdmin
 administratorPasswordSecretRef:
 name: ""
 namespace: crossplane-system
 key: password
 location: westeurope
 skuName: GP_Standard_D2s_v3
 version: "12" #! 11,12 and 13 are supported
 resourceGroupName: tap-psql-demo
 writeConnectionSecretToRef:
 namespace: crossplane-system
 connectionDetails:
 - name: type
 value: postgresql
 - name: provider
 value: azure
 - name: database
 value: postgres
 - name: username
 fromFieldPath: spec.forProvider.administratorLogin
 - name: password
 fromConnectionSecretKey: "attribute.administrator_password"
 - name: host
 fromFieldPath: status.atProvider.fqdn
 - name: port
 type: FromValue
 value: "5432"
 patches:
 - fromFieldPath: metadata.uid
 toFieldPath: spec.writeConnectionSecretToRef.name
 transforms:
 - string:
 fmt: '%s-postgresql'
 type: Format
 type: string
 type: FromCompositeFieldPath
 - type: FromCompositeFieldPath
 fromFieldPath: metadata.name
 toFieldPath: spec.forProvider.administratorPasswordSecretRef.name
 - fromFieldPath: spec.parameters.storageGB
 toFieldPath: spec.forProvider.storageMb
 type: FromCompositeFieldPath
 transforms:

```

```

- type: math
 math:
 multiply: 1024
- name: dbfwrule
 base:
 apiVersion: dbforpostgresql.azure.jet.crossplane.io/v1alpha2
 kind: FlexibleServerFirewallRule
 spec:
 forProvider:
 serverIdSelector:
 matchControllerRef: true
 #! not recommended for production deployments!
 startIpAddress: 0.0.0.0
 endIpAddress: 255.255.255.255
- name: password
 base:
 apiVersion: kubernetes.crossplane.io/v1alpha1
 kind: Object
 spec:
 forProvider:
 manifest:
 apiVersion: secretgen.k14s.io/v1alpha1
 kind: Password
 metadata:
 name: ""
 namespace: crossplane-system
 spec:
 length: 64
 secretTemplate:
 type: Opaque
 stringData:
 password: $(value)
 patches:
 - type: FromCompositeFieldPath
 fromFieldPath: metadata.name
 toFieldPath: spec.forProvider.manifest.metadata.name
EOF

```

## GCP Cloud SQL example [Composition](#)

The following [Composition](#) ensures that all CloudSQL PostgreSQL instances are placed in the `us-central1` region.



### Note

The authorized network CIDR `0.0.0.0/0` allows access to the Cloud SQL from any IP address and is not recommended in a production environment.

```

apiVersion: apiextensions.crossplane.io/v1
kind: Composition
metadata:
 labels:
 provider: gcp
 name: xpostgresqlinstances.bindable.gcp.database.example.org
spec:
 compositeTypeRef:
 apiVersion: bindable.database.example.org/v1alpha1
 kind: XPostgreSQLInstance
 publishConnectionDetailsWithStoreConfigRef:
 name: default
 resources:
 - base:

```

```

apiVersion: database.gcp.crossplane.io/v1beta1
kind: CloudSQLInstance
spec:
 forProvider:
 databaseVersion: POSTGRES_14
 region: us-central1
 settings:
 dataDiskType: PD_SSD
 ipConfiguration:
 authorizedNetworks:
 - value: 0.0.0.0/0 # not recommended for production deployments!
 ipv4Enabled: true
 tier: db-custom-1-3840
 writeConnectionSecretToRef:
 namespace: crossplane-system
 connectionDetails:
 - name: type
 value: postgresql
 - name: provider
 value: gcp
 - name: database
 value: postgres
 - fromConnectionSecretKey: username
 - fromConnectionSecretKey: password
 - name: host
 fromConnectionSecretKey: endpoint
 - name: port
 type: FromValue
 value: "5432"
 name: cloudsqlinstance
 patches:
 - fromFieldPath: metadata.uid
 toFieldPath: spec.writeConnectionSecretToRef.name
 transforms:
 - string:
 fmt: '%s-postgresql'
 type: Format
 type: string
 type: FromCompositeFieldPath
 - fromFieldPath: spec.parameters.storageGB
 toFieldPath: spec.forProvider.settings.dataDiskSizeGb
 type: FromCompositeFieldPath
EOF

```

## Services Toolkit limitations

This topic tells you about the limitations related to working with services on Tanzu Application Platform (commonly known as TAP).

### Cannot claim and bind to the same service instance from across multiple namespaces

Two or more workloads located in two or more distinct namespaces cannot claim and bind to the same service instance. This is due to the mutually exclusive nature of claims. After a claim has claimed a service instance, no other claim can then claim that same service instance.

This limitation does not exist for two or more workloads located in the same namespace. In this case, the workloads can all still all bind to one claim. This is not possible across the namespace divide.

## Overview of Source Controller



Tanzu Source Controller provides a standard interface for artifact acquisition and extends the function of [Flux CD Source Controller](#).

Tanzu Source Controller supports the following two resource types:

- `ImageRepository` [Deprecated]
- `MavenArtifact`

An `ImageRepository` resource can resolve the source from the contents of an image in an image registry. This enables app developers to create and update workloads from local source code or a code repository.

A `MavenArtifact` resource can resolve a binary artifact from a Maven repository. This functionality enables the supply chain to support artifacts produced externally.



#### Note

Fetching `RELEASE` version from GitHub packages is not currently supported. The `metadata.xml` in GitHub packages does not have the `release` tag that contains the released version number. For more information, see [Maven-metadata.xml is corrupted on upload to registry](#) on GitHub.

## Overview of Source Controller

Tanzu Source Controller provides a standard interface for artifact acquisition and extends the function of [Flux CD Source Controller](#).

Tanzu Source Controller supports the following two resource types:

- `ImageRepository` [Deprecated]
- `MavenArtifact`

An `ImageRepository` resource can resolve the source from the contents of an image in an image registry. This enables app developers to create and update workloads from local source code or a code repository.

A `MavenArtifact` resource can resolve a binary artifact from a Maven repository. This functionality enables the supply chain to support artifacts produced externally.



#### Note

Fetching `RELEASE` version from GitHub packages is not currently supported. The `metadata.xml` in GitHub packages does not have the `release` tag that contains the released version number. For more information, see [Maven-metadata.xml is corrupted on upload to registry](#) on GitHub.

## Install Source Controller

This topic tells you how to install Source Controller from the Tanzu Application Platform (commonly known as TAP) package repository.



#### Note

Follow the steps in this topic if you do not want to use a profile to install Source Controller. For more information about profiles, see [Components and installation](#)

profiles.

## Prerequisites

Before installing Source Controller:

- Complete all prerequisites to install Tanzu Application Platform. For more information, see [Prerequisites](#).
- Install cert-manager on the cluster. For more information, see [Install cert-manager](#).

## Install

To install Source Controller:

1. List version information for the package by running:

```
tanzu package available list controller.source.apps.tanzu.vmware.com --namespace tap-install
```

For example:

```
$ tanzu package available list controller.source.apps.tanzu.vmware.com --namespace tap-install
- Retrieving package versions for controller.source.apps.tanzu.vmware.com...
 NAME VERSION RELEASED-AT
 controller.source.apps.tanzu.vmware.com 0.3.1 2022-01-23 19:00:00 -0500 -05
 controller.source.apps.tanzu.vmware.com 0.3.2 2022-02-21 19:00:00 -0500 -05
 controller.source.apps.tanzu.vmware.com 0.3.3 2022-03-03 19:00:00 -0500 -05
 controller.source.apps.tanzu.vmware.com 0.4.1 2022-06-09 19:00:00 -0500 -05
```

2. (Optional) Gather the values schema:

```
tanzu package available get controller.source.apps.tanzu.vmware.com/VERSION-NUMBER --values-schema --namespace tap-install
```

Where `VERSION-NUMBER` is the version of the package listed in step 1 above.

For example:

```
tanzu package available get controller.source.apps.tanzu.vmware.com/0.4.1 --values-schema --namespace tap-install

Retrieving package details for controller.source.apps.tanzu.vmware.com/0.4.1...
KEY DEFAULT TYPE DESCRIPTION
aws_iam_role_arn string Optional: The AWS IAM Role ARN to attach to the Source Controller service account
ca_cert_data string Optional: PEM Encoded certificate data for image registries with private CA.
```

3. (Optional) Create a file named `source-controller-values.yaml` to override the default installation settings. You can configure the following fields:
  - `ca_cert_data`: Enables Source Controller to connect to image registries that use self-signed or private certificate authorities. If a certificate error `x509: certificate signed by unknown authority` occurs, use this option to trust additional certificate authorities.

To provide a custom certificate, add the PEM-encoded CA certificate data to `source-controller-values.yaml`. For example:

```
ca_cert_data: |
 -----BEGIN CERTIFICATE-----
 MIICpTCCAYUCBgkqhkiG9w0BBQ0wMzAbBgkqhkiG9w0BBQwwDgQIYg9x6gkCAggA
 ...
 9T1A7A4FFpQqbhAuAVH6KQ8WMZIrVxJSQ03c91KVkI62wQ==
 -----END CERTIFICATE-----
```

- o `aws_iam_role_arn`: Annotates the Source Controller service with an AWS Identity and Access Management (IAM) role. This allows Source Controller to pull images from Amazon Elastic Container Registry (ECR).

To add the AWS IAM role Amazon Resource Name (ARN) to the Source Controller service, add the ARN to `source-controller-values.yaml`. For example:

```
aws_iam_role_arn: "eks.amazonaws.com/role-arn: arn:aws:iam::112233445566:
role/source-controller-manager"
```

#### 4. Install the package by running:

```
tanzu package install source-controller \
 --package controller.source.apps.tanzu.vmware.com \
 --version VERSION-NUMBER \
 --namespace tap-install \
 --values-file VALUES-FILE
```

Where:

- o `VERSION-NUMBER` is the version of the package listed in step 1 above.
- o `VALUES-FILE` is the path to the file created in step 3.

For example:

```
$ tanzu package install source-controller
 --package controller.source.apps.tanzu.vmware.com
 --version 0.4.1
 --namespace tap-install
 --values-file source-controller-values.yaml

\ Installing package 'controller.source.apps.tanzu.vmware.com'
| Getting package metadata for 'controller.source.apps.tanzu.vmware.com'
| Creating service account 'source-controller-default-sa'
| Creating cluster admin role 'source-controller-default-cluster-role'
| Creating cluster role binding 'source-controller-default-cluster-rolebinding'
| Creating secret 'source-controller-default-values'
| Creating package resource
- Waiting for 'PackageInstall' reconciliation for 'source-controller'
- 'PackageInstall' resource install status: Reconciling

Added installed package 'source-controller'
```

#### 5. Verify the package installation by running:

```
tanzu package installed get source-controller -n tap-install
```

For example:

```
tanzu package installed get source-controller -n tap-install
- Retrieving installation details for source-controller...
NAME: source-controller
```

```

PACKAGE-NAME: controller.source.apps.tanzu.vmware.com
PACKAGE-VERSION: 0.4.1
STATUS: Reconcile succeeded
CONDITIONS: [{ReconcileSucceeded True }]
USEFUL-ERROR-MESSAGE:

```

Verify that `STATUS` is `Reconcile succeeded`:

```
kubectl get pods -n source-system
```

For example:

```

$ kubectl get pods -n source-system
NAME READY STATUS RESTARTS AGE
source-controller-manager-f68dc7bb6-4l1rn6 1/1 Running 0 100s

```

Verify that `STATUS` is `Running`.

## Troubleshoot Source Controller

This topic gives you guidance about how to troubleshoot issues with Source Controller.

### Collecting Logs from Source Controller Manager

To retrieve Pod logs from the `controller-manager`, run the following command in the `source-system` namespace:

```
kubectl logs -n source-system -l control-plane=controller-manager
```

For example:

```

kubectl logs -n source-system -l control-plane=controller-manager
2021-11-18T17:59:43.152Z INFO controller.imagerepository Starting Event
Source {"reconciler group": "source.apps.tanzu.vmware.com", "reconciler kind": "Image
Repository", "source": "kind source: /, Kind="}
2021-11-18T17:59:43.152Z INFO controller.metarepository Starting Event
Source {"reconciler group": "source.apps.tanzu.vmware.com", "reconciler kind": "MetaR
epository", "source": "kind source: /, Kind="}
2021-11-18T17:59:43.152Z INFO controller.metarepository Starting Event
Source {"reconciler group": "source.apps.tanzu.vmware.com", "reconciler kind": "MetaR
epository", "source": "kind source: /, Kind="}
2021-11-18T17:59:43.152Z INFO controller.metarepository Starting Event
Source {"reconciler group": "source.apps.tanzu.vmware.com", "reconciler kind": "MetaR
epository", "source": "kind source: /, Kind="}
2021-11-18T17:59:43.152Z INFO controller.metarepository Starting Contr
oller {"reconciler group": "source.apps.tanzu.vmware.com", "reconciler kind": "MetaR
epository"}
2021-11-18T17:59:43.152Z INFO controller.imagerepository Starting Event
Source {"reconciler group": "source.apps.tanzu.vmware.com", "reconciler kind": "Image
Repository", "source": "kind source: /, Kind="}
2021-11-18T17:59:43.152Z INFO controller.imagerepository Starting Event
Source {"reconciler group": "source.apps.tanzu.vmware.com", "reconciler kind": "Image
Repository", "source": "kind source: /, Kind="}
2021-11-18T17:59:43.152Z INFO controller.imagerepository Starting Contr
oller {"reconciler group": "source.apps.tanzu.vmware.com", "reconciler kind": "Image
Repository"}
2021-11-18T17:59:43.389Z INFO controller.metarepository Starting worke
rs {"reconciler group": "source.apps.tanzu.vmware.com", "reconciler kind": "MetaR
epository", "worker count": 1}
2021-11-18T17:59:43.391Z INFO controller.imagerepository Starting worke

```

```
rs {"reconciler group": "source.apps.tanzu.vmware.com", "reconciler kind": "Image
Repository", "worker count": 1}
```

## Source Controller reference

This topic provides reference documentation for Source Controller.

### ImageRepository [Deprecated]

```

apiVersion: source.apps.tanzu.vmware.com/v1alpha1
kind: ImageRepository
spec:
 image: registry.example/image/repository:tag
 # optional fields
 interval: 5m
 imagePullSecrets: []
 serviceAccountName: default
```

`ImageRepository` resolves source code defined in an Open Container Initiative (OCI) image repository, exposing the resulting source artifact at a URL defined by `.status.artifact.url`.

The interval determines how often to check tagged images for changes. Setting this value too high will result in delays in discovering new sources, while setting it too low may trigger a registry's rate limits.

Repository credentials can be defined as image pull secrets. You can reference them either directly from the resources at `.spec.imagePullSecrets` or attach them to a service account referenced at `.spec.serviceAccountName`. The default service account name "default" is used if not otherwise specified. The default credential helpers for the registry are also used, for example, pulling from Google Container Registry (GCR) on a Google Kubernetes Engine (GKE) cluster.

### MavenArtifact

```

apiVersion: source.apps.tanzu.vmware.com/v1alpha1
kind: MavenArtifact
metadata:
 name: mavenartifact-sample
spec:
 artifact:
 groupId: org.springframework.boot
 artifactId: spring-boot
 version: "2.7.0"
 repository:
 url: https://repo1.maven.org/maven2
 interval: 5m0s
 timeout: 1m0s
```

`MavenArtifact` resolves artifact from a Maven repository, exposing the resulting artifact at a URL defined by `.status.artifact.url`.

The `interval` determines how often to check artifact for changes. Setting this value too high results in delays in discovering new sources, while setting it too low may trigger a repository's rate limits.

Repository credentials may be defined as secrets referenced from the resources at `.spec.repository.secretRef`. Secrets referenced by `spec.repository.secretRef` is parsed as follows:

```

apiVersion: v1
kind: Secret
metadata:
 name: auth-secret
type: Opaque
data:
 username: <BASE64>
 password: <BASE64>
 caFile: <BASE64> // PEM Encoded certificate data for Custom CA
 certFile: <BASE64> // PEM-encoded client certificate
 keyFile: <BASE64> // Private Key

```

Maven supports a broad set of `version` syntax. Source Controller supports a strict subset of Maven's version syntax in order to ensure compatibility and avoid user confusion. The subset of supported syntax may grow over time, but will never expand past the syntax defined directly by Maven. This behavior means that we can use `mvn` as a reference implementation for artifact resolution.

Version support implemented in the following order:

1. Pinned version - an exact match of a version in2 `maven-metadata.xml` (`versioning/versions/version`).
2. `RELEASE` - metaversion defined in `maven-metadata.xml` (`versioning/release`).
3. `*-SNAPSHOT` - the newest artifact for a snapshot version.
4. `LATEST` - metaversion defined in `maven-metadata.xml` (`versioning/latest`).
5. Version ranges - <https://maven.apache.org/enforcer/enforcer-rules/versionRanges.html>. Support is planned for a future release.



#### Note

Pinned versions should be immutable, all other versions are dynamic and can change at any time. The `.spec.interval` defines how frequently to check for updated artifacts.

## Overview of Spring Boot conventions

This topic tells you about the Spring Boot convention server.

The Spring Boot convention server is a bundle of small conventions applied to any Spring Boot application that is submitted to the supply chain in which the convention controller is configured.

Run the `docker inspect` command to make the Spring Boot convention server look inside the image. Example command:

```
$ docker inspect springio/petclinic
```

Example output:

```
[
 {
 "Id": "sha256:...",
 "RepoTags": [
 "springio/petclinic:latest"
],
 "RepoDigests": [
 "springio/petclinic@sha256:..."
]
 }
]
```

```

],
 "Parent": "",
 "Container": "",
 ...
 "ContainerConfig": {
 "Hostname": "",
 "Domainname": "",
 "User": "",
 ...
 "Labels": null
 },
 "DockerVersion": "",
 "Author": "",
 "Config": {
...
]

```

The convention server searches inside the image for `Config` -> `Labels` -> `io.buildpacks.build.metadata` to find the `bom` file. It looks inside the `bom` file for metadata to evaluate whether the convention is to be applied.

For the list of conventions, see [Conventions](#).

## Overview of Spring Boot conventions

This topic tells you about the Spring Boot convention server.

The Spring Boot convention server is a bundle of small conventions applied to any Spring Boot application that is submitted to the supply chain in which the convention controller is configured.

Run the `docker inspect` command to make the Spring Boot convention server look inside the image. Example command:

```
$ docker inspect springio/petclinic
```

Example output:

```

[
 {
 "Id": "sha256:...",
 "RepoTags": [
 "springio/petclinic:latest"
],
 "RepoDigests": [
 "springio/petclinic@sha256:..."
],
 "Parent": "",
 "Container": "",
 ...
 "ContainerConfig": {
 "Hostname": "",
 "Domainname": "",
 "User": "",
 ...
 "Labels": null
 },
 "DockerVersion": "",
 "Author": "",
 "Config": {
...
]

```

The convention server searches inside the image for `Config -> Labels -> io.buildpacks.build.metadata` to find the `bom` file. It looks inside the `bom` file for metadata to evaluate whether the convention is to be applied.

For the list of conventions, see [Conventions](#).

## Install Spring Boot conventions

This topic tells you how to install Spring Boot conventions from the Tanzu Application Platform package repository.



### Note

Follow the steps in this topic if you do not want to use a profile to install Spring Boot conventions. For more information about profiles, see [Components and installation profiles](#).

## Prerequisites

Before installing Spring Boot conventions:

- Complete all prerequisites to install Tanzu Application Platform. For more information, see [Prerequisites](#).
- Install [Supply Chain Choreographer](#).

## Install Spring Boot conventions

To install Spring Boot conventions:

1. Get the exact name and version information for the Spring Boot conventions package to install by running:

```
tanzu package available list spring-boot-conventions.tanzu.vmware.com --namespace tap-install
```

For example:

```
$ tanzu package available list spring-boot-conventions.tanzu.vmware.com --namespace tap-install
/ Retrieving package versions for spring-boot-conventions.tanzu.vmware.com...
NAME VERSION RELEASED-AT
...
spring-boot-conventions.tanzu.vmware.com 1.4.0 2022-12-08T00:00:0Z
...
```

2. (Optional) Change the default installation settings by running:

```
tanzu package available get spring-boot-conventions.tanzu.vmware.com/VERSION-NUMBER \
--values-schema --namespace tap-install
```

Where `VERSION-NUMBER` is the version of the package listed. For example: `1.6.13`.

For example:



```
$ tanzu package available get spring-boot-conventions.tanzu.vmware.com/1.4.0 --
values-schema --namespace tap-install
```

KEY	DEFAULT	TYPE	DESCRIPTION
autoConfigureActuators	false	boolean	Enable or disable the automatic configuration of actuators on the TAP platform level
kubernetes_distribution		string	Kubernetes distribution that this package is being installed on. Accepted values: ['','','openshift']
kubernetes_version		string	Optional: The Kubernetes Version. Valid values are '1.24.*', or ''

3. Install the package by running:

```
tanzu package install spring-boot-conventions \
--package spring-boot-conventions.tanzu.vmware.com \
--version VERSION-NUMBER \
--namespace tap-install
```

Where `VERSION-NUMBER` is the version of the package you listed earlier.

4. Verify you installed the package by running:

```
tanzu package installed get spring-boot-conventions --namespace tap-install
```

For example:

```
tanzu package installed get spring-boot-conventions -n tap-install
| Retrieving installation details for spring-boot-conventions...
NAME: spring-boot-conventions
PACKAGE-NAME: spring-boot-conventions.tanzu.vmware.com
PACKAGE-VERSION: 1.6.13
STATUS: Reconcile succeeded
CONDITIONS: [{"ReconcileSucceeded True "}]
USEFUL-ERROR-MESSAGE:
```

Verify that `STATUS` is `Reconcile succeeded`

## Configure and access Spring Boot actuators in Tanzu Application Platform

This topic tells you how the Spring Boot conventions in Tanzu Application Platform configure Spring Boot actuators automatically. With this feature, users can activate or deactivate the automatic configuration of actuators on Tanzu Application Platform and on individual workloads.

### Workload-level configuration

Developers can add a label to their workloads to activate or deactivate the automatic configuration of actuators. By default, all existing and future accelerator projects are configured to activate automatic configuration on the workload level.

To activate or deactivate the automatic configuration of actuators at the workload level, follow these steps:

1. To activate automatic configuration of actuators, set the following label to `true` in your workload YAML:

```
apps.tanzu.vmware.com/auto-configure-actuators: "true"
```

If the preceding label is set to `true`, the Spring Boot actuator convention sets the following actuator configuration:

- The `JAVA_TOOL_OPTIONS` property is set as `-Dmanagement.server.port="8081"`.
- The `JAVA_TOOL_OPTIONS` property is set as `-Dmanagement.endpoints.web.base-path="/actuator"`.
- Annotation on the PodIntent is set as `boot.spring.io/actuator: http://:8081/actuator`.

In addition to these settings, Application Live View is activated with the following actuator configuration:

- Label on the PodIntent is set as `tanzu.app.live.view.application.actuator: actuator`.
  - Label on the PodIntent is set as `tanzu.app.live.view.application.actuator.port: 8081`.
2. To deactivate automatic configuration of actuators, set the following label to `false` in your workload YAML:

```
apps.tanzu.vmware.com/auto-configure-actuators: "false"
```

If the preceding label is set to `false`, the Spring Boot actuator convention does not set any `JAVA_TOOL_OPTIONS` and does not set the annotation `boot.spring.io/actuator`.

Application Live View is activated and configured with default values for Spring Boot web applications, assuming that some actuators are activated on the default port. On activating Application Live View, the following actuator settings are set:

- The `JAVA_TOOL_OPTIONS` property is set as `-Dserver.port="8080"`.
- Label on the PodIntent is set as `tanzu.app.live.view.application.actuator: actuator`.
- Label on the PodIntent is set as `tanzu.app.live.view.application.actuator.port: 8080`.

The Application Live View GUI renders the pages with accessible information based on whether the actuator endpoints are accessible for an application.

By default, as an additional security measure, Spring Boot conventions does not expose all the actuator data over HTTP by exposing all the actuator endpoints. In addition, the information exposed by the health endpoint is not set to `always` by default.

If the automatic configuration of actuators is set to `true` either at the workload level or platform level, the Spring Boot convention then sets the runtime environment properties `management.endpoints.web.exposure.include="*" and management.endpoint.health.show-details=true on to the PodSpec to expose all the actuator endpoints and detailed health information. You do not need to add these properties manually in application.properties or application.yml.`

## Platform-level configuration

In contrast to activating or deactivating the automatic configuration of actuators on the level of individual workloads, you can set a global setting for the platform instead. This setting is taken into account ONLY when there is no specific `auto-configure-actuators` setting on the individual workload.

To activate or deactivate the automatic configuration of actuators at a global level, follow these steps:

1. When you install Spring Boot conventions, you can provide an entry in the `values.yaml` file to activate automatic configuration. For example:

```
springboot_conventions:
 autoConfigureActuators: true
```

- To deactivate the automatic configuration, you can provide the following entry:

```
springboot_conventions:
 autoConfigureActuators: false
```



### Note

The default values for both platform level and workload level configuration is false.

To run Application Live View with Spring Boot apps, the Spring Boot convention recognizes PodIntents and adds the following metadata labels:

- `tanzu.app.live.view: "true"`: Activates the connector to observe application pod
- `tanzu.app.live.view.application.name: APPLICATION-NAME`: Identifies the app name to be used internally by Application Live View
- `tanzu.app.live.view.application.actuator.port: ACTUATOR-PORT`: Identifies the port on the pod at which the actuators are available for Application Live View
- `tanzu.app.live.view.application.flavours: spring-boot`: Exposes the framework flavor of the app

To run Application Live View with Spring Cloud Gateway apps, Spring Boot conventions recognizes PodIntents and adds the following metadata labels:

- `tanzu.app.live.view: "true"`: Activates the connector to observe application pod
- `tanzu.app.live.view.application.name: APPLICATION-NAME`: Identifies the app name to be used internally by Application Live View
- `tanzu.app.live.view.application.actuator.port: ACTUATOR-PORT`: Identifies the port on the pod at which the actuators are available for Application Live View
- `tanzu.app.live.view.application.flavours: spring-boot, spring-cloud-gateway`: Exposes the framework flavors of the app

## Enable Application Live View for Spring Boot applications

To run Application Live View for Spring Boot apps, Spring Boot conventions recognizes PodIntents and automatically adds the following metadata labels:

- `tanzu.app.live.view: "true"`: Enables the connector to observe application pod
- `tanzu.app.live.view.application.name: APPLICATION-NAME`: Identifies the app name to be used internally by Application Live View
- `tanzu.app.live.view.application.actuator.port: ACTUATOR-PORT`: Identifies the port on the pod at which the actuators are available for Application Live View
- `tanzu.app.live.view.application.flavours: spring-boot`: Exposes the framework flavor of the app

To run Application Live View for Spring Cloud Gateway apps, Spring Boot conventions recognizes PodIntents and adds the following metadata labels:

- `tanzu.app.live.view: "true"`: Enables the connector to observe application pod

- `tanzu.app.live.view.application.name`: `APPLICATION-NAME`: Identifies the app name to be used internally by Application Live View
- `tanzu.app.live.view.application.actuator.port`: `ACTUATOR-PORT`: Identifies the port on the pod at which the actuators are available for Application Live View
- `tanzu.app.live.view.application.flavours`: `spring-boot, spring-cloud-gateway`: Exposes the framework flavors of the app

These metadata labels allow Application Live View to identify pods that are enabled for Application Live View. The metadata labels also tell the Application Live View connector what kind of app it is and on which port the actuators are accessible for Application Live View. For more information, see [Configuring and accessing Spring Boot actuators in Tanzu Application Platform](#).

## Verify the applied labels and annotations

To verify the applied labels and annotations, run:

```
kubectl get podintents.conventions.carto.run WORKLOAD-NAME -o yaml
```

Where `WORKLOAD-NAME` is the name of the deployed workload. For example: `tanzu-java-web-app`.

Expected output of Spring Boot workload:

```
apiVersion: conventions.carto.run/v1alpha1
kind: PodIntent
metadata:
 creationTimestamp: "2022-11-14T10:07:55Z"
 generation: 1
 labels:
 app.kubernetes.io/component: intent
 app.kubernetes.io/part-of: tanzu-java-web-app
 apps.tanzu.vmware.com/auto-configure-actuators: "true"
 apps.tanzu.vmware.com/workload-type: web
 carto.run/cluster-template-name: convention-template
 carto.run/resource-name: config-provider
 carto.run/supply-chain-name: source-to-url
 carto.run/template-kind: ClusterConfigTemplate
 carto.run/workload-name: tanzu-java-web-app
 carto.run/workload-namespace: default
 name: tanzu-java-web-app
 namespace: default
 ownerReferences:
 - apiVersion: carto.run/v1alpha1
 blockOwnerDeletion: true
 controller: true
 kind: Workload
 name: tanzu-java-web-app
 uid: dfd3c0c2-9d1f-4231-9390-3e16f23bb62d
 resourceVersion: "444497"
 uid: 224de2aa-307a-48e3-a826-2c474c435bb2
spec:
 serviceAccountName: default
 template:
 metadata:
 annotations:
 autoscaling.knative.dev/min-scale: "1"
 developer.conventions/target-containers: workload
 labels:
 app.kubernetes.io/component: run
 app.kubernetes.io/part-of: tanzu-java-web-app
 apps.tanzu.vmware.com/auto-configure-actuators: "true"
 apps.tanzu.vmware.com/workload-type: web
 carto.run/workload-name: tanzu-java-web-app
```

```

spec:
 containers:
 - image: registry.example.com/app-live-view/test/tanzu-java-web-app-default@sha256:444686bb8bfbaba5552676140619b00f43c8f85b6823b87676c0ccdcdead65ac
 name: workload
 resources: {}
 securityContext:
 runAsUser: 1000
 serviceAccountName: default
status:
 conditions:
 - lastTransitionTime: "2022-11-14T10:07:59Z"
 message: ""
 reason: Applied
 status: "True"
 type: ConventionsApplied
 - lastTransitionTime: "2022-11-14T10:07:59Z"
 message: ""
 reason: ConventionsApplied
 status: "True"
 type: Ready
observedGeneration: 1
template:
 metadata:
 annotations:
 autoscaling.knative.dev/min-scale: "1"
 boot.spring.io/actuator: http://:8081/actuator
 boot.spring.io/version: 2.7.3
 conventions.carto.run/applied-conventions: |-
 spring-boot-convention/auto-configure-actuators-check
 spring-boot-convention/spring-boot
 spring-boot-convention/spring-boot-graceful-shutdown
 spring-boot-convention/spring-boot-web
 spring-boot-convention/spring-boot-actuator
 spring-boot-convention/spring-boot-actuator-probes
 spring-boot-convention/app-live-view-appflavour-check
 spring-boot-convention/app-live-view-connector-boot
 spring-boot-convention/app-live-view-appflavours-boot
 appliveview-sample/app-live-view-appflavour-check
 developer.conventions/target-containers: workload
 labels:
 app.kubernetes.io/component: run
 app.kubernetes.io/part-of: tanzu-java-web-app
 apps.tanzu.vmware.com/auto-configure-actuators: "true"
 apps.tanzu.vmware.com/workload-type: web
 carto.run/workload-name: tanzu-java-web-app
 conventions.carto.run/framework: spring-boot
 tanzu.app.live.view: "true"
 tanzu.app.live.view.application.actuator.path: actuator
 tanzu.app.live.view.application.actuator.port: "8081"
 tanzu.app.live.view.application.flavours: spring-boot
 tanzu.app.live.view.application.name: tanzu-java-web-app
 spec:
 containers:
 - env:
 - name: JAVA_TOOL_OPTIONS
 value: -Dmanagement.endpoint.health.probes.add-additional-paths="true" -Dmanagement.endpoint.health.show-details="always"
 -Dmanagement.endpoints.web.base-path="/actuator" -Dmanagement.endpoints.web.exposure.include="*"
 -Dmanagement.health.probes.enabled="true" -Dmanagement.server.port="8081"
 -Dserver.port="8080" -Dserver.shutdown.grace-period="24s"
 image: registry.example.com/app-live-view/test/tanzu-java-web-app-default@sha256:444686bb8bfbaba5552676140619b00f43c8f85b6823b87676c0ccdcdead65ac
 livenessProbe:
 httpGet:

```

```

 path: /livez
 port: 8080
 scheme: HTTP
 name: workload
 ports:
 - containerPort: 8080
 protocol: TCP
 readinessProbe:
 httpGet:
 path: /readyz
 port: 8080
 scheme: HTTP
 resources: {}
 securityContext:
 runAsUser: 1000
 serviceAccountName: default

```

#### Expected output of Spring Cloud Gateway workload:

```

apiVersion: conventions.carto.run/v1alpha1
kind: PodIntent
metadata:
 creationTimestamp: "2022-11-14T10:29:51Z"
 generation: 1
 labels:
 app.kubernetes.io/component: intent
 app.kubernetes.io/part-of: tanzu-scg-web-app
 apps.tanzu.vmware.com/auto-configure-actuators: "true"
 apps.tanzu.vmware.com/workload-type: web
 carto.run/cluster-template-name: convention-template
 carto.run/resource-name: config-provider
 carto.run/supply-chain-name: source-to-url
 carto.run/template-kind: ClusterConfigTemplate
 carto.run/workload-name: tanzu-scg-web-app
 carto.run/workload-namespace: default
 name: tanzu-scg-web-app
 namespace: default
 ownerReferences:
 - apiVersion: carto.run/v1alpha1
 blockOwnerDeletion: true
 controller: true
 kind: Workload
 name: tanzu-scg-web-app
 uid: 5d8cdc5b-0236-471d-8c1e-335e659f1ae6
 resourceVersion: "475756"
 uid: d086f02c-6ff0-47f8-8dee-4da8748d8adc
spec:
 serviceAccountName: default
 template:
 metadata:
 annotations:
 autoscaling.knative.dev/min-scale: "1"
 developer.conventions/target-containers: workload
 labels:
 app.kubernetes.io/component: run
 app.kubernetes.io/part-of: tanzu-scg-web-app
 apps.tanzu.vmware.com/auto-configure-actuators: "true"
 apps.tanzu.vmware.com/workload-type: web
 carto.run/workload-name: tanzu-scg-web-app
 spec:
 containers:
 - image: registry.example.com/app-live-view/test/tanzu-scg-web-app-default@sha256:7656f4ca56b7d0d6376b374643d6ac09c8cdcdbcc13d065f9224651b12724d0b
 name: workload
 resources: {}
 securityContext:

```

```

 runAsUser: 1000
 serviceAccountName: default
status:
 conditions:
 - lastTransitionTime: "2022-11-14T10:29:58Z"
 message: ""
 reason: Applied
 status: "True"
 type: ConventionsApplied
 - lastTransitionTime: "2022-11-14T10:29:58Z"
 message: ""
 reason: ConventionsApplied
 status: "True"
 type: Ready
observedGeneration: 1
template:
 metadata:
 annotations:
 autoscaling.knative.dev/min-scale: "1"
 boot.spring.io/actuator: http://:8081/actuator
 boot.spring.io/version: 2.6.3
 conventions.carto.run/applied-conventions: |-
 spring-boot-convention/auto-configure-actuators-check
 spring-boot-convention/spring-boot
 spring-boot-convention/spring-boot-web
 spring-boot-convention/spring-boot-actuator
 spring-boot-convention/spring-boot-actuator-probes
 spring-boot-convention/app-live-view-appflavour-check
 spring-boot-convention/app-live-view-connector-boot
 spring-boot-convention/app-live-view-appflavours-boot
 spring-boot-convention/app-live-view-connector-scg
 spring-boot-convention/app-live-view-appflavours-scg
 appliveview-sample/app-live-view-appflavour-check
 developer.conventions/target-containers: workload
 labels:
 app.kubernetes.io/component: run
 app.kubernetes.io/part-of: tanzu-scg-web-app
 apps.tanzu.vmware.com/auto-configure-actuators: "true"
 apps.tanzu.vmware.com/workload-type: web
 carto.run/workload-name: tanzu-scg-web-app
 conventions.carto.run/framework: spring-boot
 tanzu.app.live.view: "true"
 tanzu.app.live.view.application.actuator.path: actuator
 tanzu.app.live.view.application.actuator.port: "8081"
 tanzu.app.live.view.application.flavours: spring-boot_spring-cloud-gateway
 tanzu.app.live.view.application.name: tanzu-scg-web-app
 spec:
 containers:
 - env:
 - name: JAVA_TOOL_OPTIONS
 value: -Dmanagement.endpoint.health.probes.add-additional-paths="true" -Dman
agement.endpoint.health.show-details="always"
 -Dmanagement.endpoints.web.base-path="/actuator" -Dmanagement.endpoints.we
b.exposure.include="*"
 -Dmanagement.health.probes.enabled="true" -Dmanagement.server.port="8081"
 -Dserver.port="8080"
 image: registry.example.com/app-live-view/test/tanzu-scg-web-app-default@sha25
6:7656f4ca56b7d0d6376b374643d6ac09c8cdcbcc13d065f9224651b12724d0b
 livenessProbe:
 httpGet:
 path: /livez
 port: 8080
 scheme: HTTP
 name: workload
 ports:
 - containerPort: 8080

```

```

 protocol: TCP
 readinessProbe:
 httpGet:
 path: /readyz
 port: 8080
 scheme: HTTP
 resources: {}
 securityContext:
 runAsUser: 1000
 serviceAccountName: default

```

## List of Spring Boot conventions

This topic tells you about what the conventions do and how to apply them.

When submitting the following pod `Pod Intent` on each convention, the output can change depending on the applied convention.

Before any Spring Boot conventions are applied, the pod intent looks similar to this YAML:

```

apiVersion: conventions.carto.run/v1alpha1
kind: PodIntent
metadata:
 name: spring-sample
spec:
 template:
 spec:
 containers:
 - name: workload
 image: springio/petclinic

```

Most of the Spring Boot conventions either edit or add properties to the environment variable `JAVA_TOOL_OPTIONS`. You can override those conventions by providing the `JAVA_TOOL_OPTIONS` value you want through the Tanzu CLI or `workload.yaml`.

When a `JAVA_TOOL_OPTIONS` property already exists for a workload, the convention uses the existing value rather than the value that the convention applies by default. The property value that you provide is used for the pod specification mutation.

## Set a `JAVA_TOOL_OPTIONS` property for a workload

Do one of the following actions to set `JAVA_TOOL_OPTIONS` property and values:

### Use the Tanzu CLI apps plug-in

When creating or updating a workload, set a `JAVA_TOOL_OPTIONS` property using the `--env` flag by running:

```
tanzu apps workload create APP-NAME --env JAVA_TOOL_OPTIONS="-DPROPERTY-NAME=VALUE"
```

For example, to set the management port to `8080` rather than the `spring-boot-actuator-convention` default port `8081`, run:

```
tanzu apps workload create APP-NAME --env JAVA_TOOL_OPTIONS="-Dmanagement.server.port=8080"
```

### Use `workload.yaml`

Follow these steps:

1. Provide one or more values for the `JAVA_TOOL_OPTIONS` property in the `workload.yaml`.  
For example:



```

apiVersion: carto.run/v1alpha1
kind: Workload
...
spec:
env:
- name: JAVA_TOOL_OPTIONS
 value: -Dmanagement.server.port=8082
source:
...

```

2. Apply the `workload.yaml` file by running the command:

```
tanzu apps workload create -f workload.yaml
```

## Spring Boot convention

If the `spring-boot` dependency is in the metadata within the SBOM file under `dependencies`, the Spring Boot convention is applied to the `PodTemplateSpec` object.

The Spring Boot convention adds a label (`conventions.carto.run/framework: spring-boot`) to the `PodTemplateSpec` that describes the framework associated with the workload, and adds an annotation (`boot.spring.io/version: VERSION-NO`) that describes the Spring Boot version of the dependency.

The label and annotation are added for informational purposes only.

Example of PodIntent after applying the convention:

```

apiVersion: conventions.carto.run/v1alpha1
kind: PodIntent
metadata:
 annotations:
 kubect1.kubernetes.io/last-applied-configuration: |
 {"apiVersion":"conventions.carto.run/v1alpha1","kind":"PodIntent","metadata":{"an
notations":{},"name":"spring-sample","namespace":"default"},"spec":{"template":{"spe
c":{"containers":[{"image":"springio/petclinic","name":"workload"}]}}}
...
status:
 conditions:
 - lastTransitionTime: "... " # This status indicates that all worked as expected
 status: "True"
 type: ConventionsApplied
 - lastTransitionTime: "... "
 status: "True"
 type: Ready
 observedGeneration: 1
 template:
 metadata:
 annotations:
 boot.spring.io/version: 2.3.3.RELEASE
 conventions.carto.run/applied-conventions: |-
 spring-boot-convention/spring-boot
 labels:
 conventions.carto.run/framework: spring-boot
 spec:
 containers:
 - image: index.docker.io/springio/petclinic@sha256:...
 name: workload
 resources: {}

```

## Spring boot graceful shut down convention

If any of the following dependencies are in the metadata within the SBOM file under `dependencies`, the Spring Boot graceful shut down convention is applied to the `PodTemplateSpec` object:

- `spring-boot-starter-tomcat`
- `spring-boot-starter-jetty`
- `spring-boot-starter-reactor-netty`
- `spring-boot-starter-undertow`
- `tomcat-embed-core`

The Graceful Shutdown convention `spring-boot-graceful-shutdown` adds a property in the environment variable `JAVA_TOOL_OPTIONS` with the key `server.shutdown.grace-period`. The key value is calculated to be 80% of the value set in `.target.Spec.TerminationGracePeriodSeconds`. The default value for `.target.Spec.TerminationGracePeriodSeconds` is 30 seconds.

Example of PodIntent after applying the convention:

```
apiVersion: conventions.carto.run/v1alpha1
kind: PodIntent
metadata:
 annotations:
 kubectl.kubernetes.io/last-applied-configuration: |
 {"apiVersion":"conventions.carto.run/v1alpha1","kind":"PodIntent","metadata":{"annotations":{},"name":"spring-sample","namespace":"default"},"spec":{"template":{"spec":{"containers":[{"image":"springio/petclinic","name":"workload"}]}}}}
 ...
status:
 conditions:
 - lastTransitionTime: "... " # This status indicates that all worked as expected
 status: "True"
 type: ConventionsApplied
 - lastTransitionTime: "... "
 status: "True"
 type: Ready
 observedGeneration: 1
 template:
 metadata:
 annotations:
 boot.spring.io/version: 2.3.3.RELEASE
 conventions.carto.run/applied-conventions: |-
 spring-boot-convention/spring-boot
 spring-boot-convention/spring-boot-graceful-shutdown
 labels:
 conventions.carto.run/framework: spring-boot
 spec:
 containers:
 - env:
 - name: JAVA_TOOL_OPTIONS
 value: -Dserver.shutdown.grace-period="24s"
 image: index.docker.io/springio/petclinic@sha256:...
 name: workload
 resources: {}
```

## Spring Boot web convention

If any of the following dependencies are in the metadata within the SBOM file under `dependencies`, the Spring Boot web convention is applied to the `PodTemplateSpec` object:

- spring-boot
- spring-boot-web

The web convention `spring-boot-web` obtains the `server.port` property from the `JAVA_TOOL_OPTIONS` environment variable and sets it as a port in the `PodTemplateSpec`. If `JAVA_TOOL_OPTIONS` environment variable does not contain a `server.port` property or value, the convention adds the property and sets the value to `8080`, which is the Spring Boot default.

Example of PodIntent after applying the convention:

```
apiVersion: conventions.carto.run/v1alpha1
kind: PodIntent
metadata:
 annotations:
 kubectl.kubernetes.io/last-applied-configuration: |
 {"apiVersion":"conventions.carto.run/v1alpha1","kind":"PodIntent","metadata":{"a
nnotations":{},"name":"spring-sample","namespace":"default"},"spec":{"template":{"spe
c":{"containers":[{"image":"springio/petclinic","name":"workload"}]}}}
...
status:
 conditions:
 - lastTransitionTime: "... " # This status indicates that all worked as expected
 status: "True"
 type: ConventionsApplied
 - lastTransitionTime: "... "
 status: "True"
 type: Ready
 observedGeneration: 1
 template:
 metadata:
 annotations:
 boot.spring.io/version: 2.3.3.RELEASE
 conventions.carto.run/applied-conventions: |-
 spring-boot-convention/spring-boot
 spring-boot-convention/spring-boot-web
 labels:
 conventions.carto.run/framework: spring-boot
 spec:
 containers:
 - env:
 - name: JAVA_TOOL_OPTIONS
 value: -Dserver.port="8080"
 image: index.docker.io/springio/petclinic@sha256:...
 name: workload
 ports:
 - containerPort: 8080
 protocol: TCP
 resources: {}
```

## Spring Boot Actuator convention

If the `spring-boot-actuator` dependency is in the metadata within the `SBOM` file under `dependencies`, the Spring Boot actuator convention is applied to the `PodTemplateSpec` object.

The Spring Boot Actuator convention does the following actions:

If the workload-level or platform-level automatic configuration of actuators is enabled:

1. Sets the management port in the `JAVA_TOOL_OPTIONS` environment variable to `8081`.
2. Sets the base path in the `JAVA_TOOL_OPTIONS` environment variable to `/actuator`.

3. Adds an annotation, `boot.spring.io/actuator`, to where the actuator is accessed.

The management port is set to port `8081` for security reasons. Although you can prevent public access to the actuator endpoints that are exposed on the management port when it is set to the default `8080`, the threat of exposure through internal access remains. The best practice for security is to set the management port to something other than `8080`.

However, if a management port number value is provided using the `-Dmanagement.server.port` property in `JAVA_TOOL_OPTIONS`, the Spring Boot actuator convention uses that value rather than its default `8081` as the management port.

You can access the management context of a Spring Boot application by creating a service pointing to port `8081` and base path `/actuator`.



### Important

To override the management port setting applied by this convention, see [How to set a JAVA\\_TOOL\\_OPTIONS property for a workload](#) earlier in this topic. Any alternative methods for setting the management port are overwritten. For example, if you configure the management port using `application.properties/yml` or `config server`, the Spring Boot Actuator convention overrides your configuration.

If the workload-level or platform-level automatic configuration of actuators is deactivated, the Spring Boot actuator convention does not set any `JAVA_TOOLS_OPTIONS` and does not set the annotation `boot.spring.io/actuator`.

Example of PodIntent after applying the convention:

```
apiVersion: conventions.carto.run/v1alpha1
kind: PodIntent
metadata:
 annotations:
 kubect1.kubernetes.io/last-applied-configuration: |
 {"apiVersion":"conventions.carto.run/v1alpha1","kind":"PodIntent","metadata":{"an
notations":{},"name":"spring-sample","namespace":"default"},"spec":{"template":{"spe
c":{"containers":[{"image":"springio/petclinic","name":"workload"}]}}}
...
status:
 conditions:
 - lastTransitionTime: "..." # This status indicates that all worked as expected
 status: "True"
 type: ConventionsApplied
 - lastTransitionTime: "..."
 status: "True"
 type: Ready
 observedGeneration: 1
 template:
 metadata:
 annotations:
 boot.spring.io/actuator: http://:8081/actuator
 boot.spring.io/version: 2.3.3.RELEASE
 conventions.carto.run/applied-conventions: |-
 spring-boot-convention/spring-boot
 spring-boot-convention/spring-boot-web
 spring-boot-convention/spring-boot-actuator
 labels:
 conventions.carto.run/framework: spring-boot
 spec:
 containers:
 - env:
```

```

- name: JAVA_TOOL_OPTIONS
 value: Dmanagement.endpoints.web.base-path="/actuator" -Dmanagement.server.port="8081" -Dserver.port="8080"
 image: index.docker.io/springio/petclinic@sha256:...
 name: workload
 ports:
 - containerPort: 8080
 protocol: TCP
 resources: {}

```

## Spring Boot Actuator Probes convention

The Spring Boot Actuator Probes convention is applied only if all of the following conditions are met:

- The `spring-boot-actuator` dependency exists and is `>= 2.6`
- The `JAVA_TOOL_OPTIONS` environment variable does not include the following properties or, if either of the properties is included, it is set to a value of `true`:
  - `-Dmanagement.health.probes.enabled`
  - `-Dmanagement.endpoint.health.probes.add-additional-paths`

The Spring Boot Actuator Probes convention does the following actions:

1. Uses the main server port, which is the `server.port` value on `JAVA_TOOL_OPTIONS`, to set the liveness and readiness probes. For more information see the [Kubernetes documentation](#)
2. Adds the following properties and values to the `JAVA_TOOL_OPTIONS` environment variable:
  - `-Dmanagement.health.probes.enabled="true"`
  - `-Dmanagement.endpoint.health.probes.add-additional-paths="true"`

When this convention is applied, the probes are exposed as follows:

- Liveness probe: `/livez`
- Readiness probe: `/readyz`

Example of PodIntent after applying the convention:

```

apiVersion: conventions.carto.run/v1alpha1
kind: PodIntent
metadata:
 annotations:
 kubect1.kubernetes.io/last-applied-configuration: |
 {"apiVersion":"conventions.carto.run/v1alpha1","kind":"PodIntent","metadata":{"annotations":{},"name":"spring-sample","namespace":"default"},"spec":{"template":{"spec":{"containers":[{"image":"springio/petclinic","name":"workload"}]}}}
...
status:
 conditions:
 - lastTransitionTime: "... " # This status indicates that all worked as expected
 status: "True"
 type: ConventionsApplied
 - lastTransitionTime: "... "
 status: "True"
 type: Ready
 observedGeneration: 1
 template:
 metadata:
 annotations:
 boot.spring.io/actuator: http://:8080/actuator

```

```

boot.spring.io/version: 2.6.0
conventions.carto.run/applied-conventions: |-
 spring-boot-convention/spring-boot
 spring-boot-convention/spring-boot-web
 spring-boot-convention/spring-boot-actuator
labels:
 conventions.carto.run/framework: spring-boot
spec:
 containers:
 - env:
 - name: JAVA_TOOL_OPTIONS
 value: -Dmanagement.endpoint.health.probes.add-additional-paths="true" -Dman
agement.endpoints.web.base-path="/actuator" -Dmanagement.health.probes.enabled="true"
-Dmanagement.server.port="8081" -Dserver.port="8080"
 image: index.docker.io/springio/petclinic@sha256:...
 name: workload
 livenessProbe:
 httpGet:
 path: /livez
 port: 8080
 scheme: HTTP
 ports:
 - containerPort: 8080
 protocol: TCP
 readinessProbe:
 httpGet:
 path: /readyz
 port: 8080
 scheme: HTTP
 resources: {}

```

## Service intent conventions

The Service intent conventions do not change the behavior of the final deployment, but you can use them as added information to process in the supply chain. For example, when an app requires to be bound to database service. This convention adds an annotation and a label to the `PodTemplateSpec` for each detected dependency. It also adds an annotation and a label to the `conventions.carto.run/applied-conventions`.

The list of the supported intents are:

### MySQL

- **Name:** `service-intent-mysql`
- **Label:** `services.conventions.apps.tanzu.vmware.com/mysql`
- **Dependencies:** `mysql-connector-java`, `r2dbc-mysql`

### PostgreSQL

- **Name:** `service-intent-postgres`
- **Label:** `services.conventions.apps.tanzu.vmware.com/postgres`
- **Dependencies:** `postgresql`, `r2dbc-postgresql`

### MongoDB

- **Name:** `service-intent-mongodb`
- **Label:** `services.conventions.apps.tanzu.vmware.com/mongodb`
- **Dependencies:** `mongodb-driver-core`

### RabbitMQ

- **Name:** `service-intent-rabbitmq`
- **Label:** `services.conventions.apps.tanzu.vmware.com/rabbitmq`
- **Dependencies:** `amqp-client`

### Redis

- **Name:** `service-intent-redis`
- **Label:** `services.conventions.apps.tanzu.vmware.com/redis`
- **Dependencies:** `jedis`

### Kafka

- **Name:** `service-intent-kafka`
- **Label:** `services.conventions.apps.tanzu.vmware.com/kafka`
- **Dependencies:** `kafka-clients`

### Kafka-streams

- **Name:** `service-intent-kafka-streams`
- **Label:** `services.conventions.apps.tanzu.vmware.com/kafka-streams`
- **Dependencies:** `kafka-streams`

## Example

When you apply the `Pod Intent` and the image contains a dependency, for example, of MySQL, then the output of the convention is:

```
apiVersion: conventions.carto.run/v1alpha1
kind: PodIntent
metadata:
 annotations:
 kubectl.kubernetes.io/last-applied-configuration: |
 {"apiVersion":"conventions.carto.run/v1alpha1","kind":"PodIntent","metadata":
{"annotations":{},"name":"spring-sample","namespace":"default"},"spec":{"template":{"s
pec":{"containers":[{"image":"springio/petclinic","name":"workload"}]}}}
 creationTimestamp: "...
 generation: 1
 name: spring-sample
 namespace: default
 resourceVersion: "...
 uid: ...
spec:
 serviceAccountName: default
 template:
 metadata: {}
 spec:
 containers:
 - image: springio/petclinic
 name: workload
 resources: {}
status:
 conditions:
 - lastTransitionTime: "... # This status indicates that all worked as expected
 status: "True"
 type: ConventionsApplied
 - lastTransitionTime: "...
 status: "True"
 type: Ready
 observedGeneration: 1
 template:
```

```

metadata:
 annotations:
 boot.spring.io/actuator: http://:8080/actuator
 boot.spring.io/version: 2.3.3.RELEASE
 conventions.carto.run/applied-conventions: |-
 spring-boot-convention/spring-boot
 spring-boot-convention/spring-boot-web
 spring-boot-convention/spring-boot-actuator
 spring-boot-convention/service-intent-mysql
 services.conventions.apps.tanzu.vmware.com/mysql: mysql-connector-java/8.0.2
1
 labels:
 conventions.apps.tanzu.vmware.com/framework: spring-boot
 services.conventions.apps.tanzu.vmware.com/mysql: workload
spec:
 containers:
 - env:
 - name: JAVA_TOOL_OPTIONS
 value: Dmanagement.endpoints.web.base-path="/actuator" -Dmanagement.serv
r.port="8081" -Dserver.port="8080"
 image: index.docker.io/springio/petclinic@sha256:...
 name: workload
 ports:
 - containerPort: 8080
 protocol: TCP
 resources: {}

```

## Troubleshoot Spring Boot conventions

This topic tells you how to troubleshoot Spring Boot conventions.

### Collect logs

If you have trouble, you can retrieve and examine logs from the Spring Boot convention server as follows:

1. The Spring Boot convention server creates a namespace to contain all of the associated resources. By default the namespace is `spring-boot-convention`. To inspect the logs, run:

```
kubectl logs -l app=spring-boot-webhook -n spring-boot-convention
```

For example:

```

$ kubectl logs -l app=spring-boot-webhook -n spring-boot-convention

{"level":"info","timestamp":"2021-11-11T16:00:26.597Z","caller":"spring-boot-co
nventions/server.go:83","msg":"Successfully applied convention: spring-boot","c
omponent":"spring-boot-conventions"}
{"level":"info","timestamp":"2021-11-11T16:00:26.597Z","caller":"spring-boot-co
nventions/server.go:83","msg":"Successfully applied convention: spring-boot-gra
ceful-shutdown","component":"spring-boot-conventions"}
{"level":"info","timestamp":"2021-11-11T16:00:26.597Z","caller":"spring-boot-co
nventions/server.go:83","msg":"Successfully applied convention: spring-boot-we
b","component":"spring-boot-conventions"}
{"level":"info","timestamp":"2021-11-11T16:00:26.597Z","caller":"spring-boot-co
nventions/server.go:83","msg":"Successfully applied convention: spring-boot-act
uator","component":"spring-boot-conventions"}
{"level":"info","timestamp":"2021-11-11T16:00:26.597Z","caller":"spring-boot-co
nventions/server.go:83","msg":"Successfully applied convention: service-intent-
mysql","component":"spring-boot-conventions"}

```



2. For all of the conventions that were applied successfully, a log entry is added. If an error occurs, a log entry is added with a description.

## Overview of Spring Cloud Gateway for Kubernetes

Spring Cloud Gateway for Kubernetes is an API gateway solution based on the open-source Spring Cloud Gateway project. It provides a simple means to route internal or external API requests to application services that expose APIs.

Spring Cloud Gateway for Kubernetes handles cross-cutting concerns on behalf of API development teams, including single sign-on (SSO), access control, rate limiting, resiliency, security, and more.

It enables you to accelerate API delivery using modern cloud-native patterns with any programming language you choose for API development. It also integrates with your existing CI/CD pipeline strategy.

For more information about Spring Cloud Gateway for Kubernetes, see the [Spring Cloud Gateway for Kubernetes documentation](#).

## Overview of Spring Cloud Gateway for Kubernetes

Spring Cloud Gateway for Kubernetes is an API gateway solution based on the open-source Spring Cloud Gateway project. It provides a simple means to route internal or external API requests to application services that expose APIs.

Spring Cloud Gateway for Kubernetes handles cross-cutting concerns on behalf of API development teams, including single sign-on (SSO), access control, rate limiting, resiliency, security, and more.

It enables you to accelerate API delivery using modern cloud-native patterns with any programming language you choose for API development. It also integrates with your existing CI/CD pipeline strategy.

For more information about Spring Cloud Gateway for Kubernetes, see the [Spring Cloud Gateway for Kubernetes documentation](#).

## Install Spring Cloud Gateway for Kubernetes

This topic describes how to install Spring Cloud Gateway for Kubernetes from the Tanzu Application Platform package repository.

### Prerequisites

Before installing Spring Cloud Gateway, complete all prerequisites for installing Tanzu Application Platform. For more information, see [Prerequisites](#).

### Install

To install Spring Cloud Gateway:

1. See which versions of Spring Cloud Gateway are available to install from the Tanzu Application Platform repository by running:

```
tanzu package available list spring-cloud-gateway.tanzu.vmware.com --namespace tap-install
```

For example:

```
$ tanzu package available list spring-cloud-gateway.tanzu.vmware.com --namespace tap-install
```

NAME	VERSION	RELEASED-AT
spring-cloud-gateway.tanzu.vmware.com	2.0.0	2022-02-01T00:00:00Z

- (Optional) View the changes you can make to the default installation settings by running:

```
tanzu package available get spring-cloud-gateway.tanzu.vmware.com/VERSION-NUMBER \
--namespace tap-install --values-schema
```

Where `VERSION-NUMBER` is the version of the package listed earlier.

For example:

```
tanzu package available get spring-cloud-gateway.tanzu.vmware.com/2.0.0 \
--namespace tap-install --values-schema
```

You can use the information to generate a values override file for use in the following installation step.

For more information about values schema options, see the [Spring Cloud Gateway for Kubernetes documentation](#).



#### Important

The value of `deployment.namespace` must always be set to the same value as the `--namespace` flag.

- Install Spring Cloud Gateway by running:

#### Default values

Run this command to install Spring Cloud Gateway with the default values

```
tanzu package install spring-cloud-gateway \
--package spring-cloud-gateway.tanzu.vmware.com \
--version VERSION-NUMBER \
--namespace tap-install
```

For example:

```
$ tanzu package install spring-cloud-gateway \
--package spring-cloud-gateway.tanzu.vmware.com \
--version 2.0.0 \
--namespace tap-install
```

```
Installing package 'spring-cloud-gateway.tanzu.vmware.com'
Getting package metadata for 'spring-cloud-gateway.tanzu.vmware.com'
Creating service account 'spring-cloud-gateway-tap-install-sa'
Creating cluster admin role 'spring-cloud-gateway-tap-install-cluster-role'
Creating cluster role binding 'spring-cloud-gateway-tap-install-cluster-rolebinding'
Creating package resource
Waiting for 'PackageInstall' reconciliation for 'spring-cloud-gateway'
'PackageInstall' resource install status: Reconciling
'PackageInstall' resource install status: ReconcileSucceeded

Added installed package 'spring-cloud-gateway'
```

**Overriding values**

Run this command to install Spring Cloud Gateway while overriding the default values

```
tanzu package install spring-cloud-gateway \
 --package spring-cloud-gateway.tanzu.vmware.com \
 --version VERSION-NUMBER \
 --namespace tap-install \
 --values-file values.yml
```

## Overview of Supply Chain Choreographer for Tanzu

This topic introduces you to Supply Chain Choreographer.

### Overview

Supply Chain Choreographer is based on open source [Cartographer](#). It allows App Operators to create pre-approved paths to production by integrating Kubernetes resources with the elements of their existing toolchains, for example, Jenkins.

Each pre-approved supply chain creates a path to production. Orchestrating supply chain resources including, test, build, scan, and deploy allows developers to focus on delivering value to their users and provides App Operators the assurance that all code in production has passed through all the steps of an approved workflow.

### Out of the Box Supply Chains

Out of the box supply chains are provided with Tanzu Application Platform.

The following three supply chains are included:

- [Out of the Box Supply Chain Basic](#)
- [Out of the Box Supply Chain with Testing](#)
- [Out of the Box Supply Chain with Testing and Scanning](#)

As auxiliary components, Tanzu Application Platform also includes:

- [Out of the Box Templates](#), for providing templates used by the supply chains to perform common tasks such as fetching source code, running tests, and building container images.
- [Out of the Box Delivery Basic](#), for delivering to a Kubernetes cluster the configuration built throughout a supply chain

Both Templates and Delivery Basic are requirements for the Supply Chains.

Supply Chain Choreographer supports the following pipeline types:

- [Tekton pipelines](#)
- [Jenkins pipelines](#)

## Overview of Supply Chain Choreographer for Tanzu

This topic introduces you to Supply Chain Choreographer.

### Overview

Supply Chain Choreographer is based on open source [Cartographer](#). It allows App Operators to create pre-approved paths to production by integrating Kubernetes resources with the elements of

their existing toolchains, for example, Jenkins.

Each pre-approved supply chain creates a path to production. Orchestrating supply chain resources including, test, build, scan, and deploy allows developers to focus on delivering value to their users and provides App Operators the assurance that all code in production has passed through all the steps of an approved workflow.

## Out of the Box Supply Chains

Out of the box supply chains are provided with Tanzu Application Platform.

The following three supply chains are included:

- [Out of the Box Supply Chain Basic](#)
- [Out of the Box Supply Chain with Testing](#)
- [Out of the Box Supply Chain with Testing and Scanning](#)

As auxiliary components, Tanzu Application Platform also includes:

- [Out of the Box Templates](#), for providing templates used by the supply chains to perform common tasks such as fetching source code, running tests, and building container images.
- [Out of the Box Delivery Basic](#), for delivering to a Kubernetes cluster the configuration built throughout a supply chain

Both Templates and Delivery Basic are requirements for the Supply Chains.

Supply Chain Choreographer supports the following pipeline types:

- [Tekton pipelines](#)
- [Jenkins pipelines](#)

## Install Supply Chain Choreographer

This topic describes how you can install Supply Chain Choreographer from the Tanzu Application Platform package repository.



### Note

Follow the steps in this topic if you do not want to use a profile to install Supply Chain Choreographer. For more information about profiles, see [Components and installation profiles](#).

The Supply Chain Choreographer is now bundled with the Cartographer Conventions. For information on configuring and using Cartographer Conventions, see [Creating conventions](#).

Supply Chain Choreographer provides the custom resource definitions the supply chain uses. Each pre-approved supply chain creates a clear road to production and orchestrates supply chain resources. You can test, build, scan, and deploy. Developers can focus on delivering value to users. Application operators can rest assured that all code in production has passed through an approved workflow.

For example, Supply Chain Choreographer passes the results of fetching source code to the component that builds a container image of it, and then passes the container image to a component that deploys the image.

## Prerequisites

Before installing Supply Chain Choreographer, complete all prerequisites to install Tanzu Application Platform. For more information, see [Prerequisites](#).

## Install

To install Supply Chain Choreographer:

1. Get the values schema to see what properties can be configured during installation by running:

```
tanzu package available get cartographer.tanzu.vmware.com/0.7.1+tap.1 --values-
schema --namespace tap-install
```

KEY	DEFAULT	TYPE	DESCRIPTION
ca_cert_data	""	string	Optional: PEM Encode
d certificate data for image registries with private CA.			
cartographer.concurrency.max_deliveries	2	integer	Optional: maximum nu
mber of Deliverables to process concurrently.			
cartographer.concurrency.max_runnables	2	integer	Optional: maximum nu
mber of Runnables to process concurrently.			
cartographer.concurrency.max_workloads	2	integer	Optional: maximum nu
mber of Workloads to process concurrently.			
cartographer.resources.limits.cpu	1000m		Optional: maximum am
ount of cpu resources to allow the controller to use			
cartographer.resources.limits.memory	128Mi		Optional: maximum am
ount of memory to allow the controller to use			
cartographer.resources.requests.cpu	250m		Optional: minimum am
ount of cpu to reserve			
cartographer.resources.requests.memory	128Mi		Optional: minimum am
ount of memory to reserve			

2. Install v0.4.0 of the [cartographer.tanzu.vmware.com](#) package, naming the installation [cartographer](#), by running:

```
tanzu package install cartographer \
--namespace tap-install \
--package cartographer.tanzu.vmware.com \
--version 0.7.1+tap.1
```

Example output:

```
| Installing package 'cartographer.tanzu.vmware.com'
| Getting namespace 'tap-install'
| Getting package metadata for 'cartographer.tanzu.vmware.com'
| Creating service account 'cartographer-tap-install-sa'
| Creating cluster admin role 'cartographer-tap-install-cluster-role'
| Creating cluster role binding 'cartographer-tap-install-cluster-rolebinding'
- Creating package resource
\ Package install status: Reconciling

Added installed package 'cartographer' in namespace 'tap-install'
```

## Out of the Box Supply Chain Basic for Supply Chain Choreographer

This topic provides an overview of Out of the Box Supply Chain Basic for Supply Chain Choreographer.

This package contains Cartographer supply chains that tie together a series of Kubernetes resources that drive a developer-provided workload from source code to a Kubernetes configuration ready to be deployed to a cluster. It contains the most basic supply chains that focus on providing a quick path to deployment making no use of testing or scanning resources.

The supply chains in this package perform the following:

- Building from source code:
  1. Watching a Git repository, Maven repository, or local directory for changes
  2. Building a container image out of the source code with Buildpacks
  3. Applying operator-defined conventions to the container definition
  4. Creating a deliverable object for deploying the application to a cluster
  5. (Experimental) Alternatively, outputting a Carvel Package containing the application to a Git Repository
- Using a prebuilt application image:
  1. Applying operator-defined conventions to the container definition
  2. Creating a deliverable object for deploying the application to a cluster
  3. (Experimental) Alternatively, outputting a Carvel Package containing the application to a Git Repository

## Prerequisites

To use this package, you must:

- Install [Out of the Box Templates](#).
- Configure the Developer namespace with auxiliary objects that are used by the supply chain as described in the following section.
- (Optionally) install [Out of the Box Delivery Basic](#), if you are willing to deploy the application to the same cluster as the workload and supply chains.

## Developer Namespace

The supply chains provide definitions of many of the objects that they create to transform the source code to a container image and make it available as an application in a cluster.

The developer must provide or configure particular objects in the developer namespace so that the supply chain can provide credentials and use permissions granted to a specific development team.

The objects that the developer must provide or configure include:

- **registries secrets**: Kubernetes secrets of type `kubernetes.io/dockerconfigjson` that contain credentials for pushing and pulling the container images built by the supply chain and the installation of Tanzu Application Platform.
- **service account**: The identity to be used for any interaction with the Kubernetes API made by the supply chain.
- **rolebinding**: Grant to the identity the necessary roles for creating the resources prescribed by the supply chain.

### Registries Secrets

Regardless of the supply chain that a workload goes through, there must be Kubernetes secrets in the developer namespace containing credentials for both pushing and pulling the container image

that the supply chain builds when source code is provided. The developer namespace must also contain registry credentials for Kubernetes to run pods using images from the installation of Tanzu Application Platform.

1. Add read/write registry credentials for pushing and pulling application images:

```
tanzu secret registry add registry-credentials \
 --server REGISTRY-SERVER \
 --username REGISTRY-USERNAME \
 --password REGISTRY-PASSWORD \
 --namespace YOUR-NAMESPACE
```

Where:

- o `YOUR-NAMESPACE` is the name you want to use for the developer namespace. For example, use `default` for the default namespace.
  - o `REGISTRY-SERVER` is the URL of the registry. For Docker Hub, this must be `https://index.docker.io/v1/`. Specifically, it must have the leading `https://`, the `v1` path, and the trailing `/`. For Google Container Registry (GCR), this is `gcr.io`. Based on the information used in [Installing the Tanzu Application Platform package and profiles](#), you can use the same registry server as in `ootb_supply_chain_basic - registry - server`.
2. Add a placeholder secret for gathering the credentials used for pulling container images from the installation of Tanzu Application Platform:

```
cat <<EOF | kubectl -n YOUR-NAMESPACE apply -f -
apiVersion: v1
kind: Secret
metadata:
 name: tap-registry
 annotations:
 secretgen.carvel.dev/image-pull-secret: ""
type: kubernetes.io/dockerconfigjson
data:
 .dockerconfigjson: e30K
EOF
```

With the two secrets created:

- `tap-registry` is a placeholder secret filled indirectly by `secretgen-controller` Tanzu Application Platform credentials set up during the installation of Tanzu Application Platform.
- `registry-credentials` is a secret providing credentials for the registry where application container images are pushed to.

The following section discusses setting up the identity required for the workload.

## ServiceAccount

In a Kubernetes cluster, a ServiceAccount provides a way of representing an actor within the Kubernetes role-based access control (RBAC) system. In the case of a developer namespace, this represents a developer or development team.

You can directly attach secrets to the ServiceAccount through both the `secrets` and `imagePullSecrets` fields. This allows you to provide indirect ways for resources to find credentials without knowing the exact name of the secrets.

```
apiVersion: v1
kind: ServiceAccount
metadata:
```

```

name: default
secrets:
 - name: registry-credentials
 - name: tap-registry
imagePullSecrets:
 - name: registry-credentials
 - name: tap-registry

```



### Important

The ServiceAccount must have the secrets created earlier linked to it. If it does not, services like Tanzu Build Service (used in the supply chain) lack the necessary credentials for pushing the images it builds for that workload.

## RoleBinding

As the supply chain takes action in the cluster on behalf of the users who created the workload, it needs permissions within Kubernetes' RBAC system to do so.

Tanzu Application Platform v1.2 includes two ClusterRoles that describe all of the necessary permissions to grant to the service account:

- `workload` clusterrole, providing the necessary roles for the supply chains to manage the resources prescribed by them.
- `deliverable` clusterrole, providing the roles for deliveries to deploy to the cluster the application Kubernetes objects produced by the supply chain.

To provide those permissions to the identity you created for this workload, bind the `workload` ClusterRole to the ServiceAccount you created above:

```

apiVersion: rbac.authorization.k8s.io/v1
kind: RoleBinding
metadata:
 name: default-permit-workload
roleRef:
 apiGroup: rbac.authorization.k8s.io
 kind: ClusterRole
 name: workload
subjects:
 - kind: ServiceAccount
 name: default

```

If this is a Build cluster, and you do not intend to run the application in it, this single RoleBinding is all that's necessary.

If you intend to also deploy the application that's been built, bind to the same ServiceAccount the `deliverable` ClusterRole too:

```

apiVersion: rbac.authorization.k8s.io/v1
kind: RoleBinding
metadata:
 name: default-permit-deliverable
roleRef:
 apiGroup: rbac.authorization.k8s.io
 kind: ClusterRole
 name: deliverable
subjects:
 - kind: ServiceAccount
 name: default

```



For more information about authentication and authorization in Tanzu Application Platform, see [Overview of Default roles for Tanzu Application Platform](#).

## Developer workload

With the developer namespace set up with the preceding objects, such as secret, serviceaccount, and rolebinding, you can create the workload object.

To do so, use the `apps` plug-in from the Tanzu CLI:

```
tanzu apps workload create FLAGS WORKLOAD-NAME
```

Where:

- `FLAGS` are the one or more flags you want to include.
- `WORKLOAD-NAME` is the name of the workload you want to target.

Depending on what you are aiming to achieve, you can set different flags. To know more about those (including details about different features of the supply chains), see the following sections:

- [Building from source](#), for more information about different ways of creating a workload where the application is built from source code.
- [Using an existing image](#), for more information about how to use prebuilt images in the supply chains.
- [GitOps vs RegistryOps](#), for a description of the different ways of propagating the deployment configuration through external systems (Git repositories and image registries).
- [Carvel Package Workflow](#), for information about how to configure workloads to output Carvel Packages for delivery through Git repositories.

## Out of the Box Supply Chain Basic for Supply Chain Choreographer

This topic provides an overview of Out of the Box Supply Chain Basic for Supply Chain Choreographer.

This package contains Cartographer supply chains that tie together a series of Kubernetes resources that drive a developer-provided workload from source code to a Kubernetes configuration ready to be deployed to a cluster. It contains the most basic supply chains that focus on providing a quick path to deployment making no use of testing or scanning resources.

The supply chains in this package perform the following:

- Building from source code:
  1. Watching a Git repository, Maven repository, or local directory for changes
  2. Building a container image out of the source code with Buildpacks
  3. Applying operator-defined conventions to the container definition
  4. Creating a deliverable object for deploying the application to a cluster
  5. (Experimental) Alternatively, outputting a Carvel Package containing the application to a Git Repository
- Using a prebuilt application image:
  1. Applying operator-defined conventions to the container definition
  2. Creating a deliverable object for deploying the application to a cluster

- (Experimental) Alternatively, outputting a Carvel Package containing the application to a Git Repository

## Prerequisites

To use this package, you must:

- Install [Out of the Box Templates](#).
- Configure the Developer namespace with auxiliary objects that are used by the supply chain as described in the following section.
- (Optionally) install [Out of the Box Delivery Basic](#), if you are willing to deploy the application to the same cluster as the workload and supply chains.

## Developer Namespace

The supply chains provide definitions of many of the objects that they create to transform the source code to a container image and make it available as an application in a cluster.

The developer must provide or configure particular objects in the developer namespace so that the supply chain can provide credentials and use permissions granted to a specific development team.

The objects that the developer must provide or configure include:

- registries secrets:** Kubernetes secrets of type `kubernetes.io/dockerconfigjson` that contain credentials for pushing and pulling the container images built by the supply chain and the installation of Tanzu Application Platform.
- service account:** The identity to be used for any interaction with the Kubernetes API made by the supply chain.
- rolebinding:** Grant to the identity the necessary roles for creating the resources prescribed by the supply chain.

### Registries Secrets

Regardless of the supply chain that a workload goes through, there must be Kubernetes secrets in the developer namespace containing credentials for both pushing and pulling the container image that the supply chain builds when source code is provided. The developer namespace must also contain registry credentials for Kubernetes to run pods using images from the installation of Tanzu Application Platform.

- Add read/write registry credentials for pushing and pulling application images:

```
tanzu secret registry add registry-credentials \
 --server REGISTRY-SERVER \
 --username REGISTRY-USERNAME \
 --password REGISTRY-PASSWORD \
 --namespace YOUR-NAMESPACE
```

Where:

- `YOUR-NAMESPACE` is the name you want to use for the developer namespace. For example, use `default` for the default namespace.
- `REGISTRY-SERVER` is the URL of the registry. For Docker Hub, this must be `https://index.docker.io/v1/`. Specifically, it must have the leading `https://`, the `v1` path, and the trailing `/`. For Google Container Registry (GCR), this is `gcr.io`. Based on the information used in [Installing the Tanzu Application Platform package](#)

and profiles, you can use the same registry server as in `ootb_supply_chain_basic - registry - server`.

2. Add a placeholder secret for gathering the credentials used for pulling container images from the installation of Tanzu Application Platform:

```
cat <<EOF | kubectl -n YOUR-NAMESPACE apply -f -
apiVersion: v1
kind: Secret
metadata:
 name: tap-registry
 annotations:
 secretgen.carvel.dev/image-pull-secret: ""
type: kubernetes.io/dockerconfigjson
data:
 .dockerconfigjson: e30K
EOF
```

With the two secrets created:

- `tap-registry` is a placeholder secret filled indirectly by `secretgen-controller` Tanzu Application Platform credentials set up during the installation of Tanzu Application Platform.
- `registry-credentials` is a secret providing credentials for the registry where application container images are pushed to.

The following section discusses setting up the identity required for the workload.

## ServiceAccount

In a Kubernetes cluster, a ServiceAccount provides a way of representing an actor within the Kubernetes role-based access control (RBAC) system. In the case of a developer namespace, this represents a developer or development team.

You can directly attach secrets to the ServiceAccount through both the `secrets` and `imagePullSecrets` fields. This allows you to provide indirect ways for resources to find credentials without knowing the exact name of the secrets.

```
apiVersion: v1
kind: ServiceAccount
metadata:
 name: default
secrets:
 - name: registry-credentials
 - name: tap-registry
imagePullSecrets:
 - name: registry-credentials
 - name: tap-registry
```



### Important

The ServiceAccount must have the secrets created earlier linked to it. If it does not, services like Tanzu Build Service (used in the supply chain) lack the necessary credentials for pushing the images it builds for that workload.

## RoleBinding

As the supply chain takes action in the cluster on behalf of the users who created the workload, it needs permissions within Kubernetes' RBAC system to do so.

Tanzu Application Platform v1.2 includes two ClusterRoles that describe all of the necessary permissions to grant to the service account:

- `workload` clusterrole, providing the necessary roles for the supply chains to manage the resources prescribed by them.
- `deliverable` clusterrole, providing the roles for deliveries to deploy to the cluster the application Kubernetes objects produced by the supply chain.

To provide those permissions to the identity you created for this workload, bind the `workload` ClusterRole to the ServiceAccount you created above:

```
apiVersion: rbac.authorization.k8s.io/v1
kind: RoleBinding
metadata:
 name: default-permit-workload
roleRef:
 apiGroup: rbac.authorization.k8s.io
 kind: ClusterRole
 name: workload
subjects:
- kind: ServiceAccount
 name: default
```

If this is a Build cluster, and you do not intend to run the application in it, this single RoleBinding is all that's necessary.

If you intend to also deploy the application that's been built, bind to the same ServiceAccount the `deliverable` ClusterRole too:

```
apiVersion: rbac.authorization.k8s.io/v1
kind: RoleBinding
metadata:
 name: default-permit-deliverable
roleRef:
 apiGroup: rbac.authorization.k8s.io
 kind: ClusterRole
 name: deliverable
subjects:
- kind: ServiceAccount
 name: default
```

For more information about authentication and authorization in Tanzu Application Platform, see [Overview of Default roles for Tanzu Application Platform](#).

## Developer workload

With the developer namespace set up with the preceding objects, such as secret, serviceaccount, and rolebinding, you can create the workload object.

To do so, use the `apps` plug-in from the Tanzu CLI:

```
tanzu apps workload create FLAGS WORKLOAD-NAME
```

Where:

- `FLAGS` are the one or more flags you want to include.
- `WORKLOAD-NAME` is the name of the workload you want to target.

Depending on what you are aiming to achieve, you can set different flags. To know more about those (including details about different features of the supply chains), see the following sections:

- [Building from source](#), for more information about different ways of creating a workload where the application is built from source code.
- [Using an existing image](#), for more information about how to use prebuilt images in the supply chains.
- [GitOps vs RegistryOps](#), for a description of the different ways of propagating the deployment configuration through external systems (Git repositories and image registries).
- [Carvel Package Workflow](#), for information about how to configure workloads to output Carvel Packages for delivery through Git repositories.

## Install Out of the Box Supply Chain Basic for Supply Chain Choreographer

This topic shows you how to install the Out of the Box Supply Chain Basic package for Supply Chain Choreographer from the Tanzu Application Platform package repository.



### Note

Follow the steps in this topic if you do not want to use a profile to install Out of the Box Supply Chain Basic. For more information about profiles, see [Components and installation profiles](#).

The Out of the Box Supply Chain Basic package provides the most basic ClusterSupplyChain that brings an application from source code to a deployed instance of it running in a Kubernetes environment.

## Prerequisites

Fulfill the following prerequisites:

- Fulfill the [prerequisites](#) for installing Tanzu Application Platform.
- [Install Supply Chain Choreographer](#).

## Install

To install Out of the Box Supply Chain Basic:

1. Familiarize yourself with the set of values of the package that can be configured by running:

```
tanzu package available get ootb-supply-chain-basic.tanzu.vmware.com/0.7.0 \
 --values-schema \
 -n tap-install
```

For example:

KEY	DESCRIPTION
registry.repository	Name of the repository in the image registry server where the application
registry.server	Name of the registry server where application images should be pushed to
registry.server	Name of the repository in the image registry server where the application images from the workload should be pushed (required).
registry.server	Name of the registry server where application images should be pushed to (required).

<code>gitops.server_address</code>	Default server address to be used for forming Git URLs for pushing
<code>gitops.repository_owner</code>	Default project or user of the repository. Used to create URLs for pushing
<code>gitops.repository_name</code>	Default repository name used for forming Git URLs for pushing
<code>gitops.username</code>	Default user name to be used for the commits produced by the supply chain.
<code>gitops.branch</code>	Default branch to use for pushing Kubernetes configuration files produced by the supply chain.
<code>gitops.commit_message</code>	Default git commit message to write when publishing Kubernetes configuration files produced by the supply chain to git.
<code>gitops.email</code>	Default user email to be used for the commits produced by the supply chain.
<code>gitops.ssh_secret</code>	Name of the default Secret containing SSH credentials to lookup in the developer namespace for the supply chain to fetch source code from and push configuration to.
<code>gitops.commit_strategy</code>	Specification of how commits are made to the branch; directly or through a pull request.
<code>gitops.repository_prefix</code>	DEPRECATED: Use <code>server_address</code> and <code>repository_owner</code> instead.
<code>gitops.pull_request.server_kind</code>	The git source control platform used
<code>gitops.pull_request.commit_branch</code>	The branch to which commits will be made, before opening a pull request
<code>gitops.pull_request.pull_request_title</code>	The title for the pull request
<code>gitops.pull_request.pull_request_body</code>	Any further information to add to the pull request
<code>cluster_builder</code>	Name of the Tanzu Build Service ClusterBuilder

builder to	use by default on image objects managed
by the supply chain.	
service_account	Name of the service account in the names
pace where the Workload	is submitted to utilize for providing re
gistry credentials to	Tanzu Build Service Image objects as wel
l as deploying the	application.
maven.repository.url	The URL of the Maven repository to be us
ed when pulling Maven	artifacts. HTTP is not supported. e.
g.: "https://repo.maven.apache.org/maven"	
maven.repository.secret_name	The name of the Secret resource that con
tains the credentials used	to access the Maven repository.

2. Create a file named `ootb-supply-chain-basic-values.yaml` that specifies the corresponding values to the properties you want to change. For example:

```
registry:
 server: REGISTRY-SERVER
 repository: REGISTRY-REPOSITORY

gitops:
 server_address: https://github.com/
 repository_owner: vmware-tanzu
 branch: main
 username: supplychain
 email: supplychain
 commit_message: supplychain@cluster.local
 ssh_secret: git-ssh
 commit_strategy: direct

maven:
 repository:
 url: https://my-maven-repository/releases
 secret_name: my-maven-repository-credentials

cluster_builder: default
service_account: default
```

3. With the configuration ready, install the package by running:

```
tanzu package install ootb-supply-chain-basic \
 --package ootb-supply-chain-basic.tanzu.vmware.com \
 --version 0.7.0 \
 --namespace tap-install \
 --values-file ootb-supply-chain-basic-values.yaml
```

Example output:

```
\ Installing package 'ootb-supply-chain-basic.tanzu.vmware.com'
| Getting package metadata for 'ootb-supply-chain-basic.tanzu.vmware.com'
| Creating service account 'ootb-supply-chain-basic-tap-install-sa'
| Creating cluster admin role 'ootb-supply-chain-basic-tap-install-cluster-rol
e'
| Creating cluster role binding 'ootb-supply-chain-basic-tap-install-cluster-ro
lebinding'
| Creating secret 'ootb-supply-chain-basic-tap-install-values'
```

```

| Creating package resource
- Waiting for 'PackageInstall' reconciliation for 'ootb-supply-chain-basic'
/ 'PackageInstall' resource install status: Reconciling

Added installed package 'ootb-supply-chain-basic' in namespace 'tap-install'

```

## Out of the Box Supply Chain with Testing for Supply Chain Choreographer

This topic provides an overview of Out of the Box Supply Chain with Testing for Supply Chain Choreographer.

This package contains Cartographer Supply Chains that tie together a series of Kubernetes resources that drive a developer-provided workload from source code to a Kubernetes configuration ready to be deployed to a cluster. It passes the source code forward to image building only if the testing pipeline supplied by the developers runs successfully.

This package includes all the capabilities of the Out of the Box Supply Chain Basic, but adds testing with Tekton.

For workloads that use either source code or prebuilt images, it performs the following:

- Building from source code:
  1. Watching a Git Repository or local directory for changes
  2. Running tests from a developer-provided Tekton pipeline
  3. Building a container image out of the source code with Buildpacks
  4. Applying operator-defined conventions to the container definition
  5. Deploying the application to the same cluster
- Using a prebuilt application image:
  1. Applying operator-defined conventions to the container definition
  2. Creating a deliverable object for deploying the application to a cluster

## Prerequisites

To use this supply chain, ensure:

- Out of the Box Templates is installed.
- Out of the Box Supply Chain With Testing is **installed**.
- Out of the Box Supply Chain With Testing and Scanning is **NOT installed**.
- Developer namespace is configured with the objects per Out of the Box Supply Chain Basic guidance. This supply chain is in addition to the basic one.
- (optionally) Install [Out of the Box Delivery Basic](#), if you are willing to deploy the application to the same cluster as the workload and supply chains.

To verify that you have the right set of supply chains installed (that is, the one with Scanning and *not* the one with testing), run:

```
tanzu apps cluster-supply-chain list
```

NAME	LABEL_SELECTOR
source-test-to-url	apps.tanzu.vmware.com/has-tests=true,apps.tanzu.vmware.com/w



```
orkload-type=web
source-to-url apps.tanzu.vmware.com/workload-type=web
```

If you see `source-test-scan-to-url` in the list, the setup is wrong: you **must not have the `source-test-scan-to-url` installed** at the same time as `source-test-to-url`.

## Developer Namespace

As mentioned in the prerequisites section, this supply chain builds on the previous Out of the Box Supply Chain, so only additions are included here.

To make sure you have configured the namespace correctly, it is important that the namespace has the following objects in it (including the ones marked with ‘*new*’ whose explanation and details are provided below):

- **registries secrets:** Kubernetes secrets of type `kubernetes.io/dockerconfigjson` that contain credentials for pushing and pulling the container images built by the supply chain and the installation of Tanzu Application Platform.  
For more information, see [Out of the Box Supply Chain Basic](#).
- **service account:** The identity to be used for any interaction with the Kubernetes API made by the supply chain  
For more information, see [Out of the Box Supply Chain Basic](#).
- **rolebinding:** Grant to the identity the necessary roles for creating the resources prescribed by the supply chain.  
For more information, see [Out of the Box Supply Chain Basic](#).
- **Tekton pipeline (new):** A pipeline runs whenever the supply chain hits the stage of testing the source code.

Below you will find details about the new objects compared to Out of the Box Supply Chain Basic.

## Updates to the developer Namespace

For source code testing to be present in the supply chain, a Tekton Pipeline must exist in the same namespace as the Workload so that, at the right moment, the Tekton PipelineRun object that gets created to run the tests can reference such developer-provided Pipeline.

So, aside from the objects previously defined in the Out of the Box Supply Chain Basic section, you need to include one more:

- `tekton/Pipeline`: the definition of a series of tasks to run against the source code that has been found by earlier resources in the Supply Chain.

### Tekton/Pipeline

By default, the workload is matched to the corresponding pipeline to run using labels. Pipelines must have the label `apps.tanzu.vmware.com/pipeline: test` at a minimum, but you can add additional labels for granularity. This provides a default match in the event that no other labels are provided. The pipeline expects two parameters:

- `source-url`, an HTTP address where a `.tar.gz` file containing all the source code to be tested can be found
- `source-revision`, the revision of the commit or image reference (in case of `workload.spec.source.image` being set instead of `workload.spec.source.git`)

For example:

```

apiVersion: tekton.dev/v1beta1
kind: Pipeline
metadata:
 name: developer-defined-tekton-pipeline
 labels:
 apps.tanzu.vmware.com/pipeline: test # (!) required
spec:
 params:
 - name: source-url # (!) required
 - name: source-revision # (!) required
 tasks:
 - name: test
 params:
 - name: source-url
 value: $(params.source-url)
 - name: source-revision
 value: $(params.source-revision)
 taskSpec:
 params:
 - name: source-url
 - name: source-revision
 steps:
 - name: test
 image: gradle
 script: |-
 cd `mktemp -d`
 wget -qO- $(params.source-url) | tar xvz -m
 ./mvnw test

```

At this point, changes to the developer-provided Tekton Pipeline do not automatically trigger a re-run of the pipeline. That is, a new Tekton PipelineRun is not automatically created if a field in the Pipeline object is changed. As a workaround, the latest PipelineRun created can be deleted, which triggers a re-run.

### Allow multiple Tekton pipelines in a namespace

You can configure your developer namespace to include more than one pipeline using either of the following methods:

- Use a single pipeline running on a container image that includes testing tools and runs a common script to execute tests. This allows you to accommodate multiple workloads based in different languages in the same namespace that use a common make test script, as shown in the following example:

```

apiVersion: tekton.dev/v1beta1
kind: Pipeline
metadata:
 name: developer-defined-tekton-pipeline
 labels:
 apps.tanzu.vmware.com/pipeline: test
spec:
 #...
 steps:
 - name: test
 image: <image_that_has_JDK_and_Go>
 script: |-
 cd `mktemp -d`
 wget -qO- $(params.source-url) | tar xvz -m
 make test

```

- Update the pipeline resources to include labels that differentiate between the pipelines. For example, differentiate between Java and Go pipelines by adding labels for Java and Go:

```

apiVersion: tekton.dev/v1beta1
kind: Pipeline
metadata:
 name: java-tests
 labels:
 apps.tanzu.vmware.com/pipeline: test
 apps.tanzu.vmware.com/language: java
spec:
 #...
 steps:
 - name: test
 image: gradle
 script: |-
 # ...
 ./mvnw test

apiVersion: tekton.dev/v1beta1
kind: Pipeline
metadata:
 name: go-tests
 labels:
 apps.tanzu.vmware.com/pipeline: test
 apps.tanzu.vmware.com/language: go
spec:
 #...
 steps:
 - name: test
 image: golang
 script: |-
 # ...
 go test -v ./...

```

To match the correct pipeline, you add a `testing_pipeline_matching_labels` parameter to the workload. For example, if you want to match to the Java pipeline, you have the following `workload.yaml`:

```

apiVersion: carto.run/v1alpha1
kind: Workload
metadata:
 name: sample-java-app
 labels:
 apps.tanzu.vmware.com/has-tests: true
 apps.tanzu.vmware.com/workload-type: web
 app.kubernetes.io/part-of: sample-java-app
spec:
 params:
 - name: testing_pipeline_matching_labels
 value:
 apps.tanzu.vmware.com/pipeline: test
 apps.tanzu.vmware.com/language: java
 ...

```

This matches the workload to the pipeline with the `apps.tanzu.vmware.com/language: java` label.

## Developer Workload

With the Tekton Pipeline object submitted to the same namespace as the one where the Workload will be submitted to, you can submit your Workload.

Regardless of the workflow being targeted (local development or gitops), the Workload configuration details are the same as in Out of the Box Supply Chain Basic, except that you mark the workload with tests enabled by means of the `has-tests` label.

For example:

```
tanzu apps workload create tanzu-java-web-app \
--git-branch main \
--git-repo https://github.com/vmware-tanzu/application-accelerator-samples \
--sub-path tanzu-java-web-app \
--label apps.tanzu.vmware.com/has-tests=true \
--label app.kubernetes.io/part-of=tanzu-java-web-app \
--type web
```

```
Create workload:
 1 + |---
 2 + |apiVersion: carto.run/v1alpha1
 3 + |kind: Workload
 4 + |metadata:
 5 + | labels:
 6 + | apps.tanzu.vmware.com/workload-type: web
 7 + | apps.tanzu.vmware.com/has-tests: "true"
 8 + | app.kubernetes.io/part-of: tanzu-java-web-app
 9 + | name: tanzu-java-web-app
10 + | namespace: default
11 + |spec:
12 + | source:
13 + | git:
14 + | ref:
15 + | branch: main
16 + | url: https://github.com/vmware-tanzu/application-accelerator-samples
17 + | subPath: tanzu-java-web-app
```

## Out of the Box Supply Chain with Testing for Supply Chain Choreographer

This topic provides an overview of Out of the Box Supply Chain with Testing for Supply Chain Choreographer.

This package contains Cartographer Supply Chains that tie together a series of Kubernetes resources that drive a developer-provided workload from source code to a Kubernetes configuration ready to be deployed to a cluster. It passes the source code forward to image building only if the testing pipeline supplied by the developers runs successfully.

This package includes all the capabilities of the Out of the Box Supply Chain Basic, but adds testing with Tekton.

For workloads that use either source code or prebuilt images, it performs the following:

- Building from source code:
  1. Watching a Git Repository or local directory for changes
  2. Running tests from a developer-provided Tekton pipeline
  3. Building a container image out of the source code with Buildpacks
  4. Applying operator-defined conventions to the container definition
  5. Deploying the application to the same cluster
- Using a prebuilt application image:
  1. Applying operator-defined conventions to the container definition
  2. Creating a deliverable object for deploying the application to a cluster

## Prerequisites

To use this supply chain, ensure:

- Out of the Box Templates is installed.
- Out of the Box Supply Chain With Testing is **installed**.
- Out of the Box Supply Chain With Testing and Scanning is **NOT installed**.
- Developer namespace is configured with the objects per Out of the Box Supply Chain Basic guidance. This supply chain is in addition to the basic one.
- (optionally) Install [Out of the Box Delivery Basic](#), if you are willing to deploy the application to the same cluster as the workload and supply chains.

To verify that you have the right set of supply chains installed (that is, the one with Scanning and *not* the one with testing), run:

```
tanzu apps cluster-supply-chain list
```

NAME	LABEL_SELECTOR
source-test-to-url	apps.tanzu.vmware.com/has-tests=true,apps.tanzu.vmware.com/workload-type=web
source-to-url	apps.tanzu.vmware.com/workload-type=web

If you see `source-test-scan-to-url` in the list, the setup is wrong: you **must not have the `source-test-scan-to-url` installed** at the same time as `source-test-to-url`.

## Developer Namespace

As mentioned in the prerequisites section, this supply chain builds on the previous Out of the Box Supply Chain, so only additions are included here.

To make sure you have configured the namespace correctly, it is important that the namespace has the following objects in it (including the ones marked with *'new'* whose explanation and details are provided below):

- **registries secrets:** Kubernetes secrets of type `kubernetes.io/dockerconfigjson` that contain credentials for pushing and pulling the container images built by the supply chain and the installation of Tanzu Application Platform.  
For more information, see [Out of the Box Supply Chain Basic](#).
- **service account:** The identity to be used for any interaction with the Kubernetes API made by the supply chain  
For more information, see [Out of the Box Supply Chain Basic](#).
- **rolebinding:** Grant to the identity the necessary roles for creating the resources prescribed by the supply chain.  
For more information, see [Out of the Box Supply Chain Basic](#).
- **Tekton pipeline (new):** A pipeline runs whenever the supply chain hits the stage of testing the source code.

Below you will find details about the new objects compared to Out of the Box Supply Chain Basic.

## Updates to the developer Namespace

For source code testing to be present in the supply chain, a Tekton Pipeline must exist in the same namespace as the Workload so that, at the right moment, the Tekton PipelineRun object that gets created to run the tests can reference such developer-provided Pipeline.

So, aside from the objects previously defined in the Out of the Box Supply Chain Basic section, you need to include one more:

- `tekton/Pipeline`: the definition of a series of tasks to run against the source code that has been found by earlier resources in the Supply Chain.

## Tekton/Pipeline

By default, the workload is matched to the corresponding pipeline to run using labels. Pipelines must have the label `apps.tanzu.vmware.com/pipeline: test` at a minimum, but you can add additional labels for granularity. This provides a default match in the event that no other labels are provided. The pipeline expects two parameters:

- `source-url`, an HTTP address where a `.tar.gz` file containing all the source code to be tested can be found
- `source-revision`, the revision of the commit or image reference (in case of `workload.spec.source.image` being set instead of `workload.spec.source.git`)

For example:

```
apiVersion: tekton.dev/v1beta1
kind: Pipeline
metadata:
 name: developer-defined-tekton-pipeline
 labels:
 apps.tanzu.vmware.com/pipeline: test # (!) required
spec:
 params:
 - name: source-url # (!) required
 - name: source-revision # (!) required
 tasks:
 - name: test
 params:
 - name: source-url
 value: $(params.source-url)
 - name: source-revision
 value: $(params.source-revision)
 taskSpec:
 params:
 - name: source-url
 - name: source-revision
 steps:
 - name: test
 image: gradle
 script: |-
 cd `mktemp -d`
 wget -qO- $(params.source-url) | tar xvz -m
 ./mvnw test
```

At this point, changes to the developer-provided Tekton Pipeline do not automatically trigger a re-run of the pipeline. That is, a new Tekton PipelineRun is not automatically created if a field in the Pipeline object is changed. As a workaround, the latest PipelineRun created can be deleted, which triggers a re-run.

## Allow multiple Tekton pipelines in a namespace

You can configure your developer namespace to include more than one pipeline using either of the following methods:

- Use a single pipeline running on a container image that includes testing tools and runs a common script to execute tests. This allows you to accommodate multiple workloads based

in different languages in the same namespace that use a common make test script, as shown in the following example:

```
apiVersion: tekton.dev/v1beta1
kind: Pipeline
metadata:
 name: developer-defined-tekton-pipeline
 labels:
 apps.tanzu.vmware.com/pipeline: test
spec:
 #...
 steps:
 - name: test
 image: <image_that_has_JDK_and_Go>
 script: |-
 cd `mktemp -d`
 wget -qO- $(params.source-url) | tar xvz -m
 make test
```

- Update the pipeline resources to include labels that differentiate between the pipelines. For example, differentiate between Java and Go pipelines by adding labels for Java and Go:

```
apiVersion: tekton.dev/v1beta1
kind: Pipeline
metadata:
 name: java-tests
 labels:
 apps.tanzu.vmware.com/pipeline: test
 apps.tanzu.vmware.com/language: java
spec:
 #...
 steps:
 - name: test
 image: gradle
 script: |-
 # ...
 ./mvnw test

apiVersion: tekton.dev/v1beta1
kind: Pipeline
metadata:
 name: go-tests
 labels:
 apps.tanzu.vmware.com/pipeline: test
 apps.tanzu.vmware.com/language: go
spec:
 #...
 steps:
 - name: test
 image: golang
 script: |-
 # ...
 go test -v ./...
```

To match the correct pipeline, you add a `testing_pipeline_matching_labels` parameter to the workload. For example, if you want to match to the Java pipeline, you have the following `workload.yaml`:

```
apiVersion: carto.run/v1alpha1
kind: Workload
metadata:
 name: sample-java-app
 labels:
 apps.tanzu.vmware.com/has-tests: true
```

```

apps.tanzu.vmware.com/workload-type: web
app.kubernetes.io/part-of: sample-java-app
spec:
 params:
 - name: testing_pipeline_matching_labels
 value:
 apps.tanzu.vmware.com/pipeline: test
 apps.tanzu.vmware.com/language: java
 ...

```

This matches the workload to the pipeline with the `apps.tanzu.vmware.com/language: java` label.

## Developer Workload

With the Tekton Pipeline object submitted to the same namespace as the one where the Workload will be submitted to, you can submit your Workload.

Regardless of the workflow being targeted (local development or gitops), the Workload configuration details are the same as in Out of the Box Supply Chain Basic, except that you mark the workload with tests enabled by means of the `has-tests` label.

For example:

```

tanzu apps workload create tanzu-java-web-app \
--git-branch main \
--git-repo https://github.com/vmware-tanzu/application-accelerator-samples \
--sub-path tanzu-java-web-app \
--label apps.tanzu.vmware.com/has-tests=true \
--label app.kubernetes.io/part-of=tanzu-java-web-app \
--type web

```

```

Create workload:
 1 + |---
 2 + |apiVersion: carto.run/v1alpha1
 3 + |kind: Workload
 4 + |metadata:
 5 + | labels:
 6 + | apps.tanzu.vmware.com/workload-type: web
 7 + | apps.tanzu.vmware.com/has-tests: "true"
 8 + | app.kubernetes.io/part-of: tanzu-java-web-app
 9 + | name: tanzu-java-web-app
10 + | namespace: default
11 + |spec:
12 + | source:
13 + | git:
14 + | ref:
15 + | branch: main
16 + | url: https://github.com/vmware-tanzu/application-accelerator-samples
17 + | subPath: tanzu-java-web-app

```

## Install Out of the Box Supply Chain with Testing for Supply Chain Choreographer

This topic describes how you can install Out of the Box Supply Chain with Testing for Supply Chain Choreographer from the Tanzu Application Platform package repository.



### Note

Follow the steps in this topic if you do not want to use a profile to install Out of the Box Supply Chain with Testing. For more information about profiles, see



## Components and installation profiles.

The Out of the Box Supply Chain with Testing package provides a ClusterSupplyChain that brings an application from source code to a deployed instance that:

- Runs in a Kubernetes environment.
- Runs developer-provided tests in the form of Tekton/Pipeline objects to validate the source code before building container images.

## Prerequisites

Before installing Out of the Box Supply Chain with Testing:

- Complete all prerequisites to install Tanzu Application Platform. For more information, see [Prerequisites](#).
- Install cartographer. For more information, see [Install Supply Chain Choreographer](#).
- Install [Out of the Box Delivery Basic](#)
- Install [Out of the Box Templates](#)

## Install

Install by following these steps:

1. Ensure you do not have Out of the Box Supply Chain With Testing and Scanning ([ootb-supply-chain-testing-scanning.tanzu.vmware.com](https://ootb-supply-chain-testing-scanning.tanzu.vmware.com)) installed:

1. Run the following command:

```
tanzu package installed list --namespace tap-install
```

2. Verify [ootb-supply-chain-testing-scanning](https://ootb-supply-chain-testing-scanning.tanzu.vmware.com) is in the output:

NAME	PACKAGE-NAME
ootb-delivery-basic	ootb-delivery-basic.tanzu.vmware.com
ootb-supply-chain-basic	ootb-supply-chain-basic.tanzu.vmware.com
ootb-templates	ootb-templates.tanzu.vmware.com

3. If you see [ootb-supply-chain-testing-scanning](https://ootb-supply-chain-testing-scanning.tanzu.vmware.com) in the list, uninstall it by running:

```
tanzu package installed delete ootb-supply-chain-testing-scanning --namespace tap-install
```

Example output:

```
Deleting installed package 'ootb-supply-chain-testing-scanning' in namespace 'tap-install'.
Are you sure? [y/N]: y

| Uninstalling package 'ootb-supply-chain-testing-scanning' from namespace 'tap-install'
\ Getting package install for 'ootb-supply-chain-testing-scanning'
- Deleting package install 'ootb-supply-chain-testing-scanning' from namespace 'tap-install'
| Deleting admin role 'ootb-supply-chain-testing-scanning-tap-install-cluster-role'
| Deleting role binding 'ootb-supply-chain-testing-scanning-tap-install-cluster-rolebinding'
```

```
| Deleting secret 'ootb-supply-chain-testing-scanning-tap-install-values'
| Deleting service account 'ootb-supply-chain-testing-scanning-tap-install-sa'

Uninstalled package 'ootb-supply-chain-testing-scanning' from namespace
'tap-install'
```

2. Verify that the values of the package can be configured by referencing the values below:

KEY	DESCRIPTION
registry.repository	Name of the repository in the image registry server where the application images from the workload should be pushed (required).
registry.server	Name of the registry server where application images should be pushed to (required).
gitops.server_address	Default server address to be used for forming Git URLs for pushing Kubernetes configuration produced by the supply chain. This must include the scheme/protocol (e.g. https:// or ssh://)
gitops.repository_owner	Default project or user of the repository. Used to create URLs for pushing Kubernetes configuration produced by the supply chain.
gitops.repository_name	Default repository name used for forming Git URLs for pushing Kubernetes configuration produced by the supply chain.
gitops.username	Default user name to be used for the commits produced by the supply chain.
gitops.branch	Default branch to use for pushing Kubernetes configuration files produced by the supply chain.
gitops.commit_message	Default git commit message to write when publishing Kubernetes configuration files produced by the supply chain to git.
gitops.email	Default user email to be used for the commits produced by the supply chain.
gitops.ssh_secret	Name of the default Secret containing SSH credentials to lookup in the developer namespace for the supply chain to fetch source code from and push configuration to.
gitops.commit_strategy	Specification of how commits are made to the branch; directly or through a pull request.
gitops.repository_prefix	DEPRECATED: Use server_address and repository_owner instead.
gitops.repository_owner	Default prefix to be used for forming Git SSH URLs for pushing Kubernetes

in.	configuration produced by the supply chain.
gitops.pull_request.server_kind	The git source control platform used
gitops.pull_request.commit_branch	The branch to which commits will be made, before opening a pull request
h If the string "" is specified,	to the branch specified in .gitops.branch
d for the branch name, in order	an essentially random string will be used for the branch name, in order
	to prevent collisions.
gitops.pull_request.pull_request_title	The title for the pull request
gitops.pull_request.pull_request_body	Any further information to add to the pull request
cluster_builder	Name of the Tanzu Build Service ClusterBuilder to use by default on image objects managed by the supply chain.
service_account	Name of the service account in the namespace where the Workload
	is submitted to utilize for providing registry credentials to
	Tanzu Build Service Image objects as well as deploying the
	application.

3. Create a file named `ootb-supply-chain-testing-values.yaml` that specifies the corresponding values to the properties you want to change. For example:

```
registry:
 server: REGISTRY-SERVER
 repository: REGISTRY-REPOSITORY

gitops:
 server_address: https://github.com/
 repository_owner: vmware-tanzu
 branch: main
 username: supplychain
 email: supplychain
 commit_message: supplychain@cluster.local
 ssh_secret: git-ssh
 commit_strategy: direct

cluster_builder: default
service_account: default
```

4. With the configuration ready, install the package by running:

```
tanzu package install ootb-supply-chain-testing \
 --package ootb-supply-chain-testing.tanzu.vmware.com \
 --version 0.7.0 \
 --namespace tap-install \
 --values-file ootb-supply-chain-testing-values.yaml
```

Example output:

```
\ Installing package 'ootb-supply-chain-testing.tanzu.vmware.com'
| Getting package metadata for 'ootb-supply-chain-testing.tanzu.vmware.com'
| Creating service account 'ootb-supply-chain-testing-tap-install-sa'
| Creating cluster admin role 'ootb-supply-chain-testing-tap-install-cluster-ro
```

```
le'
| Creating cluster role binding 'ootb-supply-chain-testing-tap-install-cluster-
rolebinding'
| Creating secret 'ootb-supply-chain-testing-tap-install-values'
| Creating package resource
- Waiting for 'PackageInstall' reconciliation for 'ootb-supply-chain-testing'
\ 'PackageInstall' resource install status: Reconciling

Added installed package 'ootb-supply-chain-testing' in namespace 'tap-install'
```

## Out of the Box Supply Chain with Testing and Scanning for Supply Chain Choreographer

This topic provides an overview of Out of the Box Supply Chain with Testing and Scanning for Supply Chain Choreographer.

This package contains Cartographer Supply Chains that tie together a series of Kubernetes resources that drive a developer-provided workload from source code to a Kubernetes configuration ready to be deployed to a cluster. It contains supply chains that pass the source code through testing and vulnerability scanning, and also the container image.

This package includes all the capabilities of the Out of the Box Supply Chain With Testing, but adds source and image scanning using Grype.

Workloads that use source code or prebuilt images perform the following:

- Building from source code:
  1. Watching a Git Repository or local directory for changes
  2. Running tests from a developer-provided Tekton pipeline
  3. Scanning the source code for known vulnerabilities using Grype
  4. Building a container image out of the source code with Buildpacks
  5. Scanning the image for known vulnerabilities
  6. Applying operator-defined conventions to the container definition
  7. Deploying the application to the same cluster
- Using a prebuilt application image:
  1. Scanning the image for known vulnerabilities
  2. Applying operator-defined conventions to the container definition
  3. Creating a deliverable object for deploying the application to a cluster

## Prerequisites

To use this supply chain, verify that:

- Out of the Box Templates is installed.
- Out of the Box Supply Chain With Testing is **NOT installed**.
- Out of the Box Supply Chain With Testing and Scanning is **installed**.
- Developer namespace is configured with the objects according to Out of the Box Supply Chain With Testing guidance. This supply chain is in addition to the Supply Chain with testing.
- (Optionally) install [Out of the Box Delivery Basic](#), if you are willing to deploy the application to the same cluster as the workload and supply chains.

Verify that you have the supply chains with scanning, not with testing, installed by running:

```
tanzu apps cluster-supply-chain list
```

NAME	LABEL SELECTOR
source-test-scan-to-url	apps.tanzu.vmware.com/has-tests=true,apps.tanzu.vmware.com/workload-type=web
source-to-url	apps.tanzu.vmware.com/workload-type=web

If you see `source-test-to-url` in the list, the setup is wrong. You must not have the `source-test-to-url` installed at the same time as `source-test-scan-to-url`.

## Developer namespace

This example builds on the previous Out of the Box Supply Chain examples, so only additions are included here.

To ensure that you configured the namespace correctly, it is important that the namespace has the objects that you configured in the other supply chain setups:

- **registries secrets:** Kubernetes secrets of type `kubernetes.io/dockerconfigjson` that contain credentials for pushing and pulling the container images built by the supply chain and the installation of Tanzu Application Platform.
- **service account:** The identity to be used for any interaction with the Kubernetes API made by the supply chain.
- **rolebinding:** Grant to the identity the necessary roles for creating the resources prescribed by the supply chain.

For more information about the preceding objects, see [Out of the Box Supply Chain Basic](#).

- **Tekton pipeline:** A pipeline runs whenever the supply chain hits the stage of testing the source code.

For more information, see [Out of the Box Supply Chain Testing](#).

And the new objects, that you create here:

- **scan policy:** Defines what to do with the results taken from scanning the source code and image produced. For more information, see [ScanPolicy section](#).
- **source scan template:** A template of how TaskRuns are created for scanning the source code. See [ScanTemplate section](#).
- **image scan template:** A template of how TaskRuns are created for scanning the image produced by the supply chain. See [ScanTemplate section](#).

The following section includes details about the new objects, compared to Out of the Box Supply Chain With Testing.

## Updates to the developer namespace

For source and image scans, scan templates and scan policies must exist in the same namespace as the workload. These define:

- `ScanTemplate`: how to run a scan, allowing one to change details about the execution of the scan (either for images or source code)
- `ScanPolicy`: how to evaluate whether the artifacts scanned are compliant. For example, allowing one to be either very strict, or restrictive about particular vulnerabilities found.

The names of the objects must match the names in the example with default installation configurations. This is overridden either by using the `ootb_supply_chain_testing_scanning` package configuration in the `tap-values.yaml` file or by using workload parameters:

- To override by using the `ootb_supply_chain_testing_scanning` package configuration, make the following modification to your `tap-values.yaml` file and perform a [Tanzu Application Platform update](#).

```
ootb_supply_chain_testing_scanning:
 scanning:
 source:
 policy: SCAN-POLICY
 template: SCAN-TEMPLATE
 image:
 policy: SCAN-POLICY
 template: SCAN-TEMPLATE
```

Where `SCAN-POLICY` and `SCAN-TEMPLATE` are the names of the `ScanPolicy` and `ScanTemplate`.

- To override through workload parameters, use the following commands. For more information, see [Tanzu apps workload apply](#).

```
tanzu apps workload apply WORKLOAD --param "scanning_source_policy=SCAN-POLICY"
-n DEV-NAMESPACE
tanzu apps workload apply WORKLOAD --param "scanning_source_template=SCAN-TEMPL
ATE" -n DEV-NAMESPACE
```

Where:

- `WORKLOAD` is the name of the workload.
- `SCAN-POLICY` and `SCAN-TEMPLATE` are the names of the `ScanPolicy` and `ScanTemplate`.
- `DEV-NAMESPACE` is the developer namespace.

## ScanPolicy

The `ScanPolicy` defines a set of rules to evaluate for a particular scan to consider the artifacts (image or source code) either compliant or not.

When a `ImageScan` or `SourceScan` is created to run a scan, those reference a policy whose name must match the following sample `scan-policy`:

```

apiVersion: scanning.apps.tanzu.vmware.com/v1beta1
kind: ScanPolicy
metadata:
 name: scan-policy
 labels:
 'app.kubernetes.io/part-of': 'enable-in-gui'
spec:
 regoFile: |
 package main

 # Accepted Values: "Critical", "High", "Medium", "Low", "Negligible", "UnknownSeverity"
 notAllowedSeverities := ["Critical", "High", "UnknownSeverity"]
 ignoreCves := []

 contains(array, elem) = true {
 array[_] = elem
 } else = false { true }

 isSafe(match) {
```

```

 severities := { e | e := match.ratings.rating.severity } | { e | e := match.rati
ngs.rating[_].severity }
 some i
 fails := contains(notAllowedSeverities, severities[i])
 not fails
 }

 isSafe(match) {
 ignore := contains(ignoreCves, match.id)
 ignore
 }

 deny[msg] {
 comps := { e | e := input.bom.components.component } | { e | e := input.bom.comp
onents.component[_] }
 some i
 comp := comps[i]
 vulns := { e | e := comp.vulnerabilities.vulnerability } | { e | e := comp.vulne
rabilities.vulnerability[_] }
 some j
 vuln := vulns[j]
 ratings := { e | e := vuln.ratings.rating.severity } | { e | e := vuln.ratings.r
ating[_].severity }
 not isSafe(vuln)
 msg = sprintf("CVE %s %s %s", [comp.name, vuln.id, ratings])
 }

```

See [Writing Policy Templates](#).

## ScanTemplate

A ScanTemplate defines the PodTemplateSpec used by a TaskRun to run a particular scan (image or source). When the supply chain initiates an ImageScan or SourceScan, they reference these templates which must live in the same namespace as the workload with the names matching the following:

- source scanning ([blob-source-scan-template](#))
- image scanning ([private-image-scan-template](#))

If you are targeting a namespace that does not match the one configured in the Tanzu Application Platform profiles, for example, if `grype.namespace` is not the same as the one you are writing the workload to, you can install these in such namespace by making use of the `tanzu package install` command as described in [Install Supply Chain Security Tools - Scan](#):

1. Create a file named `ootb-supply-chain-basic-values.yaml` that specifies the corresponding values to the properties you want to change. For example:

```

grype:
 namespace: YOUR-DEV-NAMESPACE
 targetImagePullSecret: registry-credentials

```

2. With the configuration ready, install the templates by running:

```

tanzu package install grype-scanner \
 --package grype.scanning.apps.tanzu.vmware.com \
 --version 1.0.0 \
 --namespace YOUR-DEV-NAMESPACE

```



### Note

Although you can customize the templates, if you are following the Getting Started guide, VMware recommends that you follow what is provided in the installation of `grype.scanning.apps.tanzu.vmware.com`. This is created in the same namespace as configured by using `grype.namespace` in either Tanzu Application Platform profiles or individual component installation as in the earlier example. For more information, see [About Source and Image Scans](#).

### Enable storing scan results

To enable SCST - Scan to store scan results by using SCST - Store, see [Developer namespace setup](#) for exporting the SCST - Store CA certificate and authentication token to the developer namespace.

### Allow multiple Tekton pipelines in a namespace

You can configure your developer namespace to include more than one pipeline using either of the following methods:

- Use a single pipeline running on a container image that includes testing tools and runs a common script to execute tests. This allows you to accommodate multiple workloads based in different languages in the same namespace that use a common make test script, as shown in the following example:

```
apiVersion: tekton.dev/v1beta1
kind: Pipeline
metadata:
 name: developer-defined-tekton-pipeline
 labels:
 apps.tanzu.vmware.com/pipeline: test
spec:
 #...
 steps:
 - name: test
 image: <image_that_has_JDK_and_Go>
 script: |-
 cd `mktemp -d`
 wget -qO- $(params.source-url) | tar xvz -m
 make test
```

- Update the pipeline resources to include labels that differentiate between the pipelines. For example, differentiate between Java and Go pipelines by adding labels for Java and Go:

```
apiVersion: tekton.dev/v1beta1
kind: Pipeline
metadata:
 name: java-tests
 labels:
 apps.tanzu.vmware.com/pipeline: test
 apps.tanzu.vmware.com/language: java
spec:
 #...
 steps:
 - name: test
 image: gradle
 script: |-
 # ...
 ./mvnw test

apiVersion: tekton.dev/v1beta1
kind: Pipeline
```



```

metadata:
 name: go-tests
 labels:
 apps.tanzu.vmware.com/pipeline: test
 apps.tanzu.vmware.com/language: go
spec:
 #...
 steps:
 - name: test
 image: golang
 script: |-
 # ...
 go test -v ./...

```

To match the correct pipeline, you add a `testing_pipeline_matching_labels` parameter to the workload. For example, if you want to match to the Java pipeline, you have the following `workload.yaml`:

```

apiVersion: carto.run/v1alpha1
kind: Workload
metadata:
 name: sample-java-app
 labels:
 apps.tanzu.vmware.com/has-tests: true
 apps.tanzu.vmware.com/workload-type: web
 app.kubernetes.io/part-of: sample-java-app
spec:
 params:
 - name: testing_pipeline_matching_labels
 value:
 apps.tanzu.vmware.com/pipeline: test
 apps.tanzu.vmware.com/language: java
 ...

```

This matches the workload to the pipeline with the `apps.tanzu.vmware.com/language: java` label.

## Developer workload

With the ScanPolicy and ScanTemplate objects, with the required names set, submitted to the same namespace where the workload is submitted, you are ready to submit your workload.

Regardless of the workflow being targeted, such as local development or GitOps, the workload configuration details are the same as in Out of the Box Supply Chain Basic, except that you mark the workload as having tests enabled.

For example:

```

tanzu apps workload create tanzu-java-web-app \
 --git-branch main \
 --git-repo https://github.com/vmware-tanzu/application-accelerator-samples \
 --sub-path tanzu-java-web-app \
 --label apps.tanzu.vmware.com/has-tests=true \
 --label app.kubernetes.io/part-of=tanzu-java-web-app \
 --type web

```

```

Create workload:
1 + |---
2 + |apiVersion: carto.run/v1alpha1
3 + |kind: Workload
4 + |metadata:
5 + | labels:
6 + | apps.tanzu.vmware.com/workload-type: web
7 + | apps.tanzu.vmware.com/has-tests: "true"

```

```

8 + | app.kubernetes.io/part-of: tanzu-java-web-app
9 + | name: tanzu-java-web-app
10 + | namespace: default
11 + | spec:
12 + | source:
13 + | git:
14 + | ref:
15 + | branch: main
16 + | url: https://github.com/vmware-tanzu/application-accelerator-samples
17 + | subPath: tanzu-java-web-app

```

## CVE triage workflow

The Supply Chain halts progression if either a SourceScan ([sourcescans.scanning.apps.tanzu.vmware.com](https://sourcescans.scanning.apps.tanzu.vmware.com)) or an ImageScan ([imagescans.scanning.apps.tanzu.vmware.com](https://imagescans.scanning.apps.tanzu.vmware.com)) fails policy enforcement through the [ScanPolicy](https://scanpolicies.scanning.apps.tanzu.vmware.com) ([scanpolicies.scanning.apps.tanzu.vmware.com](https://scanpolicies.scanning.apps.tanzu.vmware.com)).

This can prevent source code from building or images deploying that contain vulnerabilities that are in violation of the user-defined scan policy. For information about learning how to handle these vulnerabilities and unblock your Supply Chain, see [Triaging and Remediating CVEs](#).

## Scan Images using a different scanner

[Supply Chain Security Tools - Scan](#) includes additional integrations for running an image scan using Snyk and VMware Carbon Black.

## Out of the Box Supply Chain with Testing and Scanning for Supply Chain Choreographer

This topic provides an overview of Out of the Box Supply Chain with Testing and Scanning for Supply Chain Choreographer.

This package contains Cartographer Supply Chains that tie together a series of Kubernetes resources that drive a developer-provided workload from source code to a Kubernetes configuration ready to be deployed to a cluster. It contains supply chains that pass the source code through testing and vulnerability scanning, and also the container image.

This package includes all the capabilities of the Out of the Box Supply Chain With Testing, but adds source and image scanning using Grype.

Workloads that use source code or prebuilt images perform the following:

- Building from source code:
  1. Watching a Git Repository or local directory for changes
  2. Running tests from a developer-provided Tekton pipeline
  3. Scanning the source code for known vulnerabilities using Grype
  4. Building a container image out of the source code with Buildpacks
  5. Scanning the image for known vulnerabilities
  6. Applying operator-defined conventions to the container definition
  7. Deploying the application to the same cluster
- Using a prebuilt application image:
  1. Scanning the image for known vulnerabilities

2. Applying operator-defined conventions to the container definition
3. Creating a deliverable object for deploying the application to a cluster

## Prerequisites

To use this supply chain, verify that:

- Out of the Box Templates is installed.
- Out of the Box Supply Chain With Testing is **NOT installed**.
- Out of the Box Supply Chain With Testing and Scanning is **installed**.
- Developer namespace is configured with the objects according to Out of the Box Supply Chain With Testing guidance. This supply chain is in addition to the Supply Chain with testing.
- (Optionally) install [Out of the Box Delivery Basic](#), if you are willing to deploy the application to the same cluster as the workload and supply chains.

Verify that you have the supply chains with scanning, not with testing, installed by running:

```
tanzu apps cluster-supply-chain list
```

NAME	LABEL_SELECTOR
source-test-scan-to-url	apps.tanzu.vmware.com/has-tests=true,apps.tanzu.vmware.com/workload-type=web
source-to-url	apps.tanzu.vmware.com/workload-type=web

If you see `source-test-to-url` in the list, the setup is wrong. You must not have the `source-test-to-url` installed at the same time as `source-test-scan-to-url`.

## Developer namespace

This example builds on the previous Out of the Box Supply Chain examples, so only additions are included here.

To ensure that you configured the namespace correctly, it is important that the namespace has the objects that you configured in the other supply chain setups:

- **registries secrets:** Kubernetes secrets of type `kubernetes.io/dockerconfigjson` that contain credentials for pushing and pulling the container images built by the supply chain and the installation of Tanzu Application Platform.
- **service account:** The identity to be used for any interaction with the Kubernetes API made by the supply chain.
- **rolebinding:** Grant to the identity the necessary roles for creating the resources prescribed by the supply chain.

For more information about the preceding objects, see [Out of the Box Supply Chain Basic](#).

- **Tekton pipeline:** A pipeline runs whenever the supply chain hits the stage of testing the source code.

For more information, see [Out of the Box Supply Chain Testing](#).

And the new objects, that you create here:

- **scan policy:** Defines what to do with the results taken from scanning the source code and image produced. For more information, see [ScanPolicy section](#).

- **source scan template:** A template of how TaskRuns are created for scanning the source code. See [ScanTemplate section](#).
- **image scan template:** A template of how TaskRuns are created for scanning the image produced by the supply chain. See [ScanTemplate section](#).

The following section includes details about the new objects, compared to Out of the Box Supply Chain With Testing.

## Updates to the developer namespace

For source and image scans, scan templates and scan policies must exist in the same namespace as the workload. These define:

- **ScanTemplate:** how to run a scan, allowing one to change details about the execution of the scan (either for images or source code)
- **ScanPolicy:** how to evaluate whether the artifacts scanned are compliant. For example, allowing one to be either very strict, or restrictive about particular vulnerabilities found.

The names of the objects must match the names in the example with default installation configurations. This is overridden either by using the `ootb_supply_chain_testing_scanning` package configuration in the `tap-values.yaml` file or by using workload parameters:

- To override by using the `ootb_supply_chain_testing_scanning` package configuration, make the following modification to your `tap-values.yaml` file and perform a [Tanzu Application Platform update](#).

```
ootb_supply_chain_testing_scanning:
 scanning:
 source:
 policy: SCAN-POLICY
 template: SCAN-TEMPLATE
 image:
 policy: SCAN-POLICY
 template: SCAN-TEMPLATE
```

Where `SCAN-POLICY` and `SCAN-TEMPLATE` are the names of the `ScanPolicy` and `ScanTemplate`.

- To override through workload parameters, use the following commands. For more information, see [Tanzu apps workload apply](#).

```
tanzu apps workload apply WORKLOAD --param "scanning_source_policy=SCAN-POLICY"
-n DEV-NAMESPACE
tanzu apps workload apply WORKLOAD --param "scanning_source_template=SCAN-TEMPL
ATE" -n DEV-NAMESPACE
```

Where:

- `WORKLOAD` is the name of the workload.
- `SCAN-POLICY` and `SCAN-TEMPLATE` are the names of the `ScanPolicy` and `ScanTemplate`.
- `DEV-NAMESPACE` is the developer namespace.

### ScanPolicy

The `ScanPolicy` defines a set of rules to evaluate for a particular scan to consider the artifacts (image or source code) either compliant or not.

When a `ImageScan` or `SourceScan` is created to run a scan, those reference a policy whose name must match the following sample `scan-policy`:

```

apiVersion: scanning.apps.tanzu.vmware.com/v1beta1
kind: ScanPolicy
metadata:
 name: scan-policy
 labels:
 'app.kubernetes.io/part-of': 'enable-in-gui'
spec:
 regoFile: |
 package main

 # Accepted Values: "Critical", "High", "Medium", "Low", "Negligible", "UnknownSeverity"
 notAllowedSeverities := ["Critical", "High", "UnknownSeverity"]
 ignoreCves := []

 contains(array, elem) = true {
 array[_] = elem
 } else = false { true }

 isSafe(match) {
 severities := { e | e := match.ratings.rating.severity } | { e | e := match.ratings.rating[_].severity }
 some i
 fails := contains(notAllowedSeverities, severities[i])
 not fails
 }

 isSafe(match) {
 ignore := contains(ignoreCves, match.id)
 ignore
 }

 deny[msg] {
 comps := { e | e := input.bom.components.component } | { e | e := input.bom.components.component[_] }
 some i
 comp := comps[i]
 vulns := { e | e := comp.vulnerabilities.vulnerability } | { e | e := comp.vulnerabilities.vulnerability[_] }
 some j
 vuln := vulns[j]
 ratings := { e | e := vuln.ratings.rating.severity } | { e | e := vuln.ratings.rating[_].severity }
 not isSafe(vuln)
 msg = sprintf("CVE %s %s %s", [comp.name, vuln.id, ratings])
 }

```

See [Writing Policy Templates](#).

## ScanTemplate

A ScanTemplate defines the PodTemplateSpec used by a TaskRun to run a particular scan (image or source). When the supply chain initiates an ImageScan or SourceScan, they reference these templates which must live in the same namespace as the workload with the names matching the following:

- source scanning ([blob-source-scan-template](#))
- image scanning ([private-image-scan-template](#))

If you are targeting a namespace that does not match the one configured in the Tanzu Application Platform profiles, for example, if `grype.namespace` is not the same as the one you are writing the

workload to, you can install these in such namespace by making use of the `tanzu package install` command as described in [Install Supply Chain Security Tools - Scan](#):

1. Create a file named `ootb-supply-chain-basic-values.yaml` that specifies the corresponding values to the properties you want to change. For example:

```
grype:
 namespace: YOUR-DEV-NAMESPACE
 targetImagePullSecret: registry-credentials
```

2. With the configuration ready, install the templates by running:

```
tanzu package install grype-scanner \
 --package grype.scanning.apps.tanzu.vmware.com \
 --version 1.0.0 \
 --namespace YOUR-DEV-NAMESPACE
```



#### Note

Although you can customize the templates, if you are following the Getting Started guide, VMware recommends that you follow what is provided in the installation of `grype.scanning.apps.tanzu.vmware.com`. This is created in the same namespace as configured by using `grype.namespace` in either Tanzu Application Platform profiles or individual component installation as in the earlier example. For more information, see [About Source and Image Scans](#).

### Enable storing scan results

To enable SCST - Scan to store scan results by using SCST - Store, see [Developer namespace setup](#) for exporting the SCST - Store CA certificate and authentication token to the developer namespace.

### Allow multiple Tekton pipelines in a namespace

You can configure your developer namespace to include more than one pipeline using either of the following methods:

- Use a single pipeline running on a container image that includes testing tools and runs a common script to execute tests. This allows you to accommodate multiple workloads based in different languages in the same namespace that use a common make test script, as shown in the following example:

```
apiVersion: tekton.dev/v1beta1
kind: Pipeline
metadata:
 name: developer-defined-tekton-pipeline
 labels:
 apps.tanzu.vmware.com/pipeline: test
spec:
 #...
 steps:
 - name: test
 image: <image_that_has_JDK_and_Go>
 script: |-
 cd `mktemp -d`
 wget -qO- $(params.source-url) | tar xvz -m
 make test
```

- Update the pipeline resources to include labels that differentiate between the pipelines. For example, differentiate between Java and Go pipelines by adding labels for Java and Go:

```

apiVersion: tekton.dev/v1beta1
kind: Pipeline
metadata:
 name: java-tests
 labels:
 apps.tanzu.vmware.com/pipeline: test
 apps.tanzu.vmware.com/language: java
spec:
 #...
 steps:
 - name: test
 image: gradle
 script: |-
 # ...
 ./mvnw test

apiVersion: tekton.dev/v1beta1
kind: Pipeline
metadata:
 name: go-tests
 labels:
 apps.tanzu.vmware.com/pipeline: test
 apps.tanzu.vmware.com/language: go
spec:
 #...
 steps:
 - name: test
 image: golang
 script: |-
 # ...
 go test -v ./...

```

To match the correct pipeline, you add a `testing_pipeline_matching_labels` parameter to the workload. For example, if you want to match to the Java pipeline, you have the following `workload.yaml`:

```

apiVersion: carto.run/v1alpha1
kind: Workload
metadata:
 name: sample-java-app
 labels:
 apps.tanzu.vmware.com/has-tests: true
 apps.tanzu.vmware.com/workload-type: web
 app.kubernetes.io/part-of: sample-java-app
spec:
 params:
 - name: testing_pipeline_matching_labels
 value:
 apps.tanzu.vmware.com/pipeline: test
 apps.tanzu.vmware.com/language: java
 ...

```

This matches the workload to the pipeline with the `apps.tanzu.vmware.com/language: java` label.

## Developer workload

With the ScanPolicy and ScanTemplate objects, with the required names set, submitted to the same namespace where the workload is submitted, you are ready to submit your workload.

Regardless of the workflow being targeted, such as local development or GitOps, the workload configuration details are the same as in Out of the Box Supply Chain Basic, except that you mark the workload as having tests enabled.

For example:

```
tanzu apps workload create tanzu-java-web-app \
 --git-branch main \
 --git-repo https://github.com/vmware-tanzu/application-accelerator-samples \
 --sub-path tanzu-java-web-app \
 --label apps.tanzu.vmware.com/has-tests=true \
 --label app.kubernetes.io/part-of=tanzu-java-web-app \
 --type web
```

```
Create workload:
 1 + |---
 2 + |apiVersion: carto.run/v1alpha1
 3 + |kind: Workload
 4 + |metadata:
 5 + | labels:
 6 + | apps.tanzu.vmware.com/workload-type: web
 7 + | apps.tanzu.vmware.com/has-tests: "true"
 8 + | app.kubernetes.io/part-of: tanzu-java-web-app
 9 + | name: tanzu-java-web-app
10 + | namespace: default
11 + |spec:
12 + | source:
13 + | git:
14 + | ref:
15 + | branch: main
16 + | url: https://github.com/vmware-tanzu/application-accelerator-samples
17 + | subPath: tanzu-java-web-app
```

## CVE triage workflow

The Supply Chain halts progression if either a SourceScan ([source-scans.scanning.apps.tanzu.vmware.com](https://source-scans.scanning.apps.tanzu.vmware.com)) or an ImageScan ([image-scans.scanning.apps.tanzu.vmware.com](https://image-scans.scanning.apps.tanzu.vmware.com)) fails policy enforcement through the [ScanPolicy](#) ([scan-policies.scanning.apps.tanzu.vmware.com](https://scan-policies.scanning.apps.tanzu.vmware.com)).

This can prevent source code from building or images deploying that contain vulnerabilities that are in violation of the user-defined scan policy. For information about learning how to handle these vulnerabilities and unblock your Supply Chain, see [Triaging and Remediating CVEs](#).

## Scan Images using a different scanner

[Supply Chain Security Tools - Scan](#) includes additional integrations for running an image scan using Snyk and VMware Carbon Black.

## Install Out of the Box Supply Chain with Testing and Scanning for Supply Chain Choreographer

This topic describes how you can install Out of the Box Supply Chain with Testing and Scanning for Supply Chain Choreographer from the Tanzu Application Platform package repository.



### Note



Follow the steps in this topic if you do not want to use a profile to install Out of the Box Supply Chain with Testing and Scanning. For more information about profiles, see [Components and installation profiles](#).

The Out of the Box Supply Chain with Testing and Scanning package provides a ClusterSupplyChain that brings an application from source code to a deployed instance that:

- Runs in a Kubernetes environment.
- Performs validations in terms of running application tests.
- Scans the source code and image for vulnerabilities.

## Install

To install Out of the Box Supply Chain with Testing and Scanning:

1. Complete all [prerequisites](#) to install Tanzu Application Platform.
2. [Install Supply Chain Choreographer](#).
3. [Install Out of the Box Delivery Basic](#).
4. [Install Tekton Pipelines](#).
5. [Install Out of the Box Templates](#).
6. Ensure you do not have Out of The Box Supply Chain With Testing (`ootb-supply-chain-testing.tanzu.vmware.com`) installed:
  1. Run the following command:

```
tanzu package installed list --namespace tap-install
```

2. Verify `ootb-supply-chain-testing` is in the output:

NAME	PACKAGE-NAME
ootb-delivery-basic	ootb-delivery-basic.tanzu.vmware.com
ootb-supply-chain-basic com	ootb-supply-chain-basic.tanzu.vmware. com
ootb-templates	ootb-templates.tanzu.vmware.com

3. If you see `ootb-supply-chain-testing` in the list, uninstall it by running:

```
tanzu package installed delete ootb-supply-chain-testing --namespace tap-install
```

Example output:

```
Deleting installed package 'ootb-supply-chain-testing' in namespace 'tap-install'.
Are you sure? [y/N]: y

| Uninstalling package 'ootb-supply-chain-testing' from namespace 'tap-install'
| Getting package install for 'ootb-supply-chain-testing'
- Deleting package install 'ootb-supply-chain-testing' from namespace 'tap-install'
| Deleting admin role 'ootb-supply-chain-testing-tap-install-cluster-role'
| Deleting role binding 'ootb-supply-chain-testing-tap-install-cluster-rolebinding'
| Deleting secret 'ootb-supply-chain-testing-tap-install-values'
```

```
| Deleting service account 'ootb-supply-chain-testing-tap-install-sa'

Uninstalled package 'ootb-supply-chain-testing' from namespace 'tap-install'
```

7. Check the values of the package that can be configured by running:

```
tanzu package available get ootb-supply-chain-testing-scanning.tanzu.vmware.com/0.7.0 \
--values-schema \
-n tap-install
```

For example:

KEY	DESCRIPTION
registry.repository	Name of the repository in the image registry server where the application images from the workload should be pushed (required).
registry.server	Name of the registry server where application images should be pushed to (required).
gitops.server_address	Default server address to be used for forming Git URLs for pushing Kubernetes configuration produced by the supply chain. This must include the scheme/protocol (e.g. https:// or ssh://)
gitops.repository_owner	Default project or user of the repository. Used to create URLs for pushing Kubernetes configuration produced by the supply chain.
gitops.repository_name	Default repository name used for forming Git URLs for pushing Kubernetes configuration produced by the supply chain.
gitops.username	Default user name to be used for the commits produced by the supply chain.
gitops.branch	Default branch to use for pushing Kubernetes configuration files produced by the supply chain.
gitops.commit_message	Default git commit message to write when publishing Kubernetes configuration files produced by the supply chain to git.
gitops.email	Default user email to be used for the commits produced by the supply chain.
gitops.ssh_secret	Name of the default Secret containing SSH credentials to lookup in the developer namespace for the supply chain to fetch source code from and push configuration to.
gitops.commit_strategy	Specification of how commits are made to the branch; directly or through a

	pull request.
<code>gitops.repository_prefix</code>	DEPRECATED: Use <code>server_address</code> and <code>repository_owner</code> instead.
<code>gitops.repository_owner</code>	Default prefix to be used for forming Git SSH URLs for pushing Kubernetes configuration produced by the supply chain.
<code>gitops.pull_request.server_kind</code>	The git source control platform used
<code>gitops.pull_request.commit_branch</code>	The branch to which commits will be made, before opening a pull request
<code>gitops.pull_request.commit_branch</code>	to the branch specified in <code>.gitops.branch</code>
<code>gitops.pull_request.commit_branch</code>	If the string "" is specified, an essentially random string will be used for the branch name, in order to prevent collisions.
<code>gitops.pull_request.pull_request_title</code>	The title for the pull request
<code>gitops.pull_request.pull_request_body</code>	Any further information to add to the pull request
<code>cluster_builder</code>	Name of the Tanzu Build Service ClusterBuilder to use by default on image objects managed by the supply chain.
<code>service_account</code>	Name of the service account in the namespace where the Workload is submitted to utilize for providing registry credentials to the Tanzu Build Service Image objects as well as deploying the application.

8. Create a file named `ootb-supply-chain-testing-scanning-values.yaml` that specifies the corresponding values to the properties you want to change. For example:

```
registry:
 server: REGISTRY-SERVER
 repository: REGISTRY-REPOSITORY

gitops:
 server_address: https://github.com/
 repository_owner: vmware-tanzu
 branch: main
 username: supplychain
 email: supplychain
 commit_message: supplychain@cluster.local
 ssh_secret: git-ssh
 commit_strategy: direct

cluster_builder: default
service_account: default
```



### Important

The `gitops.repository_prefix` field must end with `/`.

9. With the configuration ready, install the package by running:

```
tanzu package install ootb-supply-chain-testing-scanning \
 --package ootb-supply-chain-testing-scanning.tanzu.vmware.com \
 --version 0.7.0 \
 --namespace tap-install \
 --values-file ootb-supply-chain-testing-scanning-values.yaml
```

Example output:

```
\ Installing package 'ootb-supply-chain-testing-scanning.tanzu.vmware.com'
| Getting package metadata for 'ootb-supply-chain-testing-scanning.tanzu.vmware.com'
| Creating service account 'ootb-supply-chain-testing-scanning-tap-install-sa'
| Creating cluster admin role 'ootb-supply-chain-testing-scanning-tap-install-cluster-role'
| Creating cluster role binding 'ootb-supply-chain-testing-scanning-tap-install-cluster-rolebinding'
| Creating secret 'ootb-supply-chain-testing-scanning-tap-install-values'
| Creating package resource
- Waiting for 'PackageInstall' reconciliation for 'ootb-supply-chain-testing-scanning'
\ 'PackageInstall' resource install status: Reconciling

Added installed package 'ootb-supply-chain-testing-scanning' in namespace 'tap-install'
```

## Out of the Box Templates for Supply Chain Choreographer

This topic describes the templates you can use with Supply Chain Choreographer.

Templates define Kubernetes objects based on configuration in the workload, supply chain Tanzu Application Platform values, and results output from other templated objects. A supply chain organizes a set of templates into a directed acyclic graph. This package contains templates that are used by the Out of the Box Supply Chains and the Out of the Box Delivery. You must install this package to have Workloads delivered properly.

The OOTB Template package includes:

- [Cartographer Templates](#): See [reference](#)
- [Cartographer ClusterRunTemplates](#): See [reference](#)
- [Tekton ClusterTasks](#)
- [ClusterRoles](#)
- [openshift SecurityContextConstraints](#)

For information about OOTB Supply Chains and Delivery, see:

- [Out of the Box Supply Chain Basic](#)
- [Out of the Box Supply Chain with Testing](#)
- [Out of the Box Supply Chain with Testing and Scanning](#)
- [Out of the Box Delivery Basic](#)

## Out of the Box Templates for Supply Chain Choreographer

This topic describes the templates you can use with Supply Chain Choreographer.

Templates define Kubernetes objects based on configuration in the workload, supply chain Tanzu Application Platform values, and results output from other templated objects. A supply chain organizes a set of templates into a directed acyclic graph. This package contains templates that are

used by the Out of the Box Supply Chains and the Out of the Box Delivery. You must install this package to have Workloads delivered properly.

The OOTB Template package includes:

- [Cartographer Templates](#): See [reference](#)
- [Cartographer ClusterRunTemplates](#): See [reference](#)
- [Tekton ClusterTasks](#)
- [ClusterRoles](#)
- [openshift SecurityContextConstraints](#)

For information about OOTB Supply Chains and Delivery, see:

- [Out of the Box Supply Chain Basic](#)
- [Out of the Box Supply Chain with Testing](#)
- [Out of the Box Supply Chain with Testing and Scanning](#)
- [Out of the Box Delivery Basic](#)

## Install Out of the Box Templates for Supply Chain Choreographer

This topic describes how you can install Out of the Box Templates for Supply Chain Choreographer from the Tanzu Application Platform package repository.



### Note

Follow the steps in this topic if you do not want to use a profile to install Out of the Box Templates. For more information about profiles, see [Components and installation profiles](#).

The Out of the Box Templates package is used by all the Out of the Box Supply Chains to provide the templates that are used by the Supply Chains to create the objects that drive source code all the way to a deployed application in a cluster.

## Prerequisites

Before installing Out of the Box Templates:

- Complete all prerequisites to install Tanzu Application Platform. For more information, see [Prerequisites](#).
- Install cartographer. For more information, see [Install Supply Chain Choreographer](#).
- Install [Tekton Pipelines](#).

## Install

To install Out of the Box Templates:

1. View the configurable values of the package by running:

```
tanzu package available get ootb-templates.tanzu.vmware.com/0.7.0 \
 --values-schema \
 -n tap-install
```

For example:

KEY	DEFAULT	TYPE	DESCRIPTION
excluded_templates	[]	array	List of templates to exclude from the installation (e.g. ['git-writer'])

2. Create a file named `ootb-templates.yaml` that specifies the corresponding values to the properties you want to change.

For example, the contents of the file might look like this:

```
excluded_templates: []
```

3. After the configuration is ready, install the package by running:

```
tanzu package install ootb-templates \
 --package ootb-templates.tanzu.vmware.com \
 --version 0.7.0 \
 --namespace tap-install \
 --values-file ootb-templates-values.yaml
```

Example output:

```
\ Installing package 'ootb-templates.tanzu.vmware.com'
| Getting package metadata for 'ootb-templates.tanzu.vmware.com'
| Creating service account 'ootb-templates-tap-install-sa'
| Creating cluster admin role 'ootb-templates-tap-install-cluster-role'
| Creating cluster role binding 'ootb-templates-tap-install-cluster-rolebinding'
| Creating secret 'ootb-templates-tap-install-values'
| Creating package resource
- Waiting for 'PackageInstall' reconciliation for 'ootb-templates'
/ 'PackageInstall' resource install status: Reconciling

Added installed package 'ootb-templates' in namespace 'tap-install'
```

## Out of the Box Delivery Basic for Supply Chain Choreographer

This topic is an overview of the Out of the Box Delivery Basic package for Supply Chain Choreographer.

This package provides a reusable ClusterDelivery object that delivers the Kubernetes configuration that the Out of the Box Supply Chain produces to an environment, including [Basic](#), [Testing](#), and [Testing With Scanning](#) supply chains.

### Prerequisites

To make use of this package you must have installed:

- [Supply Chain Cartographer](#)
- [Out of the Box Templates](#)

### Using Out of the Box Delivery Basic

Out of the Box Delivery Basic support both GitOps and local development workflows:

```
GITOPS
```

```

Deliverable:
 points at a git repository where source code is found and
 kubernetes configuration is pushed to

LOCAL DEVELOPMENT

Deliverable:

 points at a container image registry where the supplychain
 pushes source code and configuration to

DELIVERY

 takes a Deliverable (local or gitops) and passes is through
 a series of resources:

 config-provider <---[config]--- deployer
 . .
 . .
GitRepository/ImageRepository kapp-ctrl/App
 - knative/Service
 - ResourceClaim
 - ServiceBinding
 ...

```

You must install this package to have Workloads delivered properly with the [Basic](#), [Testing](#), and [Testing With Scanning](#) Out of the Box Supply Chains.

Consumers do not interact directly with this package. Instead, this package is used after the supply chains create a [carto.run/Deliverable](#) object to express the intention of having the Workloads that go through them delivered to an environment. The environment is the same Kubernetes cluster as the Supply Chains.

## More information

- [Reference](#)
- [Installation](#)

## Out of the Box Delivery Basic for Supply Chain Choreographer

This topic is an overview of the Out of the Box Delivery Basic package for Supply Chain Choreographer.

This package provides a reusable ClusterDelivery object that delivers the Kubernetes configuration that the Out of the Box Supply Chain produces to an environment, including [Basic](#), [Testing](#), and [Testing With Scanning](#) supply chains.

## Prerequisites

To make use of this package you must have installed:

- [Supply Chain Cartographer](#)
- [Out of the Box Templates](#)

## Using Out of the Box Delivery Basic

Out of the Box Delivery Basic support both GitOps and local development workflows:

```

GITOPS

 Deliverable:
 points at a git repository where source code is found and
 kubernetes configuration is pushed to

LOCAL DEVELOPMENT

 Deliverable:

 points at a container image registry where the supplychain
 pushes source code and configuration to

DELIVERY

 takes a Deliverable (local or gitops) and passes is through
 a series of resources:

 config-provider <---[config]--- deployer
 . .
 . .
GitRepository/ImageRepository kapp-ctrl/App
 - knative/Service
 - ResourceClaim
 - ServiceBinding
 ...

```

You must install this package to have Workloads delivered properly with the [Basic](#), [Testing](#), and [Testing With Scanning](#) Out of the Box Supply Chains.

Consumers do not interact directly with this package. Instead, this package is used after the supply chains create a [carto.run/Deliverable](#) object to express the intention of having the Workloads that go through them delivered to an environment. The environment is the same Kubernetes cluster as the Supply Chains.

### More information

- [Reference](#)
- [Installation](#)

## Install Out of the Box Delivery Basic for Supply Chain Choreographer

This topic shows you how to install the Out of the Box Delivery Basic package for Supply Chain Choreographer from the Tanzu Application Platform package repository.



#### Note



Follow the steps in this topic if you do not want to use a profile to install Out of the Box Delivery Basic. For more information about profiles, see [Components and installation profiles](#).

The Out of the Box Delivery Basic package is used by all the Out of the Box Supply Chains to deliver the objects that have been produced by them to a Kubernetes environment.

## Prerequisites

Before installing Out of the Box Delivery Basic:

- Complete all prerequisites to install Tanzu Application Platform. For more information, see [Prerequisites](#).
- Install cartographer. For more information, see [Install Supply Chain Choreographer](#).

## Install

To install Out of the Box Delivery Basic:

1. Familiarize yourself with the set of values of the package that can be configured by running:

```
tanzu package available get ootb-delivery-basic.tanzu.vmware.com/0.7.0 \
 --values-schema \
 -n tap-install
```

For example:

KEY	DEFAULT	TYPE	DESCRIPTION
service_account	default	string	Name of the service account in the namespace where the Deliverable is submitted to.

2. Create a file named `ootb-delivery-basic-values.yaml` that specifies the corresponding values to the properties you want to change.

For example, the contents of the file might look like this:

```
service_account: default
```

3. With the configuration ready, install the package by running:

```
tanzu package install ootb-delivery-basic \
 --package ootb-delivery-basic.tanzu.vmware.com \
 --version 0.7.0 \
 --namespace tap-install \
 --values-file ootb-delivery-basic-values.yaml
```

Example output:

```
\ Installing package 'ootb-delivery-basic.tanzu.vmware.com'
| Getting package metadata for 'ootb-delivery-basic.tanzu.vmware.com'
| Creating service account 'ootb-delivery-basic-tap-install-sa'
| Creating cluster admin role 'ootb-delivery-basic-tap-install-cluster-role'
| Creating cluster role binding 'ootb-delivery-basic-tap-install-cluster-rolebi
nding'
| Creating secret 'ootb-delivery-basic-tap-install-values'
| Creating package resource
- Waiting for 'PackageInstall' reconciliation for 'ootb-delivery-basic'
/ 'PackageInstall' resource install status: Reconciling
```

```
Added installed package 'ootb-delivery-basic' in namespace 'tap-install'
```

## How-to guides for Supply Chain Choreographer for Tanzu

This topic describes the how-to guides you can use for Supply Chain Choreographer for Tanzu.

### How-to guides

The following how-to guides apply to Supply Chain Choreographer for Tanzu:

- [Install Supply Chain Choreographer](#)
- [Install Out of the Box Delivery Basic](#)
- [Install Out of the Box Supply Chain Basic](#)
- [Install Out of the Box Supply Chain with Testing](#)
- [Install Out of the Box Supply Chain with Testing and Scanning](#)
- [Install Out of the Box Templates](#)
- [Tanzu Build Service Integration](#)
- [Building from source](#)
- [Git authentication](#)
- [Output Carvel Packages from your Supply Chain](#)
- [Deploy Carvel Packages using Carvel App CR](#)
- [Deploy Carvel Packages using Flux CD Kustomization](#)
- [Deploy Carvel Packages using Argo CD](#)
- [Use Blue-green deployments with Contour and Carvel Packages](#)
- [Use Canary deployments with Contour and Carvel Packages](#)

## Out of the Box Supply Chain with testing on Jenkins for Supply Chain Choreographer

This topic provides an overview of Out of the Box Supply Chain with testing on Jenkins for Supply Chain Choreographer.

The Out of the Box templates package now includes a Tekton `ClusterTask` resource, which triggers a build for a specified Jenkins job.

You can configure the Jenkins task in both the [Out of the Box Supply Chain with Testing](#) and [Out of the Box Supply Chain With Testing and Scanning](#) to trigger a Jenkins job. The task is implemented as a Tekton `ClusterTask` and can now run from a Tekton `Pipeline`.

### Prerequisites

Follow the instructions from either [Out of the Box Supply Chain With Testing](#) or [Out of the Box Supply Chain With Testing and Scanning](#) to install the required packages. You need to set up only one of these packages.

Either of these Supply Chains can use the Jenkins service during the `source-tester` phase of the pipeline.

## Using the Out of the Box Jenkins Task

The intent of the Jenkins task provided using Out of the Box templates is to help Tanzu Application Platform users to integrate with and make use of the modern application deployment pipeline provided by our platform while maintaining their existing test suites on their Jenkins services.

The Out of the Box Jenkins task makes use of an existing Jenkins Job to run test suites on source code.

### Configuring a Jenkins job in an existing Jenkins Pipeline

This section of the guide shows how to configure a Jenkins job that you can kick off by the Tanzu Application Platform Jenkins task.

### Example Jenkins Job

Here is an example of a script that you can add to your pipeline that specifies source URL and source revision information for your source code target. This example uses a Jenkins instance that is deployed on a Kubernetes cluster although this is not the only possible configuration for a Jenkins instance.

```
#!/bin/env groovy

pipeline {
 agent {
 // Use an agent that is appropriate
 // for your Jenkins installation.
 // This is only an example
 kubernetes {
 label 'maven'
 }
 }

 stages {
 stage('Checkout code') {
 steps {
 script {
 sourceUrl = params.SOURCE_REVISION
 indexSlash = sourceUrl.indexOf("/")
 if (indexSlash == -1) {
 // TAP 1.6+
 revision = sourceUrl.substring(sourceUrl.indexOf(":") + 1)
 } else {
 // pre TAP 1.6
 revision = sourceUrl.substring(indexSlash + 1)
 }
 }
 sh "git clone ${params.GIT_URL} target"
 dir("target") {
 sh "git checkout ${revision}"
 }
 }
 }

 stage('Maven test') {
 steps {
 container('maven') {
 dir("target") {
 // Example tests with maven
 sh "mvn clean test --no-transfer-progress"
 }
 }
 }
 }
 }
}
```

```

 }
 }
}

```

Where:

- **SOURCE\_URL string** The URL of the source code being tested. The `source-provider` resource in the supply chain provides this code and is only resolvable inside the Kubernetes cluster. This URL is only useful if your Jenkins service is running inside the cluster or if there is ingress set up and the Jenkins service can make requests to services inside the cluster.
- **SOURCE\_REVISION string** The revision of the source code being tested. The format of this value can vary depending on the implementation of the `source_provider` resource. If the `source-provider` is the Flux CD `GitRepository` resource, then the value of the `SOURCE_REVISION` is the Git branch name followed by the commit SHA, both separated by a (/) slash character. For example, `main/2b1ed6c3c4f74f15b0e4de2732234eafd050eb1ca`. Your Jenkins pipeline script must extract the commit SHA from the `SOURCE_REVISION` to be useful.



#### Note

If you can't use the `SOURCE_URL` because your Jenkins service cannot make requests into the Kubernetes cluster, you can supply the source code URL to the Jenkins job with other parameters instead.

The following fields are also required in the Jenkins Job definition

- **SOURCE\_REVISION string**
- **GIT\_URL string**

To configure your `Workload` to pass the `GIT_URL` parameter into the Jenkins task:

```

tanzu apps workload create workload \
--namespace your-test-namespace \
--git-branch main \
--git-repo https://your.git/repository.git \
--label apps.tanzu.vmware.com/has-tests=true \
--label app.kubernetes.io/part-of=test-workload \
--param-yaml testing_pipeline_matching_labels='{"apps.tanzu.vmware.com/pipeline":"jenkins-pipeline"}' \
--param-yaml testing_pipeline_params='{"secret-name":"my-secret","job-name":"jenkins-job-name","job-params":[{"name":"GIT_URL","value":"https://your.git/repository.git"}]}' \
--type web \
--yes

```

The `Workload` is described in the later [Developer Workload](#) section.

### Create a secret with authentication credentials

A secret must be created in the developer namespace to contain the credentials required to authenticate and interact with your Jenkins instance's builds. The following properties are required:

- **url required:** URL of the Jenkins instance that hosts the job, including the scheme. For example: `https://my-jenkins.com`.
- **username required:** User name of the user that has access to trigger a build on Jenkins.
- **password required:** Password of the user that has access to trigger a build on Jenkins.

- `ca-cert` **optional**: The PEM-encoded CA certificate to verify the Jenkins instance identity.

Use the Kubernetes CLI tool (kubectl) to create the secret. You can provide the optional PEM-encoded CA certificate as a file using the `--from-file` flag:

```
kubectl create secret generic my-secret \
 --from-literal=url=https://jenkins.instance \
 --from-literal=username=literal-username \
 --from-file=password=/path/to/file/with/password.txt \
 --from-file=ca-cert=/path/to/ca-certificate.pem \
```

The expected format of the secret is as follows:

```
apiVersion: v1
kind: Secret
metadata:
 name: MY-SECRET # secret name that will be referenced by the workload
type: Opaque
stringData:
 url: JENKINS-URL # target jenkins instance url
 username: USERNAME # jenkins username
 password: PASSWORD # jenkins password or token
 ca-cert: PEM-CA-CERT # PEM encoded certificate
```

Where:

- `MY-SECRET` is the secret name that is referenced by the workload.
- `JENKINS-URL` is the target Jenkins instance URL.
- `USERNAME` is the Jenkins username.
- `PASSWORD` is the Jenkins password or token.
- `PEM-CA-CERT` is the PEM encoded certificate.

## Create a Tekton pipeline

The developer must create a Tekton `Pipeline` object with the following parameters:

- `source-url`, **required**: An HTTP address where a `.tar.gz` file containing all the source code being tested is supplied.
- `source-revision`, **required**: The revision of the commit or image reference found by the `source-provider`.
- `secret-name`, **required**: The secret that contains the URL, user name, password, and certificate (optional) to the Jenkins instance that houses the job that is required to run.
- `job-name`, **required**: The name of the Jenkins job that is required to run.
- `job-params`, **required**: A list of key-value pairs, encoded as a JSON string, that passes in parameters needed for the Jenkins job.

Tasks:

- `jenkins-task`, **required**: This `ClusterTask` is one of the tasks that the pipeline runs to trigger the Jenkins job. It is installed in the cluster by the **Out of the Box Templates** package.

Results:

- `jenkins-job-url`: A string result that outputs the URL of the Jenkins build that the Tekton task triggered. The `jenkins-task ClusterTask` populates the output.

Here is an example of how to create a tekton pipeline with the required parameters

```

cat <<EOF | kubectl apply -f -

apiVersion: tekton.dev/v1beta1
kind: Pipeline
metadata:
 name: developer-defined-jenkins-tekton-pipeline
 namespace: developer-namespace
 labels:
 #! This label should be provided to the Workload so that
 #! the supply chain can find this pipeline
 apps.tanzu.vmware.com/pipeline: jenkins-pipeline
spec:
 results:
 - name: jenkins-job-url #! To show the job URL on the
 #! Tanzu Developer Portal
 value: $(tasks.jenkins-task.results.jenkins-job-url)
 params:
 - name: source-url #! Required
 - name: source-revision #! Required
 - name: secret-name #! Required
 - name: job-name #! Required
 - name: job-params #! Required
 tasks:
 #! Required: Include the built-in task that triggers the
 #! given job in Jenkins
 - name: jenkins-task
 taskRef:
 name: jenkins-task
 kind: ClusterTask
 params:
 - name: source-url
 value: $(params.source-url)
 - name: source-revision
 value: $(params.source-revision)
 - name: secret-name
 value: $(params.secret-name)
 - name: job-name
 value: $(params.job-name)
 - name: job-params
 value: $(params.job-params)
EOF

```

## Patching the default Service Account

Tanzu Application Platform includes a [Namespace Provisioner](#) which is not enabled by default. This section requires that you do not use the Namespace Provisioner.

The `jenkins-task ClusterTask` resource uses a container image with the Jenkins Adapter application to trigger the Jenkins job and wait for it to complete. This container image is distributed with Tanzu Application Platform on [tanzu.packages.broadcom.com](https://tanzu.packages.broadcom.com), but it is not installed at the same time as the other packages. It is pulled at the time that the supply chain executes the job. As a result, it does not implicitly have access to the `imagePullSecrets` with the required credentials.



### Important

The `ServiceAccount` that a developer can configure with their `Workload` is *not* passed to the task and is not used to pull the Jenkins Adapter container image. If you followed the Tanzu Application Platform Install Guide, then you have a `Secret` named `tap-registry` in each of your cluster's namespaces. You can patch the

default Service Account in your workload's namespace so that your supply chain can pull the Jenkins Adapter image. For example:

```
kubectl patch serviceaccount default \
 --patch '{"imagePullSecrets": [{"name": "tap-registry"}]}' \
 --namespace developer-namespace
```

## Create a Developer Workload

Submit your [Workload](#) to the same namespace as the Tekton [Pipeline](#) defined earlier.

To enable the supply chain to run Jenkins tasks, the [Workload](#) must include the following parameters:

```
parameters:

 #! Required: selects the pipeline
 - name: testing_pipeline_matching_labels
 value:
 #! This label must match the label on the pipeline created earlier
 apps.tanzu.vmware.com/pipeline: jenkins-pipeline

 #! Required: Passes parameters to pipeline
 - name: testing_pipeline_params
 value:

 #! Required: Name of the Jenkins job
 job-name: my-jenkins-job

 #! Required: The secret created earlier to access Jenkins
 secret-name: my-secret

 #! Required: The `job-params` element is required, but the parameter string
 #! might be empty. If empty, then set this value to `[]`. If non-empty then the
 #! value contains a JSON-encoded list of parameters to pass to the Jenkins job.
 #! Ensure that the quotation marks inside the JSON-encoded string are escaped.
 job-params: "[{\\"name\\":\\"A\\",\\"value\\":\\"x\\"},{\\"name\\":\\"B\\",\\"value\\":\\"y
 \\",...}]"
```

You can create the workload by using the [apps](#) CLI plug-in. For example:

```
readonly GIT_BRANCH="my-git-branch"
readonly WORKLOAD_NAME="my-workload-name"
readonly GITHUB_REPO="github-repository-url"
readonly DEVELOPER_WORKSPACE_NAME="my-developer-namespace"

tanzu apps workload create "${WORKLOAD_NAME}" \
 --namespace "${DEVELOPER_WORKSPACE_NAME}" \
 --git-branch "${GIT_BRANCH}" \
 --git-repo "${GITHUB_REPO}" \
 --label apps.tanzu.vmware.com/has-tests=true \
 --label app.kubernetes.io/part-of="${WORKLOAD_NAME}" \
 --param-yaml testing_pipeline_matching_labels='{"apps.tanzu.vmware.com/pipeline": "jenkins-pipeline"}' \
 --param-yaml testing_pipeline_params='{"secret-name": "jenkins-secret", "job-name": "jenkins-job", "job-params": [{"name": "GIT_URL", "value": "https://github.com/spring-projects/spring-petclinic"}, {"name": "GIT_BRANCH", "value": "main"}]}' \
 --type web
```

Where:

- [GIT\\_URL](#) is the URL of your GitHub repository.

- `GIT_BRANCH` is the branch you want to target.

The value of the `job-params` parameter is a list of zero-or-more parameters that are sent to the Jenkins job. The parameter is entered into the `Workload` as a list of name-value pairs as shown in the example above.



### Important

None of the fields in the `Workload` resource are implicitly passed to the Jenkins job. You have to set them in the `job-params` explicitly. An exception to this is the `SOURCE_URL` and `SOURCE_REVISION` parameters are sent to the Jenkins job implicitly by the Jenkins Adapter trigger application. For example, you can use the `SOURCE_REVISION` to verify which commit SHA to test. See [Making a Jenkins Test Job](#) earlier for details about how to use the Git URL and source revision in a Jenkins test job.

Watch the quoting of the `job-params` value closely. In the earlier `tanzu apps workload create` example, the `job-params` value is a string with a JSON structure in it. The value of the `--param-yaml testing_pipeline_params` parameter is a JSON string. Add backslash (`\`) escape characters before the double quote characters (`"`) in the `job-params` value.

Example output from the `tanzu apps workload create` command:

```
Create workload:
 1 + |---
 2 + |apiVersion: carto.run/v1alpha1
 3 + |kind: Workload
 4 + |metadata:
 5 + | labels:
 6 + | app.kubernetes.io/part-of: my-workload-name
 7 + | apps.tanzu.vmware.com/has-tests: "true"
 8 + | name: my-workload-name
 9 + | namespace: developer-namespace
10 + |spec:
11 + | params:
12 + | - name: testing_pipeline_matching_labels
13 + | value:
14 + | apps.tanzu.vmware.com/pipeline: jenkins-pipeline
15 + | - name: testing_pipeline_params
16 + | value:
17 + | job-name: jenkins-job
18 + | job-params:
19 + | - name: param1
20 + | value: value1
21 + | secret-name: my-secret
22 + | source:
23 + | git:
24 + | ref:
25 + | branch: my-branch
26 + | url: https://my-source-code-repository
```

## Building container images with Supply Chain Choreographer

This topic describes the methods you can use to build container images for Supply Chain Choreographer for Tanzu.

### Methods for building container images



You can build a container image by using:

- A Maven artifact. See [Building from source](#)
- A Dockerfile based build. See [Dockerfile-based builds](#)
- Tanzu Build Service with buildpacks. See [Tanzu Build Service Integration](#)

## Building from source with Supply Chain Choreographer

You can build from source by providing source code for the workload with any Supply Chain package.

You can provide source code for the workload from one of three places:

1. A Git repository.
2. A directory in your local computer's file system.
3. A Maven repository.

```
Supply Chain

-- fetch source * either from Git or local directory
-- test
 -- build
 -- scan
 -- apply-conventions
 -- push config
```

This document provides details about each approach.



### Note

To provide a prebuilt container image instead of building the application from the beginning by using the supply chain, see [Using an existing image](#).

## Git source

To provide source code from a Git repository to the supply chains, you must fill `workload.spec.source.git`. With the Tanzu CLI, you can do so by using the following flags:

- `--git-branch`: branch within the Git repository to checkout
- `--git-commit`: commit SHA within the Git repository to checkout
- `--git-repo`: Git URL to remote source code
- `--git-tag`: tag within the Git repository to checkout

For example, after installing `ootb-supply-chain-basic`, to create a `Workload` the source code for which comes from the `main` branch of the `github.com/vmware-tanzu/application-accelerator-samples` Git repository, and the subdirectory `tanzu-java-web-app` run:

```
tanzu apps workload create tanzu-java-web-app \
--app tanzu-java-web-app \
--type web \
--git-repo https://github.com/vmware-tanzu/application-accelerator-samples \
--sub-path tanzu-java-web-app \
--git-branch main
```

Expect to see the following output:

```

Create workload:
 1 + |---
 2 + |apiVersion: carto.run/v1alpha1
 3 + |kind: Workload
 4 + |metadata:
 5 + | labels:
 6 + | app.kubernetes.io/part-of: tanzu-java-web-app
 7 + | apps.tanzu.vmware.com/workload-type: web
 8 + | name: tanzu-java-web-app
 9 + | namespace: default
10 + |spec:
11 + | source:
12 + | git:
13 + | ref:
14 + | branch: main
15 + | url: https://github.com/vmware-tanzu/application-accelerator-samples
16 + | subPath: tanzu-java-web-app

```



### Important

The Git repository URL must include the scheme: `http://`, `https://`, or `ssh://`.

## Private `GitRepository`

To fetch source code from a repository that requires credentials, you must provide those by using a Kubernetes secret object that the `GitRepository` object created for that workload references. See [How It Works](#) to learn more about detecting changes to the repository.

```

Workload/tanzu-java-web-app
└─GitRepository/tanzu-java-web-app
 └───> secretRef: {name: GIT-SECRET-NAME}
 |
 either a default from TAP installation or
 gitops_ssh_secret Workload parameter

```

Platform operators who install the Out of the Box Supply Chain packages by using Tanzu Application Platform profiles can customize the default name of the secret (`git-ssh`) by editing the corresponding `ootb_supply_chain*` property in the `tap-values.yaml` file:

```

ootb_supply_chain_basic:
 gitops:
 ssh_secret: GIT-SECRET-NAME

```

For platform operators who install the `ootb-supply-chain-*` package individually by using `tanzu package install`, they can edit the `ootb-supply-chain-*-values.yml` as follows:

```

gitops:
 ssh_secret: GIT-SECRET-NAME

```

You can also override the default secret name directly in the workload by using the `gitops_ssh_secret` parameter, regardless of how Tanzu Application Platform is installed. You can use the `--param` flag in Tanzu CLI. For example:

```

tanzu apps workload create tanzu-java-web-app \
 --app tanzu-java-web-app \
 --type web \
 --git-repo https://github.com/vmware-tanzu/application-accelerator-samples \
 --sub-path tanzu-java-web-app \

```

```
--git-branch main \
--param gitops_ssh_secret=SECRET-NAME
```

Expect to see the following output:

```
Create workload:
 1 + |---
 2 + |apiVersion: carto.run/v1alpha1
 3 + |kind: Workload
 4 + |metadata:
 5 + | labels:
 6 + | app.kubernetes.io/part-of: tanzu-java-web-app
 7 + | apps.tanzu.vmware.com/workload-type: web
 8 + | name: tanzu-java-web-app
 9 + | namespace: default
10 + |spec:
11 + | params:
12 + | - name: gitops_ssh_secret #! parameter that overrides the default
13 + | value: GIT-SECRET-NAME #! secret name
14 + | source:
15 + | git:
16 + | ref:
17 + | branch: main
18 + | url: https://github.com/vmware-tanzu/application-accelerator-samples
19 + | subPath: tanzu-java-web-app
```



#### Note

A secret reference is only provided to `GitRepository` if `gitops_ssh_secret` is set to a non-empty string in some fashion, either by a package property or a workload parameter. To force a `GitRepository` to not reference a secret, set the value to an empty string (`""`).

After defining the name of the Kubernetes secret, you can define the secret.

### HTTP(S) Basic-authentication and Token-based authentication

Despite both the package value and workload parameter being called `gitops.ssh_secret`, you can use HTTP(S) transports as well:

1. Ensure that the repository in the `Workload` specification uses `http://` or `https://` schemes in any URLs that relate to the repositories. For example, `https://github.com/my-org/my-repo` instead of `github.com/my-org/my-repo` OR `ssh://github.com:my-org/my-repo`.
2. In the same namespace as the workload, create a Kubernetes secret object of type `kubernetes.io/basic-auth` with the name matching the one expected by the supply chain. For example:

```
apiVersion: v1
kind: Secret
metadata:
 name: GIT-SECRET-NAME
 annotations:
 tekton.dev/git-0: GIT-SERVER # ! required
type: kubernetes.io/basic-auth
stringData:
 username: GIT-USERNAME
 password: GIT-PASSWORD
```

3. With the secret created with the name matching the one configured for `gitops.ssh_secret`, attach it to the `ServiceAccount` used by the workload. For example:

```
apiVersion: v1
kind: ServiceAccount
metadata:
 name: default
secrets:
 - name: registry-credentials
 - name: tap-registry
 - name: GIT-SECRET-NAME
imagePullSecrets:
 - name: registry-credentials
 - name: tap-registry
```

For more information about the credentials and setting up the Kubernetes secret, see [Git Authentication's HTTP section](#).

### HTTPS with a Custom CA Certificate

For Git repositories hosted with a custom CA, setup a Kubernetes secret with a custom CA. For more information, see [HTTPS with a Custom CA Certificate](#).

### SSH authentication

Aside from using HTTP(S) as a transport, you can also use SSH:

1. Ensure that the repository URL in the workload specification uses `ssh://` as the scheme in the URL, for example, `ssh://git@github.com:my-org/my-repo.git`
2. Create a Kubernetes secret object of type `kubernetes.io/ssh-auth`:

```
apiVersion: v1
kind: Secret
metadata:
 name: GIT-SECRET-NAME
 annotations:
 tekton.dev/git-0: GIT-SERVER
type: kubernetes.io/ssh-auth
stringData:
 ssh-privatekey: SSH-PRIVATE-KEY # private key with push-permissions
 identity: SSH-PRIVATE-KEY # private key with pull permissions
 identity.pub: SSH-PUBLIC-KEY # public of the `identity` private key
 known_hosts: GIT-SERVER-PUBLIC-KEYS # git server public keys
```

3. With the secret created with the name matching the one configured for `gitops.ssh_secret`, attach it to the `ServiceAccount` used by the workload. For example:

```
apiVersion: v1
kind: ServiceAccount
metadata:
 name: default
secrets:
 - name: registry-credentials
 - name: tap-registry
 - name: GIT-SECRET-NAME
imagePullSecrets:
 - name: registry-credentials
 - name: tap-registry
```

For information about how to generate the keys and set up SSH with the Git server, see [Git Authentication's SSH section](#).

## How it works

With the `workload.spec.source.git` filled, the supply chain takes care of managing a child `GitRepository` object that keeps track of commits made to the Git repository stated in `workload.spec.source.git`.

For each revision found, `gitrepository.status.artifact` gets updated providing information about an HTTP endpoint that the controller makes available for other components to fetch the source code from within the cluster.

The digest of the latest commit:

```
apiVersion: source.toolkit.fluxcd.io/v1beta1
kind: GitRepository
metadata:
 name: tanzu-java-web-app
spec:
 gitImplementation: go-git
 ignore: '! .git'
 interval: 1m0s
 ref: {branch: main}
 timeout: 20s
 url: https://github.com/vmware-tanzu/application-accelerator-samples
status:
 artifact:
 checksum: 375c2daee5fc8657c5c5b49711a8e94d400994d7
 lastUpdateTime: "2022-04-07T15:02:30Z"
 path: gitrepository/default/tanzu-java-web-app/d85df1fc.tar.gz
 revision: main/d85df1fc28c6b86ca54bd613f55991645d3b257c
 url: http://source-controller.flux-system.svc.cluster.local./gitrepository/default/tanzu-java-web-app/d85df1fc.tar.gz
 conditions:
 - lastTransitionTime: "2022-04-07T15:02:30Z"
 message: 'Fetched revision: main/d85df1fc28c6b86ca54bd613f55991645d3b257c'
 reason: GitOperationSucceed
 status: "True"
 type: Ready
 observedGeneration: 1
```

Cartographer passes the artifact URL and revision to further components in the supply chain. Those components must consume the source code from an internal URL where a tarball with the source code is fetched, without having to process any Git-specific details in multiple places.

## Workload parameters

You can pass the following parameters by using the workload object's `workload.spec.params` field to override the default behavior of the `GitRepository` object created for keeping track of the changes to a repository:

- `gitImplementation`: name of the Git implementation (`go-git`) to fetch the source code.
- `gitops_ssh_secret`: name of the secret in the same namespace as the workload where credentials to fetch the repository are found.

You can also customize the following parameters with defaults for the whole cluster. Do this by using properties for either `tap-values.yaml` when installing supply chains by using Tanzu Application Platform profiles, or `ootb-supply-chain-*values.yaml` when installing the OOTB packages individually):

- `gitops.ssh_secret`: the same as `gitops_ssh_secret` workload parameter

## Local source

You can provide source code from a local directory such as, from a directory in the developer's file system. The Tanzu CLI provides two flags to specify the source code location in the file system and where the source code is pushed to as a container image:

- `--local-path`: path on the local file system to a directory of source code to build for the workload
- `--source-image`: destination image repository where source code is staged before being built

This way, whether the cluster the developer targets is local (a cluster in the developer's machine) or not, the source code is made available by using a container image registry.

For example, if a developer has source code under the current directory (.) and access to a repository in a container image registry, you can create a workload as follows:

```
tanzu apps workload create tanzu-java-web-app \
--app tanzu-java-web-app \
--type web \
--local-path . \
--source-image $REGISTRY/test
```

```
Publish source in "." to "REGISTRY-SERVER/REGISTRY-REPOSITORY"?
It may be visible to others who can pull images from that repository

Yes

Publishing source in "." to "REGISTRY-SERVER/REGISTRY-REPOSITORY"...
Published source

Create workload:
 1 + |---
 2 + |apiVersion: carto.run/v1alpha1
 3 + |kind: Workload
 4 + |metadata:
 5 + | labels:
 6 + | app.kubernetes.io/part-of: tanzu-java-web-app
 7 + | apps.tanzu.vmware.com/workload-type: web
 8 + | name: tanzu-java-web-app
 9 + | namespace: default
10 + |spec:
11 + | source:
12 + | image: REGISTRY-SERVER/REGISTRY-REPOSITORY:latest@<digest>
```

Where:

- `REGISTRY-SERVER` is the container image registry.
- `REGISTRY-REPOSITORY` is the repository in the container image registry.

## Authentication

Both the cluster and the developer's machine must be configured to properly provide credentials for accessing the container image registry where the local source code is published to.

### Developer

The Tanzu CLI must push the source code to the container image registry indicated by `--source-image`. To do so, the CLI must find the credentials, so the developer must configure their machine accordingly.

To ensure credentials are available, use `docker` to make the necessary credentials available for the Tanzu CLI to perform the image push. Run:

```
docker login REGISTRY-SERVER -u REGISTRY-USERNAME -p REGISTRY-PASSWORD
```

## Supply chain components

Aside from the developer's ability to push source code to the container image registry, the cluster must also have the proper credentials, so it can pull that container image, unpack it, run tests, and build the application.

To provide the cluster with the credentials, point the ServiceAccount used by the workload at the Kubernetes secret that contains the credentials.

If the registry that the developer targets is the same one for which credentials were provided while setting up the workload namespace, no further action is required. Otherwise, follow the same steps as recommended for the application image.

## How it works

A workload specifies that source code must come from an image by setting `workload.spec.source.image` to point at the registry provided by using `--source-image`. Instead of having a `GitRepository` object created, an `ImageRepository` object is instantiated, with its specification filled in such a way to keep track of images pushed to the registry provided by the user.

Take the following workload as an example:

```
apiVersion: carto.run/v1alpha1
kind: Workload
metadata:
 name: app
 labels:
 app.kubernetes.io/part-of: app
 apps.tanzu.vmware.com/workload-type: web
spec:
 source:
 image: 10.188.0.3:5000/test:latest
```

Instead of a `GitRepository` object, an `ImageRepository` is created:

```
Workload/app
|
- |--GitRepository/app
+ |--ImageRepository/app
 |
 |--Image/app
 | |--Build/app-build-1
 | | |--Pod/app-build-1-build-pod
 | | |--PersistentVolumeClaim/app-cache
 | | |--SourceResolver/app-source
 | |
 | |--PodIntent/app
 | |--ConfigMap/app
 | |--Runnable/app-config-writer
 | | |--TaskRun/app-config-writer-2zj7w
 | | |--Pod/app-config-writer-2zj7w-pod
```

`ImageRepository` provides the same semantics as `GitRepository`, except that it looks for source code in container image registries rather than Git repositories.

## Maven Artifact

This approach aids integration with existing CI systems, such as Jenkins, and can pull artifacts from existing Maven repositories, including Jfrog Artifactory.

There are no dedicated fields in the `Workload` resource for specifying the Maven artifact configuration. You must fill in the `name/value` pairs in the `params` structure.

For example:

```
apiVersion: carto.run/v1alpha1
kind: Workload
metadata:
 name: my-workload
 labels:
 apps.tanzu.vmware.com/workload-type: web
spec:
 params:
 - name: maven
 value:
 groupId: com.example
 artifactId: springboot-initial
 version: RELEASE # latest 'RELEASE' or a specific version (e.g.: '1.2.2')
 type: jar # optional (defaults to 'jar')
 classifier: sources # optional
```

There are two ways to create a workload that defines a specific version of a Maven artifact as source in the Tanzu CLI.

The first way is to define the source through CLI flags. For example:

```
tanzu apps workload apply my-workload \
 --maven-artifact springboot-initial \
 --maven-version 2.6.0 \
 --maven-group com.example \
 --type web --app spring-boot-initial -y
```

Another flag that can be used alongside the others in this type of command is `--maven-type`, which refers to the Maven packaging type and defaults to `jar` if not specified.

The second one is through complex params (in JSON or YAML format). To specify the Maven info with this method, run:

```
tanzu apps workload apply my-workload \
 --param-yaml maven='{ "artifactId": "springboot-initial", "version": "2.6.0", "gr
oupId": "com.example"}'\
 --type web --app spring-boot-initial -y
```

To create a workload that defines the `RELEASE` version of a maven artifact as source, run:

```
tanzu apps workload apply my-workload \
 --param-yaml maven='{ "artifactId": "springboot-initial", "version": "RELEASE",
"groupId": "com.example"}'\
 --type web --app spring-boot-initial -y
```

The Maven repository URL and required credentials are defined in the supply chain, not the workload. For more information, see [Installing OOTB Basic](#).

## Maven Repository Secret

The `MavenArtifact` only supports authentication using basic authentication.



Additionally, MavenArtifact supports security using the TLS protocol. The Application Operator can configure the MavenArtifact to use a custom, or self-signed certificate authority (CA).

The MavenArtifact expects that all of the earlier credentials are provided in one secret, formatted as shown later:

```

apiVersion: v1
kind: Secret
metadata:
 name: maven-credentials
type: Opaque
data:
 username: <BASE64> # basic auth user name
 password: <BASE64> # basic auth password
 caFile: <BASE64> # PEM Encoded certificate data for custom CA
```

You cannot use the Tanzu CLI to create secrets such as this, but you can use the kubectl CLI instead.

For example:

```
kubectl create secret generic maven-credentials \
 --from-literal=username=literal-username \
 --from-file=password=/path/to/file/with/password.txt \
 --from-file=caFile=/path/to/ca-certificate.pem
```

## Use Dockerfile-based builds with Supply Chain Choreographer

This topic explains how you can use Dockerfile-based builds with Supply Chain Choreographer.

For any source-based supply chains, when you specify the new `dockerfile` parameter in a workload, the builds switch from using Kpack to using Kaniko. Source-based supply chains are supply chains that don't take a pre-built image. Kaniko is an open-source tool for building container images from a Dockerfile without running Docker inside a container.

## Use Dockerfile-based builds with Supply Chain Choreographer

Parameter name	Description	Example
<code>dockerfile</code>	relative path to the Dockerfile file in the build context	<code>./Dockerfile</code>
<code>docker_build_context</code>	relative path to the directory where the build context is	<code>.</code>
<code>docker_build_extra_args</code>	list of flags to pass directly to Kaniko (such as providing arguments, and so on to a build)	<code>- --build-arg=MY_KEY =MY_VALUE</code>

To build a container image from the [github.com/my-foo/bar](https://github.com/my-foo/bar) repository where the Dockerfile resides in the root of that repository, you can switch from using Kpack to building from that Dockerfile by passing the `dockerfile` parameter:

```
$ tanzu apps workload create my-foo \
 --git-repo https://github.com/my-foo/bar \
```

```

--git-branch dev \
--param dockerfile=./Dockerfile \
--type web

Create workload:
 1 + |---
 2 + |apiVersion: carto.run/v1alpha1
 3 + |kind: Workload
 4 + |metadata:
 5 + | labels:
 6 + | apps.tanzu.vmware.com/workload-type: web
 7 + | name: my-foo
 8 + | namespace: dev
 9 + |spec:
10 + | params:
11 + | - name: dockerfile
12 + | value: ./Dockerfile
13 + | source:
14 + | git:
15 + | ref:
16 + | branch: dev
17 + | url: https://github.com/my-foo/bar

```

Similarly, if the context to be used for the build must be set to a different directory within the repository, you can make use of the `docker_build_context` to change that:

```

$ tanzu apps workload create my-foo \
 --git-repo https://github.com/my-foo/bar \
 --git-branch dev \
 --param dockerfile=MyDockerfile \
 --param docker_build_context=./src

```



### Important

This feature has no platform operator configurations to be passed through `tap-values.yaml`, but if `ootb-supply-chain-*.registry.ca_cert_data` or `shared.ca_cert_data` is configured in `tap-values`, the certificates are considered when pushing the container image.

## OpenShift

Despite that Kaniko can perform container image builds without needing either a Docker daemon or privileged containers, it does require the use of:

- Capabilities usually dropped from the more restrictive SecurityContextConstraints (SCC) enabled by default in OpenShift.
- The root user.

To overcome such limitations imposed by the default unprivileged SecurityContextConstraints (SCC), Tanzu Application Platform installs:

- `SecurityContextConstraints/ootb-templates-kaniko-restricted-v2-with-anyuid` with enough extra privileges for Kaniko to operate.
- `ClusterRole/ootb-templates-kaniko-restricted-v2-with-anyuid` to permit the use of such SCC to any actor binding to that cluster role.

Each developer namespace needs a role binding that binds the role to an actor: `ServiceAccount`.

For more information, see [Set up developer namespaces to use your installed packages](#).

```

apiVersion: rbac.authorization.k8s.io/v1
kind: RoleBinding
metadata:
 name: workload-kaniko-scc
roleRef:
 apiGroup: rbac.authorization.k8s.io
 kind: ClusterRole
 name: ootb-templates-kaniko-restricted-v2-with-anyuid
subjects:
- kind: ServiceAccount
 name: default

```

With the SCC created and the ServiceAccount bound to the role that permits the use of the SCC, OpenShift accepts the pods created to run Kaniko to build the container images.



#### Note

Such restrictions are due to well-known limitations in how Kaniko performs the image builds, and there is currently no solution. For more information, see [kaniko#105](#).

## Tanzu Build Service integration for Supply Chain Choreographer

This topic describes how you can configure and use the Tanzu Build Service integration for Supply Chain Choreographer.

By default, the Out of the Box supply chains (`ootb-supply-chain-*`) in Tanzu Application Platform make use of Tanzu Build Service for building container images out of source code.

You can configure a **platform operator** by using `tap-values.yaml`:

1. The default container image registry where application images must be pushed:

```

ootb_supply_chain_basic:
 registry:
 server: <>
 repository: <>

```

2. The name of the Kpack `ClusterBuilder` used by default:

```

ootb_supply_chain_basic:
 cluster_builder: my-custom-cluster-builder

```

You can configure an **application operator** by using `Workload`:

- `spec.build.env` are the environment variables used during the build:

```

kind: Workload
apiVersion: carto.run/v1alpha1
metadata:
 name: tanzu-java-web-app
spec:
 # ...
 build:
 env:
 - name: PORT
 value: "8080"
 - name: CA_CERTIFICATE
 valueFrom:

```

```
secretKeyRef:
 name: secret-in-the-same-namespace-as-workload
 key: crt.pem
```

- `spec.params.clusterBuilder` is the name of the ClusterBuilder to use for builds of that Workload:

```
kind: Workload
apiVersion: carto.run/v1alpha1
metadata:
 name: tanzu-java-web-app
spec:
 # ...
 params:
 - name: clusterBuilder
 value: nodejs-cluster-builder
```

- `spec.params.buildServiceBindings` is the object carrying the definition of a list of service bindings to use at build time:

```

kind: Workload
apiVersion: carto.run/v1alpha1
metadata:
 name: tanzu-java-web-app
spec:
 # ...
 params:
 - name: buildServiceBindings
 value:
 - name: settings-xml
 kind: Secret
 apiVersion: v1

apiVersion: v1
kind: Secret
metadata:
 name: settings-xml
type: service.binding/maven
stringData:
 type: maven
 provider: sample
 settings.xml: <settings>...</settings>
```



#### Note

See the Kpack [ServiceBinding documentation](#) in GitHub for more details about build-time service bindings.

These configuration only take effect when Kpack is used for building a container image. If you use Dockerfile-based builds by leveraging the `dockerfile` parameter, see [dockerfile-based builds](#) for more information.

## Configure and deploy to multiple environments with custom parameters

This topic describes how to use Carvel packages, Git repositories, and Flux CD to deploy workloads to multiple environments with Supply Chain Choreographer. By using a continuous delivery (CD) tool, you can apply Carvel packages to a runtime.

## Overview

Flux CD is the VMware recommended CD tool. You can configure different parameters for each environment, such as replicas or host names. When you edit package parameters and commit them to a Git repository, Flux CD watches the Git repository and applies the package to your runtime environments.

## Feature limits

To configure and deploy to multiple environments with custom parameters, ensure that your supply chains are compatible with the feature limits.

This feature is in beta and has the following limits:

- Only the Out of the Box Basic Supply Chain package is supported.
- The Testing and Scanning supply chains are not supported.
- Innerloop development is not supported.

## Using Carvel packages

You can configure your supply chain to outputs Carvel packages and deliver configuration for each environment. For information about using Carvel, see [Carvel Package Supply Chains \(beta\)](#).

## Using GitOps delivery with Flux CD

You can deliver packages created by the Carvel package supply chain, and add them to clusters, by using a GitOps repository. For information about this delivery method, see [Use Gitops Delivery with Flux CD \(beta\)](#).

## Using GitOps delivery with Carvel App

Alternatively, you can deliver packages created by the Carvel package supply chain, and add them to clusters by using a GitOps repository. For information about this delivery method, see [Use Gitops Delivery with Carvel App](#)

## Using GitOps delivery with Argo CD

You can deliver packages created by the Carvel package supply chain, and add them to clusters by using a GitOps repository. For information about this delivery method, see [Use Gitops Delivery with Argo CD](#).

## Configuring blue-green deployment

You can use blue-green deployment to transfer user traffic from one version of an app to a later version while both are running. For information about setting up blue-green deployment, see [Use blue-green deployment with Contour and PackageInstall \(beta\)](#).

## Configuring canary deployment

You can use canary deployment to gradually shift traffic from one version of an application to a later version, and at the same time, perform analysis to verify if the later version is either promoted or rolled back. For information about setting up canary deployments, see [Use canary deployment with Contour and Carvel packages for Supply Chain Choreographer](#).

## Carvel Package Supply Chains (beta)

This topic explains what Carvel Package Supply Chains do, how they work, how operators can enable them, and how to create a `Workload` that uses them. You can use the Carvel Package Supply Chains with Supply Chain Choreographer to deliver applications to multiple production environments with configuration for each environment.

The [Out of the Box Basic Supply Chain](#) package introduces a variation of the OOTB Basic supply chains that outputs Carvel Packages.

## Overview of the Carvel Package Supply Chains

The out of the box Basic Supply Chain outputs a `Deliverable` object. These `Deliverable` objects are deployed to a cluster by the Out of the Box Delivery Supply Chain. The Carvel Package Supply Chains output a Carvel `Package` object to a GitOps repository. These `Packages` have configurable parameters such as `hostname` and `replicas` that are configured per environment. GitOps tools such as Flux CD and Argo CD can deploy the `Packages` onto multiple environments.



### Note

The Kubernetes resources created for your `server Workload` are the same for `source-to-url` or `basic-image-to-url`, optionally with a `networking.k8s.io/v1 Ingress` resource. For example, a resource named `Deployment`. The Carvel `Package` wraps these resources. You secure the `Ingress` by using the `cluster_issuer tap-ingress-selfsigned` by default.

## What do the Carvel Package Supply Chains Do?

There are two Carvel Package Supply Chains, `source-to-url-package` and `basic-image-to-url-package` in the Out of the Box Supply Chain Package. They are identical to `source-to-url` and `basic-image-to-url`, except for three resources:

- A new `carvel-package` resource is added. The supply chain stamps out a Tekton Task that bundles all application Kubernetes resources into a Carvel `Package`.
- `config-writer` is modified to write the Carvel `Package` to a GitOps repository.
- `deliverable` resource is removed.

When a `Workload` is created and all Supply Chain resources are stamped out, a Carvel `Package` is written to the GitOps repository at the path `<package_name>/packages/<package_id>.yaml`. `<package_name>` by default to `<workload_name>.<workload_namespace>.tap`, and is customized with the `name_suffix` parameter. `<package_id>` is a SemVer compatible version generated by the Bash command `$(date "+%Y%m%d%H%M%S.0.0")`.

For example:

```
app.default.tap/
 packages/
 20230321004057.0.0.yaml
```



### Note

By default, the `<package_name>` directory is created in the root directory of the GitOps repository. You can optionally create this directory at a subpath by configuring the `gitops_subpath` parameter.

For example, the following Carvel `Package` definition is stored in `<package_id>.yaml`:

```

apiVersion: data.packaging.carvel.dev/v1alpha1
kind: Package
metadata:
 name: app.default.tap.20230321004057.0.0
spec:
 refName: app.default.tap
 version: 20230321004057.0.0
 releaseNotes: |
 Release v20230321004057.0.0 of package app.default.tap
 template:
 spec:
 fetch:
 - imgpkgBundle:
 image: # imgpkg bundle containing all Kubernetes configuration
 template:
 - ytt:
 paths:
 - .
 - kbld:
 paths:
 - .imgpkg/images.yml
 - '-'
 deploy:
 - kapp: {}
 valuesSchema:
 openAPIv3:
 additionalProperties: false
 properties:
 cluster_issuer:
 default: tap-ingress-selfsigned
 description: CertManager Issuer to use to generate certificate for K8s Ingre
ss.
 title: Cluster Issuer
 type: string
 hostname:
 default: ""
 description: If set, K8s Ingress will be created with HTTP rules for hostnam
e.
 title: Hostname
 type: string
 port:
 default: 8080
 description: Port number for the backend associated with K8s Ingress.
 title: Port
 type: integer
 replicas:
 default: 1
 description: Number of replicas.
 title: Replicas
 type: integer
 workload_name:
 default: ""
 description: Required. Name of the workload, used by K8s Ingress HTTP rules.
 title: Workload name
 type: string
 type: object

```

By default, the Carvel `Package` generated by the Supply Chain has configurable parameters.

For the `server` workload type, the default parameters are:

- `workload_name`: Name of the workload. Required. Default is "".
- `replicas`: Number of pods that you want for the `apps/v1 Deployment`. Default is 1.
- `hostname`: Host name for the `networking.k8s.io/v1 Ingress`. If you don't need ingress, leave host name as an empty string. If host name is not in the file, you see an error.
- `port`: Port for the `networking.k8s.io/v1 Ingress`. Default is 8080.
- `cluster_issuer`: CertManager Issuer to use to generate certificate for Kubernetes `Ingress`. The default is "tap-ingress-selfsigned".

For the `web` workload type, the default parameters are:

- `workload_name`: Name of the workload. Required. Default is "".

For the `worker` workload type, the default parameters are:

- `workload_name`: Name of the workload. Required. Default is "".
- `replicas`: Number of pods that you want for the `apps/v1 Deployment`. Default is 1.

You can configure the Supply Chain to produce Carvel `Packages` with custom parameters. See the [installation section](#).

When a new commit is pushed to the source code Git Repository, such as `source-to-url-package`, or a new pre-built image is created, like `basic-image-to-url-package`, the Supply Chain stamps out a new version of the Carvel `Package`. This definition is written to

`<package_name>/packages/<package_id>.yaml` with a new `<package_id>`.

The Carvel `Package` stored in GitOps repositories are deployed to multiple run clusters using GitOps tools, such as Flux CD or Argo CD. See [Deploy Carvel Packages using Flux CD Kustomization](#).

## Installing the Carvel Package Supply Chains as an Operator

This section describes operator tasks for enabling and configuring the Carvel Package Supply Chains.

### Prerequisites

The Carvel Package Supply Chains require access to a GitOps repository and credentials. See [GitOps versus RegistryOps](#).

### Installation

In `tap-values`, configure the [Out of the Box Basic Supply Chain](#) and the [Out of the Box Templates](#) package with the following parameters:

1. (Required) Enable the Carvel Package workflow.

```
ootb_supply_chain_basic:
 carvel_package:
 workflow_enabled: true
```

2. (Optional) Set a GitOps subpath. This verifies the path in your GitOps repository where Carvel Packages are written. Defaults to "". See [Template reference](#).

```
ootb_supply_chain_basic:
 carvel_package:
 workflow_enabled: true
 gitops_subpath: path/to/my/dir
```



- (Optional) Set a name suffix. Carvel Package names are chosen using the `<workload_name>.<workload_namespace>.<name_suffix>` template. Defaults to `tap`. See [Template reference](#).

```
ootb_supply_chain_basic:
 carvel_package:
 workflow_enabled: true
 name_suffix: vmware.com
```

- (Optional) Enable OpenAPIv3 Schema Definition Generation. Defaults to `true`. See [Template reference](#).

```
ootb_supply_chain_basic:
 carvel_package:
 workflow_enabled: true
 openapiv3_enabled: true
```

If the size of the resulting OpenAPIv3 specification exceeds roughly 3 KB, the Supply Chain does not function. See the [known issue](#).

- (Optional) Configure the [Out of the Box Templates](#) with custom Carvel Package parameters. See [Template reference](#).

- Packages created by the Carvel Package Supply Chains contain the [YTT Schema](#) and [YTT Overlays](#).
- Supply Chain decides which YTT Schema and YTT Overlays to use based on the `selector` field. Operators can specify as many labels as they want under `selector.matchLabels`. The `selector` with the highest amount of matching labels is used.

A `selector` is only considered a match if all labels under `selector.matchLabels` match. If there is more than one matching `selector`, the `selector` with more labels is used. If there is more than one matching `selector`, and they have the same amount of labels, the Supply Chain fails. If there is no matching `selector`, the Supply Chain fails.

- The `ootb_templates.carvel_package.openapiv3_enabled = true` package has a [generated OpenAPIv3 API](#) specification.
- Setting `ootb_templates.carvel_package.parameters` overrides the default Carvel Package parameters. If an operator wants to leave the parameters the same for `web` and `worker` types, but add a parameter for `server`, they must copy the default `ootb_templates.carvel_package.parameters` from the template reference, and then make the modification.

```
ootb_templates:
 carvel_package:
 parameters:
 - selector:
 matchLabels:
 apps.tanzu.vmware.com/workload-type: server
 schema: |
 #@data/values-schema

 #@schema/title "Replicas"
 #@schema/desc "Number of replicas."
 replicas: 1
 overlays: |
 #@ load("@ytt:overlay", "overlay")
 #@ load("@ytt:data", "data")
 #@overlay/match by=overlay.subset({"apiVersion":"apps/v1", "kind": "Deployment"})
```

```

spec:
 #@overlay/match missing_ok=True
 replicas: #@ data.values.replicas
copy the existing parameters for worker + web here

```

6. Configure the [Out of the Box Basic Supply Chain](#) package with your GitOps parameters. See [GitOps versus RegistryOps](#).
7. Install the [Out of the Box Basic Supply Chain](#) package.

## Verifying the Carvel Package Supply Chains are Installed

1. Run `kubectl get ClusterSupplyChains`.
2. Confirm you see both `source-to-url-package` and `basic-image-to-url-package` with status `Ready: True`.

## Using the Carvel Package Supply Chains as a Developer

This section describes developer tasks for using the Carvel Package Supply Chains.

### Prerequisites

Your operator must [install the Carvel Package Supply Chains](#).

You must create your workload in a developer namespace. See [Developer namespace](#).

### Create a Workload

To use the Carvel Package Supply Chains, you must add the label `apps.tanzu.vmware.com/carvel-package-workflow=true` to your workload.

1. Use the `--label apps.tanzu.vmware.com/carvel-package-workflow=true` Tanzu CLI flag.

For example:

```

tanzu apps workload create tanzu-java-web-app \
 --namespace DEVELOPER_NAMESPACE \
 --app tanzu-java-web-app \
 --type server \
 --label apps.tanzu.vmware.com/carvel-package-workflow=true \
 --image springcommunity/spring-framework-petclinic

```

Expect to see the following output:

```

Create workload:
1 + |---
2 + |apiVersion: carto.run/v1alpha1
3 + |kind: Workload
4 + |metadata:
5 + | labels:
6 + | app.kubernetes.io/part-of: tanzu-java-web-app
7 + | apps.tanzu.vmware.com/carvel-package-workflow: "true"
8 + | apps.tanzu.vmware.com/workload-type: server
9 + | name: tanzu-java-web-app
10 + | namespace: DEVELOPER_NAMESPACE
11 + |spec:
12 + | image: springcommunity/spring-framework-petclinic

```

You can override most parameters set by the operator.

**Note**

Developers cannot override `carvel_package_parameters` as it presents a security risk.

- (Optional) Set a GitOps subpath. This verifies the path in your GitOps repository where Carvel Packages are written. Defaults to `""`. See [Template reference](#).

Set this parameter by modifying `workload.spec.params.carvel_package_gitops_subpath`, using the `--param carvel_package_gitops_subpath=path/to/my/dir` Tanzu CLI flag.

- (Optional) Set a name suffix. Carvel Package names are chosen using the template `<workload_name>.<workload_namespace>.<name_suffix>`. Defaults to `tap`. See [Template reference](#).

Set this parameter by modifying `workload.spec.params.carvel_package_name_suffix`, using the `--param carvel_package_name_suffix=vmware.com` Tanzu CLI flag.

- (Optional) Enable OpenAPIv3 specification generation. Defaults to `true`. See [Template reference](#).

Set this parameter by modifying `workload.spec.params.carvel_package_openapiv3_enabled`, using the `--param carvel_package_openapiv3_enabled=false` Tanzu CLI flag.

- (Optional) You can override GitOps parameters. See [GitOps versus RegistryOps](#).

## Verify the Carvel Package was Created

Verify that you see a Carvel `Package` stored in your GitOps repository. For example, at the path `tanzu-java-web-app.default.tap/packages/20230321004057.0.0.yaml` you see a valid Carvel `Package` definition.

## Git commit SHA in Package version

By default, the Git revision identifier for the software in the Carvel Package is added to the package version, in the format `+build.${git_commit}`, in the following cases:

- The `source-to-url-package` builds the package and the image building resource is either `kpack-template` or the `kaniko-template`. These templates add the label Git commit SHA of the source code used to the label `org.opencontainers.image.revision` on the OCI image container.
- An OCI image container is used with the label `org.opencontainers.image.revision`. The package version might look similar to `20230518150903.0.0+build.6db88c7` where `6db88c7` is the Git commit SHA.

## Next Steps

You can deploy the Carvel `Package` using tools such as Flux CD or Argo CD. See [Deploy Carvel Packages using Flux CD Kustomization](#).

## Use Gitops delivery with a Carvel app (beta)

This topic explains how you can deliver Carvel `Packages`, created by the Carvel Package Supply Chains, from a GitOps repository to one or more run clusters using Carvel App. You can use Carvel Package Supply Chains with Supply Chain Choreographer.

## Prerequisites

To use GitOps Delivery with Carvel App, you must complete the following prerequisites:

- You must create a [Workload](#) that uses the Carvel Package supply chains. For information about Carvel Packages, see [Carvel Package Supply Chains](#). You must have at least one Carvel [Package](#) generated by this [Workload](#) stored in your GitOps repository.
- You must have at least one run cluster. run clusters serve as your deployment environments. They can either be Tanzu Application Platform clusters, or Kubernetes clusters, but they must have kapp-controller and Contour installed. See the [Carvel documentation](#) and the [Contour documentation](#).
- If you plan to use a build cluster to control the deployment on all of the run clusters, you must create a Build cluster that has network access to your run clusters. If you intend to deploy directly on the run cluster without using a build cluster, a build cluster is only necessary for building the package.

## Set up run cluster namespaces

Each run cluster must have a namespace and [ServiceAccount](#) with the correct permissions to deploy the Carvel [Packages](#), [PackageInstalls](#) and Kubernetes [Secrets](#). Create a namespace and [ServiceAccount](#) with the following permissions:

```

apiVersion: rbac.authorization.k8s.io/v1
kind: Role
metadata:
 namespace: RUN-CLUSTER-NS
 name: app-package-and-pkgi-install-role
rules:
 - apiGroups: ["data.packaging.carvel.dev"]
 resources: ["packages"]
 verbs: ["get", "list", "create", "update", "delete", "patch"]
 - apiGroups: ["packaging.carvel.dev"]
 resources: ["packageinstalls"]
 verbs: ["get", "list", "create", "update", "delete", "patch"]
 - apiGroups: [""]
 resources: ["secrets"]
 verbs: ["get", "list", "create", "update", "delete", "patch"]
```

Where `RUN-CLUSTER-NS` is the run cluster namespace you want to use.

If your run cluster is a Tanzu Application Platform cluster, see [Set up developer namespaces to use your installed packages](#).

If your run cluster is not a Tanzu Application Platform cluster, the [ServiceAccount](#) must also have the following permissions:

```

apiVersion: rbac.authorization.k8s.io/v1
kind: Role
metadata:
 namespace: RUN-CLUSTER-NS
 name: app-cr-role
rules:
 - apiGroups: ["apps"]
 resources: ["deployments"]
 verbs: ["get", "list", "create", "update", "delete"]
 - apiGroups: [""]
 resources: ["configmaps", "services"]
 verbs: ["get", "list", "create", "update", "delete"]
```

```
- apiGroups: ["networking.k8s.io"]
 resources: ["ingresses"]
 verbs: ["get", "list", "create", "update", "delete"]
```

Where `RUN-CLUSTER-NS` is the name of your run cluster you want to create a namespace with.

## Create Carvel PackageInstalls and secrets

For each Carvel `Package` and each run cluster, you must create a Carvel `PackageInstall` and a `Secret`. The Carvel `PackageInstall` and the `Secret` is stored in your GitOps repository and deployed to run clusters by the Carvel `App`.

The following example shows GitOps repository structure after completing the procedures in this section:

```
app.default.tap/
 packages/
 20230321004057.0.0.yaml # Package
 staging/
 packageinstall.yaml # PackageInstall
 params.yaml # Secret
 prod/
 packageinstall.yaml # PackageInstall
 params.yaml # Secret
```

1. For each run cluster, create a `Secret` that has the values for each `Package` parameter. To see the configurable properties of the `Package`, inspect the `Package` CR's valuesSchema. See [Carvel Package Supply Chains](#). Store the `Secret` in your GitOps repository at `PACKAGE-NAME/RUN-CLUSTER/params.yaml`.

```

apiVersion: v1
kind: Secret
metadata:
 name: app-values
stringData:
 values.yaml: |

 workload_name: app
 replicas: 2
 hostname: app.mycompany.com
```

Where:

- o `PACKAGE-NAME` is the name of your Carvel package you want to use.
- o `RUN-CLUSTER` is the name of the run cluster you want to use with the package.



### Note

You must set a value for the `workload_name` parameter. You can skip setting other fields to use the default parameter values.

2. For each run cluster, create a `PackageInstall`. Reference the `Secret` you created earlier. Store the `PackageInstall` in your GitOps repository at `PACKAGE-NAME/RUN-CLUSTER/packageinstall.yaml`.

```

apiVersion: packaging.carvel.dev/v1alpha1
kind: PackageInstall
```

```

metadata:
 name: app
spec:
 serviceAccountName: RUN-CLUSTER-NS-SA # ServiceAccount on run cluster with pe
rmissions to deploy Package, see "Set up run Cluster Namespaces"
 packageRef:
 refName: app.default.tap # name of the Package
 versionSelection:
 constraints: 20230321004057.0.0 # version of the Package
 values:
 - secretRef:
 name: app-values # Secret created in previous step

```

Where:

- `PACKAGE-NAME` is the name of your Carvel package you want to use.
- `RUN-CLUSTER` is the name of the run cluster you want to use with the package.
- `RUN-CLUSTER-NS-SA` is the ServiceAccount on your run cluster with permissions to deploy the package.

To continuously deploy the latest version of your `Package`, set `versionSelection.constraints: >=0.0.0`. To revert to a previous version, update the `versionSelection.constraints` field and annotate the `PackageInstall`:

```
packaging.carvel.dev/downgradable: ""
```

See the [Carvel documentation](#).

1. Push the `PackageInstalls` and `Secrets` to your GitOps repository.

## Create an app

To create an app:

1. You must give the build cluster access to the run clusters. On the build cluster create a `Secret` containing the run cluster's kubeconfig for each run cluster:

```

kubectl create secret generic RUN-CLUSTER-kubeconfig \
 -n BUILD-CLUSTER-NS \
 --from-file=value.yaml=PATH-TO-RUN-CLUSTER-KUBECONFIG

```

Where:

- `RUN-CLUSTER` is the name of the run cluster you want to use with your app.
  - `BUILD-CLUSTER-NS` is the namespace of the build cluster you want to use.
  - `PATH-TO-RUN-CLUSTER-KUBECONFIG` is the location of your run cluster kubeconfig.
2. Each Carvel `App` custom resource (CR) must specify either a service account, by using `spec.serviceAccountName`, in the same namespace where the App CR is located on the Build cluster. Or specify a `Secret` with kubeconfig contents for a target destination run cluster, by using `spec.cluster.kubeconfigSecretRef.name`, to explicitly provide the privileges required for managing app resources. The example in this section uses a target run cluster.
  3. The `Carvel App` custom resource represents a collection of Kubernetes resources that kapp-controller can fetch and deploy to a cluster.

The `App` points at the Git repository branch where kapp-controller resources, such as `PackageRepository` and `Packages`, are defined. By default, an `App` custom resource syncs the

cluster with its fetch source every 30 seconds to prevent the cluster state from drifting from its source of truth. Create the following `App` on your Build cluster:

```

apiVersion: kappctrl.k14s.io/v1alpha1
kind: App
metadata:
 name: hello-app-app
 namespace: BUILD-CLUSTER-NS
spec:
 # specifies that app should be deployed to destination cluster;
 # by default, cluster is same as where this resource resides
 cluster:
 # specifies namespace in destination cluster
 namespace: ns2
 # specifies secret containing kubeconfig
 kubeconfigSecretRef:
 # specifies secret name within app's namespace
 name: cluster1
 # specifies key that contains kubeconfig
 key: value
 fetch:
 - git:
 url: # GitOps repo URL ex: https://github.com/mycompany/my-gitops
 ref: # GitOps repo branch ex: origin/main
 subPath: PATH-FOR-PACKAGES # ex: hello-app.dev.tap/packages/
 - git:
 url: # GitOps repo URL ex: https://github.com/mycompany/my-gitops
 ref: # GitOps repo branch ex: origin/main
 subPath: PATH-FOR-PACKAGE-INSTALLS # ex: hello-app.dev.tap/runcluster1
 template:
 - ytt: {}

 deploy:
 - kapp:
 intoNs: DESIRED-NAMESPACE
 rawOptions: ["--dangerous-allow-empty-list-of-resources=true"]
```

Where:

- `DESIRED-NAMESPACE` is the namespace you want to use with your app.
- `PATH-FOR-PACKAGE-INSTALLS` is the package install path.
- `PATH-FOR-PACKAGES` is the package path.
- `BUILD-CLUSTER-NS` is the build cluster namespace.



#### Note

The fetch section includes entries for all the locations in the GitOps repository to deploy, and append with other run clusters if needed.

## Verify applications

To verify your installation:

1. Target a run cluster. Confirm that all Packages from the GitOps repository are deployed:

```
kubectl get packages -A
```

2. Target a run cluster. Confirm that all PackageInstalls are reconciled:

```
kubectl get packageinstalls -A
```

You can access your application on each run cluster.

## Use Gitops delivery with Flux CD (beta)

This topic explains how you can deliver Carvel [Packages](#), created by the Carvel Package Supply Chains, from a GitOps repository to one or more run clusters using Flux CD and Supply Chain Choreographer.

## Prerequisites

To use Gitops Delivery with Flux CD, you must complete the following prerequisites:

- You must create a [Workload](#) that uses either the [source-to-url-package](#) Or [basic-image-to-url-package](#) Carvel Package Supply Chain. See the [Carvel documentation](#). You must have at least one Carvel [Package](#) generated by this [Workload](#) stored in your GitOps repository.
- You must have at least one run cluster. run clusters serve as your deployment environments. They can either be Tanzu Application Platform clusters, or regular Kubernetes clusters, but they must have kapp-controller and Contour installed. See the [Carvel documentation](#) and the [Contour documentation](#).
- To use a build cluster to control the deployment on all the run clusters, you must create a build cluster that has network access to your run clusters. You must also ensure that you installed Flux CD Kustomize Controller. See the [Flux documentation](#) for installation instructions. If you intend to deploy directly on the run cluster without a build cluster, a build cluster is only necessary for building the package.

## Set up run cluster namespaces

Each run cluster must have a namespace and [ServiceAccount](#) with the correct permissions to deploy the Carvel [Packages](#), [PackageInstalls](#) and Kubernetes [Secrets](#). Create a namespace and [ServiceAccount](#) with the following permissions:

```

apiVersion: rbac.authorization.k8s.io/v1
kind: Role
metadata:
 namespace: <run-cluster-ns>
 name: app-package-and-pkgi-install-role
rules:
- apiGroups: ["data.packaging.carvel.dev"]
 resources: ["packages"]
 verbs: ["get", "list", "create", "update", "delete", "patch"]
- apiGroups: ["packaging.carvel.dev"]
 resources: ["packageinstalls"]
 verbs: ["get", "list", "create", "update", "delete", "patch"]
- apiGroups: [""]
 resources: ["secrets"]
 verbs: ["get", "list", "create", "update", "delete", "patch"]
```

If your run cluster is a Tanzu Application Platform cluster, see [Set up developer namespaces to use your installed packages](#).

If your run cluster is not a Tanzu Application Platform cluster, the [ServiceAccount](#) must also have the following permissions:



```

apiVersion: rbac.authorization.k8s.io/v1
kind: Role
metadata:
 namespace: <run-cluster-ns>
 name: app-cr-role
rules:
- apiGroups: ["apps"]
 resources: ["deployments"]
 verbs: ["get", "list", "create", "update", "delete"]
- apiGroups: [""]
 resources: ["configmaps", "services"]
 verbs: ["get", "list", "create", "update", "delete"]
- apiGroups: ["networking.k8s.io"]
 resources: ["ingresses"]
 verbs: ["get", "list", "create", "update", "delete"]

```

## Create Carvel PackageInstalls and secrets

For each Carvel [Package](#) and for each run cluster, you must create a Carvel [PackageInstall](#) and a [Secret](#). The Carvel [PackageInstall](#) and the [Secret](#) are stored in your GitOps repository and deployed to run clusters by Flux CD.

The following example shows GitOps repository structure after completing this section:

```

app.default.tap/
 packages/
 20230321004057.0.0.yaml # Package
 staging/
 packageinstall.yaml # PackageInstall
 params.yaml # Secret
 prod/
 packageinstall.yaml # PackageInstall
 params.yaml # Secret

```

1. For each run cluster, create a [Secret](#) that has the values for each [Package](#) parameter. You can see the configurable properties of the [Package](#) by inspecting the [Package](#) CR's valuesSchema, or in the [Carvel Package Supply Chains](#) documentation. Store the [Secret](#) in your GitOps repository at `<package_name>/<run_cluster>/params.yaml`.

```

apiVersion: v1
kind: Secret
metadata:
 name: app-values
stringData:
 values.yaml: |

 workload_name: app
 replicas: 2
 hostname: app.mycompany.com

```



### Note

You must set a value for the `workload_name` parameter. You can skip setting other fields to use the default parameter values.

2. For each run cluster, create a [PackageInstall](#). Reference the [Secret](#) you created earlier. Store the [PackageInstall](#) in your GitOps repository at

```
<package_name>/<run_cluster>/packageinstall.yaml.
```

```

apiVersion: packaging.carvel.dev/v1alpha1
kind: PackageInstall
metadata:
 name: app
spec:
 serviceAccountName: <run-cluster-ns-sa> # ServiceAccount on run cluster with
 permissions to deploy Package, see "Set up run Cluster Namespaces"
 packageRef:
 refName: app.default.tap # name of the Package
 versionSelection:
 constraints: 20230321004057.0.0 # version of the Package
 values:
 - secretRef:
 name: app-values # Secret created in previous step
```

3. To continuously deploy the latest version of your `Package`, set `versionSelection.constraints: >=0.0.0`. To revert to a previous version, update the `versionSelection.constraints` field and annotate the `PackageInstall`:

```
packaging.carvel.dev/downgradable: ""
```

See the [Carvel documentation](#).

1. Push the newly created `PackageInstalls` and `Secrets` to your GitOps repository.

## Create Flux CD GitRepository and Flux CD Kustomizations on the build cluster

Configure Flux CD on the Build cluster to deploy your `Packages`, `PackageInstalls`, and `Secrets` to each of your run clusters.

1. Give your Build cluster access to your run clusters. On the Build cluster, for each run cluster, create a `Secret` containing the run cluster's kubeconfig. Create the Kubernetes `Secret` in the same namespace as the Kustomization resource:

```
kubectl create secret generic <run-cluster>-kubeconfig \
 -n <build-cluster-ns> \
 --from-file=value.yaml=<path-to-run-cluster-kubeconfig>
```

2. Configure your Build cluster to clone the GitOps repository. On the Build cluster, create the following Flux CD `GitRepository`:

```

apiVersion: source.toolkit.fluxcd.io/v1beta2
kind: GitRepository
metadata:
 name: <package-name>-gitops-repo
 namespace: <build-cluster-ns>
spec:
 url: # GitOps repo URL
 ignore: |
 !.git
 interval: 30s
 ref:
 branch: # GitOps repo branch
 timeout: 60s

 # only required if GitOps repo is private (recommended). The secret below sh
```

```

ould be present in the same namespace as the GitRepository.
 secretRef:
 name: <package-name>-gitops-auth

only required if GitOps repo is private (recommended)

apiVersion: v1
kind: Secret
metadata:
 name: <package-name>-gitops-auth
 namespace: <build-cluster-ns>
type: Opaque
data:
 username: # base64 encoded GitHub (or other git remote) username
 password: # base64 encoded GitHub (or other git remote) personal access token
n

```

3. Configure your Build cluster to deploy your `Package` to the run clusters. For each run cluster, on the Build cluster, create the following Flux CD `Kustomization`:

```

apiVersion: kustomize.toolkit.fluxcd.io/v1beta2
kind: Kustomization
metadata:
 name: <package-name>-<run-cluster>-packages
 namespace: <build-cluster-ns>
spec:
 sourceRef:
 kind: GitRepository
 name: <package-name>-gitops-repo
 namespace: <build-cluster-ns>
 path: "./<package-name>/packages"
 interval: 5m
 timeout: 5m
 prune: true
 wait: true

where to deploy
kubeConfig:
 secretRef:
 name: <run-cluster>-kubeconfig
 targetNamespace: <run-cluster-ns>
 serviceAccountName: <run-cluster-ns-sa>

```



#### Note

The Kustomization resource does not accept a `metadata.name` field longer than 63 characters.

4. Configure your Build cluster to deploy your `PackageInstalls` and `Secrets` to the run clusters. For each run cluster, on the Build cluster, create the following Flux CD `Kustomization`:

```

apiVersion: kustomize.toolkit.fluxcd.io/v1beta2
kind: Kustomization
metadata:
 # for the second run cluster, for example hello-app-prod2-packages
 name: <package-name>-<run-cluster>-packageinstalls
 namespace: <build-cluster-ns>
spec:
 sourceRef:

```

```

kind: GitRepository
name: <package-name>-gitops-repo
namespace: <build-cluster-ns>
path: "./<package-name>/<run-cluster>"
interval: 5m
timeout: 5m
prune: true
wait: true

where to deploy
kubeConfig:
 secretRef:
 name: <run-cluster>-kubeconfig
targetNamespace: <run-cluster-ns>
serviceAccountName: <run-cluster-ns-sa>

```



### Note

The Kustomization resource does not accept a `metadata.name` field longer than 63 characters.

## Verify installation

To verify your installation:

1. On your Build cluster, confirm that your Flux CD GitRepository and Kustomizations are reconciling:

```
kubectl get gitrepositories,kustomizations -A
```

2. Target a run cluster. Confirm that all Packages from the GitOps repository are deployed:

```
kubectl get packages -A
```

3. Target a run cluster. Confirm that all PackageInstalls are reconciled:

```
kubectl get packageinstalls -A
```

Now you can access your application on each run cluster.

## Use Gitops delivery with Argo CD (beta)

This topic explains how you can deliver Carvel [Packages](#), created by the Carvel Package Supply Chains, from a GitOps repository to one or more run clusters using Argo CD for Supply Chain Choreographer.

## Prerequisites

To use Gitops Delivery with Argo CD, you must complete the following prerequisites:

- Create a [Workload](#) that uses either the [source-to-url-package](#) or [basic-image-to-url-package](#) Carvel Package Supply Chain. See the [Carvel documentation](#). You must have at least one Carvel [Package](#) generated by this [Workload](#) stored in your GitOps repository.
- Have at least one run cluster. Run clusters serve as your deployment environments. They can either be Tanzu Application Platform clusters, or Kubernetes clusters, but they must

have kapp-controller and Contour installed. See the [Carvel documentation](#) and the [Contour documentation](#).

- Create a build cluster that has network access to your run clusters to use a build cluster to control the deployment on all the run clusters. You must also install Argo CD. If you intend to deploy directly on the run cluster without a build cluster, a build cluster is only necessary for building the package.

## Set up run cluster namespaces

Each run cluster must have a namespace and [ServiceAccount](#) with the correct permissions to deploy the Carvel [Packages](#).

If your run cluster is a Tanzu Application Platform cluster, see [Set up developer namespaces to use installed packages](#).

If your run cluster is not a Tanzu Application Platform cluster, create a namespace and [ServiceAccount](#) with the following permissions:

```

apiVersion: rbac.authorization.k8s.io/v1
kind: Role
metadata:
 namespace: <run-cluster-ns>
 name: app-cr-role
rules:
- apiGroups: ["apps"]
 resources: ["deployments"]
 verbs: ["get", "list", "create", "update", "delete"]
- apiGroups: [""]
 resources: ["configmaps", "services"]
 verbs: ["get", "list", "create", "update", "delete"]
- apiGroups: ["networking.k8s.io"]
 resources: ["ingresses"]
 verbs: ["get", "list", "create", "update", "delete"]
```

## Create Carvel PackageInstalls and secrets

For each Carvel [Package](#) and run cluster, you must create a Carvel [PackageInstall](#) and a [Secret](#). The Carvel [PackageInstall](#) and the [Secret](#) are stored in your GitOps repository and deployed to run clusters by Flux CD.

The following example shows a GitOps repository structure after completing this section:

```
app.default.tap/
 packages/
 20230321004057.0.0.yaml # Package
 staging/
 packageinstall.yaml # PackageInstall
 params.yaml # Secret
 prod/
 packageinstall.yaml # PackageInstall
 params.yaml # Secret
```

For each run cluster:

1. Create a [Secret](#) that has the values for each [Package](#) parameter. You can view the configurable properties of the [Package](#) by inspecting the [Package](#) CR's valuesSchema, or in the [Carvel Package Supply Chains documentation](#). Store the [Secret](#) in your GitOps repository at `<package_name>/<run_cluster>/params.yaml`.

**Note**

You can skip this step to use the default parameter values.

```

apiVersion: v1
kind: Secret
metadata:
 name: app-values
stringData:
 values.yaml: |

 workload_name: app
 replicas: 2
 hostname: app.mycompany.com
```

2. Create a `PackageInstall`. Reference the `Secret` you created earlier. Store the `PackageInstall` in your GitOps repository at `<package_name>/<run_cluster>/packageinstall.yaml`.

**Note**

If you skipped creation of the `Secret`, omit the `values` key.

```

apiVersion: packaging.carvel.dev/v1alpha1
kind: PackageInstall
metadata:
 name: app
spec:
 serviceAccountName: <run-cluster-ns-sa> # ServiceAccount on run cluster with
permissions to deploy Package, see "Set up run Cluster Namespaces"
 packageRef:
 refName: app.default.tap # name of the Package
 versionSelection:
 constraints: 20230321004057.0.0 # version of the Package
 values:
 - secretRef:
 name: app-values # Secret created in previous step
```

**Note**

To continuously deploy the latest version of your `Package`, you can set `versionSelection.constraints: >=0.0.0`

3. Push the `PackageInstalls` and `Secrets` to your GitOps repository.

## Create an Argo CD application on the Build cluster

Configure Argo CD on the Build cluster to deploy your `Packages`, `PackageInstalls`, and `Secrets` to each run cluster.

**Note**

You start by registering a cluster's credentials to Argo CD. This is only necessary when deploying to an external cluster.

1. First list all clusters contexts in your current kubeconfig:

```
kubectl config get-contexts -o name
```

2. Choose a context name from the list and supply it to the argocd cluster. This command installs a ServiceAccount, argocd-manager, into the kube-system namespace of that kubectl context, binding the service account to an admin-level ClusterRole. Argo CD uses this service account token to perform its management tasks, such as deployment and monitoring.

For example, for `run-cluster1` context, run:

```
argocd cluster add run-cluster-1
```



#### Note

You can modify the rules of the argocd-manager-role role so that it only has create, update, patch, delete privileges to a limited set of namespaces, groups, kinds. However get, list, and watch privileges are required at the cluster-scope.

3. Set the current namespace to argocd:

```
kubectl config set-context --current --namespace=argocd
```

4. Create `hello-world-app`:

```
argocd app create hello-world-app --repo https://github.com/mycompany/gitops-repo
```

5. After you create the application, you can view its status by running:

```
argocd app get hello-world-app
```

The output is similar to the following:

```
Name: hello-world-app
Server: https://kubernetes.default.svc
Namespace: default
URL: https://10.97.164.88/applications/hello-world-app
Repo: https://github.com/mycompany/gitops-repo.git
Target:
Path: hello-world-app
Sync Policy: <none>
Sync Status: OutOfSync from (1ff8a67)
Health Status: Missing

GROUP KIND NAMESPACE NAME STATUS HEALTH
apps Deployment default hello-world-app-dep OutOfSync Missing
 Service default hello-world-app-svc OutOfSync Missing
```

This command retrieves the manifests from the repository and performs a kubectl apply. The hello-world-app app is running and you can now view its resource components, logs, events, and health status.

- The application status is initially in OutOfSync state since the application has yet to be deployed, and no Kubernetes resources have been created. To sync (deploy) the application, run:

```
argocd app sync hello-world-app
```

## Verify installation

To verify your installation:

- On your Build cluster, confirm that your Flux CD GitRepository and Kustomizations are reconciling by running:

```
kubectl get gitrepositories,kustomizations -A
```

- Target a run cluster. Confirm that all Packages from the GitOps repository are deployed by running:

```
kubectl get packages -A
```

- Target a run cluster. Confirm that all PackageInstalls are reconciled by running:

```
kubectl get packageinstalls -A
```

Now you can access your application on each run cluster.

## Use blue-green deployment with Contour and PackageInstall for Supply Chain Choreographer (beta)

Blue-green deployment is an application delivery model that lets you gradually transfer user traffic from one version of your app to a later version while both are running in production. This topic outlines how to use blue-green deployment with Packages and PackageInstalls.

### Prerequisites

To use blue-green deployment, you must complete the following prerequisites:

- Complete the prerequisites in [Configure and deploy to multiple environments with custom parameters](#).
- Configure Carvel for your supply chain. See [Carvel Package Supply Chains \(beta\)](#).
- Configure Flux CD for your supply chain. See [Deploy Package and PackageInstall using Flux CD Kustomization](#).

### Add HTTPProxy to the blue deployment

The following example deploys a sample application, `hello-app`, to production using a Carvel Package and PackageInstall.

- Create a [Contour HTTPProxy](#) resource to route traffic to the `hello-app` service from the URL `www.hello-app.mycompany.com`.

```
apiVersion: projectcontour.io/v1
kind: HTTPProxy
metadata:
 name: www
```



```

namespace: prod
spec:
 virtualhost:
 fqdn: www.hello-app.mycompany.com
 routes:
 - conditions:
 - prefix: /
 services:
 - name: hello-app
 port: 8080

```



### Note

The services names used in HTTPProxy has to match the names of existing services. In this case, the name `hello-app` matches the service installed by the PackageInstall.

2. Apply the HTTPProxy to your cluster:

```
kubectl apply -f httpproxy.yaml
```

3. Verify that the HTTPProxy is present and the route serves traffic to your app.

```
kubectl get HTTPProxy --namespace=prod
```

This displays a list of all the HTTPproxies in the current namespace with their current names.

```

$ kubectl get HTTPProxy --namespace=prod
NAMESPACE NAME STATUS STATUS DESCRIPTION
prod www valid Valid HTTPProxy
hello-app-cert

```

## Create the green deployment

After a new version of the package is added to the GitOps repository, create a new PackageInstall for v1.0.1 to create the green deployment.

1. Create a `green-secret.yaml` file with a secret that contains the following ytt overlay.

```

apiVersion: v1
kind: Secret
metadata:
 name: green-overlay-secret
 namespace: prod
stringData:
 custom-package-overlay.yaml: |
 #@ load("@ytt:overlay", "overlay")

 #@ kd = overlay.subset({"apiVersion":"apps/v1", "kind": "Deployment"})
 #@ ks = overlay.subset({"apiVersion":"v1", "kind": "Service"})
 #@ ki = overlay.subset({"apiVersion":"networking.k8s.io/v1", "kind": "Ingre
ss"})
 #@ na = overlay.subset({"metadata":{"name":"hello-app"}})

 #@overlay/match by=overlay.and_op(kd, na)

metadata:

```

```

#@overlay/replace
name: hello-app-green

#@overlay/match by=overlay.and_op(ks, na)

metadata:
 #@overlay/replace
 name: hello-app-green

#@overlay/match by=overlay.and_op(ki, na)

metadata:
 #@overlay/replace
 name: hello-app-green

```

This secret changes the names of the service and deployment in the Carvel Package to allow you to install another version of the app in the same namespace.

2. Apply the secret to your cluster by running:

```
kubectl apply -f green-secret.yaml
```

3. Create a parameter secret for the new PackageInstall:

```

apiVersion: v1
kind: Secret
metadata:
 name: green-dev-values
 namespace: prod
stringData:
 values.yaml: |

 replicas: 2
 hostname: hello-app-green.mycompany.com

```

4. Apply the parameter secret to your cluster by running:

```
kubectl apply -f green-dev-values.yaml
```

5. Create a PackageInstall to include the `ext.packaging.carvel.dev/ytt-paths-from-secret-name.x` annotation to reference your new overlay secret.

```

apiVersion: packaging.carvel.dev/v1alpha1
kind: PackageInstall
metadata:
 name: green.hello-app.dev.tap
 namespace: prod
 annotations:
 ext.packaging.carvel.dev/ytt-paths-from-secret-name.0: green-overlay-secret
spec:
 serviceAccountName: default
 packageRef:
 refName: hello-app.dev.tap
 versionSelection:
 constraints: "1.0.1"
 values:
 - secretRef:
 name: green-dev-values

```

## Divide traffic between the blue and green deployments

Use the following procedure to divide traffic between your blue and green deployments.

1. Update the HTTPProxy created with the blue deployment to route traffic to both the blue and green deployments. The names of the services must match the names of the already created services.

```

apiVersion: projectcontour.io/v1
kind: HTTPProxy
metadata:
 name: www
 namespace: prod
spec:
 virtualhost:
 fqdn: www.hello-app.mycompany.com
 routes:
 - conditions:
 - prefix: /
 services:
 - name: hello-app-green
 port: 8080
 weight: 20
 - name: hello-app
 port: 8080
 weight: 80
```

2. Update the weights of traffic for each service by editing the HTTPProxy.
3. Access the service several times and confirm both versions are serving traffic in the same percentage.

```
curl -k https://www.hello-app.mycompany.com
```

After the new green app is ready to handle the complete load and the `-green` version is not required, use the following steps to remove the old version and rename the new version:

1. Ensure that all the traffic is using the correct version of the app. For example:

```
apiVersion: projectcontour.io/v1
kind: HTTPProxy
metadata:
 name: www
 namespace: prod
spec:
 virtualhost:
 fqdn: www.hello-app.mycompany.com
 routes:
 - conditions:
 - prefix: /
 services:
 - name: hello-app-green
 port: 8080
 weight: 100 # all traffic routed to the green app
```

2. Identify the name of the deployment and service that are part of the PackageInstall you no longer need:

```
kubectl get PackageInstall --namespace=prod
```

This displays a list of all the deployments and services in the current Kubernetes namespace, with their current names. For example:

NAME	PACKAGE NAME	PACKAGE VERSION	DESCRIPTION
green.hello-app.dev.tap	hello-app.dev.tap	1.0.1	Reconcile succeeded
hello-app.dev.tap	hello-app.dev.tap	1.0.0	Reconcile succeeded

### 3. Delete the PackageInstall:

```
kubectl delete PackageInstall hello-app.dev.tap --namespace=prod
```

### 4. Rename the service and deployments without the green prefix. For example, update the overlay secret:

```

apiVersion: v1
kind: Secret
metadata:
 name: overlay-secret
 namespace: prod
stringData:
 custom-package-overlay.yaml: |
 #@ load("@ytt:overlay", "overlay")
 #@ load("@ytt:data", "data")

 #@ kd = overlay.subset({"apiVersion":"apps/v1", "kind": "Deployment"})
 #@ ks = overlay.subset({"apiVersion":"v1", "kind": "Service"})
 #@ ki = overlay.subset({"apiVersion":"networking.k8s.io/v1", "kind": "Ingress"})
 #@ na = overlay.subset({"metadata":{"name":"hello-app-green"}})

 #@overlay/match by=overlay.and_op(kd, na)

 metadata:
 #@overlay/replace
 name: hello-app

 #@overlay/match by=overlay.and_op(ks, na)

 metadata:
 #@overlay/replace
 name: hello-app

 #@overlay/match by=overlay.and_op(ki, na)

 metadata:
 #@overlay/replace
 name: hello-app

apiVersion: projectcontour.io/v1
kind: HTTPProxy
metadata:
 name: www
 namespace: prod
spec:
 virtualhost:
 fqdn: www.hello-app.mycompany.com
 routes:
 - conditions:
 - prefix: /
 services:
 - name: hello-app # note the name is changed back
 port: 8080
 weight: 100
```

- Update your PackageInstall to include the `ext.packaging.carvel.dev/ytt-paths-from-secret-name.x` annotation to reference your new overlay secret. For example:

```

apiVersion: packaging.carvel.dev/v1alpha1
kind: PackageInstall
metadata:
 name: green.hello-app.dev.tap
 namespace: prod
 annotations:
 ext.packaging.carvel.dev/ytt-paths-from-secret-name.0: overlay-secret
spec:
 serviceAccountName: default
 packageRef:
 refName: hello-app.dev.tap
 versionSelection:
 constraints: "1.0.1"
 values:
 - secretRef:
 name: hello-app-values
```

- After the deployment is complete, you can delete the secrets with the overlays.

## Verify application

Verify the name of the deployment and service that are part of the PackageInstall by running:

```
kubectl get PackageInstall --namespace=prod
```

This displays a list of all the deployments and services in the current Kubernetes namespace with their current names. For example:

NAME	PACKAGE NAME	PACKAGE VERSION	DESCRIPTION
hello-app.dev.tap	hello-app.dev.tap	1.0.1	Reconcile succeeded

The name is back to the original name and the version is `1.0.1`.

## Use canary deployment with Contour and Carvel packages for Supply Chain Choreographer (beta)

This topic tells you how to automate canary releases using Contour ingress controller and Flagger with Packages and PackageInstalls.

Canary deployment is an incremental approach to releasing an application where traffic is divided between the existing deployed version and a new version. It introduces the new version to a smaller group of users before extending it to the entire user base.

## Prerequisites

To use canary deployment, you must complete the following prerequisites:

- Complete the prerequisites in [Configure and deploy to multiple environments with custom parameters](#).
- Configure your Supply Chain to output Carvel Packages. See [Output Carvel Packages from your Supply Chain](#).
- Deploy Carvel Packages using the tool of your choice:
  - [Deploy Carvel Packages using Carvel App CR](#)

- [Deploy Carvel Packages using Flux CD Kustomization](#)
- [Deploy Carvel Packages using Argo CD](#)
- Install Flagger on your Kubernetes cluster. See [Flagger Install on Kubernetes](#).

## How to use Contour ingress controller and Flagger to create a canary release

Flagger is a tool that facilitates a controlled process of shifting traffic to a canary deployment while monitoring essential performance metrics, such as the success rate of HTTP requests, average request duration, and the health of the application's pods. By analyzing these key indicators, Flagger decides whether to promote the canary deployment to a wider audience or abort it if any issues arise.

For information about creating canary releases, see [Contour canary Deployments](#) in the Flagger documentation.

Using Contour ingress controller and Flagger to create a canary release involves the following steps:

1. Install Flagger on your Kubernetes cluster.
2. Add the label `app.kubernetes.io/name` to your `Workload`.

The target deployment must have a single label selector in the format `app: <DEPLOYMENT-NAME>`. In addition to `app`, Flagger supports `name` and `app.kubernetes.io/name` selectors.



### Note

You can use `tanzu apps workload apply <WORKLOAD-NAME> --label "app.kubernetes.io/name=<WORKLOAD-NAME>"` to edit an existing workload and add the required label.

3. Create a canary resource that defines a canary release with progressive traffic shifting.

To configure the canary resource, you must specify the Kubernetes Deployment that corresponds to your `Workload`. Ensure that you set `spec.targetRef.name` to match the name of your Tanzu Application Platform `Workload`, which is the same as its Kubernetes Deployment name.

Flagger generates some Kubernetes objects. The primary deployment represents the stable release of your application. It receives all incoming traffic while the target deployment is scaled down to zero. Flagger monitors changes in the target deployment, including secrets and configmaps. Before promoting the new version as the primary release, Flagger conducts a thorough canary analysis to ensure that it is stable.

In the canary resource, you can define the canary analysis. Flagger uses this analysis definition to verify the duration of the canary phase, which runs periodically until it reaches the maximum traffic weight or the specified number of iterations.

During each iteration, Flagger executes webhooks, evaluates metrics, and checks for any exceeded failed checks threshold. If the threshold is surpassed, indicating potential issues, Flagger takes immediate action to halt the analysis and roll back the canary. If no issues are found, Flagger rolls out the new version as the primary release.

An example of a canary resource created for a workload, called `tanzu-java-web-app`, is deployed in the namespace `dev-namespace`. Replace `myapps.tanzu.biz` with your own domain:

```

apiVersion: flagger.app/v1beta1
kind: Canary
metadata:
 name: tanzu-java-web-app
 namespace: dev-namespace
spec:
 # deployment reference
 targetRef:
 apiVersion: apps/v1
 kind: Deployment
 name: tanzu-java-web-app
 service:
 # name of the Kubernetes service generated by Flagger. Defaults to spec.targetRef.name
 name: tanzu-java-web-app-flagger-service
 # service port
 port: 80
 # container port
 targetPort: 8080
 # Contour request timeout
 timeout: 15s
 # Contour retry policy
 retries:
 attempts: 3
 perTryTimeout: 5s
 # supported values for retryOn - https://projectcontour.io/docs/main/configuration/api/#projectcontour.io/v1.RetryOn
 retryOn: "5xx"
 # define the canary analysis timing and KPIs
 analysis:
 # schedule interval (default 60s)
 interval: 30s
 # max number of failed metric checks before rollback
 threshold: 5
 # max traffic percentage routed to canary
 # percentage (0-100)
 maxWeight: 50
 # canary increment step
 # percentage (0-100)
 stepWeight: 5
 # Contour Prometheus checks
 metrics:
 - name: request-success-rate
 # minimum req success rate (non 5xx responses)
 # percentage (0-100)
 thresholdRange:
 min: 99
 interval: 1m
 - name: request-duration
 # maximum req duration P99 in milliseconds
 thresholdRange:
 max: 500
 interval: 30s
 # testing
 webhooks:
 - name: acceptance-test
 type: pre-rollout
 url: http://flagger-loadtester.test/
 timeout: 30s
 metadata:
 type: bash
 cmd: "curl -s http://tanzu-java-web-app-flagger-service-canary.dev-namespace | grep Greetings"
 - name: load-test
 url: http://flagger-loadtester.test/
 type: rollout

```

```

 timeout: 5s
 metadata:
 cmd: "hey -z 1m -q 10 -c 2 -host tanzu-java-web-app.myapps.tanzu.biz
http://envoy.tanzu-system-ingress"

```

4. Save the resource you created as `canary.yaml` and apply it to your cluster:

```

export WORKLOAD_NAMESPACE=dev-namespace
kubectl apply -n $WORKLOAD_NAMESPACE -f canary.yaml

```

In the earlier example, you use the load testing service `flagger-loadtester` to generate traffic during the canary analysis.

5. Install the load testing service by running:

```

kubectl create ns test
kubectl apply -k https://github.com/fluxcd/flagger//kustomize/tester?ref=main

```

6. Add an HTTPProxy to include the proxy generated by Flagger.

The following example HTTPProxy resource references `tanzu-java-web-app-flagger-service` and is deployed in the namespace `dev-namespace`:

```

apiVersion: projectcontour.io/v1
kind: HTTPProxy
metadata:
 name: tanzu-java-web-app-ingress
 namespace: dev-namespace
spec:
 virtualhost:
 fqdn: tanzu-java-web-app.myapps.tanzu.biz
 includes:
 - name: tanzu-java-web-app-flagger-service
 namespace: dev-namespace
 conditions:
 - prefix: /

```

7. Save the resource you created as `httpproxy.yaml` and then apply it to your cluster by running:

```

export WORKLOAD_NAMESPACE=dev-namespace
kubectl apply -n $WORKLOAD_NAMESPACE -f httpproxy.yaml

```

8. Confirm the HTTPProxy created by Contour has `Valid` status by running:

```

kubectl get httpproxies -n $WORKLOAD_NAMESPACE

```

9. Make changes to GitOps repository and observe the progressive delivery in action. As changes are made to your GitOps repository, the GitOps tools in place in your environment, such as Flux CD and Argo CD, deploy the new `Packages` onto your clusters.

Flagger detects any changes to the target deployment, including secrets and configmaps, and starts a new rollout. The new version is either promoted or rolled back.

You can monitor the traffic shifting by running:

```

watch kubectl get canary -n $WORKLOAD_NAMESPACE
kubectl describe canary
CANARY-RESOURCE-NAME -n $WORKLOAD_NAMESPACE

```

Where `CANARY-RESOURCE-NAME` is the name of the canary resource you want to use.



## References and further reading

The following topics give you more information about canary:

- [Deployment Strategies](#)
- [Contour canary Deployments](#)
- [Flagger - How it works](#)

## Use an existing image with Supply Chain Choreographer

This topic describes how you can use an existing image with Supply Chain Choreographer.

For apps that build container images in a predefined way, the supply chains in the Out of the Box packages enable you to specify a prebuilt image. This uses the same stages as any other workload.

## Requirements for prebuilt images

Supply chains aim at Knative as the runtime for the container image you provide. Your app must adhere to the following Knative standards:

- **Container port listens on port 8080**

The Knative service is created with the container port set to 8080 in the pod template spec. Therefore, your container image must have a socket listening on 8080.

```
ports:
 - containerPort: 8080
 name: user-port
 protocol: TCP
```

- **Non-privileged user ID**

By default, the container initiated as part of the pod is run as user 1000.

```
securityContext:
 runAsUser: 1000
```

- **Arguments other than the image's default ENTRYPOINT**

In most cases the container image runs using the `ENTRYPOINT` it was configured with. In the case of Dockerfiles, the combination of `ENTRYPOINT` and `CMD`.

If you need extra configuration for your image, use `--env` flags with the `tanzu apps workload create` command or modify `spec.env` in your `workload.yaml` file.

- **Credentials for pulling the container image at runtime**

The image you provide is not relocated to an internal container image registry. Any components associated with the image must have the necessary credentials to pull it. For the service accounts used for the workload and deliverable, you must attach a secret that contains the credentials to pull the container image.

If the image is hosted in a registry that has certificates signed by a private certificate authority, the components of the supply chains, delivery, and the Kubernetes nodes in the run cluster must trust the certificate.

## Configure your workload to use a prebuilt image

To select a prebuilt image, set the `spec.image` field in your `workload.yaml` file with the name of the container image that contains the app to deploy by running:

```
tanzu apps workload create WORKLOAD-NAME \
 --app APP-NAME \
 --type TYPE \
 --image IMAGE
```

Where:

- `WORKLOAD-NAME` is the name you choose for your workload.
- `APP-NAME` is the name of your app.
- `TYPE` is the type of your app.
- `IMAGE` is the container image that contains the app you want to deploy.

For example, if you have an image named `IMAGE`, you can create a workload with the flag mentioned earlier:

```
tanzu apps workload create tanzu-java-web-app \
 --app tanzu-java-web-app \
 --type web \
 --image IMAGE
```

Expected output:

```
Create workload:
 1 + |---
 2 + |apiVersion: carto.run/v1alpha1
 3 + |kind: Workload
 4 + |metadata:
 5 + | labels:
 6 + | app.kubernetes.io/part-of: hello-world
 7 + | apps.tanzu.vmware.com/workload-type: web
 8 + | name: tanzu-java-web-app
 9 + | namespace: default
10 + |spec:
11 + | image: IMAGE
```

When you run `tanzu apps workload create` command with the `--image` field, the source resolution and build phases of the supply chain are skipped.

## Examples

The following examples show ways that you can build container images for a Java-based app and complete the supply chains to a running service.

### Using a Dockerfile

Using a Dockerfile is the most common way of building container images. You can select a base image, on top of which certain operations must occur, such as compiling code, and mutate the contents of the file system to a final container image that has a build of your app and any required runtime dependencies.

Here you use the `maven` base image for compiling your app code, and then the minimal distroless `java17-debian11` image for providing a JRE that can run your app when it is built.

After building the image, you push it to a container image registry, and then reference it in the workload.

1. Create a Dockerfile that describes how to build your app and make it available as a container image:

```
ARG BUILDER_IMAGE=maven
ARG RUNTIME_IMAGE=gcr.io/distroless/java17-debian11

FROM $BUILDER_IMAGE AS build

 ADD . .
 RUN unset MAVEN_CONFIG && ./mvnw clean package -B -DskipTests

FROM $RUNTIME_IMAGE AS runtime

 COPY --from=build /target/demo-0.0.1-SNAPSHOT.jar /demo.jar
 CMD ["/demo.jar"]
```

2. Push the container image to a container image registry by running:

```
docker build -t IMAGE .
docker push IMAGE
```

3. Create a workload by running:

```
tanzu apps workload create tanzu-java-web-app \
 --type web \
 --app tanzu-java-web-app \
 --image IMAGE
```

Expected output:

```
Create workload:
 1 + |---
 2 + |apiVersion: carto.run/v1alpha1
 3 + |kind: Workload
 4 + |metadata:
 5 + | labels:
 6 + | app.kubernetes.io/part-of: hello-world
 7 + | apps.tanzu.vmware.com/workload-type: web
 8 + | name: tanzu-java-web-app
 9 + | namespace: default
10 + |spec:
11 + | image: IMAGE
```

4. Run the following workload:

```
tanzu apps workload get tanzu-java-web-app
```

Expected output:

```
tanzu-java-web-app: Ready

lastTransitionTime: "2022-04-06T19:32:46Z"
message: ""
reason: Ready
status: "True"
type: Ready

Workload pods
NAME STATUS RESTARTS A
GE
tanzu-java-web-app-00001-deployment-7d7df5ccf5-k58rt Running 0 3
2s
tanzu-java-web-app-config-writer-xjmvw-pod Succeeded 0 8
9s
```

```

Workload Knative Services
NAME READY URL
tanzu-java-web-app Ready http://tanzu-java-web-app.default.example.com

```

## Using Spring Boot's `build-image` Maven target

You can use Spring Boot's `build-image` target to build a container image that runs your app. The `build-image` target must use a Dockerfile.

For example, using the same sample repository as mentioned before (<https://github.com/vmware-tanzu/application-accelerator-samples/tree/main/tanzu-java-web-app>):

1. Build the image by running the following command from the root of the repository:

```

IMAGE=ghcr.io/kontinue/hello-world:tanzu-java-web-app
./mvnw spring-boot:build-image -Dspring-boot.build-image.imageName=$IMAGE

```

Expected output:

```

[INFO] Scanning for projects...
[INFO]
[INFO] -----< com.example:demo >-----
[INFO] Building demo 0.0.1-SNAPSHOT
[INFO] -----[jar]-----
[INFO]
...
[INFO]
[INFO] Successfully built image 'ghcr.io/kontinue/hello-world:tanzu-java-web-app'
[INFO]
[INFO] -----
[INFO] BUILD SUCCESS
[INFO] -----
[INFO] Total time: 39.257 s
[INFO] Finished at: 2022-04-06T19:40:16Z
[INFO] -----

```

2. Push the image you built to the container image registry by running:

```

IMAGE=ghcr.io/kontinue/hello-world:tanzu-java-web-app
docker push $IMAGE

```

Expected output:

```

The push refers to repository [ghcr.io/kontinue/hello-world]
1dc94a70dbaa: Preparing
...
9d6787a516e7: Pushed
tanzu-java-web-app: digest: sha256:7140722ea396af69fb3d0ad12e9b4419bc3e67d9c5d8a2f6a1421decc4828ace size: 4497

```

After you push the container image, you see the same results as building the image [using a Dockerfile](#).

For more information about building container images for a Spring Boot app, see [Spring Boot with Docker](#)

## About Out of the Box Supply Chains

In Tanzu Application Platform, the `ootb-supply-chain-basic`, `ootb-supply-chain-testing`, and `ootb-supply-chain-testing-scanning` packages each receive a new supply chain that provides a prebuilt container image for your app.

```
ootb-supply-chain-basic

(cluster) basic-image-to-url ClusterSupplyChain (!) new
^ source-to-url ClusterSupplyChain

ootb-supply-chain-testing

(cluster) testing-image-to-url ClusterSupplyChain (!) new
^ source-test-to-url ClusterSupplyChain

ootb-supply-chain-testing-scanning

(cluster) scanning-image-scan-to-url ClusterSupplyChain (!) new
^ source-test-scan-to-url ClusterSupplyChain
```

To leverage the supply chains that expect a prebuilt image, you must set the `spec.image` field in the workload to the name of the container image that contains the app to deploy.

The new supply chains use a Cartographer feature that lets VMware increase the specificity of supply chain selection by using the `matchFields` selector rule.

The selection takes place as follows:

- *ootb-supply-chain-basic*
  - From source: label `apps.tanzu.vmware.com/workload-type: web`
  - Prebuilt image: label `apps.tanzu.vmware.com/workload-type: web` and set `spec.image` in the `workload.yaml`
- *ootb-supply-chain-testing*
  - From source: labels `apps.tanzu.vmware.com/workload-type: web` and `apps.tanzu.vmware.com/has-tests: true`
  - Prebuilt image: label `apps.tanzu.vmware.com/workload-type: web` and set `spec.image` in the `workload.yaml`
- *ootb-supply-chain-testing-scanning*
  - From source: labels `apps.tanzu.vmware.com/workload-type: web` and `apps.tanzu.vmware.com/has-tests: true`
  - Prebuilt image: label `apps.tanzu.vmware.com/workload-type: web` and set `spec.image` in the `workload.yaml`

Workloads that already work with the supply chains before Tanzu Application Platform v1.1 continue to work with the same supply chain. Workloads that bring a prebuilt container image must set `spec.image` in the `workload.yaml`.

## Understanding the supply chain for a prebuilt image

An `ImageRepository` object is created to keep track of new images pushed under that name. `ImageRepository` makes the image available to further resources in the supply chain, providing the final digest of the latest image.

Whenever a new image is pushed to the workload's image location, the `ImageRepository` detects the change. The image is then available to further resources by updating its

`imagerepository.status.artifact.revision` with an absolute reference to that image.

For example, if you create a workload using an image named `hello-world`, tagged `tanzu-java-web-app` hosted under `ghcr.io` in the `kontinue` repository:

```
tanzu apps workload create tanzu-java-web-app \
 --app tanzu-java-web-app \
 --type web \
 --image ghcr.io/kontinue/hello-world:tanzu-java-web-app
```

After a couple seconds, you see the `ImageRepository` object created to keep track of images named `ghcr.io/kontinue/hello-world:tanzu-java-web-app`:

```
Workload/tanzu-java-web-app
├--ImageRepository/tanzu-java-web-app
├--PodIntent/tanzu-java-web-app
├--ConfigMap/tanzu-java-web-app
├--Runnable/tanzu-java-web-app-config-writer
├--TaskRun/tanzu-java-web-app-config-writer-p21zv
└--Pod/tanzu-java-web-app-config-writer-p21zv-pod
```

If you inspect the status in `status.resources` in the `workload.yaml`, you see the `image-provider` resource promoting the image it found to further resources:

```
apiVersion: carto.run/v1alpha1
kind: Workload
spec:
 image: ghcr.io/kontinue/hello-world:tanzu-java-web-app
status:
 resources:
 - name: image-provider
 outputs:
 # output being made available to further resources in the supply chain
 # (in this case, the latest image it found under that name).
 #
 - name: image
 lastTransitionTime: "2022-04-01T15:05:01Z"
 preview: ghcr.io/kontinue/hello-world:tanzu-java-web-app@sha256:9fb930a...

 # reference to the object managed by the supply chain for this
 # resource
 #
 stampedRef:
 apiVersion: source.apps.tanzu.vmware.com/v1alpha1
 kind: ImageRepository
 name: tanzu-java-web-app
 namespace: workload

 # reference to the template that defined how this object should look
 # like
 #
 templateRef:
 apiVersion: carto.run/v1alpha1
 kind: ClusterImageTemplate
 name: image-provider-template
```

The image found by the `ImageRepository` object is carried through the supply chain to the final configuration. This is pushed to either a Git repository or image registry so that it is deployed in a run cluster.



#### Note

The image name matches the image name supplied in the `spec.image` field in the `workload.yaml`, but also includes the digest of the latest image found under the tag. If a new image is pushed to the same tag, you see the `ImageRepository` resolving the name to a different digest corresponding to the new image pushed.

## Use Git authentication with Supply Chain Choreographer

This topic describes how you can use Git authentication with Supply Chain Choreographer.

You can either fetch or push source code from or to a repository that requires credentials. You must provide credentials through a Kubernetes secret object referenced by the intended Kubernetes object created for performing the action.

The following sections provide details about how to appropriately set up Kubernetes secrets for carrying those credentials forward to the proper resources.



### Important

For HTTP, HTTPS, and SSH, do not use the same server for multiple secrets to avoid a Tekton error.

## HTTP

For any action upon an HTTP or HTTPS based repository, create a Kubernetes secret object of type `kubernetes.io/basic-auth` as follows:

```
apiVersion: v1
kind: Secret
metadata:
 name: SECRET-NAME
 annotations:
 tekton.dev/git-0: GIT-SERVER # ! required
type: kubernetes.io/basic-auth # ! required
stringData:
 username: GIT-USERNAME
 password: GIT-PASSWORD
```

For example, assuming you have a repository called `kontinue/hello-world` on GitHub that requires authentication, and you have an access token with the privileges of reading the contents of the repository, you can create the secret as follows:

```
apiVersion: v1
kind: Secret
metadata:
 name: git-secret
 annotations:
 tekton.dev/git-0: https://github.com
type: kubernetes.io/basic-auth
stringData:
 username: GITHUB-USERNAME
 password: GITHUB-ACCESS-TOKEN
```



### Note

In this example, you use an access token because GitHub deprecates basic authentication with plain user name and password. For more information, see

## Creating a personal access token on GitHub.

After you create the secret, attach it to the `ServiceAccount` configured for the workload by including it in its set of secrets. For example:

```
```yaml
apiVersion: v1
kind: ServiceAccount
metadata:
  name: default
secrets:
  - name: registry-credentials
  - name: tap-registry
  - name: GIT-SECRET-NAME
imagePullSecrets:
  - name: registry-credentials
  - name: tap-registry
```
```

## HTTPS with a Custom CA Certificate

In addition to the `shared.ca_cert_data` field, you must add the certificate to the secret used to access the Git repository. The only platform tested with custom CA certificates is GitLab.

You set up the secret similarly to the section above, but the `caFile` field specifies a certificate authority.

```
apiVersion: v1
kind: Secret
metadata:
 name: SECRET-NAME
annotations:
 tekton.dev/git-0: GIT-SERVER # ! required
type: kubernetes.io/basic-auth # ! required
stringData:
 username: GIT-USERNAME
 password: GIT-PASSWORD
 caFile: |
 -----BEGIN CERTIFICATE-----
 ...
 -----END CERTIFICATE-----
```

The secret is associated with the `ServiceAccount`.

```
```yaml
apiVersion: v1
kind: ServiceAccount
metadata:
  name: default
secrets:
  - name: registry-credentials
  - name: tap-registry
  - name: GIT-SECRET-NAME
imagePullSecrets:
  - name: registry-credentials
  - name: tap-registry
```
```

## SSH



Aside from using HTTP or HTTPS as a transport, the supply chains also allow you to use SSH.



### Important

To use the pull request feature, you must use HTTP or HTTPS authentication with an access token.

1. To provide the credentials for any Git operations with SSH, create the Kubernetes secret as follows:

```
apiVersion: v1
kind: Secret
metadata:
 name: GIT-SECRET-NAME
 annotations:
 tekton.dev/git-0: GIT-SERVER
type: kubernetes.io/ssh-auth
stringData:
 ssh-privatekey: SSH-PRIVATE-KEY # private key with push-permissions
 identity: SSH-PRIVATE-KEY # private key with pull permissions
 identity.pub: SSH-PUBLIC-KEY # public of the `identity` private key
 known_hosts: GIT-SERVER-PUBLIC-KEYS # Git server public keys
```

2. Generate a new SSH keypair: `identity` and `identity.pub`.

```
ssh-keygen -t ecdsa -b 521 -C "" -f "identity" -N ""
```

3. Go to your Git provider and add the `identity.pub` as a deployment key for the repository of interest or add to an account that has access to it. For example, for GitHub, visit <https://github.com/<repository>/settings/keys/new>.



### Note

Keys of type SHA-1/RSA are recently deprecated by GitHub.

4. Gather public keys from the provider, for example, GitHub:

```
ssh-keyscan github.com > ./known_hosts
```

5. Create the Kubernetes secret by using the contents of the files in the first step:

```
apiVersion: v1
kind: Secret
metadata:
 name: GIT-SECRET-NAME
 annotations: {tekton.dev/git-0: GIT-SERVER}
type: kubernetes.io/ssh-auth
stringData:
 ssh-privatekey: SSH-PRIVATE-KEY
 identity: SSH-PRIVATE-KEY
 identity.pub: SSH-PUBLIC-KEY
 known_hosts: GIT-SERVER-PUBLIC-KEYS
```

For example, edit the credentials:

```
apiVersion: v1
kind: Secret
metadata:
```

```

name: git-ssh
annotations: {tekton.dev/git-0: github.com}
type: kubernetes.io/ssh-auth
stringData:
 ssh-privatekey: |
 -----BEGIN OPENSSH PRIVATE KEY-----
 AAAA

 -----END OPENSSH PRIVATE KEY-----
 known_hosts: |
 <known hosts entrys for git provider>
 identity: |
 -----BEGIN OPENSSH PRIVATE KEY-----
 AAAA

 -----END OPENSSH PRIVATE KEY-----
 identity.pub: ssh-ed25519 AAAABBBCCDDDDDeeeeFFFF user@example.com

```

6. After you create the secret, attach it to the ServiceAccount configured for the workload by including it in its set of secrets. For example:

```

apiVersion: v1
kind: ServiceAccount
metadata:
 name: default
secrets:
 - name: registry-credentials
 - name: tap-registry
 - name: GIT-SECRET-NAME
imagePullSecrets:
 - name: registry-credentials
 - name: tap-registry

```



#### Note

If you've used Namespace Provisioner to set up your Developer Namespace where you workload is created, use the

`namespace_provisioner.default_parameters.supply_chain_service_account.secrets` property in your `tap-values.yaml`. For example:

```

```yaml
namespace_provisioner:
  default_parameters:
    supply_chain_service_account:
      secrets:
        - GIT-SECRET-NAME
...

```

Namespace Provisioner manages the service account and manual edits to it do not persist.

More information about Git

For information about Git, see [Git Reference](#).

Using Azure DevOps as a Git provider with your supply chains

This topic describes how you can Azure DevOps as a Git provider with your Supply Chain Choreographer supply chains.

Overview

There are two uses for Git in a supply chain:

- As a source of code to build and deploy applications
- As a repository of configuration created by the build cluster which is deployed on a run or production cluster

Azure DevOps differs from other Git providers in the following ways:

- Azure DevOps requires Git clients to support multi-ack.
- Azure DevOps repository paths differ from other Git providers.

For information about how Azure DevOps is different from other Git providers, see [Gitops write path templates](#).

The operator requires special configuration to integrate Azure DevOps repositories into a supply chain.

Azure authentication

You can use Azure authentication with Supply Chain Choreographer.

For information about configuring secrets to authenticate with your Azure DevOps Git repository, see [Use Git authentication with Supply Chain Choreographer](#).

Azure http and https authentication requires:

```
username: "_token"
password: AZURE-USER-TOKEN
```

Where `AZURE-USER-TOKEN` is your Azure personal access token. See [Azure DevOps Personal Access Tokens](#) in the Microsoft documentation.

Using Azure DevOps as a repository for committed code

Developers can use Azure DevOps to commit source code to a repository that the supply chain pulls.

Azure DevOps example

The following example uses the Azure DevOps source repository:

```
https://dev.azure.com/my-company/app/_git/app
```

You can configure the supply chain by using `tap-values`:

```
ootb_supply_chain_testing_scanning:
  git_implementation: go-git
```

or by using workload parameter:

```
apiVersion: carto.run/v1alpha1
kind: Workload
metadata:
  ...
spec:
```

```
params:
  - name: gitImplementation
    value: go-git
```

Using Azure DevOps as a GitOps repository

The supply chain commits Kubernetes configuration to a Git repository. This configuration is then applied to another cluster. This is the GitOps promotion pattern.

You must construct a path and configure your Git implementation to read and write to an Azure DevOps repository.

GitOps write path example

The following example uses the Azure DevOps Git repository:

https://dev.azure.com/vmware-tanzu/tap/_git/tap

Set the `gitops_server_kind` workload parameters to `azure`.

```
``yaml
apiVersion: carto.run/v1alpha1
kind: Workload
metadata:
  ...
spec:
  params:
    - name: gitops_server_kind
      value: azure
    ...
...`
```

Set other GitOps values in either tap-values or in the workload parameters.

- By using tap-values:

```
ootb_supply_chain_testing_scanning:
  gitops:
    server_address: https://dev.azure.com
    repository_owner: vmware-tanzu/tap
    repository_name: tap
```

- By using the workload parameters:

```
apiVersion: carto.run/v1alpha1
kind: Workload
metadata:
  ...
spec:
  params:
    - name: gitops_server_address
      value: https://dev.azure.com
    - name: gitops_repository_owner
      value: vmware-tanzu/tap
    - name: gitops_repository_name
      value: tap
    ...
```

Gitops write path templates

Azure DevOps and Git use different URL structures.

For example, the Git clone URL of an Azure DevOps repository is structured as:

`https://dev.azure.com/<org_name>/<project_name>/_git/<repository_name>`

GitHub uses the following address structure:

`https://github.com/<org_name>/<repository_name>`

In Azure DevOps, a project can have multiple repositories, but the project name and repository name are often the same.

The [config-writer](#) and [config-writer-and-pull-requester](#) templates accept three parameters to build the path of the repository. For Azure DevOps, configure them as follows:

- `gitops_server_address`: `https://dev.azure.com`
- `gitops_repository_owner`: `<org_name>/<project_name>`
- `gitops_repository_name`: `<repository_name>`

Configure the template parameters as follows:

- `gitops.server_address` tap-value during the Out of the Box Supply Chains package installation or `gitops_server_address` configured as a workload parameter.
- `gitops.repository_owner` tap-value during the Out of the Box Supply Chains package installation or `gitops_repository_owner` configured as a workload parameter.
- `gitops.repository_name` tap-value during the Out of the Box Supply Chains package installation or `gitops_repository_name` configured as a workload parameter.

To properly construct the write path, the template parameter `gitops_server_kind` must be configured as `azure`.

Configure `gitops_server_kind` as a workload parameter.



Note

When you use pull requests with GitOps, you can set the type of server with the tap-value `gitops.pull_request.server_kind`. See [GitOps versus RegistryOps](#).

For information about configuring the GitOps write operations, see [GitOps versus RegistryOps](#).

Using GitLab as a Git provider with your supply chains

This topic describes how to use GitLab as a Git provider with your Supply Chain Choreographer supply chains.

Overview

There are two uses for Git in a supply chain:

- As a source of code to build and deploy applications
- As a repository of configuration created by the build cluster which is deployed on a run or production cluster

Using GitLab as a repository for committed code

This section tells you how developers can use GitLab to commit source code to a repository that the supply chain pulls.

GitLab example

The following example uses the GitLab source repository:

<https://gitlab.example.com/my-org/repository.git>

You can configure the supply chain by using `tap-values.yaml`:

```
ootb_supply_chain_testing_scanning:
  git_implementation: go-git
```

or by using a workload parameter:

```
apiVersion: carto.run/v1alpha1
kind: Workload
metadata:
  ...
spec:
  params:
    - name: gitImplementation
      value: go-git
```

Using GitLab as a GitOps repository

The supply chain commits Kubernetes configuration to a Git repository. This configuration is then applied to another cluster. This is the GitOps promotion process.

You must construct a path and configure your Git implementation to read and write to an GitLab repository.

GitOps write path example

The following example uses the GitLab Git repository:

<https://gitlab.example.com/my-org/repository.git>

1. Set the `gitops_server_kind` workload parameters to `gitlab`.

```
apiVersion: carto.run/v1alpha1
kind: Workload
metadata:
  ...
spec:
  params:
    - name: gitops_server_kind
      value: gitlab
    ...
```

2. Set other GitOps values in either `tap-values.yaml` or in the workload parameters. By using `tap-values.yaml`:

```
ootb_supply_chain_testing_scanning:
  gitops:
    server_address: https://gitlab.example.com
    repository_owner: my-org
    repository_name: repository
```

By using the workload parameters:

```
apiVersion: carto.run/v1alpha1
kind: Workload
metadata:
  ...
spec:
```

```

params:
  - name: gitops_server_address
    value: https://gitlab.example.com
  - name: gitops_repository_owner
    value: my-org
  - name: gitops_repository_name
    value: repository
  ...

```

GitLab read example

The following example uses the GitLab repository:

<https://gitlab.example.com/my-org/repository.git>

You can configure the delivery `tap-values.yaml`:

```

ootb_delivery_basic:
  git_implementation: go-git

```

or the deliverable parameter:

```

apiVersion: carto.run/v1alpha1
kind: Deliverable
metadata:
  ...
spec:
  params:
    - name: gitImplementation
      value: go-git

```

GitLab over HTTPS with a custom CA certificate

When using HTTPS with a custom certificate authority, you must configure the Git secret both in `tap-values.yaml` and the Git secret used by the GitRepository.

1. Set the `shared.ca_cert_data` in `tap-values.yaml`. You must set the Git secret in the `caFile` field.

```

apiVersion: v1
kind: Secret
metadata:
  name: SECRET-NAME
  annotations:
    tekton.dev/git-0: GIT-SERVER # ! required
type: kubernetes.io/basic-auth # ! required
stringData:
  username: GIT-USERNAME
  password: GIT-PASSWORD
  caFile: |
    -----BEGIN CERTIFICATE-----
    ...
    -----END CERTIFICATE-----

```

2. Associate the secret with the `ServiceAccount`.

```

apiVersion: v1
kind: ServiceAccount
metadata:
  name: default
secrets:
  - name: registry-credentials
  - name: tap-registry

```

```

- name: GIT-SECRET-NAME
imagePullSecrets:
- name: registry-credentials
- name: tap-registry

```

For information about authentication, see [Git Authentication](#).

Author your supply chains

The Out of the Box Supply Chain, Delivery Basic, and Templates Supply Chain Choreographer packages give you Kubernetes objects that cover a reference path to production. Because VMware recognizes that you have your own needs, these objects are customizable, including individual templates for each resource, whole supply chains, or delivery objects.

Depending on how you installed Tanzu Application Platform, there are different ways to customize the Out of the Box Supply Chains. The following sections describe the ways supply chains and templates are authored within the context of profile-based Tanzu Application Platform installations.

Providing your own supply chain

To create a new supply chain and make it available for workloads, ensure that the supply chain does not conflict with those installed on the cluster, because those objects are cluster-scoped.

If this is your first time creating a supply chain, follow the tutorials from the [Cartographer documentation](#).

Any supply chain installed in a Tanzu Application Platform cluster might encounter two possible cases of collisions:

- **object name:**

Supply chains are cluster scoped, such as any Cartographer resource prefixed with `Cluster`. So the name of the custom supply chain must be different from the ones provided by the Out of the Box packages.

Either create a supply chain whose name is different, or remove the installation of the corresponding `ootb-supply-chain-*` from the Tanzu Application Platform.

- **workload selection:**

A workload is reconciled against a particular supply chain based on a set of selection rules as defined by the supply chains. If the rules for the supply chain to match a workload are ambiguous, the workload does not make any progress.

Either create a supply chain whose selection rules are different from the ones the Out of the Box Supply Chain packages use, or remove the installation of the corresponding `ootb-supply-chain-*` from Tanzu Application Platform.

See [Selectors](#).

For Tanzu Application Platform v1.2, the following selection rules are in place for the supply chains of the corresponding packages:

- `ootb-supply-chain-basic`
 - ClusterSupplyChain/**basic-image-to-url**
 - label `apps.tanzu.vmware.com/workload-type: web`
 - `workload.spec.image` text box set
 - ClusterSupplyChain/**source-to-url**
 - label `apps.tanzu.vmware.com/workload-type: web`

- ClusterSupplyChain/**basic-image-to-url-package (experimental)**
 - label `apps.tanzu.vmware.com/workload-type: server`
 - label `apps.tanzu.vmware.com/carvel-package-workflow: true`
 - ClusterSupplyChain/**source-to-url-package (experimental)**
 - label `apps.tanzu.vmware.com/workload-type: server`
 - label `apps.tanzu.vmware.com/carvel-package-workflow: true`
- *ootb-supply-chain-testing*
 - ClusterSupplyChain/**testing-image-to-url**
 - label `apps.tanzu.vmware.com/workload-type: web`
 - `workload.spec.image` text box set
 - ClusterSupplyChain/**source-test-to-url**
 - label `apps.tanzu.vmware.com/workload-type: web`
 - label `apps.tanzu.vmware.com/has-test: true`
- *ootb-supply-chain-testing-scanning*
 - ClusterSupplyChain/**scanning-image-scan-to-url**
 - label `apps.tanzu.vmware.com/workload-type: web`
 - `workload.spec.image` text box set
 - ClusterSupplyChain/**source-test-scan-to-url**
 - label `apps.tanzu.vmware.com/workload-type: web`
 - label `apps.tanzu.vmware.com/has-test: true`

For details about how to edit an existing supply chain, see the [Modifying an Out of the Box Supply Chain](#) section.

You can exclude a supply chain package from the installation to prevent the conflicts mentioned earlier, by using the `excluded_packages` property in `tap-values.yaml`. For example:

```
# add to excluded_packages `ootb-*` packages you DON'T want to install
# excluded_packages:
- ootb-supply-chain-basic.apps.tanzu.vmware.com
- ootb-supply-chain-testing.apps.tanzu.vmware.com
- ootb-supply-chain-testing-scanning.apps.tanzu.vmware.com
# comment out remove the `supply_chain` property
#
# supply_chain: ""
```

Providing your own templates

Similar to supply chains, Cartographer templates (`Cluster*Template` resources) are cluster-scoped, so you must ensure that the new templates submitted to the cluster do not conflict with those installed by the `ootb-templates` package.

The following set of objects are provided by `ootb-templates`:

- ClusterConfigTemplate/**config-template**
- ClusterConfigTemplate/**convention-template**
- ClusterDeploymentTemplate/**app-deploy**
- ClusterImageTemplate/**image-provider-template**

- ClusterImageTemplate/**image-scanner-template**
- ClusterImageTemplate/**kpack-template**
- ClusterTask/**kaniko-build**
- ClusterImageTemplate/**kaniko-template**
- ClusterRole/**ootb-templates-app-viewer**
- ClusterRole/**ootb-templates-deliverable**
- ClusterRole/**ootb-templates-workload**
- ClusterRunTemplate/**tekton-source-pipelinerun**
- ClusterRunTemplate/**tekton-taskrun**
- ClusterSourceTemplate/**delivery-source-template**
- ClusterSourceTemplate/**source-scanner-template**
- ClusterSourceTemplate/**source-template**
- ClusterSourceTemplate/**testing-pipeline**
- ClusterTask/**git-writer**
- ClusterTask/**image-writer**
- ClusterTemplate/**config-writer-template**
- ClusterTemplate/**deliverable-template**
- ClusterTask/**carvel-package (experimental)**
- ClusterConfigTemplate/**carvel-package (experimental)**
- ClusterTemplate/**package-config-writer-and-pull-requester-template (experimental)**
- ClusterTemplate/**package-config-writer-template (experimental)**

Before submitting your own, either ensure that the name and resource has no conflicts with those installed by `ootb-templates`, or exclude from the installation the template you want to override by using the `excluded_templates` property of `ootb-templates`.

For example, perhaps you want to override the `ClusterConfigTemplate` named `config-template` to provide your own with the same name, so that you don't need to edit the supply chain. In `tap-values.yaml`, you can exclude template provided by Tanzu Application Platform:

```
ootb_templates:
  excluded_templates:
    - 'config-writer'
```

For details about how to edit an existing template, see the [Modifying an Out of the Box Supply template](#) section.

Modifying an Out of the Box Supply Chain

To change the shape of a supply chain or the template that it points to:

1. Copy one of the reference supply chains.
2. Remove the old supply chain.
3. Edit the supply chain object.
4. Submit the modified supply chain to the cluster.

Example

In this example, you have a new `ClusterImageTemplate` object named `foo` that you want use for building container images instead of the out of the box object that makes use of Kpack. The supply chain that you want to apply the modification to is `source-to-url` provided by the `ootb-supply-chain-basic` package.

1. Find the image that contains the supply chain definition:

```
kubectl get app ootb-supply-chain-basic \
  -n tap-install \
  -o jsonpath={.spec.fetch[0].imgpkgBundle.image}
```

For example:

```
registry.example.com/tanzu-application-platform/tap-packages@sha256:f2ad401bb3e850940...
```

2. Pull the contents of the bundle into a directory named `ootb-supply-chain-basic`:

```
imgpkg pull \
  -b registry.example.com/tanzu-application-platform/tap-packages@sha256:f2ad401bb3e850940... \
  -o ootb-supply-chain-basic
```

For example:

```
Pulling bundle 'registry.example.com/tanzu-...
Extracting layer 'sha256:542f2bb8eb946fe9d2c8a...

Locating image lock file images...
The bundle repo (registry.example.com/tanzu...

Succeeded
```

3. Inspect the files obtained:

```
tree ./ootb-supply-chain-basic/
```

For example:

```
./ootb-supply-chain-basic/
├── config
│   ├── supply-chain-image.yaml
│   └── supply-chain.yaml
└── values.yaml
```

4. Edit the supply chain that you want to exchange the template with another:

```
--- a/supply-chain.yaml
+++ b/supply-chain.yaml
@@ -52,7 +52,7 @@ spec:
  - name: image-builder
    templateRef:
      kind: ClusterImageTemplate
  - name: kpack-template
+  name: foo
  params:
    - name: serviceAccount
      value: #@ data.values.service_account
```

5. Submit the supply chain to Kubernetes:

The supply chain definition found in the bundle expects the values you provided by using `tap-values.yaml` to be interpolated by using YTT before they are submitted to Kubernetes. So, before applying the modified supply chain to the cluster, use YTT to interpolate those values. After that, run:

```
ytt \
  --ignore-unknown-comments \
  --file ./ootb-supply-chain-basic/config \
  --data-value registry.server=REGISTRY-SERVER \
  --data-value registry.repository=REGISTRY-REPOSITORY |
kubectl apply -f-
```



Important

The modified supply chain does not outlive the destruction of the cluster. VMware recommends that you save it somewhere, such as in a Git repository, so that you can install it on every cluster where you expect the supply chain to exist.

Modifying an Out of the Box Supply template

The Out of the Box Templates package (`ootb-templates`) includes all of the templates and shared Tekton tasks used by the supply chains shipped by using `ootb-supply-chain-*` packages. Any template that you want to edit, for example, to change details about the resources that are created based on them, is part of this package.

The workflow for updating a template is as follows:

1. Copy one of the reference templates from `ootb-templates`.
2. Exclude that template from the set of objects provided by `ootb-templates`. For more information, see `excluded_templates` in the [Providing your own templates](#) section.
3. Edit the template.
4. Submit the modified template to the cluster.



Note

You don't need to change anything related to supply chains, because you're preserving the name of the object referenced by the supply chain.

Example

In this example, you want to update the `ClusterImageTemplate` object called `kpack-template`, which provides a template for creating `kpack/Images` to hardcode an environment variable.

1. Exclude the `kpack-template` from the set of templates that `ootb-templates` installs by updating `tap-values.yaml`:

```
ootb_templates:
  excluded_templates: ['kpack-template']
```

2. Find the image that contains the templates:

```
kubectl get app ootb-templates \
  -n tap-install \
```

```
-o jsonpath={.spec.fetch[0].imgpkgBundle.image}
```

For example:

```
registry.example.com/tanzu-application-platform/tap-packages@sha256:a5e177f38d7287f2ca7ee2afd67ff178645d8f1b1e47af4f192a5ddd6404825e
```

3. Pull the contents of the bundle into a directory named `ootb-templates`:

```
imgpkg pull \
  -b registry.example.com/tanzu-application-platform/tap-packages@sha256:a5e177f38d7287f2ca7ee2afd67ff178645d8f1b1e47af4f192a5ddd6404825e \
  -o ootb-templates
```

For example:

```
Pulling bundle 'registry.example.com/tanzu-...
Extracting layer 'sha256:a5e177f38d7...

Locating image lock file images...
The bundle repo (registry.example.com/tanzu...

Succeeded
```

4. Confirm that you downloaded all the templates:

```
tree ./ootb-templates
```

Example output:

```
./ootb-templates
|-- config
|   |-- cluster-roles.yaml
|   |-- config-template.yaml
|   |-- kpack-template.yaml          # ! the one we want to modify
|   ...
|   |-- testing-pipeline.yaml
|-- values.yaml
```

5. Change the property you want to change:

```
--- a/config/kpack-template.yaml
+++ b/config/kpack-template.yaml
@@ -65,6 +65,8 @@ spec:
     subPath: #@ data.values.workload.spec.source.subPath
     build:
       env:
+       - name: FOO
+       value: BAR
       - name: BP_OCI_SOURCE
         value: #@ data.values.source.revision
     #@ if/end param("live-update"):
```

6. Submit the template.

The name of the template is preserved but the contents are changed. So after the template is submitted, the supply chains are all embedded to the build of the application container images that have `FOO` environment variable.

Live modification of supply chains and templates

Preceding sections covered how to update supply chains or templates installed in a cluster. This section shows how you can experiment by making small changes in a live setup with `kubectl edit`.

When you install Tanzu Application Platform by using profiles, a `PackageInstall` object is created. This in turn creates a set of children `PackageInstall` objects for installing the individual components that make up the platform.

```
PackageInstall/tap
└─App/tap
  ├── PackageInstall/cert-manager
  ├── PackageInstall/cartographer
  ├── ...
  └─ PackageInstall/tekton-pipelines
```

Because the installation is based on Kubernetes primitives, `PackageInstall` tries to achieve the state where all packages are installed.

This is great but presents challenges for modifying the contents of some of the objects that the installation submits to the cluster. Namely, such modifications cause the original definition persisting instead of the changes.

For this reason, before you perform any customization to the Out of the Box packages, you must pause the top-level `PackageInstall/tap` object by running:

```
kubectl edit -n tap-install packageinstall tap
```

Example YAML:

```
apiVersion: packaging.carvel.dev/v1alpha1
kind: PackageInstall
metadata:
  name: tap
  namespace: tap-install
spec:
  paused: true # ! set this field to `paused: true`.
  packageRef:
    refName: tap.tanzu.vmware.com
    versionSelection:
# ...
```

With the installation of Tanzu Application Platform paused, all of the installed components are still there, but changes to those children `PackageInstall` objects are not overwritten.

Now you can pause the `PackageInstall` objects that relate to the templates or supply chains you want to edit.

For example:

- To edit templates, run:

```
kubectl edit -n tap-install packageinstall ootb-templates
```

- To edit the basic supply chains, run:

```
kubectl edit -n tap-install packageinstall ootb-supply-chain-basic
```

setting `packageinstall.spec.paused: as true`.

With the installations paused, further live changes to templates or supply chains are persisted until you revert the `PackageInstalls` to not being paused. To persist the changes, follow the steps outlined in the earlier sections.

Adding custom behavior to Supply Chains

Most behaviors in supply chains are supplied by Kubernetes controllers. For example, Cloud Native Buildpacks are created by the kpack controller when a kpack Image object is created. Sometimes there is need for behavior and no controller for it exists. In these instances, you might want to write a script that uses a CLI tool, or interact with an external API. To do this, you can bring the behavior to the supply chain by using Tekton.

You can look at the kaniko image-building as an example. You create a Tekton ClusterTask `kaniko-build` with instructions for how to build a Docker image using kaniko given a set of parameters. The ClusterTask has a set of steps. Each step refers to a container image and a set of instructions to run on the image. For example, it can be a Linux image against which a set of bash instructions are run. The ClusterTask is installed on the cluster.

You create the ClusterImageTemplate `kaniko-template` to create Tekton TaskRuns. TaskRuns are immutable, so you add the `lifecycle: tekton` field to the template's specifications. This ensures two things:

- When inputs to the template change, rather than updating the TaskRun, a new TaskRun is created.
- Only the values from the most recently created TaskRun that is successful are propagated forward in the supply chain.

To learn more about the `lifecycle: tekton` field, see the Cartographer tutorial [Lifecycle: Templating Objects That Cannot Update](#). To learn more about Tekton, see the [Tekton documentation](#).

Reference guides for Supply Chain Choreographer for Tanzu

This topic describes the reference guides you can use for Supply Chain Choreographer for Tanzu.

Reference guides

The following reference guides apply to Supply Chain Choreographer for Tanzu:

- [Tanzu Build Service Integration](#)
- [Use GitOps or RegistryOps with Supply Chain Choreographer](#)
- [Delivery reference for Supply Chain Choreographer](#)
- [Delivery reference for Supply Chain Choreographer](#)
- [ClusterRunTemplate reference for Supply Chain Choreographer](#)
- [Template reference for Supply Chain Choreographer](#)
- [Supply chains for Supply Chain Choreographer](#)
- [Workload Reference for Supply Chain Choreographer](#)
- [Events reference for Supply Chain Choreographer](#)

Events reference for Supply Chain Choreographer

This topic describes each event you can view with Supply Chain Choreographer.

Events are emitted when Choreographer edits resources or notices a change in their output or healthy state. Don't treat events like logs, however they can offer valuable insight into what's happening in a supply chain over time. For example, very high occurrences of events in a short

period of time might be a sign of slow application-level processing due to many page faults and a lack of storage resources.

Events are published on Workload, Deliverable, and Runnable resources. You can view them manually using:

```
kubectl describe workload.carto.run <workload-name> -n <workload-ns>
kubectl describe runnable.carto.run <runnable-name> -n <runnable-ns>
kubectl describe deliverable.carto.run <deliverable-name> -n <deliverable-ns>
```

Events

The following sections define the different events.

StampedObjectApplied

This event is emitted every time Choreographer creates or updates a resource. The created or updated resource is referenced in the event message.

Example messages:

```
Created object [gitrepositories.source.toolkit.fluxcd.io/my-project]
Updated object [apps.kappctrl.k14s.io/my-project-app]
```

StampedObjectRemoved

This event is emitted every time Choreographer deletes a resource. This currently only occurs when Runnable resources expire. The deleted object is referenced in the event message.

Example message:

```
Deleted object [task.tekton.dev/my-project-a737bdf]
```

ResourceOutputChanged

This event is emitted every time Choreographer recognizes a new output from a resource.

Example message:

```
[source-provider] found a new output in [imagerepositories.source.apps.tanzu.vmware.com/app]
```

ResourceHealthyStatusChanged

This event is emitted every time Choreographer recognizes that the healthy status of a resource has changed.

Example message:

```
[image-provider] found healthy status in [images.kpack.io/app] changed to [True]
[source-provider] found healthy status in [[gitrepositories.source.toolkit.fluxcd.io/my-project]] changed to [False]
```

Workload Reference for Supply Chain Choreographer

This topic describes the fields you can use for Supply Chain Choreographer workloads.

Standard Fields

Cartographer workloads have standard fields leveraged by supply chains. See [Cartographer's Reference Documentation](#) in the Cartographer documentation.

Labels

Workload labels affect which supply chain is selected. For information about which template is defined for a particular reference, see [Selectors](#) in the Cartographer documentation. Individual templates can also use workload labels.

The following are workload label keys whose values change the behavior of OOTB Supply Chains:

- `apps.tanzu.vmware.com/has-tests` by [Source-Test-to-URL](#) and [Source-Test-Scan-to-URL](#).
- `apps.tanzu.vmware.com/workload-type` by all supply chains.
- `apis.apps.tanzu.vmware.com/register-api` by the [Api-Descriptors Template](#).
- `apps.tanzu.vmware.com/carvel-package-workflow` by [source-to-url-package \(experimental\)](#) and [basic-image-to-url-package \(experimental\)](#).

Parameters

The OOTB templates are configured with parameters from the supply chain or workload. For information about Cartographer parameters, including precedence rules, see [Parameters](#) in the Cartographer documentation.

What parameters are relevant depends on the supply chain that selects the workload, for two reasons:

1. The OOTB supply chains refer to overlapping sets of templates. A workload selected by the Source-to-URL supply chain can provide a `scanning_image_template` parameter, but the supply chain does not refer to a template that leverages that parameter.
2. You can write Supply Chains to provide a parameter value to a template and prevent the workload from overriding the value. See [Further Information](#) in the Cartographer documentation.

The following list of parameters are respected by some OOTB supply chains. Each provides the templates that respect the parameter. The reference for the template details which supply chains include the template.

- `gitImplementation`: [source-template](#)
- `gitops_ssh_secret`: [source-template](#), [deliverable-template](#), [external-deliverable-template](#)
- `serviceAccount`: [source-template](#), [image-provider-template](#), [kpack-template](#), [kaniko-template](#), [convention-template](#), [config-writer-template](#), [config-writer-and-pull-requester-template](#), [deliverable-template](#), [external-deliverable-template](#)
- `maven`: [source-template](#)
- `testing_pipeline_matching_labels`: [testing-pipeline](#)
- `testing_pipeline_params`: [testing-pipeline](#)
- `scanning_source_template`: [source-scanner-template](#)
- `scanning_source_policy`: [source-scanner-template](#)
- `clusterBuilder`: [kpack-template](#)
- `buildServiceBindings`: [kpack-template](#)

- live-update: [kpack-template](#), [convention-template](#)
- dockerfile: [kaniko-template](#)
- docker_build_context: [kaniko-template](#)
- docker_build_extra_args: [kaniko-template](#)
- scanning_image_template: [image-scanner-template](#)
- scanning_image_policy: [image-scanner-template](#)
- annotations: [convention-template](#), [service-bindings](#), [api-descriptors](#)
- debug: [convention-template](#)
- ports: [server-template](#)
- api-descriptors: [api-descriptors](#)
- gitops_branch: [config-writer-template](#), [config-writer-and-pull-requester-template](#), [deliverable-template](#), [external-deliverable-template](#)
- gitops_user_name: [config-writer-template](#), [config-writer-and-pull-requester-template](#)
- gitops_user_email: [config-writer-template](#), [config-writer-and-pull-requester-template](#)
- gitops_commit_message: [config-writer-template](#), [config-writer-and-pull-requester-template](#)
- gitops_repository: [config-writer-template](#), [deliverable-template](#), [external-deliverable-template](#)
- gitops_repository_prefix: [config-writer-template](#), [deliverable-template](#), [external-deliverable-template](#)
- gitops_server_address: [config-writer-template](#), [config-writer-and-pull-requester-template](#), [deliverable-template](#), [external-deliverable-template](#)
- gitops_repository_owner: [config-writer-template](#), [config-writer-and-pull-requester-template](#), [deliverable-template](#), [external-deliverable-template](#)
- gitops_repository_name: [config-writer-template](#), [config-writer-and-pull-requester-template](#), [deliverable-template](#), [external-deliverable-template](#)
- gitops_commit_branch: [config-writer-and-pull-requester-template](#)
- gitops_pull_request_title: [config-writer-and-pull-requester-template](#)
- gitops_pull_request_body: [config-writer-and-pull-requester-template](#)
- gitops_server_kind: [config-writer-and-pull-requester-template](#)
- carvel_package_gitops_subpath (experimental): [carvel-package](#), [package-config-writer-template](#), [package-config-writer-and-pull-requester-template](#)
- carvel_package_name_suffix (experimental): [carvel-package](#), [package-config-writer-template](#), [package-config-writer-and-pull-requester-template](#)
- carvel_package_openapi3_enabled (experimental): [carvel-package](#)

Service Account

To create the templated objects, Cartographer needs a reference to a service account with permissions to manage resources. This service account might be provided in the workload's `.spec.serviceAccountName` field or in the supply chain's `spec.serviceAccountRef` field. See [Service Account](#) and [Workload and Supply Chain Custom Resources](#) in the Cartographer documentation.

When using the Tanzu CLI to create a workload, specify this service account's name with the `--service-account` flag.

After the templated objects are created, they often need a service account with permissions to do work. In the OOTB Templates and Supply Chains, the parameter `serviceAccount` must reference the service account for these objects. When using the Tanzu CLI to create a workload, specify this service account's name with `--param serviceAccount=...`

Supply chains for Supply Chain Choreographer

This topic describes the parameters for supply chains that you can use with Supply Chain Choreographer.

Tanzu Application Platform includes a number of supply chains packages, each of which installs two [ClusterSupplyChains](#). You can only install one supply chain package at a time.

The supply chains provide some [parameters](#) to the referenced templates. The parameters provided by the workload might override the parameters in this topic.

Source-to-URL

Purpose

- Fetches application source code
- Builds it into an image
- Writes the Kubernetes configuration necessary to deploy the application
- Commits that configuration to either a Git repository or a container image registry

Resources

This section describes the templates and their parameters.

source-provider

Refers to [source-template](#).

Parameters provided:

- `serviceAccount` from tap-value `service_account`. Overridable by workload.

image-provider

Refers to [kaniko-template](#) when the workload provides a parameter `dockerfile`. Refers to [kpack-template](#) otherwise.

Parameters provided:

- `serviceAccount` from tap-value `service_account`. Overridable by workload.
- `registry` from tap-value `registry`. NOT overridable by workload.
- `clusterBuilder` from tap-value `cluster_builder`. Overridable by workload.
- `dockerfile` value `./Dockerfile`. Overridable by workload.
- `docker_build_context` value `./`. Overridable by workload.
- `docker_build_extra_args` value `[]`. Overridable by workload.

Common resources

- [Config-Provider](#)
- [App-Config](#)
- [Service-Bindings](#)
- [Api-Descriptors](#)
- [Config-Writer](#)
- [Deliverable](#)

Parameters provided to all resources

- `maven_repository_url` from tap-value `maven.repository.url`. NOT overridable by workload.
- `maven_repository_secret_name` from tap-value `maven.repository.secret_name`. NOT overridable by workload.
- See [Params provided by all Supply Chains to all Resources](#)

Package

[Out of the Box Supply Chain Basic](#)

More information

See [Install Out of the Box Supply Chain Basic](#) for information about setting tap-values at installation time.

Source-Test-to-URL

- Fetches application source code
- Runs user defined tests against the code
- Builds the code into an image
- Writes the Kubernetes configuration necessary to deploy the application
- Commits that configuration to either a Git repository or a container image registry

Resources

source-provider

Refers to [source-template](#).

Parameters provided:

- `serviceAccount` from tap-value `service_account`. Overridable by workload.

source-tester

Refers to [testing-pipeline](#).

No parameters are provided by the supply-chain.

image-provider

Refers to [kaniko-template](#) when the workload provides a parameter `dockerfile`. Refers to [kpack-template](#) otherwise.

Parameters provided:

- `serviceAccount` from tap-value `service_account`. Overridable by workload.
- `registry` from tap-value `registry`. NOT overridable by workload.
- `clusterBuilder` from tap-value `cluster_builder`. Overridable by workload.
- `dockerfile` value `./Dockerfile`. Overridable by workload.
- `docker_build_context` value `./`. Overridable by workload.
- `docker_build_extra_args` value `[]`. Overridable by workload.

Common resources

- [Config-Provider](#)
- [App-Config](#)
- [Service-Bindings](#)
- [Api-Descriptors](#)
- [Config-Writer](#)
- [Deliverable](#)

Parameters provided to all resources

- `maven_repository_url` from tap-value `maven.repository.url`. NOT overridable by workload.
- `maven_repository_secret_name` from tap-value `maven.repository.secret_name`. NOT overridable by workload.
- See [Params provided by all Supply Chains to all Resources](#).

Package

[Out of the Box Supply Chain Testing](#)

More information

See [Install Out of the Box Supply Chain with Testing](#) for information about setting tap-values at installation time.

Source-Test-Scan-to-URL

- Fetches application source code
- Runs user defined tests against the code
- Scans the code for vulnerabilities
- Builds the code into an image
- Scans the image for vulnerabilities
- Writes the Kubernetes configuration necessary to deploy the application
- Commits that configuration to either a Git repository or an image registry

Resources

`source-provider`

Refers to [source-template](#).

Parameters provided:

- `serviceAccount` from tap-value `service_account`. Overridable by workload.

source-tester

Refers to [testing-pipeline](#).

No parameters are provided by the supply-chain.

source-scanner

Refers to [source-scanner-template](#).

Parameters provided:

- `scanning_source_policy` from tap-value `scanning.source.policy`. Overridable by workload.
- `scanning_source_template` from tap-value `scanning.source.template`. Overridable by workload.

image-provider

Refers to [kaniko-template](#) when the workload provides a parameter `dockerfile`. Refers to [kpack-template](#) otherwise.

Parameters provided:

- `serviceAccount` from tap-value `service_account`. Overridable by workload.
- `registry` from tap-value `registry`. NOT overridable by workload.
- `clusterBuilder` from tap-value `cluster_builder`. Overridable by workload.
- `dockerfile` value `./Dockerfile`. Overridable by workload.
- `docker_build_context` value `./`. Overridable by workload.
- `docker_build_extra_args` value `[]`. Overridable by workload.

image-scanner

Refers to [image-scanner-template](#).

Parameters provided:

- `scanning_image_policy` from tap-value `scanning.image.policy`. Overridable by workload.
- `scanning_image_template` from tap-value `scanning.image.template`. Overridable by workload.

Common resources

- [Config-Provider](#)
- [App-Config](#)
- [Service-Bindings](#)
- [Api-Descriptors](#)
- [Config-Writer](#)
- [Deliverable](#)

Parameters provided to all resources

- `maven_repository_url` from tap-value `maven.repository.url`. NOT overridable by workload.
- `maven_repository_secret_name` from tap-value `maven.repository.secret_name`. NOT overridable by workload.
- See [Params provided by all Supply Chains to all Resources](#)

Package

[Out of the Box Supply Chain Testing Scanning](#)

More information

See [Install Out of the Box Supply Chain with Testing and Scanning](#) for information about setting tap-values at installation time.

Basic-Image-to-URL

- Fetches a prebuilt image.
- Writes the Kubernetes configuration necessary to deploy the application.
- Commits that configuration to either a Git repository or an image registry.

Resources

image-provider

Refers to [image-provider-template](#).

Parameters provided:

- `serviceAccount` from tap-value `service_account`. Overridable by workload.

Common resources

- [Config-Provider](#)
- [App-Config](#)
- [Service-Bindings](#)
- [Api-Descriptors](#)
- [Config-Writer](#)
- [Deliverable](#)

Parameters provided to all resources

- See [Params provided by all Supply Chains to all Resources](#)

Package

[Out of the Box Supply Chain Basic](#)

More information

See [Install Out of the Box Supply Chain Basic](#) for information about setting tap-values at installation time.

Testing-Image-to-URL

- Fetches a prebuilt image.
- Writes the Kubernetes configuration necessary to deploy the application.
- Commits that configuration to either a Git repository or an image registry.

Resources

image-provider

Refers to [image-provider-template](#).

Parameters provided:

- `serviceAccount` from tap-value `service_account`. Overridable by workload.

Common resources

- [Config-Provider](#)
- [App-Config](#)
- [Service-Bindings](#)
- [Api-Descriptors](#)
- [Config-Writer](#)
- [Deliverable](#)

Parameters provided to all resources

- See [Params provided by all Supply Chains to all Resources](#)

Package

[Out of the Box Supply Chain Testing](#)

More information

See [Install Out of the Box Supply Chain with Testing](#) for information about setting tap-values at installation time.

Scanning-image-scan-to-URL

- Fetches a prebuilt image.
- Scans the image for vulnerabilities.
- Writes the Kubernetes configuration necessary to deploy the application.
- Commits the configuration to either a Git repository or an image registry.

Resources

image-provider

Refers to [image-provider-template](#).

Parameters provided:

- `serviceAccount` from tap-value `service_account`. Overridable by workload.

image-scanner

Refers to [image-scanner-template](#).

Parameters provided:

- `scanning_image_policy` from tap-value `scanning.image.policy`. Overridable by workload.
- `scanning_image_template` from tap-value `scanning.image.template`. Overridable by workload.

Common resources

- [Config-Provider](#)
- [App-Config](#)
- [Service-Bindings](#)
- [Api-Descriptors](#)
- [Config-Writer](#)
- [Deliverable](#)

Parameters provided to all resources

- See [Params provided by all Supply Chains to all Resources](#)

Package

[Out of the Box Supply Chain Testing Scanning](#)

More information

See [Install Out of the Box Supply Chain with Testing and Scanning](#) for information about setting tap-values at installation time.

Source-to-URL-Package (experimental)

Purpose

- Fetches the application source code.
- Builds the source code into an image.
- Bundles the Kubernetes configuration necessary to deploy the application into a Carvel Package.
- Commits the Package to a Git Repository.

Resources

This section describes the templates and their parameters.

source-provider

Refers to [source-template](#).

Parameters provided:

- `serviceAccount` from tap-value `service_account`. Overridable by workload.

image-provider

Refers to [kaniko-template](#) when the workload provides a parameter `dockerfile`. Refers to [kpack-template](#) otherwise.

Parameters provided:

- `serviceAccount` from tap-value `service_account`. Overridable by workload.
- `registry` from tap-value `registry`. NOT overridable by workload.
- `clusterBuilder` from tap-value `cluster_builder`. Overridable by workload.
- `dockerfile` value `./Dockerfile`. Overridable by workload.
- `docker_build_context` value `./`. Overridable by workload.
- `docker_build_extra_args` value `[]`. Overridable by workload.

carvel-package

Refers to [carvel-package](#).

Parameters provided:

- `serviceAccount` from tap-value `service_account`. Overridable by workload.
- `registry` from tap-value `registry`. NOT overridable by workload.

package-config-writer

Refers to the [package-config-writer-and-pull-requester-template](#) when the tap-value `gitops.commit_strategy` is `pull_request`. Otherwise, this resource refers to the [package-config-writer-template](#).

Parameters provided:

- `serviceAccount` from tap-value `service_account`. Overridable by workload.
- `registry` from tap-value `registry`. NOT overridable by workload.

Common resources

- [Config-Provider](#)
- [App-Config](#)
- [Service-Bindings](#)
- [Api-Descriptors](#)

Parameters provided to all resources

- `maven_repository_url` from tap-value `maven.repository.url`. NOT overridable by workload.
- `maven_repository_secret_name` from tap-value `maven.repository.secret_name`. NOT overridable by workload.
- `carvel_package_gitops_subpath` from tap-value `carvel_package.gitops_subpath`. Overridable by workload.
- `carvel_package_name_suffix` from tap-value `carvel_package.name_suffix`. Overridable by workload.
- See [Params provided by all Supply Chains to all Resources](#)

Package

[Out of the Box Supply Chain Basic](#)

More information

See [Install Out of the Box Supply Chain Basic](#) for information about setting tap-values at installation time.

Basic-Image-to-URL-Package (experimental)

- Fetches a prebuilt image.
- Bundles the Kubernetes configuration necessary to deploy the application into a Carvel Package.
- Commits the Package to a Git Repository.

Resources

image-provider

Refers to [image-provider-template](#).

Parameters provided:

- `serviceAccount` from tap-value `service_account`. Overridable by workload.

carvel-package

Refers to [carvel-package](#).

Parameters provided:

- `serviceAccount` from tap-value `service_account`. Overridable by workload.
- `registry` from tap-value `registry`. NOT overridable by workload.

package-config-writer

Refers to the [package-config-writer-and-pull-requester-template](#) when the tap-value `gitops.commit_strategy` is `pull_request`. Otherwise, this resource refers to the [package-config-writer-template](#)

Parameters provided:

- `serviceAccount` from tap-value `service_account`. Overridable by workload.
- `registry` from tap-value `registry`. NOT overridable by workload.

Common resources

- [Config-Provider](#)
- [App-Config](#)
- [Service-Bindings](#)
- [Api-Descriptors](#)
- [Config-Writer](#)
- [Deliverable](#)

Parameters provided to all resources

- `carvel_package_gitops_subpath` from tap-value `carvel_package.gitops_subpath`. Overridable by workload.
- `carvel_package_name_suffix` from tap-value `carvel_package.name_suffix`. Overridable by workload.
- See [Params provided by all Supply Chains to all Resources](#)

Package

[Out of the Box Supply Chain Basic](#)

More information

See [Install Out of the Box Supply Chain Basic](#) for information about setting tap-values at installation time.

Resources common to all OOTB supply chains

config-provider

Refers to [convention-template](#).

Parameters provided:

- `serviceAccount` from tap-value `service_account`. Overridable by workload.

app-config

The tap-values field `supported_workloads` defines which templates are referred to by this resource. Default configuration is:

```
supported_workloads:
- type: web
  cluster_config_template_name: config-template
- type: server
  cluster_config_template_name: server-template
- type: worker
  cluster_config_template_name: worker-template
```

The workload's `apps.tanzu.vmware.com/workload-type` label determines which template is used at this step. For example, when the workload has a label `apps.tanzu.vmware.com/workload-type:web`, the supply chain references `config-template`.

No parameters are provided by the supply-chain.

service-bindings

Refers to the [service-binding template](#).

No parameters are provided by the supply-chain.

api-descriptors

Refers to the [api-descriptors template](#).

No parameters are provided by the supply-chain.

config-writer

Refers to the [config-writer-and-pull-requester-template](#) when the tap-value `gitops.commit_strategy` is `pull_request`. Otherwise, this resource refers to the [config-writer-template](#)

Parameters provided:

- `serviceAccount` from tap-value `service_account`. Overridable by workload.
- `registry` from tap-value `registry`. NOT overridable by workload.

deliverable

Refers to the [external-deliverable-template](#) when the tap-value `external_delivery` evaluates to `true`. Otherwise the resource refers to the [deliverable-template](#).

Parameters provided:

- `registry` from tap-value `registry`. NOT overridable by workload.

Parameters provided by all supply chains to all resources

All of the following parameters are overridable by the workload.

- `gitops_branch` from tap-value `gitops.branch`
- `gitops_user_name` from tap-value `gitops.username`
- `gitops_user_email` from tap-value `gitops.email`
- `gitops_commit_message` from tap-value `gitops.commit_message`
- `gitops_ssh_secret` from tap-value `gitops.ssh_secret`
- `gitops_repository_prefix` from tap-value `gitops.repository_prefix` when present.
- `gitops_server_address` from tap-value `gitops.server_address` when present.
- `gitops_repository_owner` from tap-value `gitops.repository_owner` when present.
- `gitops_repository_name` from tap-value `gitops.repository_name` when present.
- `gitops_server_kind` from tap-value `gitops.pull_request.server_kind` when present.
- `gitops_commit_branch` from tap-value `gitops.pull_request.commit_branch` when present.
- `gitops_pull_request_title` from tap-value `gitops.pull_request.pull_request_title` when present.
- `gitops_pull_request_body` from tap-value `gitops.pull_request.pull_request_body` when present.

Template reference for Supply Chain Choreographer

This topic describes the objects from templates that you can use with Supply Chain Choreographer.

All the objects referenced in this topic are [Cartographer Templates](#) packaged in [Out of the Box Templates](#).

This topic describes:

- The purpose of the templates
- The one or more objects that the templates create
- The supply chains that include the templates
- The parameters that the templates use

source-template

Purpose

Creates an object to fetch source code and make that code available to other objects in the supply chain. See [Building from Source](#).

Used by

- [Source-to-URL](#) in the `source-provider` step.
- [Source-Test-to-URL](#) in the `source-provider` step.
- [Source-Test-Scan-to-URL](#) in the `source-provider` step.
- [Source-to-URL-Package \(experimental\)](#) in the `source-provider` step.

Creates

The source-template creates one of three objects, either:

- `GitRepository`. Created if the workload has `.spec.source.git` defined.
- `MavenArtifact`. Created if the template is provided a value for the parameter `maven`.
- `ImageRepository`. Created if the workload has `.spec.source.image` defined.

GitRepository

`GitRepository` makes source code from a particular commit available as a tarball in the cluster. Other resources in the supply chain can then access that code.

Parameters

Template reference for Supply Chain Choreographer

Parameter name	Meaning	Example
<code>gitImplementation</code>	The library used to fetch source code.	<pre> - name: gitImplementation value: go-git` </pre>
<code>gitops_ssh_secret</code>	Name of the secret used to provide credentials for the Git repository. The secret with this name must exist in the same namespace as the <code>Workload</code> . The credentials must be sufficient to read the repository. If not provided, Tanzu Application Platform defaults to look for a secret named <code>git-ssh</code> . See Git authentication .	<pre> - name: gitops_ssh_secret value: git-credentials </pre>

More information

For an example using the Tanzu CLI to create a Workload using GitHub as the provider of source code, see [Create a workload from GitHub repository](#).

For information about GitRepository objects, see [GitRepository](#).

ImageRepository

`ImageRepository` makes the contents of a container image available as a tarball on the cluster.

Parameters

Parameter name	Meaning	Example
<code>serviceAccount</code>	Name of the service account, providing credentials to <code>ImageRepository</code> for fetching container images. The service account must exist in the same namespace as the Workload.	<pre>- name: serviceAccount value: default</pre>



Note

When using the Tanzu CLI to configure this `serviceAccount` parameter, use `--param serviceAccount=...`. The similarly named `--service-account` flag sets a different value: the `spec.serviceAccountName` key in the Workload object.

More information

For information about the ImageRepository resource, see the [ImageRepository reference documentation](#).

For information about how to use the Tanzu CLI to create a workload leveraging ImageRepository, see [Create a workload from local source code](#).

MavenArtifact

`MavenArtifact` makes a pre-built Java artifact available to as a tarball on the cluster.

While the `source-template` leverages the workload's `.spec.source` field when creating a `GitRepository` or `ImageRepository` object, the creation of the `MavenArtifact` relies only on parameters in the Workload.

Parameters

Parameter name	Meaning	Example
<code>maven</code>	Points to the Maven artifact to fetch and the polling interval.	<pre> - name: maven value: artifactId: springboot-initial groupId: com.example version: RELEASE classifier: sources # optional type: jar # optional artifactRepositoryTimeout: 1m0s # optional </pre>
<code>maven_repository_url</code>	Specifies the Maven repository from which to fetch	<pre> - name: maven_repository_url value: https://repo1.maven.org/maven2/ </pre>
<code>maven_repository_secret_name</code>	Specifies the secret containing credentials necessary to fetch from the Maven repository. The secret named must exist in the same workspace as the workload.	<pre> - name: maven_repository_secret_name value: auth-secret </pre>

More information

For information about the custom resource, see [MavenArtifact reference docs](#).

For information about how to use the custom resource with the `tanzu apps workload` CLI plug-in [Create a Workload from Maven repository artifact](#).

testing-pipeline

Purpose

Tests the source code provided in the supply chain. Testing depends on a user provided [Tekton Pipeline](#). Parameters for this template allow for selection of the proper Pipeline and for specification of additional values to pass to the Pipeline.

Used by

- [Source-Test-to-URL](#) in the source-tester step.
- [Source-Test-Scan-to-URL](#) in the source-tester step.

These are used as the `source-tester` resource.

Creates

`testing-pipeline` creates a [Runnable](#) object. This Runnable provides inputs to the ClusterRunTemplate named `tekton-source-pipelinerun`.

Parameters

Parameter name	Meaning	Example
<code>testing_pipeline_matching_labels</code>	Set of labels to use when searching for Tekton Pipeline objects in the same namespace as the Workload. By default, a Pipeline labeled as <code>apps.tanzu.vmware.com/pipeline: test</code> is selected.	<pre> - name: testing_pipeline_matching_labels value: apps.tanzu.vmware.com/pipeline: test my.comp.any/language: golang </pre>
<code>testing_pipeline_params</code>	Set of parameters to pass to the Tekton Pipeline. To this set of parameters, the template always adds the source URL and revision as <code>source-url</code> and <code>source-revision</code> .	<pre> - name: testing_pipeline_params value: - name: verbose value: true - name: foo value: bar </pre>

More information

For information about the ClusterRunTemplate that pairs with the Runnable, read [tekton-source-pipelinerun](#)

For information about the Tekton Pipeline that the user must create, read the [OOTB Supply Chain Testing documentation of the Pipeline](#)

source-scanner-template

Purpose

Scans the source code for vulnerabilities.

Used by

- `Source-Test-Scan-to-URL` in the source-scanner step.

This is used as the `source-scanner` resource.

Creates

[SourceScan](#)

Parameters

Parameter name	Meaning	Example
<code>scanning_source_template</code>	Name of the ScanTemplate object to use for running the scans. The ScanTemplate must be in the same namespace as the Workload.	<pre>- name: scanning_source_template value: private-source-scan-template</pre>
<code>scanning_source_policy</code>	Name of the ScanPolicy object to use when evaluating the scan results of a source scan. The ScanPolicy must be in the same namespace as the Workload.	<pre>- name: scanning_source_policy value: allowlist-policy</pre>

More information

For information about how to set up the Workload namespace with the ScanPolicy and ScanTemplate required for this resource, see [Out of the Box Supply Chain with Testing and Scanning](#).

For information about the SourceScan custom resource, see [SourceScan reference](#).

For information about how the artifacts found during scanning are catalogued, see [Supply Chain Security Tools for Tanzu – Store](#).

image-provider-template

Purpose

Fetches a container image of a prebuilt application, specified in the workload's `.spec.image` field. This makes the content-addressable name, (e.g. the image name containing the digest) available to other resources in the supply chain.

Used by

- [Basic-Image-to-URL](#) in the image-provider step.
- [Testing-Image-to-URL](#) in the image-provider step.
- [Scanning-Image-Scan-to-URL](#) in the image-provider step.
- [Basic-Image-to-URL-Package \(experimental\)](#) in the image-provider step.

These are used as the `image-provider` resource.

Creates

ImageRepository.source.apps.tanzu.vmware.com

Parameters

Parameter name	Meaning	Example
<code>serviceAccount</code>	Name of the service account providing credentials for the target image registry. The service account must exist in the same namespace as the Workload.	<pre>- name: serviceAccount value: default</pre>



Note

When using the Tanzu CLI to configure this `serviceAccount` parameter, use `--param serviceAccount=...`. The similarly named `--service-account` flag sets a different value: the `spec.serviceAccountName` key in the Workload object.

More information

For information about the ImageRepository resource, see [ImageRepository reference docs](#).

For information about prebuilt images, see [Using a prebuilt image](#).

kpack-template

Purpose

Builds a container image from source code using [cloud native buildpacks](#).

Used by

- [Source-to-URL](#) in the image-provider step.
- [Source-Test-to-URL](#) in the image-provider step.
- [Source-Test-Scan-to-URL](#) in the image-provider step.
- [Source-to-URL-Package \(experimental\)](#) in the image-provider step.

These are used as the `image-provider` resource when the workload parameter `dockerfile` is not defined.

Creates

[Image.kpack.io](#)

Parameters

Parameter name	Meaning	Example
<code>serviceAccount</code>	Name of the service account providing credentials for the configured image registry. <code>Image</code> uses these credentials to push built container images to the registry. The service account must exist in the same namespace as the Workload.	<pre>- name: serviceAccount value: default</pre>

Parameter name	Meaning	Example
<code>clusterBuilder</code>	Name of the Kpack Cluster Builder to use.	<pre>- name: clusterBuilder value: nodejs-cluster-builder</pre>
<code>buildServiceBindings</code>	Definition of a list of service bindings to make use at build time. For example, providing credentials for fetching dependencies from repositories that require credentials.	<pre>- name: buildServiceBindings value: - name: settings-xml kind: Secret apiVersion: v1</pre>
<code>live-update</code>	Enable the use of Tilt's live-update function.	<pre>- name: live-update value: "true"</pre>



Note

When using the Tanzu CLI to configure this `serviceAccount` parameter, use `--parameter serviceAccount=...`. The similarly named `--service-account` flag sets a different value: the `spec.serviceAccountName` key in the Workload object.

More information

For information about the integration with Tanzu Build Service, see [Tanzu Build Service Integration](#).

For information about `live-update`, see [Developer Conventions](#) and [Overview of Tanzu Developer Tools for IntelliJ](#).

For information about using Kpack builders with `clusterBuilder`, see [Builders](#).

For information about `buildServiceBindings`, see [Service Bindings](#).

kaniko-template

Purpose

Build an image for source code that includes a Dockerfile.

Used by

- [Source-to-URL](#) in the image-provider step.
- [Source-Test-to-URL](#) in the image-provider step.

- [Source-Test-Scan-to-URL](#) in the image-provider step.
- [Source-to-URL-Package \(experimental\)](#) in the image-provider step.

These are used as the `image-provider` resource when the workload parameter `dockerfile` is defined.

Creates

A taskrun.tekton.dev which provides configuration to a Tekton ClusterTask to build an image with kaniko.

This template uses the `lifecycle: tekton` flag to create new immutable objects rather than updating the previous object.

Parameters

Parameter name	Meaning	Example
<code>dockerfile</code>	relative path to the Dockerfile file in the build context	<pre>./Dockerfile</pre>
<code>docker_build_context</code>	relative path to the directory where the build context is	<pre>.</pre>
<code>docker_build_extra_args</code>	List of flags to pass directly to kaniko, such as providing arguments to a build.	<pre>- --build-arg=FOO=BAR</pre>
<code>serviceAccount</code>	Name of the service account to use for providing Docker credentials. The service account must exist in the same namespace as the Workload. The service account must have a secret associated with the credentials. See Configuring authentication for Docker in the Tekton documentation.	<pre>- name: serviceAccount value: default</pre>
<code>registry</code>	Specification of the registry server and repository in which the built image is placed.	<pre>- name: registry value: server: index.docker.io repository: web-team</pre>

More information

For information about how to use Dockerfile-based builds and limits associated with the function, see [Dockerfile-based builds](#).

For information about `lifecycle:tekton`, read [Cartographer Lifecycle](#).

image-scanner-template

Purpose

Scans the container image for vulnerabilities, persists the results in a store, and prevents the image from moving forward if CVEs are found which are not compliant with its referenced ScanPolicy.

Used by

- [Source-Test-Scan-to-URL](#) in the image-scanner step.
- [Scanning-Image-Scan-to-URL](#) in the image-scanner step.

Creates

ImageScan.scanning.apps.tanzu.vmware.com

Parameters

Parameter name	Meaning	Example
<code>scanning_image_template</code>	Name of the ScanTemplate object for running the scans against a container image. The ScanTemplate must be in the same namespace as the Workload.	<pre>- name: scanning_image_template value: private-image-scan-template</pre>
<code>scanning_image_policy</code>	Name of the ScanPolicy object for evaluating the scan results of an image scan. The ScanPolicy must be in the same namespace as the Workload.	<pre>- name: scanning_image_policy value: allowlist-policy</pre>

More information

For information about the ImageScan custom resource, see [ImageScan reference](#).

For information about how the artifacts found during scanning are catalogued, see [Supply Chain Security Tools for Tanzu – Store](#).

convention-template

Purpose

Create the PodTemplateSpec for the Kubernetes configuration (e.g. the knative service or kubernetes deployment) which are applied to the cluster.

Used by

- [Source-to-URL](#) in the config-provider step.
- [Basic-Image-to-URL](#) in the config-provider step.
- [Source-Test-to-URL](#) in the config-provider step.
- [Testing-Image-to-URL](#) in the config-provider step.
- [Source-Test-Scan-to-URL](#) in the config-provider step.
- [Scanning-Image-Scan-to-URL](#) in the config-provider step.

- [Source-to-URL-Package \(experimental\)](#) in the config-provider step.
- [Basic-Image-to-URL-Package \(experimental\)](#) in the config-provider step.

Creates

Creates a [PodIntent](#) object. The PodIntent leverages conventions installed on the cluster. The PodIntent object is responsible for generating a PodTemplateSpec. The PodTemplateSpec is used in app configs, such as knative services and deployments, to represent the shape of the pods to run the application in containers.

Parameters

Parameter name	Meaning	Example
<code>serviceAccount</code>	Name of the serviceAccount providing necessary credentials to PodIntent . The serviceAccount must be in the same namespace as the Workload. The serviceAccount is set as the <code>serviceAccountName</code> in the podtemplatespec. The credentials associated with the serviceAccount must allow fetching the container image used to inspect the metadata passed to convention servers.	<pre>- name: serviceAccount value: default</pre>
<code>annotations</code>	Extra set of annotations to pass down to the PodTemplateSpec.	<pre>- name: annotations value: name: my-application version: v1.2.3 team: store</pre>
<code>debug</code>	Put the workload in debug mode.	<pre>- name: debug value: "true"</pre>
<code>live-update</code>	Enable live-updating of the code (for innerloop development).	<pre>- name: live-update value: "true"</pre>

**Note**

When using the Tanzu CLI to configure this `serviceAccount` parameter, use `--param serviceAccount=...`. The similarly named `--service-account` flag sets a different value: the `spec.serviceAccountName` key in the Workload object.

More information

For information about `PodTemplateSpec`, see [PodTemplateSpec](#) in the Kubernetes documentation.

For information about conventions, see [Cartographer Conventions](#).

For information about the two convention servers enabled by default in Tanzu Application Platform installations, see [Developer Conventions](#) and [Spring Boot conventions](#).

config-template

Purpose

For workloads with the label `apps.tanzu.vmware.com/workload-type: web`, define a knative service.

Used by

- [Source-to-URL](#) in the app-config step.
- [Basic-Image-to-URL](#) in the app-config step.
- [Source-Test-to-URL](#) in the app-config step.
- [Testing-Image-to-URL](#) in the app-config step.
- [Source-Test-Scan-to-URL](#) in the app-config step.
- [Scanning-Image-Scan-to-URL](#) in the app-config step.

Creates

A ConfigMap, in which the data field has a key `delivery.yaml` whose value is the definition of a knative service.

Parameters

None

More information

See [workload types](#) for more details about the three different types of workloads.

worker-template

Purpose

For workloads with the label `apps.tanzu.vmware.com/workload-type: worker`, define a Kubernetes Deployment.

Used by

- [Source-to-URL](#) in the app-config step.
- [Basic-Image-to-URL](#) in the app-config step.

- [Source-Test-to-URL](#) in the app-config step.
- [Testing-Image-to-URL](#) in the app-config step.
- [Source-Test-Scan-to-URL](#) in the app-config step.
- [Scanning-Image-Scan-to-URL](#) in the app-config step.

Creates

A ConfigMap, in which the data field has a key `delivery.yaml` whose value is the definition of a Kubernetes Deployment.

Parameters

None

More information

For information about the three different types of workloads, see [workload types](#).

server-template

Purpose

For workloads with the label `apps.tanzu.vmware.com/workload-type: server`, define a Kubernetes Deployment and a Kubernetes Service.

Used by

- [Source-to-URL](#) in the app-config step.
- [Basic-Image-to-URL](#) in the app-config step.
- [Source-Test-to-URL](#) in the app-config step.
- [Testing-Image-to-URL](#) in the app-config step.
- [Source-Test-Scan-to-URL](#) in the app-config step.
- [Scanning-Image-Scan-to-URL](#) in the app-config step.
- [Source-to-URL-Package \(experimental\)](#) in the app-config step.
- [Basic-Image-to-URL-Package \(experimental\)](#) in the app-config step.

Creates

A ConfigMap, in which the data field has a key `delivery.yaml` whose value is the definitions of a Kubernetes Deployment and a Kubernetes Service to expose the pods.

Parameters

Parameter name	Meaning	Example
<code>ports</code>	Set of network ports to expose from the application to the Kubernetes cluster.	<pre> - name: ports value: - containerPort: 2025 name: smtp port: 25 </pre>

More information

For information about the three different types of workloads, see [workload types](#).

For information about the ports parameter, see [server-specific Workload parameters](#).

service-bindings

Purpose

Adds [ServiceBindings](#) to the set of Kubernetes configuration files.

Used by

- [Source-to-URL](#) in the service-bindings step.
- [Basic-Image-to-URL](#) in the service-bindings step.
- [Source-Test-to-URL](#) in the service-bindings step.
- [Testing-Image-to-URL](#) in the service-bindings step.
- [Source-Test-Scan-to-URL](#) in the service-bindings step.
- [Scanning-Image-Scan-to-URL](#) in the service-bindings step.
- [Source-to-URL-Package \(experimental\)](#) in the service-bindings step.
- [Basic-Image-to-URL-Package \(experimental\)](#) in the service-bindings step.

Creates

A ConfigMap. This template consumes input of multiple deployment YAML files and enriches the input with ResourceClaims and ServiceBindings if the workload contains serviceClaims.

Parameters

Parameter name	Meaning	Example
<code>annotations</code>	Extra set of annotations to pass down to the ServiceBinding and ResourceClaim objects.	<pre> - name: annotations value: name: my-application version: v1.2.3 team: store </pre>

More information

For an example, see [--service-ref](#) in the Tanzu CLI documentation.

For an overview of the function, see [Consume services on Tanzu Application Platform](#).

api-descriptors

Purpose

The `api-descriptor` resource takes care of adding an `APIDescriptor` to the set of Kubernetes objects to deploy such that API auto registration takes place.

Used by

- [Source-to-URL](#) in the api-descriptors step.
- [Basic-Image-to-URL](#) in the api-descriptors step.
- [Source-Test-to-URL](#) in the api-descriptors step.
- [Testing-Image-to-URL](#) in the api-descriptors step.
- [Source-Test-Scan-to-URL](#) in the api-descriptors step.
- [Scanning-Image-Scan-to-URL](#) in the api-descriptors step.
- [Source-to-URL-Package \(experimental\)](#) in the api-descriptors step.
- [Basic-Image-to-URL-Package \(experimental\)](#) in the api-descriptors step.

Creates

A ConfigMap. This template consumes input of multiple YAML files and enriches the input with an `APIDescriptor` if the workload has a label `apis.apps.tanzu.vmware.com/register-api` set to `true`.

Parameters

Parameter name	Meaning	Example
<code>annotations</code>	Extra set of annotations to pass down to the <code>APIDescriptor</code> object.	<pre>- name: annotations value: name: my-application version: v1.2.3 team: store</pre>
<code>api_descriptor</code>	Information used to fill the state that you want of the <code>APIDescriptor</code> object (its spec).	<pre>- name: api_descriptor value: type: openapi location: baseURL: http://petclinic-hard-coded.my-apps.tapdemo.vmware.com/ path: "/v3/api owner: team-petclinic system: pet-clinics description: "example"</pre>

More information

For information about API auto registration, see [Use API Auto Registration](#).

config-writer-template

Purpose

Persist in an external system, such as a registry or git repository, the Kubernetes configuration passed to the template.

Used by

- [Source-to-URL](#) in the config-writer step.
- [Basic-Image-to-URL](#) in the config-writer step.
- [Source-Test-to-URL](#) in the config-writer step.
- [Testing-Image-to-URL](#) in the config-writer step.
- [Source-Test-Scan-to-URL](#) in the config-writer step.
- [Scanning-Image-Scan-to-URL](#) in the config-writer step.

Creates

A runnable which creates a Tekton TaskRun that refers either to the Tekton Task [git-writer](#) or the Tekton Task [image-writer](#).

Parameters

Parameter name	Meaning	Example
<code>serviceAccount</code>	Name of the service account which provides the credentials to the registry or repository. The service account must exist in the same namespace as the Workload.	<pre>- name: serviceAccount value: default</pre>
<code>gitops_branch</code>	Name of the branch to push the configuration to.	<pre>- name: gitops_branch value: main</pre>
<code>gitops_user_name</code>	User name to use in the commits.	<pre>- name: gitops_user_name value: "Alice Lee"</pre>
<code>gitops_user_email</code>	User email address to use in the commits.	<pre>- name: gitops_user_email value: alice@example.com</pre>

Parameter name	Meaning	Example
<code>gitops_commit_message</code>	Message to write as the body of the commits produced for pushing configuration to the Git repository.	<pre>- name: gitops_commit_message value: "ci bump"</pre>
<code>gitops_repository</code>	The full repository URL to which the configuration is committed. DEPRECATED	<pre>- name: gitops_repository value: "https://github.com/vmware-tanzu/cartographer"</pre>
<code>gitops_repository_prefix</code>	The prefix of the repository URL. DEPRECATED	<pre>- name: gitops_repository value: "https://github.com/vmware-tanzu/"</pre>
<code>gitops_server_address</code>	The server URL of the Git repository to which configuration is applied.	<pre>- name: gitops_server_address value: "https://github.com/"</pre>
<code>gitops_repository_owner</code>	The owner/organization to which the repository belongs.	<pre>- name: gitops_repository_owner value: vmware-tanzu</pre>
<code>gitops_repository_name</code>	The name of the repository.	<pre>- name: gitops_repository_name value: cartographer</pre>
<code>registry</code>	Specification of the registry server and repository in which the configuration is placed.	<pre>- name: registry value: server: index.docker.io repository: web - team ca_cert_data: -----BEGIN CERTIFICATE----- MIFXzCCA0egAwIBAgIJAjYm37SFocjlMA0GCSqGSIb3DQEBAQUAMEY... -----END CERTIFICATE-----</pre>

More information

For information about operating this template, see [Gitops vs RegistryOps](#) and the [config-writer-and-pull-requester-template](#).

config-writer-and-pull-requester-template

Purpose

Persist the passed in Kubernetes configuration to a branch in a repository and open a pull request to another branch. This process allows for manual review of configuration before deployment to a cluster.

Used by

- [Source-to-URL](#) in the config-writer step.
- [Basic-Image-to-URL](#) in the config-writer step.
- [Source-Test-to-URL](#) in the config-writer step.
- [Testing-Image-to-URL](#) in the config-writer step.
- [Source-Test-Scan-to-URL](#) in the config-writer step.
- [Scanning-Image-Scan-to-URL](#) in the config-writer step.

Creates

A runnable which provides configuration to the ClusterRunTemplate [commit-and-pr-pipelinerun](#) to create a Tekton TaskRun. The Tekton TaskRun refers to the Tekton Task [commit-and-pr](#).

Parameters

Parameter name	Meaning	Example
<code>serviceAccount</code>	Name of the service account which provides the credentials to the registry or repository. The service account must exist in the same namespace as the Workload.	<pre> - name: serviceAccount value: default </pre>
<code>gitops_commit_branch</code>	Name of the branch to which configuration is pushed.	<pre> - name: gitops_commit_branch value: feature </pre>
<code>gitops_branch</code>	Name of the branch to which a pull request is opened.	<pre> - name: gitops_branch value: main </pre>

Parameter name	Meaning	Example
<code>gitops_user_name</code>	User name to use in the commits.	<pre>- name: gito ps_user_name value: "Alice Lee"</pre>
<code>gitops_user_email</code>	User email address to use in the commits.	<pre>- name: gito ps_user_email value: alice@example.com</pre>
<code>gitops_commit_message</code>	Message to write as the body of the commits produced for pushing configuration to the Git repository.	<pre>- name: gito ps_commit_message value: "ci bump"</pre>
<code>gitops_pull_request_title</code>	Title of the pull request to be opened.	<pre>- name: gito ps_pull_request_title value: "ready for review"</pre>
<code>gitops_pull_request_body</code>	Body of the pull request to be opened.	<pre>- name: gito ps_pull_request_body value: "generated by supply chain"</pre>
<code>gitops_server_address</code>	The server URL of the Git repository to which configuration is applied.	<pre>- name: gito ps_server_address value: "https://github.com/"</pre>
<code>gitops_repository_owner</code>	The owner/organization to which the repository belongs.	<pre>- name: gito ps_repository_owner value: vmware-tanzu</pre>
<code>gitops_repository_name</code>	The name of the repository.	<pre>- name: gito ps_repository_name value: cartographer</pre>

Parameter name	Meaning	Example
<code>gitops_server_kind</code>	The kind of Git provider	<pre> - name: gitops_server_kind value: gitlab </pre>

More information

For information about the operation of this template, see [Gitops vs RegistryOps](#) and the [config-writer-template](#).

deliverable-template

Purpose

Create a deliverable which [pairs with a Delivery](#) to deploy Kubernetes configuration on the cluster.

Used by

- [Source-to-URL](#) in the deliverable step.
- [Basic-Image-to-URL](#) in the deliverable step.
- [Source-Test-to-URL](#) in the deliverable step.
- [Testing-Image-to-URL](#) in the deliverable step.
- [Source-Test-Scan-to-URL](#) in the deliverable step.
- [Scanning-Image-Scan-to-URL](#) in the deliverable step.

Creates

A [Deliverable](#) preconfigured with reference to a repository or registry from which to fetch Kubernetes configuration.

Parameters

Parameter name	Meaning	Example
<code>serviceAccount</code>	Name of the service account providing the necessary permissions for the Delivery to create children objects. Populates the Deliverable's <code>serviceAccount</code> parameter. The service account must be in the same namespace as the Deliverable.	<pre> - name: serviceAccount value: default </pre>
<code>gitops_ssh_secret</code>	Name of the secret where credentials exist for fetching the configuration from a Git repository. Populates the Deliverable's <code>gitops_ssh_secret</code> parameter. The service account must be in the same namespace as the Deliverable.	<pre> - name: gitops_ssh_secret value: ssh-secret </pre>

Parameter name	Meaning	Example
<code>gitops_branch</code>	Name of the branch from which to fetch the configuration.	<pre>- name: gitops_ branch value: main</pre>
<code>gitops_repository</code>	The full repository URL to which the configuration is fetched. DEPRECATED	<pre>- name: gitops_ repository value: "http s://github.com/vmware -tanzu/cartographer"</pre>
<code>gitops_repository_prefix</code>	The prefix of the repository URL. DEPRECATED	<pre>- name: gitops_ repository value: "http s://github.com/vmware -tanzu/"</pre>
<code>gitops_server_address</code>	The server URL of the Git repository from which configuration is fetched.	<pre>- name: gitops_ server_address value: "http s://github.com/"</pre>
<code>gitops_repository_owner</code>	The owner/organization to which the repository belongs.	<pre>- name: gitops_ repository_owner value: vmware -tanzu</pre>
<code>gitops_repository_name</code>	The name of the repository.	<pre>- name: gitops_ repository_name value: cartog rapher</pre>

Parameter name	Meaning	Example
<code>registry</code>	Specification of the registry server and repository from which the configuration is fetched.	<pre> - name: registry value: server: index.docker.io repository: web-team ca_certificate: -----BEGIN CERTIFICATE----- MIIFXzCCA 0egAwIBAgIJAJYm37SFoc jlMA0GCSqGSIb3DQEBAQU AMEY... -----END CERTIFICATE----- </pre>



Note

When using the Tanzu CLI to configure this `serviceAccount` parameter, use `--param serviceAccount=...`. The similarly named `--service-account` flag sets a different value: the `spec.serviceAccountName` key in the Workload object.

More information

For information about the ClusterDelivery shipped with `ootb-delivery-basic`, see [Out of the Box Delivery Basic](#).

external-deliverable-template

Purpose

Create a definition of a deliverable which a user can manually applied to an external kubernetes cluster. When a properly configured Delivery is installed on that external cluster, the Deliverable will [pair with the Delivery](#) to deploy Kubernetes configuration on the cluster. For example, the [OOTB Delivery](#).

Used by

- [Source-to-URL](#) in the deliverable step.
- [Basic-Image-to-URL](#) in the deliverable step.
- [Source-Test-to-URL](#) in the deliverable step.
- [Testing-Image-to-URL](#) in the deliverable step.
- [Source-Test-Scan-to-URL](#) in the deliverable step.
- [Scanning-Image-Scan-to-URL](#) in the deliverable step.

Creates

A configmap in which the `.data` field has a key `deliverable` for which the value is the YAML definition of a [Deliverable](#).

Parameters

Parameter name	Meaning	Example
<code>serviceAccount</code>	Name of the service account providing the necessary permissions for the Delivery to create children objects. Populates the Deliverable's <code>serviceAccount</code> parameter. The service account must be in the same namespace as the Deliverable.	<pre>- name: serviceAccount value: default</pre>
<code>gitops_ssh_secret</code>	Name of the secret where credentials exist for fetching the configuration from a Git repository. Populates the Deliverable's <code>gitops_ssh_secret</code> parameter. The service account must be in the same namespace as the Deliverable.	<pre>- name: gitops_ssh_secret value: ssh-secret</pre>
<code>gitops_branch</code>	Name of the branch from which to fetch the configuration.	<pre>- name: gitops_branch value: main</pre>
<code>gitops_repository</code>	The full repository URL to which the configuration is fetched. DEPRECATED	<pre>- name: gitops_repository value: "https://github.com/vmware-tanzu/cartographer"</pre>
<code>gitops_repository_prefix</code>	The prefix of the repository URL. DEPRECATED	<pre>- name: gitops_repository value: "https://github.com/vmware-tanzu/"</pre>
<code>gitops_server_address</code>	The server URL of the Git repository from which configuration is fetched.	<pre>- name: gitops_server_address value: "https://github.com/"</pre>
<code>gitops_repository_owner</code>	The owner/organization to which the repository belongs.	<pre>- name: gitops_repository_owner value: vmware-tanzu</pre>

Parameter name	Meaning	Example
<code>gitops_repository_name</code>	The name of the repository.	<pre> - name: gitops_ repository_name value: cartog rapher </pre>
<code>registry</code>	Specification of the registry server and repository from which the configuration is fetched.	<pre> - name: registr y value: server: ind ex.docker.io repository: web-team ca_cert_dat a: -----BEGIN N CERTIFICATE----- MIIFXzCCA 0egAwIBAgIJAJYm37SFoc jlMA0GCSqGSib3DQEBDQU AMEY... -----END CERTIFICATE----- </pre>

More information

For information about the ClusterDelivery shipped with `ootb-delivery-basic`, see [Out of the Box Delivery Basic](#).

For information about using the Deliverable object in a multicluster environment, see [Getting started with multicluster Tanzu Application Platform](#).

delivery-source-template

Purpose

Continuously fetches Kubernetes configuration files from a Git repository or container image registry and makes them available on the cluster.

Used by

- [Delivery-Basic](#)

Creates

The source-template creates one of three objects, either: - `GitRepository`. Created if the deliverable has `.spec.source.git` defined. - `ImageRepository`. Created if the deliverable has `.spec.source.image` defined.

GitRepository

`GitRepository` makes source code from a particular commit available as a tarball in the cluster. Other resources in the supply chain can then access that code.

Parameters

Parameter name	Meaning	Example
<code>gitImplementation</code>	The library used to fetch source code.	<pre>- name: gitImplementation value: go-git</pre>
<code>gitops_ssh_secret</code>	Name of the secret used to provide credentials for the Git repository. The secret with this name must exist in the same namespace as the <code>Deliverable</code> . The credentials must be sufficient to read the repository. If not provided, Tanzu Application Platform defaults to look for a secret named <code>git-ssh</code> . See Git authentication .	<pre>- name: gitops_ssh_secret value: git-credentials</pre>

More information

For an example using the Tanzu CLI to create a Workload using GitHub as the provider of source code, see [Create a workload from GitHub repository](#).

For information about GitRepository objects, see [GitRepository](#).

ImageRepository

`ImageRepository` makes the contents of a container image available as a tarball on the cluster.

Parameters

Parameter name	Meaning	Example
<code>serviceAccount</code>	Name of the service account, providing credentials to <code>ImageRepository</code> for fetching container images. The service account must exist in the same namespace as the <code>Deliverable</code> .	<pre>- name: serviceAccount value: default</pre>

More information

For information about the ImageRepository resource, see [ImageRepository reference docs](#).

app-deploy

Purpose

Applies Kubernetes configuration to the cluster.

Used by

- [Delivery-Basic](#)

Creates

A [kapp App](#).

Parameters

Parameter name	Meaning	Example
<code>serviceAccount</code>	Name of the service account providing the necessary privileges for <code>App</code> to apply the Kubernetes objects to the cluster. The service account must be in the same namespace as the Deliverable.	<pre>- name: serviceAccount value: e: default</pre>
<code>gitops_sub_path</code> (deprecated)	Sub directory within the configuration bundle that is used for looking up the files to apply to the Kubernetes cluster. DEPRECATED	<pre>- name: gitops_sub_path value: e: ./config</pre>



Note

The `gitops_sub_path` parameter is deprecated. Use `deliverable.spec.source.subPath` instead.

More information

For details about RBAC and how `kapp-controller` makes use of the ServiceAccount provided through the Deliverable's `serviceAccount` parameter, see [kapp-controller's Security Model](#).

carvel-package (experimental)

Purpose

Bundles Kubernetes configuration into a Carvel Package.

Used by

- [Source-to-URL-Package \(experimental\)](#) in the `carvel-package` step.
- [Basic-Image-to-URL-Package \(experimental\)](#) in the `carvel-package` step.

Creates

A `taskrun.tekton.dev` which provides configuration to a Tekton ClusterTask to bundle Kubernetes configuration into a Carvel Package.

This template uses the `lifecycle: tekton` flag to create new immutable objects rather than updating the previous object.

Parameters

Parameter name	Meaning	Example
<code>serviceAccount</code>	Name of the service account to use for providing Docker credentials. The service account must exist in the same namespace as the Workload. The service account must have a secret associated with the credentials. See Configuring authentication for Docker in the Tekton documentation.	<pre>- name: serviceAccount value: default</pre>
<code>registry</code>	Specification of the registry server and repository in which the built image is placed.	<pre>- name: registry value: server: index.docker.io repository: web-team</pre>
<code>carvel_package_gitops_subpath</code>	Specifies the subpath to which Carvel Packages should be written.	<pre>- name: carvel_package_gitops_subpath value: path/to/my/dir</pre>
<code>carvel_package_name_suffix</code>	Specifies the suffix to append to the Carvel Package name. The format is <code>WORKLOAD_NAME.WORKLOAD_NAMESPACE.carvel_package_name_suffix</code> . The full Carvel Package name must be a valid DNS subdomain name as defined in RFC 1123.	<pre>- name: carvel_package_name_suffix value: vmware.com</pre>

Parameter name	Meaning	Example
carvel_package_parameters	Specifies the custom Carvel Package parameters	<pre> - name: carvel_package_parameters value: - selector: matchLabels: apps.tanzu.vmware.com/workload-type: server schema: #@data/values-schema --- #@schema/title "Workload name" #@schema/desc "Required. Name of the workload, used by K8s Ingress HTTP rules." #@schema/example "tanzu-java-web-app" #@schema/validation min_len=1 workload_name: "" #@schema/title "Replicas" #@schema/desc "Number of replicas." replicas: 1 #@schema/title "Port" #@schema/desc "Port number for the backend associated with K8s Ingress." port: 8080 #@schema/title "Hostname" #@schema/desc "If set, K8s Ingress will be created with HTTP rules for hostname." #@schema/example "app.tanzu.vmware.com" hostname: "" #@schema/title "Cluster Issuer" #@schema/desc "CertManager Issuer to use to generate c </pre>

Parameter name	Meaning	Example
		<pre> ertificate for K8s Ingress." cluster_issuer: "tap-ingress-selfsigned" overlays: #@ load("@ytt:overlay", "overlay") #@ load("@ytt:data", "data") #@overlay/match by=overlay.subset({"apiVersion":"apps/v1", "kind": "Deployment"}) --- spec: #@overlay/match missing_ok=True replicas: #@ data.values.replicas #@ if data.values.hostname != "" --- apiVersion: networking.k8s.io/v1 kind: Ingress metadata: name: #@ data.values.workload_name annotations: cert-manager.io/cluster-issuer: #@ data.values.cluster_issuer ingress.kubernetes.io/force-ssl-redirect: "true" kubernetes.io/ingress.class: contour kapp.k14s.io/change-rule: "upsert after upserting Services" labels: app.kubernetes.io/component: "run" carto.run/workload-name: #@ data.values.workload_name spec: </pre>

Parameter name	Meaning	Example
		<pre> tls: - secr etName: #@ data.value s.workload_name host s: - #@ data.values.hostname rules: - host: #@ data.values.hostnam e http: path s: - pa thType: Prefix pa th: / ba ckend: service: name: #@ data.values.w orkload_name port: number: #@ data.value s.port #@ end - selector: matchLabel s: apps.tan zu.vmware.com/workload -type: web schema: #@data/val ues-schema --- #@schema/v alidation min_len=1 workload_n ame: "" overlays: "" - selector: matchLabel s: apps.tan zu.vmware.com/workload -type: worker schema: #@data/val ues-schema --- #@schema/v alidation min_len=1 workload_n ame: "" replicas: 1 </pre>

Parameter name	Meaning	Example
		<pre> overlays: #@ load("@ytt:overlay", "overlay") #@ load("@ytt:data", "data") #@overlay/match by=overlay.subset({"apiVersion":"apps/v1", "kind": "Deployment"}) --- spec: #@overlay/match missing_ok=True replica s: #@ data.values.replicas </pre>
<code>carvel_package_openapi3_enabled</code>	Specifies whether the Carvel Package should include a generated OpenAPIv3 specification	<pre> - name: carvel_package_openapi3_enabled value: true </pre>

More information

To read more about `lifecycle:tekton`, read [Cartographer Lifecycle](#).

package-config-writer-template (experimental)

Purpose

Persist in an external git repository the Carvel Package Kubernetes configuration passed to the template.

Used by

- [Source-to-URL-Package \(experimental\)](#) in the config-writer step.
- [Basic-Image-to-URL-Package \(experimental\)](#) in the config-writer step.

Creates

A runnable which creates a Tekton TaskRun that refers either to the Tekton Task `git-writer`.

Parameters

Parameter name	Meaning	Example
<code>serviceAccount</code>	Name of the service account which provides the credentials to the registry or repository. The service account must exist in the same namespace as the Workload.	<pre>- name: serviceAccount value: default</pre>
<code>gitops_branch</code>	Name of the branch to push the configuration to.	<pre>- name: gitops_branch value: main</pre>
<code>gitops_user_name</code>	User name to use in the commits.	<pre>- name: gitops_user_name value: "Alice Lee"</pre>
<code>gitops_user_email</code>	User email address to use in the commits.	<pre>- name: gitops_user_email value: alice@example.com</pre>
<code>gitops_commit_message</code>	Message to write as the body of the commits produced for pushing configuration to the Git repository.	<pre>- name: gitops_commit_message value: "ci bump"</pre>
<code>gitops_repository</code>	The full repository URL to which the configuration is committed. DEPRECATED	<pre>- name: gitops_repository value: "https://github.com/vmware-tanzu/cartographer"</pre>
<code>gitops_repository_prefix</code>	The prefix of the repository URL. DEPRECATED	<pre>- name: gitops_repository value: "https://github.com/vmware-tanzu/"</pre>
<code>gitops_server_address</code>	The server URL of the Git repository to which configuration is applied.	<pre>- name: gitops_server_address value: "https://github.com/"</pre>

Parameter name	Meaning	Example
<code>gitops_repository_owner</code>	The owner/organization to which the repository belongs.	<pre>- name: gitops _repository_owner value: vmware-tanzu</pre>
<code>gitops_repository_name</code>	The name of the repository.	<pre>- name: gitops _repository_name value: carto grapher</pre>
<code>registry</code>	Specification of the registry server and repository in which the configuration is placed.	<pre>- name: registry value: server: index.docker.io repository: web-team ca_certificate: -----BEGIN IN CERTIFICATE----- MIIFXzCC A0egAwIBAgIJAJYm37SF ocjlMA0GCSqGSIb3DQEB DQUAMEY... -----END CERTIFICATE-----</pre>
<code>carvel_package_gitops_subpath</code>	Specifies the subpath to which Carvel Packages should be written.	<pre>- name: carvel _package_gitops_subpath value: path/to/my/dir</pre>
<code>carvel_package_name_suffix</code>	Specifies the suffix to append to the Carvel Package name. The format is <code>WORKLOAD_NAME.WORKLOAD_NAMESPACE.carvel_package_name_suffix</code> . The full Carvel Package name must be a valid DNS subdomain name as defined in RFC 1123.	<pre>- name: carvel _package_name_suffix value: vmware.com</pre>

More information

See [Gitops vs RegistryOps](#) for more information about the operation of this template and of the [package-config-writer-and-pull-requester-template \(experimental\)](#).

package-config-writer-and-pull-requester-template (experimental)

Purpose

Persist the passed in Carvel Package Kubernetes configuration to a branch in a repository and open a pull request to another branch. (This process allows for manual review of configuration before deployment to a cluster)

Used by

- [Source-to-URL-Package \(experimental\)](#) in the config-writer step.
- [Basic-Image-to-URL-Package \(experimental\)](#) in the config-writer step.

Creates

A runnable which provides configuration to the ClusterRunTemplate `commit-and-pr-pipelinerun` to create a Tekton TaskRun. The Tekton TaskRun refers to the Tekton Task `commit-and-pr`.

Parameters

Parameter name	Meaning	Example
<code>serviceAccount</code>	Name of the service account which provides the credentials to the registry or repository. The service account must exist in the same namespace as the Workload.	<pre>- name: serviceAccount value: default</pre>
<code>gitops_commit_branch</code>	Name of the branch to which configuration is pushed.	<pre>- name: gitops_commit_branch value: feature</pre>
<code>gitops_branch</code>	Name of the branch to which a pull request is opened.	<pre>- name: gitops_branch value: main</pre>
<code>gitops_user_name</code>	User name to use in the commits.	<pre>- name: gitops_user_name value: "Alice Lee"</pre>
<code>gitops_user_email</code>	User email address to use in the commits.	<pre>- name: gitops_user_email value: alice@example.com</pre>

Parameter name	Meaning	Example
<code>gitops_commit_message</code>	Message to write as the body of the commits produced for pushing configuration to the Git repository.	<pre>- name: gitops_commit_message value: "ci bump"</pre>
<code>gitops_pull_request_title</code>	Title of the pull request to be opened.	<pre>- name: gitops_pull_request_title value: "ready for review"</pre>
<code>gitops_pull_request_body</code>	Body of the pull request to be opened.	<pre>- name: gitops_pull_request_body value: "generated by supply chain"</pre>
<code>gitops_server_address</code>	The server URL of the Git repository to which configuration is applied.	<pre>- name: gitops_server_address value: "https://github.com/"</pre>
<code>gitops_repository_owner</code>	The owner/organization to which the repository belongs.	<pre>- name: gitops_repository_owner value: vmware-tanzu</pre>
<code>gitops_repository_name</code>	The name of the repository.	<pre>- name: gitops_repository_name value: cartographer</pre>
<code>gitops_server_kind</code>	The kind of Git provider	<pre>- name: gitops_server_kind value: gitlab</pre>

Parameter name	Meaning	Example
<code>carvel_package _gitops_subpat h</code>	Specifies the subpath to which Carvel Packages should be written.	<pre>- name: carvel_package _gitops_subpat h value: path/to/my/dir</pre>
<code>carvel_package _name_suffix</code>	Specifies the suffix to append to the Carvel Package name. The format is WORKLOAD_NAME.WORKLOAD_NAMESPACE.carvel_package_name_suffix The full Carvel Package name must be a valid DNS subdomain name as defined in RFC 1123.	<pre>- name: carvel_package _name_suffix value: vmware.com</pre>

More information

See [Gitops vs RegistryOps](#) for more information about the operation of this template and of the [package-config-writer-template \(experimental\)](#).

ClusterRunTemplate reference for Supply Chain Choreographer

This topic lists the objects you can use with Supply Chain Choreographer. All the objects referenced in this topic are [Cartographer ClusterRunTemplates](#) packaged in [Out of the Box Templates](#). This topic describes the one or more objects they create, the supply chains that include them, and the parameters they use.

tekton-source-pipelinerun

Purpose

Tests source code.

Used by

- [testing-pipeline](#)

Creates

This ClusterRunTemplate creates a [Tekton PipelineRun](#) referring to the user's Tekton Pipeline.

Inputs

ClusterRunTemplate reference for Supply Chain Choreographer

Input name	Meaning	Example
<code>tekton-params</code>	Set of parameters to pass to the Tekton Pipeline	<pre> - name: source-url value: https://github.com/vmware-tanzu/cartographer.git - name: source-revision value: e4a53f49a92fc913d26f8cc23d59102a51a5e635 - name: verbose value: true - name: foo value: bar </pre>

More information

For information about the runnable created in the OOTB Testing and OOTB Testing and Scanning, see [testing-pipeline](#).

For information about the Tekton Pipeline that the user must create, see [Tekton/Pipeline](#).

tekton-taskrun

Purpose

Generic template for creating a Tekton TaskRun.

Used by

- [config-writer-template](#)

Creates

A Tekton TaskRun.

Inputs

Input name	Meaning	Example
<code>serviceAccount</code>	Service Account with permissions necessary for the Tekton Task	default
<code>taskRef</code>	Reference to the Tekton Task to which the TaskRun provides parameters	<pre> kind: ClusterTask name: git-writer </pre>
<code>params</code>	Parameters which are provided to the Tekton Task	<pre> - name: git_branch value: main - name: git_username value: "Some Name" </pre>

commit-and-pr-pipelinerun

Purpose

Commit configuration to a Git repository and open a pull request for review.

Used by

- [config-writer-and-pull-requester-template](#)

Creates

Creates a Tekton TaskRun referring to the `commit-and-pr` Tekton Task.

Inputs

Input name	Meaning	Example
<code>serviceAccount</code>	Service Account with credentials for the Git repository	default
<code>git_server_kind</code>	Type of Git provider	github
<code>git_server_address</code>	Server URL	https://github.com
<code>repository_owner</code>	Owner or Organization in which the repository resides	vmware-tanzu
<code>repository_name</code>	Name of the repository	cartographer
<code>commit_branch</code>	Name of the commit branch. Recommended value is an empty string.	""
<code>pull_request_title</code>	Title of the PR to be opened	"Update"
<code>pull_request_body</code>	Body of the PR to be opened	"Ready for review"
<code>base_branch</code>	Branch into which the PR is merged	main
<code>git_username</code>	User name associated with the commit	Waciuma Rasheed
<code>git_user_email</code>	User email associated with the commit	Sam@todd.com
<code>git_commit_message</code>	Message on commit	"App update"
<code>git_files</code>	Base64 encoded JSON file where keys equal the filename and the value is the file contents.	"eyJkZWxpdmVyeS55bWwiOiJhcGlWZXJzaW9uOiBzZXJ2aW5nLmtuYXRpdmUuZGV2L3YxXG5raW5kOiBTZXJ2aW5nLlXG4ifQ=="

`sub_path` The directory location in the repository in which to write the files.

""

More information

For information about the template creating the related runnable, see [config-writer-and-pull-requester-template](#).

For information about gitops, see [GitOps versus RegistryOps](#).

Delivery reference for Supply Chain Choreographer

This topic describes the delivery parameters and templates you can use with Supply Chain Choreographer.

Tanzu Application Platform delivery package installs a single [ClusterDelivery](#).

The delivery provides some parameters to the templates. The parameters provided by the deliverable might override some of the delivery parameters in this topic. For more information about how parameters work, including precedence rules, see the [Cartographer](#) documentation.

delivery-basic

Purpose

- Fetches Kubernetes configuration created by a supply chain.
- Deploys the configuration on the cluster.

Resources

The following resources describe the templates.

source-provider

Refers to [delivery-source-template](#).

Parameters provided:

- `serviceAccount` from tap-value `service_account`. Overridable by deliverable.

Deployer

Refers to [app-deploy](#) template.

Parameter provided:

- `serviceAccount` from tap-value `service_account`. Overridable by deliverable.

Package

Refers to [Out of the Box Delivery Basic](#).

More information

For information about setting `tap-values.yaml` at installation time, see [Install Out of the Box Delivery Basic](#).

Use Git with Supply Chain Choreographer

This topic explains how you can use Git with Supply Chain Choreographer.

Overview

The out of the box supply chains and delivery use Git in three ways:

- To fetch the developers source code, using the [template](#).
- To store complete Kubernetes configuration, the write side of GitOps, using [template 1](#), [template 2](#), [template 3 \(experimental\)](#), and [template 4 \(experimental\)](#).
- To fetch stored Kubernetes configuration, the read side of GitOps, from either the same or a different Kubernetes cluster, using the [template](#).

Supported Git Repositories

Tanzu Application Platform supports three Git providers:

- GitHub
- GitLab
- [Azure DevOps](#)

Related Articles

[Git Authentication](#) walks through the objects, such as secrets and service accounts, you can create on a cluster to allow successful supply chain Git operations. This includes the configuring a custom CA certificate.

[GitOps versus RegistryOps](#) discusses the two methods of storing built Kubernetes configuration, either in a Git repository or a container image registry, and walks through the parameters that must be provided for each.

[Configuration for Azure DevOps](#): discusses configuration necessary for working with this Git provider.

Use GitOps or RegistryOps with Supply Chain Choreographer

You can use GitOps or RegistryOps to manage your Kubernetes configuration with Supply Chain Choreographer.

Regardless of the supply chain that a workload goes through, in the end, some Kubernetes configuration is pushed to an external entity, either to a Git repository or to a container image registry.

For example:

```
Supply Chain

-- fetch source
-- test
  -- build
    -- scan
      -- apply-conventions
        -- push config      * either to Git or Registry
```

This topic dives into the specifics of that last phase of the supply chains by pushing configuration to a Git repository or a container image registry.

**Note**

For more information about providing source code either from a local directory or Git repository, see [Building from Source](#).

GitOps

The GitOps approach differs from local iteration in that GitOps configures the supply chains to push the Kubernetes configuration to a remote Git repository. This allows users to compare configuration changes and promote those changes through environments by using GitOps principles.

Typically associated with an outerloop workflow, the GitOps approach is only activated if a collection of parameters are set:

- `gitops.server_address` during the Out of the Box Supply Chains package installation or `gitops_server_address` configured as a workload parameter.
- `gitops.repository_owner` during the Out of the Box Supply Chains package installation or `gitops_repository_owner` configured as a workload parameter.
- `gitops.repository_name` during the Out of the Box Supply Chains package installation or `gitops_repository_name` configured as a workload parameter.

With all three values set, Kubernetes configuration is written to the specified repository. If a value is set at installation and the corresponding workload parameter is also set, the value of the workload parameter is respected.

In the repository, files are located in the `./config/{workload-namespace}/{workload-name}` directory. This allows multiple workloads to commit configuration to the same repository.

Examples

`tap-values.yaml`

```
gitops:
  server_address:
  repository_owner:
  repository_name:
```

`workload`

```
name: incrediApp
namespace: awesomeTeam
params:
  - name: gitops_server_address
    value: https://github.com/
  - name: gitops_repository_owner
    value: vmware-tanzu
  - name: gitops_repository_name
    value: cartographer
```

Resulting GitOps repository: <https://github.com/vmware-tanzu/cartographer>

Directory containing configuration: `./config/awesomeTeam/incrediApp`

`tap-values.yaml`:

```
gitops:
  server_address: https://github.com/
```

```
repository_owner: vmware-tanzu
repository_name: cartographer
```

workload:

```
name: superApp
namespace: awesomeTeam
```

Resulting GitOps repository: <https://github.com/vmware-tanzu/cartographer>

Directory containing configuration: `./config/awesomeTeam/superApp`

tap-values.yaml:

```
gitops:
  server_address: https://github.com/
  repository_owner: vmware-tanzu
```

workload:

```
name: superApp
namespace: awesomeTeam
params:
  - name: gitops_repository_owner
    value: buildpacks-community
  - name: gitops_repository_name
    value: kpack
```

Resulting GitOps repository: <https://github.com/buildpacks-community/kpack>

Directory containing configuration: `./config/awesomeTeam/superApp`

tap-values.yaml:

```
gitops:
  server_address:
  repository_owner:
  repository_name:
```

workload:

```
name: superApp
namespace: awesomeTeam
params:
  - name: gitops_repository_owner
    value: buildpacks-community
  - name: gitops_repository_name
    value: kpack
```

Resulting GitOps repository: Fails to resolve as some, but not all, of the three required values are provided.

Deprecated parameters

The following parameters are deprecated and no longer recommended for specifying GitOps repositories:

- `gitops.repository_prefix`: configured during the Out of the Box Supply Chains package installation.
- `gitops_repository`: configured as a workload parameter.

For example, assuming the installation of the supply chain packages through Tanzu Application Platform profiles and a `tap-values.yaml`:

```
ootb_supply_chain_basic:
  registry:
    server: REGISTRY-SERVER
    repository: REGISTRY-REPOSITORY

  gitops:
    repository_prefix: https://github.com/my-org/
```

Workloads in the cluster with the Kubernetes configuration produced throughout the supply chain are pushed to the repository whose name is formed by concatenating `gitops.repository_prefix` with the name of the workload. In this case, for example, `https://github.com/my-org/${workload.metadata.name}.git`.

```
Supply Chain
  param:
    - gitops_repository_prefix: GIT-REPO_PREFIX

workload-1:
  `git push` to GIT-REPO-PREFIX/workload-1.git

workload-2:
  `git push` to GIT-REPO-PREFIX/workload-2.git

...

workload-n:
  `git push` to GIT-REPO-PREFIX/workload-n.git
```

Alternatively, you can force a workload to publish the configuration in a Git repository by providing the `gitops_repository` parameter to the workload:

```
tanzu apps workload create tanzu-java-web-app \
  --app tanzu-java-web-app \
  --type web \
  --git-repo https://github.com/vmware-tanzu/application-accelerator-samples \
  --sub-path tanzu-java-web-app \
  --git-branch main \
  --param gitops_ssh_secret=GIT-SECRET-NAME \
  --param gitops_repository=https://github.com/my-org/config-repo
```

In this case, at the end of the supply chain, the configuration for this workload is published to the repository provided under the `gitops_repository` parameter.

If you use deprecated parameters, Kubernetes configuration is committed to the `./config` directory in the repository. This can lead to collisions if two workloads specify the same repository, or two workloads in different namespaces have the same name and the `gitops.repository_prefix` is set in `tap-values.yaml`.

If the deprecated values are set and any of the suggested GitOps values are set, the deprecated values are ignored.

Examples

`tap-values.yaml`:

```
gitops:
```

```
repository_prefix: https://github.com/vmware-tanzu
```

workload:

```
name: superApp
namespace: awesomeTeam
```

Resulting GitOps repository: <https://github.com/vmware-tanzu/incrediApp>

Directory containing configuration: `./config`

tap-values.yaml:

```
gitops:
  server_address: https://github.com/
  repository_owner: vmware-tanzu
  repository_name: cartographer
```

workload:

```
name: superApp
namespace: awesomeTeam
params:
  - name: gitops_repository
    value: https://github.com/buildpacks-community/kpack
```

Resulting GitOps repository: <https://github.com/vmware-tanzu/cartographer> The deprecated parameter `gitops_repository` is ignored.

Directory containing configuration: `./config/awesomeTeam/superApp`

tap-values.yaml:

```
gitops:
  repository_prefix: https://github.com/vmware-tanzu
```

workload:

```
name: superApp
namespace: awesomeTeam
params:
  - name: gitops_repository_owner
    value: buildpacks-community
  - name: gitops_repository_name
    value: kpack
```

Resulting GitOps repository: Fails to resolve as some, but not all, of the three GitOps values are provided. The deprecated value `repository_prefix` is ignored because suggested values are present.

Pull requests

In the standard `git-ops` approach, configuration is pushed to a repository and is immediately applied to a cluster by any deliverable watching that repository. Operators might want to manually review configuration before applying it to the cluster. To do this, operators must specify a `pull_request` commit strategy. You can use this strategy with the following Git providers:

- GitHub
- GitLab

- [Azure DevOps](#)

Authentication

The pull request approach requires HTTP(S) authentication with a token.

The pull request function is not a part of the Git specification, but most Git server providers include it. You must authenticate with those providers using a token.

In the [Kubernetes secret](#) that holds the Git credentials, the password text box must contain a token. When generating a token, ensure that it has the proper scope:

- On GitHub, the token must have a [Repo scope](#).
- On GitLab, the token must have an [API scope](#).

To use the `pull_request` commit strategy, set the following parameters:

- `commit_strategy == pull_request` configured during the Out of the Box Supply Chains package installation.
- `gitops.pull_request.server_kind` configured during the Out of the Box Supply Chains package installation or `gitops_server_kind` configured as a workload parameter. Supported values are `github`, `gitlab`, and `azure`.
- `gitops.pull_request.commit_branch` configured during the Out of the Box Supply Chains package installation or `gitops_commit_branch` configured as a workload parameter.
- `gitops.pull_request.pull_request_title` configured during the Out of the Box Supply Chains package installation or `gitops_pull_request_title` configured as a workload parameter.
- `gitops.pull_request.pull_request_body` configured during the Out of the Box Supply Chains package installation or `gitops_pull_request_body` configured as a workload parameter.

If a value is set at both installation and in a workload parameter, the workload parameter is respected.

The recommended value for `commit_branch` is an empty string. This generates a new branch for each commit based on a hash of the time when the commit is created. This prevents collisions between multiple workloads using a single Git repository.

For example, using the following Tanzu Application Platform values:

```
ootb_supply_chain_basic:
  gitops:
    server_address: https://github.com/
    repository_owner: vmware-tanzu
    repository_name: cartographer
    branch: main
    commit_strategy: pull_request
    pull_request:
      server_kind: github
      commit_branch: ""
      pull_request_title: ready for review
      pull_request_body: generated by supply chain
```

In a workload with the name `app` in the `dev` namespace, you find:

A commit to the <https://github.com/vmware-tanzu/cartographer> repository on a branch with a random name. For example, `MTYlMTYxMzEONQo=`. There is a pull request open to merge this branch into the base branch `main`.

Authentication

Regardless of how the supply chains are configured, if the repository prefix or repository name is configured to push to Git, you must provide credentials for the remote provider by using a Kubernetes secret in the same namespace as the workload attached to the workload [ServiceAccount](#).

Because the operation of pushing requires elevated permissions, credentials are required by both public and private repositories.

HTTP(S) Basic authentication or Token-based authentication

If the repository at which configuration is published uses [https://](#) or [http://](#) as the URL scheme, the Kubernetes secret must provide the credentials for that repository as follows:

```
apiVersion: v1
kind: Secret
metadata:
  name: GIT-SECRET-NAME # `git-ssh` is the default name.
                        # - operators can change such default by using the
                        #   `gitops.ssh_secret` property in `tap-values.yaml`
                        # - developers can override by using the workload parameter
                        #   named `gitops_ssh_secret`.
  annotations:
    tekton.dev/git-0: GIT-SERVER # ! required
type: kubernetes.io/basic-auth # ! required
stringData:
  username: GIT-USERNAME
  password: GIT-PASSWORD
  # ! Optional, required if the git repository is signed by a certificate authority not
  # in the system trust store
  caFile: |
    CADATA-BASE64
```

Both the Tekton annotation and the [basic-auth](#) secret type must be set. [GIT-SERVER](#) must be prefixed with the appropriate URL scheme and the Git server. For example, for [https://github.com/vmware-tanzu/cartographer](#), [https://github.com](#) must be provided as the [GIT-SERVER](#).

To use the pull request approach, the password text box must contain a token. See [Pull Requests](#).

After the [Secret](#) is created, attach it to the [ServiceAccount](#) used by the workload. For example:

```
apiVersion: v1
kind: ServiceAccount
metadata:
  name: default
secrets:
  - name: registry-credentials
  - name: tap-registry
  - name: GIT-SECRET-NAME
imagePullSecrets:
  - name: registry-credentials
  - name: tap-registry
```

For more information about the credentials and setting up the Kubernetes secret, see [Git Authentication's HTTP section](#).

SSH

If the repository to which configuration is published uses [https://](#) or [http://](#) as the URL scheme, the Kubernetes secret must provide the credentials for that repository as follows:

```

apiVersion: v1
kind: Secret
metadata:
  name: GIT-SECRET-NAME # `git-ssh` is the default name.
                        # - operators can change such default through the
                        #   `gitops.ssh_secret` property in `tap-values.yaml`
                        # - developers can override by using the workload parameter
                        #   named `gitops_ssh_secret`.
  annotations:
    tekton.dev/git-0: GIT-SERVER
type: kubernetes.io/ssh-auth
stringData:
  ssh-privatekey: SSH-PRIVATE-KEY # private key with push-permissions
  identity: SSH-PRIVATE-KEY # private key with pull permissions
  identity.pub: SSH-PUBLIC-KEY # public of the `identity` private key
  known_hosts: GIT-SERVER-PUBLIC-KEYS # git server public keys

```

After the `Secret` is created, attach it to the `ServiceAccount` used by the workload. For example:

```

apiVersion: v1
kind: ServiceAccount
metadata:
  name: default
secrets:
  - name: registry-credentials
  - name: tap-registry
  - name: GIT-SECRET-NAME
imagePullSecrets:
  - name: registry-credentials
  - name: tap-registry

```



Note

If you've used Namespace Provisioner to set up your Developer Namespace where you workload is created, use the `namespace_provisioner.default_parameters.supply_chain_service_account.secrets` property in your `tap-values.yaml`. For example:

```

namespace_provisioner:
  default_parameters:
    supply_chain_service_account:
      secrets:
        - GIT-SECRET-NAME

```

Namespace Provisioner manages the service account and manual edits to it do not persist.

For information about the credentials and setting up the Kubernetes secret, see [Git Authentication's SSH section](#).

GitOps workload parameters

While installing `ootb-*`, operators can configure `gitops.repository_prefix` to indicate what prefix the supply chain must use when forming the name of the repository to push to the Kubernetes configurations produced by the supply chains.

To change the behavior to use GitOps, set the source of the source code to a Git repository. As the supply chain progresses, configuration is pushed to a repository named

```
$(gitops.repository_prefix) + $(workload.name).
```

For example, configure `gitops.repository_prefix` to `git@github.com/foo/` and create a workload as follows:

```
tanzu apps workload create tanzu-java-web-app \
--git-branch main \
--git-repo https://github.com/vmware-tanzu/application-accelerator-samples \
--sub-path tanzu-java-web-app \
--label app.kubernetes.io/part-of=tanzu-java-web-app \
--type web
```

Expect to see the following output:

```
Create workload:
 1 + |---
 2 + |apiVersion: carto.run/v1alpha1
 3 + |kind: Workload
 4 + |metadata:
 5 + |  labels:
 6 + |    apps.tanzu.vmware.com/workload-type: web
 7 + |    app.kubernetes.io/part-of: tanzu-java-web-app
 8 + |  name: tanzu-java-web-app
 9 + |  namespace: default
10 + |spec:
11 + |  source:
12 + |    git:
13 + |      ref:
14 + |        branch: main
15 + |      url: https://github.com/vmware-tanzu/application-accelerator-samples
16 + |      subPath: tanzu-java-web-app
```

As a result, the Kubernetes configuration is pushed to `git@github.com/foo/tanzu-java-web-app.git`.

Regardless of the setup, developers can also manually override the repository where configuration is pushed to by tweaking the following parameters:

- `gitops_ssh_secret`: Name of the secret in the same namespace as the workload where SSH credentials exist for pushing the configuration produced by the supply chain to a Git repository. Example: `ssh-secret`
- `gitops_repository`: SSH URL of the Git repository to push the Kubernetes configuration produced by the supply chain to. Example: `ssh://git@foo.com/staging.git`
- `gitops_branch`: Name of the branch to push the configuration to. Example: `main`
- `gitops_commit_message`: Message to write as the body of the commits produced for pushing configuration to the Git repository. Example: `ci bump`
- `gitops_user_name`: User name to use in the commits. Example: `Alice Lee`
- `gitops_user_email`: User email address to use in the commits. Example: `alice@example.com`

Read more on Git

See [Git Reference](#)

RegistryOps

RegistryOps is typically used for inner loop flows where configuration is treated as an artifact from quick iterations by developers. In this scenario, at the end of the supply chain, configuration is pushed to a container image registry in the form of an [imgpkg bundle](#). You can think of it as a container image whose sole purpose is to carry arbitrary files.

To enable this mode of operation, the supply chains must be configured **without** the following parameters being configured during the installation of the `ootb-` packages or overwritten by the workload by using the following parameters:

- `gitops_repository_prefix`
- `gitops_repository`

If none of the parameters are set, the configuration is pushed to the same container image registry as the application image. That is, to the registry configured under the `registry: {}` section of the `ootb-` values.

For example, assuming the installation of Tanzu Application Platform by using profiles, configure the `ootb-supply-chain*` package as follows:

```
ootb_supply_chain_basic:
  registry:
    server: REGISTRY-SERVER
    repository: REGISTRY_REPOSITORY
```

The Kubernetes configuration produced by the supply chain is pushed to an image named after `REGISTRY-SERVER/REGISTRY-REPOSITORY` including the workload name.

In this scenario, no extra credentials must be set up, because the secret containing the credentials for the container image registry were already configured during the setup of the workload namespace.

Overview of Supply Chain Security Tools for VMware Tanzu - Policy Controller

Supply Chain Security Tools - Policy Controller is a security tool that helps you ensure that the container images in their registry have not been tampered with. Policy Controller is a Kubernetes Admission Controller that allows you to apply policies to verify signatures on container images before being admitted to a cluster.

The Policy Controller:

- Verifies signatures on container images used by Kubernetes resources
- Enforces policies to allow or deny images being admitted a cluster
- Allows operators to define multiple policies in the cluster
- Allows operators to select which `namespaces` to enforce policies against
- Supports `cosign` signatures and keyless signing
- Supports storing public keys in a KMS

It enforces its policies against all resources that create `Pods` as part of their life cycle:

- `Pod`
- `ReplicaSet`
- `Deployment`
- `Job`
- `StatefulSet`
- `DaemonSet`
- `CronJob`

**Note**

This component is the successor to [Supply Chain Security Tools - Sign](#), which is deprecated. Support and maintenance for [Supply Chain Security Tools - Sign](#) continues. Monitor Release Notes for updates.

Supply Chain Security Tools - Policy Controller is based on Sigstore's Policy Controller and is compatible only with `cosign` signatures. See [Cosign](#) and [Policy Controller](#) in GitHub. For information about image signing and verification, see [Sigstore](#) open source community and the `cosign` project in GitHub.

The Policy Controller component is a policy enforcement tool only. It does not sign images. Operators can configure image signing for their containers in several ways, including:

- By using [Tanzu Build Service](#)
- By using `kpack`
- By integrating `cosign` into their build pipelines

Image signatures generated by `cosign` are stored in the same registry location as the image itself unless configured with the `COSIGN_REPOSITORY` environment variable. Policy Controller uses registry credentials provided in the admission request, Service Account, or `signaturePullSecrets` defined in the policy to connect to the registry to verify a signature.

**Important**

This component does not work with insecure registries.

To install Supply Chain Security Tools - Policy Controller, see [Install Supply Chain Security Tools - Policy Controller](#).

Overview of Supply Chain Security Tools for VMware Tanzu - Policy Controller

Supply Chain Security Tools - Policy Controller is a security tool that helps you ensure that the container images in their registry have not been tampered with. Policy Controller is a Kubernetes Admission Controller that allows you to apply policies to verify signatures on container images before being admitted to a cluster.

The Policy Controller:

- Verifies signatures on container images used by Kubernetes resources
- Enforces policies to allow or deny images being admitted a cluster
- Allows operators to define multiple policies in the cluster
- Allows operators to select which `namespaces` to enforce policies against
- Supports `cosign` signatures and keyless signing
- Supports storing public keys in a KMS

It enforces its policies against all resources that create `Pods` as part of their life cycle:

- `Pod`
- `ReplicaSet`
- `Deployment`

- [Job](#)
- [StatefulSet](#)
- [DaemonSet](#)
- [CronJob](#)



Note

This component is the successor to [Supply Chain Security Tools - Sign](#), which is deprecated. Support and maintenance for [Supply Chain Security Tools - Sign](#) continues. Monitor Release Notes for updates.

Supply Chain Security Tools - Policy Controller is based on Sigstore's Policy Controller and is compatible only with `cosign` signatures. See [Cosign](#) and [Policy Controller](#) in GitHub. For information about image signing and verification, see [Sigstore](#) open source community and the `cosign` project in GitHub.

The Policy Controller component is a policy enforcement tool only. It does not sign images. Operators can configure image signing for their containers in several ways, including:

- By using [Tanzu Build Service](#)
- By using `kpack`
- By integrating `cosign` into their build pipelines

Image signatures generated by `cosign` are stored in the same registry location as the image itself unless configured with the `COSIGN_REPOSITORY` environment variable. Policy Controller uses registry credentials provided in the admission request, Service Account, or `signaturePullSecrets` defined in the policy to connect to the registry to verify a signature.



Important

This component does not work with insecure registries.

To install Supply Chain Security Tools - Policy Controller, see [Install Supply Chain Security Tools - Policy Controller](#).

Install Supply Chain Security Tools - Policy Controller

You install Supply Chain Security Tools (SCST) - Policy Controller as part of the Tanzu Application Platform Full, Iterate, and Run profiles. You can use the instructions in this topic to manually install SCST - Policy Controller.



Note

Follow the steps in this topic if you do not want to use a profile to install SCST - Policy Controller. For more information about profiles, see [Components and installation profiles](#).

Prerequisites

- Complete all prerequisites to install Tanzu Application Platform. For more information, see [Prerequisites](#).

- A container image registry that supports TLS connections.



Important

This component does not work with not secure registries.

- For keyless authorities support, you must set `policy.tuf_enabled: true`. By default, the public official Sigstore The Update Framework (TUF) server is used. To target an alternative Sigstore stack, specify `policy.tuf_mirror` and `policy.tuf_root`.
- If you are installing in an air-gapped environment and require keyless authorities, you must deploy a Sigstore Stack on the cluster or be accessible from the air-gapped environment.
- During configuration, you provide a cosign public key to validate signed images. The Policy Controller only supports ECDSA public keys. An example cosign public key is provided that can validate an image from the public cosign registry. To provide your own key and images, follow the [Cosign Quick Start Guide](#) in GitHub.



Caution

This component rejects `Pods` if they are not correctly configured. Test your configuration in a test environment before applying policies to your production cluster.

Install

To install SCST - Policy Controller:

1. List version information for the package by running:

```
tanzu package available list policy.apps.tanzu.vmware.com --namespace tap-install
```

For example:

```
$ tanzu package available list policy.apps.tanzu.vmware.com --namespace tap-install
- Retrieving package versions for policy.apps.tanzu.vmware.com...
NAME                                VERSION    RELEASED-AT
policy.apps.tanzu.vmware.com        1.2.0     2023-10-01 20:00:00 -0400 EDT
```

2. (Optional) Make changes to the default installation settings by running:

```
tanzu package available get policy.apps.tanzu.vmware.com/VERSION --values-schema --namespace tap-install
```

Where `VERSION` is the version number you discovered. For example, `1.2.0`.

For example:

```
$ tanzu package available get policy.apps.tanzu.vmware.com/1.2.0 --values-schema --namespace tap-install
| Retrieving package details for policy.apps.tanzu.vmware.com/1.2.0...

KEY                                DEFAULT    TYPE    DESCRIPTION
custom_ca                          <nil>     array   List of custom CA contents that should be included in the application container for registry communication.
                                         An array of items containing
```



```

a ca_content field with the PEM-encoded contents of a certificate authority.
deployment_namespace    cosign-system string    Deployment namespace specifies the namespace where this component should be deployed to.
                                                                    If not specified, "cosign-system" is assumed.
fail_on_empty_authorities true                boolean   Configure if a ClusterImagePolicy will fail or allow empty authorities
limits_cpu               200m              string    The CPU limit defines a hard ceiling on how much CPU time
                                                                    that the Policy Controller manager container can use.
                                                                    https://kubernetes.io/docs/concepts/configuration/manage-resources-containers/#meaning-of-cpu
no_match_policy          deny               string    The action when no policy matches the admitting image digest. Valid values are "warn", "allow", or "deny".
quota.pod_number        6                 string    The maximum number of Policy Controller Pods allowed to be created with the priority class
                                                                    system-cluster-critical. This value must be enclosed in quotes (""). If this value is not specified then a default value of 6 is used.
replicas                 1                 integer   The number of replicas to be created for the Policy Controller. This value must not be enclosed in quotes. If this value is not specified then a default value of 1 is used.
requests_memory          20Mi              string    The memory request defines the minimum memory amount for the Policy Controller manager.
                                                                    https://kubernetes.io/docs/concepts/configuration/manage-resources-containers/#meaning-of-memory
tuf_root                 string             string    The root.json file content of the TUF mirror
custom_ca_secrets        <nil>             array     List of custom CA secrets that should be included in the application container for registry communication.
                                                                    An array of secret references each containing a secret_name field with the secret name to be referenced and a namespace field with the name of the namespace where the referred secret resides.
limits_memory            200Mi             string    The memory limit defines a hard ceiling on how much memory
                                                                    that the Policy Controller manager container can use.
                                                                    https://kubernetes.io/docs/concepts/configuration/manage-resources-containers/#meaning-of-memory
requests_cpu             20m               string    The CPU request defines the minimum CPU time for the Policy Controller manager. During CPU contention, CPU request is used as a weighting where higher CPU requests are allocated more CPU time.
                                                                    https://kubernetes.io/docs/concepts/configuration/manage-resources-containers/#meaning-of-cpu
tuf_mirror               string             string    TUF mirror address

```

3. Create a file named `scst-policy-values.yaml` and add the settings you want to customize:

- `custom_ca_secrets:`

If your container registries are secured by self-signed certificates, this setting controls which secrets are added to the application container as custom certificate authorities (CAs). `custom_ca_secrets` consists of an array of items. Each item contains two text boxes: the `secret_name` text box defines the name of the secret,

and the `namespace` text box defines the name of the namespace where said secret is stored.

For example:

```
custom_ca_secrets:
- secret_name: first-ca
  namespace: ca-namespace
- secret_name: second-ca
  namespace: ca-namespace
```



Note

This setting is allowed even if `custom_cas` is defined.

- `custom_cas`:

This setting enables adding certificate content in PEM format. The certificate content is added to the application container as custom certificate authorities (CAs) to communicate with registries deployed with self-signed certificates. `custom_cas` consists of an array of items.

Each item contains a single text box named `ca_content`. The value of this text box must be a PEM-formatted certificate authority. The certificate content must be defined as a YAML block, preceded by the literal indicator (`|`) to preserve line breaks and ensure that the certificates are interpreted correctly.

For example:

```
custom_cas:
- ca_content: |
  ----- BEGIN CERTIFICATE -----
  first certificate content here...
  ----- END CERTIFICATE -----
- ca_content: |
  ----- BEGIN CERTIFICATE -----
  second certificate content here...
  ----- END CERTIFICATE -----
```



Note

This setting is allowed even if `custom_ca_secrets` is defined.

- `deployment_namespace`:

This setting controls the namespace to which this component is deployed. When not specified, the namespace `cosign-system` is assumed. This component creates the specified namespace to deploy required resources. Select a namespace that is not used by any other components.

- `limits_cpu`:

This setting controls the maximum CPU resource allocated to the Policy admission controller. The default value is “200m”. See [Kubernetes documentation](#).

- `limits_memory`:

This setting controls the maximum memory resource allocated to the Policy admission controller. The default value is “200Mi”. See [Kubernetes documentation](#).

- `quota.pod_number:`

This setting controls the maximum number of pods that are allowed in the deployment namespace with the `system-cluster-critical` priority class. This priority class is added to the pods to prevent preemption of this component's pods in case of node pressure.

The default value for this text box is `6`. If your use requires more than 6 pods, change this value to allow the number of replicas you intend to deploy.



Note

VMware recommends to run this component with a critical priority level to prevent the cluster from rejecting all admission requests if the component's pods are evicted due to resource limits.

- `replicas:`

This setting controls the default amount of replicas deployed by this component. The default value is `1`.

For production environments: VMware recommends you increase the number of replicas to `3` to ensure that the availability of the component and better admission performance.

- `requests_cpu:`

This setting controls the minimum CPU resource allocated to the Policy admission controller. During CPU contention, this value is used as a weighting where higher values indicate more CPU time is allocated. The default value is `20m`. See [CPU resource units](#) in the Kubernetes documentation.

- `requests_memory:`

This setting controls the minimum memory resource allocated to the Policy admission controller. The default value is `20Mi`. See [Memory resource units](#) in the Kubernetes documentation.

- `tuf_enabled:`

This setting defines whether the TUF initialization is done on startup. It is required for keyless verification support. The default value is `false`, which means that keyless authorities of `ClusterImagePolicy` are not supported. Also, policy-controller does not have an external dependency on setup.

- `tuf_root:`

The `root.json` file content of the TUF mirror.

- `tuf_mirror:`

This setting defines the TUF mirror address which is used for doing the initialization.

- `no_match_policy:`

The action when no policy matches the admitting image digest. Valid values are `"warn"`, `"allow"`, or `"deny"`. Default value is `"deny"`

- `fail_on_empty_authorities:`

Failing or allowing empty authorities when adding a new `ClusterImagePolicy`. Default value is `true`.

4. Install the package:

```
tanzu package install policy-controller \
--package policy.apps.tanzu.vmware.com \
--version VERSION \
--namespace tap-install \
--values-file scst-policy-values.yaml
```

Where `VERSION` is the version number you discovered earlier. For example, `1.2.0`.

For example:

```
$ tanzu package install policy-controller \
--package policy.apps.tanzu.vmware.com \
--version 1.2.0 \
--namespace tap-install \
--values-file scst-policy-values.yaml

Installing package 'policy.apps.tanzu.vmware.com'
Getting package metadata for 'policy.apps.tanzu.vmware.com'
Creating service account 'policy-controller-tap-install-sa'
Creating cluster admin role 'policy-controller-tap-install-cluster-role'
Creating cluster role binding 'policy-controller-tap-install-cluster-rolebinding'
Creating package resource
Waiting for 'PackageInstall' reconciliation for 'policy-controller'
'PackageInstall' resource install status: Reconciling
'PackageInstall' resource install status: ReconcileSucceeded
'PackageInstall' resource successfully reconciled

Added installed package 'policy-controller'
```

After you run the commands earlier the policy controller is running.

Policy Controller is now installed, but it does not enforce any policies by default. Policies must be explicitly configured on the cluster. To configure signature verification policies, see [Configuring Supply Chain Security Tools - Policy](#).

Migration From Supply Chain Security Tools - Sign

This topic explains how you can migrate from Supply Chain Security Tools - Sign to Supply Chain Security Tools - Policy.

In Tanzu Application Platform v1.4, the Image Policy Webhook is removed. If the Image Policy Webhook was used with the previous Tanzu Application Platform versions in your cluster, you must migrate the `ClusterImagePolicy` resource from Image Policy Webhook to Policy Controller. For information about additional features introduced in SCST - Policy, see [Configuring Supply Chain Security Tools - Policy](#).

Enable Policy Controller on Namespaces

Policy Controller works with an opt-in system. Operators must update namespaces with the label `policy.sigstore.dev/include: "true"` to the namespace resource to enable Policy Controller verification.

```
kubectl label namespace my-secure-namespace policy.sigstore.dev/include=true
```



Caution

Without a Policy Controller `ClusterImagePolicy` applied, there are fallback behaviors where images are validated against the public Sigstore Rekor and Fulcio servers by

using a keyless authority flow. Therefore, if the deploying image is signed publicly by a third-party using the keyless authority flow, the image are admitted as it can validate against the public Rekor and Fulcio. To avoid this behavior, develop, and apply a `ClusterImagePolicy` that applies to the images being deployed in the namespace.

Policy Controller ClusterImagePolicy

The Policy Controller `ClusterImagePolicy` does not have a name. Image Policy Controller required that the `ClusterImagePolicy` be named `image-policy` and that there be only one `ClusterImagePolicy`. Multiple Policy Controller `ClusterImagePolicies` are applied. During validation, all `ClusterImagePolicy` that have an image `glob` pattern that matches the deploying image is evaluated. All matched `ClusterImagePolicies` must be valid. For a `ClusterImagePolicy` to be valid, at least one authority in the policy must validate the signature of the deploying image.

Excluding Namespaces

The namespaces listed in `spec.verification.exclude.resources.namespaces[]` must have `policy.sigstore.dev/include` set to `false` or not be set. Therefore, they are exempted from Policy Controller validation.

Image Policy Webhook:

```
---
apiVersion: signing.apps.tanzu.vmware.com/v1beta1
kind: ClusterImagePolicy
metadata:
  name: image-policy
spec:
  verification:
    ...

  exclude:
    resources:
      namespaces:
      - image-policy-system
      - kube-system
      - cert-manager
    ...
```

Specifying Public Keys

`spec.verification.keys[].publicKey` from Image Policy Webhook is mapped to `spec.authorities[].key.data` for Policy Controller.

The `name` associated with each `key` is no longer required. Image Policy Webhook has direct association between `key` name and `imagePattern`. For Policy Controller, multiple `ClusterImagePolicy` resources are defined to create direct association between image patterns and key authorities.

Image patterns and keys are scoped to each `ClusterImagePolicy` resource.

Therefore, to have direct association be isolated between `key` and `imagePattern`, multiple Policy Controller `ClusterImagePolicy` must be created. Each `ClusterImagePolicy` has the image `glob` pattern defined and the associated key authorities defined.

Image Policy Webhook:

```

---
apiVersion: signing.apps.tanzu.vmware.com/v1beta1
kind: ClusterImagePolicy
metadata:
  name: image-policy
spec:
  verification:
    ...

  keys:
  - name: official-cosign-key
    publicKey: |
      -----BEGIN PUBLIC KEY-----
      MFkwEwYHKoZIzj0CAQYIKoZIzj0DAQcDQgAEhyQCx0E9wQWSFI9ULGwy3BuRklnt
      IqozONbdblqz11hlRJy9c7SG+hdcF19jE9uE/dwtuwU2MqU9T/cN0YkWww==
      -----END PUBLIC KEY-----

    ...

```

Policy Controller:

```

---
apiVersion: policy.sigstore.dev/v1beta1
kind: ClusterImagePolicy
metadata:
  name: POLICY-NAME
spec:
  authorities:
    ...

  - key:
    data: |
      -----BEGIN PUBLIC KEY-----
      MFkwEwYHKoZIzj0CAQYIKoZIzj0DAQcDQgAEhyQCx0E9wQWSFI9ULGwy3BuRklnt
      IqozONbdblqz11hlRJy9c7SG+hdcF19jE9uE/dwtuwU2MqU9T/cN0YkWww==
      -----END PUBLIC KEY-----

    ...

```

Where `POLICY-NAME` is the name of the cluster image policy you want to use.

Specifying Image Matching

`spec.verification.images[].namePattern` from Image Policy Webhook maps to `spec.images[].glob` for Policy Controller.

Policy Controller follows more closely to `glob` matching. For the Image Policy Webhook, `registry.com/*` wildcards all projects and images under the registry. However, `glob` matching uses `/` separator delimiting. Therefore, the `glob` wildcard matching equivalent is `registry.com/**/*`. The `**` allows for recursive project path matching while the trailing `*` images found in the terminating project path.

If only one level of pathing is required, the `glob` pattern is `registry.com/*/*`.

Policy Controller has defaults defined. If `*` is specified, the `glob` matching behavior is `index.docker.io/library/*`. If `*/*` is specified, the `glob` matching behavior is `index.docker.io/*/*`. With these defaults, the `glob` pattern `**` matches against all images.

Image Policy Webhook:

```

---
apiVersion: signing.apps.tanzu.vmware.com/v1beta1
kind: ClusterImagePolicy

```

```

metadata:
  name: image-policy
spec:
  verification:
    ...

  images:
  - namePattern: gcr.io/projectsigstore/cosign*
    keys:
    - name: official-cosign-key
    secretRef:
      name: your-secret
      namespace: your-namespace

  ...

```

Policy Controller:

```

---
apiVersion: policy.sigstore.dev/v1beta1
kind: ClusterImagePolicy
metadata:
  name: POLICY-NAME
spec:
  images:
  - glob: gcr.io/projectsigstore/cosign*

```

Where `POLICY-NAME` is the name of the cluster image policy you want to use.

Specifying policy mode

If `AllowUnmatchedImages` is set to `true` in the Image Policy Webhook deployment, create the following policy in the cluster:

```

---
apiVersion: policy.sigstore.dev/v1beta1
kind: ClusterImagePolicy
metadata:
  name: allow-unmatched-image-policy
spec:
  images:
  - glob: "*"
    authorities:
    - static:
        action: pass

```

Configuring Supply Chain Security Tools - Policy

This topic describes how you can configure Supply Chain Security Tools (SCST) - Policy. SCST - Policy requires extra configuration steps to verify your container images.

Admission of Images

An image is admitted after it is validated against a policy with matching image pattern, and where at least one valid signature is obtained from the authorities provided in a matched [ClusterImagePolicy](#).

If more than one policy exists with a matching image pattern, *ALL* of the policies must have at least one passing authority for the image.

Including Namespaces

The Policy Controller only validates resources in namespaces that have chosen to opt-in. This is done by adding the label `policy.sigstore.dev/include: "true"` to the namespace resource.

```
kubectl label namespace my-secure-namespace policy.sigstore.dev/include=true
```



Caution

Without a Policy Controller ClusterImagePolicy applied, there are fallback behaviors where images are validated against the public Sigstore Rekor and Fulcio servers by using a keyless authority flow. Therefore, if the deploying image is signed publicly by a third-party using the keyless authority flow, the image is admitted as it can validate against the public Rekor and Fulcio. To avoid this behavior, develop, and apply a ClusterImagePolicy that applies to the images being deployed in the namespace.

Create a ClusterImagePolicy resource

The cluster image policy is a custom resource containing the following properties:

images

In a ClusterImagePolicy, `spec.images` specifies a list of glob matching patterns. These patterns are matched against the image digest in `PodSpec` for resources attempting deployment.

Policy Controller defines the following globs by default:

- If `*` is specified, the `glob` matching behavior is `index.docker.io/library/*`.
- If `*/*` is specified, the `glob` matching behavior is `index.docker.io/*/*`.

With these defaults, you require the `glob` pattern `**` to match against all images. If your image is hosted on Docker Hub, include `index.docker.io` as the host for the `glob`.

A sample ClusterImagePolicy which matches against all images using `glob`:

```
apiVersion: policy.sigstore.dev/v1beta1
kind: ClusterImagePolicy
metadata:
  name: image-policy
spec:
  images:
  - glob: "**"
```

mode

In a ClusterImagePolicy, `spec.mode` specifies the action of a policy:

- `enforce`: The default behavior. If the policy fails to validate the image, the policy fails.
- `warn`: If the policy fails to validate the image, validation error messages are converted to warnings and the policy passes.

A sample of a ClusterImagePolicy which has `warn` mode configured.

```
---
apiVersion: policy.sigstore.dev/v1beta1
kind: ClusterImagePolicy
```



```

metadata:
  name: POLICY-NAME
spec:
  mode: warn

```

Where `POLICY-NAME` is the name of the policy you want to configure your ClusterImagePolicy with.

When `enforce` mode is set, an image that fails validation is not admitted.

Sample output message:

```

error: failed to patch: admission webhook "policy.sigstore.dev" denied the request: va
l idation failed: failed policy: POLICY-NAME: spec.template.spec.containers[0].image
IMAGE-REFERENCE signature key validation failed for authority authority-0 for IMAGE-RE
FERENCE: GET IMAGE-SIGNATURE-REFERENCE: DENIED: denied; denied
failed policy: POLICY-NAME: spec.template.spec.containers[1].image
IMAGE-REFERENCE signature key validation failed for authority authority-0 for IMAGE-RE
FERENCE: GET IMAGE-SIGNATURE-REFERENCE: DENIED: denied; denied

```

When `warn` mode is set, an image that fails validation is admitted.

Sample output message:

```

Warning: failed policy: POLICY-NAME: spec.template.spec.containers[0].image
Warning: IMAGE-REFERENCE signature key validation failed for authority authority-0 for
IMAGE-REFERENCE: GET IMAGE-SIGNATURE-REFERENCE: DENIED: denied; denied
Warning: failed policy: POLICY-NAME: spec.template.spec.containers[1].image
Warning: IMAGE-REFERENCE signature key validation failed for authority authority-0 for
IMAGE-REFERENCE: GET IMAGE-SIGNATURE-REFERENCE: DENIED: denied; denied

```

If you don't want a `Warning` output message, you can configure a `static.action pass` authority to allow expected unsigned images. For example, you may want to allow unsigned images if your policy controller runs on a development environment, and you need to iterate quickly. For information about static action authorities, see [Static Action](#).

match

You can use `match` to filter resources using group, version, kind, or labels in a selected namespace to enforce the defined policy. If the list of matching resources is empty, all core resources are used by default.

For example, you can filter all `v1 cronjobs` with the label `app: tap` in a namespace that is labeled for policy enforcement:

```

spec:
  match:
    - group: batch
      resource: cronjobs
      version: v1
      selector:
        matchLabels:
          app: tap

```

authorities

Authorities listed in the `authorities` block of the ClusterImagePolicy are `key` or `keyless` specifications.

key

Each `key` authority can contain a PEM-encoded ECDSA public key, a `secretRef`, or a `kms` path.

The policy resyncs with KMS referenced every 10 hours. Any updates to the secret in KMS is pulled in during the refresh. To force a resync, the policy must be deleted and recreated.



Important

Only ECDSA public keys are supported.

```
spec:
  authorities:
    - key:
      data: |
        -----BEGIN PUBLIC KEY-----
        ...
        -----END PUBLIC KEY-----
    - key:
      secretRef:
        name: secretName
    - key:
      kms: KMSPATH
```

Where `KMSPATH` is the name of the KMS path you want to configure in your key authority.



Note

The secret referenced in `key.secretRef.name` must be created in the `cosign-system` namespace or the namespace where the Policy Controller is installed. This secret must only contain one `data` entry with the public key.

keyless



Note

Keyless support is deactivated by default. See [Install Supply Chain Security Tools - Policy Controller](#).

Each keyless authority can contain a Fulcio URL, a Rekor URL, a certificate, or an array of identities.

Identities are represented with a combination of `issuer` or `issuerRegExp` with `subject` or `subjectRegExp`.

- `issuer`: Defines the issuer for this identity.
- `issuerRegExp`: Specifies a regular expression to match the issuer for this identity.
- `subject`: Defines the subject for this identity.
- `subjectRegExp`: Specifies a regular expression to match the subject for this identity.

An example of keyless authority structure:

```
spec:
  authorities:
    - keyless:
      url: https://fulcio.example.com
      ca-cert:
        data: Certificate Data
      identities:
        - issuer: https://accounts.google.com
```

```

      subjectRegExp: .*@example.com
    - issuer: https://token.actions.githubusercontent.com
      subject: https://github.com/mycompany/*/.github/workflows/*@*
  ctlog:
    url: https://rekor.example.com
  - keyless:
    url: https://fulcio.example.com
    ca-cert:
      secretRef:
        name: secretName
    identities:
      - issuerRegExp: .*kubernetes.default.*
        subjectRegExp: .*kubernetes.io/namespaces/default/serviceaccounts/default

```

The authorities are evaluated using the `any of` operator to admit container images. For each pod, the Policy Controller iterates over the list of containers and init containers. For every policy that matches against the images, they must each have at least one valid signature obtained using the authorities specified. If an image does not match any policy, the Policy Controller does not admit the image.

`static.action`

ClusterImagePolicy authorities are configured to always `pass` or `fail` with `static.action`.

Sample `ClusterImagePolicy` with static action `fail`.

```

apiVersion: policy.sigstore.dev/v1beta1
kind: ClusterImagePolicy
metadata:
  name: POLICY-NAME
spec:
  authorities:
  - static:
    action: fail

```

Where `POLICY-NAME` is the name of the policy you want to configure your ClusterImagePolicy with.

A sample output of static action `fail`:

```

error: failed to patch: admission webhook "policy.sigstore.dev" denied the request: va
l idation failed: failed policy: POLICY-NAME: spec.template.spec.containers[0].image
IMAGE-REFERENCE disallowed by static policy
failed policy: POLICY-NAME: spec.template.spec.containers[1].image
IMAGE-REFERENCE disallowed by static policy

```

Images that are unsigned in a namespace with validation enabled are admitted with an authority with static action `pass`.

This applies when you are configuring a policy with `static.action pass` for `tap-packages` images. Another policy is then configured to validate signed images produced by Tanzu Build Service. This allows images from `tap-packages`, which are unsigned and required by the platform, to be admitted while still validating signed built images from Tanzu Build Service. See [Configure your supply chain to sign and verify your image builds](#).

If `Warning` messages are desirable for admitted images where validation failed, you can configure a policy with `warn` mode and valid authorities. For information about ClusterImagePolicy modes, see [Mode](#).

Provide credentials for the package

There are three ways the package reads credentials to authenticate to registries protected by authentication:

1. Reading `imagePullSecrets` directly from the resource being admitted. See [Container image pull secrets](#) in the Kubernetes documentation.
2. Reading `imagePullSecrets` from the service account the resource is running as. See [Arranging for imagePullSecrets to be automatically attached](#) in the Kubernetes documentation.
3. Reading a `secretRef` from the `ClusterImagePolicy` resource's `signaturePullSecrets` when specifying the cosign signature source.

Authentication can fail for the following scenarios:

- A not valid credential is specified in the `imagePullSecrets` of the resource or in the service account the resource runs as.
- A not valid credential is specified in the `ClusterImagePolicy signaturePullSecrets` text box.

Provide secrets for authentication in your policy

You can provide secrets for authentication as part of the policy configuration. The `oci` location is the image location or a remote location where signatures are configured to be stored during signing. The `signaturePullSecrets` is available in the `cosign-system` namespace or the namespace where the Policy Controller is installed.

By default, `imagePullSecrets` from the resource or service account is used while the default `oci` location is the image location.

See the following example:

```
spec:
  authorities:
    - key:
        data: |
          -----BEGIN PUBLIC KEY-----
          ...
          -----END PUBLIC KEY-----
        source:
          - oci: registry.example.com/project/signature-location
            signaturePullSecrets:
              - name: MY-SECRET
    - keyless:
        url: https://fulcio.example.com
        source:
          - oci: registry.example.com/project/signature-location
            signaturePullSecrets:
              - name: MY-SECRET
```

Where `MY-SECRET` is the name of the secret you want to use with your credentials.

VMware recommends using a set of credentials with the least amount of privilege that allows reading the signature stored in your registry.

Verify your configuration

A sample policy:

```
apiVersion: policy.sigstore.dev/v1beta1
kind: ClusterImagePolicy
metadata:
```

```

name: image-policy
spec:
  images:
  - glob: "gcr.io/projectsigstore/cosign*"
  authorities:
  - name: official-cosign-key
    key:
      data: |
        -----BEGIN PUBLIC KEY-----
        MFkwEwYHkoZIZj0CAQYIKoZIZj0DAQcDQgAEhyQCx0E9wQWSFI9ULGwy3BuRklnt
        IqozONbbdbqz11hlRJy9c7SG+hdcF19jE9uE/dwtuwU2MqU9T/cN0YkWww==
        -----END PUBLIC KEY-----

```

When using the sample policy, run these commands to verify your configuration:

1. Verify that the Policy Controller admits the signed image that validates with the configured public key. Run:

```

kubectl run cosign \
  --image=gcr.io/projectsigstore/cosign:v1.2.1 \
  --dry-run=server

```

For example:

```

$ kubectl run cosign \
  --image=gcr.io/projectsigstore/cosign:v1.2.1 \
  --dry-run=server
pod/cosign created (server dry run)

```

2. Verify that the Policy Controller rejects the unmatched image. Run:

```

kubectl run busybox --image=busybox --dry-run=server

```

For example:

```

$ kubectl run busybox --image=busybox --dry-run=server
Error from server (BadRequest): admission webhook "policy.sigstore.dev" denied the request: validation failed: no matching policies: spec.containers[0].image
index.docker.io/library/busybox@sha256:3614ca5eacf0a3a1bcc361c939202a974b4902b9334ff36eb29ffe9011aad83

```

In the output, it did not specify which authorities were used as there was no policy found that matched the image. Therefore, the image fails to validate for a signature and fails to deploy.

3. Verify that the Policy Controller rejects a matched image signed with a different key than the one configured. Run:

```

kubectl run cosign-fail \
  --image=gcr.io/projectsigstore/cosign:v0.3.0 \
  --dry-run=server

```

For example:

```

$ kubectl run cosign-fail \
  --image=gcr.io/projectsigstore/cosign:v0.3.0 \
  --dry-run=server
Error from server (BadRequest): admission webhook "policy.sigstore.dev" denied the request: validation failed: failed policy: image-policy: spec.containers[0].image
gcr.io/projectsigstore/cosign@sha256:135d8c5e27bdc917f04b415fc947d7d5b1137f99

```

```
bb8fa00bffc3ecac1856e9c52 failed to validate public keys with authority official-cosign-key for gcr.io/projectsigstore/cosign@sha256:135d8c5e27bdc917f04b415fc947d7d5b1137f99bb8fa00bffc3ecac1856e9c52: no matching signatures:
```

In the output, it specifies which authorities were used for validation when a policy was found that matched the image. In this case, the authority used was `official-cosign-key`. If no name is specified, it is defaulted to `authority-#`.

Overview of Supply Chain Security Tools - Scan

This topic gives you an overview of use cases, features, and CVEs for Supply Chain Security Tools (SCST) - Scan.

Overview

With Supply Chain Security Tools - Scan, you can build and deploy secure, trusted software that complies with your corporate security requirements. Supply Chain Security Tools - Scan provides scanning and gatekeeping capabilities that Application and DevSecOps teams can incorporate early in their path to production as it is a known industry best practice for reducing security risk and ensuring more efficient remediation.

Language support

For information about the languages and frameworks that are supported by Tanzu Application Platform components, see the [Language and framework support in Tanzu Application Platform](#) table.

Use cases

The following use cases apply to Supply Chain Security Tools - Scan:

- Use your scanner as a plug-in to scan source code repositories and images for known Common Vulnerabilities and Exposures (CVEs) before deploying to a cluster.
- Identify CVEs by continuously scanning each new code commit or each new image built.
- Analyze scan results against user-defined policies by using Open Policy Agent.
- Produce vulnerability scan results and post them to the Supply Chain Security Tools - Store from where they are queried.

Supply Chain Security Tools - Scan features

The following Supply Chain Security Tools - Scan features enable the [Use cases](#):

- Kubernetes controllers to run scan TaskRuns.
- Custom Resource Definitions (CRDs) for Image and Source Scan.
- CRD for a scanner plug-in. Example is available by using Anchore's Syft and Grype.
- CRD for policy enforcement.
- Enhanced scanning coverage by analyzing the Cloud Native Buildpack SBoMs that Tanzu Build Service images provide.

A Note on Vulnerability Scanners

Although vulnerability scanning is an important practice in DevSecOps and the benefits of it are widely recognized and accepted, it is important to remember that there are limitations present that impact its efficacy. The following examples illustrate the limitations that are prevalent in most scanners today:

Missed CVEs

One limitation of all vulnerability scanners is that there is no one tool that can find 100% of all CVEs, which means there is always a risk that a missed CVE can be exploited. Some reasons for missed CVEs include:

- The scanner does not detect the vulnerability because it is just discovered and the CVE databases that the scanner checks against are not updated yet.
- Scanners verify different CVE sources based on the detected package type and OS.
- The scanner might not fully support a particular programming language, packaging system or manifest format.
- The scanner might not implement binary analysis or fingerprinting.
- The detected component does not always include a canonical name and vendor, requiring the scanner to infer and attempt fuzzy matching.
- When vendors register impacted software with NVD, the provided information might not exactly match the values in the release artifacts.

False positives

Vulnerability scanners cannot always access the information to accurately identify whether a CVE exists. This often leads to an influx of false positives where the tool mistakenly flags something as a vulnerability when it isn't. Unless a user is specialized in security or is deeply familiar with what is deemed to be a vulnerable component by the scanner, assessing and determining false positives becomes a challenging and time-consuming activity. Some reasons for a false positive flag include:

- A component might be misidentified due to similar names.
- A subcomponent might be identified as the parent component.
- A component is correctly identified but the impacted function is not on a reachable code path.
- A component's impacted function is on a reachable code path but is not a concern due to the specific environment or configuration.
- The version of a component might be incorrectly flagged as impacted.
- The detected component does not always include a canonical name and vendor, requiring the scanner to infer and attempt fuzzy matching.

So what can you do to protect yourselves and your software?

Although vulnerability scanning is not a perfect solution, it is an essential part of the process for keeping your organization secure. You can take the following measures to maximize the benefits while minimizing the impact of the limitations:

- Scan more continuously and comprehensively to identify and remediate zero-day vulnerabilities quicker. Comprehensive scanning can be achieved by:
 - scanning earlier in the development cycle to ensure issues can be addressed more efficiently and do not delay a release. Tanzu Application Platform includes security practices such as source and container image vulnerability scanning earlier in the path to production for application teams.

- scanning any base images in use. Tanzu Application Platform image scanning includes the ability to recognize and scan the OS packages from a base image.
 - scanning running software in test, stage, and production environments at a regular cadence.
 - generating accurate provenance at any level so that scanners have a complete picture of the dependencies to scan. This is where a software bill of materials (SBOM) comes into play. To help you automate this process, VMware Tanzu Build Service, leveraging Cloud Native Buildpacks, generates an SBOM for buildpack-based projects. Since this SBOM is generated during the image building stage, it is more accurate and complete than one generated earlier or later in the release life cycle. This is because it can highlight dependencies introduced at the time of build that might introduce potential for compromise.
- Scan by using multiple scanners to maximize CVE coverage.
 - Practice keeping your dependencies up-to-date.
 - Reduce overall surface area of attack by:
 - using smaller dependencies.
 - reducing the amount of third party dependencies when possible.
 - using distroless base images when possible.
 - Maintain a central record of false positives to ease CVE triaging and remediation efforts.

Overview of Supply Chain Security Tools - Scan

This topic gives you an overview of use cases, features, and CVEs for Supply Chain Security Tools (SCST) - Scan.

Overview

With Supply Chain Security Tools - Scan, you can build and deploy secure, trusted software that complies with your corporate security requirements. Supply Chain Security Tools - Scan provides scanning and gatekeeping capabilities that Application and DevSecOps teams can incorporate early in their path to production as it is a known industry best practice for reducing security risk and ensuring more efficient remediation.

Language support

For information about the languages and frameworks that are supported by Tanzu Application Platform components, see the [Language and framework support in Tanzu Application Platform](#) table.

Use cases

The following use cases apply to Supply Chain Security Tools - Scan:

- Use your scanner as a plug-in to scan source code repositories and images for known Common Vulnerabilities and Exposures (CVEs) before deploying to a cluster.
- Identify CVEs by continuously scanning each new code commit or each new image built.
- Analyze scan results against user-defined policies by using Open Policy Agent.
- Produce vulnerability scan results and post them to the Supply Chain Security Tools - Store from where they are queried.

Supply Chain Security Tools - Scan features

The following Supply Chain Security Tools - Scan features enable the [Use cases](#):

- Kubernetes controllers to run scan TaskRuns.
- Custom Resource Definitions (CRDs) for Image and Source Scan.
- CRD for a scanner plug-in. Example is available by using Anchore's Syft and Grype.
- CRD for policy enforcement.
- Enhanced scanning coverage by analyzing the Cloud Native Buildpack SBoMs that Tanzu Build Service images provide.

A Note on Vulnerability Scanners

Although vulnerability scanning is an important practice in DevSecOps and the benefits of it are widely recognized and accepted, it is important to remember that there are limitations present that impact its efficacy. The following examples illustrate the limitations that are prevalent in most scanners today:

Missed CVEs

One limitation of all vulnerability scanners is that there is no one tool that can find 100% of all CVEs, which means there is always a risk that a missed CVE can be exploited. Some reasons for missed CVEs include:

- The scanner does not detect the vulnerability because it is just discovered and the CVE databases that the scanner checks against are not updated yet.
- Scanners verify different CVE sources based on the detected package type and OS.
- The scanner might not fully support a particular programming language, packaging system or manifest format.
- The scanner might not implement binary analysis or fingerprinting.
- The detected component does not always include a canonical name and vendor, requiring the scanner to infer and attempt fuzzy matching.
- When vendors register impacted software with NVD, the provided information might not exactly match the values in the release artifacts.

False positives

Vulnerability scanners cannot always access the information to accurately identify whether a CVE exists. This often leads to an influx of false positives where the tool mistakenly flags something as a vulnerability when it isn't. Unless a user is specialized in security or is deeply familiar with what is deemed to be a vulnerable component by the scanner, assessing and determining false positives becomes a challenging and time-consuming activity. Some reasons for a false positive flag include:

- A component might be misidentified due to similar names.
- A subcomponent might be identified as the parent component.
- A component is correctly identified but the impacted function is not on a reachable code path.
- A component's impacted function is on a reachable code path but is not a concern due to the specific environment or configuration.
- The version of a component might be incorrectly flagged as impacted.

- The detected component does not always include a canonical name and vendor, requiring the scanner to infer and attempt fuzzy matching.

So what can you do to protect yourselves and your software?

Although vulnerability scanning is not a perfect solution, it is an essential part of the process for keeping your organization secure. You can take the following measures to maximize the benefits while minimizing the impact of the limitations:

- Scan more continuously and comprehensively to identify and remediate zero-day vulnerabilities quicker. Comprehensive scanning can be achieved by:
 - scanning earlier in the development cycle to ensure issues can be addressed more efficiently and do not delay a release. Tanzu Application Platform includes security practices such as source and container image vulnerability scanning earlier in the path to production for application teams.
 - scanning any base images in use. Tanzu Application Platform image scanning includes the ability to recognize and scan the OS packages from a base image.
 - scanning running software in test, stage, and production environments at a regular cadence.
 - generating accurate provenance at any level so that scanners have a complete picture of the dependencies to scan. This is where a software bill of materials (SBoM) comes into play. To help you automate this process, VMware Tanzu Build Service, leveraging Cloud Native Buildpacks, generates an SBoM for buildpack-based projects. Since this SBoM is generated during the image building stage, it is more accurate and complete than one generated earlier or later in the release life cycle. This is because it can highlight dependencies introduced at the time of build that might introduce potential for compromise.
- Scan by using multiple scanners to maximize CVE coverage.
- Practice keeping your dependencies up-to-date.
- Reduce overall surface area of attack by:
 - using smaller dependencies.
 - reducing the amount of third party dependencies when possible.
 - using distroless base images when possible.
- Maintain a central record of false positives to ease CVE triaging and remediation efforts.

Scan Types for Supply Chain Security Tools - Scan

This topic tells you what scan types you can use with Scan Types for Supply Chain Security Tools (SCST) - Scan. The out-of-box test and scan supply chain supports the source and container image scan types.

Source scan

The source scan step in the test and scan supply chain performs a Software Composition Analysis (SCA) scan to inspect the open source dependencies of an application for vulnerabilities. You perform this by inspecting the file that the language uses for dependency declaration. For example:

Language	Dependency File
Spring	<code>pom.xml</code>
.Net	<code>deps.json</code>

Language	Dependency File
Node.JS	<code>packages.json</code>
Python	<code>requirements.txt</code>

Rather than declare specific dependency versions, some languages such as Spring, Java, and .Net resolve dependency versions at build time. For these languages, performing a SCA scan on the declaration file stored in the source code does not produce meaningful results, often creating false positives or false negatives.

Due to this, in Tanzu Application Platform v1.6, the source scan step is moved to an opt-in step in the supply chain.

Adding Source Scan to the Test and Scan Supply Chain

To add source scanning to the [out-of-the-box test and scan supply chain](#), you can apply an overlay in the install `tap-values.yaml` file. This overlay adds the required resources to the supply chain in the correct location to opt-in to source scanning.

For information about how overlays work with Tanzu Application Platform, see [Customize your package installation](#).

To add source scanning to the default out-of-the-box test and scan supply chain:

1. Create a `secret.yaml` file with a `Secret` that contains your ytt overlay. For example:

```
apiVersion: v1
kind: Secret
metadata:
  name: ootb-supply-chain-testing-scanning-add-source-scanner
  namespace: tap-install
  annotations:
    kapp.k14s.io/change-group: "tap-overlays"
  type: Opaque
stringData:
  ootb-supply-chain-testing-scanning-add-source-scanner.yaml: |
    #@ load("@ytt:overlay", "overlay")
    #@overlay/match by=overlay.subset({"metadata":{"name":"source-test-scan-to-
url"},"kind":"ClusterSupplyChain"})
    ---
    spec:
      resources:
        #@overlay/match by=overlay.index(2)
        #@overlay/insert before=True
        - name: source-scanner
          params:
            - default: scan-policy
              name: scanning_source_policy
            - default: blob-source-scan-template
              name: scanning_source_template
          sources:
            - name: source
              resource: source-tester
          templateRef:
            kind: ClusterSourceTemplate
            name: source-scanner-template
        #@overlay/match by="name"
        - name: image-provider
          sources:
            #@overlay/match by="name"
            - name: source
              resource: source-scanner
```

For information about ytt overlays, see the [Carvel documentation](#).

2. Apply the `Secret` to your cluster:

```
kubectl apply -f secret.yml
```

3. Update your values file to include a `package_overlays` field:

```
package_overlays:
- name: ootb-supply-chain-testing-scanning
  secrets:
  - name: ootb-supply-chain-testing-scanning-add-source-scanner
```

4. Update Tanzu Application Platform:

```
tanzu package installed update tap -p tap.tanzu.vmware.com -v 1.6.13 --values-file tap-values.yaml -n tap-install
```

For a multicluster installation, you must apply this to the build profile, because that is where the scan components run. For information about Tanzu Application Platform profiles, see [Installing Tanzu Application Platform package and profiles](#).

Container image scan

A container image scan inspects the contents of a built container image for vulnerabilities. This scan is performed on the container image after it is uploaded to the container image registry and at periodic intervals after the initial upload. Many container registries, such as [Harbor](#) and [Docker Hub](#) include this capability.

Tanzu Application Platform enables scanning container images for vulnerabilities as part of your supply chain, allowing you to prevent deployment of a container image if vulnerabilities are discovered that exceed your security policy.

Install Supply Chain Security Tools - Scan

This topic describes how you can install Supply Chain Security Tools (SCST) - Scan from the Tanzu Application Platform package repository.



Note

Follow the steps in this topic if you do not want to use a profile to install SCST - Scan. For information about profiles, see [Components and installation profiles](#).

Prerequisites

Before installing SCST - Scan:

- Complete all prerequisites to install Tanzu Application Platform. For more information, see [Prerequisites](#).
- Install [Supply Chain Security Tools - Store](#) for scan results to persist. The integration with SCST - Store are handled in:
 - **Single Cluster:** The SCST - Store is present in the same cluster where SCST - Scan and the `ScanTemplates` are present.

- **Multi-Cluster:** The SCST - Store is present in a different cluster (e.g.: view cluster) where the SCST - Scan and `ScanTemplates` are present.
- **Integration Deactivated:** The SCST - Scan deployment is not required to communicate with SCST - Store.

For information about SCST - Store, see [Using the Supply Chain Security Tools - Store](#).

Configure properties

When you install the SCST - Scan (Scan controller), you can configure the following optional properties:

Key	Default	Type	Description	ScanTemplate Version
<code>resources.limits.cpu</code>	250m	integer /string	Limits describes the maximum amount of CPU resources allowed.	<i>n/a</i>
<code>resources.limits.memory</code>	256Mi	integer /string	Limits describes the maximum amount of memory resources allowed.	<i>n/a</i>
<code>resources.requests.cpu</code>	100m	integer /string	Requests describes the minimum amount of CPU resources required.	<i>n/a</i>
<code>resources.requests.memory</code>	128Mi	integer /string	Requests describes the minimum amount of memory resources required.	<i>n/a</i>
<code>namespace</code>	scan-link-system	string	Deployment namespace for the Scan Controller	<i>n/a</i>
<code>metadataStore.caSecret.importFromNamespace</code>	metadata-store	string	Namespace from which you import the Insight Metadata Store CA Cert	earlier than v1.2.0
<code>metadataStore.caSecret.name</code>	app-tls-cert	string	Name of deployed secret with key ca.crt holding the CA Cert of the Insight Metadata Store	earlier than v1.2.0
<code>metadataStore.clusterRole</code>	metadata-store-read-write	string	Name of the deployed ClusterRole for read/write access to the Insight Metadata Store deployed in the same cluster	earlier than v1.2.0
<code>metadataStore.url</code>	https://metadata-store-app.metadata-store.svc.cluster.local:8443	string	URL of the Insight Metadata Store	earlier than v1.2.0
<code>metadataStore.authSecret.importFromNamespace</code>	<i>n/a</i>	string	Namespace from which to import the Insight Metadata Store auth_token	earlier than v1.2.0
<code>metadataStore.authSecret.name</code>	<i>n/a</i>	string	Name of deployed secret with key auth_token	earlier than v1.2.0
<code>retryScanJobsSecondsAfterError</code>	60	integer	Seconds to wait before retrying errored scans	v1.3.1 and later
<code>caCertData</code>	""	string	The custom certificates trusted by the scans' connections	v1.4.0 and later
<code>certIssuer</code>	""	string	The common certificate issuer for the cluster	v1.5.0 and later

Key	Default	Type	Description	ScanTemplate Version
controller.pullSecret	"controller-secret-ref"	string	Reference to the secret used for pulling the controller image from private registry. Set to empty if deploying from a public registry.	v1.5.0 and later
docker.import	true	Boolean	Import <code>controller.pullSecret</code> from another namespace (requires <code>secretgen-controller</code>). Set to false if the secret is present.	v1.5.0 and later
kubeRbacProxy.certRef	""	string	Reference to the secret which holds certificate for kube-rbac-proxy. The Certificate enables secure connection to the metric proxy.	v1.5.0 and later
kubeRbacProxy.tls.minVersion	""	string	Minimum TLS version supported by kube-rbac-proxy. Value must match version names from https://golang.org/pkg/crypto/tls/#pkg-constants .	v1.5.0 and later
kubeRbacProxy.tls.ciphers	empty array	array of strings	Comma-separated list of cipher suites for the server supported by kube-rbac-proxy. Values are from <code>tls</code> package constants (https://golang.org/pkg/crypto/tls/#pkg-constants).	v1.5.0 and later

When you install the SCST - Scan (Grype scanner), you can configure the following optional properties:

Key	Default	Type	Description	ScanTemplate Version
resources.requests.cpu	250m	integer /string	Requests describes the minimum amount of CPU resources required.	
resources.requests.memory	128Mi	integer /string	Requests describes the minimum amount of memory resources required.	
scanner.serviceAccount	grype-scanner	string	Name of scan pod's service ServiceAccount	
scanner.serviceAccountAnnotations	nil	object	Annotations added to ServiceAccount	
targetImagePullSecret	<i>n/a</i>	string	Reference to the secret used for pulling images from private registry	
targetSourceSshSecret	<i>n/a</i>	string	Reference to the secret containing SSH credentials for cloning private repositories	
namespace	default	string	Deployment namespace for the Scan Templates	<i>n/a</i>
metadataStore.url	https://metadata-store-app.metadata-store.svc.cluster.local:8443	string	URL of the Insight Metadata Store	v1.2.0 and earlier
metadataStore.authSecret.name	<i>n/a</i>	string	Name of deployed secret with key <code>auth_token</code>	v1.2.0 and earlier
metadataStore.authSecret.importFromNamespace	<i>n/a</i>	string	Namespace from which to import the Insight Metadata Store <code>auth_token</code>	v1.2.0 and earlier

Key	Default	Type	Description	ScanTemplate Version
metadataStore.caSecret.importFromNamespace	metadata-store	string	Namespace from which to import the Insight Metadata Store CA Cert	v1.2.0 and earlier
metadataStore.caSecret.name	app-tls-cert	string	Name of deployed secret with key ca.crt holding the CA Cert of the Insight Metadata Store	v1.2.0 and earlier
metadataStore.clusterRole	metadata-store-read-write	string	Name of the deployed ClusterRole for read/write access to the Insight Metadata Store deployed in the same cluster	v1.2.0

Install

There are two options for installing Supply Chain Security Tools – Scan

Option 1: Install to multiple namespaces with the Namespace Provisioner

The Namespace Provisioner enables operators to securely automate the provisioning of multiple developer namespaces in a shared cluster. To install Supply Chain Security Tools – Scan by using the Namespace Provisioner, see [Namespace Provisioner](#).

The Namespace Provisioner can also create scan policies across multiple developer namespaces. See [Customize installation](#) in the Namespace Provisioner documentation for configuration steps.

Option 2: Install manually to each individual namespace

The installation for Supply Chain Security Tools – Scan involves installing two packages:

- Scan controller
- Grype scanner

The Scan controller enables you to use a scanner, in this case, the Grype scanner. Ensure that both the Grype scanner and the Scan controller are installed.

To install SCST - Scan (Scan controller):

1. List version information for the package by running:

```
tanzu package available list scanning.apps.tanzu.vmware.com --namespace tap-  
install
```

For example:

```
$ tanzu package available list scanning.apps.tanzu.vmware.com --namespace tap-  
install  
/ Retrieving package versions for scanning.apps.tanzu.vmware.com...  
NAME                                VERSION    RELEASED-AT  
scanning.apps.tanzu.vmware.com      1.1.0
```

2. (Optional) Make changes to the default installation settings:

If you are using Grype Scanner [v1.5.1 and later](#) or other supported scanners included with Tanzu Application Platform [v1.5.1 and later](#), and do not want to use the default SCST - Store integration, deactivate the integration by appending the following field to the `values.yaml` file:

```
---
metadataStore:
  url: "" # Deactivate Supply Chain Security Tools - Store integration
```

If you are using Grype Scanner [v1.5.0](#) or other supported scanners included with Tanzu Application Platform [v1.5.0](#), and do not want to use the default SCST - Store integration, deactivate the integration by appending the following field to the `values.yaml` file:

```
---
metadataStore: {} # Deactivate Supply Chain Security Tools - Store integration
```

If you are using Grype Scanner [v1.2.0](#) and [earlier](#), or the Snyk Scanner, the following scanning configuration deactivates the embedded SCST - Store integration with a `scan-values.yaml` file.

```
---
metadataStore:
  url: "" # Deactivate Supply Chain Security Tools - Store integration
```

If your Grype Scanner version is earlier than [v1.2.0](#), the scanning configuration must configure the store parameters. See [v1.1 Install Supply Chain Security Tools - Scan](#).

Run to retrieve other configurable settings and append the key-value pair to the previous `scan-values.yaml` file:

```
tanzu package available get scanning.apps.tanzu.vmware.com/VERSION --values-schema -n tap-install
```

Where `VERSION` is your package version number. For example, [1.1.0](#).

3. Install the package by running:

```
tanzu package install scan-controller \
  --package scanning.apps.tanzu.vmware.com \
  --version VERSION \
  --namespace tap-install \
  --values-file scan-values.yaml
```

Where `VERSION` is your package version number. For example, [1.1.0](#).

To install SCST - Scan (Grype scanner):



Note

To install Grype in multiple namespaces, use a namespace provisioner. See [Namespace Provisioner](#).

1. List version information for the package by running:

```
tanzu package available list grype.scanning.apps.tanzu.vmware.com --namespace tap-install
```

For example:

```
$ tanzu package available list grype.scanning.apps.tanzu.vmware.com --namespace tap-install
/ Retrieving package versions for grype.scanning.apps.tanzu.vmware.com...
NAME                                VERSION    RELEASED-AT
grype.scanning.apps.tanzu.vmware.com 1.1.0
```

2. (Optional) Make changes to the default installation settings:

To define the configuration for the SCST - Store integration in the `grype-values.yaml` file for the Grype Scanner:

```
---
namespace: "DEV-NAMESPACE" # The developer namespace where the ScanTemplates are going to be deployed
metadataStore:
  url: "METADATA-STORE-URL" # The base URL where the Store deployment can be reached
  caSecret:
    name: "CA-SECRET-NAME" # The name of the secret containing the ca.crt
    importFromNamespace: "SECRET-NAMESPACE" # The namespace where Store is deployed (if single cluster) or where the connection secrets were created (if multi-cluster)
  authSecret:
    name: "TOKEN-SECRET-NAME" # The name of the secret containing the auth token to connect to Store
    importFromNamespace: "SECRET-NAMESPACE" # The namespace where the connection secrets were created (if multi-cluster)
```

**Note**

In a single cluster, the connection between the scanning pod and the metadata store happens inside the cluster and does not pass through ingress. This is automatically configured. You do not need to provide an ingress connection to the store. For information about troubleshooting issues with scanner to metadata store connection configuration, see [Troubleshooting Scanner to MetadataStore Configuration](#).

Important You must either define both the `METADATA-STORE-URL` and `CA-SECRET-NAME`, or not define them as they depend on each other.

Where:

- `DEV-NAMESPACE` is the namespace where you want to deploy the `ScanTemplates`. This is the namespace where the scanning feature runs.
- `METADATA-STORE-URL` is the base URL where the Supply Chain Security Tools (SCST) - Store deployment is reached, for example, `https://metadata-store-app.metadata-store.svc.cluster.local:8443`.
- `CA-SECRET-NAME` is the name of the secret containing the `ca.crt` to connect to the SCST - Store deployment.
- `SECRET-NAMESPACE` is the namespace where SCST - Store is deployed, if you are using a single cluster. If you are using multicluster, it is where the connection secrets were created.
- `TOKEN-SECRET-NAME` is the name of the secret containing the authentication token to connect to the SCST - Store deployment when installed in a different cluster, if you are using multicluster. If built images are pushed to the same registry as the Tanzu Application Platform images, this can reuse the `tap-registry` secret created in [Add the Tanzu Application Platform package repository](#) as described earlier.

Run to retrieve other configurable settings and append the key-value pair to the previous `grype-values.yaml` file:

```
tanzu package available get grype.scanning.apps.tanzu.vmware.com/VERSION --values-schema -n tap-install
```

Where `VERSION` is your package version number. For example, `1.1.0`.

For example:

```
$ tanzu package available get grype.scanning.apps.tanzu.vmware.com/1.1.0 --values-schema -n tap-install
| Retrieving package details for grype.scanning.apps.tanzu.vmware.com/1.1.0...
  KEY                                DEFAULT  TYPE      DESCRIPTION
  namespace                          default  string    Deployment namespace for the Scan
Templates
  resources.limits.cpu                1000m   <nil>     Limits describes the maximum amou
nt of cpu resources allowed.
  resources.requests.cpu              250m   <nil>     Requests describes the minimum am
ount of cpu resources required.
  resources.requests.memory           128Mi  <nil>     Requests describes the minimum am
ount of memory resources required.
  targetImagePullSecret               <EMPTY> string    Reference to the secret used for
pulling images from private registry.
  targetSourceSshSecret               <EMPTY> string    Reference to the secret containin
g SSH credentials for cloning private repositories.
```



Important

If `targetSourceSshSecret` is not set, the private source scan template is not installed.

3. Install the package by running:

```
tanzu package install grype-scanner \
  --package grype.scanning.apps.tanzu.vmware.com \
  --version VERSION \
  --namespace tap-install \
  --values-file grype-values.yaml
```

Where `VERSION` is your package version number. For example, `1.1.0`.

For example:

```
$ tanzu package install grype-scanner \
  --package grype.scanning.apps.tanzu.vmware.com \
  --version 1.1.0 \
  --namespace tap-install \
  --values-file grype-values.yaml
/ Installing package 'grype.scanning.apps.tanzu.vmware.com'
| Getting namespace 'tap-install'
| Getting package metadata for 'grype.scanning.apps.tanzu.vmware.com'
| Creating service account 'grype-scanner-tap-install-sa'
| Creating cluster admin role 'grype-scanner-tap-install-cluster-role'
| Creating cluster role binding 'grype-scanner-tap-install-cluster-rolebinding'
/ Creating package resource
- Package install status: Reconciling

Added installed package 'grype-scanner' in namespace 'tap-install'
```

Upgrade Supply Chain Security Tools - Scan

This topic describes how you can upgrade Supply Chain Security Tools - Scan from the Tanzu Application Platform package repository.

You can perform a fresh install of SCST - Scan by following the instructions in [Install Supply Chain Security Tools - Scan](#).

Prerequisites

Before you upgrade SCST - Scan, upgrade the Tanzu Application Platform by following the instructions in [Upgrading Tanzu Application Platform](#).

General Upgrades for SCST - Scan

When you're upgrading to any version of SCST - Scan these are some factors to accomplish this task:

1. Inspect the [Release Notes](#) for the version you're upgrading to. There you can find any breaking changes for the installation.
2. Get the values schema for the package version you're upgrading to by running:

```
tanzu package available get scanning.apps.tanzu.vmware.com/$VERSION --values-schema -n tap-install
```

Where `$VERSION` is the new version. This gives you insights on the values you can configure in your `tap-values.yaml` for the new version.

Upgrading a scanner in all namespaces

This section describes how to upgrade a supported scanner in all namespaces. The procedure is different depending on the installation method:

1. Installation by using Namespace Provisioner
2. Manual installation

Installation by using Namespace Provisioner

All scanners installed by the Namespace Provisioner in all managed namespaces are upgraded automatically. For example, if you upgrade your installation of Tanzu Application Platform and the version of Grype is updated, all Grype scanners installed by the Namespace Provisioner for all managed namespaces are automatically upgraded.

Manual installation

1. If a scanner, such as Grype Scanner, was installed as part of Tanzu Application Platform by using the [full profile](#), run to upgrade:

```
tanzu package installed update tap -p tap.tanzu.vmware.com -v VERSION --values-file tap-values.yaml -n tap-install
```

Where `VERSION` is your Tanzu Application Platform version.

2. If a scanner, such as Grype Scanner, was installed by using [component installation](#) you must manually run:

```
tanzu package installed update grype -p grype.scanning.apps.tanzu.vmware.com -v GRYPE-VERSION --values-file grype-values.yaml -n NAMESPACE
```

Where:

- `GRYPE-VERSION` is the version of Grype that you are upgrading to.
- `NAMESPACE` is the namespace in which Grype is installed in.

Upgrade to Version v1.2.0

To upgrade from a previous version of SCST - Scan to the version `v1.2.0`:

1. Change the `SecretExports` from SCST - Store.

SCST - Scan needs information to connect to the SCST - Store deployment, you must change where these secrets are exported to enable the connection with the version `v1.2.0` of SCST - Scan.

- **For a single cluster deployment:**

1. Edit the `tap-values.yaml` file you used to deploy SCST - Store to export the CA certificate to your developer namespace.

```
metadata_store:
  ns_for_export_app_cert: "DEV-NAMESPACE"
```



Note

The `ns_for_export_app_cert` supports one namespace at a time. If you have multiple namespaces you can replace this value with a `*`, but this exports the CA certificate to all namespaces. Consider whether this increased visibility presents a risk.

2. Update Tanzu Application Platform to apply the changes:

```
tanzu package installed update tap -f tap-values.yaml -n tap-instal1
```

- **For a multi-cluster deployment:**

You must reapply the `SecretExport` by changing the `toNamespace: scan-link-system` to `toNamespace: DEV-NAMESPACE`:

```
---
apiVersion: secretgen.carvel.dev/v1alpha1
kind: SecretExport
metadata:
  name: store-ca-cert
  namespace: metadata-store-secrets
spec:
  toNamespace: "DEV-NAMESPACE"
---
apiVersion: secretgen.carvel.dev/v1alpha1
kind: SecretExport
metadata:
  name: store-auth-token
  namespace: metadata-store-secrets
spec:
  toNamespace: "DEV-NAMESPACE"
```

2. Update your `tap-values.yaml` file.

The installation of the SCST - Scan and the Grype scanner have some changes. The connection to the SCST - Store component have moved to the Grype scanner package. To deactivate the connection from the SCST - Scan, which is still present for backwards compatibility, but is deprecated and is removed in [v1.3.0](#).

```
# Deactivate scan controller embedded Supply Chain Security Tools - Store integ
ration
scanning:
  metadataStore:
    url: ""

# Install Grype Scanner v1.2.0
grype:
  namespace: "DEV-NAMESPACE" # The developer namespace where the ScanTemplates
are going to be deployed
  metadataStore:
    url: "METADATA-STORE-URL" # The base URL where the Store deployment can be
reached
  caSecret:
    name: "CA-SECRET-NAME" # The name of the secret containing the ca.crt
    importFromNamespace: "SECRET-NAMESPACE" # The namespace where Store is de
ployed (if single cluster) or where the connection secrets were created (if mul
ti-cluster)
  authSecret:
    name: "TOKEN-SECRET-NAME" # The name of the secret containing the auth to
ken to connect to Store
    importFromNamespace: "SECRET-NAMESPACE" # The namespace where the connect
ion secrets were created (if multi-cluster)
```

For more insights on how to install Grype, see [Install Supply Chain Security Tools - Scan \(Grype Scanner\)](#).



Note

If a mix of Grype templates, such as earlier than v1.2.0 and v1.2.0 and later, are used, both `scanning` and `grype` must configure the parameters. The secret must also export to both `scan-link-system` and the developer namespace. Do this by exporting to `*` or by defining multiple secrets and exports. If Grype is installed to multiple namespaces there must be corresponding exports. See [Install Supply Chain Security Tools - Scan \(Grype Scanner\)](#).

3. Update Tanzu Application Platform to apply the changes:

```
tanzu package installed update tap -f tap-values.yaml -n tap-install
```

4. Update the `ScanPolicy` to include the latest structure changes for [v1.2.0](#).

To update to the latest valid Rego File in the `ScanPolicy`, [Enforce compliance policy using Open Policy Agent](#). [v1.2.0](#) introduced some breaking changes in the Rego File structure used for the `ScanPolicies`. For more information, see the [Release Notes](#).

5. Verify the upgrade.

You can run any `ImageScan` or `SourceScan` in your `DEV-NAMESPACE` where the Grype Scanner was installed, and it finishes. Here is a sample you can try to run to detect if everything upgraded.

1. Create the `verify-upgrade.yaml` file in your system with the following content:

```

---
apiVersion: scanning.apps.tanzu.vmware.com/v1beta1
kind: ScanPolicy
metadata:
  name: scan-policy
  labels:
    'app.kubernetes.io/part-of': 'enable-in-gui'
spec:
  regoFile: |
    package main

    # Accepted Values: "Critical", "High", "Medium", "Low", "Negligible",
    "UnknownSeverity"
    notAllowedSeverities := ["Critical", "High", "UnknownSeverity"]
    ignoreCves := []

    contains(array, elem) = true {
      array[_] = elem
    } else = false { true }

    isSafe(match) {
      severities := { e | e := match.ratings.rating.severity } | { e | e
:= match.ratings.rating[_].severity }
      some i
      fails := contains(notAllowedSeverities, severities[i])
      not fails
    }

    isSafe(match) {
      ignore := contains(ignoreCves, match.id)
      ignore
    }

    deny[msg] {
      comps := { e | e := input.bom.components.component } | { e | e := i
nput.bom.components.component[_] }
      some i
      comp := comps[i]
      vulns := { e | e := comp.vulnerabilities.vulnerability } | { e | e
:= comp.vulnerabilities.vulnerability[_] }
      some j
      vuln := vulns[j]
      ratings := { e | e := vuln.ratings.rating.severity } | { e | e := v
uln.ratings.rating[_].severity }
      not isSafe(vuln)
      msg = sprintf("CVE %s %s %s", [comp.name, vuln.id, ratings])
    }
---
apiVersion: scanning.apps.tanzu.vmware.com/v1beta1
kind: ImageScan
metadata:
  name: sample-public-image-scan
spec:
  registry:
    image: "nginx:1.16"
  scanTemplate: public-image-scan-template
  scanPolicy: scan-policy

```

2. Deploy the resources:

```
kubectl apply -f verify-upgrade.yaml -n DEV-NAMESPACE
```

3. View the scan results:

```
kubectl describe imagescan sample-public-image-scan -n DEV-NAMESPACE
```

If it is successful, the `ImageScan` goes to the `Failed` phase and shows the results of the scan in the `Status`.

Install another scanner for Supply Chain Security Tools - Scan

This topic describes how you can install scanners to work with Supply Chain Security Tools - Scan from the Tanzu Application Platform package repository.

Follow the instructions in this topic to install a scanner other than the out of the box Grype Scanner with SCST - Scan.

Prerequisites

Before installing a new scanner, install [Supply Chain Security Tools - Scan](#). It must be present on the same cluster. The prerequisites for Scan are also required.

Install

To install a new scanner, follow these steps:

1. Complete scanner specific prerequisites for the scanner you're trying to install. For example, creating an API token to connect to the scanner.
 - [Snyk Scanner \(Beta\)](#) is available for image scanning.
 - [Carbon Black Scanner \(Beta\)](#) is available for image scanning.
2. List the available packages to discover what scanners you can use by running:

```
tanzu package available list --namespace tap-install
```

For example:

```
$ tanzu package available list --namespace tap-install
/ Retrieving available packages...
NAME                                DISPLAY-NAME
SHORT-DESCRIPTION
grype.scanning.apps.tanzu.vmware.com  Grype Scanner for Supply
Chain Security Tools - Scan          Default scan templates using A
nchore Grype
snyk.scanning.apps.tanzu.vmware.com   Snyk for Supply Chain Se
curity Tools - Scan                 Default scan templates using
Snyk
carbonblack.scanning.apps.tanzu.vmware.com  Carbon Black Scanner for
Supply Chain Security Tools - Scan  Default scan templates using C
arbon Black
```

3. List version information for the scanner package by running:

```
tanzu package available list SCANNER-NAME --namespace tap-install
```

For example:

```
$ tanzu package available list snyk.scanning.apps.tanzu.vmware.com --namespace
tap-install
/ Retrieving package versions for snyk.scanning.apps.tanzu.vmware.com...
```

NAME	VERSION	RELEASED-AT
snyk.scanning.apps.tanzu.vmware.com	1.0.0-beta.2	

- (Optional) Confirm that the secret created in Step 1 for scanner specific prerequisites is created.
- Create a `values.yaml` to apply custom configurations to the scanner:



Note

This step might be required for some scanners but optional for others.

To list the values you can configure for any scanner, run:

```
tanzu package available get SCANNER-NAME/VERSION --values-schema -n tap-install
```

Where:

- `SCANNER-NAME` is the name of the scanner package you retrieved earlier.
- `VERSION` is your package version number. For example, `snyk.scanning.apps.tanzu.vmware.com/1.0.0-beta.2`.

For example:

```
$ tanzu package available get snyk.scanning.apps.tanzu.vmware.com/1.0.0-beta.2
--values-schema -n tap-install

KEY                                     DEFAULT
TYPE      DESCRIPTION
-----
metadataStore.authSecret.name
string    Name of deployed Secret with key auth_token
metadataStore.authSecret.importFromNamespace
string    Namespace from which to import the Insight Metadata Store auth_token
metadataStore.caSecret.importFromNamespace   metadata-store
string    Namespace from which to import the Insight Metadata Store CA Cert
metadataStore.caSecret.name                  app-tls-cert
string    Name of deployed Secret with key ca.crt holding the CA Cert of the Insi
ght Metadata Store
metadataStore.clusterRole                    metadata-store-read-write
string    Name of the deployed ClusterRole for read/write access to the Insight M
etadata Store deployed in the same cluster
metadataStore.url                            https://metadata-store-app.metada
ta-store.svc.cluster.local:8443 string  Url of the Insight Metadata Store
namespace                                     default
string    Deployment namespace for the Scan Templates
resources.requests.cpu                       250m
<nil>    Requests describes the minimum amount of cpu resources required.
resources.requests.memory                    128Mi
<nil>    Requests describes the minimum amount of memory resources required.
resources.limits.cpu                         1000m
<nil>    Limits describes the maximum amount of cpu resources allowed.
snyk.tokenSecret.name
string    Reference to the secret containing a Snyc API Token as snyk_token.
targetImagePullSecret
string    Reference to the secret used for pulling images from private registry.
```

- Define the `--values-file` flag to customize the default configuration:

The `values.yaml` file you created earlier is referenced with the `--values-file` flag when running your Tanzu install command:

```
tanzu package install REFERENCE-NAME \
  --package SCANNER-NAME \
  --version VERSION \
  --namespace tap-install \
  --values-file PATH-TO-VALUES-YAML
```

Where:

- `REFERENCE-NAME` is the name referenced by the installed package. For example, `grype-scanner`, `snyk-scanner`.
- `SCANNER-NAME` is the name of the scanner package you retrieved earlier. For example, `snyk.scanning.apps.tanzu.vmware.com`.
- `VERSION` is your package version number. For example, `1.0.0-beta.2`.
- `PATH-TO-VALUES-YAML` is the path that points to the `values.yaml` file created earlier.

For example:

```
$ tanzu package install snyk-scanner \
  --package snyk.scanning.apps.tanzu.vmware.com \
  --version 1.1.0 \
  --namespace tap-install \
  --values-file values.yaml
/ Installing package 'snyk.scanning.apps.tanzu.vmware.com'
| Getting namespace 'tap-install'
| Getting package metadata for 'snyk.scanning.apps.tanzu.vmware.com'
| Creating service account 'snyk-scanner-tap-install-sa'
| Creating cluster admin role 'snyk-scanner-tap-install-cluster-role'
| Creating cluster role binding 'snyk-scanner-tap-install-cluster-rolebinding'
/ Creating package resource
- Package install status: Reconciling

Added installed package 'snyk-scanner' in namespace 'tap-install'
```

Verify Installation

To verify the installation create an `ImageScan` or `SourceScan` referencing one of the newly added `ScanTemplates` for the scanner.

1. (Optional) Create a `ScanPolicy` formatted for the output specific to the scanner you are installing, to reference in the `ImageScan` or `SourceScan`.

```
kubectl apply -n $DEV_NAMESPACE -f SCAN-POLICY-YAML
```



Note

As vulnerability scanners output different formats, the `ScanPolicies` can vary. For information about policies and samples, see [Enforce compliance policy using Open Policy Agent](#).

2. Retrieve available `ScanTemplates` from the namespace where the scanner is installed:

```
kubectl get scantemplates -n DEV-NAMESPACE
```

Where `DEV-NAMESPACE` is the developer namespace where the scanner is installed.

For example:

```
$ kubectl get scantemplates
NAME                                AGE
blob-source-scan-template          10d
private-image-scan-template        10d
public-image-scan-template         10d
public-source-scan-template        10d
snyk-private-image-scan-template   10d
snyk-public-image-scan-template    10d
```

3. Create the following ImageScan YAML:



Note

Some scanners do not support both [ImageScan](#) and [SourceScan](#).

```
apiVersion: scanning.apps.tanzu.vmware.com/v1beta1
kind: ImageScan
metadata:
  name: sample-scanner-public-image-scan
spec:
  registry:
    image: "nginx:1.16"
  scanTemplate: SCAN-TEMPLATE
  scanPolicy: SCAN-POLICY # Optional
```

Where:

- [SCAN-TEMPLATE](#) is the name of the installed [ScanTemplate](#) in the [DEV-NAMESPACE](#) you retrieved earlier.
- [SCAN-POLICY](#) it's an optional reference to an existing [ScanPolicy](#) in the same [DEV-NAMESPACE](#).

For example:

```
apiVersion: scanning.apps.tanzu.vmware.com/v1beta1
kind: ImageScan
metadata:
  name: sample-snyk-public-image-scan
spec:
  registry:
    image: "nginx:1.16"
  scanTemplate: snyk-public-image-scan-template
  scanPolicy: snyk-scan-policy
```

4. Create the following SourceScan YAML:



Note

Some scanners do not support both [ImageScan](#) and [SourceScan](#).

```
apiVersion: scanning.apps.tanzu.vmware.com/v1beta1
kind: SourceScan
metadata:
  name: sample-scanner-public-source-scan
spec:
  git:
    url: "https://github.com/houndci/hound.git"
    revision: "5805c650"
```

```
scanTemplate: SCAN-TEMPLATE
scanPolicy: SCAN-POLICY # Optional
```

Where:

- `SCAN-TEMPLATE` is the name of the installed `ScanTemplate` in the `DEV-NAMESPACE` you retrieved earlier.
- `SCAN-POLICY` is an optional reference to an existing `ScanPolicy` in the same `DEV-NAMESPACE`.

For example:

```
apiVersion: scanning.apps.tanzu.vmware.com/v1beta1
kind: SourceScan
metadata:
  name: sample-grype-public-source-scan
spec:
  git:
    url: "https://github.com/houndci/hound.git"
    revision: "5805c650"
  scanTemplate: public-source-scan-template
  scanPolicy: scan-policy
```

5. Apply the ImageScan and SourceScan YAMLS:

To run the scans, apply them to the cluster by running these commands:

ImageScan:

```
kubectl apply -f PATH-TO-IMAGE-SCAN-YAML -n DEV-NAMESPACE
```

Where `PATH-TO-IMAGE-SCAN-YAML` is the path to the YAML file created earlier.

SourceScan:

```
kubectl apply -f PATH-TO-SOURCE-SCAN-YAML -n DEV-NAMESPACE
```

Where `PATH-TO-SOURCE-SCAN-YAML` is the path to the YAML file created earlier.

For example:

```
$ kubectl apply -f imagescan.yaml -n my-apps
imagescan.scanning.apps.tanzu.vmware.com/sample-snyk-public-image-scan created

$ kubectl apply -f sourcescan.yaml -n my-apps
sourcescan.scanning.apps.tanzu.vmware.com/sample-grype-public-source-scan created
```

6. To verify the integration, get the scan to see if it completed by running:

For **ImageScan**:

```
kubectl get imagescan IMAGE-SCAN-NAME -n DEV-NAMESPACE
```

Where `IMAGE-SCAN-NAME` is the name of the `ImageScan` as defined in the YAML file created earlier.

For **SourceScan**:

```
kubectl get sourcescan SOURCE-SCAN-NAME -n DEV-NAMESPACE
```

Where `SOURCE-SCAN-NAME` is the name of the `SourceScan` as defined in the YAML file created earlier.

For example:

```
$ kubectl get imagescan sample-snyk-public-image-scan -n my-apps
NAME                                     PHASE      SCANNEDIMAGE  AGE    CRITICAL  HIG
H   MEDIUM  LOW   UNKNOWN  CVETOTAL
sample-snyk-public-image-scan  Completed  nginx:1.16    26h   0         114
58         314   0     486

$ kubectl get sourcescan sample-grype-public-source-scan -n my-apps
NAME                                     PHASE
SCANNEDREVISION  SCANNEDREPOSITORY  AGE    CRITICAL  HIG
H   MEDIUM  LOW   UNKNOWN  CVETOTAL
sourcescan.scanning.apps.tanzu.vmware.com/grypesourcescan-sample-public  Compl
eted   5805c650          https://github.com/houndci/hound.git  8m34s  21
121   112    9     0     263
```



Note

If you define a `ScanPolicy` for the scans and the evaluation finds a violation, the `Phase` is `Failed` instead of `Completed`. In both cases the scan finished.

7. Clean up:

```
kubectl delete -f PATH-TO-SCAN-YAML -n DEV-NAMESPACE
```

Where `PATH-TO-SCAN-YAML` is the path to the YAML file created earlier.

Install scanner to multiple namespaces

To install a Scanner to multiple namespaces, VMware recommends using a namespace provisioner. See [Namespace Provisioner](#)

Configure Tanzu Application Platform Supply Chain to use new scanner

In order to scan your images with the new scanner installed in the [Out of the Box Supply Chain with Testing and Scanning](#), you must update your Tanzu Application Platform installation.

Add the `ootb_supply_chain_testing_scanning.scanning` section to your `tap-values.yaml` and perform a [Tanzu Application Platform update](#).

You can define which `ScanTemplates` is used for both `SourceScan` and `ImageScan`. The default values are the Grype Scanner `ScanTemplates`, but they are overwritten by any other `ScanTemplate` present in your `DEV-NAMESPACE`. The same applies to the `ScanPolicies` applied to each kind of scan.

```
ootb_supply_chain_testing_scanning:
  scanning:
    image:
      template: IMAGE-SCAN-TEMPLATE
      policy: IMAGE-SCAN-POLICY
    source:
      template: SOURCE-SCAN-TEMPLATE
      policy: SOURCE-SCAN-POLICY
```



Note

For the Supply Chain to work properly, the `SOURCE-SCAN-TEMPLATE` must support blob files and the `IMAGE-SCAN-TEMPLATE` must support private images.

For example:

```
ootb_supply_chain_testing_scanning:
  scanning:
    image:
      template: snyk-private-image-scan-template
      policy: snyk-scan-policy
    source:
      template: blob-source-scan-template
      policy: scan-policy
```

Uninstall Scanner

To replace the scanner in the Supply Chain, follow the steps mentioned in [Configure TAP Supply Chain to Use New Scanner](#). After the scanner is no longer required by the Supply Chain, you can remove the package by running:

```
tanzu package installed delete REFERENCE-NAME \
  --namespace tap-install
```

Where `REFERENCE-NAME` is the name you identified the package with, when installing in the [Install](#) section. For example, `grype-scanner`, `snyk-scanner`.

For example:

```
$ tanzu package installed delete snyk-scanner \
  --namespace tap-install
```

Other Available Scanner Integrations

In addition to providing the above supported integrations, VMware encourages the broader community to support VMware in our goal of integrating with customers' preferred CVE scanners.

Additional integrations:

- [Prisma Scanner \(Alpha\)](#) is available for source and image scanning.
- [Trivy Scanner \(Alpha\)](#) is available for source and image scanning.

Prerequisites for Snyk Scanner for Supply Chain Security Tools - Scan (Beta)

This topic describes the prerequisites you must complete to install Supply Chain Security Tools - Scan (Snyk Scanner) from the Tanzu Application Platform package repository.



Important

Snyk's image scanning capability is in beta. Snyk might only return a partial list of CVEs when scanning Buildpack images.

Prepare the Snyk Scanner configuration

1. Obtain a Snyk API Token from the [Snyk documentation](#).
2. Create a Snyk secret YAML file and insert the base64 encoded Snyk API token into the `snyk_token`:

```
apiVersion: v1
kind: Secret
metadata:
  name: snyk-token-secret
  namespace: my-apps
data:
  snyk_token: BASE64-SNYK-API-TOKEN
```

Where `BASE64-SNYK-API-TOKEN` is the Snyk API Token obtained earlier.

3. Apply the Snyk secret YAML file by running:

```
kubectl apply -f YAML-FILE
```

Where `YAML-FILE` is the name of the Snyk secret YAML file you created.

4. Define the `--values-file` flag to customize the default configuration. You must define the following fields in the `values.yaml` file for the Snyk Scanner configuration. You can add fields as needed to activate or deactivate behaviors. You can append the values to this file as shown later in this topic. Create a `values.yaml` file by using the following configuration:

```
---
namespace: DEV-NAMESPACE
targetImagePullSecret: TARGET-REGISTRY-CREDENTIALS-SECRET
snyk:
  tokenSecret:
    name: SNYK-TOKEN-SECRET
```

Where:

- `DEV-NAMESPACE` is your developer namespace. To use a namespace other than the default namespace, ensure that the namespace exists before you install. If the namespace does not exist, the scanner installation fails.
- `TARGET-REGISTRY-CREDENTIALS-SECRET` is the name of the secret that contains the credentials to pull an image from a private registry for scanning.
- `SNYK-TOKEN-SECRET` is the name of the secret you created that contains the `snyk_token` to connect to the [Snyk API](#). This field is required.

The Snyk Scanner integration can work with or without the SCST - Store integration. The `values.yaml` file is slightly different for each configuration.

SCST - Store integration

Using SCST - Store Integration: To persist the results found by the Snyk Scanner, you can enable the SCST - Store integration by appending the fields to the `values.yaml` file.

The Grype and Snyk Scanner Integrations both enable the Metadata Store. To prevent conflicts, the configuration values are slightly different based on whether the Grype Scanner Integration is installed or not. If Tanzu Application Platform is installed using the Full Profile, the Grype Scanner Integration is installed, unless it is explicitly excluded.

- If the Grype Scanner Integration is installed in the same `dev-namespace` Snyk Scanner is installed:

```

#! ...
metadataStore:
  #! The url where the Store deployment is accessible.
  #! Default value is: "https://metadata-store-app.metadata-store.svc.cluster.local:8443"
  url: "STORE-URL"
  caSecret:
    #! The name of the secret that contains the ca.crt to connect to the Store Deployment.
    #! Default value is: "app-tls-cert"
    name: "CA-SECRET-NAME"
    importFromNamespace: "" #! since both Snyk and Grype both enable store, one must leave importFromNamespace blank
  #! authSecret is for multicluster configurations.
  authSecret:
    #! The name of the secret that contains the auth token to authenticate to the Store Deployment.
    name: "AUTH-SECRET-NAME"
    importFromNamespace: "" #! since both Snyk and Grype both enable store, one must leave importFromNamespace blank

```

- If the Grype Scanner Integration is not installed in the same `dev-namespace` Snyk Scanner is installed:

```

#! ...
metadataStore:
  #! The url where the Store deployment is accessible.
  #! Default value is: "https://metadata-store-app.metadata-store.svc.cluster.local:8443"
  url: "STORE-URL"
  caSecret:
    #! The name of the secret that contains the ca.crt to connect to the Store Deployment.
    #! Default value is: "app-tls-cert"
    name: "CA-SECRET-NAME"
    #! The namespace where the secrets for the Store Deployment live.
    #! Default value is: "metadata-store"
    importFromNamespace: "STORE-SECRETS-NAMESPACE"
  #! authSecret is for multicluster configurations.
  authSecret:
    #! The name of the secret that contains the auth token to authenticate to the Store Deployment.
    name: "AUTH-SECRET-NAME"
    #! The namespace where the secrets for the Store Deployment live.
    importFromNamespace: "STORE-SECRETS-NAMESPACE"

```

Without SCST - Store Integration: The SCST - Store integration is enabled by default. If you don't want to use this integration, deactivate the integration by appending the following field to the `values.yaml` file:

```

# ...
metadataStore:
  url: "" # Configuration is moved, so set this string to empty.

```

Sample ScanPolicy for Snyk in SPDX JSON format

1. Create a ScanPolicy YAML with a Rego file for scanner output in the SPDX JSON format. Here is a sample scan policy resource:

```

apiVersion: scanning.apps.tanzu.vmware.com/v1beta1
kind: ScanPolicy
metadata:

```

```

name: snyk-scan-policy
labels:
  'app.kubernetes.io/part-of': 'enable-in-gui'
spec:
  regoFile: |
    package main

    # Accepted Values: "Critical", "High", "Medium", "Low", "Negligible", "UnknownSeverity"
    notAllowedSeverities := ["Critical", "High", "UnknownSeverity"]
    ignoreCves := []

    contains(array, elem) = true {
      array[_] = elem
    } else = false { true }

    isSafe(match) {
      fails := contains(notAllowedSeverities, match.relationships[_].ratedBy.rating[_].severity)
      not fails
    }

    isSafe(match) {
      ignore := contains(ignoreCves, match.id)
      ignore
    }

    deny[msg] {
      vuln := input.vulnerabilities[_]
      ratings := vuln.relationships[_].ratedBy.rating[_].severity
      comp := vuln.relationships[_].affect.to[_]
      not isSafe(vuln)
      msg = sprintf("CVE %s %s %s", [comp, vuln.id, ratings])
    }

```

2. Apply the YAML file by running:

```
kubectl apply -n $DEV_NAMESPACE -f SCAN-POLICY-YAML
```



Note

The Snyk Scanner integration is only available for an image scan, not a source scan.

After all prerequisites are completed, follow the steps in [Install another scanner for Supply Chain Security Tools - Scan](#) to install the Snyk Scanner.

Prerequisites for Carbon Black Scanner for Supply Chain Security Tools - Scan (Beta)

This topic describes prerequisites you must complete to install Supply Chain Security Tools - Scan (Carbon Black Scanner) from the Tanzu Application Platform package repository. The Carbon Black Scanner integration is only available for an image scan, not a source scan.



Important

Carbon Black's image scanning capability is in beta. Carbon Black might only return a partial list of CVEs when scanning Buildpack images.

Prepare the Carbon Black Scanner configuration

To prepare the Carbon Black Scanner configuration before you install any scanners:

1. Obtain a Carbon Black API Token from Carbon Black Cloud.
2. Create a Carbon Black secret YAML file and insert the Carbon Black API configuration key. Obtain all values from your CBC console.

```
apiVersion: v1
kind: Secret
metadata:
  name: CARBONBLACK-CONFIG-SECRET
  namespace: my-apps
stringData:
  cbc_api_id: CBC-API-ID
  cbc_api_key: CBC-API-KEY
  cbc_org_key: CBC-ORG-KEY
  cbc_saas_url: CBC-SAAS-URL
```

Where:

- `CBC-API-ID` is the API ID obtained from CBC.
 - `CBC-API-KEY` is the API Key obtained from CBC.
 - `CBC-ORG-KEY` is the Org Key of your CBC organization.
 - `CBC-SAAS-URL` is the CBC Backend URL.
3. Apply the Carbon Black secret YAML file by running:

```
kubectl apply -f YAML-FILE
```

Where `YAML-FILE` is the name of the Carbon Black secret YAML file you created.

4. Define the `--values-file` flag to customize the default configuration. Create a `values.yaml` file by using the following configuration:

You must define the following fields in the `values.yaml` file for the Carbon Black Scanner configuration. You can add fields as needed to enable or deactivate behaviors. You can append the values to this file as shown later in this topic.

```
---
namespace: DEV-NAMESPACE
targetImagePullSecret: TARGET-REGISTRY-CREDENTIALS-SECRET
carbonBlack:
  configSecret:
    name: CARBONBLACK-CONFIG-SECRET
```

- `DEV-NAMESPACE` is your developer namespace.



Important

To use a namespace other than the default namespace, ensure that the namespace exists before you install. If the namespace does not exist, the scanner installation fails.

- `TARGET-REGISTRY-CREDENTIALS-SECRET` is the name of the secret that contains the credentials to pull an image from a private registry for scanning.

- `CARBONBLACK-CONFIG-SECRET` is the name of the secret you created that contains the Carbon Black configuration to connect to CBC. This field is required.

The Carbon Black Scanner integration can work with or without the SCST - Store integration. The `values.yaml` file is slightly different for each configuration.

SCST - Store integration

To Integrate:

1. Do one of the following procedures:
 - [Use the Supply Chain Security Tools - Store](#)
 - [Without using the Supply Chain Security Tools - Store](#)
2. Apply the YAML.

Using SCST - Store Integration

To persist the results found by the Carbon Black Scanner, you can enable the SCST - Store integration by appending the fields to the `values.yaml` file.

The Grype and Carbon Black Scanner Integrations both enable the Metadata Store. To prevent conflicts, the configuration values are slightly different based on whether the Grype Scanner Integration is installed or not. If Tanzu Application Platform was installed using the Full Profile, the Grype Scanner Integration was installed, unless it was explicitly excluded.

- If the Grype Scanner Integration is installed in the same `dev-namespace` Carbon Black Scanner is installed:

```
#! ...
metadataStore:
  #! The url where the Store deployment is accessible.
  #! Default value is: "https://metadata-store-app.metadata-store.svc.cluster.local:8443"
  url: "STORE-URL"
  caSecret:
    #! The name of the secret that contains the ca.crt to connect to the Store Deployment.
    #! Default value is: "app-tls-cert"
    name: "CA-SECRET-NAME"
    importFromNamespace: "" #! since both Carbon Black and Grype both enable store, one must leave importFromNamespace blank
  #! authSecret is for multicluster configurations.
  authSecret:
    #! The name of the secret that contains the auth token to authenticate to the Store Deployment.
    name: "AUTH-SECRET-NAME"
    importFromNamespace: "" #! since both Carbon Black and Grype both enable store, one must leave importFromNamespace blank
```

- If the Grype Scanner Integration is not installed in the same `dev-namespace` Carbon Black Scanner is installed:

```
#! ...
metadataStore:
  #! The url where the Store deployment is accessible.
  #! Default value is: "https://metadata-store-app.metadata-store.svc.cluster.local:8443"
  url: "STORE-URL"
  caSecret:
    #! The name of the secret that contains the ca.crt to connect to the Store
```

```
Deployment.
  #! Default value is: "app-tls-cert"
  name: "CA-SECRET-NAME"
  #! The namespace where the secrets for the Store Deployment live.
  #! Default value is: "metadata-store"
  importFromNamespace: "STORE-SECRETS-NAMESPACE"
  #! authSecret is for multicluster configurations.
  authSecret:
    #! The name of the secret that contains the auth token to authenticate to the
    #! Store Deployment.
    name: "AUTH-SECRET-NAME"
    #! The namespace where the secrets for the Store Deployment live.
    importFromNamespace: "STORE-SECRETS-NAMESPACE"
```

Without SCST - Store Integration

The SCST - Store integration is enabled by default. If you don't want to use this integration, explicitly deactivate the integration by appending the following field to the `values.yaml` file:

```
# ...
metadataStore:
  url: "" # Disable Supply Chain Security Tools - Store integration
```

Sample ScanPolicy in CycloneDX format

1. Create a ScanPolicy YAML with a Rego file for scanner output in the CycloneDX format. For example:

```
apiVersion: scanning.apps.tanzu.vmware.com/v1beta1
kind: ScanPolicy
metadata:
  name: scan-policy
  labels:
    'app.kubernetes.io/part-of': 'enable-in-gui'
spec:
  regoFile: |
    package main

    # Accepted Values: "Critical", "High", "Medium", "Low", "Negligible", "UnknownSeverity"
    notAllowedSeverities := ["Critical", "High", "UnknownSeverity"]
    ignoreCves := []

    contains(array, elem) = true {
      array[_] = elem
    } else = false { true }

    isSafe(match) {
      severities := { e | e := match.ratings.rating.severity } | { e | e := match.ratings.rating[_].severity }
      some i
      fails := contains(notAllowedSeverities, severities[i])
      not fails
    }

    isSafe(match) {
      ignore := contains(ignoreCves, match.id)
      ignore
    }

    deny[msg] {
      comps := { e | e := input.bom.components.component } | { e | e := input.bom.components.component[_] }
```

```

    some i
    comp := comps[i]
    vulns := { e | e := comp.vulnerabilities.vulnerability } | { e | e := comp.vulnerabilities.vulnerability[_] }
    some j
    vuln := vulns[j]
    ratings := { e | e := vuln.ratings.rating.severity } | { e | e := vuln.ratings.rating[_].severity }
    not isSafe(vuln)
    msg = sprintf("CVE %s %s %s", [comp.name, vuln.id, ratings])
  }

```

2. Apply the YAML:

```
kubectl apply -n $DEV_NAMESPACE -f SCAN-POLICY-YAML
```

After you complete all prerequisites, install the Carbon Black Scanner. See [Install another scanner for Supply Chain Security Tools - Scan](#).

Prerequisites for Prisma Scanner for Supply Chain Security Tools - Scan (Alpha)

This topic describes prerequisites you must complete to install SCST - Scan (Prisma) from the VMware package repository.



Important

This integration is in Alpha, which means that it is still in active development by the Tanzu Practices Global Tech Team and might be subject to change at any point. Users might encounter unexpected behavior.

Verify the latest alpha package version

Run this command to output a list of available tags:

```
imgpkg tag list -i projects.registry.vmware.com/tanzu_practice/tap-scanners-package/prisma-repo-scanning-bundle | sort -V
```

Use the latest version returned in place of the sample version in this topic. For example, **0.1.5-alpha.13** in the following output.

```

imgpkg tag list -i projects.registry.vmware.com/tanzu_practice/tap-scanners-package/prisma-repo-scanning-bundle | sort -V
0.1.4-alpha.11
0.1.4-alpha.12
0.1.4-alpha.15
0.1.5-alpha.11
0.1.5-alpha.12
0.1.5-alpha.13

```

Relocate images to a registry

You must relocate the images from tanzu.packages.broadcom.com to your own container image registry before installing. The Prisma Scanner is in the Alpha development phase, and not packaged as part of Tanzu Application Platform. It is hosted on tanzu.packages.broadcom.com.

For information about supported registries, see each registry's documentation.

To relocate images from `tanzu.packages.broadcom.com` to your registry:

1. Retrieve your Broadcom registry API token:
 1. Sign in to the [Broadcom Support Portal](#).
 2. Go to [Tanzu Application Platform \(TAP\)](#) and expand the **VMware Tanzu Application Platform** dropdown.
 3. Click the Token Download icon next to the Tanzu Application Platform version you want to download.

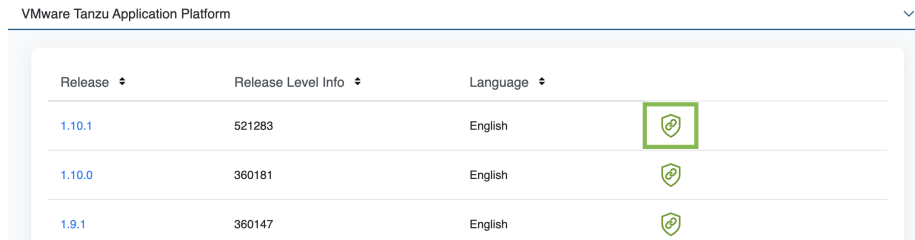

4. Follow the instructions in the dialog box. Save the token as a variable named `MY_BROADCOM_SUPPORT_ACCESS_TOKEN`. For example:

```
export MY_BROADCOM_SUPPORT_ACCESS_TOKEN=API-TOKEN
```

Where `API-TOKEN` is your token from the Broadcom Support Portal.

2. Set up environment variables for installation:

```
export IMGPKG_REGISTRY_HOSTNAME_0=tanzu.packages.broadcom.com
export IMGPKG_REGISTRY_USERNAME_0=MY-BROADCOM-SUPPORT-USERNAME
export IMGPKG_REGISTRY_PASSWORD_0=${MY_BROADCOM_SUPPORT_ACCESS_TOKEN}
export INSTALL_REGISTRY_HOSTNAME=MY-REGISTRY
export INSTALL_REGISTRY_USERNAME=MY-REGISTRY-USER
export INSTALL_REGISTRY_PASSWORD=MY-REGISTRY-PASSWORD
export VERSION=VERSION-NUMBER
export INSTALL_REPO=TARGET-REPOSITORY
```

Where:

- `MY-BROADCOM-SUPPORT-USERNAME` is the user with access to the images in `tanzu.packages.broadcom.com`.
- `MY-REGISTRY` is your own registry.
- `MY-REGISTRY-USER` is the user with write access to `MY-REGISTRY`.
- `MY-REGISTRY-PASSWORD` is the password for `MY-REGISTRY-USER`.
- `VERSION-NUMBER` is your Prisma Scanner version. For example, `0.1.4-alpha.12`.
- `TARGET-REPOSITORY` is your target repository, a directory or repository on `MY-REGISTRY` that serves as the location for the installation files for Prisma Scanner.

3. Install the Carvel tool `imgpkg` CLI. See [Deploying Cluster Essentials](#).
4. Relocate images with the `imgpkg` CLI by running:

```
imgpkg copy -b projects.registry.vmware.com/tanzu_practice/tap-scanners-package/prisma-repo-scanning-bundle:${VERSION} \
--to-repo ${INSTALL_REGISTRY_HOSTNAME}/${INSTALL_REPO}/prisma-repo-scanning-bundle
```

Add the Prisma Scanner package repository

Tanzu CLI packages are available on repositories. Adding the Prisma Scanning package repository makes the Prisma Scanning bundle and its packages available for installation.

VMware recommends installing the Prisma Scanner objects in the existing `tap-install` namespace to keep the Prisma Scanner grouped logically with the other Tanzu Application Platform components.

1. Add the Prisma Scanner package repository to the cluster by running:

```
tanzu package repository add prisma-scanner-repository \
  --url ${INSTALL_REGISTRY_HOSTNAME}/${INSTALL_REPO}/prisma-repo-scanning-bundle:${VERSION} \
  --namespace tap-install
```

2. Get the status of the Prisma Scanner package repository, and ensure that the status updates to `Reconcile succeeded` by running:

```
tanzu package repository get prisma-scanner-repository --namespace tap-install
```

For example:

```
$ tanzu package repository get prisma-scanning-repository --namespace tap-install
- Retrieving repository prisma-scanner-repository...
NAME:          prisma-scanner-repository
VERSION:       71091125
REPOSITORY:    projects.registry.vmware.com/tanzu_practice/tap-scanners-package/prisma-repo-scanning-bundle
TAG:           0.1.4-alpha.12
STATUS:        Reconcile succeeded
REASON:
```

3. List the available packages by running:

```
tanzu package available list --namespace tap-install
```

For example:

```
$ tanzu package available list --namespace tap-install
/ Retrieving available packages...
NAME                                DISPLAY-NAME
SHORT-DESCRIPTION
prisma.scanning.apps.tanzu.vmware.com Prisma for Supply Chain Security Tools - Scan
prisma                                Default scan templates using Prisma
```

Prepare the Prisma Scanner configuration

Before installing the Prisma scanner, you must create the configuration and a Kubernetes secret that contains credentials to access Prisma Cloud.

Obtain Console URL and Access Keys and Token

The Prisma Scanner supports two methods of authentication:

- Basic authentication with API Key and Secret
- Token-based Authentication

The steps to configure both are outlined to allow you to decide which option you use.

**Note**

The token method issued by Prisma Cloud has a expiration of 1 hour, so it requires frequent refreshing.

To obtain your Prisma Compute Console URL and Access Keys and Token. See [Access keys](#) in the Palo Alto Networks documentation.

**Note**

Generated tokens expire after an hour.

Access key and secret authentication

To create a Prisma secret, use the following instructions.

1. Create a Prisma secret YAML file and insert the base64 encoded Prisma API token into the `prisma_token`:

```
apiVersion: v1
kind: Secret
metadata:
  name: PRISMA-ACCESS-KEY-SECRET
  namespace: APP-NAME
data:
  username: BASE64-PRISMA-ACCESS-KEY-ID
  password: BASE64-PRISMA-ACCESS-KEY-PASSWORD
```

Where:

- `PRISMA-ACCESS-KEY-SECRET` is the name of your Prisma token secret.
- `APP-NAME` is the namespace you want to use.
- `BASE64-PRISMA-ACCESS-KEY-ID` is your base64 encoded Prisma Access Key ID.
- `BASE64-PRISMA-ACCESS-KEY-PASSWORD` is your base64 encoded Prisma Access Key Password.

2. Apply the Prisma secret YAML file by running:

```
kubectl apply -f YAML-FILE
```

Where `YAML-FILE` is the name of the Prisma secret YAML file you created.

3. Define the `--values-file` flag to customize the default configuration. You must define the following fields in the `values.yaml` file for the Prisma Scanner configuration. You can add fields to activate or deactivate behaviors. You can append the values to this file as shown later in this topic. Create a `values.yaml` file by using the following configuration:

```
---
namespace: DEV-NAMESPACE
targetImagePullSecret: TARGET-REGISTRY-CREDENTIALS-SECRET
prisma:
  url: PRISMA-URL
  basicAuth:
    name: PRISMA-ACCESS-KEY-SECRET
```

Where:

- `DEV-NAMESPACE` is your developer namespace. To use a namespace other than the default namespace, ensure that the namespace exists before you install. If the namespace does not exist, the scanner installation fails.
- `TARGET-REGISTRY-CREDENTIALS-SECRET` is the name of the secret that contains the credentials to pull an image from a private registry for scanning.
- `PRISMA-URL` is the FQDN of your Twistlock server.
- `PRISMA-CONFIG-SECRET` is the name of the secret you created that contains the Prisma configuration to connect to Prisma. This field is required.

The Prisma integration can work with or without the SCST - Store integration. The `values.yaml` file is slightly different for each configuration.

Access Token Authentication

1. Create a Prisma secret YAML file and insert the base64 encoded Prisma API token into the `prisma_token`:

```
apiVersion: v1
kind: Secret
metadata:
  name: PRISMA-TOKEN-SECRET
  namespace: APP-NAME
data:
  prisma_token: BASE64-PRISMA-API-TOKEN
```

Where:

- `PRISMA-TOKEN-SECRET` is the name of your Prisma token secret.
- `APP-NAME` is the namespace you want to use.
- `BASE64-PRISMA-API-TOKEN` is the name of your base64 encoded Prisma API token.

2. Apply the Prisma secret YAML file by running:

```
kubectl apply -f YAML-FILE
```

Where `YAML-FILE` is the name of the Prisma secret YAML file you created.

3. Define the `--values-file` flag to customize the default configuration. You must define the following fields in the `values.yaml` file for the Prisma Scanner configuration. You can add fields as needed to activate or deactivate behaviors. You can append the values to this file as shown later in this topic. Create a `values.yaml` file by using the following configuration:

```
---
namespace: DEV-NAMESPACE
targetImagePullSecret: TARGET-REGISTRY-CREDENTIALS-SECRET
prisma:
  url: PRISMA-URL
  tokenSecret:
    name: PRISMA-CONFIG-SECRET
```

Where:

- `DEV-NAMESPACE` is your developer namespace. To use a namespace other than the default namespace, ensure that the namespace exists before you install. If the namespace does not exist, the scanner installation fails.
- `TARGET-REGISTRY-CREDENTIALS-SECRET` is the name of the secret that contains the credentials to pull an image from a private registry for scanning.

- `PRISMA-URL` is the FQDN of your Twistlock server.
- `PRISMA-CONFIG-SECRET` is the name of the secret you created that contains the Prisma configuration to connect to Prisma. This field is required.

SCST - Store integration

The Prisma Scanner integration can work with or without the SCST - Store integration. The `values.yaml` file is slightly different for each configuration.

When using SCST - Store integration, to persist the results found by the Prisma Scanner, you can enable the SCST - Store integration by appending the fields to the `values.yaml` file.

The Grype, Snyk, and Prisma Scanner Integrations enable the Metadata Store. To prevent conflicts, the configuration values are slightly different based on whether the Grype Scanner Integration is installed or not. If Tanzu Application Platform is installed using the Full Profile, the Grype Scanner Integration is installed unless it is explicitly excluded.

Multiple Scanners installed

In order to find your CA secret name and authentication token secret name as needed for your `values.yaml` when installing Prisma Scanner you must look at the configuration of a prior installed scanner in the same namespace as it already exists.

For information about how the scanner was likely initially created, see [Set up multicluster Supply Chain Security Tools \(SCST\) - Store](#).

```
#! ...
metadataStore:
  #! The url where the Store deployment is accessible.
  #! Default value is: "https://metadata-store-app.metadata-store.svc.cluster.local:8443"
  url: "STORE-URL"
  caSecret:
    #! The name of the secret that contains the ca.crt to connect to the Store Deployment.
    #! Default value is: "app-tls-cert"
    name: "CA-SECRET-NAME"
    importFromNamespace: "" #! since both Prisma and Grype/Snyk both enable store, one must leave importFromNamespace blank
  #! authSecret is for multicluster configurations.
  authSecret:
    #! The name of the secret that contains the auth token to authenticate to the Store Deployment.
    name: "AUTH-SECRET-NAME"
    importFromNamespace: "" #! since both Prisma and Grype/Snyk both enable store, one must leave importFromNamespace blank
```

Where:

- `STORE-URL` is the URL where the Store deployment is accessible.
- `CA-SECRET-NAME` is the name of the secret that contains the `ca.crt` to connect to the Store Deployment. Default is `app-tls-cert`.
- `AUTH-SECRET-NAME` is the name of the secret that contains the authentication token to authenticate to the Store Deployment.

Prisma Only Scanner Installed

For information about creating and exporting secrets for the Metadata Store CA and authentication token referenced in the data values when installing Prisma Scanner, see [Set up multicluster Supply](#)

Chain Security Tools (SCST) - Store.

An example `values.yaml` when no other scanner integrations installed in the same `dev-namespace` where the Prisma Scanner is installed:

```
#! ...
metadataStore:
  #! The url where the Store deployment is accessible.
  #! Default value is: "https://metadata-store-app.metadata-store.svc.cluster.local:8443"
  url: "STORE-URL"
  caSecret:
    #! The name of the secret that contains the ca.crt to connect to the Store Deployment.
    #! Default value is: "app-tls-cert"
    name: "CA-SECRET-NAME"
    #! The namespace where the secrets for the Store Deployment live.
    #! Default value is: "metadata-store"
    importFromNamespace: "STORE-SECRETS-NAMESPACE"
  #! authSecret is for multicluster configurations.
  authSecret:
    #! The name of the secret that contains the auth token to authenticate to the Store Deployment.
    name: "AUTH-SECRET-NAME"
    #! The namespace where the secrets for the Store Deployment live.
    importFromNamespace: "STORE-SECRETS-NAMESPACE"
```

Where:

- `STORE-URL` is the URL where the Store deployment is accessible.
- `CA-SECRET-NAME` is the name of the secret that contains the `ca.crt` to connect to the Store Deployment. Default is `app-tls-cert`.
- `STORE-SECRETS-NAMESPACE` is the namespace where the secrets for the Store Deployment live. Default is `metadata-store`.
- `AUTH-SECRET-NAME` is the name of the secret that contains the authentication token to authenticate to the Store Deployment.

No Store Integration

If you do not want to enable the SCST - Store integration, explicitly deactivate the integration by appending the following field to the `values.yaml` file that is enabled by default:

```
# ...
metadataStore:
  url: "" # Deactivate Supply Chain Security Tools - Store integration
```

Prepare the ScanPolicy

To prepare the ScanPolicy, use the instructions in the following sections.

Sample ScanPolicy using Prisma Policies

The following sample ScanPolicy allows you to control whether the SupplyChain passes or fails based on the compliance and vulnerability rules configured in the Prisma Compute Console.

The policy reads the `complianceScanPassed` and `vulnerabilityScanPassed` fields returned from Prisma scanner output to control the results of the scan.

```

apiVersion: scanning.apps.tanzu.vmware.com/v1beta1
kind: ScanPolicy
metadata:
  name: prisma-scan-policy
  labels:
    'app.kubernetes.io/part-of': 'enable-in-gui'
spec:
  regoFile: |
    package main

    import future.keywords.in

    deny[msg] {
      vulnerabilityAndComplianceScanResults := {e | e := input.bom.metadata.properties.property[_]}
      some result in vulnerabilityAndComplianceScanResults
      failedScans:= "false" in result
      failedScans
      vulnerabilityMessages := { message |
        components := {e | e := input.bom.components.component} | {e | e := input.bom.components.component[_]}
        some component in components
        vulnerabilities := {e | e := component.vulnerabilities.vulnerability} | {e | e := component.vulnerabilities.vulnerability[_]}
        some vulnerability in vulnerabilities
        ratings := {e | e := vulnerability.ratings.rating.severity} | {e | e := vulnerability.ratings.rating[_].severity}
        formattedRatings := concat(", ", ratings)
        message := sprintf("Vulnerability - Component: %s CVE: %s Severity: %s", [component.name, vulnerability.id, formattedRatings])
      }
      complianceMessages := { message |
        compliances := {e | e := input.bom.metadata.component.compliances.compliance} | {e | e := input.bom.metadata.component.compliances.compliance[_]}
        some compliance in compliances
        message := sprintf("Compliance - %s \nId: %s Severity: %s Category: %s", [compliance.title, compliance.id, compliance.severity, compliance.category])
      }
      combinedMessages := complianceMessages | vulnerabilityMessages
      some message in combinedMessages
      msg := message
    }

```

Sample ScanPolicy using Local Policies

The following sample ScanPolicy allows you to control whether the SupplyChain passes or fails based on the Prisma Scanner CycloneDX vulnerability results returned from the Prisma Scanner.

```

apiVersion: scanning.apps.tanzu.vmware.com/v1beta1
kind: ScanPolicy
metadata:
  name: prisma-scan-policy
  labels:
    'app.kubernetes.io/part-of': 'enable-in-gui'
spec:
  regoFile: |
    package main

    # Accepted Values: "Critical", "High", "Medium", "Low", "Negligible", "UnknownSeverity"
    notAllowedSeverities := ["Critical", "High", "UnknownSeverity"]
    ignoreCves := []

    contains(array, elem) = true {

```

```

    array[_] = elem
  } else = false { true }

  isSafe(match) {
    severities := { e | e := match.ratings.rating.severity } | { e | e := match.rati
ngs.rating[_].severity }
    some i
    fails := contains(notAllowedSeverities, severities[i])
    not fails
  }

  isSafe(match) {
    ignore := contains(ignoreCves, match.id)
    ignore
  }

  deny[msg] {
    comps := { e | e := input.bom.components.component } | { e | e := input.bom.comp
onents.component[_] }
    some i
    comp := comps[i]
    vulns := { e | e := comp.vulnerabilities.vulnerability } | { e | e := comp.vulne
rabilities.vulnerability[_] }
    some j
    vuln := vulns[j]
    ratings := { e | e := vuln.ratings.rating.severity } | { e | e := vuln.ratings.r
ating[_].severity }
    not isSafe(vuln)
    msg = sprintf("CVE %s %s %s", [comp.name, vuln.id, ratings])
  }

```

Apply the YAML:

```
kubectl apply -n $DEV-NAMESPACE -f SCAN-POLICY-YAML
```

Where:

- `DEV-NAMESPACE` is the name of the developer namespace you want to use.
- `SCAN-POLICY-YAML` is the name of your SCST - Scan YAML.

Install Prisma Scanner

After all prerequisites are completed, install the Prisma Scanner. See [Install another scanner for Supply Chain Security Tools - Scan](#).

Self-Signed Registry Certificate

When attempting to pull an image from a registry with a self-signed certificate during image scans additional configuration is necessary.

Tanzu Application Platform Values Shared CA

If your `tap-values.yaml` used during install has the following shared section filled out, Prisma Scanner uses this and enable it to connect to your registry without additional configuration.

```

shared:
  ca_cert_data: | # To be passed if using custom certificates.
    -----BEGIN CERTIFICATE-----
    MIIFXzCCA0egAwIBAgIJAJYm37SFocj1MA0GCSqGSIb3DQEBAQUAMEY...
    -----END CERTIFICATE-----

```

Secret within Developer Namespace

1. Create a secret that holds the registry's CA certificate data.

An example of the secret:

```
apiVersion: v1
kind: Secret
metadata:
  name: prisma-registry-cert
  namespace: dev
type: Opaque
data:
  ca_cert_data: BASE64_CERT
```

2. Update your Prisma Scanner install values.yaml. Add `caCertSecret` to the root of your `prisma-values.yaml` when installing Prisma Scanner. Example:

```
namespace: dev
targetImagePullSecret: tap-registry
caCertSecret: prisma-registry-cert
```

Connect to Prisma through a Proxy

To connect to Prisma through a proxy, you must add `environmentVariables` configuration to your `prisma-values.yaml`. All valid container `env` configurations are supported.

For example:

```
namespace: dev
targetImagePullSecret: tap-registry
environmentVariables:
- name: HTTP_PROXY
  value: "test.proxy.com"
- name: HTTPS_PROXY
  value: "test.proxy.com"
- name: NO_PROXY
  value: "127.0.0.1,.svc,.svc.cluster.local,demo.app"
```

Known Limits

OpenShift is not supported.

Install Trivy for Supply Chain Security Tools - Scan (alpha)

This topic describes how you can install SCST - Scan (Trivy) from the VMware package repository.



Important

This integration is in Alpha, which means that it is still in active development by the Tanzu Practice Global Tech Team and might be subject to change at any point. Users might encounter unexpected behavior.

Verify the latest alpha package version

Run the following command to output a list of available tags.

```
imgpkg tag list -i projects.registry.vmware.com/tanzu_practice/tap-scanners-package/trivy-repo-scanning-bundle | sort -V
```

For example:

```
imgpkg tag list -i projects.registry.vmware.com/tanzu_practice/tap-scanners-package/trivy-repo-scanning-bundle | sort -V

0.1.4-alpha.6
0.1.4-alpha.1
0.1.4-alpha.3
0.1.4-alpha.5
0.1.4-alpha.6
```

In this topic, use the latest version returned by the command above.

Relocate images to a registry

You must relocate the images from tanzu.packages.broadcom.com to your own container image registry before installing.

Trivy is in the Alpha development phase, is not packaged as part of the Tanzu Application Platform package, and is hosted on tanzu.packages.broadcom.com.

For information about supported registries, see the registry's documentation.

To relocate images from the VMware Project Registry to your registry:

1. Install Docker if it is not already installed.
2. Set up environment variables for installation by running:

```
export INSTALL_REGISTRY_USERNAME=MY-REGISTRY-USER
export INSTALL_REGISTRY_PASSWORD=MY-REGISTRY-PASSWORD
export INSTALL_REGISTRY_HOSTNAME=MY-REGISTRY
export VERSION=VERSION-NUMBER
export INSTALL_REPO=TARGET-REPOSITORY
```

Where:

- [MY-REGISTRY-USER](#) is the user with write access to [MY-REGISTRY](#).
 - [MY-REGISTRY-PASSWORD](#) is the password for [MY-REGISTRY-USER](#).
 - [MY-REGISTRY](#) is your own registry.
 - [VERSION](#) is your Trivy version. For example, [0.1.4-alpha.6](#).
 - [TARGET-REPOSITORY](#) is your target repository, a directory or repository on [MY-REGISTRY](#) that serves as the location for the installation files for Trivy.
3. Install the Carvel tool `imgpkg` CLI. See [Deploying Cluster Essentials v1.4](#).
 4. Relocate the images with the `imgpkg` CLI by running:

```
imgpkg copy -b projects.registry.vmware.com/tanzu_practice/tap-scanners-package/trivy-repo-scanning-bundle:${VERSION} \
--to-repo ${INSTALL_REGISTRY_HOSTNAME}/${INSTALL_REPO}/trivy-repo-scanning-bundle
```



Note

The VMware project repository does not require authentication, so you don't need to perform a Docker login.

Add Trivy package repository

Tanzu CLI packages are available on repositories. Adding the Trivy scanning package repository makes the Trivy scanning bundle and its packages available for installation.

VMware recommends installing Trivy objects in the existing `tap-install` namespace to keep Trivy grouped logically with the other Tanzu Application Platform components.

1. Add Trivy package repository to the cluster by running:

```
tanzu package repository add trivy-scanner-repository \
  --url ${INSTALL_REGISTRY_HOSTNAME}/${INSTALL_REPO}/trivy-repo-scanning-bundle:$VERSION \
  --namespace tap-install
```

2. Get the status of Trivy package repository, and ensure that the status updates to `Reconcile succeeded` by running:

```
tanzu package repository get trivy-scanner-repository --namespace tap-install
```

For example:

```
tanzu package repository get trivy-scanner-repository --namespace tap-install

NAME:          trivy-scanner-repository
VERSION:       7750726
REPOSITORY:    projects.registry.vmware.com/tanzu_practice/tap-scanners-package/trivy-repo-scanning-bundle
TAG:           0.1.4-alpha.6
STATUS:        Reconcile succeeded
REASON:
```

3. List the available packages by running:

```
tanzu package available list --namespace tap-install
```

For example:

```
$ tanzu package available list --namespace tap-install
/ Retrieving available packages...
NAME                                DISPLAY-NAME
SHORT-DESCRIPTION
trivy.scanning.apps.tanzu.vmware.com  trivy
Default scan templates using Trivy
```

Prepare Trivy configuration

Before installing the Trivy, you must create the configuration necessary to install Trivy.

1. Define the `--values-file` flag to customize the default configuration. You must define the following fields in the `values.yaml` file for the Trivy Scanner configuration. You can add fields as needed to activate or deactivate behaviors. You can append the values to the `values.yaml` file. Create a `values.yaml` file by using the following configuration:

```
---
namespace: DEV-NAMESPACE
```

```
targetImagePullSecret: TARGET-REGISTRY-CREDENTIALS-SECRET
targetSourceSshSecret: TARGET-SOURCE-SSH-SECRET
```

Where:

- `DEV-NAMESPACE` is your developer namespace. To use a namespace other than the default namespace, ensure that the namespace exists before you install. If the namespace does not exist, the scanner installation fails.
- `TARGET-REGISTRY-CREDENTIALS-SECRET` is the name of the secret that contains the credentials to pull an image from a private registry for scanning.
- `TARGET-SOURCE-SSH-SECRET` is the name of the secret containing SSH credentials for cloning private repositories

2. To see all available values, run the following command using the version that you want:

```
VERSION="0.1.4-alpha.6"
tanzu package available get trivy.scanning.apps.tanzu.vmware.com/$VERSION --values-schema -n tap-install
```

Example output:

```
KEY                                     DEFAULT
TYPE      DESCRIPTION
environmentVariables                    <nil>
<nil> Environment Variables you want added to the scan container to impact trivy behavior
resources.limits.cpu                     1000m
string Limits describes the maximum amount of cpu resources allowed.
resources.requests.cpu                   250m
string Requests describes the minimum amount of cpu resources required.
resources.requests.memory                 128Mi
string Requests describes the minimum amount of memory resources
scanner.docker.server
string <nil>
scanner.docker.username
string <nil>
scanner.docker.password
string <nil>
scanner.pullSecret
string <nil>
scanner.serviceAccount                   trivy-scanner
string Name of scan pod's service ServiceAccount
scanner.serviceAccountAnnotations        <nil>
<nil> Annotations added to ServiceAccount
trivy.cli.image.additionalArguments
string additional arguments to be appended to the image scan command
trivy.cli.plugins.aqua.repositoryUrl
string location of the aqua plugin tar in an OCI registry to be used in place of the embedded version
trivy.cli.repositoryUrl
string location of the CLI tar in an OCI registry to be used in place of the embedded version
trivy.cli.source.additionalArguments
string additional arguments to be appended to the fs scan command
trivy.db.repositoryUrl
string location of the vulnerability database in an OCI registry to be used as the download location prior to running a scan
caCertSecret
string Reference to the secret containing the registry ca cert set as ca_cert_data
metadataStore.authSecret.importFromNamespace
string Namespace from which to import the Insight Metadata Store auth_token
metadataStore.authSecret.name
```



```

string Name of deployed Secret with key auth_token
metadataStore.caSecret.importFromNamespace metadata-store
string Namespace from which to import the Insight Metadata Store CA Cert
metadataStore.caSecret.name app-tls-cert
string Name of deployed Secret with key ca.crt holding the CA Cert of the Insight Metadata Store
metadataStore.clusterRole metadata-store-read-write
string Name of the deployed ClusterRole for read/write access to the Insight Metadata Store deployed in the same cluster
metadataStore.url https://metadata-store-app.metadata-store.svc.cluster.local:8443 string Url of the Insight Metadata Store
namespace default
string Deployment namespace for the Scan Templates
targetImagePullSecret
string Reference to the secret used for pulling images from private registry
targetSourceSshSecret
string Reference to the secret containing SSH credentials for cloning private repositories

```

SCST - Store integration

Trivy integration can work with or without the SCST - Store integration. The `values.yaml` file is slightly different for each configuration.

To persist the results found by the Trivy, enable the SCST - Store integration by appending the SCST- scan fields to Trivy `values.yaml` file.

The Grype, Snyk, Prisma, Carbon Black, and Trivy integrations enable the Metadata Store. To prevent conflicts, the configuration values are slightly different based on whether another scanner integration is installed or not. If Tanzu Application Platform is installed using the Full Profile, the Grype Scanner Integration is installed unless it is explicitly excluded.

Multiple scanners installed

When installing Trivy, find your CA secret name and authentication token secret name for your `values.yaml` by looking at the configuration of a prior installed scanner in the same namespace as it already exists.

For information about how the scanner was initially created, see [Set up multicluster Supply Chain Security Tools \(SCST\) - Store](#).

The following example `values.yaml` has other scanners already installed in the same `dev-namespace` where Trivy is installed:

```

#! ...
metadataStore:
  #! The url where the Store deployment is accessible.
  #! Default value is: "https://metadata-store-app.metadata-store.svc.cluster.local:8443"
  url: "STORE-URL"
  caSecret:
    #! The name of the secret that contains the ca.crt to connect to the Store Deployment.
    #! Default value is: "app-tls-cert"
    name: "CA-SECRET-NAME"
    importFromNamespace: "" #! since both Trivy and Grype/Snyk both enable store, one must leave importFromNamespace blank
  #! authSecret is for multicluster configurations.
  authSecret:
    #! The name of the secret that contains the auth token to authenticate to the Store Deployment.
    name: "AUTH-SECRET-NAME"

```

```
importFromNamespace: "" #! since both Trivy and Grype/Snyk both enable store, one
must leave importFromNamespace blank
```

Where:

- `STORE-URL` is the URL where the Store deployment is accessible.
- `CA-SECRET-NAME` is the name of the secret that contains the `ca.crt` to connect to the Store Deployment. Default is `app-tls-cert`.
- `AUTH-SECRET-NAME` is the name of the secret that contains the authentication token to authenticate to the Store Deployment.

Trivy is the only scanner installed

For a walk through of creating and exporting secrets for the Metadata Store CA and authentication token which referenced in the data values, see [Set up multicluster Supply Chain Security Tools \(SCST\) - Store](#).

The following example `values.yaml` has no other scanner integrations installed in the same `dev-namespace` where Trivy is installed:

```
#! ...
metadataStore:
  #! The url where the Store deployment is accessible.
  #! Default value is: "https://metadata-store-app.metadata-store.svc.cluster.local:84
43"
  url: "STORE-URL"
  caSecret:
    #! The name of the secret that contains the ca.crt to connect to the Store Deploy
ent.
    #! Default value is: "app-tls-cert"
    name: "CA-SECRET-NAME"
    #! The namespace where the secrets for the Store Deployment live.
    #! Default value is: "metadata-store"
    importFromNamespace: "STORE-SECRETS-NAMESPACE"
  #! authSecret is for multicluster configurations.
  authSecret:
    #! The name of the secret that contains the auth token to authenticate to the Stor
e Deployment.
    name: "AUTH-SECRET-NAME"
    #! The namespace where the secrets for the Store Deployment live.
    importFromNamespace: "STORE-SECRETS-NAMESPACE"
```

Where:

- `STORE-URL` is the URL where the Store deployment is accessible.
- `CA-SECRET-NAME` is the name of the secret that contains the `ca.crt` to connect to the Store Deployment. Default is `app-tls-cert`.
- `STORE-SECRETS-NAMESPACE` is the namespace where the secrets for the Store Deployment live. Default is `metadata-store`.
- `AUTH-SECRET-NAME` is the name of the secret that contains the authentication token to authenticate to the Store Deployment.

No store integration

If you do not want to enable the SCST - Store integration, deactivate the integration by appending the following field to the `values.yaml` file that is enabled by default:

```
# ...
metadataStore:
```

```
url: "" # Deactivate Supply Chain Security Tools - Store integration
```

Prepare the ScanPolicy

The following sample ScanPolicy allows you to control whether the SupplyChain passes or fails based on the CycloneDX vulnerability results returned from the Trivy.

```
---
apiVersion: scanning.apps.tanzu.vmware.com/v1beta1
kind: ScanPolicy
metadata:
  name: trivy-scan-policy
  labels:
    app.kubernetes.io/part-of: enable-in-gui
spec:
  regoFile: |
    package main

    import future.keywords.in
    import future.keywords.every

    # Accepted Values: "critical", "high", "medium", "low", unknown"
    notAllowedSeverities := ["critical", "high", "unknown"]
    notAllowedSet := {x | x := notAllowedSeverities[_]}
    ignoreCves := []

    isSafe(match) {
      severities := { e | e := match.ratings.rating.severity } | { e | e := match.ra
tings.rating[_].severity }
      every severity in severities {
        not severity in notAllowedSet
      }
    }

    isIgnored(match) {
      match.id in ignoreCves
    }

    deny[msg] {
      notAllowedVulnerabilities := { vulnerability |
        vulnerabilities := {e | e := input.bom.vulnerabilities.vulnerability} | {e |
e := input.bom.vulnerabilities.vulnerability[_]}
        some vulnerability in vulnerabilities
        not isIgnored(vulnerability)
        not isSafe(vulnerability)
      }
      formattedVulnerabilityMessages := { message |
        some vulnerability in notAllowedVulnerabilities
        ratings := {e | e := vulnerability.ratings.rating.severity} | {e | e := vuln
erability.ratings.rating[_].severity}
        formattedRatings := concat(" ", ratings)
        affectedComponents := {e | e := vulnerability.affects.target.ref} | {e | e :
= vulnerability.affects.target[_].ref}
        formattedComponents := concat("\n", affectedComponents)
        message = sprintf("CVE: %s \nRatings: %s\nAffected Components: \n%s", [vu
lnerability.id, formattedRatings, formattedComponents])
      }
      some formattedVulnerabilityMessage in formattedVulnerabilityMessages
      msg := formattedVulnerabilityMessage
    }
  }
```

To prepare the ScanPolicy, run:

```
kubectl apply -n $DEV-NAMESPACE -f SCAN-POLICY-YAML
```

Where:

- `DEV-NAMESPACE` is the name of the developer namespace you want to use.
- `SCAN-POLICY-YAML` is the name of your SCST - Scan YAML.

Install Trivy

After the following prerequisites are completed, install the Trivy:

- Prerequisites listed in [Install another scanner for Supply Chain Security Tools - Scan](#).
- Install the ORAS CLI. See [the ORAS documentation](#).

Air-gap configuration

This section explains how to configure Trivy in an air-gapped environment.

For information about additional flags and configuration, see [Air-Gapped Environment](#) in the Trivy documentation.

Relocate a Trivy database to your registry



Note

Using a relocated database means you are taking responsibility for keeping it up to date to ensure that security scans are relevant. Stale databases weaken your security posture.

If you have a host with access, you can use the ORAS CLI to perform a copy.

```
oras copy -r ghcr.io/aquasecurity/trivy-db:2 registry.company.com/project_name/trivy-d
b:2 # the tag of 2 is required

Copying 4a39b38cf2fd db.tar.gz
Copied 4a39b38cf2fd db.tar.gz
Copied ghcr.io/aquasecurity/trivy-db:2 => registry.company.com/project_name/trivy-db:2
Digest: sha256:ed57874a80499e858caac27fc92e4952346eb75a2774809ee989bcd2ce48897a
```

If not, you can use the ORAS CLI to download the database and manifest and then push to your registry.

1. Download the trivy-db.

```
oras pull ghcr.io/aquasecurity/trivy-db:2
```

Example output:

```
oras pull ghcr.io/aquasecurity/trivy-db:2
Downloading 1612cc15d377 db.tar.gz
Downloaded 1612cc15d377 db.tar.gz
Pulled ghcr.io/aquasecurity/trivy-db:2
Digest: sha256:af903c7ddb7516f18b06254b6297cf53c0ece918def07322925c71d2f694860
```

2. Download the manifest for trivy-db.

```
oras manifest fetch ghcr.io/aquasecurity/trivy-db:2 > trivy-db-manifest.json
```

3. Add the media type to the manifest.

```
jq '.mediaType="application/vnd.oci.image.manifest.v1+json"' trivy-db-manifest.json > updated-trivy-db-manifest.json
```

4. Push the prior downloaded trivy-db to your registry.

```
oras push registry.company.com/project_name/trivy-db:2 ./db.tar.gz
```

Example output:

```
oras push registry.company.com/project_name/trivy-db:2 \
./db.tar.gz

Uploading 1612cc15d377 db.tar.gz
Uploaded 1612cc15d377 db.tar.gz
Pushed registry.company.com/project_name/trivy-db:2
Digest: sha256:41a7eeab8837e90d8a5afd56cfce73936e15d3db04c5294f992ecff9492971dc
```

5. Push the updated trivy-db manifest to your registry

```
oras manifest push registry.company.com/project_name/trivy-db:2 updated-trivy-db-manifest.json
```

Example output:

```
oras manifest push registry.company.com/project_name/trivy-db:2 updated-trivy-db-manifest.json
Pushed registry.company.com/project_name/trivy-db:2
Digest: sha256:b51a2fccf38e723aac1a7217ba36ca52398b2b20e3d74c9d5089dfdc9bb2f11
```

6. Clean up files by running:

```
rm trivy-db-manifest.json updated-trivy-db-manifest.json db.tar.gz
```

7. Update data values with the database repository URL. Edit your `values.yaml` to add the following:

```
trivy:
  db:
    repositoryUrl: "registry.company.com/project_name/trivy-db"
```

The URL leaves off the tag of 2.

Use another Trivy version

This section describes how to use a different Trivy CLI version than what is bundled with the package.

To use another Trivy version:

1. Install the ORAS CLI. See [the ORAS documentation](#).
2. Download the version of the CLI you are interested in from their [GitHub releases page](#). For example:
https://github.com/aquasecurity/trivy/releases/download/v0.36.0/trivy_0.36.0_Linux-64bit.tar.gz

```
wget -c https://github.com/aquasecurity/trivy/releases/download/v0.36.0/trivy_0.36.0_Linux-64bit.tar.gz -O trivy.tar.gz
```

```
Length: 48363295 (46M) [application/octet-stream]
Saving to: `trivy.tar.gz'

trivy.tar.gz 100%[==>] 46.12M 50.7MB/s in 0.9s

2023-01-25 10:47:55 (50.7 MB/s) - `trivy.tar.gz' saved [48363295/48363295]
```

3. Relocate the CLI to your registry.

Run the following to relocate the CLI to your registry:

```
oras push registry.company.com/project_name/trivy-cli:0.36.0 \
--artifact-type trivy/cli \
./trivy.tar.gz:application/gzip

Uploading 121f4d8282aa trivy.tar.gz
Uploaded 121f4d8282aa trivy.tar.gz
Pushed registry.company.com/project_name/trivy-cli:0.36.0
Digest: sha256:5bdb18378e8f66a72f4bef4964edecfcc2f21883e7a6caca6dbf7a3d7233696
```

4. Edit your `values.yaml` to add the location of your CLI.

```
trivy:
  cli:
    repositoryUrl: "registry.company.com/project_name/trivy-cli:0.36.0"
```

Use another Trivy Aqua plug-in version

Trivy Aqua plug-in enables Aqua SaaS integration with your Trivy scans.

To use another Trivy Aqua plug-in version:

1. Install the ORAS CLI. See [the ORAS documentation](#).
2. Download the version of Trivy Aqua plug-in you want from the GitHub releases page. See [trivy-plugin-aqua](#) in GitHub.

For example, [v0.115.14](#) in GitHub:

```
TRIVY-AQUA-PLUGIN-VERSION="v0.115.6"
wget -c "https://github.com/aquasecurity/trivy-plugin-aqua/releases/download/
${TRIVY-AQUA-PLUGIN-VERSION}/linux_amd64_${TRIVY-AQUA-PLUGIN-VERSION}.tar.gz" -
O trivy-aqua-plugin.tar.gz

--2023-01-30 10:44:05-- https://github.com/aquasecurity/trivy-plugin-aqua/rele
ases/download/v0.115.6/linux_amd64_v0.115.6.tar.gz
HTTP request sent, awaiting response... 200 OK
Length: 50915539 (49M) [application/octet-stream]
Saving to: `trivy-aqua-plugin.tar.gz'

trivy-aqua-plugin.tar.gz 100%[==>] 48.56M 35.3MB/s in 1.4s

2023-01-30 10:44:07 (35.3 MB/s) - `trivy-aqua-plugin.tar.gz' saved [50915539/50
915539]
```

3. The YAML file is a necessary component to tell Trivy it has the plug-in already installed. Download the `plugin.yml` file associated with Trivy Aqua plug-in version you downloaded.

```
TRIVY-AQUA-PLUGIN-VERSION="v0.115.6"
wget -c "https://raw.githubusercontent.com/aquasecurity/trivy-plugin-aqua/${TRI
VY-AQUA-PLUGIN-VERSION}/plugin.yaml" -O plugin.yaml

--2023-01-30 10:46:32-- https://raw.githubusercontent.com/aquasecurity/trivy-p
```

```

lugin-aqua/v0.115.6/plugin.yaml
HTTP request sent, awaiting response... 200 OK
Length: 909 [text/plain]
Saving to: 'plugin.yaml'
plugin.yaml 100%[==>]      909  --.-KB/s   in 0s

2023-01-30 10:46:32 (54.2 MB/s) - 'plugin.yaml' saved [909/909]

```

4. Relocate the plug-in and YAML to your registry:

```

TRIVY-AQUA-PLUGIN-VERSION="v0.115.6"
REPOSITORY-URL="registry.company.com/project_name/trivy-aqua-plugin:$TRIVY-AQUA-
-PLUGIN-VERSION"

oras push ${REPOSITORY-URL} \
--artifact-type trivy/aqua-plugin \
./trivy-aqua-plugin.tar.gz:application/gzip \
./plugin.yaml:text/yaml

Uploading 6fb65adbfde2 plugin.yaml
Uploading 7340855e31ff trivy-aqua-plugin.tar.gz
Uploaded 6fb65adbfde2 plugin.yaml
Uploaded 7340855e31ff trivy-aqua-plugin.tar.gz
Pushed registry.company.com/project_name/trivy-aqua-plugin:v0.115.6
Digest: sha256:791274e44b97fad98edf570205fddc1b0bc21c56d3d54565ad9475fd4da969ae

```

Where:

- `TRIVY-AQUA-PLUGIN-VERSION` is the version of Trivy Aqua plug-in you are using.
- `REPOSITORY-URL` is the repository where you want to relocate the plug-in.

5. Edit your `values.yaml` to add the location of your CLI.

```

trivy:
  plugins:
    aqua:
      repositoryUrl: "registry.company.com/project_name/trivy-aqua-plugin:v0.11
5.6"

```

Integrate with the Aqua SaaS platform

To integrate with the Aqua SaaS platform:

1. In order to connect to the SaaS Platform you must have an API key. To create an API key:
 1. Log into Aqua SaaS.
 2. Enter CSPM.
 3. Click **Settings** -> **API Keys**.
 4. Click **Generate Key**.
 5. Save the information for the next steps.
2. To integrate with the Aqua SaaS Platform you must have an API key. You pass this to the scanner through environment variables, referenced in a secret. Create an auth secret:

Example secret:

```

apiVersion: v1
kind: Secret
metadata:
  name: aqua-creds
  namespace: APP-NAMESPACE

```

```
stringData:
  aqua-key: API-KEY
  aqua-secret: API-KEY-SECRET
```

Where:

- `APP-NAMESPACE` is the developer namespace your app uses.
 - `API-KEY` is the Aqua Platform API key.
 - `API-KEY-SECRET` is the Aqua Platform API key's Secret.
3. Set environment variables to tell Trivy to connect and report to Aqua SaaS. You can find plug-in options in the [README.md](#) in GitHub.

Here is an example of referencing your API key and secret from a Kubernetes Secret created earlier:

```
namespace: dev
targetImagePullSecret: registry-credentials
environmentVariables:
  - name: TRIVY-RUN-AS-PLUGIN
    value: aqua
  - name: AQUA-KEY
    valueFrom:
      secretKeyRef:
        name: aqua-creds
        key: aqua-key
  - name: AQUA-SECRET
    valueFrom:
      secretKeyRef:
        name: aqua-creds
        key: aqua-secret
```

Where:

- `TRIVY-RUN-AS-PLUGIN` is the Trivy plug-in you want to enable without using the subcommand.
- `AQUA-KEY` is the Aqua Platform API key.
- `AQUA-SECRET` is the Aqua Platform API key's Secret.

Self-signed registry certificate

You need additional configuration when attempting to pull an image from a registry with a self-signed certificate during image scans.

1. If your `tap-values.yaml` used during install has the following shared section filled out, Trivy uses this to connect to your registry without additional configuration. Use the following YAML with a Tanzu Application Platform values shared CA:

```
shared:
  ca_cert_data: | # To be passed if using custom certificates.
    -----BEGIN CERTIFICATE-----
    MIIFXzCCA0egAwIBAgIJAJYm37SFocjlMA0GCSqGSIb3DQEBDQUAMEY...
    -----END CERTIFICATE-----
```

2. Create a secret that holds the registry's CA certificate data. An example secret:

```
apiVersion: v1
kind: Secret
metadata:
  name: trivy-registry-cert
```



```
namespace: dev
type: Opaque
data:
  ca_cert_data: BASE64_CERT
```

- Update your Trivy install `trivy-values.yaml`. Add `caCertSecret` to the root of your `trivy-values.yaml`. For example:

```
namespace: dev
targetImagePullSecret: tap-registry
caCertSecret: trivy-registry-cert
```

Spec reference

This topic describes the specifications and custom resources you can use with Supply Chain Security Tools - Scan.

With the Scan Controller and Grype Scanner installed the following Custom Resource Definitions (CRDs) are now available:

```
$ kubectl get crds | grep scanning.apps.tanzu.vmware.com
imagescans.scanning.apps.tanzu.vmware.com      2021-09-09T15:22:07Z
scanpolicies.scanning.apps.tanzu.vmware.com    2021-09-09T15:22:07Z
scantemplates.scanning.apps.tanzu.vmware.com   2021-09-09T15:22:07Z
sourcescans.scanning.apps.tanzu.vmware.com     2021-09-09T15:22:07Z
```

For more information about installing SCST - Scan, see [Installing Individual Packages](#).

About source and image scans

Both SourceScan (`sourcescans.scanning.apps.tanzu.vmware.com`) and ImageScan (`imagescans.scanning.apps.tanzu.vmware.com`) define what will be scanned, and ScanTemplate (`scantemplates.scanning.apps.tanzu.vmware.com`) will define how to run a scan. We have provided five custom resources (CRs) pre-installed for use. You can either use them as-is or as samples to create your own.

To view the pre-installed Scan Template CRs, run:

```
kubectl get scantemplates
```

You will see the following scan templates:

CR Name	Use Case
<code>public-source-scan-template</code>	Clones and scans source code from a public repository.
<code>private-source-scan-template</code>	Connects with SSH credentials to clone and scan source code from a private repository.
<code>public-image-scan-template</code>	Pulls and scans images from a public registry.
<code>private-image-scan-template</code>	Connects with the registry credentials to pull and scan images from a private registry.
<code>blob-source-scan-template</code>	To be used in a Supply Chain. Gets a <code>.tar.gz</code> available file with <code>wget</code> , uncompresses it, and scans the source code inside it.

By default, three scan templates are deployed (`public-source-scan-template`, `public-image-scan-template`, and `blob-source-scan-template`).

If `targetImagePullSecret` is set in `tap-values.yaml`, `private-image-scan-template` is also deployed. If `targetSourceSshSecret` is set in `tap-values.yaml`, `private-source-scan-template` is also deployed.

The private scan templates reference secrets created using the Docker server and credentials you provided, which means they are ready to use immediately.

For more information about the `SourceScan` and `ImageScan` CRDs and how to customize your own, refer to [Configuring Code Repositories and Image Artifacts to be Scanned](#).

About policy enforcement around vulnerabilities found

The Scan Controller supports policy enforcement by using an Open Policy Agent (OPA) engine. ScanPolicy (scanpolicies.scanning.apps.tanzu.vmware.com) allows scan results to be validated for company policy compliance and can prevent source code from being built or images from being deployed.

For more information, see [Configuring Policy Enforcement using Open Policy Agent \(OPA\)](#).

Scan samples for Supply Chain Security Tools - Scan

This section provides samples on multiple use cases for SCST - Scan that you can copy to your cluster for testing purposes.

- [Running a sample public image scan with compliance check](#)
- [Running a sample public source scan with compliance check](#)
- [Running a sample private image scan](#)
- [Running a sample private source scan](#)
- [Running a sample public source scan of a blob/tar file](#)

Scan samples for Supply Chain Security Tools - Scan

This section provides samples on multiple use cases for SCST - Scan that you can copy to your cluster for testing purposes.

- [Running a sample public image scan with compliance check](#)
- [Running a sample public source scan with compliance check](#)
- [Running a sample private image scan](#)
- [Running a sample private source scan](#)
- [Running a sample public source scan of a blob/tar file](#)

Sample public image scan with compliance check for Supply Chain Security Tools - Scan

This topic includes an example public image scan with compliance check for SCST - Scan.

Public image scan

The following example performs an image scan on an image in a public registry. This image revision has 223 known vulnerabilities (CVEs), spanning a number of severities. ImageScan uses the ScanPolicy to run a compliance check against the CVEs.

The policy in this example is set to only consider **Critical** severity CVEs as a violation, which returns 21 Critical Severity Vulnerabilities.



Note

This example ScanPolicy is deliberately constructed to showcase the features available and must not be considered an acceptable base policy.

In this example, the scan does the following:

- Finds all 223 of the CVEs
- Ignores any CVEs with severities that are not critical
- Indicates in the `Status.Conditions` that 21 CVEs have violated policy compliance

Define the ScanPolicy and ImageScan

Create `sample-public-image-scan-with-compliance-check.yaml`:

```
---
apiVersion: scanning.apps.tanzu.vmware.com/v1beta1
kind: ScanPolicy
metadata:
  name: sample-scan-policy
  labels:
    'app.kubernetes.io/part-of': 'enable-in-gui'
spec:
  regoFile: |
    package main

    # Accepted Values: "Critical", "High", "Medium", "Low", "Negligible", "UnknownSeverity"
    notAllowedSeverities := ["Critical"]
    ignoreCves := []

    contains(array, elem) = true {
      array[_] = elem
    } else = false { true }

    isSafe(match) {
      severities := { e | e := match.ratings.rating.severity } | { e | e := match.ratings.rating[_].severity }
      some i
      fails := contains(notAllowedSeverities, severities[i])
      not fails
    }

    isSafe(match) {
      ignore := contains(ignoreCves, match.id)
      ignore
    }

    deny[msg] {
      comps := { e | e := input.bom.components.component } | { e | e := input.bom.components.component[_] }
      some i
      comp := comps[i]
      vulns := { e | e := comp.vulnerabilities.vulnerability } | { e | e := comp.vulnerabilities.vulnerability[_] }
      some j
      vuln := vulns[j]
      ratings := { e | e := vuln.ratings.rating.severity } | { e | e := vuln.ratings.r
```

```

ating[_].severity }
    not isSafe(vuln)
    msg = sprintf("CVE %s %s %s", [comp.name, vuln.id, ratings])
}

---
apiVersion: scanning.apps.tanzu.vmware.com/v1beta1
kind: ImageScan
metadata:
  name: sample-public-image-scan-with-compliance-check
spec:
  registry:
    image: "nginx:1.16"
  scanTemplate: public-image-scan-template
  scanPolicy: sample-scan-policy

```

(Optional) Set up a watch

Before deploying the resources to a user specified namespace, set up a watch in another terminal to view the progression:

```

watch kubectl get sourcescans,imagescans,pods,taskruns,scantemplates,scanpolicies -n DEV-NAMESPACE

```

Where `DEV-NAMESPACE` is the developer namespace where the scanner is installed.

For more information about setting up a watch, see [Observing and Troubleshooting](#).

Deploy the resources

```

kubectl apply -f sample-public-image-scan-with-compliance-check.yaml -n DEV-NAMESPACE

```

Where `DEV-NAMESPACE` is the developer namespace where the scanner is installed.

View the scan results

```

kubectl describe imagescan sample-public-image-scan-with-compliance-check -n DEV-NAMESPACE

```

Where `DEV-NAMESPACE` is the developer namespace where the scanner is installed.



Note

The `Status.Conditions` includes a `Reason: EvaluationFailed` and `Message: Policy violated because of 21 CVEs`.

For more information about scan status conditions, see [Viewing and Understanding Scan Status Conditions](#).

Edit the ScanPolicy

To edit the Scan Policy, see [Step 5: Sample Public Source Code Scan with Compliance Check](#).

Clean up

To clean up, run:

```

kubectl delete -f sample-public-image-scan-with-compliance-check.yaml -n DEV-NAMESPACE

```

Where `DEV-NAMESPACE` is the developer namespace where the scanner is installed.

Sample public source code scan with compliance check for Supply Chain Security Tools - Scan

This topic includes an example public source code scan with compliance check for SCST - Scan.

Public source scan

This example performs a source scan on a public repository. The source revision has 192 known Common Vulnerabilities and Exposures (CVEs), spanning several severities. SourceScan uses the ScanPolicy to run a compliance check against the CVEs.

The example policy is set to only consider `Critical` severity CVEs as violations, which returns 7 Critical Severity Vulnerabilities.



Note

This example ScanPolicy is deliberately constructed to showcase the features available and must not be considered an acceptable base policy.

For this example, the scan (at the time of writing):

- Finds all 192 of the CVEs.
- Ignores any CVEs that have severities that are not critical.
- Indicates in the `Status.Conditions` that 7 CVEs have violated policy compliance.

Run an example public source scan

To perform an example source scan on a public repository:

1. Create `sample-public-source-scan-with-compliance-check.yaml` to define the ScanPolicy and SourceScan:

```
---
apiVersion: scanning.apps.tanzu.vmware.com/v1beta1
kind: ScanPolicy
metadata:
  name: sample-scan-policy
  labels:
    'app.kubernetes.io/part-of': 'enable-in-gui'
spec:
  regoFile: |
    package main

    # Accepted Values: "Critical", "High", "Medium", "Low", "Negligible", "Unkn
ownSeverity"
    notAllowedSeverities := ["Critical"]
    ignoreCves := []

    contains(array, elem) = true {
      array[_] = elem
    } else = false { true }

    isSafe(match) {
      severities := { e | e := match.ratings.rating.severity } | { e | e := mat
ch.ratings.rating[_].severity }
      some i
      fails := contains(notAllowedSeverities, severities[i])
```

```

    not fails
  }

  isSafe(match) {
    ignore := contains(ignoreCves, match.id)
    ignore
  }

  deny[msg] {
    comps := { e | e := input.bom.components.component } | { e | e := input.bom.components.component[_] }
    some i
    comp := comps[i]
    vulns := { e | e := comp.vulnerabilities.vulnerability } | { e | e := comp.vulnerabilities.vulnerability[_] }
    some j
    vuln := vulns[j]
    ratings := { e | e := vuln.ratings.rating.severity } | { e | e := vuln.ratings.rating[_].severity }
    not isSafe(vuln)
    msg = sprintf("CVE %s %s %s", [comp.name, vuln.id, ratings])
  }

---
apiVersion: scanning.apps.tanzu.vmware.com/v1beta1
kind: SourceScan
metadata:
  name: sample-public-source-scan-with-compliance-check
spec:
  git:
    url: "https://github.com/houndci/hound.git"
    revision: "5805c650"
  scanTemplate: public-source-scan-template
  scanPolicy: sample-scan-policy

```

- (Optional) Before deploying the resources to a user specified namespace, set up a watch in another terminal to view the progression:

```
watch kubectl get sourcescans,imagescans,pods,taskruns,scantemplates,scanpolicies -n DEV-NAMESPACE
```

Where `DEV-NAMESPACE` is the developer namespace where the scanner is installed.

For more information, see [Observing and Troubleshooting](#).

- Deploy the resources by running:

```
kubectl apply -f sample-public-source-scan-with-compliance-check.yaml -n DEV-NAMESPACE
```

Where `DEV-NAMESPACE` is the developer namespace where the scanner is installed.

- When the scan completes, view the results by running:

```
kubectl describe sourcescan sample-public-source-scan-with-compliance-check -n DEV-NAMESPACE
```

The `Status.Conditions` includes a `Reason: EvaluationFailed` and `Message: Policy violated because of 7 CVEs`. For more information, see [Viewing and Understanding Scan Status Conditions](#).

- If the failing CVEs are acceptable or the build must be deployed regardless of these CVEs, the app is patched to remove the vulnerabilities. Update the `ignoreCVEs` array in the `ScanPolicy` to include the CVEs to ignore:

```

...
spec:
  regoFile: |
    package policies

    default isCompliant = false

    # Accepted Values: "UnknownSeverity", "Critical", "High", "Medium", "Low",
    "Negligible"
    violatingSeverities := ["Critical"]
    # Adding the failing CVEs to the ignore array
    ignoreCVEs := ["CVE-2018-14643", "GHSA-f2jv-r9rf-7988", "GHSA-w457-6q6x-cgp
    9", "CVE-2021-23369", "CVE-2021-23383", "CVE-2020-15256", "CVE-2021-29940"]
    ...

```

6. The changes applied to the new ScanPolicy trigger the scan to run again. Reapply the resources by running:

```
kubectl apply -f sample-public-source-scan-with-compliance-check.yaml -n DEV-NAME-SPACE
```

7. Re-describe the SourceScan CR by running:

```
kubectl describe sourcescan sample-public-source-scan-with-compliance-check -n DEV-NAME-SPACE
```

8. Ensure that `Status.Conditions` now includes a `Reason: EvaluationPassed` and `No CVEs were found that violated the policy`. You can update the `violatingSeverities` array in the ScanPolicy if you want. For reference, the Grype scan returns the following Severity spread of vulnerabilities:

- o Critical: 7
- o High: 88
- o Medium: 92
- o Low: 5
- o Negligible: 0
- o UnknownSeverity: 0

9. Clean up by running:

```
kubectl delete -f sample-public-source-scan-with-compliance-check.yaml -n DEV-NAME-SPACE
```

Sample private image scan for Supply Chain Security Tools - Scan

This example describes how you can perform a scan against an image located in a private registry for SCST - Scan.

Define the resources

Set up target image pull secret

1. Confirm that target image secret is configured. This is completed during Tanzu Application Platform installation. If the target image secret exists, see [Create the private image scan](#).

2. If the target image secret was not configured, create a secret containing the credentials used to pull the target image you want to scan. For information about secret creation, see the [Kubernetes documentation](#).

```
kubectl create secret docker-registry TARGET-REGISTRY-CREDENTIALS-SECRET \
--docker-server=YOUR-REGISTRY-SERVER \
--docker-username=YOUR-NAME \
--docker-password=YOUR-PASSWORD \
--docker-email=YOUR-EMAIL \
-n DEV-NAMESPACE
```

- `TARGET-REGISTRY-CREDENTIALS-SECRET` is the name of the secret that is created.
 - `DEV-NAMESPACE` is the developer namespace where the scanner is installed.
 - `YOUR-REGISTRY-SERVER` is the registry server you want to use.
 - `YOUR-NAME` is the name associated with the secret.
 - `YOUR-PASSWORD` is the password associated with the secret.
 - `YOUR-EMAIL` is the email associated with the secret.
3. Update the `tap-values.yaml` file to include the name of secret created earlier.

```
grype:
  namespace: "MY-DEV-NAMESPACE"
  targetImagePullSecret: "TARGET-REGISTRY-CREDENTIALS-SECRET"
```

4. Upgrade Tanzu Application Platform with the modified `tap-values.yaml` file.

```
tanzu package installed update tap -p tap.tanzu.vmware.com -v ${TAP-VERSION} -
-values-file tap-values.yaml -n tap-install
```

Where `TAP-VERSION` is the Tanzu Application Platform version.

Create the private image scan

Create `sample-private-image-scan.yaml`:

```
---
apiVersion: scanning.apps.tanzu.vmware.com/v1beta1
kind: ImageScan
metadata:
  name: sample-private-image-scan
spec:
  registry:
    image: IMAGE-URL
  scanTemplate: private-image-scan-template
```

Where `IMAGE-URL` is the URL of an image in a private registry.

(Optional) Set up a watch

Before deploying the resources to a user specified namespace, set up a watch in another terminal to view the progression:

```
watch kubectl get sourcescans,imagescans,pods,taskruns,scantemplates,scanpolicies -n D
EV-NAMESPACE
```

Where `DEV-NAMESPACE` is the developer namespace where the scanner is installed.

For more information, see [Observing and Troubleshooting](#).

Deploy the resources

```
kubectl apply -f sample-private-image-scan.yaml -n DEV-NAMESPACE
```

Where `DEV-NAMESPACE` is the developer namespace where the scanner is installed.

View the scan results

When the scan completes, run:

```
kubectl describe imagescan sample-private-image-scan -n DEV-NAMESPACE
```

Where `DEV-NAMESPACE` is the developer namespace where the scanner is installed.



Note

The `Status.Conditions` includes a `Reason: JobFinished` and `Message: The scan job finished`. See [Viewing and Understanding Scan Status Conditions](#).

Clean up

```
kubectl delete -f sample-private-image-scan.yaml -n DEV-NAMESPACE
```

Where `DEV-NAMESPACE` is the developer namespace where the scanner is installed.

View vulnerability reports

After completing the scans, [query the Supply Chain Security Tools - Store](#) to view your vulnerability results.

Sample private source scan for Supply Chain Security Tools - Scan

This example shows how you can perform a private source scan for SCST - Scan.

Define the resources

1. Create a Kubernetes secret with an SSH key for cloning a Git repository. See the [Kubernetes documentation](#).

```
cat <<EOF | kubectl create -f -
apiVersion: v1
kind: Secret
metadata:
  name: SECRET-SSH-AUTH
  namespace: DEV-NAMESPACE
  annotations:
    tekton.dev/git-0: https://github.com
    tekton.dev/git-1: https://gitlab.com
type: kubernetes.io/ssh-auth
stringData:
  ssh-privatekey: |
    -----BEGIN OPENSSH PRIVATE KEY-----
    ...
    ...
```

```
-----END OPENSSSH PRIVATE KEY-----
EOF
```

Where:

- `SECRET-SSH-AUTH` is the name of the secret that is being created.
- `DEV-NAMESPACE` is the developer namespace where the scanner is installed.
- `.stringData.ssh-privatekey` contains the private key with pull-permissions.

2. Update the `tap-values.yaml` file to include the name of secret created above.

```
grype:
  namespace: "MY-DEV-NAMESPACE"
  targetSourceSshSecret: "SECRET-SSH-AUTH"
```

3. Upgrade Tanzu Application Platform with the modified `tap-values.yaml` file.

```
tanzu package installed update tap -p tap.tanzu.vmware.com -v ${TAP-VERSION} -
-values-file tap-values.yaml -n tap-install
```

Where `TAP-VERSION` is the Tanzu Application Platform version.

4. Create `sample-private-source-scan.yaml`:

```
---
apiVersion: scanning.apps.tanzu.vmware.com/v1beta1
kind: SourceScan
metadata:
  name: sample-private-source-scan
spec:
  git:
    url: URL
    revision: REVISION
    knownHosts: |
      KNOWN-HOSTS
  scanTemplate: private-source-scan-template
```

Where:

- `URL` is the Git clone repository using SSH.
- `REVISION` is the commit hash.
- `KNOWN-HOSTS` are the SSH client stored host keys generated by `ssh-keyscan`.

For example, `ssh-keyscan github.com` produces:

```
github.com ssh-rsa AAAAB3NzaC1yc2EAAAABIwAAAQEAq2A7hRGmdnm9tUDbO9IDSwBK6TbQa+PX
YPCPy6rbTrTtw7PHkccKrrp0yVhp5HdEiCkr6pLlVDBfOLX9QUusyCOV0wzFjIjNlGEYsdllJizHhbn2
mUjvSAHQqzETYP8leFzLQnNpht4EVVUh7VfDESU84KezmD5QlWpXLmvU31/yMf+Se8xhHTvKSCZIFIm
WwoG6mbUoWf9nZpIoaSjB+weqqUmpaaasXVal72J+UX2B+2RPW3RcT0eOzQgqlJL3RkrTJvdsjE3JE
AvGq3lGHSZxy28G3skua2SmVi/w4yCE6gbODqntWlg7+wC604ydGXA8VJiS5ap43JXiUFFAaQ==
github.com ecdsa-sha2-nistp256 AAAAE2VjZHNhLXNoYTItbmlzdHAyNTYAAAAIbmlzdHAyNTYA
AABBBEmKSENjQEezOmxkZMy7opKgwFB9nkt5YRrYMjNuG5N87uRgg6CLrbo5wAdT/y6v0mKV0U2w0WZ
2YB/++Tpockg=
github.com ssh-ed25519 AAAAC3NzaC1lZDI1NTE5AAAAIOMqqnkVzrm0SdG6U0oqKLSabgH5C9ok
Wi0dh2l9GKJl
```

```
---
apiVersion: scanning.apps.tanzu.vmware.com/v1beta1
kind: SourceScan
metadata:
  name: sample-private-source-scan
```

```
spec:
  git:
    url: git@github.com:acme/website.git
    revision: 25as5e7df56c6401111be514a2f3666179ba04d0
    knownHosts: |
      10.254.171.53 ecdsa-sha2-nistp256 AAAAE2VjZHNhLXNoYTItb
      POVVQF/CzuAeQNV4fZVf2pLxpGHle15zkpxOosckequUDxoq
    scanTemplate: private-source-scan-template
```

(Optional) Set up a watch

Before deploying the resources to a user specified namespace, set up a watch in another terminal to view the progression:

```
watch kubectl get sourcescans,imagescans,pods,taskruns,scantemplates,scanpolicies -n D
EV-NAMESPACE
```

Where `DEV-NAMESPACE` is the developer namespace where the scanner is installed.

See [Observing and Troubleshooting](#).

Deploy the resources

```
kubectl apply -f sample-private-source-scan.yaml -n DEV-NAMESPACE
```

Where `DEV-NAMESPACE` is the developer namespace where the scanner is installed.

View the scan status

After the scan has completed, run:

```
kubectl describe sourcescan sample-private-source-scan -n DEV-NAMESPACE
```

Where `DEV-NAMESPACE` is the developer namespace where the scanner is installed.

Notice the `Status.Conditions` includes a `Reason: JobFinished` and `Message: The scan job finished`. See [Viewing and Understanding Scan Status Conditions](#).

Clean up

```
kubectl delete -f sample-private-source-scan.yaml -n DEV-NAMESPACE
```

Where `DEV-NAMESPACE` is the developer namespace where the scanner is installed.

View vulnerability reports

After completing the scans, [query the Supply Chain Security Tools - Store](#) to view your vulnerability results.

Sample public source scan of a blob for Supply Chain Security Tools - Scan

You can do a public source scan of a blob for SCST - Scan. This example performs a scan against source code in a `.tar.gz` file. This is helpful in a Supply Chain, where there is a `GitRepository` step that handles cloning a repository and outputting the source code as a compressed archive.

Define the resources

Create `public-blob-source-example.yaml`:

```
---
apiVersion: scanning.apps.tanzu.vmware.com/v1beta1
kind: SourceScan
metadata:
  name: public-blob-source-example
spec:
  blob:
    url: "https://gitlab.com/nina-data/ckan/-/archive/master/ckan-master.tar.gz"
  scanTemplate: blob-source-scan-template
```

(Optional) Set up a watch

Before deploying the resources to a user specified namespace, set up a watch in another terminal to view the progression:

```
watch kubectl get sourcescans,imagescans,pods,taskruns,scantemplates,scanpolicies -n DEV-NAMESPACE
```

Where `DEV-NAMESPACE` is the developer namespace where the scanner is installed.

For more information, see [Observing and Troubleshooting](#).

Deploy the resources

```
kubectl apply -f public-blob-source-example.yaml -n DEV-NAMESPACE
```

Where `DEV-NAMESPACE` is the developer namespace where the scanner is installed.

View the scan results

When the scan completes, perform:

```
kubectl describe sourcescan public-blob-source-example -n DEV-NAMESPACE
```

Where `DEV-NAMESPACE` is the developer namespace where the scanner is installed.

Notice the `Status.Conditions` includes a `Reason: JobFinished` and `Message: The scan job finished`.

For more information, see [Viewing and Understanding Scan Status Conditions](#).

Clean up

```
kubectl delete -f public-blob-source-example.yaml -n DEV-NAMESPACE
```

Where `DEV-NAMESPACE` is the developer namespace where the scanner is installed.

View vulnerability reports

After completing the scans, [query the Supply Chain Security Tools - Store](#) to view your vulnerability results.

Using Grype in air-gapped (offline) environments for Supply Chain Security Tools - Scan

This topic tells you how to use Grype in air-gapped (offline) environments for Supply Chain Security Tools (SCST) - Scan.

The `grype` CLI attempts to perform two over the Internet calls:

- One to verify for later versions of the CLI.
- One to update the vulnerability database before scanning.

For the `grype` CLI to function in an offline or air-gapped environment, the vulnerability database must be hosted within the environment. You must configure the `grype` CLI with the internal URL.

The `grype` CLI accepts environment variables to satisfy these needs.

Host the Grype vulnerability database

To host Grype's vulnerability database in an air-gapped environment:

1. Retrieve Grype's listing file from its public endpoint: <https://toolbox-data.anchore.io/grype/databases/listing.json>.
2. Create your own `listing.json` file.

Note Different Grype versions require specific database schema versions. To avoid compatibility issues between different versions, include a database schema for each version. For example:

```
{
  "available": {
    "1": [
      {
        "built": "2023-06-16T01:33:30Z",
        "version": 1,
        "url": "https://toolbox-data.anchore.io/grype/databases/vulnerability-db_v1_2023-06-16T01:33:30Z_1621f4169ffd15bea9e5.tar.gz",
        "checksum": "sha256:3f2c1b432945cca9a69b2e604f6fb231fec450fdd27f4946fc5608692b63a9d1"
      }
    ],
    "2": [
      {
        "built": "2023-06-16T01:33:30Z",
        "version": 2,
        "url": "https://toolbox-data.anchore.io/grype/databases/vulnerability-db_v2_2023-06-16T01:33:30Z_d6eee5e78d9b78285e1a.tar.gz",
        "checksum": "sha256:7b7e3a2a7712c72b8c5cc777733c4d8d140d8cfee65e4f04540abbdfe3ef1f65"
      }
    ],
    "3": [
      {
        "built": "2023-06-16T01:33:30Z",
        "version": 3,
        "url": "https://toolbox-data.anchore.io/grype/databases/vulnerability-db_v3_2023-06-16T01:33:30Z_f96ae38a7b05987c3ecec.tar.gz",
        "checksum": "sha256:8ea9fae3fda3bf3bf35bd5e5eb656fc127b59cd3c42db4c36795556aab8a9cf0"
      }
    ],
    "4": [
      {
```

```

        "built": "2023-06-16T01:33:30Z",
        "version": 4,
        "url": "https://toolbox-data.anchore.io/grype/databases/vulnerability-db_v4_2023-06-16T01:33:30Z_13bba2fa8ff62b7f8b26.tar.gz",
        "checksum": "sha256:3b53d20241b88e5aa45feb817b325c53d6efbe9falfc5a67eeddaecafa7687e0"
      }
    ],
    "5": [
      {
        "built": "2023-06-16T01:33:30Z",
        "version": 5,
        "url": "https://toolbox-data.anchore.io/grype/databases/vulnerability-db_v5_2023-06-16T01:33:30Z_e07da3853f6db6eb1104.tar.gz",
        "checksum": "sha256:93d4d9d2f9e39f86570f832cf85b7149a949ca6f1613581b10c12393509d884f"
      }
    ]
  }
}

```

Where `url` points to a tarball containing Grype's `vulnerability`, `db`, and `metadata.json` files.

- Download and host the tarballs in your internal file server.



Note

Some storage solutions for internal file servers change the name of TAR files automatically because of their limits. Notice these modified names and reflect the changes in the `url`. Ensure that the timestamp in the name is correctly formatted because Grype parses the name of TAR artifact to get the timestamp.

- Update the download `url` to point at your internal endpoint.

For information about setting up an offline vulnerability database, see the [Anchore Grype README](#) in GitHub.

To enable Grype in offline air-gapped environments

- Add the following to your `tap-values.yaml` file:

```

grype:
  db:
    dbUpdateUrl: INTERNAL-VULN-DB-URL

```

Where `INTERNAL-VULN-DB-URL` is the URL that points to the internal file server.

- Update Tanzu Application Platform:

```
tanzu package installed update tap -f tap-values.yaml -n tap-install
```

Configure Grype environmental variables

- Create a secret that contains the ytt overlay to add the Grype environment variable to the ScanTemplates.

```

apiVersion: v1
kind: Secret

```

```

metadata:
  name: grype-airgap-environmental-variables
  namespace: tap-install
stringData:
  patch.yaml: |
    #@ load("@ytt:overlay", "overlay")

    #@overlay/match by=overlay.subset({"kind":"ScanTemplate"}), expects="1+"
    ---
    spec:
      template:
        initContainers:
          #@overlay/match by=overlay.subset({"name": "scan-plugin"}), expects
          ="1+"
          - name: scan-plugin
            #@overlay/match missing_ok=True
            env:
              #@overlay/append
              - name: GRYPE_CHECK_FOR_APP_UPDATE
                value: "false"

```

Where `spec.template.initContainers[]` specifies setting one or more environment variables in the `scan-plugin` `initContainer`.



Note

If you are using the Namespace Provisioner to provision a new developer namespace and want to apply a package overlay for Grype, you must import the overlay `Secret`. See [Import overlay secrets](#).

Troubleshooting

ERROR failed to fetch latest cli version



Note

This message is a warning and the Grype scan still runs with this message.

The Grype CLI checks for later versions of the CLI by contacting the anchore endpoint over the Internet.

```

ERROR failed to fetch latest version: Get "https://toolbox-data.anchore.io/grype/releases/latest/VERSION": dial tcp: lookup toolbox-data.anchore.io on [::1]:53: read udp [::1]:65010->[::1]:53: read: connection refused

```

Solution

To deactivate this check, set the environment variable `GRYPE_CHECK_FOR_APP_UPDATE` to `false` by using a package overlay with the following steps:

1. Create a secret that contains the ytt overlay to add the Grype environment variable to the `ScanTemplates`.

```

apiVersion: v1
kind: Secret
metadata:
  name: grype-airgap-deactivate-cli-check-overlay

```

```

namespace: tap-install #! namespace where tap is installed
stringData:
  patch.yaml: |
    #@ load("@ytt:overlay", "overlay")

    #@overlay/match by=overlay.subset({"kind":"ScanTemplate"}), expects="1+"
    ---
    spec:
      template:
        initContainers:
          #@overlay/match by=overlay.subset({"name": "scan-plugin"}), expects
          ="1+"
          - name: scan-plugin
            #@overlay/match missing_ok=True
            env:
              #@overlay/append
              - name: GRYPE_CHECK_FOR_APP_UPDATE
                value: "false"

```

2. Configure `tap-values.yaml` to use `package_overlays`. Add the following to your `tap-values.yaml` file:

```

package_overlays:
  - name: "grype"
    secrets:
      - name: "grype-airgap-deactivate-cli-check-overlay"

```

3. Update Tanzu Application Platform:

```
tanzu package installed update tap -f tap-values.yaml -n tap-install
```

Database is too old

```

1 error occurred:
 * db could not be loaded: the vulnerability database was built N days/weeks ago (max
allowed age is 5 days)

```

Grype needs up-to-date vulnerability information to provide accurate matches. By default, it fails to run if the local database was not built in the last 5 days.

Solution

Two options to resolve this:

1. Stale databases weaken your security posture. VMware recommends updating the database daily as the first recommended solution.
2. If updating the database daily is not an option, the data staleness check is configurable by using the environment variable `GRYPE_DB_MAX_ALLOWED_BUILT_AGE` and is addressed using a package overlay with the following steps:
 1. Create a secret that contains the ytt overlay to add the Grype environment variable to the ScanTemplates.

```

apiVersion: v1
kind: Secret
metadata:
  name: grype-airgap-override-stale-db-overlay
  namespace: tap-install #! namespace where tap is installed
stringData:
  patch.yaml: |
    #@ load("@ytt:overlay", "overlay")

```



```

#@overlay/match by=overlay.subset({"kind":"ScanTemplate"}),expects="1
+"
---
spec:
  template:
    initContainers:
      #@overlay/match by=overlay.subset({"name": "scan-plugin"}), exp
ects="1+"
      - name: scan-plugin
        #@overlay/match missing_ok=True
        env:
          #@overlay/append
          - name: GRYPE_DB_MAX_ALLOWED_BUILT_AGE #! see note on best
practices
            value: "120h"

```



Note

The default maximum allowed built age of Grype's vulnerability database is 5 days. This means that scanning with a 6 day old database causes the scan to fail. You can use the `GRYPE_DB_MAX_ALLOWED_BUILT_AGE` parameter to override the default in accordance with your security posture.

2. Configure `tap-values.yaml` to use `package_overlays`. Add the following to your `tap-values.yaml` file:

```

package_overlays:
  - name: "grype"
    secrets:
      - name: "grype-airgap-override-stale-db-overlay"

```

3. Update Tanzu Application Platform:

```
tanzu package installed update tap -f tap-values.yaml -n tap-install
```

Vulnerability database is invalid

```

scan-pod[scan-plugin] 1 error occurred:
scan-pod[scan-plugin] * failed to load vulnerability db: vulnerability database is in
valid (run db update to correct): database metadata not found: /.cache/grype/db/5

```

Solution

Examine the `listing.json` file you created. This matches the format of the listing file. The listing file is located at Anchore Grype's public endpoint. See the [Grype README.md](#) in GitHub.

An example `listing.json`:

```

{
  "available": {
    "5": [
      {
        "built": "2023-03-28T01:29:38Z",
        "version": 5,
        "url": "https://toolbox-data.anchore.io/grype/databases/vulnerability-db_v5_20
23-03-28T01:29:38Z_e49d318c32a6113eed07.tar.gz",
        "checksum": "sha256:408ce2932f04dee929a5df524e92494f2d635c6b19e30ff9f0a50425b1

```

```
fc29a1"
  },
  .....
]
}
}
```

Where:

- `5` refers to the Grype's vulnerability database schema.
- `built` is the build timestamp in the format `yyyy-MM-ddTHH:mm:ssZ`.
- `url` is the download URL for the tarball containing the database. This points at your internal endpoint. The tarball contains the following files:
 - `vulnerability.db` is an SQLite file that is Grype's vulnerability database. Each time the data shape of the vulnerability database changes, a new schema is created. Different Grype versions require specific database schema versions. For example, Grype `v0.54.0` requires database schema version `v5`.
 - `metadata.json` file
- `checksum` is the SHA used to verify the database's integrity.

Verify these possible reasons why the vulnerability database is not valid:

1. The database schema is invalid. Confirm that the required database schema for the installed Grype version is used. Confirm that the top level version key matches the nested `version`. For example, the top level version `1` in the following snippet does not match the nested `version: 5`.

```
{
  "available": {
    "1": [{
      "built": "2023-02-08T08_17_20Z",
      "version": 5,
      "url": "https://INTERNAL-ENDPOINT/PATH-TO-TARBALL/vulnerability-db_v
5_2023-02-08T08_17_20Z_6ef73016d160043c630f.tar.gz",
      "checksum": "sha256:aab8d369933c845878ef1b53bb5c26ee49b91ddc5cd87c9e
b57ffb203a88a72f"
    }]
  }
}
```

Where `PATH-TO-TARBALL` is the path to the tarball containing the vulnerability database.

As stale databases weaken your security posture, VMware recommends using the newest entry of the relevant schema version in the `listing.json` file. See Anchore's [grype-db](#) in GitHub.

2. The `built` parameters in the `listing.json` file are incorrectly formatted. The proper format is `yyyy-MM-ddTHH:mm:ssZ`.
3. The `url` that you modified to point at an internal endpoint is not reachable from within the cluster. For information about verifying connectivity, see [Debug Grype database in a cluster](#).
4. Verify if there are syntax errors in the `listing.json`:

```
grype db check
```

5. Validate the configured `listing.json`:

```
grype db list -o raw
```

Debug Grype database in a cluster

1. Describe the failed source scan or image scan to verify the name of the ScanTemplate being used.

- o For `sourcescan`, run:

```
kubectl describe sourcescan SCAN-NAME -n DEV-NAMESPACE
```

- o For `imagescan`, run:

```
kubectl describe imagescan SCAN-NAME -n DEV-NAMESPACE
```

Where `SCAN-NAME` is the name of the source or image scan that failed.

2. Pause reconciliation of the `grype.scanning.apps.tanzu.vmware.com` package:

```
kubectl package installed pause -i <PACKAGE-INSTALL-NAME> -n tap-install
```

Where `PACKAGE-INSTALL-NAME` is the name of the `grype.scanning.apps.tanzu.vmware.com` package (e.g. `grype`)

3. Edit the ScanTemplate's `scan-plugin` container to include a “sleep” entrypoint which allows you to troubleshoot inside the container:

```
- name: scan-plugin
  volumeMounts:
    ...
  image: #@ data.values.scanner.image
  imagePullPolicy: IfNotPresent
  env:
    ...
  command: ["/bin/bash"]
  args:
    - "sleep 1800" # insert 30 min sleep here
```

4. Re-run the scan.
5. Get the name of the `scan-plugin` pod.

```
kubectl get pods -n DEV-NAMESPACE
```

6. Get a shell to the container.

```
kubectl exec --stdin --tty SCAN-PLUGIN-POD -c step-scan-plugin -- /bin/bash
```

Where `SCAN-PLUGIN-POD` is the name of the `scan-plugin` pod. For more information, see the [Kubernetes documentation](#).

7. Inside the container, run Grype CLI commands to report database status and verify connectivity from the cluster to the mirror. See the [Grype documentation](#) in GitHub.
 - o Report current status of Grype’s database, such as location, build date, and checksum:

```
grype db status
```

8. Ensure that the built parameters in the `listing.json` has timestamps in this proper format `yyyy-MM-ddTHH:mm:ssZ`.
9. After you complete troubleshooting, use the following command to trigger reconciliation:

```
kubectl package installed kick -i <PACKAGE-INSTALL-NAME> -n tap-install
```

Where `PACKAGE-INSTALL-NAME` is the name of the `grype.scanning.apps.tanzu.vmware.com` package, such as Grype.

Grype package overlays are not applied to scantemplates created by Namespace Provisioner

If you used the Namespace Provisioner to provision a new developer namespace and want to apply a package overlay for Grype, see [Import overlay secrets](#).

Triage and Remediate CVEs for Supply Chain Security Tools - Scan

This topic explains how you can triage and remediate CVEs related to SCST - Scan.

Confirm that Supply Chain stopped due to failed policy enforcement

To confirm that Supply Chain failure is related to policy enforcement:

1. Verify that the status of the workload is `MissingValueAtPath` due to waiting on a `.status.compliantArtifact` from either the SourceScan or ImageScan:

```
kubectl describe workload WORKLOAD-NAME -n DEVELOPER-NAMESPACE
```

2. Describe the SourceScan or ImageScan to determine what CVE(s) violated the ScanPolicy:

```
kubectl describe sourcescan NAME -n DEVELOPER-NAMESPACE
kubectl describe imagescan NAME -n DEVELOPER-NAMESPACE
```

Triage

The goal of triage is to analyze and prioritize the reported vulnerability data to discover the appropriate course of action to take at the remediation step. To remediate efficiently and appropriately, you need context on the vulnerabilities that are blocking your supply chain, the packages that are affected, and the impact they can have.

During triage, review which packages are impacted by the CVEs that violated your scan policy. Use the Supply Chain Choreographer in the Tanzu Developer Portal (formerly named Tanzu Application Platform GUI) to visualize your supply chain, including scans, scan policy, and CVEs. You can also use the Tanzu CLI Insight plug-in to query packages, vulnerabilities, and create vulnerability analysis. See [Tanzu CLI Insight plug-in](#).

During this stage, VMware recommends reviewing information pertaining to the CVEs from sources such as the [National Vulnerability Database](#) or the release page of a package.

Remediation

After triage is complete, the next step is to remediate the blocking vulnerabilities quickly. Some common methods for CVE remediation are as follows:

- Updating the affected component to remove the CVE
- Amending the scan policy with an exception if you decide to accept the CVE and unblock your supply chain

Updating the affected component

Vulnerabilities that occur in older versions of a package might be resolved in later versions. Apply a patch by upgrading to a later version. You can further adopt security best practices by using your project's package manager tools, such as `go mod graph` for projects in Go, to identify transitive or indirect dependencies that can affect CVEs.

Amending the scan policy

If you decide to proceed without remediating the CVE, for example, when a CVE is evaluated to be a false positive or when a fix is not available, you can amend the ScanPolicy to ignore one or more CVEs. For information about common scanner limitations, see [Note on Vulnerability Scanners](#). For information about templates, see [Writing Policy Templates](#).

Under RBAC, users with the `app-operator-scanning` role that is part of the `app-operator` aggregate role, have permission to edit the ScanPolicy. See [Detailed role permissions breakdown](#).

Observe Supply Chain Security Tools - Scan

This topic outlines observability and troubleshooting methods and issues you can use with SCST - Scan components.

Observability

The scans run inside a Tekton TaskRun where the TaskRun creates a pod. Both the TaskRun and pod are cleaned up after completion.

Before applying a new scan, you can set a watch on the TaskRuns, Pods, SourceScans, and Imagescans to observe their progression:

```
watch kubectl get sourcescans,imagescans,pods,taskruns,scantemplates,scanpolicies -n D
EV-NAMESPACE
```

Where `DEV-NAMESPACE` is the developer namespace where the scanner is installed.

Troubleshoot Supply Chain Security Tools - Scan

This topic describes troubleshooting methods you can use with Supply Chain Security Tools (SCST) - Scan.

Debugging commands

Run these commands to get more logs and details about the errors around scanning. The TaskRuns and pods persist for a predefined amount of seconds before getting deleted.

(`deleteScanJobsSecondsAfterFinished` is the tap pkg variable that defines this)

Debugging Tekton TaskRun

To retrieve TaskRun events:

```
kubectl describe taskrun TASKRUN-NAME -n DEV-NAMESPACE
```

Where:

- `TASKRUN-NAME` is the name of the TaskRun.
- `DEV-NAMESPACE` is the name of the developer namespace you want to use.

Debugging Scan pods

Run the following to get error logs from a pod when scan pods are in a failing state:

```
kubectl logs scan-pod-name -n DEV-NAMESPACE
```

Where `DEV-NAMESPACE` is the name of the developer namespace you want to use.

See [here](#) for more details about debugging Kubernetes pods.

The following is an example of a successful scan run output:

```
scan:
  cveCount:
    critical: 20
    high: 120
    medium: 114
    low: 9
    unknown: 0
  scanner:
    name: Grype
    vendor: Anchore
    version: v0.37.0
  reports:
    - /workspace/scan.xml
eval:
  violations:
    - CVE node-fetch GHSA-w7rc-rwvf-8q5r Low
store:
  locations:
    - https://metadata-store-app.metadata-store.svc.cluster.local:8443/api/sources?repo=hound&sha=5805c6502976c10f5529e7f7aeb0af0c370c0354&org=houndci
```

A scan run that has an error means that one of the init containers: `scan-plugin`, `metadata-store-plugin`, `compliance-plugin`, `summary`, or any other additional containers had a failure.

To inspect for a specific init container in a pod:

```
kubectl logs scan-pod-name -n DEV-NAMESPACE -c init-container-name
```

Where `DEV-NAMESPACE` is the name of the developer namespace you want to use.

See [Debug Init Containers](#) in the Kubernetes documentation for debug init container tips.

Debugging SourceScan and ImageScan

To retrieve status conditions of an SourceScan and ImageScan, run:

```
kubectl describe sourcescan SOURCE-SCAN -n DEV-NAMESPACE
```

Where:

- `DEV-NAMESPACE` is the name of the developer namespace you want to use.
- `SOURCE-SCAN` is the name of the SourceScan you want to use.

```
kubectl describe imagescan IMAGE-SCAN -n DEV-NAMESPACE
```

Where:

- `DEV-NAMESPACE` is the name of the developer namespace you want to use.
- `IMAGE-SCAN` is the name of the ImageScan you want to use.

Under `Status.Conditions`, for a condition look at the “Reason”, “Type”, “Message” values that use the keyword “Error” to investigate issues.

Debugging Scanning within a SupplyChain

See [here](#) for Tanzu workload commands for tailing build and runtime logs and getting workload status and details.

Viewing the Scan-Controller manager logs

To retrieve scan-controller manager logs:

```
kubect1 -n scan-link-system logs -f deployment/scan-link-controller-manager -c manager
```

Restarting Deployment

If you encounter an issue with the scan-link controller not starting, run the following to restart the deployment to see if it’s reproducible or flaking upon starting:

```
kubect1 rollout restart deployment scan-link-controller-manager -n scan-link-system
```

Troubleshooting scanner to MetadataStore configuration

Insight CLI failed to post scan results to metadata store due to failed certificate verification

If you encounter this issue:

```
✘ Error: Post "https://metadata-store.tap.tanzu.example.com/api/sourceReport?": \
tls: failed to verify certificate: x509: certificate signed by unknown authority
```

To ensure that the `caSecret` from the scanner `DEV-NAMESPACE` matches the `caSecret` from the `METADATASTORE-NAMESPACE` namespace:

1. In a single cluster, the connection between the scanning pod and the metadata store happens inside the cluster and does not pass through ingress. This is automatically configured. You do not need to provide an ingress connection to the store. If you provided an ingress connection to the store, delete it.
2. Get the `caSecret.name`. If you are using a multicluster setup, retrieve `grype.metadataStore.caSecret.name` from the Grype config:

```
grype:
  metadataStore:
    caSecret:
      name: store-ca-cert
      importFromNamespace: metadata-store-secrets
```



Note

`caSecret.name` is set to `store-ca-cert`. For more information, see [Set up multicluster Supply Chain Security Tools \(SCST\) - Store](#).

If you are using a single-cluster setup, the default value for `grype.metadataStore.caSecret.name` is `app-tls-cert`. For more information, see [Install Supply Chain Security Tools - Scan](#).

- Verify that the `CA-SECRET` secret exists in the `DEV-NAMESPACE` by running:

```
kubectl get secret CA-SECRET -n DEV-NAMESPACE
```

- If the secret `CA-SECRET` doesn't exist in your `DEV-NAMESPACE`, verify that the `CA-SECRET` exists in the `METADASTORE-NAMESPACE` namespace:

```
kubectl get secret CA-SECRET -n METADASTORE-NAMESPACE
```

Where `METADASTORE-NAMESPACE` is the namespace that contains the secret `CA-SECRET`.

If you are using a single cluster, it is configured using the `metadata-store` namespace. If multicluster, it is configured using the `metadata-store-secrets`.

If `CA-SECRET` does not exist in the metadata store namespace, configure the certificate. See [Custom certificate configuration](#).

- Check if the `secretexport` and `secretimport` exist and are reconciling successfully by running:

```
kubectl get secretexports.secretgen.carvel.dev -n `METADASTORE-NAMESPACE`
kubectl get secretimports.secretgen.carvel.dev -n `DEV-NAMESPACE`
```

SCST - Store creates the single cluster `secretexport` by default. See [Deployment details and configuration](#). For information about creating the multicluster `secretexport`, see [Set up multicluster Supply Chain Security Tools \(SCST\) - Store](#).

- Verify that the `ca.crt` field in both secrets from `METADASTORE-NAMESPACE` and `DEV-NAMESPACE` match, or that the `ca.crt` field of the secret in the `METADASTORE-NAMESPACE` includes the `ca.crt` field of the `DEV-NAMESPACE` secret.

Confirm this by base64 decoding both secrets and verifying that there is a match:

```
kubectl get secret CA-SECRET -n DEV-NAMESPACE -o json | jq -r '.data."ca.crt"' | base64 -d
kubectl get secret CA-SECRET -n METADASTORE-NAMESPACE -o json | jq -r '.data."ca.crt"' | base64 -d
```

The certificates in the `METADASTORE-NAMESPACE` and `DEV-NAMESPACE` must have a match for the scanner to connect to the metadata-store.

Troubleshooting issues

Source scan missing in supply chain

The source scan step is opt-in in Tanzu Application Platform v1.6 to better support languages that resolve dependencies at build time. For information and how to opt-in to source scanning in the out-of-the-box test and scan supply chain, see [Scan Types for Supply Chain Security Tools - Scan](#).

Troubleshooting Grype in air gap Environments

For information about issues with Grype in air gap environments, see [Use vulnerability scanning in offline and air-gapped environments](#).

Missing target SSH secret

Scanning source code from a private source repository requires an SSH secret present in the namespace and referenced as `grype.targetSourceSshSecret` in `tap-values.yaml`. See [Installing the Tanzu Application Platform Package and Profiles](#).

If a private source scan is triggered and the secret cannot be found, the scan pod includes a `FailedMount` warning in Events with the message:

```
MountVolume.SetUp failed for volume "ssh-secret" : secret "secret-ssh-auth" not found
```

Where `secret-ssh-auth` is the value specified in `grype.targetSourceSshSecret`

Missing target image pull secret

Scanning an image from a private registry requires an image pull secret to exist in the Scan CRs namespace and be referenced as `grype.targetImagePullSecret` in `tap-values.yaml`. See [Installing the Tanzu Application Platform Package and Profiles](#).

If a private image scan is triggered and the secret is not configured, the scan TaskRun's pod's `step-scan-plugin` container fails with the following error:

```
Error: GET https://registry.example.com/v2/vse-dev/spring-petclinic/manifests/sha256:128e38c1d3f10401a595c253743bee343967c81e8f22b94e30b2ab8292b3973f: \
UNAUTHORIZED: unauthorized to access repository: vse-dev/spring-petclinic, action: pull: unauthorized to access repository: vse-dev/spring-petclinic, action: pull
```

Deactivate Supply Chain Security Tools (SCST) - Store

SCST - Store is required to install SCST - Scan.

1. If you install without the SCST - Store, you must edit the configurations to deactivate the Store:

```
---
metadataStore:
  url: ""
```

2. Install the package with the edited configurations by running:

```
tanzu package install scan-controller \
--package scanning.apps.tanzu.vmware.com \
--version VERSION \
--namespace tap-install \
--values-file tap-values.yaml
```

Resolving Incompatible Syft Schema Version

You might encounter the following error:

```
The provided SBOM has a Syft Schema Version which doesn't match the version that is supported by Grype...
```

This means that the Syft Schema Version from the provided SBOM doesn't match the version supported by the installed `grype-scanner`. There are two different methods to resolve this incompatibility issue:

1. Install a version of [Tanzu Build Service](#) that provides an SBOM with a compatible Syft Schema Version. This is the method VMware recommends.
2. Deactivate the `failOnSchemaErrors` in `grype-values.yaml`. See [Install Supply Chain Security Tools - Scan](#). Although this change bypasses the check on Syft Schema Version, it does not resolve the incompatibility issue and produces a partial scanning result.

```
syft:
  failOnSchemaErrors: false
```

Resolving incompatible scan policy

If your scan policy appears to not be enforced, it might be because the Rego file defined in the scan policy is incompatible with the scanner that is being used. For example, the Grype Scanner outputs in the CycloneDX XML format while the Snyk Scanner outputs SPDX JSON.

See [Sample ScanPolicy for Snyk in SPDX JSON format](#) for an example of a ScanPolicy formatted for SPDX JSON.

Could not find CA in secret

If you encounter the following issue, it might be due to not exporting `app-tls-cert` to the correct namespace:

```
{"level": "error", "ts": "2022-06-08T15:20:48.43237873Z", "logger": "setup", "msg": "Could not find CA in Secret", "err": "unable to set up connection to Supply Chain Security Tools - Store"}
```

Configure `ns_for_export_app_cert` in your `tap-values.yaml`.

```
metadata_store:
  ns_for_export_app_cert: "DEV-NAMESPACE"
```

Where `DEV-NAMESPACE` is the name of the developer namespace you want to use.

If there are multiple developer namespaces, use `ns_for_export_app_cert: "*" .`

Blob Source Scan is reporting wrong source URL

A Source Scan for a blob artifact can cause reporting in the `status.artifact` and `status.compliantArtifact` the wrong URL for the resource, passing the remote SSH URL instead of the cluster local fluxcd one. One symptom of this issue is the `image-builder` failing with a `ssh:// is an unsupported protocol` error message.

You can confirm you're having this problem by running `kubectl describe` in the affected resource and comparing the `spec.blob.url` value against the `status.artifact.blob.url`. The problem occurs if they are different URLs. For example:

```
kubectl describe sourcescan SOURCE-SCAN-NAME -n DEV-NAMESPACE
```

Where:

- `SOURCE-SCAN-NAME` is the name of the source scan you want to configure.
- `DEV-NAMESPACE` is the name of the developer namespace you want to use.

And compare the output:

```
...
spec:
  blob:
```

```

...
  url: http://source-controller.flux-system.svc.cluster.local./gitrepository/sample/
repo/8d4cea98b0fa9e0112d58414099d0229f190f7f1.tar.gz
...
status:
  artifact:
    blob:
      ...
      url: ssh://git@github.com:sample/repo.git
  compliantArtifact:
    blob:
      ...
      url: ssh://git@github.com:sample/repo.git

```

This problem happens in SCST - Scan **v1.2.0** when you use a Gype Scanner ScanTemplates earlier than **v1.2.0**, because this is a deprecated path. To fix this problem, upgrade your Gype Scanner deployment to **v1.2.0** or later. See [Upgrading Supply Chain Security Tools - Scan](#) for step-by-step instructions.

Resolving failing scans that block a Supply Chain

If the Supply Chain is not progressing due to CVEs found in either the SourceScan or ImageScan, see the CVE triage workflow in [Triaging and Remediating CVEs](#).

Policy not defined in the Tanzu Developer Portal

If you encounter **No policy has been defined**, it might be because the Tanzu Application Platform GUI is unable to view the Scan Policy resource.

Confirm that the Scan Policy associated with a SourceScan or ImageScan exists. For example, the `scanPolicy` in the scan matches the name of the Scan Policy.

```

kubectl describe sourcescan NAME -n DEV-NAMESPACE
kubectl describe imagescan NAME -n DEV-NAMESPACE
kubectl get scanpolicy NAME -n DEV-NAMESPACE

```

Where `DEV-NAMESPACE` is the name of the developer namespace you want to use.

Add the `app.kubernetes.io/part-of` label to the Scan Policy. See [Enable Tanzu Application Platform GUI to view ScanPolicy Resource](#).

Lookup error when connecting to SCST - Store

If your scan pod is failing, you might see the following connection error in the logs:

```

dial tcp: lookup metadata-store-app.metadata-store.svc.cluster.local on 10.100.0.10:5
3: no such host

```

A connection error while attempting to connect to the local cluster URL causes this error. If this is a multicluster deployment, set the `grype.metadataStore.url` property in your Build profile `values.yaml`. You must set the ingress domain of SCST - Store which is deployed in the View cluster. For information about this configuration, see [Install Build profile](#).

Sourcescan error with SCST - Store endpoint without a prefix

If your Source Scan resource is failing, the status might show this error:

```

Error: endpoint require 'http://' or 'https://' prefix

```

This is because the `grype.metadataStore.url` value in the Tanzu Application Platform profile `values.yaml` was not configured with the correct prefix. Verify that the URL starts with either `http://` or `https://`.

Deprecated pre-v1.2 templates

If the scan phase is in `Error` and the status condition message is:

```
Summary logs could not be retrieved: . error opening stream pod logs reader: container
summary is \
not valid for pod scan-grypeimagescan-sample-public-zmj2g-hqv5g
```

This error might be a consequence of using Grype Scanner ScanTemplates shipped with SCST - Scan v1.1 or earlier. These ScanTemplates are deprecated and are not supported in Tanzu Application Platform v1.4.0 and later.

There are two options to resolve this issue:

- Option 1: Upgrade to the latest Grype Scanner version. This automatically replaces the old ScanTemplates with the upgraded ScanTemplates.
- Option 2: Create a ScanTemplate. Follow the steps in [Create a scan template](#).

Incorrectly configured self-signed certificate

The following error in the pod logs indicate that the self-signed certificate might be incorrectly configured:

```
x509: certificate signed by unknown authority
```

To resolve this issue, ensure that `shared.ca_cert_data` contains the required certificate. For an example of setting up the shared self-signed certificate, see [Build profile](#).

For information about `shared.ca_cert_data`, see [View possible configuration settings for your package](#).

Unable to pull scan controller and scanner images from a specified registry

The `docker` field and related sub-fields by SCST - Scan Controller, Grype Scanner, or Snyk Scanner are deprecated in Tanzu Application Platform v1.4.0. Previously these text boxes might be used to populate the `registry-credentials` secret. You might encounter the following error during installation:

```
UNAUTHORIZED: unauthorized to access repository
```

The recommended migration path for users setting up their namespaces manually is to add registry credentials to both the developer namespace and the `scan-link-system` namespace, using these [instructions](#).



Important

This step does not apply to users who used `--export-to-all-namespaces` when setting up the Tanzu Application Platform package repository.

Grype database not available

Before running a scan, the Grype scanner downloads a copy of its database. If the database fails to download, the following log entry might appear.

```
Vulnerability DB [no update available] New version of grype is available: 0.50.2 [000
0] WARN unable \
to check for vulnerability database update 1 error occurred: * failed to load vulnerab
ility db: \
vulnerability database is corrupt (run db update to correct): database metadata not fo
und: \
~/Library/Caches/grype/db/3
```

To resolve this issue, ensure that Grype has access to its vulnerability database:

- If you set up a mirror of the vulnerability database in [Use vulnerability scanning in offline and air-gapped environments](#), verify that it is populated and reachable.
- If you did not set up a mirror, Grype manages its database behind the scenes. Verify that the cluster has access to <https://anchore.com/>.

This issue is unrelated to Supply Chain Security Tools for Tanzu – Store.

Scanner Pod restarts once in SCST - Scan v1.5.0 or later

For SCST - Scan v1.5.0 or later, you see scanner pods restart:

Pods				
NAME	READY	STATUS	RESTARTS	AGE
my-scan-45smk-pod	0/9	Completed	1	14m

One restart in scanner pods is expected with successful scans. To support Tanzu Service Mesh (TSM) integration, jobs were replaced with TaskRuns. This restart is an artifact of how Tekton cleans up sidecar containers by patching the container specifications.

Troubleshoot Rego files with a scan policy for Supply Chain Security Tools - Scan

This topic describes how you can use an example output to troubleshoot your Rego file for SCST - Scan. You use a Rego file in a scan policy custom resource. See [Enforce compliance policy using Open Policy Agent](#).

For information about how to write Rego, see [Open Policy Agent documentation](#).

Using the Rego playground

Use the [Rego Playground](#), to evaluate your Rego file against an input. In this example, use the example output of an image or source scan custom resource.

Sample input in CycloneDX's XML re-encoded as JSON format

The following is an example scan custom resource output in CycloneDX's XML structure re-encoded as JSON. This example output contains CVEs at low, medium, high, and critical severities.

To troubleshoot using this example output:

1. Paste your Rego file and the example output into the [Rego Playground](#).
2. Evaluate your Rego file against the example output and verify that your Rego file detects the intended CVEs. See this Rego [example](#).

```

{
  "bom": {
    "-serialNumber": "urn:uuid:123",
    "-v": "http://cyclonedx.org/schema/ext/vulnerability/1.0",
    "-version": "1",
    "-xmlns": "http://cyclonedx.org/schema/bom/1.2",
    "components": {
      "component": [
        {
          "-type": "library",
          "licenses": {
            "license": {
              "name": "GPL-2"
            }
          },
          "name": "adduser",
          "version": "3.118",
          "vulnerabilities": {
            "vulnerability": [
              {
                "-ref": "urn:uuid:3d7c61c6-9cfa-494c-858a-9668a318ff2
3",
                "advisories": {
                  "advisory": "https://security-tracker.debian.org/t
racker/CVE-2011-3374"
                },
                "id": "CVE-2011-3374-a",
                "ratings": {
                  "rating": {
                    "severity": "Low"
                  }
                },
                "source": {
                  "-name": "debian:10",
                  "url": "http://cve.mitre.org/cgi-bin/cvename.cgi?n
ame=CVE-2011-3374"
                }
              },
              {
                "-ref": "urn:uuid:ebabaa92-2bf9-4d33-8181-595b0fdf55b
d",
                "advisories": {
                  "advisory": "https://security-tracker.debian.org/t
racker/CVE-2020-27350"
                },
                "id": "CVE-2020-27350-a",
                "ratings": {
                  "rating": {
                    "severity": "Medium"
                  }
                },
                "source": {
                  "-name": "debian:10",
                  "url": "http://cve.mitre.org/cgi-bin/cvename.cgi?n
ame=CVE-2020-27350"
                }
              },
              {
                "-ref": "urn:uuid:07c58c81-1e01-459d-9e9d-0e10456a9bf
0",
                "advisories": {
                  "advisory": "https://security-tracker.debian.org/t
racker/CVE-2020-3810"
                },
                "id": "CVE-2020-3810-a",
                "ratings": {

```

```

        "rating": {
            "severity": "Medium"
        }
    },
    "source": {
        "-name": "debian:10",
        "url": "http://cve.mitre.org/cgi-bin/cvename.cgi?name=CVE-2020-3810"
    }
}
]
},
{
    "-type": "library",
    "licenses": {
        "license": [
            {
                "name": "GPL-2"
            },
            {
                "name": "GPLv2+"
            }
        ]
    },
    "name": "apt",
    "version": "1.8.2",
    "vulnerabilities": {
        "vulnerability": [
            {
                "-ref": "urn:uuid:3d7c61c6-9cfa-494c-858a-9668a318ff23",
                "advisories": {
                    "advisory": "https://security-tracker.debian.org/tracker/CVE-2011-3374"
                },
                "id": "CVE-2011-3374",
                "ratings": {
                    "rating": {
                        "severity": "Low"
                    }
                },
                "source": {
                    "-name": "debian:10",
                    "url": "http://cve.mitre.org/cgi-bin/cvename.cgi?name=CVE-2011-3374"
                }
            },
            {
                "-ref": "urn:uuid:ebabaa92-2bf9-4d33-8181-595b0fdf55bd",
                "advisories": {
                    "advisory": "https://security-tracker.debian.org/tracker/CVE-2020-27350"
                },
                "id": "CVE-2020-27350",
                "ratings": {
                    "rating": {
                        "severity": "High"
                    }
                },
                "source": {
                    "-name": "debian:10",
                    "url": "http://cve.mitre.org/cgi-bin/cvename.cgi?name=CVE-2020-27350"
                }
            }
        ]
    }
}
]
}
}

```

```

        },
        {
          "-ref": "urn:uuid:07c58c81-1e01-459d-9e9d-0e10456a9bf",
          "advisories": {
            "advisory": "https://security-tracker.debian.org/tracker/CVE-2020-3810"
          },
          "id": "CVE-2020-3810",
          "ratings": {
            "rating": {
              "severity": "Critical"
            }
          },
          "source": {
            "-name": "debian:10",
            "url": "http://cve.mitre.org/cgi-bin/cvename.cgi?name=CVE-2020-3810"
          }
        }
      ]
    },
    "metadata": {
      "component": {
        "-type": "container",
        "name": "nginx:1.16",
        "version": "sha256:123"
      },
      "timestamp": "2022-01-28T13:30:43-08:00",
      "tools": {
        "tool": {
          "name": "grype",
          "vendor": "anchore",
          "version": "[not provided]"
        }
      }
    }
  }
}

```

Example input in SPDX JSON format

The example in this section is a modified scan custom resource input, in `.spdx.json`, that contains CVEs at low, medium, high, and critical severities. You can use this example input to evaluate your Rego file.

To troubleshoot using this example output:

1. Paste your Rego file and the example input into the [Rego Playground](#).
2. Evaluate your Rego file against the output and verify that your Rego file detects the intended CVEs. See this [Rego example](#).

```

{
  "id": "SPDXRef-docker-image|nginx",
  "specVersion": "SPDX-3.0",
  "creator": "Organization: Snyk Ltd",
  "created": "2023-03-01T16:10:08Z",
  "profile": [
    "base",
    "vulnerabilities"
  ],
}

```



```

"description": "Snyk test result for project docker-image|nginx in SPDX SBOM format",
"vulnerabilities": [
  {
    "id": "SNYK-DEBIAN10-APT-1049974",
    "name": "SNYK-DEBIAN10-APT-1049974",
    "summary": "Integer Overflow or Wraparound",
    "details": "## NVD Description\n**_Note:_** _Versions mentioned in the description apply only to the upstream `apt` package and not the `apt` package as distributed by `Debian:10`. See `How to fix?` for `Debian:10` relevant fixed versions and status.\n\nAPT had several integer overflows and underflows while parsing .deb packages, aka GHSL-2020-168 GHSL-2020-169, in files apt-pkg/contrib/extracttar.cc, apt-pkg/deb/debfile.cc, and apt-pkg/contrib/arfile.cc. This issue affects: apt 1.2.32ubuntu0 versions prior to 1.2.32ubuntu0.2; 1.6.12ubuntu0 versions prior to 1.6.12ubuntu0.2; 2.0.2ubuntu0 versions prior to 2.0.2ubuntu0.2; 2.1.10ubuntu0 versions prior to 2.1.10ubuntu0.1;\n\n## Remediation\nUpgrade `Debian:10` `apt` to version 1.8.2.2 or higher.\n\n## References\n- [ADVISORY] (https://security-tracker.debian.org/tracker/CVE-2020-27350)\n- [CONFIRM] (https://bugs.launchpad.net/bugs/1899193)\n- [CONFIRM] (https://security.netapp.com/advisory/ntap-20210108-0005/)\n- [DEBIAN] (https://www.debian.org/security/2020/dsa-4808)\n- [UBUNTU] (https://usn.ubuntu.com/usn/usn-4667-1)\n",
    "relationships": [
      {
        "affect": {
          "to": [
            "docker-image|nginx@1.16",
            "apt/libapt-pkg5.0@1.8.2"
          ],
          "type": "AFFECTS"
        },
        "foundBy": {
          "to": [
            ""
          ],
          "type": "FOUND_BY"
        },
        "suppliedBy": {
          "to": [
            ""
          ],
          "type": "SUPPLIED_BY"
        },
        "ratedBy": {
          "to": [
            ""
          ],
          "type": "RATED_BY",
          "cwes": [
            190
          ],
          "rating": [
            {
              "method": "CVSS_3",
              "score": [
                {
                  "base": 5.7
                }
              ],
              "severity": "Medium",
              "vector": "CVSS:3.1/AV:L/AC:L/PR:H/UI:N/S:C/C:L/I:L/A:L"
            }
          ]
        }
      }
    ],
    "externalReferences": [
      {

```

```

    "category": "ADVISORY",
    "locator": "https://security-tracker.debian.org/tracker/CVE-2020-27350"
  },
  {
    "category": "ADVISORY",
    "locator": "https://bugs.launchpad.net/bugs/1899193"
  },
  {
    "category": "ADVISORY",
    "locator": "https://security.netapp.com/advisory/ntap-20210108-0005/"
  },
  {
    "category": "ADVISORY",
    "locator": "https://www.debian.org/security/2020/dsa-4808"
  },
  {
    "category": "ADVISORY",
    "locator": "https://usn.ubuntu.com/usn/usn-4667-1"
  }
],
"modified": "2022-10-29T13:11:02.438923Z",
"published": "2020-12-10T03:10:23.901831Z"
},
{
  "id": "SNYK-DEBIAN10-APT-407502",
  "name": "SNYK-DEBIAN10-APT-407502",
  "summary": "Improper Verification of Cryptographic Signature",
  "details": "## NVD Description\n**_Note:_** _Versions mentioned in the description apply only to the upstream `apt` package and not the `apt` package as distributed by `Debian:10`.\n_See `How to fix?` for `Debian:10` relevant fixed versions and status.\n\nIt was found that apt-key in apt, all versions, do not correctly validate gpg keys with the primary keyring, leading to a potential man-in-the-middle attack.\n## Remediation\nThere is no fixed version for `Debian:10` `apt`.\n## References\n- [ADVISORY] (https://security-tracker.debian.org/tracker/CVE-2011-3374)\n- [Debian Bug Report] (https://bugs.debian.org/cgi-bin/bugreport.cgi?bug=642480)\n- [MISC] (https://people.canonical.com/~ubuntu-security/cve/2011/CVE-2011-3374.html)\n- [MISC] (https://seclists.org/fulldisclosure/2011/Sep/221)\n- [MISC] (https://snyk.io/vuln/SNYK-LINUX-APT-116518)\n- [MISC] (https://ubuntu.com/security/CVE-2011-3374)\n- [RedHat CVE Database] (https://access.redhat.com/security/cve/cve-2011-3374)\n",
  "relationships": [
    {
      "affect": {
        "to": [
          "docker-image|nginx@1.16",
          "apt/libapt-pkg5.0@1.8.2"
        ],
        "type": "AFFECTS"
      },
      "foundBy": {
        "to": [
          ""
        ],
        "type": "FOUND_BY"
      },
      "suppliedBy": {
        "to": [
          ""
        ],
        "type": "SUPPLIED_BY"
      },
      "ratedBy": {
        "to": [
          ""
        ],
        "type": "RATED_BY",
        "cwes": [

```

```

    347
  ],
  "rating": [
    {
      "method": "CVSS_3",
      "score": [
        {
          "base": 3.7
        }
      ],
      "severity": "Low",
      "vector": "CVSS:3.1/AV:N/AC:H/PR:N/UI:N/S:U/C:N/I:L/A:N"
    }
  ]
},
"externalReferences": [
  {
    "category": "ADVISORY",
    "locator": "https://security-tracker.debian.org/tracker/CVE-2011-3374"
  },
  {
    "category": "ADVISORY",
    "locator": "https://bugs.debian.org/cgi-bin/bugreport.cgi?bug=642480"
  },
  {
    "category": "ADVISORY",
    "locator": "https://people.canonical.com/~ubuntu-security/cve/2011/CVE-2011-3374.html"
  },
  {
    "category": "ADVISORY",
    "locator": "https://seclists.org/fulldisclosure/2011/Sep/221"
  },
  {
    "category": "ADVISORY",
    "locator": "https://snyk.io/vuln/SNYK-LINUX-APT-116518"
  },
  {
    "category": "ADVISORY",
    "locator": "https://ubuntu.com/security/CVE-2011-3374"
  },
  {
    "category": "ADVISORY",
    "locator": "https://access.redhat.com/security/cve/cve-2011-3374"
  }
],
"modified": "2022-11-01T00:08:27.375895Z",
"published": "2018-06-27T16:20:45.037549Z"
},
{
  "id": "SNYK-DEBIAN10-APT-568926",
  "name": "SNYK-DEBIAN10-APT-568926",
  "summary": "Improper Input Validation",
  "details": "### NVD Description\n**_Note:_** _Versions mentioned in the descripti
on apply only to the upstream `apt` package and not the `apt` package as distributed b
y `Debian:10`.\n\n_See `How to fix?` for `Debian:10` relevant fixed versions and statu
s.\n\nMissing input validation in the ar/tar implementations of APT before version 2.
1.2 could result in denial of service when processing specially crafted deb files.\n##
Remediation\nUpgrade `Debian:10` `apt` to version 1.8.2.1 or higher.\n## References\n-
[ADVISORY] (https://security-tracker.debian.org/tracker/CVE-2020-3810)\n- [FEDORA] (http
s://lists.fedoraproject.org/archives/list/package-announce@lists.fedoraproject.org/mes
sage/U4PEH357M2M2SUGKETMEHMSGQS652QHH/)\n- [GitHub Issue] (https://github.com/Debian/ap
t/issues/111)\n- [MISC] (https://bugs.launchpad.net/bugs/1878177)\n- [MISC] (https://lis
ts.debian.org/debian-security-announce/2020/msg00089.html)\n- [MISC] (https://salsa.deb

```

```

ian.org/apt-team/apt/-/commit/dceb1e49e4b8e4dadaf056be34088b415939cda6)\n- [MISC](http
s://tracker.debian.org/news/1144109/accepted-apt-212-source-into-unstable/)\n- [UBUNT
U](https://usn.ubuntu.com/4359-2/)\n- [Ubuntu CVE Tracker](http://people.ubuntu.com/~u
buntu-security/cve/CVE-2020-3810)\n- [Ubuntu Security Advisory](https://usn.ubuntu.co
m/4359-1/)\n",
  "relationships": [
    {
      "affect": {
        "to": [
          "docker-image|nginx@1.16",
          "apt/libapt-pkg5.0@1.8.2"
        ],
        "type": "AFFECTS"
      },
      "foundBy": {
        "to": [
          ""
        ],
        "type": "FOUND_BY"
      },
      "suppliedBy": {
        "to": [
          ""
        ],
        "type": "SUPPLIED_BY"
      },
      "ratedBy": {
        "to": [
          ""
        ],
        "type": "RATED_BY",
        "cwes": [
          20
        ],
        "rating": [
          {
            "method": "CVSS_3",
            "score": [
              {
                "base": 5.5
              }
            ],
            "severity": "Medium",
            "vector": "CVSS:3.1/AV:L/AC:L/PR:N/UI:R/S:U/C:N/I:N/A:H"
          }
        ]
      }
    }
  ],
  "externalReferences": [
    {
      "category": "ADVISORY",
      "locator": "https://security-tracker.debian.org/tracker/CVE-2020-3810"
    },
    {
      "category": "ADVISORY",
      "locator": "https://lists.fedoraproject.org/archives/list/package-announce@l
ists.fedoraproject.org/message/U4PEH357M2M2SUGKETMEHMSGQS652QHH/"
    },
    {
      "category": "ADVISORY",
      "locator": "https://github.com/Debian/apt/issues/111"
    },
    {
      "category": "ADVISORY",
      "locator": "https://bugs.launchpad.net/bugs/1878177"
    }
  ]
}

```

```

    },
    {
      "category": "ADVISORY",
      "locator": "https://lists.debian.org/debian-security-announce/2020/msg00089.
html"
    },
    {
      "category": "ADVISORY",
      "locator": "https://salsa.debian.org/apt-team/apt/-/commit/dceble49e4b8e4dad
af056be34088b415939cda6"
    },
    {
      "category": "ADVISORY",
      "locator": "https://tracker.debian.org/news/1144109/accepted-apt-212-source-
into-unstable/"
    },
    {
      "category": "ADVISORY",
      "locator": "https://usn.ubuntu.com/4359-2/"
    },
    {
      "category": "ADVISORY",
      "locator": "http://people.ubuntu.com/~ubuntu-security/cve/CVE-2020-3810"
    },
    {
      "category": "ADVISORY",
      "locator": "https://usn.ubuntu.com/4359-1/"
    }
  ],
  "modified": "2022-11-01T00:08:51.907776Z",
  "published": "2020-05-12T14:19:01.052295Z"
},
{
  "id": "SNYK-DEBIAN10-APT-1049974",
  "name": "SNYK-DEBIAN10-APT-1049974",
  "summary": "Integer Overflow or Wraparound",
  "details": "## NVD Description\n**_Note:_** _Versions mentioned in the descripti
on apply only to the upstream `apt` package and not the `apt` package as distributed b
y `Debian:10`.\n_See `How to fix?` for `Debian:10` relevant fixed versions and statu
s.\n\nAPT had several integer overflows and underflows while parsing .deb packages, a
ka GHSL-2020-168 GHSL-2020-169, in files apt-pkg/contrib/extracttar.cc, apt-pkg/deb/de
bfile.cc, and apt-pkg/contrib/arfile.cc. This issue affects: apt 1.2.32ubuntu0 versio
s prior to 1.2.32ubuntu0.2; 1.6.12ubuntu0 versions prior to 1.6.12ubuntu0.2; 2.0.2ubun
tu0 versions prior to 2.0.2ubuntu0.2; 2.1.10ubuntu0 versions prior to 2.1.10ubuntu0.
1;\n## Remediation\nUpgrade `Debian:10` `apt` to version 1.8.2.2 or higher.\n## Refere
nces\n- [ADVISORY] (https://security-tracker.debian.org/tracker/CVE-2020-27350)\n- [CON
FIRM] (https://bugs.launchpad.net/bugs/1899193)\n- [CONFIRM] (https://security.netapp.co
m/advisory/ntap-20210108-0005/)\n- [DEBIAN] (https://www.debian.org/security/2020/dsa-4
808)\n- [UBUNTU] (https://usn.ubuntu.com/usn/usn-4667-1)\n",
  "relationships": [
    {
      "affect": {
        "to": [
          "docker-image|nginx@1.16",
          "apt@1.8.2",
          "apt/libapt-pkg5.0@1.8.2"
        ],
        "type": "AFFECTS"
      },
      "foundBy": {
        "to": [
          ""
        ],
        "type": "FOUND_BY"
      },
      "suppliedBy": {

```

```

    "to": [
      ""
    ],
    "type": "SUPPLIED_BY"
  },
  "ratedBy": {
    "to": [
      ""
    ],
    "type": "RATED_BY",
    "cwes": [
      190
    ],
    "rating": [
      {
        "method": "CVSS_3",
        "score": [
          {
            "base": 5.7
          }
        ],
        "severity": "Medium",
        "vector": "CVSS:3.1/AV:L/AC:L/PR:H/UI:N/S:C/C:L/I:L/A:L"
      }
    ]
  }
}
],
"externalReferences": [
  {
    "category": "ADVISORY",
    "locator": "https://security-tracker.debian.org/tracker/CVE-2020-27350"
  },
  {
    "category": "ADVISORY",
    "locator": "https://bugs.launchpad.net/bugs/1899193"
  },
  {
    "category": "ADVISORY",
    "locator": "https://security.netapp.com/advisory/ntap-20210108-0005/"
  },
  {
    "category": "ADVISORY",
    "locator": "https://www.debian.org/security/2020/dsa-4808"
  },
  {
    "category": "ADVISORY",
    "locator": "https://usn.ubuntu.com/usn/usn-4667-1"
  }
],
"modified": "2022-10-29T13:11:02.438923Z",
"published": "2020-12-10T03:10:23.901831Z"
},
{
  "id": "SNYK-DEBIAN10-APT-407502",
  "name": "SNYK-DEBIAN10-APT-407502",
  "summary": "Improper Verification of Cryptographic Signature",
  "details": "### NVD Description\n**_Note:** _Versions mentioned in the descripti
on apply only to the upstream `apt` package and not the `apt` package as distributed b
y `Debian:10`.\nSee `How to fix?` for `Debian:10` relevant fixed versions and statu
s.\n\nIt was found that apt-key in apt, all versions, do not correctly validate gpg k
eys with the primary keyring, leading to a potential man-in-the-middle attack.\n## Rem
ediation\nThere is no fixed version for `Debian:10` `apt`.\n## References\n- [ADVISOR
Y] (https://security-tracker.debian.org/tracker/CVE-2011-3374)\n- [Debian Bug Report] (h
ttps://bugs.debian.org/cgi-bin/bugreport.cgi?bug=642480)\n- [MISC] (https://people.cano
nical.com/~ubuntu-security/cve/2011/CVE-2011-3374.html)\n- [MISC] (https://seclists.or

```

```

g/fulldisclosure/2011/Sep/221)\n- [MISC](https://snyk.io/vuln/SNYK-LINUX-APT-116518)\n
- [MISC](https://ubuntu.com/security/CVE-2011-3374)\n- [RedHat CVE Database](https://a
ccess.redhat.com/security/cve/cve-2011-3374)\n",
  "relationships": [
    {
      "affect": {
        "to": [
          "docker-image|nginx@1.16",
          "apt@1.8.2",
          "apt/libapt-pkg5.0@1.8.2"
        ],
        "type": "AFFECTS"
      },
      "foundBy": {
        "to": [
          ""
        ],
        "type": "FOUND_BY"
      },
      "suppliedBy": {
        "to": [
          ""
        ],
        "type": "SUPPLIED_BY"
      },
      "ratedBy": {
        "to": [
          ""
        ],
        "type": "RATED_BY",
        "cwes": [
          347
        ],
        "rating": [
          {
            "method": "CVSS_3",
            "score": [
              {
                "base": 3.7
              }
            ],
            "severity": "Low",
            "vector": "CVSS:3.1/AV:N/AC:H/PR:N/UI:N/S:U/C:N/I:L/A:N"
          }
        ]
      }
    }
  ],
  "externalReferences": [
    {
      "category": "ADVISORY",
      "locator": "https://security-tracker.debian.org/tracker/CVE-2011-3374"
    },
    {
      "category": "ADVISORY",
      "locator": "https://bugs.debian.org/cgi-bin/bugreport.cgi?bug=642480"
    },
    {
      "category": "ADVISORY",
      "locator": "https://people.canonical.com/~ubuntu-security/cve/2011/CVE-2011-
3374.html"
    },
    {
      "category": "ADVISORY",
      "locator": "https://seclists.org/fulldisclosure/2011/Sep/221"
    }
  ],

```

```

    {
      "category": "ADVISORY",
      "locator": "https://snyk.io/vuln/SNYK-LINUX-APT-116518"
    },
    {
      "category": "ADVISORY",
      "locator": "https://ubuntu.com/security/CVE-2011-3374"
    },
    {
      "category": "ADVISORY",
      "locator": "https://access.redhat.com/security/cve/cve-2011-3374"
    }
  ],
  "modified": "2022-11-01T00:08:27.375895Z",
  "published": "2018-06-27T16:20:45.037549Z"
},
{
  "id": "SNYK-DEBIAN10-EXPAT-2329087",
  "name": "SNYK-DEBIAN10-EXPAT-2329087",
  "summary": "Incorrect Calculation",
  "details": "## NVD Description\n**_Note:** _Versions mentioned in the descripti
on apply only to the upstream `expat` package and not the `expat` package as distribut
ed by `Debian:10`.\n_See `How to fix?` for `Debian:10` relevant fixed versions and st
atus.\n\nIn Expat (aka libexpat) before 2.4.3, a left shift by 29 (or more) places in
the storeAtts function in xmlparse.c can lead to realloc misbehavior (e.g., allocating
too few bytes, or only freeing memory).\n## Remediation\nUpgrade `Debian:10` `expat` t
o version 2.2.6-2+deb10u2 or higher.\n## References\n- [ADVISORY](https://security-tra
cker.debian.org/tracker/CVE-2021-45960)\n- [MISC](https://bugzilla.mozilla.org/show_bu
g.cgi?id=1217609)\n- [MISC](https://github.com/libexpat/libexpat/issues/531)\n- [MISC]
(https://github.com/libexpat/libexpat/pull/534)\n- [cve@mitre.org](http://www.openwal
l.com/lists/oss-security/2022/01/17/3)\n- [cve@mitre.org](https://security.netapp.com/
advisory/ntap-20220121-0004/)\n- [cve@mitre.org](https://www.tenable.com/security/tns-
2022-05)\n- [cve@mitre.org](https://www.debian.org/security/2022/dsa-5073)\n- [cve@mit
re.org](https://cert-portal.siemens.com/productcert/pdf/ssa-484086.pdf)\n- [cve@mitre.
org](https://security.gentoo.org/glsa/202209-24)\n",
  "relationships": [
    {
      "affect": {
        "to": [
          "docker-image|nginx@1.16",
          "nginx-module-image-filter@1.16.1-1~buster",
          "libgd2/libgd3@2.2.5-5.2",
          "fontconfig/libfontconfig1@2.13.1-2",
          "expat/libexpat1@2.2.6-2+deb10u1"
        ],
        "type": "AFFECTS"
      },
      "foundBy": {
        "to": [
          ""
        ],
        "type": "FOUND_BY"
      },
      "suppliedBy": {
        "to": [
          ""
        ],
        "type": "SUPPLIED_BY"
      },
      "ratedBy": {
        "to": [
          ""
        ],
        "type": "RATED_BY",
        "cwes": [
          682
        ]
      }
    }
  ]
}

```



```

    ],
    "rating": [
      {
        "method": "CVSS_3",
        "score": [
          {
            "base": 8.8
          }
        ],
        "severity": "High",
        "vector": "CVSS:3.1/AV:N/AC:L/PR:L/UI:N/S:U/C:H/I:H/A:H"
      }
    ]
  },
  "externalReferences": [
    {
      "category": "ADVISORY",
      "locator": "https://security-tracker.debian.org/tracker/CVE-2021-45960"
    },
    {
      "category": "ADVISORY",
      "locator": "https://bugzilla.mozilla.org/show_bug.cgi?id=1217609"
    },
    {
      "category": "ADVISORY",
      "locator": "https://github.com/libexpat/libexpat/issues/531"
    },
    {
      "category": "ADVISORY",
      "locator": "https://github.com/libexpat/libexpat/pull/534"
    },
    {
      "category": "ADVISORY",
      "locator": "http://www.openwall.com/lists/oss-security/2022/01/17/3"
    },
    {
      "category": "ADVISORY",
      "locator": "https://security.netapp.com/advisory/ntap-20220121-0004/"
    },
    {
      "category": "ADVISORY",
      "locator": "https://www.tenable.com/security/tns-2022-05"
    },
    {
      "category": "ADVISORY",
      "locator": "https://www.debian.org/security/2022/dsa-5073"
    },
    {
      "category": "ADVISORY",
      "locator": "https://cert-portal.siemens.com/productcert/pdf/ssa-484086.pdf"
    },
    {
      "category": "ADVISORY",
      "locator": "https://security.gentoo.org/glsa/202209-24"
    }
  ],
  "modified": "2023-02-14T13:37:37.505975Z",
  "published": "2022-01-02T01:41:26.770663Z"
},
{
  "id": "SNYK-DEBIAN10-EXPAT-2331803",
  "name": "SNYK-DEBIAN10-EXPAT-2331803",
  "summary": "Integer Overflow or Wraparound",
  "details": "### NVD Description\n**_Note: ** _Versions mentioned in the descripti

```

```

on apply only to the upstream `expat` package and not the `expat` package as distributed by `Debian:10`. See `How to fix?` for `Debian:10` relevant fixed versions and status.
\ndefineAttribute in xmlparse.c in Expat (aka libexpat) before 2.4.3 has an integer overflow.
## Remediation
Upgrade `Debian:10` `expat` to version 2.2.6-2+deb10u2 or higher.
## References
- [ADVISORY] (https://security-tracker.debian.org/tracker/CVE-2022-22824)
- [cve@mitre.org] (https://github.com/libexpat/libexpat/pull/539)
- [cve@mitre.org] (http://www.openwall.com/lists/oss-security/2022/01/17/3)
- [cve@mitre.org] (https://www.tenable.com/security/tns-2022-05)
- [cve@mitre.org] (https://www.debian.org/security/2022/dsa-5073)
- [cve@mitre.org] (https://cert-portal.siemens.com/productcert/pdf/ssa-484086.pdf)
- [cve@mitre.org] (https://security.gentoo.org/glsa/2022-09-24)
",
  "relationships": [
    {
      "affect": {
        "to": [
          "docker-image|nginx@1.16",
          "nginx-module-image-filter@1.16.1-1~buster",
          "libgd2/libgd3@2.2.5-5.2",
          "fontconfig/libfontconfig1@2.13.1-2",
          "expat/libexpat1@2.2.6-2+deb10u1"
        ],
        "type": "AFFECTS"
      },
      "foundBy": {
        "to": [
          ""
        ],
        "type": "FOUND_BY"
      },
      "suppliedBy": {
        "to": [
          ""
        ],
        "type": "SUPPLIED_BY"
      },
      "ratedBy": {
        "to": [
          ""
        ],
        "type": "RATED_BY",
        "cwes": [
          190
        ],
        "rating": [
          {
            "method": "CVSS_3",
            "score": [
              {
                "base": 9.8
              }
            ],
            "severity": "Critical",
            "vector": "CVSS:3.1/AV:N/AC:L/PR:N/UI:N/S:U/C:H/I:H/A:H"
          }
        ]
      }
    }
  ],
  "externalReferences": [
    {
      "category": "ADVISORY",
      "locator": "https://security-tracker.debian.org/tracker/CVE-2022-22824"
    },
    {
      "category": "ADVISORY",
      "locator": "https://github.com/libexpat/libexpat/pull/539"
    }
  ]
}

```

```

    },
    {
      "category": "ADVISORY",
      "locator": "http://www.openwall.com/lists/oss-security/2022/01/17/3"
    },
    {
      "category": "ADVISORY",
      "locator": "https://www.tenable.com/security/tns-2022-05"
    },
    {
      "category": "ADVISORY",
      "locator": "https://www.debian.org/security/2022/dsa-5073"
    },
    {
      "category": "ADVISORY",
      "locator": "https://cert-portal.siemens.com/productcert/pdf/ssa-484086.pdf"
    },
    {
      "category": "ADVISORY",
      "locator": "https://security.gentoo.org/glsa/202209-24"
    }
  ],
  "modified": "2023-02-14T13:39:18.516672Z",
  "published": "2022-01-08T13:52:14.479733Z"
}
],
"name": "docker-image|nginx-sha256:d20aa6d1cae56fd17cd458f4807e0de462caf2336f0b70b5e
eb69fcaaf30dd9c",
"dataLicense": "CC0-1.0",
"documentNamespace": "spdx.org/spdxdocs/docker-image|nginx-feb02ce6-cd47-49c2-9a97-2
b4833b4a1f0",
"relationships": [
  {
    "from": "SPDXRef-docker-image|nginx",
    "to": [
      "SPDXRef-index.docker.io/library/nginx-sha256:d20aa6d1cae56fd17cd458f4807e0de4
62caf2336f0b70b5eeb69fcaaf30dd9c"
    ],
    "type": "DESCRIBES"
  }
],
"packages": [
  {
    "SPDXID": "SPDXRef-index.docker.io/library/nginx-sha256:d20aa6d1cae56fd17cd458f4
807e0de462caf2336f0b70b5eeb69fcaaf30dd9c",
    "versionInfo": "sha256:d20aa6d1cae56fd17cd458f4807e0de462caf2336f0b70b5eeb69fcaa
f30dd9c",
    "id": "SPDXRef-index.docker.io/library/nginx-sha256:d20aa6d1cae56fd17cd458f4807e
0de462caf2336f0b70b5eeb69fcaaf30dd9c",
    "name": "index.docker.io/library/nginx",
    "checksums": [
      {
        "algorithm": "SHA256",
        "checksumValue": "d20aa6d1cae56fd17cd458f4807e0de462caf2336f0b70b5eeb69fcaaf
30dd9c"
      }
    ]
  }
]
}
]
}

```

Configure code repositories and image artifacts for Supply Chain Security Tools - Scan

This topic describes how you can configure code repositories and image artifacts for SCST - Scan.

Prerequisite

Both the source and image scans require you to define a `ScanTemplate`. Run `kubectl get scantemplates` for the ScanTemplates provided with the scanner installation. For information about how to reference these ScanTemplates, see [How to create a ScanTemplate](#).

Deploy scan custom resources

The scan controller defines two custom resources to create scans:

- SourceScan
- ImageScan

SourceScan

The `SourceScan` custom resource helps you define and trigger a scan for a given repository. You can deploy `SourceScan` with source code existing in a public repository or a private one:

1. Create the `SourceScan` custom resource.

Example:

```
apiVersion: scanning.apps.tanzu.vmware.com/v1beta1
kind: SourceScan
metadata:
  # set the name of the source scan CR
  name: sample-source-scan
spec:
  # At least one of these fields (blob or git) must be defined.
  blob:
    # location to a file with the source code compressed (supported files: .tar.gz)
    url:
  git:
    # A multiline string defining the known hosts that are going to be used for
the SSH client on the container
    knownHosts:
    # Branch, tag, or commit digest
    revision:
    # The name of the kubernetes secret containing the private SSH key information.
    sshKeySecret:
    # A string containing the repository URL.
    url:
    # The username needed to SSH connection. Default value is "git"
    username:

    # A string defining the name of an existing ScanTemplate custom resource.
    scanTemplate: my-scan-template

    # A string defining the name of an existing ScanPolicy custom resource. See
"Enforcement Policies (OPA)" section.
    scanPolicy: my-scan-policy
```

2. Deploy the `SourceScan` custom resource to the desired namespace on cluster by running:

```
kubectl apply -f <path_to_the_cr>/<custom_resource_filename>.yaml -n <desired_namespace>
```

After the scanning completes, the following fields appear in the custom resource and are filled by the scanner:

```
# These fields are populated from the source scan results
status:
  # The source code information as provided in the CycloneDX `bom>metadata>component>` fields
  artifact:
    blob:
      url:
    git:
      url:
      revision:

  # An array populated with information about the scanning status
  # and the policy validation. These conditions might change in the lifecycle
  # of the scan, refer to the "View Scan Status and Understanding Conditions" section to learn more.
  conditions: []

  # The URL of the vulnerability scan results in the Metadata Store integration.
  # Only available when the integration is configured.
  metadataUrl:

  # When the CRD is updated to point at new revisions, this lets you know
  # if the status reflects the latest one or not
  observedGeneration: 1
  observedPolicyGeneration: 1
  observedTemplateGeneration: 1

  # The latest datetime when the scanning was successfully finished.
  scannedAt:
  # Information about the scanner that was used for the latest image scan.
  # This information reflects what's in the CycloneDX `bom>metadata>tools>tool>` fields.
  scannedBy:
    scanner:
      # The name of the scanner that was used.
      name: my-image-scanner

      # The name of the scanner's development company or team
      vendor: my-image-scanner-provider

      # The version of the scanner used.
      version: 1.0.0
```

ImageScan

The `ImageScan` custom resource helps you define and trigger a scan for a given image. You can deploy `ImageScan` with an image existing in a public or private registry:

1. Create the `ImageScan` custom resource.

Example:

```
apiVersion: scanning.apps.tanzu.vmware.com/v1beta1
kind: ImageScan
metadata:
  # set the name of the image scan CR
  name: sample-image-scan
spec:
  registry:
    # Required. A string containing the image name can additionally add its tag
```

```

or its digest
  image: nginx:1.16

  # A string containing the secret needed to pull the image from a private registry.
  # The secret needs to be deployed in the same namespace as the ImageScan
  imagePullSecret: my-image-pull-secret

  # A string defining the name of an existing ScanTemplate custom resource. See
  "How To Create a ScanTemplate" section.
  scanTemplate: my-scan-template

  # A string defining the name of an existing ScanPolicy custom resource. See
  "Enforcement Policies (OPA)" section.
  scanPolicy: my-scan-policy

```

2. Deploy the `ImageScan` custom resource to the desired namespace on cluster by running:

```
kubectl apply -f <path_to_the_cr>/<custom_resource_filename>.yaml -n <desired_namespace>
```

After the scanning completes, the following fields appear in the custom resource and are filled by the scanner:

```

# These fields are populated from the image scan results
status:
  artifact:
    registry:
      # The image name with its digest as provided in the CycloneDX `bom>metadata>component>` fields
      image:
      imagePullSecret:

      # An array that is populated with information about the scanning status
      # and the policy validation. These conditions might change in the lifecycle
      # of the scan, refer to the "View Scan Status and Understanding Conditions" section to learn more.
      conditions: []

      # The URL of the vulnerability scan results in the Metadata Store integration.
      # Only available when the integration is configured.
      metadataUrl:

      # When the CRD is updated to point at new revisions, this lets you know
      # whether the status reflects the latest one
      observedGeneration: 1
      observedPolicyGeneration: 1
      observedTemplateGeneration: 1

      # The latest datetime when the scanning was successfully finished.
      scannedAt:
      # Information about the scanner used for the latest image scan.
      # This information reflects what's in the CycloneDX `bom>metadata>tools>tool>` fields.
      scannedBy:
        scanner:
          # The name of the scanner that was used.
          name: my-image-scanner

          # The name of the scanner's development company or team
          vendor: my-image-scanner-provider

```

```
# The version of the scanner used.
version: 1.0.0
```

Configure code repositories and image artifacts for Supply Chain Security Tools - Scan

This topic describes how you can configure code repositories and image artifacts for SCST - Scan.

Prerequisite

Both the source and image scans require you to define a `ScanTemplate`. Run `kubectl get scantemplates` for the ScanTemplates provided with the scanner installation. For information about how to reference these ScanTemplates, see [How to create a ScanTemplate](#).

Deploy scan custom resources

The scan controller defines two custom resources to create scans:

- SourceScan
- ImageScan

SourceScan

The `SourceScan` custom resource helps you define and trigger a scan for a given repository. You can deploy `SourceScan` with source code existing in a public repository or a private one:

1. Create the `SourceScan` custom resource.

Example:

```
apiVersion: scanning.apps.tanzu.vmware.com/v1beta1
kind: SourceScan
metadata:
  # set the name of the source scan CR
  name: sample-source-scan
spec:
  # At least one of these fields (blob or git) must be defined.
  blob:
    # location to a file with the source code compressed (supported files: .tar.gz)
    url:
  git:
    # A multiline string defining the known hosts that are going to be used for
the SSH client on the container
    knownHosts:
    # Branch, tag, or commit digest
    revision:
    # The name of the kubernetes secret containing the private SSH key information.
    sshKeySecret:
    # A string containing the repository URL.
    url:
    # The username needed to SSH connection. Default value is "git"
    username:

  # A string defining the name of an existing ScanTemplate custom resource.
  scanTemplate: my-scan-template

  # A string defining the name of an existing ScanPolicy custom resource. See
```

```
"Enforcement Policies (OPA)" section.
  scanPolicy: my-scan-policy
```

2. Deploy the `SourceScan` custom resource to the desired namespace on cluster by running:

```
kubectl apply -f <path_to_the_cr>/<custom_resource_filename>.yaml -n <desired_namespace>
```

After the scanning completes, the following fields appear in the custom resource and are filled by the scanner:

```
# These fields are populated from the source scan results
status:
  # The source code information as provided in the CycloneDX `bom>metadata>component>` fields
  artifact:
    blob:
      url:
    git:
      url:
      revision:

  # An array populated with information about the scanning status
  # and the policy validation. These conditions might change in the lifecycle
  # of the scan, refer to the "View Scan Status and Understanding Conditions" section to learn more.
  conditions: []

  # The URL of the vulnerability scan results in the Metadata Store integration.
  # Only available when the integration is configured.
  metadataUrl:

  # When the CRD is updated to point at new revisions, this lets you know
  # if the status reflects the latest one or not
  observedGeneration: 1
  observedPolicyGeneration: 1
  observedTemplateGeneration: 1

  # The latest datetime when the scanning was successfully finished.
  scannedAt:
  # Information about the scanner that was used for the latest image scan.
  # This information reflects what's in the CycloneDX `bom>metadata>tools>tool>` fields.
  scannedBy:
    scanner:
      # The name of the scanner that was used.
      name: my-image-scanner

      # The name of the scanner's development company or team
      vendor: my-image-scanner-provider

      # The version of the scanner used.
      version: 1.0.0
```

ImageScan

The `ImageScan` custom resource helps you define and trigger a scan for a given image. You can deploy `ImageScan` with an image existing in a public or private registry:

1. Create the `ImageScan` custom resource.

Example:

```

apiVersion: scanning.apps.tanzu.vmware.com/v1beta1
kind: ImageScan
metadata:
  # set the name of the image scan CR
  name: sample-image-scan
spec:
  registry:
    # Required. A string containing the image name can additionally add its tag
    # or its digest
    image: nginx:1.16

    # A string containing the secret needed to pull the image from a private re
    # gistry.
    # The secret needs to be deployed in the same namespace as the ImageScan
    imagePullSecret: my-image-pull-secret

    # A string defining the name of an existing ScanTemplate custom resource. See
    # "How To Create a ScanTemplate" section.
    scanTemplate: my-scan-template

    # A string defining the name of an existing ScanPolicy custom resource. See
    # "Enforcement Policies (OPA)" section.
    scanPolicy: my-scan-policy

```

2. Deploy the `ImageScan` custom resource to the desired namespace on cluster by running:

```

kubectl apply -f <path_to_the_cr>/<custom_resource_filename>.yaml -n <desired_n
amespace>

```

After the scanning completes, the following fields appear in the custom resource and are filled by the scanner:

```

# These fields are populated from the image scan results
status:
  artifact:
    registry:
      # The image name with its digest as provided in the CycloneDX `bom>metada
      # ta>component>*<` fields
      image:
      imagePullSecret:

    # An array that is populated with information about the scanning status
    # and the policy validation. These conditions might change in the lifecycle
    # of the scan, refer to the "View Scan Status and Understanding Conditions" s
    # ection to learn more.
    conditions: []

    # The URL of the vulnerability scan results in the Metadata Store integratio
    # n.
    # Only available when the integration is configured.
    metadataUrl:

    # When the CRD is updated to point at new revisions, this lets you know
    # whether the status reflects the latest one
    observedGeneration: 1
    observedPolicyGeneration: 1
    observedTemplateGeneration: 1

    # The latest datetime when the scanning was successfully finished.
    scannedAt:
    # Information about the scanner used for the latest image scan.
    # This information reflects what's in the CycloneDX `bom>metadata>tools>tool>
    # *` fields.
    scannedBy:

```

```

scanner:
  # The name of the scanner that was used.
  name: my-image-scanner

  # The name of the scanner's development company or team
  vendor: my-image-scanner-provider

  # The version of the scanner used.
  version: 1.0.0

```

Enforce compliance policy using Open Policy Agent

This topic describes how you can use Open Policy Agent to enforce compliance policy for Supply Chain Security Tools - Scan.

Writing a policy template

The Scan Policy custom resource (CR) allows you to define a Rego file for policy enforcement that you can reuse across image scan and source scan CRs.

The Scan Controller supports policy enforcement by using an Open Policy Agent (OPA) engine with Rego files. This allows you to validate scan results for company policy compliance and can prevent source code from being built or images from being deployed.

Rego file contract

To define a Rego file for an image scan or source scan, you must comply with the requirements defined for every Rego file for the policy verification to work. For information about how to write Rego, see [Open Policy Agent documentation](#).

- **Package main:** The Rego file must define a package in its body called `main`. The system looks for this package to verify the scan results compliance.
- **Input match:** The Rego file evaluates one vulnerability match at a time, iterating as many times as the Rego file finds vulnerabilities in the scan. The match structure is accessed in the `input.currentVulnerability` object inside the Rego file and has the `CycloneDX` format.
- **deny rule:** The Rego file must define a `deny` rule inside its body. `deny` is a set of error messages that are returned to the user. Each rule you write adds to that set of error messages. If the conditions in the body of the `deny` statement are true then the user is handed an error message. If false, the vulnerability is allowed in the Source or Image scan.

Define a Rego file for policy enforcement

Follow these steps to define a Rego file for policy enforcement that you can reuse across image scan and source scan CRs that output in the CycloneDX XML format.



Note

The Snyk Scanner outputs SPDX JSON. For an example of a ScanPolicy formatted for SPDX JSON output, see [Sample ScanPolicy for Snyk in SPDX JSON format](#).

1. Create a scan policy with a Rego file. The following is an example scan policy resource:

```

---
apiVersion: scanning.apps.tanzu.vmware.com/v1beta1
kind: ScanPolicy

```

```

metadata:
  name: scan-policy
  labels:
    app.kubernetes.io/part-of: enable-in-gui
spec:
  regoFile: |
    package main

    # Accepted Values: "Critical", "High", "Medium", "Low", "Negligible", "Unkn
ownSeverity"
    notAllowedSeverities := ["Critical", "High", "UnknownSeverity"]
    ignoreCves := []

    contains(array, elem) = true {
      array[_] = elem
    } else = false { true }

    isSafe(match) {
      severities := { e | e := match.ratings.rating.severity } | { e | e := mat
ch.ratings.rating[_].severity }
      some i
      fails := contains(notAllowedSeverities, severities[i])
      not fails
    }

    isSafe(match) {
      ignore := contains(ignoreCves, match.id)
      ignore
    }

    deny[msg] {
      comps := { e | e := input.bom.components.component } | { e | e := input.b
om.components.component[_] }
      some i
      comp := comps[i]
      vulns := { e | e := comp.vulnerabilities.vulnerability } | { e | e := com
p.vulnerabilities.vulnerability[_] }
      some j
      vuln := vulns[j]
      ratings := { e | e := vuln.ratings.rating.severity } | { e | e := vuln.ra
tings.rating[_].severity }
      not isSafe(vuln)
      msg = sprintf("CVE %s %s %s", [comp.name, vuln.id, ratings])
    }

```

You can edit the following text boxes of the Rego file as part of the [CVE triage workflow](#):

- o `notAllowedSeverities` contains the categories of CVEs that cause the SourceScan or ImageScan failing policy enforcement. The following example shows an `app-operator` blocking only `Critical`, `High` and `UnknownSeverity` CVEs.

```

...
spec:
  regoFile: |
    package main

    # Accepted Values: "Critical", "High", "Medium", "Low", "Negligible",
"UnknownSeverity"
    notAllowedSeverities := ["Critical", "High", "UnknownSeverity"]
    ignoreCves := []
...

```

- o `ignoreCves` contains individual ignored CVEs when determining policy enforcement. In the following example, an `app-operator` ignores `CVE-2018-14643` and `GHSA-f2jv-r9rf-7988` if they are false positives. See [A Note on Vulnerability Scanners](#).

```

...
spec:
  regoFile: |
    package main

    notAllowedSeverities := []
    ignoreCves := ["CVE-2018-14643", "GHSA-f2jv-r9rf-7988"]
...

```

2. Deploy the scan policy to the cluster:

```
kubectl apply -f <path_to_scan_policy>/<scan_policy_filename>.yaml -n <desired_namespace>
```

For information about how scan policies are used in the CVE triage workflow, see [Triaging and Remediating CVEs](#).

Further refine the Scan Policy for use

The scan policy earlier demonstrates how vulnerabilities are ignored during a compliance check. It is not possible to audit why a vulnerability is ignored. You might want to allow an exception, where a build with a failing vulnerability is allowed to progress through a supply chain. You can allow this exception for a certain period of time, requiring an expiration date. Vulnerability Exploitability Exchange (VEX) documents are gaining popularity to capture security advisory information pertaining to vulnerabilities. You can use Rego for these use cases.

For example, the following scan policy includes an additional text box to capture comments regarding why the scan ignores a vulnerability. The `notAllowedSeverities` array remains an array of strings, but the `ignoreCves` array updates from an array of strings to an array of objects. This causes a change to the `contains` function, splitting it into separate functions for each array.

```

---
apiVersion: scanning.apps.tanzu.vmware.com/v1beta1
kind: ScanPolicy
metadata:
  name: scan-policy
  labels:
    app.kubernetes.io/part-of: enable-in-gui
spec:
  regoFile: |
    package main

    # Accepted Values: "Critical", "High", "Medium", "Low", "Negligible", "UnknownSeverity"
    notAllowedSeverities := ["Critical", "High", "UnknownSeverity"]

    # List of known vulnerabilities to ignore when deciding whether to fail compliance. Example:
    # ignoreCves := [
    #   {
    #     "id": "CVE-2018-14643",
    #     "detail": "Determined affected code is not in the execution path."
    #   }
    # ]
    ignoreCves := []

    containsSeverity(array, elem) = true {
      array[_] = elem
    } else = false { true }

    isSafe(match) {

```

```

    severities := { e | e := match.ratings.rating.severity } | { e | e := match.rati
ngs.rating[_].severity }
    some i
    fails := containsSeverity(notAllowedSeverities, severities[i])
    not fails
  }

containsCve(array, elem) = true {
  array[_].id = elem
} else = false { true }

isSafe(match) {
  ignore := containsCve(ignoreCves, match.id)
  ignore
}

deny[msg] {
  comps := { e | e := input.bom.components.component } | { e | e := input.bom.comp
onents.component[_] }
  some i
  comp := comps[i]
  vulns := { e | e := comp.vulnerabilities.vulnerability } | { e | e := comp.vulne
rabilities.vulnerability[_] }
  some j
  vuln := vulns[j]
  ratings := { e | e := vuln.ratings.rating.severity } | { e | e := vuln.ratings.r
ating[_].severity }
  not isSafe(vuln)
  msg = sprintf("CVE %s %s %s", [comp.name, vuln.id, ratings])
}

```

The following example includes an expiration text box and only allows the vulnerability to be ignored for a period of time:

```

---
apiVersion: scanning.apps.tanzu.vmware.com/v1beta1
kind: ScanPolicy
metadata:
  name: scan-policy
  labels:
    app.kubernetes.io/part-of: enable-in-gui
spec:
  regoFile: |
    package main

    # Accepted Values: "Critical", "High", "Medium", "Low", "Negligible", "UnknownSeve
rity"
    notAllowedSeverities := ["Critical", "High", "UnknownSeverity"]

    # List of known vulnerabilities to ignore when deciding whether to fail complianc
e. Example:
    # ignoreCves := [
    #   {
    #     "id": "CVE-2018-14643",
    #     "detail": "Determined affected code is not in the execution path.",
    #     "expiration": "2022-Dec-31"
    #   }
    # ]
    ignoreCves := []

    containsSeverity(array, elem) = true {
      array[_] = elem
    } else = false { true }

    isSafe(match) {

```

```

    severities := { e | e := match.ratings.rating.severity } | { e | e := match.rati
ngs.rating[_].severity }
    some i
    fails := containsSeverity(notAllowedSeverities, severities[i])
    not fails
  }

containsCve(array, elem) = true {
  array[_].id = elem
  curr_time := time.now_ns()
  date_format := "2006-Jan-02"
  expire_time := time.parse_ns(date_format, array[_].expiration)
  curr_time < expire_time
} else = false { true }

isSafe(match) {
  ignore := containsCve(ignoreCves, match.id)
  ignore
}

deny[msg] {
  comps := { e | e := input.bom.components.component } | { e | e := input.bom.comp
onents.component[_] }
  some i
  comp := comps[i]
  vulns := { e | e := comp.vulnerabilities.vulnerability } | { e | e := comp.vulne
rabilities.vulnerability[_] }
  some j
  vuln := vulns[j]
  ratings := { e | e := vuln.ratings.rating.severity } | { e | e := vuln.ratings.r
ating[_].severity }
  not isSafe(vuln)
  msg = sprintf("CVE %s %s %s", [comp.name, vuln.id, ratings])
}

```

Troubleshooting Rego files (Scan Policy)

To troubleshoot or confirm that any modifications made to the rego file in the provided sample scan policy are functioning as intended, see [Troubleshooting Rego Files](#).

Enable Tanzu Developer Portal to view ScanPolicy Resource

For the Tanzu Developer Portal (formerly named Tanzu Application Platform GUI) to view the ScanPolicy resource, it must have a matching `kubernetes-label-selector` with a `part-of` prefix.

The following example is portion of a ScanPolicy that is viewable by the Tanzu Developer Portal:

```

---
apiVersion: scanning.apps.tanzu.vmware.com/v1beta1
kind: ScanPolicy
metadata:
  name: scan-policy
  labels:
    app.kubernetes.io/part-of: enable-in-gui
spec:
  regoFile: |
    ...

```



Note

Anything can be a value for the label. The Tanzu Application Platform GUI is looking for the existence of the `part-of` prefix string and doesn't match for anything else specific.

Deprecated Rego file Definition

Before Scan Controller v1.2.0, you must use the following format where the rego file differences are:

- The package name must be `package policies` instead of `package main`.
- The deny rule is a Boolean `isCompliant` instead of `deny[msg]`.
 - **isCompliant rule:** The Rego file must define inside its body an `isCompliant` rule. This must be a Boolean type containing the result whether the vulnerability violates the security policy or not. If `isCompliant` is `true`, the vulnerability is allowed in the Source or Image scan. Otherwise, `false` is considered. Any scan that finds at least one vulnerability that evaluates to `isCompliant=false` makes the `PolicySucceeded` condition set to false.

The following is an example scan policy resource:

```
apiVersion: scanning.apps.tanzu.vmware.com/v1alpha1
kind: ScanPolicy
metadata:
  name: v1alpha1-scan-policy
  labels:
    app.kubernetes.io/part-of: enable-in-gui
spec:
  regoFile: |
    package policies

    default isCompliant = false

    ignoreSeverities := ["Critical", "High"]

    contains(array, elem) = true {
      array[_] = elem
    } else = false { true }

    isCompliant {
      ignore := contains(ignoreSeverities, input.currentVulnerability.Ratings.Rating
[_].Severity)
      ignore
    }
  }
```

Create a ScanTemplate with Supply Chain Security Tools - Scan

This topic describes how to create a ScanTemplate with Supply Chain Security Tools - Scan.

Overview

The `ScanTemplate` custom resource (CR) defines how the scan Pod fulfills the task of vulnerability scanning. There are default `ScanTemplates` provided out of the box using the Tanzu Application Platform default scanner, `Anchore Grype`. One or more `initContainers` run to complete the scan and must save results to a shared `volume`.

After the `initContainers` completes, a single container on the scan Pod called `summary` combines the result of the `initContainers` so that the `Scan` CR status is updated.

A customized `ScanTemplate` is created by editing or replacing `initContainer` definitions and reusing the `summary` container from the `grype` package. A container can read the `out.yaml` from an earlier step to locate relevant inputs.

Output Model

Each `initContainer` can create a subdirectory in `/workspace` to use as a scratch space. Before terminating the container must create an `out.yaml` file in the subdirectory containing the relevant subset of fields from the output model:

```
fetch:
  git:
    url:
    revision:
    path:
  blob:
    url:
    revision:
    path:
  image:
    url:
    revision:
    path:
sbom:
  packageCount:
  reports: []
scan:
  cveCount:
    critical:
    high:
    medium:
    low:
    unknown:
  scanner:
    name:
    vendor:
    version:
    db:
      version:
  reports: []
eval:
  violations: []
store:
  locations: []
```

The `scan` portion of the earlier output is required and if missing the scan controller fails to properly update the final status of the `Scan` CR. Other portions of the output, including those of `store` and `policy evaluation`, are optional and can be omitted if not applicable in a custom supply chain setup.

ScanTemplate Structure

```
apiVersion: scanning.apps.tanzu.vmware.com/v1beta1
kind: ScanTemplate
spec:
  template: # a core/v1 PodSpec
    # Here are list volumes mounted for writing to or
    # reading from during different stages of the scan
```



```
volumes:
  # required the results of different scan stages
  # should be saved in files digestible by the scan
  # controller in this volume
  - name: workspace
  emptyDir: { }
  # different steps required for a scanning can be staged
  # in sequential stages through initContainers.
  initContainers:
  # Summary container will take results of initContainers
  # and will let Controller to update Scan CR status.
  containers:
  - name: summary
```

Note: You cannot name a container `sleep` because there is already a container named `sleep` which comes from the scan-link controller.

Sample Outputs

```
# example for a typical git clone (source scan fetch stage)
# saved at: /workspace/git-clone/out.yaml
fetch:
  git:
    url: github.com/my/repo
    revision: aee9f8
    path: /workspace/git-clone/cloned-repository
```

```
# an example of typical scan stage
# saved at: /workspace/grype-scan/out.yaml
scan:
  cveCount:
    critical: 0
    high: 1
    medium: 3
    low: 25
    unknown: 0
  scanner:
    name: grype
    vendor: Anchore
    version: 0.33.0
    db:
      version: 2022-04-13
  reports:
  - /workspace/grype-scan/repo.cyclonedx.xml
  - /workspace/grype-scan/app.cyclonedx.xml
  - /workspace/grype-scan/base.cyclonedx.xml
```

```
# example of a typical evaluation stage
# saved at: /workspace/policy-eval/out.yaml
eval:
  violations:
  - banned package log4j
  - critical CVE 2022-01-01-3333
  - number of critical CVEs over threshold
```

```
# example of a typical upload to store stage
# saved at: /workspace/upload-to-store/out.yaml
store:
  locations:
  - http://metadata-store.cluster.local:8080/reports/3
```

View scan status conditions for Supply Chain Security Tools - Scan

This topic explains how you can view scan status conditions for Supply Chain Security Tools - Scan.

Viewing scan status

You can view the scan status by using `kubectl describe` on a `SourceScan` or `ImageScan`. You can see information about the scan status under the Status field for each scan CR.

Overview of conditions

The `Status.Conditions` array is populated with the scan status information during and after scanning execution, and the policy validation (if defined for the scan) after the results are available.

Condition types for the scans

Scanning

The Condition with type `Scanning` indicates running the scanning TaskRun. The Status field indicates whether the scan is running or has already finished. For example, if `Status: True`, the scan TaskRun is still running and if `Status: False`, the scan is done.

The Reason field is `JobStarted` while the scan is running and `JobFinished` when it is done.

The Message field can either be `The scan job is running` or `The scan job terminated` depending on the current Status and Reason.

Succeeded

The Condition with type `Succeeded` indicates the scanning TaskRun result. The Status field indicates whether the scan finished successfully or if it encountered an error. For example, the status is `Status: True` if it completed successfully or `Status: False` otherwise.

The Reason field is `JobFinished` if the scanning was successful or `Error` if otherwise.

The Message and Error fields have more information about the last seen status of the scan TaskRun.

SendingResults

The condition with type `SendingResults` indicates sending the scan results to the metadata store. In addition to a successful process of sending the results, the condition can also indicate that the metadata store integration has not been configured or that there was an error sending. An error is usually a misconfigured metadata store URL or that the metadata store is inaccessible. Verify the installation steps to ensure that the configuration is correct regarding secrets being set within the `scan-link-system` namespace.

PolicySucceeded

The Condition with type `PolicySucceeded` indicates the compliance of the scanning results against the defined policies. See [Code Compliance Policy Enforcement using Open Policy Agent \(OPA\)](#). The Status field indicates whether the results are compliant or not (`Status: True` or `Status: False` respectively) or `Status: Unknown` in case an error occurred during the policy verification.

The Reason field is `EvaluationPassed` if the scan complies with the defined policies. The Reason field is `EvaluationFailed` if the scan is not compliant, or `Error` if something went wrong.

The Message and Error fields are populated with `An error has occurred` and an error message if something went wrong during policy verification. Otherwise, the Message field displays `No CVEs were found that violated the policy` if there are no non-compliant vulnerabilities found or `Policy violated because of X CVEs` indicating the count of unique vulnerabilities found.

Overview of CVECount

The `status.CVECount` is populated with the number of CVEs in each category (CRITICAL, HIGH, MEDIUM, LOW, UNKNOWN) and the total (CVETOTAL).



Note

You can also view scan CVE summary in print columns with `kubectl get` on a `SourceScan` or `ImageScan`.

Overview of MetadataURL

The `status.metadataURL` is populated with the URL of the vulnerability scan results in the metadata store integration. This is only available when the integration is configured.

Overview of Phase

The `status.phase` field is populated with the current phase of the scan. The phases are: Pending, Scanning, Completed, Failed, and Error.

- `Pending`: initial phase of the scan.
- `Scanning`: execution of the scan TaskRun is running.
- `Completed`: scan completed and no CVEs were found that violated the scan policy.
- `Failed`: scan completed but CVEs were found that violated the scan policy.
- `Error`: indication of an error (e.g., an invalid scantemplate or scan policy).



Note

The PHASE print column also shows this with `kubectl get` on a `SourceScan` or `ImageScan`.

Overview of ScannedBy

The `status.scannedBy` field is populated with the name, vendor, and scanner version that generates the security assessment report.

Overview of ScannedAt

The `status.scannedAt` field is populated with the latest date when the scanning finishes.

Troubleshoot Rego files with a scan policy for Supply Chain Security Tools - Scan

This topic describes how you can use an example output to troubleshoot your Rego file for SCST - Scan. You use a Rego file in a scan policy custom resource. See [Enforce compliance policy using](#)

[Open Policy Agent](#).

For information about how to write Rego, see [Open Policy Agent documentation](#).

Using the Rego playground

Use the [Rego Playground](#), to evaluate your Rego file against an input. In this example, use the example output of an image or source scan custom resource.

Sample input in CycloneDX's XML re-encoded as JSON format

The following is an example scan custom resource output in CycloneDX's XML structure re-encoded as JSON. This example output contains CVEs at low, medium, high, and critical severities.

To troubleshoot using this example output:

1. Paste your Rego file and the example output into the [Rego Playground](#).
2. Evaluate your Rego file against the example output and verify that your Rego file detects the intended CVEs. See this [Rego example](#).

```
{
  "bom": {
    "-serialNumber": "urn:uuid:123",
    "-v": "http://cyclonedx.org/schema/ext/vulnerability/1.0",
    "-version": "1",
    "-xmlns": "http://cyclonedx.org/schema/bom/1.2",
    "components": {
      "component": [
        {
          "-type": "library",
          "licenses": {
            "license": {
              "name": "GPL-2"
            }
          },
          "name": "adduser",
          "version": "3.118",
          "vulnerabilities": {
            "vulnerability": [
              {
                "-ref": "urn:uuid:3d7c61c6-9cfa-494c-858a-9668a318ff23",
                "advisories": {
                  "advisory": "https://security-tracker.debian.org/tracker/CVE-2011-3374"
                },
                "id": "CVE-2011-3374-a",
                "ratings": {
                  "rating": {
                    "severity": "Low"
                  }
                },
                "source": {
                  "-name": "debian:10",
                  "url": "http://cve.mitre.org/cgi-bin/cvename.cgi?name=CVE-2011-3374"
                }
              },
              {
                "-ref": "urn:uuid:ebabaa92-2bf9-4d33-8181-595b0fdf55bd",
                "advisories": {
                  "advisory": "https://security-tracker.debian.org/tracker/CVE-2011-3374"
                }
              }
            ]
          }
        }
      ]
    }
  }
}
```

```

racker/CVE-2020-27350"
    },
    "id": "CVE-2020-27350-a",
    "ratings": {
      "rating": {
        "severity": "Medium"
      }
    },
    "source": {
      "-name": "debian:10",
      "url": "http://cve.mitre.org/cgi-bin/cvename.cgi?n
ame=CVE-2020-27350"
    }
  },
  {
    "-ref": "urn:uuid:07c58c81-1e01-459d-9e9d-0e10456a9bf
0",
    "advisories": {
      "advisory": "https://security-tracker.debian.org/t
racker/CVE-2020-3810"
    },
    "id": "CVE-2020-3810-a",
    "ratings": {
      "rating": {
        "severity": "Medium"
      }
    },
    "source": {
      "-name": "debian:10",
      "url": "http://cve.mitre.org/cgi-bin/cvename.cgi?n
ame=CVE-2020-3810"
    }
  }
]
},
{
  "-type": "library",
  "licenses": {
    "license": [
      {
        "name": "GPL-2"
      },
      {
        "name": "GPLv2+"
      }
    ]
  },
  "name": "apt",
  "version": "1.8.2",
  "vulnerabilities": {
    "vulnerability": [
      {
        "-ref": "urn:uuid:3d7c61c6-9cfa-494c-858a-9668a318ff2
3",
        "advisories": {
          "advisory": "https://security-tracker.debian.org/t
racker/CVE-2011-3374"
        },
        "id": "CVE-2011-3374",
        "ratings": {
          "rating": {
            "severity": "Low"
          }
        },
        "source": {

```

Example input in SPDX JSON format

The example in this section is a modified scan custom resource input, in `.spdx.json`, that contains CVEs at low, medium, high, and critical severities. You can use this example input to evaluate your Rego file.

To troubleshoot using this example output:

1. Paste your Rego file and the example input into the [Rego Playground](#).
2. Evaluate your Rego file against the output and verify that your Rego file detects the intended CVEs. See this Rego [example](#).

```
{
  "id": "SPDXRef-docker-image|nginx",
  "specVersion": "SPDX-3.0",
  "creator": "Organization: Snyk Ltd",
  "created": "2023-03-01T16:10:08Z",
  "profile": [
    "base",
    "vulnerabilities"
  ],
  "description": "Snyk test result for project docker-image|nginx in SPDX SBOM format",
  "vulnerabilities": [
    {
      "id": "SNYK-DEBIAN10-APT-1049974",
      "name": "SNYK-DEBIAN10-APT-1049974",
      "summary": "Integer Overflow or Wraparound",
      "details": "## NVD Description\n**_Note:** _Versions mentioned in the description apply only to the upstream `apt` package and not the `apt` package as distributed by `Debian:10`. See `How to fix?` for `Debian:10` relevant fixed versions and status.\nAPT had several integer overflows and underflows while parsing .deb packages, aka GHSL-2020-168 GHSL-2020-169, in files apt-pkg/contrib/extracttar.cc, apt-pkg/deb/debfile.cc, and apt-pkg/contrib/arfile.cc. This issue affects: apt 1.2.32ubuntu0 versions prior to 1.2.32ubuntu0.2; 1.6.12ubuntu0 versions prior to 1.6.12ubuntu0.2; 2.0.2ubuntu0 versions prior to 2.0.2ubuntu0.2; 2.1.10ubuntu0 versions prior to 2.1.10ubuntu0.1;\n## Remediation\nUpgrade `Debian:10` `apt` to version 1.8.2.2 or higher.\n## References\n- [ADVISORY] (https://security-tracker.debian.org/tracker/CVE-2020-27350)\n- [CONFIRM] (https://bugs.launchpad.net/bugs/1899193)\n- [CONFIRM] (https://security.netapp.com/advisory/ntap-20210108-0005/)\n- [DEBIAN] (https://www.debian.org/security/2020/dsa-4808)\n- [UBUNTU] (https://usn.ubuntu.com/usn/usn-4667-1)\n",
      "relationships": [
        {
          "affect": {
            "to": [
              "docker-image|nginx@1.16",
              "apt/libapt-pkg5.0@1.8.2"
            ],
            "type": "AFFECTS"
          },
          "foundBy": {
            "to": [
              ""
            ],
            "type": "FOUND_BY"
          },
          "suppliedBy": {
            "to": [
              ""
            ],
            "type": "SUPPLIED_BY"
          },
          "ratedBy": {
            "to": [
              ""
            ]
          }
        }
      ]
    }
  ]
}
```

```

    ],
    "type": "RATED_BY",
    "cwes": [
      190
    ],
    "rating": [
      {
        "method": "CVSS_3",
        "score": [
          {
            "base": 5.7
          }
        ],
        "severity": "Medium",
        "vector": "CVSS:3.1/AV:L/AC:L/PR:H/UI:N/S:C/C:L/I:L/A:L"
      }
    ]
  }
},
"externalReferences": [
  {
    "category": "ADVISORY",
    "locator": "https://security-tracker.debian.org/tracker/CVE-2020-27350"
  },
  {
    "category": "ADVISORY",
    "locator": "https://bugs.launchpad.net/bugs/1899193"
  },
  {
    "category": "ADVISORY",
    "locator": "https://security.netapp.com/advisory/ntap-20210108-0005/"
  },
  {
    "category": "ADVISORY",
    "locator": "https://www.debian.org/security/2020/dsa-4808"
  },
  {
    "category": "ADVISORY",
    "locator": "https://usn.ubuntu.com/usn/usn-4667-1"
  }
],
"modified": "2022-10-29T13:11:02.438923Z",
"published": "2020-12-10T03:10:23.901831Z"
},
{
  "id": "SNYK-DEBIAN10-APT-407502",
  "name": "SNYK-DEBIAN10-APT-407502",
  "summary": "Improper Verification of Cryptographic Signature",
  "details": "## NVD Description\n**_Note:** _Versions mentioned in the description apply only to the upstream `apt` package and not the `apt` package as distributed by `Debian:10`. See `How to fix?` for `Debian:10` relevant fixed versions and status.\n\nIt was found that apt-key in apt, all versions, do not correctly validate gpg keys with the primary keyring, leading to a potential man-in-the-middle attack.\n\n## Remediation\nThere is no fixed version for `Debian:10` `apt`.\n\n## References\n- [ADVISORY] (https://security-tracker.debian.org/tracker/CVE-2011-3374)\n- [Debian Bug Report] (https://bugs.debian.org/cgi-bin/bugreport.cgi?bug=642480)\n- [MISC] (https://people.canonical.com/~ubuntu-security/cve/2011/CVE-2011-3374.html)\n- [MISC] (https://seclists.org/fulldisclosure/2011/Sep/221)\n- [MISC] (https://snyk.io/vuln/SNYK-LINUX-APT-116518)\n- [MISC] (https://ubuntu.com/security/CVE-2011-3374)\n- [RedHat CVE Database] (https://access.redhat.com/security/cve/cve-2011-3374)\n",
  "relationships": [
    {
      "affect": {
        "to": [
          "docker-image|nginx@1.16",

```



```

    "apt/libapt-pkg5.0@1.8.2"
  ],
  "type": "AFFECTS"
},
"foundBy": {
  "to": [
    ""
  ],
  "type": "FOUND_BY"
},
"suppliedBy": {
  "to": [
    ""
  ],
  "type": "SUPPLIED_BY"
},
"ratedBy": {
  "to": [
    ""
  ],
  "type": "RATED_BY",
  "cwes": [
    347
  ],
  "rating": [
    {
      "method": "CVSS_3",
      "score": [
        {
          "base": 3.7
        }
      ],
      "severity": "Low",
      "vector": "CVSS:3.1/AV:N/AC:H/PR:N/UI:N/S:U/C:N/I:L/A:N"
    }
  ]
}
},
"externalReferences": [
  {
    "category": "ADVISORY",
    "locator": "https://security-tracker.debian.org/tracker/CVE-2011-3374"
  },
  {
    "category": "ADVISORY",
    "locator": "https://bugs.debian.org/cgi-bin/bugreport.cgi?bug=642480"
  },
  {
    "category": "ADVISORY",
    "locator": "https://people.canonical.com/~ubuntu-security/cve/2011/CVE-2011-3374.html"
  },
  {
    "category": "ADVISORY",
    "locator": "https://seclists.org/fulldisclosure/2011/Sep/221"
  },
  {
    "category": "ADVISORY",
    "locator": "https://snyk.io/vuln/SNYK-LINUX-APT-116518"
  },
  {
    "category": "ADVISORY",
    "locator": "https://ubuntu.com/security/CVE-2011-3374"
  },
  {

```

```

        "category": "ADVISORY",
        "locator": "https://access.redhat.com/security/cve/cve-2011-3374"
    }
],
"modified": "2022-11-01T00:08:27.375895Z",
"published": "2018-06-27T16:20:45.037549Z"
},
{
    "id": "SNYK-DEBIAN10-APT-568926",
    "name": "SNYK-DEBIAN10-APT-568926",
    "summary": "Improper Input Validation",
    "details": "## NVD Description\n**_Note:_** _Versions mentioned in the descripti
on apply only to the upstream `apt` package and not the `apt` package as distributed b
y `Debian:10`.\n_See `How to fix?` for `Debian:10` relevant fixed versions and statu
s.\n\nMissing input validation in the ar/tar implementations of APT before version 2.
1.2 could result in denial of service when processing specially crafted deb files.\n##
Remediation\nUpgrade `Debian:10` `apt` to version 1.8.2.1 or higher.\n## References\n-
[ADVISORY] (https://security-tracker.debian.org/tracker/CVE-2020-3810)\n- [FEDORA] (http
s://lists.fedoraproject.org/archives/list/package-announce@lists.fedoraproject.org/mes
sage/U4PEH357M2M2SUGKETMEHMSGQS652QHH/)\n- [GitHub Issue] (https://github.com/Debian/ap
t/issues/111)\n- [MISC] (https://bugs.launchpad.net/bugs/1878177)\n- [MISC] (https://lis
ts.debian.org/debian-security-announce/2020/msg00089.html)\n- [MISC] (https://salsa.deb
ian.org/apt-team/apt/-/commit/dceble49e4b8e4dadaf056be34088b415939cda6)\n- [MISC] (http
s://tracker.debian.org/news/1144109/accepted-apt-212-source-into-unstable/)\n- [UBUNT
U] (https://usn.ubuntu.com/4359-2/)\n- [Ubuntu CVE Tracker] (http://people.ubuntu.com/~u
buntu-security/cve/CVE-2020-3810)\n- [Ubuntu Security Advisory] (https://usn.ubuntu.co
m/4359-1/)\n",
    "relationships": [
        {
            "affect": {
                "to": [
                    "docker-image|nginx@1.16",
                    "apt/libapt-pkg5.0@1.8.2"
                ],
                "type": "AFFECTS"
            },
            "foundBy": {
                "to": [
                    ""
                ],
                "type": "FOUND_BY"
            },
            "suppliedBy": {
                "to": [
                    ""
                ],
                "type": "SUPPLIED_BY"
            },
            "ratedBy": {
                "to": [
                    ""
                ],
                "type": "RATED_BY",
                "cwes": [
                    20
                ],
                "rating": [
                    {
                        "method": "CVSS_3",
                        "score": [
                            {
                                "base": 5.5
                            }
                        ],
                        "severity": "Medium",
                        "vector": "CVSS:3.1/AV:L/AC:L/PR:N/UI:R/S:U/C:N/I:N/A:H"
                    }
                ]
            }
        }
    ]
}

```

```

    }
  ]
}
],
"externalReferences": [
  {
    "category": "ADVISORY",
    "locator": "https://security-tracker.debian.org/tracker/CVE-2020-3810"
  },
  {
    "category": "ADVISORY",
    "locator": "https://lists.fedoraproject.org/archives/list/package-announce@lists.fedoraproject.org/message/U4PEH357M2SUGKETMEHMSGQS652QHH/"
  },
  {
    "category": "ADVISORY",
    "locator": "https://github.com/Debian/apt/issues/111"
  },
  {
    "category": "ADVISORY",
    "locator": "https://bugs.launchpad.net/bugs/1878177"
  },
  {
    "category": "ADVISORY",
    "locator": "https://lists.debian.org/debian-security-announce/2020/msg00089.html"
  },
  {
    "category": "ADVISORY",
    "locator": "https://salsa.debian.org/apt-team/apt/-/commit/dceble49e4b8e4dadaf056be34088b415939cda6"
  },
  {
    "category": "ADVISORY",
    "locator": "https://tracker.debian.org/news/1144109/accepted-apt-212-source-into-unstable/"
  },
  {
    "category": "ADVISORY",
    "locator": "https://usn.ubuntu.com/4359-2/"
  },
  {
    "category": "ADVISORY",
    "locator": "http://people.ubuntu.com/~ubuntu-security/cve/CVE-2020-3810"
  },
  {
    "category": "ADVISORY",
    "locator": "https://usn.ubuntu.com/4359-1/"
  }
],
"modified": "2022-11-01T00:08:51.907776Z",
"published": "2020-05-12T14:19:01.052295Z"
},
{
  "id": "SNYK-DEBIAN10-APT-1049974",
  "name": "SNYK-DEBIAN10-APT-1049974",
  "summary": "Integer Overflow or Wraparound",
  "details": "### NVD Description\n**_Note:** _Versions mentioned in the description apply only to the upstream `apt` package and not the `apt` package as distributed by `Debian:10`. \n_See `How to fix?` for `Debian:10` relevant fixed versions and status. \n\nAPT had several integer overflows and underflows while parsing .deb packages, aka GHSL-2020-168 GHSL-2020-169, in files apt-pkg/contrib/extracttar.cc, apt-pkg/deb/debfile.cc, and apt-pkg/contrib/arfile.cc. This issue affects: apt 1.2.32ubuntu0 version prior to 1.2.32ubuntu0.2; 1.6.12ubuntu0 versions prior to 1.6.12ubuntu0.2; 2.0.2ubuntu0 versions prior to 2.0.2ubuntu0.2; 2.1.10ubuntu0 versions prior to 2.1.10ubuntu0."
}

```

```

1;\n## Remediation\nUpgrade `Debian:10` `apt` to version 1.8.2.2 or higher.\n## Referenc
nces\n- [ADVISORY] (https://security-tracker.debian.org/tracker/CVE-2020-27350)\n- [CON
FIRM] (https://bugs.launchpad.net/bugs/1899193)\n- [CONFIRM] (https://security.netapp.co
m/advisory/ntap-20210108-0005/)\n- [DEBIAN] (https://www.debian.org/security/2020/dsa-4
808)\n- [UBUNTU] (https://usn.ubuntu.com/usn/usn-4667-1)\n",
  "relationships": [
    {
      "affect": {
        "to": [
          "docker-image|nginx@1.16",
          "apt@1.8.2",
          "apt/libapt-pkg5.0@1.8.2"
        ],
        "type": "AFFECTS"
      },
      "foundBy": {
        "to": [
          ""
        ],
        "type": "FOUND_BY"
      },
      "suppliedBy": {
        "to": [
          ""
        ],
        "type": "SUPPLIED_BY"
      },
      "ratedBy": {
        "to": [
          ""
        ],
        "type": "RATED_BY",
        "cwes": [
          190
        ],
        "rating": [
          {
            "method": "CVSS_3",
            "score": [
              {
                "base": 5.7
              }
            ],
            "severity": "Medium",
            "vector": "CVSS:3.1/AV:L/AC:L/PR:H/UI:N/S:C/C:L/I:L/A:L"
          }
        ]
      }
    }
  ],
  "externalReferences": [
    {
      "category": "ADVISORY",
      "locator": "https://security-tracker.debian.org/tracker/CVE-2020-27350"
    },
    {
      "category": "ADVISORY",
      "locator": "https://bugs.launchpad.net/bugs/1899193"
    },
    {
      "category": "ADVISORY",
      "locator": "https://security.netapp.com/advisory/ntap-20210108-0005/"
    },
    {
      "category": "ADVISORY",
      "locator": "https://www.debian.org/security/2020/dsa-4808"
    }
  ]
}

```

```

    },
    {
      "category": "ADVISORY",
      "locator": "https://usn.ubuntu.com/usn/usn-4667-1"
    }
  ],
  "modified": "2022-10-29T13:11:02.438923Z",
  "published": "2020-12-10T03:10:23.901831Z"
},
{
  "id": "SNYK-DEBIAN10-APT-407502",
  "name": "SNYK-DEBIAN10-APT-407502",
  "summary": "Improper Verification of Cryptographic Signature",
  "details": "## NVD Description\n**_Note:_** _Versions mentioned in the description apply only to the upstream `apt` package and not the `apt` package as distributed by `Debian:10`.\n_See `How to fix?` for `Debian:10` relevant fixed versions and statuses.\n\nIt was found that apt-key in apt, all versions, do not correctly validate gpg keys with the primary keyring, leading to a potential man-in-the-middle attack.\n## Remediation\nThere is no fixed version for `Debian:10` `apt`.\n## References\n- [ADVISORY] (https://security-tracker.debian.org/tracker/CVE-2011-3374)\n- [Debian Bug Report] (https://bugs.debian.org/cgi-bin/bugreport.cgi?bug=642480)\n- [MISC] (https://people.canonical.com/~ubuntu-security/cve/2011/CVE-2011-3374.html)\n- [MISC] (https://seclists.org/fulldisclosure/2011/Sep/221)\n- [MISC] (https://snyk.io/vuln/SNYK-LINUX-APT-116518)\n- [MISC] (https://ubuntu.com/security/CVE-2011-3374)\n- [RedHat CVE Database] (https://access.redhat.com/security/cve/cve-2011-3374)\n",
  "relationships": [
    {
      "affect": {
        "to": [
          "docker-image|nginx@1.16",
          "apt@1.8.2",
          "apt/libapt-pkg5.0@1.8.2"
        ],
        "type": "AFFECTS"
      },
      "foundBy": {
        "to": [
          ""
        ],
        "type": "FOUND_BY"
      },
      "suppliedBy": {
        "to": [
          ""
        ],
        "type": "SUPPLIED_BY"
      },
      "ratedBy": {
        "to": [
          ""
        ],
        "type": "RATED_BY",
        "cwes": [
          347
        ],
        "rating": [
          {
            "method": "CVSS_3",
            "score": [
              {
                "base": 3.7
              }
            ],
            "severity": "Low",
            "vector": "CVSS:3.1/AV:N/AC:H/PR:N/UI:N/S:U/C:N/I:L/A:N"
          }
        ]
      }
    }
  ]
}

```

```

    ]
  }
}
],
"externalReferences": [
  {
    "category": "ADVISORY",
    "locator": "https://security-tracker.debian.org/tracker/CVE-2011-3374"
  },
  {
    "category": "ADVISORY",
    "locator": "https://bugs.debian.org/cgi-bin/bugreport.cgi?bug=642480"
  },
  {
    "category": "ADVISORY",
    "locator": "https://people.canonical.com/~ubuntu-security/cve/2011/CVE-2011-3374.html"
  },
  {
    "category": "ADVISORY",
    "locator": "https://seclists.org/fulldisclosure/2011/Sep/221"
  },
  {
    "category": "ADVISORY",
    "locator": "https://snyk.io/vuln/SNYK-LINUX-APT-116518"
  },
  {
    "category": "ADVISORY",
    "locator": "https://ubuntu.com/security/CVE-2011-3374"
  },
  {
    "category": "ADVISORY",
    "locator": "https://access.redhat.com/security/cve/cve-2011-3374"
  }
],
"modified": "2022-11-01T00:08:27.375895Z",
"published": "2018-06-27T16:20:45.037549Z"
},
{
  "id": "SNYK-DEBIAN10-EXPAT-2329087",
  "name": "SNYK-DEBIAN10-EXPAT-2329087",
  "summary": "Incorrect Calculation",
  "details": "## NVD Description\n**_Note:_** _Versions mentioned in the description apply only to the upstream `expat` package and not the `expat` package as distributed by `Debian:10`.\n\nSee `How to fix?` for `Debian:10` relevant fixed versions and status.\n\nIn Expat (aka libexpat) before 2.4.3, a left shift by 29 (or more) places in the storeAtts function in xmlparse.c can lead to realloc misbehavior (e.g., allocating too few bytes, or only freeing memory).\n\n## Remediation\nUpgrade `Debian:10` `expat` to version 2.2.6-2+deb10u2 or higher.\n\n## References\n- [ADVISORY](https://security-tracker.debian.org/tracker/CVE-2021-45960)\n- [MISC](https://bugzilla.mozilla.org/show_bug.cgi?id=1217609)\n- [MISC](https://github.com/libexpat/libexpat/issues/531)\n- [MISC](https://github.com/libexpat/libexpat/pull/534)\n- [cve@mitre.org](http://www.openwall.com/lists/oss-security/2022/01/17/3)\n- [cve@mitre.org](https://security.netapp.com/advisory/ntap-20220121-0004/)\n- [cve@mitre.org](https://www.tenable.com/security/tns-2022-05)\n- [cve@mitre.org](https://www.debian.org/security/2022/dsa-5073)\n- [cve@mitre.org](https://cert-portal.siemens.com/productcert/pdf/ssa-484086.pdf)\n- [cve@mitre.org](https://security.gentoo.org/glsa/202209-24)\n",
  "relationships": [
    {
      "affect": {
        "to": [
          "docker-image|nginx@1.16",
          "nginx-module-image-filter@1.16.1-1~buster",
          "libgd2/libgd3@2.2.5-5.2",
          "fontconfig/libfontconfig@2.13.1-2",
          "expat/libexpat1@2.2.6-2+deb10u1"
        ]
      }
    }
  ]
}

```

```

    ],
    "type": "AFFECTS"
  },
  "foundBy": {
    "to": [
      ""
    ],
    "type": "FOUND_BY"
  },
  "suppliedBy": {
    "to": [
      ""
    ],
    "type": "SUPPLIED_BY"
  },
  "ratedBy": {
    "to": [
      ""
    ],
    "type": "RATED_BY",
    "cwes": [
      682
    ],
    "rating": [
      {
        "method": "CVSS_3",
        "score": [
          {
            "base": 8.8
          }
        ],
        "severity": "High",
        "vector": "CVSS:3.1/AV:N/AC:L/PR:L/UI:N/S:U/C:H/I:H/A:H"
      }
    ]
  }
}
],
"externalReferences": [
  {
    "category": "ADVISORY",
    "locator": "https://security-tracker.debian.org/tracker/CVE-2021-45960"
  },
  {
    "category": "ADVISORY",
    "locator": "https://bugzilla.mozilla.org/show_bug.cgi?id=1217609"
  },
  {
    "category": "ADVISORY",
    "locator": "https://github.com/libexpat/libexpat/issues/531"
  },
  {
    "category": "ADVISORY",
    "locator": "https://github.com/libexpat/libexpat/pull/534"
  },
  {
    "category": "ADVISORY",
    "locator": "http://www.openwall.com/lists/oss-security/2022/01/17/3"
  },
  {
    "category": "ADVISORY",
    "locator": "https://security.netapp.com/advisory/ntap-20220121-0004/"
  },
  {
    "category": "ADVISORY",
    "locator": "https://www.tenable.com/security/tns-2022-05"
  }
]

```

```

    },
    {
      "category": "ADVISORY",
      "locator": "https://www.debian.org/security/2022/dsa-5073"
    },
    {
      "category": "ADVISORY",
      "locator": "https://cert-portal.siemens.com/productcert/pdf/ssa-484086.pdf"
    },
    {
      "category": "ADVISORY",
      "locator": "https://security.gentoo.org/glsa/202209-24"
    }
  ],
  "modified": "2023-02-14T13:37:37.505975Z",
  "published": "2022-01-02T01:41:26.770663Z"
},
{
  "id": "SNYK-DEBIAN10-EXPAT-2331803",
  "name": "SNYK-DEBIAN10-EXPAT-2331803",
  "summary": "Integer Overflow or Wraparound",
  "details": "## NVD Description\n**_Note:_** _Versions mentioned in the descripti
on apply only to the upstream `expat` package and not the `expat` package as distribut
ed by `Debian:10`.\n_See `How to fix?` for `Debian:10` relevant fixed versions and st
atus.\n\ndefineAttribute in xmlparse.c in Expat (aka libexpat) before 2.4.3 has an in
teger overflow.\n## Remediation\nUpgrade `Debian:10` `expat` to version 2.2.6-2+deb10u
2 or higher.\n## References\n- [ADVISORY] (https://security-tracker.debian.org/tracker/
CVE-2022-22824)\n- [cve@mitre.org] (https://github.com/libexpat/libexpat/pull/539)\n-
[cve@mitre.org] (http://www.openwall.com/lists/oss-security/2022/01/17/3)\n- [cve@mitr
e.org] (https://www.tenable.com/security/tns-2022-05)\n- [cve@mitre.org] (https://www.de
bian.org/security/2022/dsa-5073)\n- [cve@mitre.org] (https://cert-portal.siemens.com/pr
oductcert/pdf/ssa-484086.pdf)\n- [cve@mitre.org] (https://security.gentoo.org/glsa/2022
09-24)\n",
  "relationships": [
    {
      "affect": {
        "to": [
          "docker-image|nginx@1.16",
          "nginx-module-image-filter@1.16.1-1~buster",
          "libgd2/libgd3@2.2.5-5.2",
          "fontconfig/libfontconfig1@2.13.1-2",
          "expat/libexpat1@2.2.6-2+deb10u1"
        ],
        "type": "AFFECTS"
      },
      "foundBy": {
        "to": [
          ""
        ],
        "type": "FOUND_BY"
      },
      "suppliedBy": {
        "to": [
          ""
        ],
        "type": "SUPPLIED_BY"
      },
      "ratedBy": {
        "to": [
          ""
        ],
        "type": "RATED_BY",
        "cwes": [
          190
        ],
        "rating": [

```



```

        {
          "method": "CVSS_3",
          "score": [
            {
              "base": 9.8
            }
          ],
          "severity": "Critical",
          "vector": "CVSS:3.1/AV:N/AC:L/PR:N/UI:N/S:U/C:H/I:H/A:H"
        }
      ]
    }
  ],
  "externalReferences": [
    {
      "category": "ADVISORY",
      "locator": "https://security-tracker.debian.org/tracker/CVE-2022-22824"
    },
    {
      "category": "ADVISORY",
      "locator": "https://github.com/libexpat/libexpat/pull/539"
    },
    {
      "category": "ADVISORY",
      "locator": "http://www.openwall.com/lists/oss-security/2022/01/17/3"
    },
    {
      "category": "ADVISORY",
      "locator": "https://www.tenable.com/security/tns-2022-05"
    },
    {
      "category": "ADVISORY",
      "locator": "https://www.debian.org/security/2022/dsa-5073"
    },
    {
      "category": "ADVISORY",
      "locator": "https://cert-portal.siemens.com/productcert/pdf/ssa-484086.pdf"
    },
    {
      "category": "ADVISORY",
      "locator": "https://security.gentoo.org/glsa/202209-24"
    }
  ],
  "modified": "2023-02-14T13:39:18.516672Z",
  "published": "2022-01-08T13:52:14.479733Z"
}
],
"name": "docker-image|nginx-sha256:d20aa6d1cae56fd17cd458f4807e0de462caf2336f0b70b5e
eb69fcaaf30dd9c",
"dataLicense": "CC0-1.0",
"documentNamespace": "spdx.org/spdxdocs/docker-image|nginx-feb02ce6-cd47-49c2-9a97-2
b4833b4a1f0",
"relationships": [
  {
    "from": "SPDXRef-docker-image|nginx",
    "to": [
      "SPDXRef-index.docker.io/library/nginx-sha256:d20aa6d1cae56fd17cd458f4807e0de4
62caf2336f0b70b5eeb69fcaaf30dd9c"
    ],
    "type": "DESCRIBES"
  }
],
"packages": [
  {
    "SPDXID": "SPDXRef-index.docker.io/library/nginx-sha256:d20aa6d1cae56fd17cd458f4

```

```

807e0de462caf2336f0b70b5eeb69fcaaf30dd9c",
  "versionInfo": "sha256:d20aa6d1cae56fd17cd458f4807e0de462caf2336f0b70b5eeb69fcaaf30dd9c",
  "id": "SPDXRef-index.docker.io/library/nginx-sha256:d20aa6d1cae56fd17cd458f4807e0de462caf2336f0b70b5eeb69fcaaf30dd9c",
  "name": "index.docker.io/library/nginx",
  "checksums": [
    {
      "algorithm": "SHA256",
      "checksumValue": "d20aa6d1cae56fd17cd458f4807e0de462caf2336f0b70b5eeb69fcaaf30dd9c"
    }
  ]
}
]
}
}

```

Supply Chain Security Tools - Scan 2.0 (beta)

This topic gives you an overview of Supply Chain Security Tools (SCST) - Scan 2.0. SCST - Scan 2.0 is the next generation scanning framework for the Tanzu Application Platform. This will supersede the [SCST - Scan component](#) in a future release. The focus of this next generation framework is to simplify the scan integration so that users can create integrations for the available scan engines.



Important

SCST - Scan 2.0 is in beta, which means that it is still in active development by VMware and might be subject to change at any point. Users might encounter unexpected behavior. This is an opt-in component to gather early feedback from beta testers and is not installed by default with any profile.

Overview

SCST - Scan 2.0 provides a framework to scan components of workloads to help users increase the security posture of their application. This component can scan container images using your preferred container image scan solution for known Common Vulnerabilities and Exposures (CVEs). By including this component in a users software supply chain, a user can identify vulnerabilities earlier in the development life cycle.

Scan 2.0 simplifies integrating image scan solutions, such as Anchore's Grype, Aqua's Trivy, Palo Alto's Prisma, and VMware Carbon Black Cloud into Tanzu Application Platform. You achieve this by using the following features of Scan 2.0:

- Reducing the scope of what image scanning is responsible for to include:
 - Scanning a container for vulnerabilities
 - Pushing the scan results in an industry standard format, such as [CycloneDX](#) or [SPDX](#), as an industry standard OCI artifact to an OCI compliant container registry. Using industry standards mitigates the need for users wishing to create an integration to be familiar with proprietary Tanzu Application Platform configurations.
 - Providing a generic interface as a Kubernetes Custom Resource Definition (CRD), `ImageVulnerabilityScan`, that allows users to declare how the Tanzu Application Platform executes a scan on a container image for a container image scan solution.

As part of the Tanzu Application Platform, the Scan 2.0 component scans a container image for a workload that is built by the supply chain or provided as part of a workload definition, and posting the results to the container registry as an OCI artifact. Downstream services in the Tanzu

Application such as the [Tanzu CLI Insight Plugin](#) and the [Supply Chain Choreographer](#) and [Security Analysis](#) dashboards within the [Tanzu Developer portal](#) depend on the data being in the [SCST - Store component](#). Because pushing of scan results to the proprietary store endpoint is decoupled from the scan framework in Scan 2.0, the [AMR Observer \(alpha\)](#) observes results pushed to a container registry, parses the results, and pushes them to the SCST - Store component.

Integrating in to a supply chain

The SCST Scan 2.0 component defines how to scan a container image with a scan solution using the generic Kubernetes custom resource [ImageVulnerabilityScan](#). For [Cartographer](#) to stamp out an [ImageVulnerabilityScan](#) CR as part of a supply chain execution, the [ImageVulnerabilityScan](#) must be wrapped in a [ClusterImageTemplate](#) CR. This CR tells cartographer not only how to stamp out the [ImageVulnerabilityScan](#) template, but also what configurations are passed to it.

Getting started with Scan 2.0

To try out the Scan 2.0 component, review the [Scan 2.0 Getting Started guide](#).

Getting Started with Supply Chain Security Tools - Scan 2.0

You can get started with Supply Chain Security Tools (SCST) - Scan 2.0 by using the following topics:

[Installing SCST - Scan 2.0](#)

[Add App Scanning to Default Test and Scan Supply Chains](#)

[Bring your own scanner with Supply Chain Security Tools - Scan 2.0](#)

[Verifying Scanning with Supply Chain Integration](#)

Install Supply Chain Security Tools - Scan 2.0 in a cluster

The following sections describe how to install Supply Chain Security Tools (SCST) - Scan 2.0. SCST-Scan 2.0 is in beta and is not installed with any profiles and must be installed following these directions.

Prerequisites

SCST - Scan 2.0 requires the following prerequisites:

- Complete all prerequisites to install Tanzu Application Platform. For more information, see [Prerequisites](#).
- Install the [Tekton component](#). Tekton is already installed if you installed Tanzu Application Platform by using a profile based installation in both the Full and Build Profiles.
- Downstream Tanzu Application Platform services, such as Tanzu Developer Portal and Tanzu CLI, depend on scan results stored in the SCST - Store component to display them correctly. You must enable AMR (beta) and AMR Observer (alpha) components. See the [AMR documentation](#).

Configure properties

When you install SCST - Scan 2.0, you can configure the following optional properties:

Key	Default	Type	Description
caCertData	""	string	The custom certificates trusted by the scan's connections
docker.import	true	Boolean	Import <code>docker.pullSecret</code> from another namespace (requires <code>secretgen-controller</code>). Set to false if the secret is already present.
docker.pullSecret	registries-credentials	string	Name of a Docker pull secret in the deployment namespace to pull the scanner images
workspace.storageSize	100Mi	string	Size of the PersistentVolume that the Tekton pipeline runs uses
workspace.storageClass	""	string	Name of the storage class to use while creating the PersistentVolume claims used by tekton pipeline runs

Install

To install SCST - Scan 2.0:

1. List version information for the package by running:

```
tanzu package available list app-scanning.apps.tanzu.vmware.com --namespace tap-install
```

For example:

```
$ tanzu package available list app-scanning.apps.tanzu.vmware.com --namespace tap-install
- Retrieving package versions for app-scanning.apps.tanzu.vmware.com...
  NAME                                VERSION                                RELEASED-AT
  app-scanning.apps.tanzu.vmware.com  0.1.0-beta                            2023-03-01 20:00:00
-0400 EDT
```

2. (Optional) Make changes to the default installation settings:

Retrieve the configurable settings:

```
tanzu package available get app-scanning.apps.tanzu.vmware.com/VERSION --values -schema --namespace tap-install
```

Where `VERSION` is your package version number. For example, `0.1.0-beta`.

For example:

```
tanzu package available get app-scanning.apps.tanzu.vmware.com/0.1.0-beta --values -schema --namespace tap-install
| Retrieving package details for app-scanning.apps.tanzu.vmware.com/0.1.0-beta...

  KEY                                DEFAULT                                TYPE                                DESCRIPTION
  docker.import                      true                                    boolean                            Import `docker.pullSecret` from another namespace (requires
  docker.pullSecret                  registries-credentials                string                             Name of a docker pull secret in the deployment namespace to pull the scanner
  workspace.storageSize              2Gi                                    string                             Size of the Persistent Volume to be used by the tekton pipeline runs
  workspace.storageClass              string                                 string                             Name of the storage class to use while creating the Persistent Volume Claims
  workspace.storageClass              string                                 string                             used by tekton pipeline runs
```

```
caCertData                                string    The custom certificates to be trusted by the scan's connections
```

To edit any of the default installation settings, create an `app-scanning-values-file.yaml` and append the key-value pairs to be modified to the file. For example:

```
scans:
  workspace:
    storageSize: 200Mi
```

3. Install the package. If you did not edit the default installation settings, you do not need to specify the `--values-file` flag.

```
tanzu package install app-scanning-beta --package-name app-scanning.apps.tanzu.
vmware.com \
  --version VERSION \
  --namespace tap-install \
  --values-file app-scanning-values-file.yaml
```

Where `VERSION` is your package version number. For example, `0.1.0-beta`.

For example:

```
tanzu package install app-scanning-alpha --package app-scanning.apps.tanzu.vmwaw
re.com \
  --version 0.1.0-beta \
  --namespace tap-install \
  --values-file app-scanning-values-file.yaml

Installing package 'app-scanning.apps.tanzu.vmware.com'
Getting package metadata for 'app-scanning.apps.tanzu.vmware.com'
Creating service account 'app-scanning-default-sa'
Creating cluster admin role 'app-scanning-default-cluster-role'
Creating cluster role binding 'app-scanning-default-cluster-rolebinding'
Creating package resource
Waiting for 'PackageInstall' reconciliation for 'app-scanning'
'PackageInstall' resource install status: Reconciling
'PackageInstall' resource install status: ReconcileSucceeded
```

Configure service accounts and registry credentials

This section contains instructions for users that are running a standalone ImageVulnerabilityScan or using multiple registries.

If the image that you are scanning, or if you are bringing your own scanner, and your vulnerability scanner image are located in private registries different from the [Tanzu Application Platform bundles registry](#), you must edit your scanner service account to include registry credentials for these registries.



Important

If your use case is listed below, skip this topic and proceed to [Add App Scanning to default Test and Scan supply chains](#).

- You are running an ImageVulnerabilityScan in the context of a supply chain.
- You used the Namespace Provisioner to provision your developer namespace. For more information, see the [Namespace Provisioner documentation](#).

To configure service accounts and registry credentials, SCST - Scan 2.0 requires the following access:

Registry	Permission	Service Account	Example
Tanzu Application Platform bundles registry	Read	scanner	registry.example.com
Target image registry	Read	scanner	your-registry.io
Vulnerability scanner image registry	Read	scanner	your-registry.io
Scan results location registry	Write	publisher	your-registry.io

Where:

- `Tanzu Application Platform bundles registry` is the registry containing the Tanzu Application Platform bundles. This is the registry from the [Relocate images to a registry](#) step.
- `Target image registry` is the registry containing the image to scan. This registry credential is required if you are scanning a private image. The `image to scan` is called the `target image` or `TARGET-IMAGE`.
- `Vulnerability scanner image registry` is the registry containing your vulnerability scanner image. This is only needed if you are bringing your own scanner and your vulnerability scanner image is located in a private registry different from the `Tanzu Application Platform bundles registry`.
- `Scan results location registry` is the registry where scan results are published.

To configure service accounts and registry credentials:

1. Create a secret `scanning-tap-component-read-creds` with read access to the registry containing the Tanzu Application Platform bundles. This pulls the SCST - Scan 2.0 images. You can place your vulnerability scanner image in the registry where you relocated the Tanzu Application Platform bundles to.

```
read -s TAP_REGISTRY_PASSWORD
kubectl create secret docker-registry scanning-tap-component-read-creds \
  --docker-username=TAP-REGISTRY-USERNAME \
  --docker-password=$TAP_REGISTRY_PASSWORD \
  --docker-server=TAP-REGISTRY-URL \
  -n DEV-NAMESPACE
```

Where `DEV-NAMESPACE` is the developer namespace where scanning occurs.

2. If you are scanning a private target image, create a secret `target-image-read-creds` with read access to the registry containing that target image.



Important

If you followed the directions for [Install Tanzu Application Platform](#), you can skip this step and use the `targetImagePullSecret` secret with your service account as referenced in your `tap-values.yaml`. See [Full profile](#).

```
read -s REGISTRY_PASSWORD
kubectl create secret docker-registry target-image-read-creds \
  --docker-username=REGISTRY-USERNAME \
  --docker-password=$REGISTRY_PASSWORD \
  --docker-server=REGISTRY-URL \
  -n DEV-NAMESPACE
```

3. Create a secret `write-creds` with write access to the registry for the scanner to upload the scan results to.

```
read -s WRITE_PASSWORD
kubectl create secret docker-registry write-creds \
  --docker-username=WRITE-USERNAME \
  --docker-password=$WRITE_PASSWORD \
  --docker-server=DESTINATION-REGISTRY-URL \
  -n DEV-NAMESPACE
```

4. (Optional) If you are bringing your own vulnerability scanner and your vulnerability scanner image is located in a private registry different from the registry containing your Tanzu Application Platform bundles, you must create a secret `vulnerability-scanner-image-read-creds` with read access to the registry.

```
read -s WRITE_PASSWORD
kubectl create secret docker-registry vulnerability-scanner-image-read-creds \
  --docker-username=WRITE-USERNAME \
  --docker-password=$WRITE_PASSWORD \
  --docker-server=REGISTRY-URL \
  -n DEV-NAMESPACE
```

5. Create a `scanner-sa.yaml` file containing the service account `scanner` which enables SCST - Scan 2.0 to pull both the vulnerability scanner image and target image. Attach the one or more read secrets created earlier pulling the Tanzu Application Platform bundles, and optionally, your vulnerability scanner image under `imagePullSecrets`. Attach the read secret created earlier for your target image under `secrets`.

```
apiVersion: v1
kind: ServiceAccount
metadata:
  name: scanner
  namespace: DEV-NAMESPACE
imagePullSecrets:
- name: scanning-tap-component-read-creds
- name: vulnerability-scanner-image-read-creds # optional
secrets:
- name: target-image-read-creds
```

Where:

- `imagePullSecrets.name` includes the name of the secret used to pull the scan component from the registry. If you are bringing your own vulnerability scanner and the vulnerability scanner image is located in a separate private registry, you must also include the name of the secret with those registry credentials.
 - `secrets.name` is the name of the secret used to pull the target image to scan. This is required if the image you are scanning is private.
6. Apply the service account to your developer namespace by running:

```
kubectl apply -f scanner-sa.yaml
```

7. Create a `publisher-sa.yaml` file containing the service account `publisher` which enables SCST - Scan 2.0 to push the scan results to a user specified registry.

```
apiVersion: v1
kind: ServiceAccount
metadata:
  name: publisher
  namespace: DEV-NAMESPACE
```

```
imagePullSecrets:
- name: scanning-tap-component-read-creds
secrets:
- name: write-creds
```

Where:

- `imagePullSecrets.name` is the name of the secret used to pull the scan component image from the registry.
- `secrets.name` is the name of the secret used to publish the scan results.

8. Apply the service account to your developer namespace by running:

```
kubectl apply -f publisher-sa.yaml
```

(Optional) Set up your registry retention policy

Although Tanzu Application Platform ingests scan artifacts into the Metadata Store, and stores information such as packages and parsed vulnerabilities, only a pointer to the the original SBOM location is stored. The original SBOM generated by the scan is not preserved within the Metadata Store. VMware recommends that you keep these original artifacts according to your organizations archival requirements.

If the registry specified to push scan results to supports retention policies, you can configure the registry to delete old scan results automatically, depending on your archival requirements. Scan result artifacts accumulate over time and can quickly consume hard disk space.

For information about configuring Harbor tag retention rules, see the [Harbor documentation](#). For example, you can configure Harbor to retain the most recently pushed # artifacts or retain the artifacts pushed within the last # days.

Retention policy setup differs between registry providers. Check with your specific registry's documentation on configuration options.

Add App Scanning to default Test and Scan supply chains

This topic tells you how to enable Supply Chain Security Tools (SCST) - Scan 2.0 and an included container image scanner with the out-of-box box test and scan supply chain. The default out-of-box configuration for the [Testing and Scanning](#) supply chain uses SCST - Scan 1.0 but you can switch to using SCST - Scan 2.0 by using this topic.

Overview

SCST - Scan 2.0 includes two integrations for container image scanners:

- Anchore Grype
- Aqua Trivy

VMware recommends using Aqua Trivy scanner with Tanzu Application Platform for container image scanning. Anchore Grype is included as an open source alternative and for users who want to remain consistent with the default scanner in SCST - Scan 1.0. Additionally, you can build an integration for additional scanners by following the [Bring Your Own Scanner guide](#).

Container Image Scanner	Documentation	Template Name	Status
Aqua Trivy	Link	image-vulnerability-scan-trivy	Recommended out-of-box scanner for Scan 2.0

Container Image Scanner	Documentation	Template Name	Status
Anchore Gype	Link	image-vulnerability-scan-gype	Alternative to Trivy that is used in Scan 1.0

Prerequisites

Before you can integrate SCST - Scan 2.0 with the out of the box supply chain:

- Installed Scan 2.0. See [Install Supply Chain Security Tools - Scan 2.0 in a cluster](#).

Integrate with OOTB Supply Chain

To integrate App Scanning with an OOTB supply chain:

1. After completing the prerequisites, update your `tap-values.yaml` file to specify the Gype ClusterImageTemplate. For example:

```
ootb_supply_chain_testing_scanning:
  image_scanner_template_name: image-vulnerability-scan-gype
```

2. Update your Tanzu Application Platform installation by running:

```
tanzu package installed update tap -p tap.tanzu.vmware.com -v TAP-VERSION --values-file tap-values.yaml -n tap-install
```

Where `TAP-VERSION` is the version of Tanzu Application Platform installed.

3. Downstream Tanzu Application Platform services, such as Tanzu Developer Portal and Tanzu CLI, depend on scan results stored in the SCST - Store component to display them correctly. To do this, you must enable AMR (beta) and AMR Observer (alpha) components. See the [AMR documentation](#).
4. To display scan results in Tanzu Developer Portal, you must give permission for Tanzu Developer Portal to read ImageVulnerabilityScan CRs. See [Tanzu Developer Portal troubleshooting guide](#).
5. [Verify](#) the new scanner.

Bring your own scanner with Supply Chain Security Tools - Scan 2.0

This topic tells you how to bring your own scanner to use with Supply Chain Security Tools (SCST) - Scan 2.0.

Overview

Supply Chain Security Tools (SCST) - Scan 2.0 includes integrations with Trivy and Gype and examples for the following container image scanning tools:

- [Trivy](#)
- [Prisma](#)
- [Snyk](#)
- [Carbon Black Cloud](#)

You might have an existing investment in a scan solution that VMware does not have a published integration with, but Scan 2.0 makes building an integration to bring your own scanner easy. To bring your own scanner to the Tanzu Application Platform:

1. [Create an ImageVulnerabilityScan](#): Create an ImageVulnerabilityScan template that tells the Tanzu Application Platform how to run your scanner.
2. [Verify your ImageVulnerabilityScan](#): Verify that your ImageVulnerabilityScan is working correctly so that downstream Tanzu Application Platform services work correctly.
3. [Wrap your ImageVulnerabilityScan in a ClusterImageTemplate](#): The ClusterImageTemplate wraps the ImageVulnerabilityScan and allows the Tanzu Application Platform supply chain to run the scan job.

Prerequisites

Tanzu Application Platform users must have the following prerequisites:

- Provide a Vulnerability Scanner Image either by:
 - Using a publicly available image that contains the scanner CLI.
 - For example, the official Aqua image for Trivy from [Dockerhub](#).
 - Building your own image with the scanner CLI, which allows for:
 - A more customizable scanning experience.
 - For example, you can create an image with the scanner CLI with any dependencies required to run the scanner CLI.
 - Managing your image to meet the Tanzu Application Platform user's compliance standards.
- Know how your preferred scanner works. For example, commands to use to call scan results.

Bring your own scanner using an ImageVulnerabilityScan

This topic tells you how to bring your own scanner using an [ImageVulnerabilityScan](#). An [ImageVulnerabilityScan](#) allows you to scan with any scanner by defining your scan as a Tekton step. For more information, see the [Tekton documentation](#).

Customize an ImageVulnerabilityScan

To customize an ImageVulnerabilityScan to use your scanner:

1. Create a file named `image-vulnerability-scan.yaml`.

```
apiVersion: app-scanning.apps.tanzu.vmware.com/v1alpha1
kind: ImageVulnerabilityScan
metadata:
  name: generic-image-scan
  namespace: DEV-NAMESPACE
spec:
  image: TARGET-IMAGE
  scanResults:
    location: registry/project/scan-results
  serviceAccountNames:
    scanner: scanner
    publisher: publisher
  steps:
  - name: scan
    image: SCANNER-IMAGE
```

```
command: ["SCANNER-CLI-COMMAND"]
args:
  ...
```

Where:

- `DEV-NAMESPACE` is the developer namespace where scanning occurs.
- `spec.image` is the image that you are scanning. You must specify the digest. See [Retrieving an image digest](#).
- `scanResults.location` is the registry URL where results are uploaded. For example, `my.registry/scan-results`.
- `serviceAccountNames` includes:
 - `scanner` is the service account that runs the scan. It must have read access to `image`.
 - `publisher` is the service account that uploads results. It must have write access to `scanResults.location`.
- `SCANNER-IMAGE` is your vulnerability scanner image, such as the image containing the scanner of your choice.
- `SCANNER-CLI-COMMAND` is the scanner's CLI command.
- `SCANNER-NAME` is the scanner image name that is reported in the Tanzu Developer Portal, formerly Tanzu Application Platform GUI.



Important

Do not define `write-certs` or `cred-helper` as step names. These names are already used during scanning.

2. Configure the `scan` step. You must input your scanner specific `image`, `command`, and `args`. For example:

```
- name: scan
  image: anchore/grype:latest
  command: ["grype"]
  args:
  - registry:${params.image}
  - -o
  - cyclonedx
  - --file
  - $(params.scan-results-path)/scan.cdx
```

To pass `spec.image` and `scanResults.location` to `args`, you can use `$(params.image)` and `$(params.scan-results-path)`.

Because volumes on a Tekton pipeline are shared amongst steps, files created by one step are consumable by the other steps. The scan controller applies the following security context to `pipelinerun.spec.podTemplate`:

```
runAsUser: 65534
fsGroup: 65534
runAsGroup: 65534
```

The `SCANNER-IMAGE` runs and manipulates files with user and group ids of `65534`.

Configuration options

This section lists optional and required ImageVulnerabilityScan specifications fields.

Required fields:

- `image` is the registry URL and digest of the target image. For example, `nginx@sha256:aa0afebbb3cfa473099a62c4b32e9b3fb73ed23f2a75a65ce1d4b4f55a5c2ef2`.
- `scanResults.location` is the registry URL where results are uploaded. For example, `my.registry/scan-results`.

Optional fields:

- `activeKeychains` is an array of enabled credential helpers to authenticate against registries using workload identity mechanisms.

```
activeKeychains:
- name: acr # Azure Container Registry
- name: ecr # Elastic Container Registry
- name: gcr # Google Container Registry
- name: ghcr # Github Container Registry
```

- `serviceAccountNames` includes:
 - `scanner` is the service account that runs the scan. It must have read access to `image`.
 - `publisher` is the service account that uploads results. It must have write access to `scanResults.location`.
- `workspace` includes:
 - `size` is size of the PersistentVolumeClaim the scan uses to download the image and vulnerability database.
 - `bindings` are additional array of secrets, ConfigMaps, or EmptyDir volumes to mount to the running scan. The `name` is used as the mount path.

```
bindings:
- name: additionalconfig
  configMap:
    name: my-configmap
- name: additionalsecret
  secret:
    secretName: my-secret
- name: scratch
  emptyDir: {}
```

For information about workspace bindings, see [Using other types of volume sources](#). Only Secrets, ConfigMaps, and EmptyDirs are supported.

Default environment

The following describes the default environment for Tekton workspaces:

- `/home/app-scanning` is a memory-backed EmptyDir mount that contains service account credentials loaded by Tekton.
- `/cred-helper` is a memory-backed EmptyDir mount containing:
 - `config.json` combines static credentials with workload identity credentials when `activeKeychains` is enabled.
 - `trusted-cas.crt` when SCST - Scan 2.0 is deployed with `caCertData`
- `/workspace` is a PersistentVolumeClaim to hold scan artifacts and results.
 - The working directory for all Steps is by default located at `/workspace/scan-results`.

Environment variables

If undefined by your `step` definition the environment uses the following default variables:

- HOME=/home/app-scanning
- DOCKER_CONFIG=/cred-helper
- XDG_CACHE_HOME=/workspace/.cache
- TMPDIR=/workspace/tmp
- SSL_CERT_DIR=/etc/ssl/certs:/cred-helper

Tekton pipeline parameters:

These parameters are populated after creating the `GrypelImageVulnerabilityScan`. For information about parameters, see the [Tekton documentation](#).

Parameters	Default	Type	Description
image	""	string	The scanned image
scan-results-path	/workspace/scan-results	string	Location to save scanner output
trusted-ca-certs	""	string	PEM data from the installation's <code>caCertData</code>



Note

The `publisher` service account uploads any files, such as scanner output, in the `scan-results-path` directory to the registry of your choice. For information about configuring the registry URL where the `publisher` service account uploads scan results, see [Configure your custom ImageVulnerabilityScan samples](#).

Retrieving an image digest

SCST - Scan 2.0 custom resources require the digest form of the URL. For example, `nginx@sha256:aa0afebbb3cfa473099a62c4b32e9b3fb73ed23f2a75a65ce1d4b4f55a5c2ef2`.

Use the [Docker documentation](#) to pull and inspect an image digest:

```
docker pull nginx:latest
docker inspect --format='{{index .RepoDigests 0}}' nginx:latest
```

Alternatively, you can install [krane](#) to retrieve the digest without pulling the image:

```
krane digest nginx:latest
```

Verifying an ImageVulnerabilityScan

This topic tells you how to verify an `ImageVulnerabilityScan` without Supply Chain integration.

Overview

After you build an `ImageVulnerabilityScan` to bring your own scanner, you can validate the capabilities to verify the integration.

Ensure that the scan integration is working correctly so that downstream servers such as AMR Observer, Tanzu Developer Portal (formerly named Tanzu Application Platform GUI), and the insight CLI can use scan results.

To verify scanning:

1. Verify that a triggered scan is completed.
2. Retrieve the scan results from the registry.
3. Verify that the scan results are in a supported format.

Trigger and observe scanning

To verify that you can scan an image using your ImageVulnerabilityScan:

1. Deploy your ImageVulnerabilityScan to the cluster by running:

```
kubectl apply -f image-vulnerability-scan.yaml -n DEV-NAMESPACE
```

Where `DEV-NAMESPACE` is the name of the developer namespace you want to use.

2. Child resources are created. View the child PipelineRun, TaskRuns, and pods:

```
kubectl get -l imagevulnerabilityscan pipelinerun,taskrun,pod -n DEV-NAMESPACE
```

3. When the scanning completes, the status is shown. Specify `-o wide` to see the digest of the image scanned and the location of the published results.

```
kubectl get imagevulnerabilityscans -n DEV-NAMESPACE -o wide
```

The following is an example of expected output:

NAME	SCANRESULT	SCANNEDIMAGE
SUCCEEDED	REASON	
generic-image-scan	registry/project/scan-results@digest	nginx:latest@digest
True	Succeeded	

Retrieve scan results

Scan results are uploaded to the container image registry as an [imgpkg](#) bundle. To retrieve a vulnerability report:

1. Retrieve the result location from the ImageVulnerabilityScan CR Status:

```
SCAN_RESULT_URL=$(kubectl get imagevulnerabilityscan my-scan -n DEV-NAMESPACE -o jsonpath='{.status.scanResult}')
```

2. Download the bundle to a local directory and list the content:

```
imgpkg pull -b $SCAN_RESULT_URL -o scan-results/
ls scan-results/
```

Validating scan format

After retrieving the scan results, you must verify that the scan results are in a format that downstream Tanzu Application Platform services such as AMR Observer support. AMR Observer supports the following SBOM formats and versions.

Verifying an ImageVulnerabilityScan

SBOM Formats	Versions
CycloneDX	1.2, 1.3, 1.4
SPDX	2.2

VMware recommends validating the scan results by using this CycloneDX tool, [sbom-utility](#). This tool validates CycloneDX and SPDX BOMs against versioned schemas.



Note

The output of the scan must be valid in accordance with SPDX or CycloneDX specifications. If not, although it might be parsed correctly, VMware cannot ensure that the information is parsed correctly, and results might not be displayed accurately in Tanzu Developer Portal and Tanzu Applications CLI.

To validate a scan format with sbom:

1. Setup and install sbom. See the [sbom](#) documentation.
2. Run the `sbom-utility` CLI with the subcommand `validate` to validate the scan report against its declared format, such as SPDX, CycloneDX, and version.

```
./sbom-utility validate -i SCAN-REPORT-FILE-NAME
```

Where `SCAN-REPORT-FILE-NAME` is the name of the scan report.

For example:

```
sbom-utility-v0.11.0-darwin-amd64 % ./sbom-utility validate -i scan-results/scan.json
Welcome to the sbom-utility! Version `v0.11.0` (sbom-utility) (darwin/amd64)
=====
[INFO] Loading license policy config file: `license.json`...
[WARN] Invalid flag for command: `output-file` (`o`). Ignoring...
[INFO] Attempting to load and unmarshal file `/Users/lrobin/go/src/gitlab/app-scanning/scan-results-grype-cyclonedx-json/scan.json`...
[INFO] Successfully unmarshalled data from: `/Users/lrobin/go/src/gitlab/app-scanning/scan-results-grype-cyclonedx-json/scan.json`
[INFO] Determining file's SBOM format and version...
[INFO] Determined SBOM format, version (variant): `CycloneDX`, `1.4` (latest)
[INFO] Matching SBOM schema (for validation): schema/cyclonedx/1.4/bom-1.4.schema.json
[INFO] Loading schema `schema/cyclonedx/1.4/bom-1.4.schema.json`...
[INFO] Schema `schema/cyclonedx/1.4/bom-1.4.schema.json` loaded.
[INFO] Validating `/Users/lrobin/go/src/gitlab/app-scanning/scan-results-grype-cyclonedx-json/scan.json`...
[INFO] SBOM valid against JSON schema: `true`
```



Important

The `sbom-utility` only accepts JSON as input. Your scan report must be a JSON file to use this tool.

Author a ClusterImageTemplate for Supply Chain integration

This topic tells you how to create your own ClusterImageTemplate and customize the embedded ImageVulnerabilityScan to use the scanner of your choice.

Prerequisites

The following prerequisite is required to author a ClusterImageTemplate for Supply Chain integration:

- You create your own ImageVulnerabilityScan or configured one of the samples provided in [Configure your custom ImageVulnerabilityScan](#).

Create a ClusterImageTemplate

This section describes how to create a ClusterImageTemplate using an ImageVulnerabilityScan with Trivy. To use a different scanner, replace the embedded ImageVulnerabilityScan with your own.

- Create a YAML file with the following content and name it `custom-ivs-template.yaml`.

```
apiVersion: carto.run/v1alpha1
kind: ClusterImageTemplate
metadata:
  name: image-vulnerability-scan-custom # input name of your ClusterImageTemplate
spec:
  imagePath: .status.scannedImage
  retentionPolicy:
    maxFailedRuns: 10
    maxSuccessfulRuns: 10
  lifecycle: immutable

  healthRule:
    multiMatch:
      healthy:
        matchConditions:
          - status: "True"
            type: ScanCompleted
          - status: "True"
            type: Succeeded
      unhealthy:
        matchConditions:
          - status: "False"
            type: ScanCompleted
          - status: "False"
            type: Succeeded

  params:
    - name: image_scanning_workspace_size
      default: 4Gi
    - name: image_scanning_service_account_scanner
      default: scanner
    - name: image_scanning_service_account_publisher
      default: publisher
    - name: image_scanning_active_keychains
      default: []
    - name: trivy_db_repository
      default: ghcr.io/aquasecurity/trivy-db
    - name: trivy_java_db_repository
      default: ghcr.io/aquasecurity/trivy-java-db
    - name: registry
      default:
        server: my-registry.io # input your registry server
        repository: my-registry-repository # input your registry repository

  ytt: |
    #@ load("@ytt:data", "data")

    #@ def merge_labels(fixed_values):
```



```

#@ labels = {}
#@ if hasattr(data.values.workload.metadata, "labels"):
#@     labels.update(data.values.workload.metadata.labels)
#@ end
#@ labels.update(fixed_values)
#@ return labels
#@ end

#@ def scanResultsLocation():
#@     return "/".join([
#@         data.values.params.registry.server,
#@         data.values.params.registry.repository,
#@         "-".join([
#@             data.values.workload.metadata.name,
#@             data.values.workload.metadata.namespace,
#@             "scan-results",
#@         ])
#@     ]) + ":" + data.values.workload.metadata.uid
#@ end

#@ def param(key):
#@     if not key in data.values.params:
#@         return None
#@     end
#@     return data.values.params[key]
#@ end

#@ def maven_param(key):
#@     if not key in data.values.params["maven"]:
#@         return None
#@     end
#@     return data.values.params["maven"][key]
#@ end

#@ def correlationId():
#@     if hasattr(data.values.workload, "annotations") and hasattr(data.values.workload.annotations, "apps.tanzu.vmware.com/correlationid"):
#@         return data.values.workload.annotations["apps.tanzu.vmware.com/correlationid"]
#@     end
#@     if not hasattr(data.values.workload.spec, "source"):
#@         return ""
#@     end
#@     url = ""
#@     if hasattr(data.values.workload.spec.source, "git"):
#@         url = data.values.workload.spec.source.git.url
#@     end
#@     if hasattr(data.values.workload.spec.source, "image"):
#@         url = data.values.workload.spec.source.image.split("@")[0]
#@     end
#@     if param("maven"):
#@         url = param("maven_repository_url") + "/" + maven_param("groupId").replace(".", "/") + "/" + maven_param("artifactId")
#@     end
#@     return url + "?sub_path=" + getattr(data.values.workload.spec.source, "subPath", "/")
#@ end

---
apiVersion: app-scanning.apps.tanzu.vmware.com/v1alpha1
kind: ImageVulnerabilityScan
metadata:
  labels: #@ merge_labels({ "app.kubernetes.io/component": "image-scan" })
  annotations:
    apps.tanzu.vmware.com/correlationid: #@ correlationId()
  generateName: #@ data.values.workload.metadata.name + "-trivy-scan-"

```

```

spec:
  image: #@ data.values.image
  activeKeychains: #@ data.values.params.image_scanning_active_keychains
  scanResults:
    location: #@ scanResultsLocation()
  workspace:
    size: #@ data.values.params.image_scanning_workspace_size
  serviceAccountNames:
    scanner: #@ data.values.params.image_scanning_service_account_scanner
    publisher: #@ data.values.params.image_scanning_service_account_publisher
er
  steps:
    - name: trivy-generate-report
      image: my.registry.com/aquasec/trivy:0.41.0      # input the location of
your trivy scanner image
      env:
        - name: TRIVY_DB_REPOSITORY
          value: #@ data.values.params.trivy_db_repository
        - name: TRIVY_JAVA_DB_REPOSITORY
          value: #@ data.values.params.trivy_java_db_repository
        - name: TRIVY_CACHE_DIR
          value: /workspace/trivy-cache
        - name: XDG_CACHE_HOME
          value: /workspace/.cache
        - name: TMPDIR
          value: /workspace
      args:
        - image
        - $(params.image)
        - --exit-code=0
        - --no-progress
        - --scanners=vuln
        - --format=cyclonedx
        - --output=scan.cdx.json
    - name: trivy-display-report
      image: my.registry.com/aquasec/trivy:0.41.0      # input the location of
your trivy scanner image
      env:
        - name: TRIVY_DB_REPOSITORY
          value: #@ data.values.params.trivy_db_repository
        - name: TRIVY_JAVA_DB_REPOSITORY
          value: #@ data.values.params.trivy_java_db_repository
        - name: TRIVY_CACHE_DIR
          value: /workspace/trivy-cache
        - name: XDG_CACHE_HOME
          value: /workspace/.cache
        - name: TMPDIR
          value: /workspace
      args:
        - image
        - $(params.image)
        - --skip-db-update
        - --skip-java-db-update
        - --exit-code=0
        - --scanners=vuln
        - --severity=HIGH
        - --no-progress

```

Where:

- o `.metadata.name` is the name of your ClusterImageTemplate. Ensure that it does not conflict with the names of packaged templates. See [Author your supply chains](#).
- o `registry-server` is the registry server.
- o `registry-repository` is the registry repository.

**Note**

apps.tanzu.vmware.com/correlationid contains the metadata of the mapping to the source of the resource being scanned. See [here](#).

2. Edit the following in your `custom-ivs-template.yaml` file:
 - `.metadata.name` is the name of your ClusterImageTemplate.
 - `registry-server` and `registry-repository` refer to your registry.
 - The location of your Trivy scanner image
3. (Optional) If you are replacing the embedded ImageVulnerabilityScan with your own, use `ytt` to pass relevant values to the ImageVulnerabilityScan:

```
metadata:
  labels: #@ merge_labels({ "app.kubernetes.io/component": "image-scan" })
  generateName: #@ data.values.workload.metadata.name + "-trivy-scan-"
spec:
  image: #@ data.values.image
  activeKeychains: #@ data.values.params.image_scanning_active_keychains
  scanResults:
    location: #@ scanResultsLocation()
  workspace:
    size: #@ data.values.params.image_scanning_workspace_size
  serviceAccountNames:
    scanner: #@ data.values.params.image_scanning_service_account_scanner
    publisher: #@ data.values.params.image_scanning_service_account_publisher
```

4. Create the ClusterImageTemplate:

```
kubectl apply -f custom-ivs-template.yaml
```

5. After you create your custom ClusterImageTemplate, you can integrate it with SCST - Scan 2.0. See [Add App Scanning to default Test and Scan supply chains](#).

Configure your custom ImageVulnerabilityScan samples for Supply Chain Security Tools - Scan

This topic gives you sample ImageVulnerabilityScans for various scanners, and any associated secrets.

ImageVulnerabilityScan samples

This section includes ImageVulnerabilityScans (IVS) for various scanners. To use them, copy the YAML content for the scanner you want to use in the following topics:

- [Carbon Black](#)
- [Snyk](#)
- [Prisma](#)
- [Trivy](#)
- [Grype](#)

Use custom ImageVulnerabilityScan samples

To use a custom ImageVulnerabilityScan sample:

1. Copy the sample YAML into a file named `custom-ivs.yaml`. Some scanners, such as Carbon Black, Snyk, and Prisma Scanner, require specific credentials that you must specify in the secret.
2. Obtain the one or more necessary images. For example, an image containing the scanner.
3. Edit these fields of your ImageVulnerabilityScan:
 - `spec.image` is the image that you are scanning. See [Retrieving an image digest](#).
 - `scanResults.location` is the registry URL where the `publisher` service account uploads the scan results. For example, `my.registry/scan-results`.
 - `serviceAccountNames` includes:
 - `scanner` is the service account that runs the scan. It must have read access to `image`.
 - `publisher` is the service account that uploads results. It must have write access to `scanResults.location`.
4. Complete any scanner specific changes specified on the sample ImageVulnerabilityScan page.
5. You can either incorporate your custom ImageVulnerabilityScan into a [ClusterImageTemplate](#) or run a standalone scan using:

```
kubectl apply -f custom-ivs.yaml -n DEV-NAMESPACE
```

Where `DEV-NAMESPACE` is the name of the developer namespace where scanning occurs.

Retrieving an image digest

SCST - Scan 2.0 custom resources require the digest form of the URL. For example, `nginx@sha256:aa0afebbb3cfa473099a62c4b32e9b3fb73ed23f2a75a65ce1d4b4f55a5c2ef2`.

Use the [Docker documentation](#) to pull and inspect an image digest:

```
docker pull nginx:latest
docker inspect --format='{{index .RepoDigests 0}}' nginx:latest
```

Alternatively, you can install [krane](#) to retrieve the digest without pulling the image:

```
krane digest nginx:latest
```

Configure a ImageVulnerabilityScan for Carbon Black

This topic gives you an example of how to configure a secret and ImageVulnerabilityScan (IVS) for Carbon Black.

Example secret

This section contains a sample secret containing the Carbon Black credentials inside the `~/cbctl/cbctl.yaml` config file. These credentials are used to authenticate your Carbon Black account. You can find it in the Carbon Black console. See the [Carbon Black documentation](#). You must apply this once to your developer namespace.

```
apiVersion: v1
kind: Secret
metadata:
  name: cbctl-creds
```

```
stringData:
  cbctl: |
    cb_api_id: CB-API-ID
    cb_api_key: CB-API-KEY
    org_key: ORG-KEY
    saas_url: SAAS-URL
```

Where:

- **CB-API-ID** is the API ID obtained from Carbon Black Cloud.
- **CB-API-KEY** is the API Key obtained from Carbon Black.
- **ORG-KEY** is the Org Key for your Carbon Black organization.
- **SAAS-URL** is the Carbon Black Backend URL.

Example ImageVulnerabilityScan

This section contains a sample IVS that uses Carbon Black to scan a targeted image and push the results to the specified registry location. For information about the IVS specification, see [Configuration Options](#).

Set the tekton-pipelines feature-flags configmap `enable-api-fields` to `alpha`. This lets you use the `stdoutConfig` which is needed to output the scan report as a file.

```
apiVersion: app-scanning.apps.tanzu.vmware.com/v1alpha1
kind: ImageVulnerabilityScan
metadata:
  name: carbon-black-ivs
spec:
  image: nginx@sha256:... # The image to be scanned. Digest must be specified.
  scanResults:
    location: registry/project/scan-results
  serviceAccountNames:
    publisher: publisher
    scanner: scanner
  workspace:
    bindings:
      - name: cbctl
        secret:
          secretName: cbctl-creds
        items:
          - key: cbctl
            path: .cbctl.yaml
  steps:
  - name: carbon-black
    image: CARBON-BLACK-SCANNER-IMAGE
    imagePullPolicy: IfNotPresent
    command:
      - cbctl
      - image
      - scan
      - --force=true
      - $(params.image)
      - --config
      - /cbctl/.cbctl.yaml
      - --ocyclonedx
    stdoutConfig:
      path: /workspace/scan-results/scan-results.cdx.xml
```

Where `CARBON-BLACK-SCANNER-IMAGE` is the Carbon Black scanner image. For example, `cbartifactory/cbctl:latest`.

For information about publicly available Carbon Black images, see [DockerHub](#). For more information about using the Carbon Black Scanner CLI, see the [Carbon Black documentation](#).

The Carbon Black `cbctl-creds` secret is mounted as a workspace binding and the credentials are inserted into a `cbctl.yaml` config file that the Carbon Black CLI uses.

`stdoutConfig.path` is specified to take the output stream of the step to a file where you can publish it to the registry. For more information, see the [Tekton documentation](#).

Disclaimer

For the publicly available Carbon Black scanner CLI image, CLI commands and parameters used are accurate at the time of documentation.

Configure an ImageVulnerabilityScan for Snyk

This topic tells you how to configure an ImageVulnerabilityScan for Snyk.

Example Secret



Important

For the publicly available Snyk scanner CLI image, CLI commands and parameters used are accurate at the time of documentation.

This section contains a sample secret containing the Snyk API token, which authenticates your Snyk account. You must apply this once to your developer namespace.

```

apiVersion: v1
kind: Secret
metadata:
  name: snyk-token
stringData:
  snyk: |
    {"api": "SNYK-API-TOKEN"}
---
apiVersion: app-scanning.apps.tanzu.vmware.com/v1alpha1
kind: ImageVulnerabilityScan
metadata:
  name: snyk-ivs
spec:
  image: nginx@sha256:... # The image to be scanned. Digest must be specified.
  scanResults:
    location: registry/project/scan-results
  serviceAccountNames:
    publisher: publisher
    scanner: scanner
  workspace:
    bindings:
      - name: snyk
        secret:
          secretName: snyk-token
        items:
          - key: snyk
            path: configstore/snyk.json
  steps:
    - name: snyk
      image: SNYK-SCANNER-IMAGE
      env:
        - name: XDG-CONFIG-HOME

```

```

    value: /snky
    command: ["snky","container","test",$(params.image),"--json-file-output=$(params.s
can-results-path)/scan.json"]
    onError: continue
  - name: snyk2spdx # You will need to create your own image. See explanation below.
    image: SNYK2SPDX-IMAGE
    command: ["/bin/bash"]
    args:
      - "-c"
      - |
        set -e
        cat $(params.scan-results-path)/scan.json | /app/bin/snyk2spdx --output=$(para
ms.scan-results-path)/scan.spdx.json

```

Where:

- `TARGET-IMAGE` is the image to be scanned. You must specify the digest.
- `SNYK-SCANNER-IMAGE` is the image containing the Snyk CLI. For example, `snyk/snyk:golang`. For information about publicly available Snyk images, see [DockerHub](#). For more information about using the Snyk CLI, see the [Snyk documentation](#).
- `XDG-CONFIG-HOME` is the directory that contains your Snyk CLI config file, `configstore/snyk.json`, which is populated using the snyk-token `Secret` you created. For more information, see the [Snyk Config documentation](#).
- `SNYK2SPDX-IMAGE` is the image used to convert the Snyk CLI output `scan.json` in the `snyk` step to SPDX format and have its missing `DOCUMENT DESCRIBES` relation inserted. See the Snyk [snyk2spdx repository](#) in GitHub.

To use the sample:

1. Clone the [snyk2spdx repository](#).
2. Add the following Dockerfile to the root of the repository:

```

FROM node AS build

RUN npm install -g typescript
RUN npm install -g ts-node

WORKDIR /build-dir
ADD . .

RUN npm install --legacy-peer-deps
RUN npm run build && npm prune --json --omit=dev --legacy-peer-deps
RUN npx nexe@3.3.7 dist/index.js -r './dist/**/*.js' -t linux-x64-12.16.2 -o s
nyk2spdx-linux

FROM paketobuildpacks/builder-jammy-base AS run

ENTRYPOINT ["/app/bin/snyk2spdx"]
CMD ["/app/bin/snyk2spdx"]

```



Note

After detecting vulnerabilities, the Snyk image exits with Exit Code 1 and causes a failed scan task. You can ignore the step error by setting `onError` and handling the error in a subsequent step.

3. Build and push the image to a registry. Replace `SNYK2SPDX-IMAGE` with the new image you built.

The `snyk2spdx` output does not conform to the [verification process](#). Although the results might be ingested to the Tanzu Application Platform metadata store, VMware does not ensure the accuracy of the results.



Note

After detecting vulnerabilities, the Snyk image exits with Exit Code 1 and causes a failed scan task. You can ignore the step error by setting `onError` and handling the error in a subsequent step. For instructions, see the [Tekton documentation](#).

For information about setting up scanner credentials, see the [Snyk CLI documentation](#).

Configure an ImageVulnerabilityScan for Prisma

This topic gives you an example of how to configure a secret and ImageVulnerabilityScan (IVS) for Prisma.

Example secret

This section contains a sample secret containing the Prisma Cloud account access key, secret key, and console URL which are used to authenticate your Prisma account. You must apply this once to your developer namespace.

```
apiVersion: v1
kind: Secret
metadata:
  name: prisma-auth
stringData:
  username: USERNAME
  password: PASSWORD
  address: ADDRESS
```

Where:

- `USERNAME` is the access Key from the Prisma Cloud account.
- `PASSWORD` is the secret Key from the Prisma Cloud account.
- `ADDRESS` is the URL for Console from the Prisma Cloud account.

Example ImageVulnerabilityScan

This section contains a sample IVS that uses Prisma to scan a targeted image and push the results to the specified registry location. For information about the IVS specification, see [Configuration Options](#).

```
apiVersion: app-scanning.apps.tanzu.vmware.com/v1alpha1
kind: ImageVulnerabilityScan
metadata:
  name: prisma-ivs
spec:
  image: TARGET-IMAGE
  scanResults:
    location: registry/project/scan-results
  serviceAccountNames:
    publisher: publisher
    scanner: scanner
  steps:
```



```

- name: prisma
  image: PRISMA-SCANNER-IMAGE
  imagePullPolicy: IfNotPresent
  workingDir: /workspace
  securityContext:
    privileged: true
    allowPrivilegeEscalation: true
    seccompProfile:
      type: RuntimeDefault
    capabilities:
      drop:
        - ALL
  script: |
    #!/bin/bash
    # Alternative method of making twistcli available in the container
    curl --output ./twistcli --write-out "%{http_code}" -s -L -k -u $USER_NAME:$PASS
WORD $ADDRESS/api/v1/util/twistcli
    chmod +x /workspace/twistcli

    if [[ ! -e /cred-helper/config.json ]]; then
    echo "{}" > /cred-helper/config.json
    fi

    podman pull $IMAGE
    twistcli images scan --podman-path /usr/bin/podman --address $ADDRESS --user $US
ER_NAME --password $PASSWORD $IMAGE --output-file ./twist-scan.json --containerized

    # Input commands used for your Prisma summary report conversion. See below for m
ore detail.
    twistoutput=./twist-scan.json
    twistversion=$(./twistcli -v | sed "s/twistcli version //" )
    IMAGE_NAME=$(echo $IMAGE | cut -d'@' -f1)
    IMAGE_DIGEST=$(echo $IMAGE | cut -d'@' -f2)
    /prismaconverter image $twistversion $twistoutput "/" "./scan-results/twist-sca
n-cdx.json" $IMAGE_NAME $IMAGE_DIGEST
  env:
    - name: USER_NAME
      valueFrom:
        secretKeyRef:
          key: username
          name: prisma-auth
          optional: false
    - name: PASSWORD
      valueFrom:
        secretKeyRef:
          key: password
          name: prisma-auth
          optional: false
    - name: ADDRESS
      valueFrom:
        secretKeyRef:
          key: address
          name: prisma-auth
          optional: false
    - name: IMAGE
      value: $(params.image)
  workspace: {}

```

Where:

- **TARGET-IMAGE** is the image to scan. You must specify the digest.
- **PRISMA-SCANNER-IMAGE** is the image containing the Prisma Cloud `twistcli`, `podman`, and a utility to convert the Prisma summary report in JSON format to a CycloneDX SBOM in XML format. The Prisma scanner produces a proprietary output instead of community standard CycloneDX or SPDX. Because of this, you cannot use the scan report summary produced by

Prisma as is and you must convert it. Contact your account team if you want to use Prisma and need this utility.

- The `securityContext` grants root access as Prisma requires root access to run. If permission is not given, you might encounter a `cannot clone: Operation not permitted` error message. For information about the `securityContext`, see [Customize an ImageVulnerabilityScan](#). Due to needing root access, you cannot run Prisma scans in clusters with restricted pod Security Standards.

For information about using the CLI, see the Prisma [twistcli docs](#).

Configure an ImageVulnerabilityScan for Trivy

This topic gives you an example of how to configure an ImageVulnerabilityScan (IVS) for Trivy.

Example ImageVulnerabilityScan

This section gives you an example IVS that uses Trivy to scan a targeted image and push the results to the specified registry location. For information about the IVS specification, see [Configuration Options](#).

```
apiVersion: app-scanning.apps.tanzu.vmware.com/v1alpha1
kind: ImageVulnerabilityScan
metadata:
  name: trivy-ivs
spec:
  image: TARGET-IMAGE
  scanResults:
    location: registry/project/scan-results
  serviceAccountNames:
    publisher: publisher
    scanner: scanner
  steps:
  - name: trivy
    image: TRIVY-SCANNER-IMAGE
    command: ["trivy"]
    args:
    - image
    - --format
    - cyclonedx
    - --output
    - $(params.scan-results-path)/scan.cdx.json
    - --scanners
    - vuln
    - $(params.image)
```

Where:

- `TARGET-IMAGE` is the image to be scanned. Digest must be specified.
- `TRIVY-SCANNER-IMAGE` is the image containing the Trivy CLI. For example, `aquasec/trivy:0.42.1` For information about publicly available Trivy images, see [DockerHub](#). For more information about using the Trivy CLI, see the [Trivy documentation](#).

Configure a ImageVulnerabilityScan for Grype

This topic gives you an example of how to configure an ImageVulnerabilityScan (IVS) for Grype.

Example ImageVulnerabilityScan

This section contains a sample IVS that uses Grype to scan a targeted image and push the results to the specified registry location. For information about the IVS specification, see [Configuration Options](#).

```
apiVersion: app-scanning.apps.tanzu.vmware.com/v1alpha1
kind: ImageVulnerabilityScan
metadata:
  name: grype-ivs
spec:
  image: TARGET-IMAGE
  scanResults:
    location: registry/project/scan-results
  serviceAccountNames:
    publisher: publisher
    scanner: scanner
  steps:
  - name: grype
    image: GRYPE-SCANNER-IMAGE
    args:
      - -o
      - cyclonedx-json
      - registry:${(params.image)}
      - --file
      - /workspace/scan-results/scan.cdx.json
    env:
      - name: GRYPE_ADD_CPES_IF_NONE
        value: "false"
      - name: GRYPE_EXCLUDE
      - name: GRYPE_SCOPE
```

Where:

- `TARGET-IMAGE` is the image to scan. You must specify digest.
- `GRYPE-SCANNER-IMAGE` is the image containing the Grype CLI. For example, `anchore/grype:latest`. For information about publicly available Grype images, see [DockerHub](#). For more information about using the Grype CLI, see the [Grype documentation](#).

Verify scanning with Supply Chain integration

This topic tells you how to verify scanning with Supply Chains.

Create a workload

1. Create a sample workload with a pre-built image by using the `tanzu apps workload create` command:

```
tanzu apps workload create WORKLOAD-NAME \
  --app APP-NAME \
  --git-repo GIT-REPO \
  --git-branch GIT-BRANCH \
  --type TYPE \
  --namespace DEV-NAMESPACE
```

Where:

- `WORKLOAD-NAME` is the name you choose for your workload.
- `APP-NAME` is the name of your app.
- `GIT-REPO` is the Git repository from which the workload is created.

- `GIT-BRANCH` is the branch in a Git repository from where the workload is created.
- `TYPE` is the type of your app.
- `DEV-NAMESPACE` is the name of the developer namespace where scanning occurs.



Note

For information about how to use the Tanzu CLI workload creation, see [Create a Workload](#).

Retrieve scan results

Scan results are uploaded to the container image registry as an `imgpkg` bundle. To retrieve a vulnerability report:

1. Retrieve the result location from the ImageVulnerabilityScan CR Status:

```
SCAN_RESULT_URL=$(kubectl get imagevulnerabilityscan my-scan -n DEV-NAMESPACE -o jsonpath='{.status.scanResult}')
```

2. Download the bundle to a local directory and list the content:

```
imgpkg pull -b $SCAN_RESULT_URL -o scan-results/
ls scan-results/
```

Supply Chain Security Tools - Scan 2.0 Observability

This topic guides you through observing Supply Chain Security Tools (SCST) - Scan 2.0. This helps you understand each step of scanning.

Scanning Steps

This section describes each of the scanning steps and corresponding observability methods.

- To watch the status of the scanning custom resources and child resources:

```
kubectl get -l imagevulnerabilityscan pipelinerun,taskrun,pod
kubectl get imagevulnerabilityscan
```

- View the status, reason, and urls:

```
kubectl get imagevulnerabilityscan -o wide
```

- View the complete status and events of scanning custom resources:

```
kubectl describe imagevulnerabilityscan IMAGE-VULNERABILITY-SCAN-NAME
```

Where `IMAGE-VULNERABILITY-SCAN-NAME` is the name of an ImageVulnerabilityScan resource you want to inspect.

- List the child resources of a scan:

```
kubectl get -l imagevulnerabilityscan=$NAME pipelinerun,taskrun,pod
```

- Get the logs of the controller:

```
kubectl logs -f deployment/app-scanning-controller-manager -n app-scanning-system -c manager
```

Troubleshooting Supply Chain Security Tools - Scan 2.0

This topic helps you troubleshoot Supply Chain Security Tools (SCST) - Scan 2.0.

Overview

When Scan 2.0 creates an ImageVulnerabilityScan, the following resources are also created:

- Tekton `PipelineRun` with the following `Tasks`:
 - workspace-setup-task
 - scan-task
 - publish-task
- Tekton `TaskRun` corresponding to each `Task`
- `Pod` corresponding to each `TaskRun`

Viewing resources

- To view all resources:

```
kubectl get imagevulnerabilityscans, pipelineruns, taskruns, pods -n DEV-NAMESPACE
```

Where `DEV-NAMESPACE` is the name of your developer namespace.

- To verify which resources are failing, proceed to the following debugging sections:

```
NAME                                                                 SUCCEEDED
REASON
imagevulnerabilityscan.app-scanning.apps.tanzu.vmware.com/my-scan  False
Failed

NAME                                                                 SUCCEEDED  REASON  STARTTIME  COMPLETIONTIME
pipelinerun.tekton.dev/my-scan-5kllf  False      Failed   2m10s      85s

NAME                                                                 SUCCEEDED  REASON
STARTTIME  COMPLETIONTIME
taskrun.tekton.dev/my-scan-5kllf-publish-task  False      Failed
94s      85s
taskrun.tekton.dev/my-scan-5kllf-scan-task    True       Succeeded
2m1s      94s
taskrun.tekton.dev/my-scan-5kllf-workspace-setup-task  True       Succeeded
2m9s      2m1s

NAME          READY  STATUS    RESTARTS  AGE
pod/my-scan-5kllf-publish-task-pod  0/4    Completed  1          94s
pod/my-scan-5kllf-scan-task-pod    0/4    Completed  1          2m
pod/my-scan-5kllf-workspace-setup-task-pod  0/2    Completed  1          2m10s
```

Debugging commands

The following sections describe commands you run to get logs and details about scanning errors.

Debugging resources

If a resource fails or has errors, inspect the resource. If multiple resources are involved, inspecting them all may provide a broader understanding (e.g. inspecting the corresponding [TaskRun](#) to a failed [Pod](#)).

To get status conditions on a resource:

```
kubectl describe RESOURCE RESOURCE-NAME -n DEV-NAMESPACE
```

Where:

- `RESOURCE` is one of the following: [ImageVulnerabilityScan](#), [PipelineRun](#), [TaskRun](#), Or [Pod](#).
- `RESOURCE-NAME` is the name of the `RESOURCE`.
- `DEV-NAMESPACE` is the name of your developer namespace.

Debugging scan pods

You can use the following methods to debug scan pods:

- To get error logs from a pod when scan pods fail:

```
kubectl logs SCAN-POD-NAME -n DEV-NAMESPACE
```

Where `SCAN-POD-NAME` is the name of the scan pod.

For information about debugging Kubernetes pods, see the [Kubernetes documentation](#).

A scan run that has an error may indicate that one of the following step containers has a failure:

- `step-workspace-setup`
- `step-write-certs`
- `step-cred-helper`
- `step-SCANNER`
- `step-publisher`
- `sidecar-sleep`

Where `step-SCANNER` is your [scanner step](#).

- To verify which step container had a [failed exit code](#):

```
kubectl get taskrun TASKRUN-NAME -o json | jq .status
```

Where `TASKRUN-NAME` is the name of the TaskRun.

- To inspect a specific step container in a pod:

```
kubectl logs scan-pod-name -n DEV-NAMESPACE -c step-container-name
```

Where `DEV-NAMESPACE` is your developer namespace.

For information about debugging a TaskRun, see the [Tekton documentation](#).

- To debug inside of the scan-task pod: Add an additional step with a `sleep` command after your scanner step in the [ImageVulnerabilityScan](#). For example:

```
...
spec:
```

```

...
steps:
- name: SCANNER-STEP
  ...
- name: view
  image: busybox:latest
  args:
  - -c
  - sleep 6000

```

This keeps the pod in a running state so that you can exec into it. Re-run the scan and then exec into the pod:

```

kubectl exec SCAN-TASK-POD-NAME -n DEV-NAMESPACE -c step-view --stdin --tty
-- sh

```

Where `SCAN-TASK-POD-NAME` is the name of your scan-task pod.

Viewing the Scan-Controller manager logs

You can run these commands to view the Scan-Controller manager logs:

- Retrieve scan-controller manager logs:

```

kubectl logs deployment/app-scanning-controller-manager -n app-scanning-system

```

- Tail scan-controller manager logs:

```

kubectl logs -f deployment/app-scanning-controller-manager -n app-scanning-system

```

Troubleshooting issues

Volume permission error

If you encounter a permission error for accessing, opening, and writing to the files inside cluster volume, such as:

```

unsuccessful cred copy: ".git-credentials" from "/tekton/creds" to "/home/app-scanning":
unable to open destination: open /home/app-scanning/.git-credentials: permission denied

```

Ensure that the problematic step runs with the [proper user and group ids](#).

Incompatible Tekton version

Tanzu Application Platform v1.7.0 includes [app-scanning.apps.tanzu.vmware.com](#) version 0.2.0 and Tekton Pipelines version 0.50.1. The [app-scanning.apps.tanzu.vmware.com](#) package is incompatible with previous versions of Tekton Pipelines as v1 CRDs were not enabled. You must first upgrade the Tanzu Application Platform package to v1.7.0 or greater prior to upgrading [app-scanning.apps.tanzu.vmware.com](#).

If you did not upgrade in the above order, you may encounter ImageVulnerabilityScans not progressing.

```

NAME          SUCCEEDED  REASON
my-scan

```

To resolve this issue:

1. Confirm that the issue is due to installation of an incompatible Tekton version by viewing the controller manager logs.

```
kubectl -n app-scanning-system logs -f deployment/app-scanning-controller-manager -c manager
```

If you encounter the following error, proceed to the next step:

```
ERROR controller-runtime.source.EventHandler failed to get informer from cache
{"error": "failed to get API group resources: unable to retrieve the complete list of
server APIs: tekton.dev/v1: the server could not find the requested resource"}
```

1. Follow [Upgrade your Tanzu Application Platform](#) to upgrade TAP to version [v1.7.0](#) or greater.

Scan results empty

The publish-task task will fail if the `scan-results-path` (default value of `/workspace/scan-result`) is empty. To confirm, view the logs of the publish-task pod:

```
kubectl logs PUBLISH-TASK-POD-NAME -c step-publisher -n DEV-NAMESPACE
```

Where `PUBLISH-TASK-POD-NAME` is the name of your publish-task pod.

```
2023/08/22 17:09:49 results folder /workspace/scan-results is empty
```

To resolve this issue, you can debug within the scan-task pod by following the instructions under [Debugging scan pods](#). You will need to use an image with both a shell and your scanner CLI image to run the `sleep` command and troubleshoot your scanner commands from within the container.

Overview of Supply Chain Security Tools for VMware Tanzu - Sign

This component is removed in Tanzu Application Platform v1.4 in favor of [Supply Chain Security Tools - Policy Controller](#).

To migrate from Supply Chain Security Tools - Sign to Supply Chain Security Tools - Policy Controller, see [Migration From Supply Chain Security Tools - Sign](#)

Overview of Supply Chain Security Tools for Tanzu – Store

This topic gives you an overview of Supply Chain Security Tools (SCST) – Store.

Overview

Supply Chain Security Tools - Store saves software bills of materials (SBOMs) to a database and allows you to query for image, source code, package, and vulnerability relationships. It integrates with [Supply Chain Security Tools - Scan](#) to automatically store the resulting source code and image vulnerability reports. It accepts CycloneDX input and outputs in both human-readable and machine-readable formats, including JSON, text, and CycloneDX.

The following is a quick demo of configuring the tanzu insight plug-in and querying the metadata store for CVEs and scan results.



Using the Tanzu Insight CLI plug-in

The Tanzu Insight CLI plug-in is the primary way to view results from the Supply Chain Security Tools - Scan of source code and image files. Use it to query by source code commit, image digest, and CVE identifier to understand security risks.

See [Tanzu Insight plug-in overview](#) to install, configure, and use `tanzu insight`.

Multicluster configuration

See [Multicluster setup](#) for information about how to set up SCST - Store in a multicluster setup.

Integrating with Tanzu Developer Portal

Using the Supply Chain Choreographer in Tanzu Developer Portal (formerly named Tanzu Application Platform GUI), you can visualize your supply chain. It uses SCST - Store to show the packages and vulnerabilities in your source code and images.

Additional documentation

[Additional documentation](#) includes information about the API, deployment details and configuration, AWS RDS configuration, other database backup recommendations, known issues, and other topics.

Overview of Supply Chain Security Tools for Tanzu – Store

This topic gives you an overview of Supply Chain Security Tools (SCST) – Store.

Overview

Supply Chain Security Tools - Store saves software bills of materials (SBOMs) to a database and allows you to query for image, source code, package, and vulnerability relationships. It integrates with [Supply Chain Security Tools - Scan](#) to automatically store the resulting source code and image vulnerability reports. It accepts CycloneDX input and outputs in both human-readable and machine-readable formats, including JSON, text, and CycloneDX.

The following is a quick demo of configuring the `tanzu insight` plug-in and querying the metadata store for CVEs and scan results.



Using the Tanzu Insight CLI plug-in

The Tanzu Insight CLI plug-in is the primary way to view results from the Supply Chain Security Tools - Scan of source code and image files. Use it to query by source code commit, image digest, and CVE identifier to understand security risks.

See [Tanzu Insight plug-in overview](#) to install, configure, and use `tanzu insight`.

Multicluster configuration

See [Multicluster setup](#) for information about how to set up SCST - Store in a multicluster setup.

Integrating with Tanzu Developer Portal

Using the Supply Chain Choreographer in Tanzu Developer Portal (formerly named Tanzu Application Platform GUI), you can visualize your supply chain. It uses SCST - Store to show the packages and vulnerabilities in your source code and images.

Additional documentation

[Additional documentation](#) includes information about the API, deployment details and configuration, AWS RDS configuration, other database backup recommendations, known issues, and other topics.

Data models and concepts for Supply Chain Security Tools - Store

This topic describes the different data models and concepts the Supply Chain Security Tools (SCST) - Store uses for consuming and providing information.

Overview

This diagram shows an overview of the SCST - Store data models and their relations.

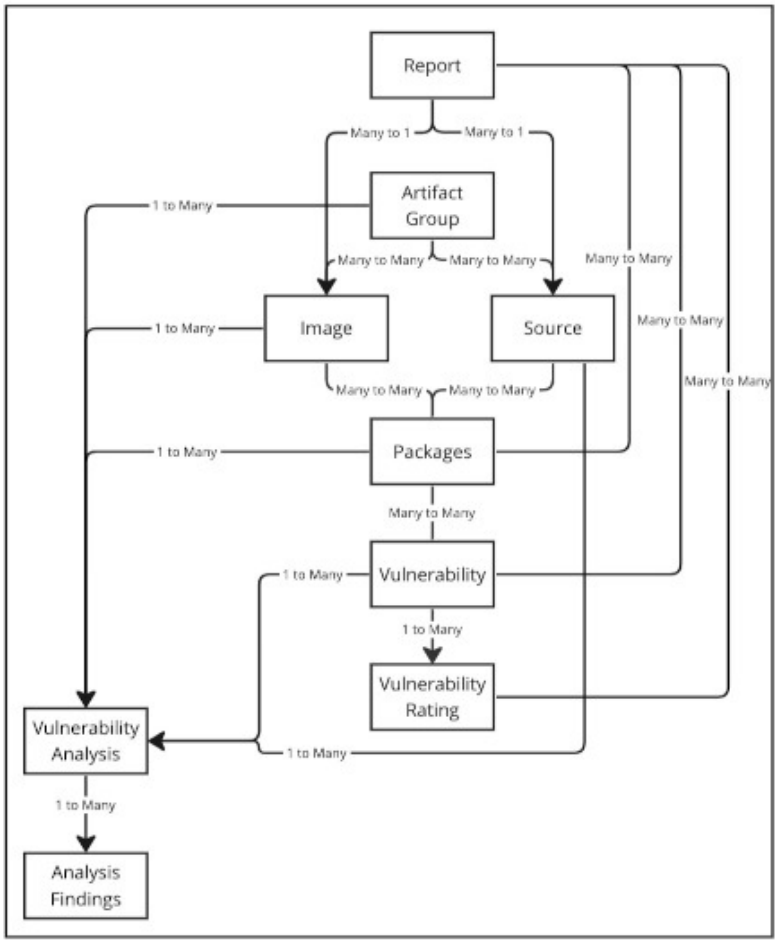

Software Bill of Material per build

Originally, the SCST - Store aggregated the data of all vulnerability scans submitted to it. This allowed users to see information from all scan results against an image or source. However, users couldn't retrieve information against an image or source from a specific vulnerability scan. For example, a user can't know from which vulnerability scan a specific CVE might have surfaced from. This is why VMware introduced Software Bill of Material per build for SCST - Store.

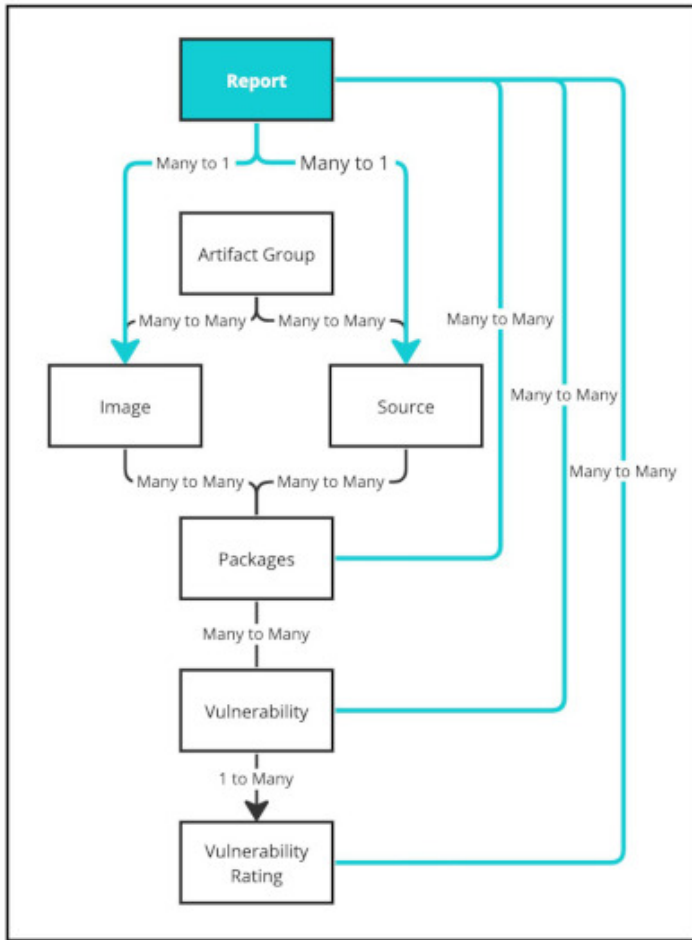

Items in blue are the new information saved with each vulnerability scan.

With each vulnerability scan submitted, the SCST - Store creates an internal report, which keeps track of the following from the vulnerability scan:

- The specific image or source
- Which packages were listed
- Which vulnerabilities were listed
- Which ratings were listed

Users can then search for all reports against an image or source with [query for a list of reports](#).

After a report is located, a query for a specific report retrieves the information for that report. See [Paths](#).

Vulnerability triage

The new Triage feature of Tanzu Application Platform allows you to store vulnerability analysis information alongside the current data handled by SCST - Store. Using the Tanzu Insight CLI, users can now perform basic triaging functions against any detected vulnerabilities. The main objective is to reduce spreadsheet and tool toil by centralizing CVE scanning, identification, and triaging in one place.

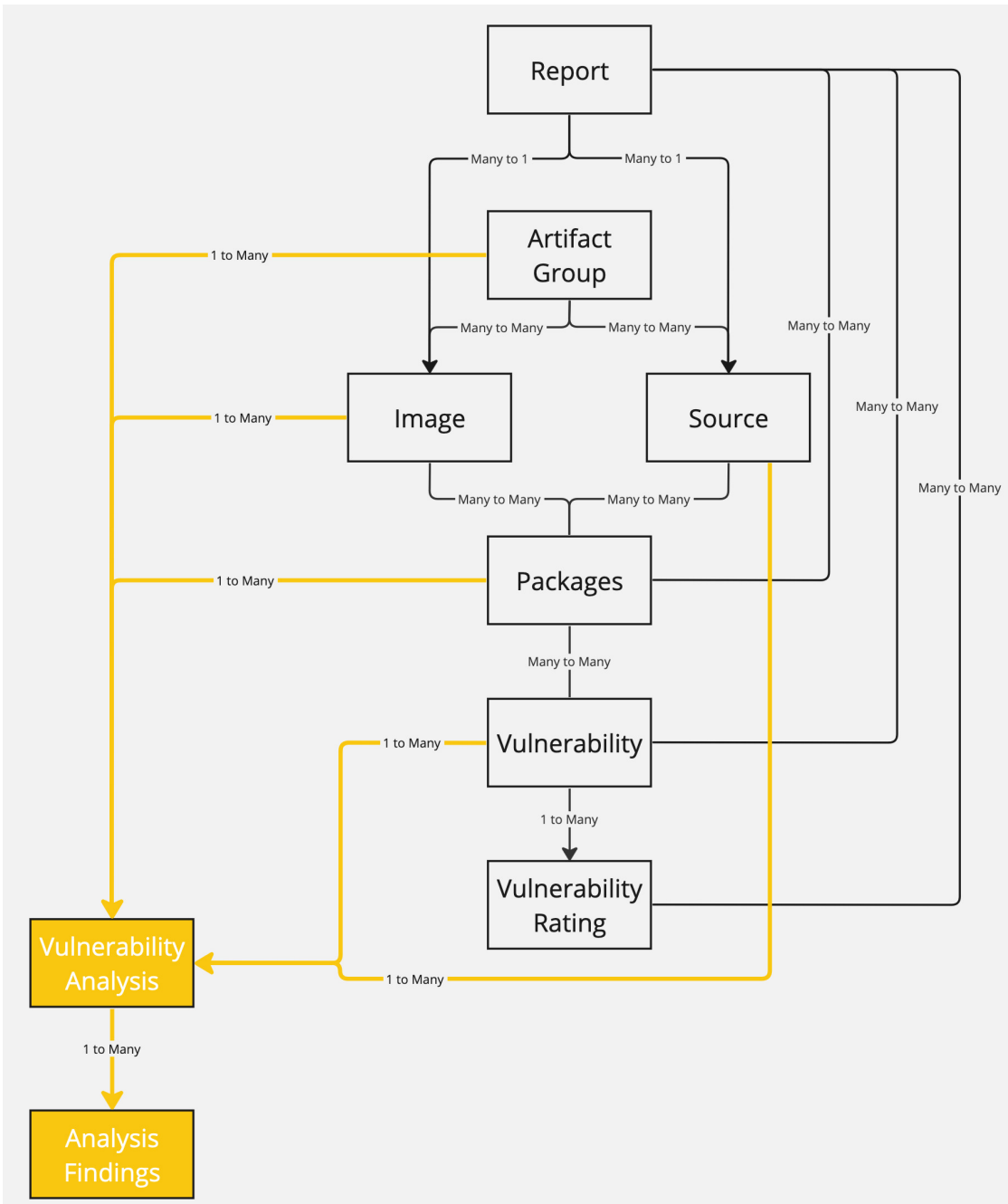

Highlighted items are the new information saved for vulnerability analysis. You can create, view, and update vulnerability analysis using the [Tanzu CLI Insight plug-in](#).

See [API resource](#).

Configure your target endpoint and certificate for Supply Chain Security Tools - Store

This topic describes how you can configure your target endpoint and certificate for Supply Chain Security Tools (SCST) - Store.

Overview

The connection to Supply Chain Security Tools - Store requires TLS encryption, and the configuration depends on the kind of installation.

For a production environment, VMware recommends that SCST - Store is installed with ingress enabled. The following instructions help set up the TLS connection, assuming that you deployed with ingress enabled.

Using Ingress

When using an [Ingress setup](#), SCST - Store creates a specific TLS Certificate for HTTPS communications under the `metadata-store` namespace.

Set the endpoint host to:

```
metadata-store.INGRESS-DOMAIN
```

Where `INGRESS-DOMAIN` is the value of the `ingress_domain` property in your deployment YAML

Example:

```
metadata-store.example.domain.com
```



Note

In a multicluster setup, a DNS record is required for the domain. The following instructions for single cluster setup do not apply, skip to the [Set the target](#) section.

Single-cluster setup

In a single-cluster setup, a DNS record is still recommended. However, if no accessible DNS record exists for the domain, edit the `/etc/hosts` file to add a local record:

```
ENVOY_IP=$(kubectl get svc envoy -n tanzu-system-ingress -o jsonpath="{.status.loadBalancer.ingress[0].ip}")

# Replace with your domain
METADATA_STORE_DOMAIN="metadata-store.example.domain.com"

# Delete any previously added entry
sudo sed -i '' "/$METADATA_STORE_DOMAIN/d" /etc/hosts

echo "$ENVOY_IP $METADATA_STORE_DOMAIN" | sudo tee -a /etc/hosts > /dev/null
```

Set the target

To get the certificate, run:

```
kubectl get secret tap-ingress-selfsigned-root-ca -n cert-manager -o json | jq -r '.data."ca.crt"' | base64 -d > insight-ca.crt
```

Set the target by running:

```
tanzu insight config set-target https://$METADATA_STORE_DOMAIN --ca-cert insight-ca.crt
```



Important

The `tanzu insight config set-target` does not initiate a test connection. Use `tanzu insight health` to test connecting using the configured endpoint and CA certificate. Neither commands test whether the access token is correct. For that you must use the plug-in to [add data](#) and [query data](#).

Next Step

- [Configure access token](#)

Additional Resources

For information about deploying SCST - Store **without** Ingress, see:

- [Using LoadBalancer](#)
- [Using NodePort](#)

Configure your access tokens for Supply Chain Security Tools - Store

This topic tells you how to configure your access tokens for Supply Chain Security Tools (SCST) - Store.

The access token is a `Bearer` token used in the HTTP request header `Authorization`. For example, `Authorization: Bearer eyJhbGciOiJSUzI1NiIsImtpZCI6IjhmV0...`

Service accounts are required to have associated access tokens. Before Kubernetes 1.24, service accounts generated access tokens automatically. As of Kubernetes 1.24, a secret must be applied manually.

By default, SCST - Store includes a `read-write` service account installed with an access token generated. This service account is cluster-wide. If you want to create your own service accounts, see [Retrieve and create service accounts for SCST - Store](#).

Setting the Access Token

When using the `insight` plug-in, you must set the `METADATA_STORE_ACCESS_TOKEN` environment variable, or use the `--access-token` flag. VMware discourages using the `--access-token` flag as the token appears in your shell history.

The following command retrieves the access token from the default `metadata-store-read-write-client` service account and stores it in `METADATA_STORE_ACCESS_TOKEN`:

```
export METADATA_STORE_ACCESS_TOKEN=$(kubectl get secrets metadata-store-read-write-client -n metadata-store -o jsonpath="{.data.token}" | base64 -d)
```

Additional Resources

- [Retrieve access tokens](#)
- [Create service accounts](#)
- [Create a service account with a custom cluster role](#)

Security details for Supply Chain Security Tools - Store

This topic describes the security details for Supply Chain Security Tools (SCST) - Store.

Application security

TLS encryption

Supply Chain Security Tools - Store requires TLS connection. If certificates are not provided, the application does not start. It supports TLS v1.2 and TLS v1.3. It does not support TLS 1.0, so a downgrade attack cannot happen. TLS 1.0 is prohibited under Payment Card Industry Data Security Standard (PCI DSS).

Cryptographic algorithms

Elliptic Curve:

```
CurveP521
CurveP384
CurveP256
```

Cipher Suites:

```
TLS_AES_128_GCM_SHA256
TLS_AES_256_GCM_SHA384
TLS_ECDHE_ECDSA_WITH_AES_128_GCM_SHA256
TLS_ECDHE_ECDSA_WITH_AES_256_GCM_SHA384
TLS_ECDHE_RSA_WITH_AES_128_GCM_SHA256
TLS_ECDHE_RSA_WITH_AES_256_GCM_SHA384
```

Access controls

SCST - Store uses [kube-rbac-proxy](#) as the only entry point to its API. Authentication and Authorization must be completed by using the [kube-rbac-proxy](#) before its API is accessible.

Authentication

The [kube-rbac-proxy](#) uses [Token Review](#) to verify that the token is valid. [Token Review](#) is a Kubernetes API to ensure that a trusted vendor issued the access token provided by the user. To issue an access token using Kubernetes, the user can create a Kubernetes Service Account and retrieve the corresponding generated secret for the access token.

To create a service account and use its access token, see the [Create Service Account Docs](#).

Authorization

The [kube-rbac-proxy](#) uses [Subject Access Review](#) to ensure that users access certain operations. [Subject Access Review](#) is a Kubernetes API that uses [Kubernetes RBAC](#) to verify that the user can perform specific actions. See [Create Service Account Doc](#).

There are two supported roles:

- [Read Only](#) cluster role
- [Read and Write](#) cluster role

These cluster roles are deployed by default. Additionally, a service account is created and bound to the [Read and Write](#) cluster role by default. If you do not want this service account, set the [add_default_rw_service_account](#) property to `false` in the `metadata-store-values.yaml` file during deployment. See [Install SCST - Store](#).

There is no default service account bound to the `Read Only` cluster role. You must create your service account and cluster role binding to bind to the `Read Only` role.



Important

There is no support for roles with access to only specific types of resources. For example, images, packages, and vulnerabilities.

Container security

Non-root user

All containers shipped do not use root user accounts or accounts with root access. Using Kubernetes Security Context ensures that applications do not run with root users.

Security Context for the API server:

```
allowPrivilegeEscalation: false
runAsUser: 65532
fsGroup: 65532
```

Security Context for the PostgreSQL database pod:

```
allowPrivilegeEscalation: false
runAsUser: 999
fsGroup: 999
```



Note

`65532` is the UUID for the nobody user. `999` is the UUID for the PostgreSQL user.

Security scanning

There are two types of security scans that are performed before every release.

Static Application Security Testing (SAST)

A Coverity Scan is run on the source code of the API server, CLI, and all their dependencies. There are no high or critical items outstanding at the time of release.

Software Composition Analysis (SCA)

A Black Duck scan is run on the compiled binary to check for vulnerabilities and license data. There are no high or critical items outstanding at the time of release.

A Gype scan is run against the source code and the compiled container for dependencies vulnerabilities. There are no high or critical items outstanding at the time of release.

Artifact Metadata Repository (alpha/beta)

This topic gives you an overview of Artifact Metadata Repository (AMR).



Important

SCST - Artifact Metadata Repository (AMR) has components with alpha and beta statuses, meaning that it is still in active development and is subject to change at any point. Users might encounter unexpected behavior. This is an opt-in component to gather early feedback from alpha and beta testers and is not installed by default with any profile.

AMR Observer (alpha)

AMR Observer is a set of managed controllers that watches for relevant updates on resources of interest. When relevant events are observed, a CloudEvent is generated and sent to AMR CloudEvent-Handler to be relayed for storage in the Metadata Store. For information about CloudEvents, see [CloudEvent JSON Specification](#).

AMR CloudEvent Handler (beta)

AMR CloudEvent Handler receives CloudEvents from other sources, such as the AMR Observer, and stores relevant information into the Artifact Metadata Repository or Metadata Store.

Known Issues

The following known issues are associated with SCST - AMR:

- Periodic reconciliation or restarting of the AMR Observer causes reattempted posting of ImageVulnerabilityScan results. There is an error on duplicate submission of identical ImageVulnerabilityScans that you can ignore if the previous submission was successful.
- ReplicaSet status in Artifact Metadata Repository has two states: `created` and `deleted`. There is a known issue where the `available` and `unavailable` states are not showing. The workaround is that you can interpolate information from the `instances` metadata in the AMR for the ReplicaSet.

Additional Resources

- [AMR Configuration](#)
- [AMR Data Models](#)
- [AMR GraphQL Query](#)

Artifact Metadata Repository (alpha/beta)

This topic gives you an overview of Artifact Metadata Repository (AMR).



Important

SCST - Artifact Metadata Repository (AMR) has components with alpha and beta statuses, meaning that it is still in active development and is subject to change at any point. Users might encounter unexpected behavior. This is an opt-in component to gather early feedback from alpha and beta testers and is not installed by default with any profile.

AMR Observer (alpha)

AMR Observer is a set of managed controllers that watches for relevant updates on resources of interest. When relevant events are observed, a CloudEvent is generated and sent to AMR CloudEvent-Handler to be relayed for storage in the Metadata Store. For information about CloudEvents, see [CloudEvent JSON Specification](#).

AMR CloudEvent Handler (beta)

AMR CloudEvent Handler receives CloudEvents from other sources, such as the AMR Observer, and stores relevant information into the Artifact Metadata Repository or Metadata Store.

Known Issues

The following known issues are associated with SCST - AMR:

- Periodic reconciliation or restarting of the AMR Observer causes reattempted posting of ImageVulnerabilityScan results. There is an error on duplicate submission of identical ImageVulnerabilityScans that you can ignore if the previous submission was successful.
- ReplicaSet status in Artifact Metadata Repository has two states: `created` and `deleted`. There is a known issue where the `available` and `unavailable` states are not showing. The workaround is that you can interpolate information from the `instances` metadata in the AMR for the ReplicaSet.

Additional Resources

- [AMR Configuration](#)
- [AMR Data Models](#)
- [AMR GraphQL Query](#)

Artifact Metadata Repository architecture

This topic gives you an overview of the Artifact Metadata Repository (AMR) architecture.



Important

Artifact Metadata Repository (AMR) has components with alpha and beta statuses, meaning that it is still in active development and is subject to change at any point. Users might encounter unexpected behavior. This is an opt-in component to gather early feedback from alpha and beta testers and is not installed by default with any profile.

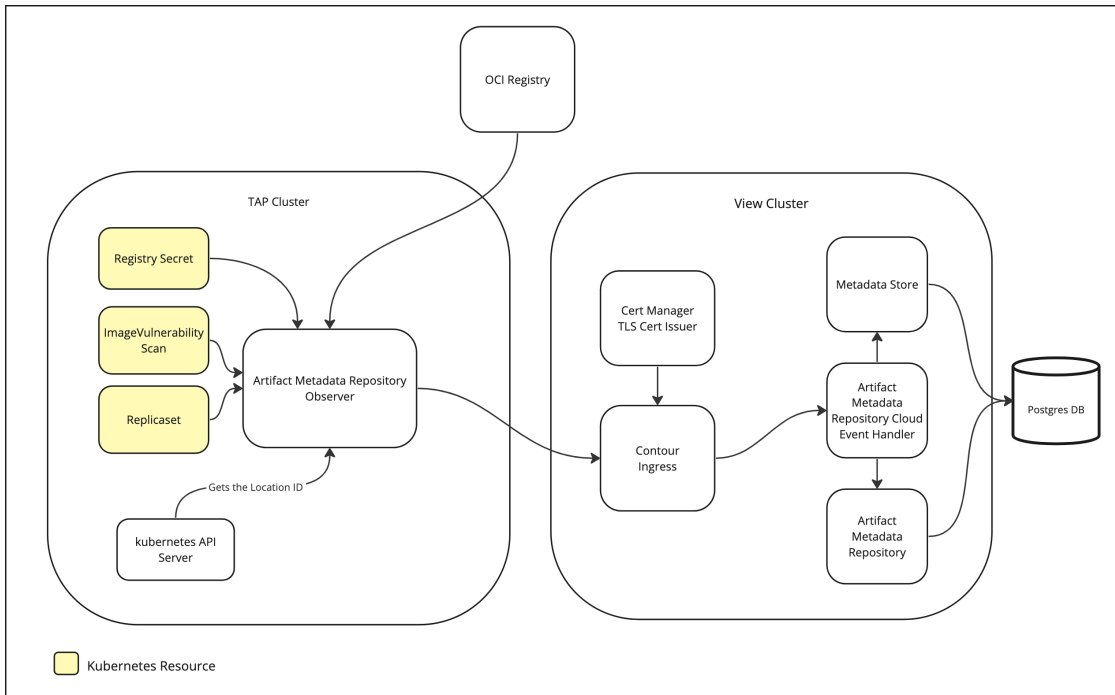

AMR Observer

The AMR Observer is deployed to the build and run clusters when it is **enabled**. It starts by communicating with the Kubernetes API Server to obtain the cluster's location ID, which is the GUID of the `kube-system` namespace. After you retrieve the location ID, the AMR Observer emits a cloud event, including any operator-defined metadata, to the Artifact Metadata Repository Cloud Event Handler (AMR Cloud Event Handler). This cloud event registers the location, and subsequent cloud events in the same cluster use the same location ID in the source field. This mechanism helps the AMR keep track of artifacts and their associated location.

Watched resources

The AMR Observer consists of managed controllers that watch resources. In Tanzu Application Platform 1.6, AMR Observer watches for `ImageVulnerabilityScans` and workload `ReplicaSets`. Workload `ReplicaSets` are `ReplicaSets` that contain one container named `workload` that the out of the box Supply Chain produces.

ImageVulnerabilityScans

The AMR Observer watches the `ImageVulnerabilityScan` Custom Resources for completed scans. When a scan is completed, the AMR Observer uses the `registry secret` and the location information from the `ImageVulnerabilityScan` Custom Resources to fetch the SBOM report. After obtaining the SBOM report, it wraps it in a cloud event and emits it to the AMR Cloud Event Handler. The AMR Cloud Event Handler persists this event in the Metadata Store.

ReplicaSet

The AMR Observer watches the runtime data of `ReplicaSet` Apps. It reads the status of the `ReplicaSet`, including number of instances, created, updated, deleted, and emits a cloud event to the AMR Cloud Event Handler. The AMR Cloud Event Handler ensures the event is stored in the Artifact Metadata Repository.

Configure Artifact Metadata Repository

This tells you how to configure Artifact Metadata Repository (AMR).

AMR Observer

You can obtain the Tanzu Application Platform values schema with the following command:

```
tanzu package available get amr-observer.apps.tanzu.vmware.com/0.1.0-alpha.8 --values-
schema --namespace tap-install
```

Values are under the `amr` root key, not under the `metadata_store` root key.



Note

If AMR Observer is deployed `standalone` and not through Tanzu Application Platform package, the values file for a standalone package installation does not have the Tanzu Application Platform value root keys of `amr.observer` or `amr.deploy_observer`.

A template of the AMR Observer Tanzu Application Platform values:

```
amr:
  deploy_observer: true
  observer:
    location: |
      alias: CLUSTER_ALIAS # Optional
      labels:
      - key: environment
        value: prod
    resync_period: "5h"
    eventhandler:
      endpoint: "https://amr-persister.<DOMAIN>"
      liveness_period_seconds: 25
    ca_cert_data: |
      -----BEGIN CERTIFICATE-----
      Custom CA certificate for AMR CloudEvent Handler's HTTPProxy with custom TLS cer
      ts
      -----END CERTIFICATE-----
```

Configuration options:

- `amr.deploy_observer`
 - Default: `false`
 - If deployed on a full profile Tanzu Application Platform cluster and `metadata_store.amr.deploy` is `false`, this overrides `amr.deploy_observer` to be `false`.
- `amr.observer.location`
 - Default: `""`
 - Location is the multiline string configuration for the `location.conf` content.
 - The YAML string can contain additional fields:
 - `alias`: An alias for the cluster's location. If no alias is specified, the reference of the `kube-system` namespace UID is used.
 - `labels`: Consists of an array for key and value pairing. Useful for adding searchable and identifiable metadata.
- `amr.observer.resync_period`

- Default: “10h”
- Determines the minimum frequency at which watched resources are reconciled. A lower period corrects entropy more quickly, but reduce responsiveness to change if there are many watched resources. Change this value only if you know what you are doing.
- `amr.observer.ca_cert_data` OR `shared.ca_cert_data`
 - Default: ""
 - The AMR Observer uses the truststore to add certificates. You can get the CA Certificate on the cluster running AMR CloudEvent Handler:

```
kubectl -n metadata-store get secrets/amr-persister-ingress-cert -o jsonpath='{.data."cert.ca"}' | base64 -d
```

- `amr.observer.eventhandler.endpoint`
 - Default: ""
 - The URL of the CloudEvent handler endpoint.
 - On the view or full Tanzu Application Platform profile cluster, obtain the AMR CloudEvent Handler ingress address. Obtain the FQDN of the AMR CloudEvent Handler:

```
kubectl -n metadata-store get httpproxies.projectcontour.io amr-persister-ingress -o jsonpath='{.spec.virtualhost.fqdn}'
```



Note

Ensure that the correct protocol is set. If there is TLS, `https://` must be prepended. If there is no TLS, `http://` must be prepended.

- `amr.observer.eventhandler.liveness_period_seconds`
 - Default: 25
 - The period in seconds between executed health checks to the Artifact Metadata Repository CloudEvent Handler endpoint.

Artifact Metadata Repository (AMR) data model and concepts

This topic tells you about data models used in the Artifact Metadata Repository (AMR).

Overview

The following diagram shows the data models used in the AMR to store artifact information and the relationship between them.

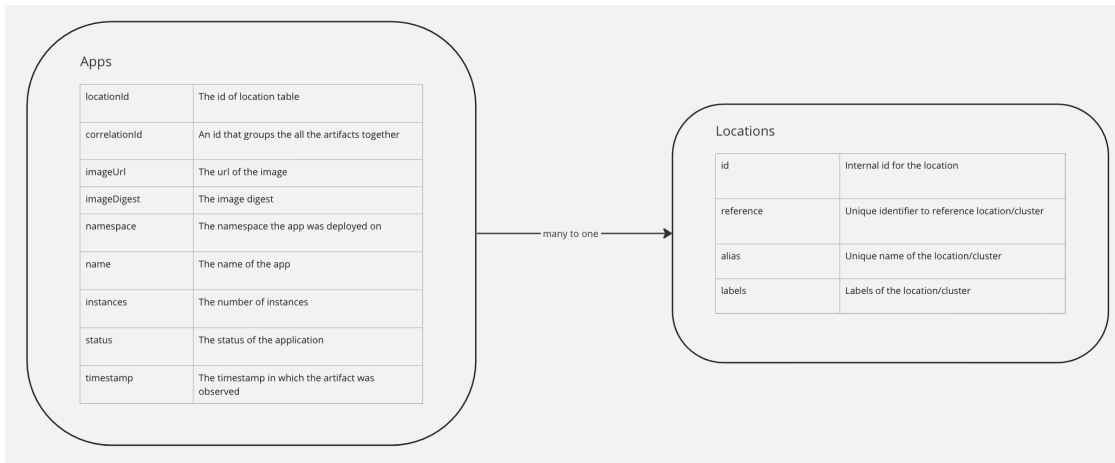

AMR data models

There are two types of data models in the AMR:

- [Apps](#)
- [Locations](#)

Apps

The [Apps](#) data model represents the information of an application, such as replicaset, at a point in time. Cloud events sends this information to the AMR, so each entry represents the status of the app when an event occurred. See [cloud events](#). These entries correspond to events, such as when an app is created, scaled up, running, scaled down or deleted. This lets users see the history of their apps.

Each [Apps](#) data entry stores information about the associated location it was deployed in, details about the status, and what is deployed. See the diagram above for a list of all fields the data model stores. You can only associate an [Apps](#) entry with one [Locations](#) entry. You can point multiple [Apps](#) entries to the same [Locations](#) entry. All [Apps](#) entries within a location are guaranteed to be unique, meaning that no two [Apps](#) entries in the same location can have identical values for all their fields.

Locations

The [Locations](#) data model stores data about the locations that [Apps](#) are deployed on, like clusters.

- **reference**: unique reference to the location. It is automatically set to be the `kube-system` namespace UID by the AMR. This is not configurable by the user.
- **alias**: unique alias for the location. By default, it is initialized with the value of the **reference**, but users have the option to configure it to a different value. See [AMR Configuration](#).
- **labels**: labels of the location. Users can add them by using tap values YAML file. See [AMR Configuration](#).

AMR GraphQL Querying

This topic tells you how to connect to the GraphQL playground and how to query each supported data model. For information about the AMR data models, see [AMR Data Models](#).

Connecting to GraphQL playground

VMware recommends enabling ingress. The Supply Chain Security Tools for Tanzu – Store and Artifact Metadata Repository (AMR) packages share the same ingress configuration. Setting `ingress_domain` for the SCST - Store applies the same value for AMR. To connect to the AMR GraphQL playground when ingress is enabled, go to <https://artifact-metadata-repository.<ingress-domain>/play>. You can use this to write and execute your own GraphQL queries to fetch data from the AMR.

Querying for locations

This section tells you about GraphQL query arguments, and the list of fields available for `Location`.

Locations query arguments

You can specify the following supported arguments when querying for `Location`. They are all optional.

- `query`: expects an object that specifies additional arguments used to query. The following arguments are supported in this query object:
 - `alias`: human-readable identifier of the location, as a `String` value. By default, a location's `alias` is set to be the same as the `reference`. It is configurable by the user, see [AMR Configuration](#).

For example:

```
locations(query:{alias: "test-cluster"})
```

- `reference`: string UID representing the location, as a `String` value. A location's `reference` is automatically set to be the `kube-system` namespace UID by the AMR. It is not configurable by the user.

For example:

```
locations(query:{reference: "f4f63c6a10ed7cfb06dfb03c2b2d6a9d5bbe95931c71f8cb346fd2284b1e5d82"})
```

- `labels`: specify labels the location must contain. Expects a list of labels. A label has `key` and `value` fields of `String` type, at least one of those fields must be provided when querying with labels.



Note

The result returns locations that have `all` given labels (i.e. this is an `AND` operation).

For example:

```
locations(query:{ labels:[{value: "run"},
                           {key: "env"},
                           {key: "region", value: "east1b"} ]
})
```

Locations fields

Users can choose the following fields to return in the GraphQL query. At least one field must be specified.

- `alias`: human-readable identifier of the location

- `reference`: string UID representing the location
- `labels`: labels associated with the location, has the following fields
 - `key`: key of the label
 - `value`: value of the label

Sample locations queries

- Query for location with the `alias "test-cluster"`. The query results return information about the `reference`, `alias`, and `labels` showing both `key` and `value`.

```
query getLocationByAlias {
  locations(query:{alias: "test-cluster"}) {
    reference
    alias
    labels {
      key
      value
    }
  }
}
```

- Query for locations that contain two `labels`, one with `key "env"` and one `{key: "region", value: "east1b"}`. The query results return information about `alias` and `reference` only.

```
query getLocationByLabel {
  locations(query:{labels:[{key: "env"},
                           {key: "region", value: "east1b"} ]
  }) {
    reference
    alias
  }
}
```

Querying for apps

This section provides details about the GraphQL query arguments, and the list of fields available for `Apps`.

Apps query arguments

You can specify the following supported arguments when querying for `Apps`. They are all optional.

- `latest`: When set to true, it returns the latest result from the given query. When set to false, it returns all results from the given query. By default, it is false when not specified. This field is a `Boolean` value.

For example:

```
apps(latest: true)
```

- `query`: expects an object that specifies additional arguments used to query. The following arguments are supported in this query object:
 - `name`: the name of the app. `String` value.

For example:

```
apps(query: {name: "my-app"})
```

- `namespace`: the namespace where the app is deployed. `String` value.

For example:

```
apps(query: {namespace: "dev-namespace"})
```

- `location`: the location where the app is deployed. Expects a location query object. See [Location Query Arguments](#).



Note

`alias` is the only supported field for `location` when querying for `apps`. The other location fields are available in the schema but have no effect.

For example:

```
apps(query: {location: {alias: "test-cluster"}})
```

- `order`: order results by a specified `field` in a `direction`. Expects a key-value list to specify the `field` and `direction`.



Note

The only supported `field` is `timestamp`, with directions `ASC` or `DESC`.

For example:

```
apps(query: {order: {
  field: timestamp,
  direction: DESC
}})
```

- `timestamp`: return results only in the given time range. Expects a key-value list with the `before` and `after` timestamps that define the time range.



Note

Timestamps must be in ISO_8601 format

For example:

```
apps(query: {timestamp: {
  before: "2022-11-29T16:21:35-05:00",
  after: "2022-11-27T16:21:35-05:00"
}})
```

Apps fields

Users can choose to return the following fields in the GraphQL query. You must specify at least one field.

- `name`: name of the app
- `namespace`: namespace the app is deployed in

- `imageUrl`: image URL of the app
- `imageDigest`: image digest of the app
- `status`: status of the app, such as `Created`, `Available`, `Deleted`.
- `instances`: number of instances of the app. For example, the number of pods deployed.
- `timestamp`: timestamp of when the event occurred to the app, in ISO_8601 format
- `location`: location of the app, see [Location Fields](#) for details about attributes to specify here.

Sample apps queries

- Query for the `latest` information for all apps. The query results return information about `name`, `namespace`, `imageUrl`, `imageDigest`, `instances`, `status`, and `timestamp` for each app.

```
query getLatestAppStatus {
  apps(latest: true) {
    name
    namespace
    imageUrl
    imageDigest
    instances
    status
    timestamp
  }
}
```

- Query for the `latest` information for app with the `name` "my-app" in namespace "dev-ns". The query results return information about `imageUrl`, `imageDigest`, `instances`, `status`, and `timestamp`. Also return information of the `location` of the app, including the `alias` and `key value` of the `labels`.

```
query getLatestAppStatus {
  apps(latest: true, query: { name: "some-app-1",
                             namespace: "dev-ns"
  }) {
    location {
      alias
      labels {
        key
        value
      }
    }
    imageUrl
    imageDigest
    instances
    status
    timestamp
  }
}
```

- Query for app history the app named "my-app" in the `location` with `alias` "test-cluster", order causes `descending` order. The query results return information about `name`, `namespace`, `imageUrl`, `imageDigest`, `instances`, and `status`.

```
query getHistoryOfApp {
  apps(query: { name: "my-app",
                location: {alias: "test-cluster"},
                order: {
                  field: timestamp,
                  direction: DESC
                }
  }) {
    name
    namespace
    imageUrl
    imageDigest
    instances
    status
    timestamp
  }
}
```

```

    }
  }) {
    name
    namespace
    imageUrl
    imageDigest
    instances
    status
  }
}

```

- Query for information about the app named "my-app" in the location with alias "test-cluster", in a specific time range. The query results return information about name, namespace, imageUrl, imageDigest, instances, and status. Also return information of the location of the app, including the alias and key value of the labels.

```

query getAppWithTimerange {
  apps(query: { name: "my-app",
    location: {alias: "test-cluster"},
    timestamp: {
      before: "2023-06-15T06:47:25Z",
      after: "2023-05-12T18:30:17Z"
    }
  }) {
    location {
      alias
      labels {
        key
        value
      }
    }
    name
    namespace
    imageUrl
    imageDigest
    instances
    status
  }
}

```

Additional resources

- [AMR Data Models](#)

CloudEvent JSON specification for Supply Chain Security Tools - Artifact Metadata Repository

This topic tells you how Artifact Metadata Repository (AMR) Observer uses CloudEvents to describe events and send them to AMR CloudEvent Handler.

JSON specification

You can use the following CloudEvent JSON specification for an ImageVulnerabilityScan:

```

{
  "specversion": "1.0",
  "id": "4461832-scan.cdx.xml", // ResourceVersion-ScanFilename
  "source": "d9falee9-ba42-4262-aaf6-4128f99096b9", // Kube-system namespace UID
  "type": "vmware.tanzu.apps.image.sbom.pushed.v1", // CloudEvent Type
  "subject": "/apis/app-scanning.apps.tanzu.vmware.com/v1alpha1/namespaces/my-apps/im

```

```

agevulnerabilityscans/grypescan-m92q8",
  "datacontenttype": "application/vnd.cyclonedx+xml",
  "time": "2023-02-07T19:50:31.436247579Z",
  "data": "<REPORT_DATA_HERE>", // scan.cdx.xml content
  "name": "grypescan-m92q8",
  "namespace": "my-apps",
  "correlationid": "github.com/sample-accelerators/tanzu-java-web-app",
  "image": "nginx@sha256:aa0afebbb3cfa473099a62c4b32e9b3fb73ed23f2a75a65ce1d4b4f55a5c
2ef2", // scanned image
  "scanresults": "example.registry.com/scan-results@sha256:a9ad6728e08c0bdd8ad7524c12
9bd85137066332ba8ae0bb78750a07299d820b",
  "file": "scan.cdx.xml", // filename within scanresults bundle
  "workloaduid": "4da69791-b041-4ae6-95de-1e6b3d1fa0d6",
  "workloadname": "tanzu-java-web-app",
  "workloadnamespace": "my-apps",
}

```

Required CloudEvent attributes

CloudEvents have the following required attributes. See [required attributes](#) in GitHub.

- `id`
 - The combination of `source` and `id` must be unique for each distinct CloudEvent. You can use the resourceVersion and scanResult filename as an identifier.
- `source`
 - Use UID of kube-system namespace resource where the Observer is deployed.
- `specversion`
 - Must use a value of 1.0 when referring to this version of the specification.
- `type`
 - Must be defined. AMR Observer and CloudEvent Handler supports the use of:
 - `vmware.tanzu.apps.image.sbom.pushed.v1`
 - Contains the ImageVulnerabilityScan report
 - Submits image scan reports to Metadata Store
 - `vmware.tanzu.apps.image.sbom.pushed.v1alpha1`
 - Contains the ImageVulnerabilityScan report
 - Submits image scan reports to Metadata Store
 - Submits artifact groups containing workload correlation to image scan reports to Metadata Store
 - `vmware.tanzu.apps.location.created.v1`
 - Contains cluster kube-system namespace UID and user defined labels for location
 - Submits cluster location to Artifact Metadata Repository
 - `dev.knative.apiserver.resource.add`
 - Backwards compatibility with Knative APIServerSource in Resource mode
 - AMR CloudEvent Handler supports ReplicaSets with workload named container
 - Submits ReplicaSet status to Artifact Metadata Repository
 - `dev.knative.apiserver.resource.updated`
 - Backwards compatibility with Knative APIServerSource in Resource mode

- AMR CloudEvent Handler supports ReplicaSets with workload named container
- Submits ReplicaSet status to Artifact Metadata Repository
- `dev.knative.apiserver.resource.delete`
 - Backwards compatibility with Knative APIServerSource in Resource mode
 - AMR CloudEvent Handler supports ReplicaSets with workload named container
 - Submits ReplicaSet status to Artifact Metadata Repository

Optional CloudEvent attributes

You can define the following CloudEvents optional attributes. See [optional attributes](#) in GitHub.

- `subject`
 - `/apis/<group>/<version>/namespace/<namespace-name>/<kind>/<name>`
- `datacontenttype`
 - Contains the metadata for the type of data in the data field. You can specify which XML data the scan results are with `application/vnd.cyclonedx+xml` or `application/spdx+json` so the AMR CloudEvent-Handler knows which unmarshaller to use.
- `data`
 - Contains the scan result file content
- `time`
 - Timestamp from the observed resource

CloudEvent extension attributes

Fields that are not part of the required and optional attributes for CloudEvents are considered extension context attributes. See [extension context attributes](#) in GitHub.

- (Optional) `correlationid`
 - Contains the metadata of the mapping to the source of the resource being scanned.
- `image`
 - Required for `vmware.tanzu.apps.image.sbom.pushed.*` types
 - Contains the scanned image and digest
- `scanresults`
 - Required for `vmware.tanzu.apps.image.sbom.pushed.*` types
 - Contains the ScanResult OCI location so that AMR can reference where the original scan results are located when results are normalized.
- `file`
 - Required for `vmware.tanzu.apps.image.sbom.pushed.*` types
 - Scan result filename
- (Optional) `workloaduid`
 - Contains the workload UID. Utilized for associating artifact-groups in Metadata Store
- (Optional) `workloadname`
 - Contains the workload name. Utilized for associating artifact-groups in Metadata Store

- (Optional) `workloadnamespace`
 - Contains the workload namespace. Utilized for associating artifact-groups in Metadata Store

Batch CloudEvents

If you use JSON batch format, you can send multiple CloudEvents to the AMR CloudEvent-Handler in a batch. For more information, see the [CloudEvents documentation](#) in GitHub.

Artifact Metadata Repository CloudEvent Handler

Switching Context

If Artifact Metadata Repository CloudEvent Handler is installed on a separate cluster, such as with a view profile cluster, it is important that the correct cluster is targeted when updating the installation. Ensure that the correct cluster is targetted before updating package values.

1. Switch the context to the View profile cluster by running:

```
kubectl config use-context VIEW-CLUSTER-NAME
```

2. Update `tap-values.yaml` in an editor according to the desired configuration.
3. Update the installed Tanzu Application Platform package on the cluster by running:

Install

On the view profile cluster or full profile cluster, the Metadata Store installation must be updated to have Artifact Metadata Repository deployed. When the Artifact Metadata Repository is deployed, Artifact Metadata Repository CloudEvent Handler is deployed alongside it.

To do so, additional Tanzu Application Platform values are required:

```
metadata_store:
  amr:
    deploy: true
```

Uninstall

Artifact Metadata Repository CloudEvent Handler is deployed alongside Artifact Metadata Repository. Therefore, to undeploy Artifact Metadata Repository CloudEvent Handler, the Tanzu Application Platform values are updated with:

```
metadata_store:
  amr:
    deploy: false
```



Note

When Artifact Metadata Repository Observer is deployed on the same cluster with the full Tanzu Application Platform profile, Artifact Metadata Repository Observer is undeployed when Artifact Metadata Repository is undeployed.

Artifact Metadata Repository Observer for Supply Chain Security Tools - Store

This topic tells you how to install Artifact Metadata Repository (AMR) Observer for Supply Chain Security Tools (SCST) - Store.



Note

AMR Observer does not support connecting to registries with self-signed certificates. This means that AMR Observer is not able to retrieve scan results if they are stored on such registries.

Prerequisites

You must deploy AMR and AMR CloudEvent Handler if you are using the Full profile. To do so, additional Tanzu Application Platform values are required.

```
metadata_store:
  amr:
    deploy: true
```

Alternatively, AMR and AMR CloudEvent Handler must be deployed and accessible by the cluster where AMR Observer is deployed.

Switching Context

If Artifact Metadata Repository Observer is installed on a separate cluster from AMR CloudEvent Handler, you must ensure that the correct cluster is targeted before updating package values.

```
# 1. Switch context to cluster with AMR Observer
kubectl config use-context OBSERVER-CLUSTER-NAME

# 2. Update the tap-values.yaml in an editor according to the desired configuration

# 3. Update the installed TAP package on the cluster
tanzu package installed update tap --values-file tap-values.yaml -n tap-install
```

Where `OBSERVER-CLUSTER-NAME` is the name of the cluster you want to use.

Install

To deploy AMR Observer on a Full, Build, or Run Tanzu Application Platform profile, update the Tanzu Application Platform values:

```
amr:
  deploy_observer: true
```



Note

If deployed on a full profile Tanzu Application Platform cluster and `metadata_store.amr.deploy` is `false`, this overrides `amr.deploy_observer` to `false`.

When AMR Observer is installed on a different cluster from AMR and AMR CloudEvent Handler, the following values are required:

- `amr.observer.eventhandler.endpoint` is required for the Observer to send to the AMR CloudEvent Handler.
- `amr.observer.eventhandler.ca_cert_data` or `shared.ca_cert_data` are required for AMR CloudEvent Handlers that use Custom CA certificates to generate the associated TLS certificate for the ingress endpoint.



Note

If SCST - Scan 2.0 is installed after AMR Observer has already been deployed, a deployment you must restart AMR Observer to observe the new ImageVulnerabilityScan Custom Resource that was installed with SCST - Scan 2.0.

```
kubectl -n amr-observer-system rollout restart deployment amr-observer-controller-manager
```

The following log appears if the AMR Observer is observing the ImageVulnerabilityScan Custom Resource:

```
2023-06-28T17:56:43Z INFO Starting Controller {"controller": "imagevulnerabilityscan", "controllerGroup": "app-scanning.apps.tanzu.vmware.com", "controllerKind": "ImageVulnerabilityScan"}
```

For information about logging, see [Troubleshoot - AMR Observer Logs](#).

See [Configuration - AMR Observer](#).

Installing Artifact Metadata Repository Observer Standalone

1. To install AMR Observer standalone from a Tanzu Application Platform profile, verify the available version:

```
$ tanzu package available list amr-observer.apps.tanzu.vmware.com -n tap-install
```

NAME	VERSION	RELEASED-AT
amr-observer.apps.tanzu.vmware.com	0.1.0-alpha.8	2023-06-08 16:17:22 -0400 EDT

2. Get the values-schema to create the values file:

```
$ tanzu package available get amr-observer.apps.tanzu.vmware.com/0.1.0-alpha.8 --values-schema --namespace tap-install
```

KEY	DEFAULT	TYPE	DESCRIPTION
ca_cert_data		string	ca_cert_data is used to add certificates to the truststore that is used by the amr-observer.
eventhandler.endpoint		string	The URL of the cloudevent handler endpoint.
eventhandler.liveness_period_seconds		integer	The period in seconds between executed health checks to the cloudevent handler endpoint.
location		string	location is the multiline string configuration for the location.conf content.
resync_period		string	resync_period determines the minimum frequency at which watched resources are reconciled. A lower period will correct entropy more quickly, but reduce responsiveness to change if t

```
here are many watched resources. Change this value only if you know what you are doing. Defaults to 10 hours if unset.
```

3. A sample `values-file.yaml` for installing AMR Observer standalone on a cluster where AMR CloudEvent Handler is present.

```
eventhandler:
  endpoint: http://amr-persister.metadata-store.svc.cluster.local
```

The values file for a standalone package installation does not have the Tanzu Application Platform value root key of `amr.observer` or `amr.deploy_observer`.

For more information, see [Configuration](#).

Troubleshooting Artifact Metadata Repository (AMR)

This topic tells you how to troubleshoot issues with Artifact Metadata Repository (AMR).

Debugging AMR

1. Pause reconciliation of the package

```
tanzu package installed pause amr-observer -n tap-install
# OR
kubectl package installed pause -i amr-observer -n tap-install
```

2. Change the zap log level.

```
kubectl -n amr-observer-system \
  patch deployment amr-observer-controller-manager \
  --type='json' \
  -p='[{"op": "add",
      "path": "/spec/template/spec/containers/1/args/-",
      "value": "--zap-log-level=3"
    }]'
```

Logs now show `LEVEL(-3)` with the example patch above.

```
$ kubectl -n amr-observer-system logs deployments/amr-observer-controller-manager
2023-06-20T15:42:39Z    LEVEL(-3)    httpclient.circuitbreaker    AMR CloudEventHandler {"availability": true, "State": "closed"}
```

3. Unpause reconciliation of the package:

```
tanzu package installed kick amr-observer -n tap-install
# OR
kubectl package installed kick -i amr-observer -n tap-install
```

Health Check

AMR Observer does not send events to AMR CloudEvent Handler if either the AMRCloudEvent Handler, AMR, or MDS isn't working.

Sample log in AMR Observer when HealthCheck is working:

```
2023-06-20T15:51:50Z    INFO    httpclient.circuitbreaker    Received response with status {"status": "204 No Content"}
```

```
2023-06-20T15:51:50Z INFO httpclient.circuitbreaker Successfully sent CloudEvent
```

Sample log in AMR Observer when HealthCheck is failing:

```
2023-06-20T19:01:58Z INFO httpclient.circuitbreaker Received response with
status {"status": "503 Service Unavailable"}
2023-06-20T19:01:58Z ERROR httpclient {"error": "request failed with
status 503"}
gitlab.eng.vmware.com/tanzu-image-signing/amr-observer/internal/cloud/event/client.(*C
loudEventClient).logAndReturnError
/workspace/internal/cloud/event/client/client.go:53
gitlab.eng.vmware.com/tanzu-image-signing/amr-observer/internal/cloud/event/client.(*C
loudEventClient).do
/workspace/internal/cloud/event/client/client.go:102
gitlab.eng.vmware.com/tanzu-image-signing/amr-observer/internal/cloud/event/client.(*C
loudEventClient).checkCloudEventHandlerAvailability.func1
/workspace/internal/cloud/event/client/client.go:123
github.com/sony/gobreaker.(*CircuitBreaker).Execute
/go/pkg/mod/github.com/sony/gobreaker@v0.5.0/gobreaker.go:242
gitlab.eng.vmware.com/tanzu-image-signing/amr-observer/internal/cloud/event/client.(*C
loudEventClient).checkCloudEventHandlerAvailability
/workspace/internal/cloud/event/client/client.go:117
gitlab.eng.vmware.com/tanzu-image-signing/amr-observer/internal/cloud/event/client.(*C
loudEventClient).CheckAvailabilityPeriodically
/workspace/internal/cloud/event/client/client.go:111
```

Sample log in AMR CloudEvent Handler:

```
{"level": "error", "ts": "2023-06-20T15:15:04.321672436Z", "caller": "amr-persister/main.g
o:99", "msg": "AMR is unavailable: Get \"https://artifact-metadata-repository-app.metada
ta-store.svc.cluster.local:8443/play\": dial tcp 10.28.116.184:8443: connect: connecti
on refused", "stacktrace": "<...>"}
```

```
{"level": "error", "ts": "2023-06-20T20:13:15.689628865Z", "caller": "amr-persister/main.g
o:102", "msg": "MDS is unavailable: Get \"https://metadata-store-app.metadata-store.svc.
cluster.local:8443/api/health\": dial tcp 10.28.122.145:8443: connect: connection refu
sed", "stacktrace": "..."}

```

Unsupported protocol is used for the `amr.observer.eventhandler.endpoint`.

```
2023-06-28T18:48:31Z ERROR httpclient error sending request to AMR CloudEven
t Handler {"error": "Get \"amr-persister.example.com/healthz\": unsupported prot
ocol scheme \"\""}
...
2023-06-28T18:48:31Z ERROR setup unable to registry location {"error": "fai
led to send, Post \"amr-persister.example.com\": unsupported protocol scheme \"\""}
...
2023-06-28T18:48:31Z ERROR httpclient.circuitbreaker error contacting event
handler {"error": "Get \"amr-persister.example.com/healthz\": unsupported protocol sch
eme \"\""}

```

To fix this, use the appropriate `https://` or `http://` prepended protocol.

If the log contains:

```
2023/06/28 19:09:06 No certs appended, using system certs only
2023-06-28T19:09:06Z INFO controller-runtime.metrics Metrics server is star
```

```
ting to listen {"addr": "127.0.0.1:8080"}
2023-06-28T19:09:06Z INFO setup Establishing {"locationId": "d9fa1ee9-ba42-4262-aaf6-4128f99096b9"}
```

And if the following describe on the pod shows:

```
$ kubectl -n amr-observer-system describe pods "<amr-observer-controller-manager-...>"
```

Sample output:

```
...
Events:
  Type          Reason          Age          From          Message
  ----          -
  ...
Warning Unhealthy 3m35s (x3 over 4m15s) kubelet Liveness probe failed:
Get "http://192.168.45.78:8081/healthz": context deadline exceeded (Client.Timeout exceeded while awaiting headers)
...
Warning Unhealthy 3m5s (x10 over 4m25s) kubelet Readiness probe failed:
Get "http://192.168.45.78:8081/readyz": context deadline exceeded (Client.Timeout exceeded while awaiting headers)
```

This is a symptom of a wrong protocol for `amr.observer.eventhandler.endpoint`. The fix is to use the appropriate `https://` or `http://` prepended protocol dependent on the TLS configuration.

AMR Observer Logs

```
kubectl -n amr-observer-system logs deployments/amr-observer-controller-manager
```

The AMR Observer is not observing `ImageVulnerabilityScan` CRD.

```
2023-06-20T15:47:09Z INFO ivs.SetupWithManager Not registering ImageVulnerabilityScans Controller: customresourcedefinitions.apiextensions.k8s.io "imagevulnerabilityscans.app-scanning.apps.tanzu.vmware.com" not found"
```

The AMR Observer is observing `ImageVulnerabilityScan` CRD if it is installed.

```
2023-06-28T17:56:43Z INFO Starting Controller {"controller": "imagevulnerabilityscan", "controllerGroup": "app-scanning.apps.tanzu.vmware.com", "controllerKind": "ImageVulnerabilityScan"}
```

When Observer first starts up, it registers a Location to the Metadata Store. See [Configuration \(Insert link to observer configuration of location\)](#) for more information on customizing Locations.

```
2023-06-20T15:47:09Z INFO setup Establishing {"locationId": "f17f073d-dfec-4624-953e-a133b694ecad"}
sent: type: vmware.tanzu.apps.location.created.v1
source: f17f073d-dfec-4624-953e-a133b694ecad
id: 1667244096281455275
Extensions:
map[]
```

Information on what CA certificates were added to the Observer's HTTP client.

```
2023-06-20T15:47:05Z INFO setup No additional certs read from configured path,
continuing with system truststore" {"path": "/truststore/ca.crt"}
```

No valid CA certificates were found.

```
2023/06/28 18:41:04 No certs appended, using system certs only
```

When the ReplicaSet is observed to be deleted, it will attempt to send the result to AMR CloudEvent Handler. There is a known minor bug that even non workload replicaSets will be sent during create and delete events. The log will show an error, however, it is a no-op because AMR CloudEvent Handler will filter out ReplicaSet CloudEvents without a workload container.

```
result: 204: sent: type: dev.knative.apiserver.resource.delete
source: f17f073d-dfec-4624-953e-a133b694ecad
2023-06-20T19:01:23Z INFO replicaset.sendCloudEvent received result {"ceType": "dev.knative.apiserver.resource.delete", "result": "500: "}
id: 4565357219078868493
Extensions:
map[kind:ReplicaSet name:artifact-metadata-repository-app-7ff9bc58f namespace:metadata-store]
```

There is partial legacy support for Knative ApiServerSource CloudEvents which the Observer leverages which is why there are CloudEvents formatted similarly to Knative APIServerSource being sent.

AMR CloudEvent Handler Logs

```
kubectl -n metadata-store logs deployments/amr-persister
```

When an event is received, there are log messages for an event being handled:

```
{"level": "debug", "ts": "2023-06-20T15:47:09.203079201Z", "caller": "persister/persisteradapter.go:76", "msg": "Handle single event"}
{"level": "debug", "ts": "2023-06-20T15:47:09.203160964Z", "caller": "persister/persisteradapter.go:108", "msg": "Handle Event"}
```

When the Observer starts up, it will send the Location CloudEvent and the AMR CloudEvent Handler will send the Location information to the Metadata Store. The log messages will contain where the request is sent to, the JSON payload, as well as the response body returned from the Metadata Store:

```
{"level": "debug", "ts": "2023-06-20T15:47:09.203390152Z", "caller": "persister/persisteradapter.go:117", "msg": "Registry Location Event"}
{"level": "info", "ts": "2023-06-20T15:47:09.20349837Z", "caller": "persister/persisteradapter.go:279", "msg": "Sending request to: https://artifact-metadata-repository-app.metadata-store.svc.cluster.local:8443/api/v1/locations with payload: {"alias": "f17f073d-dfec-4624-953e-a133b694ecad", "reference": "f17f073d-dfec-4624-953e-a133b694ecad"}"}
{"level": "info", "ts": "2023-06-20T15:47:09.238033374Z", "caller": "persister/persisteradapter.go:299", "msg": "status: 200, responseBody: {"alias": "f17f073d-dfec-4624-953e-a133b694ecad", "reference": "f17f073d-dfec-4624-953e-a133b694ecad", "labels": null}"}
\n"
```

When there is an error sending Location to the Metadata Store:

```
{"level": "debug", "ts": "2023-06-20T15:15:04.294883639Z", "caller": "persister/persisteradapter.go:117", "msg": "Registry Location Event"}
```

```
{ "level": "info", "ts": "2023-06-20T15:15:04.295528237Z", "caller": "persister/persisteradapter.go:279", "msg": "Sending request to: https://artifact-metadata-repository-app.metadata-store.svc.cluster.local:8443/api/v1/locations with payload: {\"alias\": \"f17f073d-dfec-4624-953e-a133b694ecad\", \"reference\": \"f17f073d-dfec-4624-953e-a133b694ecad\"}" }
{ "level": "error", "ts": "2023-06-20T15:15:04.304782986Z", "caller": "persister/persisteradapter.go:283", "msg": "post error: Post \"https://artifact-metadata-repository-app.metadata-store.svc.cluster.local:8443/api/v1/locations\": dial tcp 10.28.116.184:8443: connect: connection refused", "stacktrace": "<...>" }
{ "level": "error", "ts": "2023-06-20T15:15:04.304878714Z", "caller": "amr-persister/main.go:72", "msg": "Error Handler received error Post \"https://artifact-metadata-repository-app.metadata-store.svc.cluster.local:8443/api/v1/locations\": dial tcp 10.28.116.184:8443: connect: connection refused", "stacktrace": "..."}

```

When the AMR CloudEvent Handler is up and ready to receive CloudEvents:

```
{ "level": "info", "ts": "2023-06-20T15:14:56.308829574Z", "caller": "amr-persister/main.go:61", "msg": "Start Receiving" }
```

When the Artifact Metadata Repository is unavailable:

```
{ "level": "error", "ts": "2023-06-20T19:03:47.006718745Z", "caller": "amr-persister/main.go:99", "msg": "AMR is unavailable: Get \"https://artifact-metadata-repository-app.metadata-store.svc.cluster.local:8443/play\": dial tcp 10.28.116.184:8443: connect: connection refused", "stacktrace": "..."}

```

When the Metadata Store is unavailable.

```
{ "level": "error", "ts": "2023-06-20T20:13:15.689628865Z", "caller": "amr-persister/main.go:102", "msg": "MDS is unavailable: Get \"https://metadata-store-app.metadata-store.svc.cluster.local:8443/api/health\": dial tcp 10.28.122.145:8443: connect: connection refused", "stacktrace": "..."}

```

The received ReplicaSet CloudEvent did not contain a “workload” container. Currently we only support ReplicaSets generated during a Workload run and contain a “workload” named container.

```
{ "level": "error", "ts": "2023-06-20T20:13:11.60733257Z", "caller": "persister/persisteradapter.go:218", "msg": "generate application payload error: unable to find workload container", "stacktrace": "..."}

```

The report already exists. This occurs when the resync period has been reached and the controllers are configured to reconcile the ImageVulnerability custom resource. This error is a non-issue as long as the previous submission of the report was successful.

```
{ "level": "info", "ts": "2023-06-21T20:54:32.772037121Z", "caller": "mds/handle-event.go:107", "msg": "Error posting image report: Validation failed: {\"message\": \"a report with uid 'd1625dd5ad94c2c5f83a8de4c3a3c382e4e4774a77c2e71fcf68a0cd3f953f7b' already exists\"}\n" }
{ "level": "error", "ts": "2023-06-21T20:54:32.772060231Z", "caller": "amr-persister/main.go:72", "msg": "Error Handler received error Validation failed: {\"message\": \"a report with uid 'd1625dd5ad94c2c5f83a8de4c3a3c382e4e4774a77c2e71fcf68a0cd3f953f7b' already exists\"}\n", "stacktrace": "..."}

```

Additional documentation for Supply Chain Security Tools - Store

This topic lists extra topics for explaining Supply Chain Security Tools (SCST) - Store in more detail.

Use and operate

- [Multicluster setup](#)
- [Developer namespace setup](#)
- [API details](#)
- [API walkthrough](#)
- [Failover, redundancy, and backups](#)

Troubleshooting and logging

- [Troubleshooting upgrading](#)
- [Log configuration and usage](#)
- [Connecting to the Postgres Database](#)

Configuration

- [Deployment details and configuration](#)

Access control

- [Retrieve access tokens](#)
- [Create service accounts](#)
- [Create a service account with a custom cluster role](#)

Certificates

- [Ingress support](#)
- [Using LoadBalancer](#)
- [Using NodePort](#)
- [Custom certificate configuration](#)
- [TLS configuration](#)
- [Certificate rotation](#)
- [Scanners cluster specific configurations](#)

Database

- [Use external postgres database](#)
- [AWS RDS postgres configuration](#)
- [Database backup recommendations](#)

Other

- [Install SCST - Store independent from TAP profiles](#)

Additional documentation for Supply Chain Security Tools - Store

This topic lists extra topics for explaining Supply Chain Security Tools (SCST) - Store in more detail.

Use and operate

- [Multicluster setup](#)
- [Developer namespace setup](#)
- [API details](#)
- [API walkthrough](#)
- [Failover, redundancy, and backups](#)

Troubleshooting and logging

- [Troubleshooting upgrading](#)
- [Log configuration and usage](#)
- [Connecting to the Postgres Database](#)

Configuration

- [Deployment details and configuration](#)

Access control

- [Retrieve access tokens](#)
- [Create service accounts](#)
- [Create a service account with a custom cluster role](#)

Certificates

- [Ingress support](#)
- [Using LoadBalancer](#)
- [Using NodePort](#)
- [Custom certificate configuration](#)
- [TLS configuration](#)
- [Certificate rotation](#)
- [Scanners cluster specific configurations](#)

Database

- [Use external postgres database](#)
- [AWS RDS postgres configuration](#)
- [Database backup recommendations](#)

Other

- [Install SCST - Store independent from TAP profiles](#)

API reference for Supply Chain Security Tools - Store

This topic contains API reference information for Supply Chain Security Tools - Store. See [API walkthrough](#) for an SCST - Store example.

Information

Version

1.6.1

Content negotiation

URI Schemes

- http
- https

Consumes

- application/json
- multipart/form-data
- application/xml

Produces

- application/json

All endpoints

images

Method	URI	Name	Summary
POST	/api/imageReport	create image report	(Use POST /api/v1/images instead) Create a new image report. Related packages and vulnerabilities are also created.
GET	/api/images	get images	Search image by id, name or digest .
GET	/api/packages/{IDor Name}/images	get package images	List the images that contain the given package.
GET	/api/vulnerabilities/{CVEID}/images	get vulnerability images	List the images that contain the given vulnerability.

Operations

Method	URI	Name	Summary
GET	/api/health	health check	

Packages

Method	URI	Name	Summary
GET	/api/images/{IDorDigest}/packages	get image packages	List the packages in an image.
GET	/api/images/packages	get image packages query	List packages of the given image.
GET	/api/packages	get packages	Search packages by id, name and/or version.

Method	URI	Name	Summary
GET	/api/sources/{IDorRepoorSha}/packages	get source packages	
GET	/api/sources/packages	get source packages query	List packages of the given source.
GET	/api/vulnerabilities/{CVEID}/packages	get vulnerability packages	List packages that contain the given CVE id.

Sources

Method	URI	Name	Summary
POST	/api/sourceReport	create source report	(Use POST /api/v1/sources instead) Create a new source report. Related packages and vulnerabilities are also created.
GET	/api/packages/{IDorName}/sources	get package sources	List the sources containing the given package.
GET	/api/sources	get sources	Search for sources by ID, repository, commit sha and/or organization.
GET	/api/vulnerabilities/{CVEID}/sources	get vulnerability sources	List sources that contain the given vulnerability.

v1artifact_groups

Method	URI	Name	Summary
POST	/api/v1/artifact-groups	create artifact group	Create an artifact group with specified labels and entity
POST	/api/v1/artifact-groups/_search	search artifact groups	Query for a list of artifact group that contains image(s) with specified digests, and or source(s) with specified shas. At least one image digest or source sha must be provided. This query can be further refined by matching images and sources with a specific combination of package name and/or cve id.
POST	/api/v1/artifact-groups/vulnerabilities/_reach	search artifact groups vuln reach	Search for how many artifact groups are affected by vulnerabilities associated with the specified image(s) digests, and/or source(s) shas. At least one image digest or source sha must be provided.
POST	/api/v1/artifact-groups/vulnerabilities/_search	search artifact groups vulnerabilities	Search for all vulnerabilities associated with an artifact group that contains image(s) with specified digests, and/or source(s) with specified shas. At least one image digest or source sha must be provided.

v1images

Method	URI	Name	Summary
GET	/api/v1/images/{ID_OR_DIGEST}	v1 get image	Search image by ID or DIGEST
GET	/api/v1/images	v1 get images	Query for images. If no parameters are given, this endpoint will return all images.

Method	URI	Name	Summary
POST	/api/v1/images	v1 post images	Add an image with a CycloneDX or SPDX report

v1packages

Method	URI	Name	Summary
GET	/api/v1/packages/{ID}	get package by ID	Search package by ID
GET	/api/v1/images/packages	v1 get images packages	Query for packages with images parameters. If no parameters are given, this endpoint will return all packages related to images.
GET	/api/v1/packages	v1 get packages	Query for packages. If no parameters are given, this endpoint will return all packages.
GET	/api/v1/sources/packages	v1 get sources packages	Query for packages with source parameters. If no parameters are given, this endpoint will return all packages related to sources.

v1reports

Method	URI	Name	Summary
GET	/api/v1/reports/{ReportUID}	v1 get report	Get a specific report by its unique identifier
GET	/api/v1/reports	v1 search reports	Query for a list of reports with specified image digest, source sha, or original location.

v1sources

Method	URI	Name	Summary
GET	/api/v1/sources/{ID_OR_SHA}	v1 get source	Search source by ID or SHA
GET	/api/v1/sources	v1 get sources	Query for sources. If no parameters are given, this endpoint will return all sources.
GET	/api/v1/sources/vulnerabilities	v1 get sources vulnerabilities	Query for vulnerabilities with source parameters. If no parameters are given, this endpoint will return all vulnerabilities.
POST	/api/v1/sources	v1 post sources	Add a source with a CycloneDX or SPDX report

v1triage

Method	URI	Name	Summary
POST	/api/v1/triage/{UID}/copy	v1 copy vulnerability analysis	Copies the analysis of an existing triage to a new target.
POST	/api/v1/triage	v1 create vulnerability analysis	Inserts or updates a vulnerability analysis
GET	/api/v1/triage	v1 get triage	Query for Triage Analysis. If no parameters are given, this endpoint will return all analysis instances.

v1vulnerabilities

Method	URI	Name	Summary
GET	/api/v1/vulnerabilities/{ID}	get vulnerability by ID	Search vulnerability by ID
GET	/api/v1/images/vulnerabilities	v1 get images vulnerabilities	Query for vulnerabilities with image parameters. If no parameters are give, this endpoint will return all vulnerabilities.

vulnerabilities

Method	URI	Name	Summary
GET	/api/images/{IDorDigest}/vulnerabilities	get image vulnerabilities	List vulnerabilities from the given image.
GET	/api/packages/{IDorName}/vulnerabilities	get package vulnerabilities	List vulnerabilities from the given package.
GET	/api/sources/{IDorRepoorSha}/vulnerabilities	get source vulnerabilities	
GET	/api/sources/vulnerabilities	get source vulnerabilities query	List vulnerabilities of the given source.
GET	/api/vulnerabilities	get vulnerabilities	Search for vulnerabilities by CVE id.

Paths

Create an artifact group with specified labels and entity (*CreateArtifactGroup*)

```
POST /api/v1/artifact-groups
```

Parameters

Name	Source	Type	Go type	Separator	Required	Default	Description
ArtifactGroupPostRequest	body	ArtifactGroupPostRequest	models.ArtifactGroupPostRequest		✓		

All responses

Code	Status	Description	Has headers	Schema
201	Created	ArtifactGroupCreatePostResponse		schema
400	Bad Request	ErrorMessage		schema
default		ErrorMessage		schema

Responses

201 - ArtifactGroupCreatePostResponse

Status: Created

Schema

[ArtifactGroupCreatePostResponse](#)

400 - ErrorMessage

Status: Bad Request

Schema

[ErrorMessage](#)

Default Response

ErrorMessage

Schema

[ErrorMessage](#)

(Use POST /api/v1/images instead) Create a new image report.
Related packages and vulnerabilities are also created.
(*CreateImageReport*)

```
POST /api/imageReport
```

Parameters

Name	Source	Type	Go type	Separator	Required	Default	Description
Image	body	Image	models.Image		✓		

All responses

Code	Status	Description	Has headers	Schema
200	OK	Image		schema
default		ErrorMessage		schema

Responses

200 - Image

Status: OK

Schema

[Image](#)

Default Response

ErrorMessage

Schema

[ErrorMessage](#)

(Use POST /api/v1/sources instead) Create a new source report.
 Related packages and vulnerabilities are also created.
 (*CreateSourceReport*)

```
POST /api/sourceReport
```

Parameters

Name	Source	Type	Go type	Separator	Required	Default	Description
Image	body	Source	models.Source		✓		

All responses

Code	Status	Description	Has headers	Schema
200	OK	Source		schema
default		ErrorMessage		schema

Responses

200 - Source

Status: OK

Schema

[Source](#)

Default Response

ErrorMessage

Schema

[ErrorMessage](#)

List the packages in an image. (*GetImagePackages*)

```
GET /api/images/{IDorDigest}/packages
```

Parameters

Name	Source	Type	Go type	Separator	Required	Default	Description
IDorDigest	path	string	string		✓		

All responses

Code	Status	Description	Has headers	Schema
200	OK	Package		schema
default		ErrorMessage		schema

Responses

200 - Package

Status: OK

Schema

[\[\]Package](#)

Default Response

ErrorMessage

Schema

[ErrorMessage](#)

List packages of the given image. (*GetImagePackagesQuery*)

```
GET /api/images/packages
```

Parameters

Name	Source	Type	Go type	Separator	Required	Default	Description
digest	query	string	string				
id	query	int64 (formatted integer)	int64				
name	query	string	string				

All responses

Code	Status	Description	Has headers	Schema
200	OK	Package		schema
default		ErrorMessage		schema

Responses

200 - Package

Status: OK

Schema

[\[\]Package](#)

Default Response

ErrorMessage

Schema

[ErrorMessage](#)

List vulnerabilities from the given image. (*GetImageVulnerabilities*)

```
GET /api/images/{IDorDigest}/vulnerabilities
```

Parameters

Name	Source	Type	Go type	Separator	Required	Default	Description
IDorDigest	path	string	string		✓		
Severity	query	string	string				Case insensitive vulnerabilities severity filter. Possible values are: low, medium, high, critical, unknown.

All responses

Code	Status	Description	Has headers	Schema
200	OK	Vulnerability		schema
default		ErrorMessage		schema

Responses

200 - Vulnerability

Status: OK

Schema

[\[\]Vulnerability](#)

Default Response

ErrorMessage

Schema

[ErrorMessage](#)

Search image by id, name or digest . (*GetImages*)

```
GET /api/images
```

All responses

Code	Status	Description	Has headers	Schema
200	OK	Image		schema
default		ErrorMessage		schema

Responses

200 - Image

Status: OK

Schema

[Image](#)

Default Response

ErrorMessage

Schema

[ErrorMessage](#)

Search package by ID (*GetPackageByID*)

```
GET /api/v1/packages/{ID}
```

Parameters

Name	Source	Type	Go type	Separator	Required	Default	Description
ID	path	uint64 (formatted integer)	uint64		✓		

All responses

Code	Status	Description	Has headers	Schema
200	OK	Package		schema
404	Not Found	ErrorMessage		schema
default		ErrorMessage		schema

Responses

200 - Package

Status: OK

Schema

[Package](#)

404 - ErrorMessage

Status: Not Found

Schema

[ErrorMessage](#)

Default Response

ErrorMessage

Schema

[ErrorMessage](#)

List the images that contain the given package. (*GetPackageImages*)

```
GET /api/packages/{IDorName}/images
```

Parameters

Name	Source	Type	Go type	Separator	Required	Default	Description
IDorName	path	string	string		✓		

All responses

Code	Status	Description	Has headers	Schema
200	OK	Image		schema
default		ErrorMessage		schema

Responses

200 - Image

Status: OK

Schema

[\[\]Image](#)

Default Response

ErrorMessage

Schema

[ErrorMessage](#)

List the sources containing the given package. (*GetPackageSources*)

```
GET /api/packages/{IDorName}/sources
```

Parameters

Name	Source	Type	Go type	Separator	Required	Default	Description
IDorName	path	string	string		✓		

All responses

Code	Status	Description	Has headers	Schema
200	OK	Source		schema
default		ErrorMessage		schema

Responses

200 - Source

Status: OK

Schema

[\[\]Source](#)

Default Response

ErrorMessage

Schema

[\[\]ErrorMessage](#)

List vulnerabilities from the given package. (*GetPackageVulnerabilities*)

```
GET /api/packages/{IDorName}/vulnerabilities
```

Parameters

Name	Source	Type	Go type	Separator	Required	Default	Description
IDorName	path	string	string		✓		
Severity	query	string	string				Case insensitive vulnerabilities severity filter. Possible values are: low, medium, high, critical, unknown.

All responses

Code	Status	Description	Has headers	Schema
200	OK	Vulnerability		schema
default		ErrorMessage		schema

Responses

200 - Vulnerability

Status: OK

Schema

[\[\]Vulnerability](#)

Default Response

ErrorMessage

Schema

[ErrorMessage](#)

Search packages by id, name and/or version. (*GetPackages*)

```
GET /api/packages
```

Parameters

Name	Source	Type	Go type	Separator	Required	Default	Description
id	query	int64 (formatted integer)	int64				Any of id or name must be provided
name	query	string	string				Any of id or name must be provided
version	query	string	string				

All responses

Code	Status	Description	Has headers	Schema
200	OK	Package		schema
default		ErrorMessage		schema

Responses

200 - Package

Status: OK

Schema

[\[\]Package](#)

Default Response

ErrorMessage

Schema

[ErrorMessage](#)

get source packages (*GetSourcePackages*)

```
GET /api/sources/{IDorRepoorSha}/packages
```

Parameters

Name	Source	Type	Go type	Separator	Required	Default	Description
IDorRepoorSha	path	string	string		✓		

All responses

Code	Status	Description	Has headers	Schema
200	OK	Package		schema
default		ErrorMessage		schema

Responses

200 - Package

Status: OK

Schema

[\[\]Package](#)

Default Response

ErrorMessage

Schema

[ErrorMessage](#)

List packages of the given source. (*GetSourcePackagesQuery*)

```
GET /api/sources/packages
```

Parameters

Name	Source	Type	Go type	Separator	Required	Default	Description
id	query	uint64 (formatted integer)	uint64				
repo	query	string	string				
sha	query	string	string				

All responses

Code	Status	Description	Has headers	Schema
200	OK	Package		schema

Code	Status	Description	Has headers	Schema
default		ErrorMessage		schema

Responses

200 - Package

Status: OK

Schema

[\[\]Package](#)

Default Response

ErrorMessage

Schema

[ErrorMessage](#)

get source vulnerabilities (*GetSourceVulnerabilities*)

```
GET /api/sources/{IDorRepoorSha}/vulnerabilities
```

Parameters

Name	Source	Type	Go type	Separator	Required	Default	Description
IDorRepoorSha	path	string	string		✓		

All responses

Code	Status	Description	Has headers	Schema
200	OK	Vulnerability		schema
default		ErrorMessage		schema

Responses

200 - Vulnerability

Status: OK

Schema

[\[\]Vulnerability](#)

Default Response

ErrorMessage

Schema

[ErrorMessage](#)

List vulnerabilities of the given source. (*GetSourceVulnerabilitiesQuery*)

```
GET /api/sources/vulnerabilities
```

Parameters

Name	Source	Type	Go type	Separator	Required	Default	Description
Severity	query	string	string				Case insensitive vulnerabilities severity filter. Possible values are: low, medium, high, critical, unknown.
id	query	uint64 (formatted integer)	uint64				
repo	query	string	string				
sha	query	string	string				

All responses

Code	Status	Description	Has headers	Schema
200	OK	Vulnerability		schema
default		ErrorMessage		schema

Responses

200 - Vulnerability

Status: OK

Schema

[\[\]Vulnerability](#)

Default Response

ErrorMessage

Schema

[ErrorMessage](#)

Search for sources by ID, repository, commit sha and/or organization. (*GetSources*)

GET /api/sources

Parameters

Name	Source	Type	Go type	Separator	Required	Default	Description
id	query	int64 (formatted integer)	int64				
org	query	string	string				
repo	query	string	string				
sha	query	string	string				

All responses

Code	Status	Description	Has headers	Schema
200	OK	Source		schema
default		ErrorMessage		schema

Responses

200 - Source

Status: OK

Schema

[\[\]Source](#)

Default Response

ErrorMessage

Schema

[ErrorMessage](#)

Search for vulnerabilities by CVE id. (*GetVulnerabilities*)

GET /api/vulnerabilities

Parameters

Name	Source	Type	Go type	Separator	Required	Default	Description
CVEID	query	string	string		✓		
Severity	query	string	string				Case insensitive vulnerabilities severity filter. Possible values are: low, medium, high, critical, unknown.

All responses

Code	Status	Description	Has headers	Schema
200	OK	Vulnerability		schema
default		ErrorMessage		schema

Responses

200 - Vulnerability

Status: OK

Schema

[\[\]Vulnerability](#)

Default Response

ErrorMessage

Schema

[ErrorMessage](#)

Search vulnerability by ID (*GetVulnerabilityByID*)

```
GET /api/v1/vulnerabilities/{ID}
```

Parameters

Name	Source	Type	Go type	Separator	Required	Default	Description
ID	path	uint64 (formatted integer)	uint64		✓		

All responses

Code	Status	Description	Has headers	Schema
200	OK	Vulnerability		schema
404	Not Found	ErrorMessage		schema
default		ErrorMessage		schema

Responses

200 - Vulnerability

Status: OK

Schema

[Vulnerability](#)

404 - ErrorMessage

Status: Not Found

Schema

[ErrorMessage](#)

Default Response

ErrorMessage

Schema

[ErrorMessage](#)

List the images that contain the given vulnerability. (*GetVulnerabilityImages*)

```
GET /api/vulnerabilities/{CVEID}/images
```

Parameters

Name	Source	Type	Go type	Separator	Required	Default	Description
CVEID	path	string	string		✓		

All responses

Code	Status	Description	Has headers	Schema
200	OK	Image		schema
default		ErrorMessage		schema

Responses

200 - Image

Status: OK

Schema

[\[\]Image](#)

Default Response

ErrorMessage

Schema

[ErrorMessage](#)

List packages that contain the given CVE id. (*GetVulnerabilityPackages*)

```
GET /api/vulnerabilities/{CVEID}/packages
```

Parameters

Name	Source	Type	Go type	Separator	Required	Default	Description
CVEID	path	string	string		✓		

All responses

Code	Status	Description	Has headers	Schema
200	OK	Package		schema
default		ErrorMessage		schema

Responses

200 - Package

Status: OK

Schema

[\[\]Package](#)

Default Response

ErrorMessage

Schema

[ErrorMessage](#)

List sources that contain the given vulnerability. (*GetVulnerabilitySources*)

```
GET /api/vulnerabilities/{CVEID}/sources
```

Parameters

Name	Source	Type	Go type	Separator	Required	Default	Description
CVEID	path	string	string		✓		

All responses

Code	Status	Description	Has headers	Schema
200	OK	Source		schema
default		ErrorMessage		schema

Responses

200 - Source

Status: OK

Schema

[\[Source\]](#)

Default Response

ErrorMessage

Schema

[ErrorMessage](#)

health check (*HealthCheck*)

```
GET /api/health
```

All responses

Code	Status	Description	Has headers	Schema
200	OK			schema
default		ErrorMessage		schema

Responses

200

Status: OK

Schema

Default Response

ErrorMessage

Schema

[ErrorMessage](#)

Query for a list of artifact group that contains image(s) with specified digests, and or source(s) with specified shas. At least one image digest or source sha must be provided. This query can be further refined by matching images and sources with a specific combination of package name and/or cve id. (*SearchArtifactGroups*)

```
POST /api/v1/artifact-groups/_search
```

Query for a list of artifact group that contains image(s) with specified digests, and or source(s) with specified shas.

Parameters

Name	Source	Type	Go type	Separator	Required	Default	Description
ArtifactGroupFilter sPostRequest	body	ArtifactGroupS earchFilters	models.ArtifactGro upSearchFilters		✓		

All responses

Code	Status	Description	Has headers	Schema
200	OK	PaginatedArtifactGroupSearchPostResponse		schema
400	Bad Request	ErrorMessage		schema
default		ErrorMessage		schema

Responses

200 - PaginatedArtifactGroupSearchPostResponse

Status: OK

Schema

[PaginatedArtifactGroupSearchPostResponse](#)

400 - ErrorMessage

Status: Bad Request

Schema

[ErrorMessage](#)

Default Response

ErrorMessage

Schema

[ErrorMessage](#)

Search for how many artifact groups are affected by vulnerabilities associated with the specified image(s) digests, and/or source(s) shas. At least one image digest or source sha must be provided. (*SearchArtifactGroupsVulnReach*)

```
POST /api/v1/artifact-groups/vulnerabilities/_reach
```

Parameters

Name	Source	Type	Go type	Separator	Required	Default	Description
ArtifactGroupVulnReachFiltersPostRequest	body	ArtifactGroupVulnReachFiltersPostRequest	models.ArtifactGroupVulnReachFiltersPostRequest		✓		

All responses

Code	Status	Description	Has headers	Schema
200	OK	PaginatedArtifactGroupVulnReachPostResponse		schema
400	Bad Request	ErrorMessage		schema
default		ErrorMessage		schema

Responses

200 - PaginatedArtifactGroupVulnReachPostResponse

Status: OK

Schema

[PaginatedArtifactGroupVulnReachPostResponse](#)

400 - ErrorMessage

Status: Bad Request

Schema

[ErrorMessage](#)

Default Response

ErrorMessage

Schema

[ErrorMessage](#)

Search for all vulnerabilities associated with an artifact group that contains image(s) with specified digests, and/or source(s) with specified shas. At least one image digest or source sha must be provided. (*SearchArtifactGroupsVulnerabilities*)

```
POST /api/v1/artifact-groups/vulnerabilities/_search
```

The result can be further refined by matching the images and sources with a package name and/or an artifact group UID

Parameters

Name	Source	Type	Go type	Separator	Required	Default	Description
ArtifactGroupVulnSearchFiltersPostRequest	body	ArtifactGroupVulnSearchFilters	models.ArtifactGroupVulnSearchFilters		✓		

All responses

Code	Status	Description	Has headers	Schema
200	OK	PaginatedArtifactGroupVulnSearchPostResponse		schema
400	Bad Request	ErrorMessage		schema
default		ErrorMessage		schema

Responses

200 - PaginatedArtifactGroupVulnSearchPostResponse

Status: OK

Schema

[PaginatedArtifactGroupVulnSearchPostResponse](#)

400 - ErrorMessage

Status: Bad Request

Schema

[ErrorMessage](#)

Default Response

ErrorMessage

Schema

[ErrorMessage](#)

Copies the analysis of an existing triage to a new target. (*V1CopyVulnerabilityAnalysis*)

```
POST /api/v1/triage/{UID}/copy
```

This endpoint takes an existing analysis instance and copies its latest state into a new instance, replacing the image/source/artifact group of the existing analysis with the ones provided in the request.

If an instance with the targeted parameters already exists, it updates its analysis to match that of the instance found by the provided uid.

Consumes

- application/json

Parameters

Name	Source	Type	Go type	Separator	Required	Default	Description
UID	path	string	string		✓		UID of triage to copy from
VulnerabilityAnalysisCopyRequest	body	VulnerabilityAnalysisCopyRequest	models.VulnerabilityAnalysisCopyRequest		✓		

All responses

Code	Status	Description	Has headers	Schema
200	OK	V1AnalysisInstanceUIDResponse		schema
201	Created	V1AnalysisInstanceUIDResponse		schema
400	Bad Request	ErrorMessage		schema
404	Not Found	ErrorMessage		schema
503	Service Unavailable	ErrorMessage		schema

Responses

200 - V1AnalysisInstanceUIDResponse

Status: OK

Schema

[AnalysisInstanceUIDResponse](#)

201 - V1AnalysisInstanceUIDResponse

Status: Created

Schema

[AnalysisInstanceUIDResponse](#)

400 - ErrorMessage

Status: Bad Request

Schema

[ErrorMessage](#)

404 - ErrorMessage

Status: Not Found

Schema

[ErrorMessage](#)

503 - ErrorMessage

Status: Service Unavailable

Schema

[ErrorMessage](#)

Inserts or updates a vulnerability analysis (*V1CreateVulnerabilityAnalysis*)

```
POST /api/v1/triage
```

Creates or updates a vulnerability analysis for a particular vulnerability instance. A vulnerability instance is a combination of Vulnerability + OS/Application Package + Image or Source + Artifact Group.

A vulnerability analysis contains the necessary data to assess the impact of a particular vulnerability. This endpoint follows CycloneDX Vex specification for vulnerability analysis.

Consumes

- application/json

Parameters

Name	Source	Type	Go type	Separator	Required	Default	Description
VulnerabilityAnalysisRequest	body	VulnerabilityAnalysisRequest	models.VulnerabilityAnalysisRequest		✓		

All responses

Code	Status	Description	Has headers	Schema
200	OK	V1AnalysisInstanceUIDResponse		schema
201	Created	V1AnalysisInstanceUIDResponse		schema
400	Bad Request	ErrorMessage		schema
503	Service Unavailable	ErrorMessage		schema

Responses

200 - V1AnalysisInstanceUIDResponse

Status: OK

Schema

[AnalysisInstanceUIDResponse](#)

201 - V1AnalysisInstanceUIDResponse

Status: Created

Schema

[AnalysisInstanceUIDResponse](#)

400 - ErrorMessage

Status: Bad Request

Schema

[ErrorMessage](#)

503 - ErrorMessage

Status: Service Unavailable

Schema

[ErrorMessage](#)

Search image by ID or DIGEST (V1GetImage)

```
GET /api/v1/images/{ID_OR_DIGEST}
```

One of the following combination of headers is needed (—> response format):

1. Report-Type-Format: cyclonedx and Accept: application/json —> cyclonedx SBOM
2. Report-Type-Format: cyclonedx and Accept: application/xml —> cyclonedx SBOM
3. Report-Type-Format: spdx2.2 and Accept: application/json —> spdx SBOM
4. Report-Type-Format and Accept not present at all —> Image

Parameters

Name	Source	Type	Go type	Separator	Required	Default	Description
ID_OR_DIGEST	path	string	string		✓		
Accept	header	string	string				The Accept type of the input report. Supported values are 'application/json', 'application/xml'
Report-Type-Format	header	string	string				The input report type format. Supported values are 'cyclonedx' and 'spdx2.2'

All responses

Code	Status	Description	Has headers	Schema
200	OK	Image		schema

Code	Status	Description	Has headers	Schema
404	Not Found	ErrorMessage		schema
default		ErrorMessage		schema

Responses

200 - Image

Status: OK

Schema

[Image](#)

404 - ErrorMessage

Status: Not Found

Schema

[ErrorMessage](#)

Default Response

ErrorMessage

Schema

[ErrorMessage](#)

Query for images. If no parameters are given, this endpoint will return all images. (*V1GetImages*)

```
GET /api/v1/images
```

Parameters

Name	Source	Type	Go type	Separator	Required	Default	Description
all	query	boolean	bool				If no pagination parameters are provided, defaults to true and returns all available results.
digest	query	string	string				
name	query	string	string				
page	query	int64 (formatted integer)	int64			1	

Name	Source	Type	Go type	Separator	Required	Default	Description
page_size	query	int64 (formatted integer)	int64			20	
registry	query	string	string				

All responses

Code	Status	Description	Has headers	Schema
200	OK	PaginatedImageResponse		schema
404	Not Found	ErrorMessage		schema
default		ErrorMessage		schema

Responses

200 - PaginatedImageResponse

Status: OK

Schema

[PaginatedImageResponse](#)

404 - ErrorMessage

Status: Not Found

Schema

[ErrorMessage](#)

Default Response

ErrorMessage

Schema

[ErrorMessage](#)

Query for packages with images parameters. If no parameters are given, this endpoint will return all packages related to images. (*V1GetImagesPackages*)

```
GET /api/v1/images/packages
```

Parameters

Name	Source	Type	Go type	Separator	Required	Default	Description
all	query	boolean	bool				If no pagination parameters are provided, defaults to true and returns all available results.
digest	query	string	string				
name	query	string	string				
package_name	query	string	string				Substring package name filter. For example, setting <code>name=cur</code> would match <code>curl</code> and <code>libcurl</code> .
page	query	int64 (formatted integer)	int64			1	
page_size	query	int64 (formatted integer)	int64			20	
registry	query	string	string				

All responses

Code	Status	Description	Has headers	Schema
200	OK	PaginatedPackageResponse		schema
404	Not Found	ErrorMessage		schema
default		ErrorMessage		schema

Responses

200 - PaginatedPackageResponse

Status: OK

Schema

[PaginatedPackageResponse](#)

404 - ErrorMessage

Status: Not Found

Schema

[ErrorMessage](#)

Default Response

ErrorMessage

Schema

[ErrorMessage](#)

Query for vulnerabilities with image parameters. If no parameters are give, this endpoint will return all vulnerabilities.
(*V1GetImagesVulnerabilities*)

```
GET /api/v1/images/vulnerabilities
```

Parameters

Name	Source	Type	Go type	Separator	Required	Default	Description
Severity	query	string	string				Case insensitive vulnerabilities severity filter. Possible values are: low, medium, high, critical, unknown.
all	query	boolean	bool				If no pagination parameters are provided, defaults to true and returns all available results.
digest	query	string	string				
name	query	string	string				
page	query	int64 (formatted integer)	int64			1	
page_size	query	int64 (formatted integer)	int64			20	
registry	query	string	string				

All responses

Code	Status	Description	Has headers	Schema
200	OK	PaginatedVulnerabilityResponse		schema
404	Not Found	ErrorMessage		schema
default		ErrorMessage		schema

Responses

200 - PaginatedVulnerabilityResponse

Status: OK

Schema

[PaginatedVulnerabilityResponse](#)

404 - ErrorMessage

Status: Not Found

Schema

[ErrorMessage](#)

Default Response

ErrorMessage

Schema

[ErrorMessage](#)

Query for packages. If no parameters are given, this endpoint will return all packages. (*V1GetPackages*)

```
GET /api/v1/packages
```

Parameters

Name	Source	Type	Go type	Separator	Required	Default	Description
all	query	boolean	bool				If no pagination parameters are provided, defaults to true and returns all available results.
name	query	string	string				Name filter works as a substring match on the package name. For example, setting <code>name=cur</code> would match <code>curl</code> and <code>libcurl</code> .
package_manager	query	string	string				
page	query	int64 (formatted integer)	int64			1	
page_size	query	int64 (formatted integer)	int64			20	
version	query	string	string				

All responses

Code	Status	Description	Has headers	Schema
200	OK	PaginatedPackageResponse		schema
404	Not Found	ErrorMessage		schema
default		ErrorMessage		schema

Responses

200 - PaginatedPackageResponse

Status: OK

Schema

[PaginatedPackageResponse](#)

404 - ErrorMessage

Status: Not Found

Schema

[ErrorMessage](#)

Default Response

ErrorMessage

Schema

[ErrorMessage](#)

Get a specific report by its unique identifier (*V1GetReport*)

```
GET /api/v1/report/{ReportUID}
```

One of the following combination of headers is needed (—> response format):

1. Report-Type-Format: CycloneDX and Accept: application/json —> CycloneDX SBOM
2. Report-Type-Format: CycloneDX and Accept: application/xml —> CycloneDX SBOM
3. Report-Type-Format: spdx2.2 and Accept: application/json —> SPDX SBOM
4. Report-Type-Format and Accept not present at all —> ReportResponse

Parameters

Name	Source	Type	Go type	Separator	Required	Default	Description
ReportUID	path	string	string		✓		The report's unique identifier
Accept	header	string	string				The Accept type of the input report. Supported values are 'application/json', 'application/xml'
Report-Type-Format	header	string	string				The input report type format. Supported values are 'cyclonedx' and 'spdx2.2'

All responses

Code	Status	Description	Has headers	Schema
200	OK	ReportResponse		schema
400	Bad Request	ErrorMessage		schema
404	Not Found	ErrorMessage		schema
503	Service Unavailable	ErrorMessage		schema

Responses

200 - ReportResponse

Status: OK

Schema

[ReportResponse](#)

400 - ErrorMessage

Status: Bad Request

Schema

[ErrorMessage](#)

404 - ErrorMessage

Status: Not Found

Schema

[ErrorMessage](#)

503 - ErrorMessage

Status: Service Unavailable

Schema

[ErrorMessage](#)

Search source by ID or SHA (*V1GetSource*)

```
GET /api/v1/sources/{ID_OR_SHA}
```

One of the following combinations of headers could be used, if not headers are sent the default response is Source (→ response format):

1. Report-Type-Format: cyclonedx and Accept: application/json → cyclonedx SBOM
2. Report-Type-Format: cyclonedx and Accept: application/xml → cyclonedx SBOM
3. Report-Type-Format: sdx2.2 and Accept: application/json → sdx SBOM

Parameters

Name	Source	Type	Go type	Separator	Required	Default	Description
ID_OR_SHA	path	string	string		✓		
Accept	header	string	string				The Accept type of the input report. Supported values are 'application/json', 'application/xml'
Report-Type-Format	header	string	string				The input report type format. Supported values are 'cyclonedx' and 'spdx2.2'

All responses

Code	Status	Description	Has headers	Schema
200	OK	Source		schema
404	Not Found	ErrorMessage		schema
default		ErrorMessage		schema

Responses

200 - Source

Status: OK

Schema

[Source](#)

404 - ErrorMessage

Status: Not Found

Schema

[ErrorMessage](#)

Default Response

ErrorMessage

Schema

[ErrorMessage](#)

Query for sources. If no parameters are given, this endpoint will return all sources. (*V1GetSources*)

```
GET /api/v1/sources
```

Parameters

Name	Source	Type	Go type	Separator	Required	Default	Description
all	query	boolean	bool				If no pagination parameters are provided, defaults to true and returns all available results.
org	query	string	string				
page	query	int64 (formatted integer)	int64			1	
page_size	query	int64 (formatted integer)	int64			20	
repo	query	string	string				
sha	query	string	string				

All responses

Code	Status	Description	Has headers	Schema
200	OK	PaginatedSourceResponse		schema
404	Not Found	ErrorMessage		schema
default		ErrorMessage		schema

Responses

200 - PaginatedSourceResponse

Status: OK

Schema

[PaginatedSourceResponse](#)

404 - ErrorMessage

Status: Not Found

Schema

[ErrorMessage](#)

Default Response

ErrorMessage

Schema

[ErrorMessage](#)

Query for packages with source parameters. If no parameters are given, this endpoint will return all packages related to sources.
(*V1GetSourcesPackages*)

```
GET /api/v1/sources/packages
```

All responses

Code	Status	Description	Has headers	Schema
200	OK	PaginatedPackageResponse		schema
404	Not Found	ErrorMessage		schema
default		ErrorMessage		schema

Responses

200 - PaginatedPackageResponse

Status: OK

Schema

[PaginatedPackageResponse](#)

404 - ErrorMessage

Status: Not Found

Schema

[ErrorMessage](#)

Default Response

ErrorMessage

Schema

[ErrorMessage](#)

Query for vulnerabilities with source parameters. If no parameters are given, this endpoint will return all vulnerabilities.
(*V1GetSourcesVulnerabilities*)

```
GET /api/v1/sources/vulnerabilities
```

Parameters

Name	Source	Type	Go type	Separator	Required	Default	Description
Severity	query	string	string				Case insensitive vulnerabilities severity filter. Possible values are: low, medium, high, critical, unknown.
all	query	boolean	bool				If no pagination parameters are provided, defaults to true and returns all available results.
org	query	string	string				
page	query	int64 (formatted integer)	int64			1	
page_size	query	int64 (formatted integer)	int64			20	
repo	query	string	string				
sha	query	string	string				

All responses

Code	Status	Description	Has headers	Schema
200	OK	PaginatedVulnerabilityResponse		schema
404	Not Found	ErrorMessage		schema
default		ErrorMessage		schema

Responses

200 - PaginatedVulnerabilityResponse

Status: OK

Schema

[PaginatedVulnerabilityResponse](#)

404 - ErrorMessage

Status: Not Found

Schema

[ErrorMessage](#)

Default Response

ErrorMessage

Schema

[ErrorMessage](#)

Query for Triage Analysis. If no parameters are given, this endpoint will return all analysis instances. (*V1GetTriage*)

```
GET /api/v1/triage
```

Parameters

Name	Source	Type	Go type	Separator	Required	Default	Description
all	query	boolean	bool				If no pagination parameters are provided, defaults to true and returns all available results.
commit	query	string	string				
digest	query	string	string				
page	query	int64 (formatted integer)	int64			1	
page_size	query	int64 (formatted integer)	int64			20	

All responses

Code	Status	Description	Has headers	Schema
200	OK	PaginatedVulnerabilityAnalysisResponse		schema
400	Bad Request	ErrorMessage		schema

Responses

200 - PaginatedVulnerabilityAnalysisResponse

Status: OK

Schema

[PaginatedVulnerabilityAnalysisResponse](#)

400 - ErrorMessage

Status: Bad Request

Schema

[ErrorMessage](#)

Add an image with a CycloneDX or SPDX report (*V1PostImages*)

```
POST /api/v1/images
```

A CycloneDX or SPDX report can be sent in one of two ways: 1) through the body of the request or 2) through uploading the file via a multi-part form.

To add an image via a CycloneDX report or SPDX report submitted in the body of the request, use one of the following supported header combinations: 1. Report-Type-Format: cyclonedx and Content-Type: application/json 2. Report-Type-Format: cyclonedx and Content-Type: application/xml 3. Report-Type-Format: spdx and Content-Type: application/json

To add an image via a CycloneDX report or SPDX report submitted by uploading a file, the following are required: 1. the Content-Type header must be 'multipart/form-data' 2. the Report-Type-Format header must also be specified as either 'cyclonedx' or 'spdx' 3. formData includes field 'file' for the CycloneDX or SPDX report file 4. formData includes field 'format' of the report file

Consumes

- application/json
- application/xml
- multipart/form-data

Parameters

Name	Source	Type	Go type	Separator	Required	Default	Description
Content-Type	header	string	string		✓		The content type of the input report. Supported values are 'application/json', 'application/xml', and 'multipart/form-data'
Entity-Name	header	string	string				Manual input of the name of the entity. If this value is provided, Entity-Version header must also be provided. If this value is not provided, the value will be read from the submitted SBOM
Entity-Version	header	string	string				Manual input of the version of the entity. If this value is provided, Entity-Name header must also be provided. If this value is not provided, the value will be read from the submitted SBOM
Original-Location	header	string	string				The stored location of the original SBOM vulnerability scan result used to create this report.
Report-Type-Format	header	string	string		✓		The input report type format. Supported values are 'cyclonedx' and 'spdx'
Report-UID	header	string	string				A unique identifier to assign to the report. If omitted, a unique identifier will be randomly generated for the report. Supported characters: ALPHA DIGIT "-" / "." / "_" / "~"
file	formData	file	io.ReaderCloser				CycloneDX or SPDX report (required if using 'multipart/form-data')

Name	Source	Type	Go type	Separator	Required	Default	Description
format	formData	string	string				The file format of the report file. Supported values are 'application/json' and 'application/xml' (required if using 'multipart/form-data')

All responses

Code	Status	Description	Has headers	Schema
200	OK	V1ImagePostResponse		schema
400	Bad Request	ErrorMessage		schema
default		ErrorMessage		schema

Responses

200 - V1ImagePostResponse

Status: OK

Schema

[V1ImagePostResponse](#)

400 - ErrorMessage

Status: Bad Request

Schema

[ErrorMessage](#)

Default Response

ErrorMessage

Schema

[ErrorMessage](#)

Add a source with a CycloneDX or SPDX report (*V1PostSources*)

```
POST /api/v1/sources
```

A CycloneDX or SPDX report can be sent in one of two ways: 1) through the body of the request or 2) through uploading the file via a multi-part form.

To add a source via a CycloneDX report or SPDX report submitted in the body of the request, use one of the following supported header combinations: 1. Report-Type-Format: cyclonedx and Content-Type: application/json 2. Report-Type-Format: cyclonedx and Content-Type: application/xml 3. Report-Type-Format: spdx and Content-Type: application/json

To add a source via a CycloneDX report or SPDX report submitted by uploading a file, the following are required: 1. the Content-Type header must be 'multipart/form-data' 2. the Report-Type-Format header must also be specified as either 'cyclonedx' or 'spdx' 3. formData includes field 'file' for the CycloneDX or SPDX report file 4. formData includes field 'format' of the report file

Consumes

- application/json
- application/xml
- multipart/form-data

Parameters

Name	Source	Type	Go type	Separator	Required	Default	Description
Content-Type	header	string	string		✓		The content type of the input report. Supported values are 'application/json', 'application/xml', and 'multipart/form-data'
Entity-Name	header	string	string				Manual input of the name of the entity. If this value is provided, Entity-Version header must also be provided. If this value is not provided, the value will be read from the submitted SBOM
Entity-Version	header	string	string				Manual input of the version of the entity. If this value is provided, Entity-Name header must also be provided. If this value is not provided, the value will be read from the submitted SBOM
Original-Location	header	string	string				The stored location of the original SBOM vulnerability scan result used to create this report.
Report-Type-Format	header	string	string		✓		The input report type format. Supported values are 'cyclonedx' and 'spdx'
Report-UID	header	string	string				A unique identifier to assign to the report. If omitted, a unique identifier will be randomly generated for the report. Supported characters: ALPHA DIGIT "-" / "." / "_" / "~"
file	formData	file	io.ReadCloser				CycloneDX or SPDX report (required if using 'multipart/form-data')
format	formData	string	string				The file format of the report file. Supported values are 'application/json' and 'application/xml' (required if using 'multipart/form-data')

All responses

Code	Status	Description	Has headers	Schema
200	OK	V1SourcePostResponse		schema
400	Bad Request	ErrorMessage		schema

Responses

200 - V1SourcePostResponse

Status: OK

Schema

V1SourcePostResponse

400 - ErrorMessage

Status: Bad Request

Schema

ErrorMessage

Query for a list of reports with specified image digest, source sha, or original location. (*V1SearchReports*)

```
GET /api/v1/reports
```

Parameters

Name	Source	Type	Go type	Separator	Required	Default	Description
all	query	boolean	bool				If no pagination parameters are provided, defaults to true and returns all available results.
artifact_group_name	query	string	string				Filter reports by the associated artifact group with provided "name" label value. Only available when searching by image or source.
artifact_group_namespace	query	string	string				Filter reports by the associated artifact group with provided "namespace" label value. Only available when searching by image or source.
artifact_group_uid	query	string	string				The uid of the artifact group that the report(s) are associated with. Only available when searching by image or source.
digest	query	string	string		✓		The digest of the image. Only one of image digest, source sha, or original location should be provided.
ordering	query	string	string			"DESC"	The order in which the list of reports will be returned. When set to ASC, will return the list in ascending order (oldest to newest) by date/time the report was generated. When set to DESC, will return the list in descending order (newest to oldest).

Name	Source	Type	Go type	Separator	Required	Default	Description
original_location	query	string	string		✓		The URI of where the original SBOM scan reports are stored. Only one of image digest, source sha, or original location should be provided.
page	query	int64 (formatted integer)	int64			1	
page_size	query	int64 (formatted integer)	int64			20	
sha	query	string	string		✓		The sha index of the source. Only one of image digest, source sha, or original location should be provided.

All responses

Code	Status	Description	Has headers	Schema
200	OK	PaginatedSearchReportResponse		schema
400	Bad Request	ErrorMessage		schema
404	Not Found	ErrorMessage		schema
500	Internal Server Error	ErrorMessage		schema

Responses

200 - PaginatedSearchReportResponse

Status: OK

Schema

[PaginatedSearchReportResponse](#)

400 - ErrorMessage

Status: Bad Request

Schema

[ErrorMessage](#)

404 - ErrorMessage

Status: Not Found

Schema

[ErrorMessage](#)

500 - ErrorMessage

Status: Internal Server Error

Schema

[ErrorMessage](#)

Models

AnalysisInstanceImageDependency

Properties

Name	Type	Go type	Required	Default	Description	Example
Digest	string	string	✓		The digest of the image	sha256:f7de1564f13da1ef7e5720ebce14006793242c0d8d7d60c343632bcf3bc5306d
Registry	string	string			The DNS name of the registry that stores the image	docker.io

AnalysisInstancePackageDependency

Properties

Name	Type	Go type	Required	Default	Description	Example
Name	string	string	✓		OS or Application package name	libc
Version	string	string	✓		OS or Application package version	0.0.1

AnalysisInstanceSourceDependency

Properties

Name	Type	Go type	Required	Default	Description	Example
Org	string	string			The repository organization name of the source entity	my-organization
Repo	string	string			The repository name of the source	my-sample-repo
Sha	string	string	✓		The commit sha of the source	d6cd1e2bd19e03a81132a23b2025920577f84e37

AnalysisInstanceUIDResponse

Properties

Name	Type	Go type	Required	Default	Description	Example
UID	string	string			Unique identifier for the analysis instance	8b1cc5da-fabe-45a6-ab8c-49260bbeef99

AnalysisRequest

Properties

Name	Type	Go type	Required	Default	Description	Example
Comments	string	string			Free form comments for the analysis	Lorem ipsum dolor sit amet
Justification	string	string			The rationale of why the analysis state was asserted	code_not_present
Response	[]string	[]string			A response to the vulnerability by the manufacturer, supplier, or project responsible for the affected component or service	
State	string	string	✓		Triage analysis state	in_triage

ArtifactGroupCreatePostResponse

Properties

Name	Type	Go type	Required	Default	Description	Example
Entities	[]EntityCreatePostResponse	[]*EntityCreatePostResponse			Entities associated with the Artifact Group	
Labels	map of string	map[string]string			Key-Value pair of labels associated with the Artifact Group	{"env": "production", "namespace": "default"}
Report UID	string	string			Unique identifier for the report	
UID	string	string			Unique identifier for the Artifact Group such as workload UID	8b1cc5da-fabe-45a6-ab8c-49260bbeef99

ArtifactGroupPostRequest

Properties

Name	Type	Go type	Required	Default	Description	Example
EntityID	uint64 (formatted integer)	uint64			The database ID of the source or image being associated with this artifact group	24
Labels	map of string	map[string]string			Key-Value pair of labels associated with the Artifact Group	{"env": "production", "namespace": "default"}
Report UID	string	string			Report's unique identifier. Supported characters: ALPHA DIGIT "-" / "." / "_" / "~"	
in: header						
Type	string	string			The entity type being associated with this artifact group. Allowable values: image, source	image

Name	Type	Go type	Required	Default	Description	Example
UID	string	<code>string</code>	✓		Unique identifier for the Artifact Group such as workload UID	<code>8b1cc5da-fabe-45a6-ab8c-49260bbeef99</code>

ArtifactGroupResponse

Properties

Name	Type	Go type	Required	Default	Description	Example
Entities	<code>[]EntityResponse</code>	<code>[]*EntityResponse</code>			Entities associated with the Artifact Group	
Labels	map of string	<code>map[string]string</code>			Key-Value pair of labels associated with the Artifact Group	<code>{"env": "production", "namespace": "default"}</code>
Report UID	string	<code>string</code>			Unique identifier for the report	
UID	string	<code>string</code>			Unique identifier for the Artifact Group such as workload UID	<code>8b1cc5da-fabe-45a6-ab8c-49260bbeef99</code>

ArtifactGroupSearchEntityPostResponse

Properties

Name	Type	Go type	Required	Default	Description	Example
Digest	string	<code>string</code>			The digest of the image entity. Only visible if the entity is of image type	<code>sha256:f7de1564f13da1ef7e5720ebce14006793242c0d8d7d60c343632bcf3bc5306d</code>
Host	string	<code>string</code>			The dns name where the source entity is hosted on. Only visible if the entity type is of source type	<code>gitlab.com</code>
ID	uint64 (formatted integer)	<code>uint64</code>	✓		The database ID of the source or image	<code>24</code>
Name	string	<code>string</code>			The name of the image entity. Only visible if the entity is of image type	<code>checkr/flagr</code>
Org	string	<code>string</code>			The organization name of the source entity. Only visible if the entity type is of source type	<code>my-organization</code>
Packages	<code>[]ArtifactGroupSearchPackagePostResponse</code>	<code>[]*ArtifactGroupSearchPackagePostResponse</code>				
Registry	string	<code>string</code>			The DNS name of the registry that stores the image entity. Only visible if the entity is of image type	<code>docker.io</code>

Name	Type	Go type	Required	Default	Description	Example
Repo	string	string			The repository name of the source entity. Only visible if the entity type is of source type	my-sample-repo
Sha	string	string			The commit sha of the source entity. Only visible if the entity type is of source type	d6cd1e2bd19e03a81132a23b2025920577f84e37
Type	string	string	✓		The entity Type of scan that is stored. This is set to either "image" or "source"	image

ArtifactGroupSearchFilters

Properties

Name	Type	Go type	Required	Default	Description	Example
All	boolean	bool			If no pagination parameters are provided, defaults to true and returns all available results.	
CVEID	string	string			An optional CVE ID that the image and source must contain. Only packages, and their images and sources, with this CVE ID will be returned. If both package name and CVE ID are provided, then only the images and sources with the specified package name and CVE ID will be returned.	CVE-7467-2020
Digests	[]string	[]string			A list of image digests. At least one image digest or source sha must be provided.	["9n38274ods897fmay487gsdyfga678wr82","7n38274ods897fmay487gsdyfga678wr82"]
PackageName	string	string			An optional package name that the image and source must contain. Only packages, and their images and sources, with this name will be returned. If both package name and CVE ID are provided, then only the images and sources with the specified package name and CVE ID will be returned.	package1
Page	int64 (formatted integer)	int64		1		
PageSize	int64 (formatted integer)	int64		20		

Name	Type	Go type	Required	Default	Description	Example
Shas	[]string	[]string			A list of source shas. At least one image digest or source sha must be provided.	<pre>["sha256:2c11624a8d9c9071996a886a4acaf09939ef3386e4c07735c6a2532f02eed4ea","sha256:04baf0e0d8df23ec342edb72acc3fb02f61c418bc6e8d7093149956a9aad2d12a"]</pre>

ArtifactGroupSearchPackagePostResponse

Properties

Name	Type	Go type	Required	Default	Description	Example
Homepage	string	string			URL of the package's homepage	<pre>https://github.com/jackc/pgconn</pre>
ID	uint64 (formatted integer)	uint64			Package ID	12
Name	string	string			Name of the package	<pre>github.com/jackc/pgconn</pre>
Package Manager	string	string			Package manager used to install, upgrade, configure, and remove the package	Go
Version	string	string			Version of the package	v1.13.0
Vulnerabilities	[]VulnerabilityResponse	[]*VulnerabilityResponse				

ArtifactGroupSearchPostResponse

Properties

Name	Type	Go type	Required	Default	Description	Example
Entities	[]ArtifactGroupSearchEntityPostResponse	[]*ArtifactGroupSearchEntityPostResponse			Entities associated with the Artifact Group	
Labels	map of string	map[string]string			Key-Value pair of labels associated with the Artifact Group	<pre>{"env":"production","namespace":"default"}</pre>
Report UID	string	string			Unique identifier for the report	
UID	string	string			Unique identifier for the Artifact Group such as workload UID	<pre>8b1cc5da-fabe-45a6-ab8c-49260bbeef99</pre>

ArtifactGroupVulnReachFiltersPostRequest

Properties

Name	Type	Go type	Required	Default	Description	Example
All	boolean	<code>bool</code>			If no pagination parameters are provided, defaults to true and returns all available results.	
Digests	<code>[]string</code>	<code>[]string</code>			A list of image digests.	<code>["sha256:2c11624a8d9c9071996a886a4acaf09939ef3386e4c07735c6a2532f02eed4ea", "sha256:04baf0d8df23ec342edb72acc3fb02f61c418bc6e8d7093149956a9aad2d12a"]</code>
Page	int64 (formatted integer)	<code>int64</code>		1		
PageSize	int64 (formatted integer)	<code>int64</code>		20		
Severities	<code>[]string</code>	<code>[]string</code>			Optional list of severities to filter vulnerabilities on. Possible values are: low, medium, high, critical, unknown.	<code>["critical", "high"]</code>
Shas	<code>[]string</code>	<code>[]string</code>			A list of source shas.	<code>["9n38274ods897fmay487gsdyfga678wr82", "7n38274ods897fmay487gsdyfga678wr82"]</code>

ArtifactGroupVulnReachPostResponse

Properties

Name	Type	Go type	Required	Default	Description	Example
AgCount	uint64 (formatted integer)	<code>uint64</code>			Number of artifact groups affected by the vulnerability	5
Vulnerability	VulnerabilityResponse	<code>VulnerabilityResponse</code>				

ArtifactGroupVulnSearchFilters

Properties

Name	Type	Go type	Required	Default	Description	Example
All	boolean	<code>bool</code>			If no pagination parameters are provided, defaults to true and returns all available results.	

Name	Type	Go type	Required	Default	Description	Example
ArtifactGroup UID	string	string			An optional artifact group UID that the image and source must contain. Only artifact groups, and their images and sources, with this artifact group UID will be returned. If both package name and artifact group UID are provided, then only the images and sources with the specified package name and artifact group UID will be returned.	9aa3548e-5fae-11ed-9b6a-0242ac120002
Digests	[]string	[]string			A list of image digests. At least one image digest or source sha must be provided.	["9n38274ods897fmay487gsdyfga678wr82", "7n38274ods897fmay487gsdyfga678wr82"]
PackageName	string	string			An optional package name that the image and source must contain. Only packages, and their images and sources, with this name will be returned. If both package name and artifact group UID are provided, then only the images and sources with the specified package name and artifact group UID will be returned.	package1
Page	int64 (formatted integer)	int64		1		
PageSize	int64 (formatted integer)	int64		20		
Shas	[]string	[]string			A list of source shas. At least one image digest or source sha must be provided.	["sha256:2c11624a8d9c9071996a886a4acaf09939ef3386e4c07735c6a2532f02eed4ea", "sha256:04baf0d8df23ec342edb72acc3fb02f61c418bc6e8d7093149956a9aad2d12a"]

ArtifactGroupVulnSearchPostResponse

Properties

Name	Type	Go type	Required	Default	Description	Example
ArtifactGroups	[]ArtifactGroupResponse	[]*ArtifactGroupResponse				
CNA	string	string			CVE Numbering Authority	GitHub, Inc.
CVEID	string	string			CVE ID of the vulnerability	CVE-7467-2020

Name	Type	Go type	Required	Default	Description	Example
Description	string	<code>string</code>			Description of the vulnerability	IBM Datapower Gateway 10.0.2.0 through 10.0.4.0, 10.0.1.0 through 10.0.1.5, and 2018.4.1.0 through 2018.4.1.18 could allow unauthorized viewing of logs and files due to insufficient authorization checks. IBM X-Force ID: 218856.
ID	uint64 (formatted integer)	<code>uint64</code>			Vulnerability ID	12
Packages	<code>[]PackageResponse</code>	<code>[]*PackageResponse</code>				
Rating	<code>[]RatingResponse</code>	<code>[]*RatingResponse</code>			Rating information	
References	<code>[]string</code>	<code>[]string</code>			Additional external links	<code>["https://github.com/example/repo/issues/11", "https://github.com/example/issues/31"]</code>
URL	string	<code>string</code>			Related url to the vulnerability	<code>https://nvd.nist.gov/vuln/detail/CVE-7467-2020</code>

BaseArtifactGroupResponse

`interface{}`

BaseEntityResponse

`interface{}`

BasePackageResponse

`interface{}`

BaseRatingResponse

`interface{}`

BaseReportResponse

`interface{}`

BaseVulnerabilityResponse

`interface{}`

DeletedAt

- composed type `NullTime`

EntityCreatePostResponse

Properties

Name	Type	Go type	Required	Default	Description	Example
ID	uint64 (formatted integer)	uint64	✓		The database ID of the source or image	24
Type	string	string	✓		The entity Type of scan that is stored. This is set to either "image" or "source".	image

EntityResponse

Properties

Name	Type	Go type	Required	Default	Description	Example
Digest	string	string			The digest of the image entity. Only visible if the entity is of image type	sha256:f7de1564f13da1ef7e5720ebce14006793242c0d8d7d60c343632bcf3bc5306d
Host	string	string			The dns name where the source entity is hosted on. Only visible if the entity type is of source type	gitlab.com
ID	uint64 (formatted integer)	uint64	✓		The database ID of the source or image	24
Name	string	string			The name of the image entity. Only visible if the entity is of image type	checkr/flagr
Org	string	string			The organization name of the source entity. Only visible if the entity type is of source type	my-organization
Registry	string	string			The DNS name of the registry that stores the image entity. Only visible if the entity is of image type	docker.io
Repo	string	string			The repository name of the source entity. Only visible if the entity type is of source type	my-sample-repo
Sha	string	string			The commit sha of the source entity. Only visible if the entity type is of source type	d6cd1e2bd19e03a81132a23b2025920577f84e37
Type	string	string	✓		The entity Type of scan that is stored. This is set to either "image" or "source"	image

ErrorMessage

ErrorMessage wraps an error message in a struct so responses are properly marshalled as a JSON object.

Properties

Name	Type	Go type	Required	Default	Description	Example
Message	string	string			in: body	something went wrong

GetVulnerabilityAnalysisResponse

Properties

Name	Type	Go type	Required	Default	Description	Example
Analysis	[]VAAnalysisResponse	<code>[]*VAAnalysisResponse</code>	✓		A collection of analyses regarding the applicability and response to the detected vulnerability	
ArtifactGroupUID	string	<code>string</code>			Unique user identifier for the artifact group	<code>workload-11</code>
CreatedBy	string	<code>string</code>			The identity of the person responsible for creating the triage	<code>John Doe</code>
UID	string	<code>string</code>	✓		Unique identifier for the vulnerability analysis	<code>8b1cc5da-fabe-45a6-ab8c-49260bbeef99</code>
image	VAImageResponse	<code>VAImageResponse</code>				
package	VAPackageResponse	<code>VAPackageResponse</code>	✓			
source	VASourceResponse	<code>VASourceResponse</code>				
vulnerability	VAVulnerabilityResponse	<code>VAVulnerabilityResponse</code>	✓			

Image

Properties

Name	Type	Go type	Required	Default	Description	Example
Digest	string	<code>string</code>	✓			<code>9n38274ods897fmay487gsdyfga678wr82</code>
ID	uint64 (formatted integer)	<code>uint64</code>				
Name	string	<code>string</code>	✓			<code>myorg/application</code>
Packages	[]Package	<code>[]*Package</code>				
Registry	string	<code>string</code>	✓			<code>docker.io</code>
Sources	[]Source	<code>[]*Source</code>				

MethodType

Properties

Name	Type	Go type	Required	Default	Description	Example
CreatedAt	date-time (formatted string)	<code>strfmt.DateTime</code>				
DeletedAt	DeletedAt	<code>DeletedAt</code>				

Name	Type	Go type	Required	Default	Description	Example
ID	uint64 (formatted integer)	<code>uint64</code>				
Name	string	<code>string</code>				
Rating	<code>[]Rating</code>	<code>[]*Rating</code>				
UpdatedAt	date-time (formatted string)	<code>strfmt.DateTime</code>				

Model

```
type User struct { gorm.Model }
```

Properties

Name	Type	Go type	Required	Default	Description	Example
CreatedAt	date-time (formatted string)	<code>strfmt.DateTime</code>				
DeletedAt	<code>DeletedAt</code>	<code>DeletedAt</code>				
ID	uint64 (formatted integer)	<code>uint64</code>				
UpdatedAt	date-time (formatted string)	<code>strfmt.DateTime</code>				

NullTime

NullTime implements the Scanner interface so it can be used as a scan destination, similar to NullString.

Properties

Name	Type	Go type	Required	Default	Description	Example
Time	date-time (formatted string)	<code>strfmt.DateTime</code>				
Valid	boolean	<code>bool</code>				

Package

Properties

Name	Type	Go type	Required	Default	Description	Example
Homepage	string	<code>string</code>				
ID	uint64 (formatted integer)	<code>uint64</code>				
Images	<code>[]Image</code>	<code>[]*Image</code>				
Name	string	<code>string</code>				
PackageManager	string	<code>string</code>				
Sources	<code>[]Source</code>	<code>[]*Source</code>				
Version	string	<code>string</code>				
Vulnerabilities	<code>[]Vulnerability</code>	<code>[]*Vulnerability</code>				

PackageResponse

Properties

Name	Type	Go type	Required	Default	Description	Example
Homepage	string	<code>string</code>			URL of the package's homepage	<code>https://github.com/jackc/pgconn</code>
ID	uint64 (formatted integer)	<code>uint64</code>			Package ID	<code>12</code>
Name	string	<code>string</code>			Name of the package	<code>github.com/jackc/pgconn</code>
PackageManager	string	<code>string</code>			Package manager used to install, upgrade, configure, and remove the package	<code>Go</code>
Version	string	<code>string</code>			Version of the package	<code>v1.13.0</code>

PaginatedArtifactGroupSearchPostResponse

Properties

Name	Type	Go type	Required	Default	Description	Example
Count	int64 (formatted integer)	<code>int64</code>			Total number of results of all combined pages	<code>10</code>
CurrentPage	int64 (formatted integer)	<code>int64</code>			Current page of results to return	<code>1</code>
LastPage	int64 (formatted integer)	<code>int64</code>			Last page which contains results	<code>2</code>
PageSize	int64 (formatted integer)	<code>int64</code>			Number of results returned per request	<code>20</code>
Results	[]ArtifactGroupSearchPostResponse	<code>[]*ArtifactGroupSearchPostResponse</code>				

PaginatedArtifactGroupVulnReachPostResponse

Properties

Name	Type	Go type	Required	Default	Description	Example
Count	int64 (formatted integer)	<code>int64</code>			Total number of results of all combined pages	<code>10</code>
CurrentPage	int64 (formatted integer)	<code>int64</code>			Current page of results to return	<code>1</code>
LastPage	int64 (formatted integer)	<code>int64</code>			Last page which contains results	<code>2</code>
PageSize	int64 (formatted integer)	<code>int64</code>			Number of results returned per request	<code>20</code>
Results	[]ArtifactGroupVulnReachPostResponse	<code>[]*ArtifactGroupVulnReachPostResponse</code>				

PaginatedArtifactGroupVulnSearchPostResponse

Properties

Name	Type	Go type	Required	Default	Description	Example
Count	int64 (formatted integer)	<code>int64</code>			Total number of results of all combined pages	10
CurrentPage	int64 (formatted integer)	<code>int64</code>			Current page of results to return	1
LastPage	int64 (formatted integer)	<code>int64</code>			Last page which contains results	2
PageSize	int64 (formatted integer)	<code>int64</code>			Number of results returned per request	20
Results	<code>[]ArtifactGroupVulnSearchPostResponse</code>	<code>[]*ArtifactGroupVulnSearchPostResponse</code>				

PaginatedResponse

Properties

Name	Type	Go type	Required	Default	Description	Example
Count	int64 (formatted integer)	<code>int64</code>			Total number of results of all combined pages	10
CurrentPage	int64 (formatted integer)	<code>int64</code>			Current page of results to return	1
LastPage	int64 (formatted integer)	<code>int64</code>			Last page which contains results	2
PageSize	int64 (formatted integer)	<code>int64</code>			Number of results returned per request	20
Results	<code>[]interface{} (#interface)</code>	<code>[]interface{}</code>				

PaginatedSearchReportResponse

Properties

Name	Type	Go type	Required	Default	Description	Example
Count	int64 (formatted integer)	<code>int64</code>			Total number of results of all combined pages	10
CurrentPage	int64 (formatted integer)	<code>int64</code>			Current page of results to return	1
LastPage	int64 (formatted integer)	<code>int64</code>			Last page which contains results	2
PageSize	int64 (formatted integer)	<code>int64</code>			Number of results returned per request	20
Results	<code>[]SearchReportResponse</code>	<code>[]*SearchReportResponse</code>				

PaginatedVulnerabilityAnalysisResponse

Properties

Name	Type	Go type	Required	Default	Description	Example
Count	int64 (formatted integer)	<code>int64</code>			Total number of results of all combined pages	10
CurrentPage	int64 (formatted integer)	<code>int64</code>			Current page of results to return	1
LastPage	int64 (formatted integer)	<code>int64</code>			Last page which contains results	2
PageSize	int64 (formatted integer)	<code>int64</code>			Number of results returned per request	20
Results	<code>[]GetVulnerabilityAnalysisResponse</code>	<code>[]*GetVulnerabilityAnalysisResponse</code>				

Rating

Properties

Name	Type	Go type	Required	Default	Description	Example
ID	uint64 (formatted integer)	<code>uint64</code>				
MethodType	<code>MethodType</code>	<code>MethodType</code>				
MethodTypeID	uint64 (formatted integer)	<code>uint64</code>				
Score	double (formatted number)	<code>float64</code>				
Severity	string	<code>string</code>				
Vector	string	<code>string</code>				

RatingResponse

Properties

Name	Type	Go type	Required	Default	Description	Example
ID	uint64 (formatted integer)	<code>uint64</code>			Rating ID	3
MethodTypeID	uint64 (formatted integer)	<code>uint64</code>			ID of the method used to score the Rating. 1: CVSSv2, 2: CVSSv3, 4: CVSSv31, 5: OWASP, all other ids: Unknown	1
Score	double (formatted number)	<code>float64</code>			CVSS score	9.7
Severity	string	<code>string</code>			Threat level of vulnerability	High
Vector	string	<code>string</code>			CVSS score in vector format	<code>AV:L/AC:L/Au:N/C:C/I:C/A:C</code>

ReportArtifactGroupResponse

Properties

Name	Type	Go type	Required	Default	Description	Example
Labels	map of string	map[string]string			Key-Value pair of labels associated with the Artifact Group	<code>{"env": "production", "namespace": "default"}</code>
UID	string	string			Unique identifier for the Artifact Group such as workload UID	<code>8b1cc5da-fabe-45a6-ab8c-49260bbeef99</code>

ReportEntityResponse

Properties

Name	Type	Go type	Required	Default	Description	Example
Artifact Groups	<code>[]ReportArtifactGroupResponse</code>	<code>[]*ReportArtifactGroupResponse</code>			The artifact group this report is part of	
Digest	string	string			The digest of the image entity. Only visible if the entity is of image type	<code>sha256:f7de1564f13da1ef7e5720ebce14006793242c0d8d7d60c343632bcf3bc5306d</code>
Host	string	string			The dns name where the source entity is hosted on. Only visible if the entity type is of source type	<code>gitlab.com</code>
Name	string	string			The name of the image entity. Only visible if the entity is of image type	<code>checkr/flagr</code>
Org	string	string			The organization name of the source entity. Only visible if the entity type is of source type	<code>my-organization</code>
Packages	<code>[]ReportPackageResponse</code>	<code>[]*ReportPackageResponse</code>			List of packages that are associated with the report	
Registry	string	string			The DNS name of the registry that stores the image entity. Only visible if the entity is of image type	<code>docker.io</code>
Repo	string	string			The repository name of the source entity. Only visible if the entity type is of source type	<code>my-sample-repo</code>
Sha	string	string			The commit sha of the source entity. Only visible if the entity type is of source type	<code>d6cd1e2bd19e03a81132a23b2025920577f84e37</code>
Type	string	string	✓		The entity Type of scan that is stored. This is set to either "image" or "source"	<code>image</code>

ReportPackageResponse

Properties

Name	Type	Go type	Required	Default	Description	Example
Homepage	string	string			URL of the package's homepage	https://github.com/jackc/pgconn
Name	string	string			Name of the package	github.com/jackc/pgconn
Package Manager	string	string			Package manager used to install, upgrade, configure, and remove the package	Go
Version	string	string			Version of the package	v1.13.0
Vulnerabilities	[]ReportVulnerabilityResponse	[]*ReportVulnerabilityResponse			List of vulnerabilities associated with this package that were surfaced in this report	

ReportRatingResponse

Properties

Name	Type	Go type	Required	Default	Description	Example
MethodType	string	string			Method used to score the Rating	CVSSv2
Score	double (formatted number)	float64			CVSS score	9.7
Severity	string	string			Threat level of vulnerability	High
Vector	string	string			CVSS score in vector format	AV:L/AC:L/Au:N/C:C/II:C/A:C

ReportResponse

Properties

Name	Type	Go type	Required	Default	Description	Example
GeneratedAt	string	string			The date and time this report was submitted to the Store. Time format is in ISO 8601	2006-01-02T15:04:05Z07:00
OriginalLocation	string	string			The OCI registry location of the original SBOM vulnerability scan that generated this report	k8s-minikube/kicbase@sha256:be897edc9ed473a9678010f390a0092f488f6a1c30865f571c3b6388f9f56f9b
UID	string	string			The unique identifier of the report	6b96a6ff-248d-4c36-b385-93c3813e1e86
entity	ReportEntityResponse	ReportEntityResponse				
tool	ReportToolResponse	ReportToolResponse				

ReportToolResponse

Properties

Name	Type	Go type	Required	Default	Description	Example
Name	string	string			The name of the tool that generated the original SBOM report	Grype
Vendor	string	string			The name of the vendor of the tool that generated the original SBOM report	Anchore
Version	string	string			The version of the tool that generated the original SBOM report	v0.61.1

ReportVulnerabilityResponse

Properties

Name	Type	Go type	Required	Default	Description	Example
CNA	string	string			CVE Numbering Authority	GitHub, Inc.
CVEID	string	string			CVE ID of the vulnerability	CVE-7467-2020
Description	string	string			Description of the vulnerability	IBM Datapower Gateway 10.0.2.0 through 10.0.4.0, 10.0.1.0 through 10.0.1.5, and 2018.4.1.0 through 2018.4.1.18 could allow unauthorized viewing of logs and files due to insufficient authorization checks. IBM X-Force ID: 218856.
Ratings	[]ReportRatingResponse	[]*ReportRatingResponse			List of ratings associated with this vulnerability that were surfaced in this report	
References	[]string	[]string			Additional external links	["https://github.com/example/repo/issues/11", "https://github.com/example/repo/issues/31"]
URL	string	string			Related url to the vulnerability	https://nvd.nist.gov/vuln/detail/CVE-7467-2020

SearchReportResponse

Properties

Name	Type	Go type	Required	Default	Description	Example
EntityID	uint64 (formatted integer)	uint64			The database ID of the source or image being associated with this report	24
EntityType	string	string			The entity type of scan that is stored. This is set to either "image" or "source"	image
GeneratedAt	string	string			The date and time this report was submitted to the Store. Time format is in ISO 8601	2006-01-02T15:04:05Z07:00

Name	Type	Go type	Required	Default	Description	Example
Original Location	string	string			The OCI registry location of the original SBOM vulnerability scan that generated this report	k8s-minikube/kicbase@sha256:b e897edc9ed473a9678010f390 a0092f488f6a1c30865f571c3 b6388f9f56f9b
UID	string	string			The unique identifier of the report	6b96a6ff-248d-4c36-b385- 93c3813e1e86
artifact_group	ReportArtifactGroupResponse	ReportArtifactGroupResponse				
tool	ReportToolResponse	ReportToolResponse				

Source

Properties

Name	Type	Go type	Required	Default	Description	Example
DeletedAt	DeletedAt	DeletedAt				
Host	string	string				gitlab.com
ID	uint64 (formatted integer)	uint64				
Images	[]Image	[]*Image				
Organization	string	string				vmware
Packages	[]Package	[]*Package				
Repository	string	string	✓			myproject
Sha	string	string	✓			0eb5fcd1

StringArray

[]string

V1ImagePostResponse

Properties

Name	Type	Go type	Required	Default	Description	Example
Digest	string	string			The sha256 digest of the image	sha256:2b46bcf70f38c314637 0208d547db81e548437a40b4b2 3326b0135330d62c2a0
ID	int64 (formatted integer)	int64			The database ID of the image.	24
Name	string	string			The name of the image repository containing the image	anchore/grype

Name	Type	Go type	Required	Default	Description	Example
Registry	string	string			The registry name where the image is hosted.	my-sample-repo
Report Uid	string	string			The report's unique identifier associated with the data submitted by this image	6b96a6ff-248d-4c36-b385-93c3813e1e86

V1SourcePostResponse

Properties

Name	Type	Go type	Required	Default	Description	Example
Host	string	string			The dns name where the source is hosted.	gitlab.com
ID	int64 (formatted integer)	int64			The database ID of the source.	24
Organization	string	string			The organization name of the source.	my-organization
ReportUID	string	string			The global unique identifier for the report.	1234abcd-1234-1234-1234-123456abcdef
Repository	string	string			The repository name of the source.	my-sample-repo
Sha	string	string			The commit sha of the source.	d6cd1e2bd19e03a81132a23b2025920577f84e37

VAAAnalysisResponse

Properties

Name	Type	Go type	Required	Default	Description	Example
Comments	string	string			Free form comments for the analysis	Lorem ipsum dolor sit amet
Created By	string	string			Author of the vulnerability analysis	John Doe
Justification	string	string			The rationale of why the analysis state was asserted	code_not_present
Response	[]string	[]string			A response to the vulnerability by the manufacturer, supplier, or project responsible for the affected component or service	
State	string	string	✓		Triage analysis state	in_triage

VAIImageResponse

Properties

Name	Type	Go type	Required	Default	Description	Example
Digest	string	string	✓		The digest of the image	sha256:f7de1564f13da1ef7e5720ebce14006793242c0d8d7d60c343632bcf3bc5306d
Name	string	string	✓		The name of the image repository containing the image	anchore/grype
Registry	string	string			The DNS name of the registry that stores the image	docker.io

VAPackageResponse

Properties

Name	Type	Go type	Required	Default	Description	Example
Name	string	string	✓		OS or Application package name	libc
PackageManager	string	string	✓		Package manager used to install, upgrade, configure, and remove the package	Go
Version	string	string	✓		OS or Application package version	0.0.1

VASourceResponse

Properties

Name	Type	Go type	Required	Default	Description	Example
Org	string	string			The organization name of the source entity	my-organization
Repo	string	string			The repository name of the source	my-sample-repo
Sha	string	string	✓		The commit sha of the source	d6cd1e2bd19e03a81132a23b2025920577f84e37

VAVulnerabilityResponse

Properties

Name	Type	Go type	Required	Default	Description	Example
CVEID	string	string	✓		Unique identifier of the vulnerability	CVE-2020-0001
Description	string	string			A description of the vulnerability identified by the CVEID	An attacker who can control log messages or log message parameters can execute arbitrary code loaded

Vulnerability

Properties

Name	Type	Go type	Required	Default	Description	Example
CNA	string	string				GitHub, Inc.
CVEID	string	string	✓			CVE-7467-2020
Description	string	string				A description of CVE-7467-2020
ID	uint64 (formatted integer)	uint64				
Packages	[]Package	[]*Package				
Ratings	[]Rating	[]*Rating				
References	StringArray	StringArray				
URL	string	string				https://nvd.nist.gov/vuln/detail/CVE-7467-2020

VulnerabilityAnalysisCopyRequest

Properties

Name	Type	Go type	Required	Default	Description	Example
ArtifactGroupUid	string	string			UID of Workload linked to the image or source	8b1cc5da-fabe-45a6-ab8c-49260bbeef99
CreatedBy	string	string			User calling in the endpoint	someone@fake.org
image	AnalysisInstanceImageDependency	AnalysisInstanceImageDependency				
source	AnalysisInstanceSourceDependency	AnalysisInstanceSourceDependency				

VulnerabilityAnalysisRequest

- composed type [VulnerabilityAnalysisCopyRequest](#)
- inlined member (*AO1*)

Properties

Name	Type	Go type	Required	Default	Description	Example
analysis	AnalysisRequest	AnalysisRequest				
package	AnalysisInstancePackageDependency	AnalysisInstancePackageDependency	✓			
vulnerability	Vulnerability	Vulnerability	✓			

Inlined models

Vulnerability

Vulnerability to triage

Properties

Name	Type	Go type	Required	Default	Description	Example
CVEID	string	string			Unique identifier of the vulnerability	CVE-2020-0001

VulnerabilityResponse

Properties

Name	Type	Go type	Required	Default	Description	Example
CNA	string	string			CVE Numbering Authority	GitHub, Inc.
CVEID	string	string			CVE ID of the vulnerability	CVE-7467-2020
Description	string	string			Description of the vulnerability	IBM Datapower Gateway 10.0.2.0 through 10.0.4.0, 10.0.1.0 through 10.0.1.5, and 2018.4.1.0 through 2018.4.1.18 could allow unauthorized viewing of logs and files due to insufficient authorization checks. IBM X-Force ID: 218856.
ID	uint64 (formatted integer)	uint64			Vulnerability ID	12
Rating	[]RatingResponse	[]*RatingResponse			Rating information	
References	[]string	[]string			Additional external links	["https://github.com/example/repo/issues/11", "https://github.com/example/repo/issues/31"]
URL	string	string			Related url to the vulnerability	https://nvd.nist.gov/vuln/detail/CVE-7467-2020

paginatedImageResponse

Properties

Name	Type	Go type	Required	Default	Description	Example
Count	int64 (formatted integer)	int64			Total number of results of all combined pages	10
CurrentPage	int64 (formatted integer)	int64			Current page of results to return	1
LastPage	int64 (formatted integer)	int64			Last page which contains results	2
PageSize	int64 (formatted integer)	int64			Number of results returned per request	20

Name	Type	Go type	Required	Default	Description	Example
Results	[]ResponseImage	<code>[]*ResponseImage</code>				

paginatedPackageResponse

Properties

Name	Type	Go type	Required	Default	Description	Example
Count	int64 (formatted integer)	<code>int64</code>			Total number of results of all combined pages	10
CurrentPage	int64 (formatted integer)	<code>int64</code>			Current page of results to return	1
LastPage	int64 (formatted integer)	<code>int64</code>			Last page which contains results	2
PageSize	int64 (formatted integer)	<code>int64</code>			Number of results returned per request	20
Results	[]ResponsePackage	<code>[]*ResponsePackage</code>				

paginatedSourceResponse

Properties

Name	Type	Go type	Required	Default	Description	Example
Count	int64 (formatted integer)	<code>int64</code>			Total number of results of all combined pages	10
CurrentPage	int64 (formatted integer)	<code>int64</code>			Current page of results to return	1
LastPage	int64 (formatted integer)	<code>int64</code>			Last page which contains results	2
PageSize	int64 (formatted integer)	<code>int64</code>			Number of results returned per request	20
Results	[]ResponseSource	<code>[]*ResponseSource</code>				

paginatedVulnerabilityResponse

Properties

Name	Type	Go type	Required	Default	Description	Example
Count	int64 (formatted integer)	<code>int64</code>			Total number of results of all combined pages	10
CurrentPage	int64 (formatted integer)	<code>int64</code>			Current page of results to return	1
LastPage	int64 (formatted integer)	<code>int64</code>			Last page which contains results	2
PageSize	int64 (formatted integer)	<code>int64</code>			Number of results returned per request	20

Name	Type	Go type	Required	Default	Description	Example
Results	[]ResponseVulnerability	<code>[]*ResponseVulnerability</code>				

responseImage

Properties

Name	Type	Go type	Required	Default	Description	Example
CreatedAt	date-time (formatted string)	<code>strfmt.DateTime</code>				
Digest	string	<code>string</code>	✓			<code>9n38274ods897fmay487gsdyfga678wr82</code>
ID	uint64 (formatted integer)	<code>uint64</code>				
Name	string	<code>string</code>	✓			<code>myorg/application</code>
Packages	[]Package	<code>[]*Package</code>				
Registry	string	<code>string</code>	✓			<code>docker.io</code>
Sources	[]Source	<code>[]*Source</code>				
UpdatedAt	date-time (formatted string)	<code>strfmt.DateTime</code>				

responsePackage

Properties

Name	Type	Go type	Required	Default	Description	Example
CreatedAt	date-time (formatted string)	<code>strfmt.DateTime</code>				
Homepage	string	<code>string</code>				
ID	uint64 (formatted integer)	<code>uint64</code>				
Images	[]Image	<code>[]*Image</code>				
Name	string	<code>string</code>				
PackageManager	string	<code>string</code>				
Sources	[]Source	<code>[]*Source</code>				
UpdatedAt	date-time (formatted string)	<code>strfmt.DateTime</code>				
Version	string	<code>string</code>				
Vulnerabilities	[]Vulnerability	<code>[]*Vulnerability</code>				

responseSource

Properties

Name	Type	Go type	Required	Default	Description	Example
CreatedAt	date-time (formatted string)	<code>strfmt.DateTime</code>				
DeletedAt	DeletedAt	<code>DeletedAt</code>				

Name	Type	Go type	Required	Default	Description	Example
Host	string	<code>string</code>				<code>gitlab.com</code>
ID	uint64 (formatted integer)	<code>uint64</code>				
Images	<code>[]Image</code>	<code>[]*Image</code>				
Organization	string	<code>string</code>				<code>vmware</code>
Packages	<code>[]Package</code>	<code>[]*Package</code>				
Repository	string	<code>string</code>	✓			<code>myproject</code>
Sha	string	<code>string</code>	✓			<code>0eb5fcd1</code>
UpdatedAt	date-time (formatted string)	<code>strfmt.DateTime</code>				

responseVulnerability

Properties

Name	Type	Go type	Required	Default	Description	Example
CNA	string	<code>string</code>				<code>GitHub, Inc.</code>
CVEID	string	<code>string</code>	✓			<code>CVE-7467-2020</code>
Created At	date-time (formatted string)	<code>strfmt.DateTime</code>				
Description	string	<code>string</code>				<code>A description of CVE-7467-2020</code>
ID	uint64 (formatted integer)	<code>uint64</code>				
Packages	<code>[]Package</code>	<code>[]*Package</code>				
Ratings	<code>[]Rating</code>	<code>[]*Rating</code>				
References	<code>StringArray</code>	<code>StringArray</code>				
URL	string	<code>string</code>				<code>https://nvd.nist.gov/vuln/detail/CVE-7467-2020</code>
UpdatedAt	date-time (formatted string)	<code>strfmt.DateTime</code>				

API walkthrough for Supply Chain Security Tools - Store

This topic tells you how to make an API call that you can use with Supply Chain Security Tools (SCST) - Store. For information about using the SCST - Store API, see [API reference for Supply Chain Security Tools - Store](#).

Use curl to post an image report

This procedure uses Ingress, if Tanzu Application Platform is deployed without Ingress, see [Use your NodePort with Supply Chain Security Tools - Store](#) and [Use your LoadBalancer with Supply Chain Security Tools - Store](#). Complete the following steps:

1. Switch to the `kubectl` context or `kubeconfig` to target the View cluster.

- Retrieve the CA certificate and store it locally. Run:

```
kubectl get secret ingress-cert -n metadata-store -o json | jq -r '.data."ca.crt"' | base64 -d > /tmp/ca.crt
```

- Using the `health` endpoint as an example, run:

```
curl -i https://metadata-store.INGRESS-DOMAIN/api/HEALTH \
--cacert /tmp/ca.crt
```

For example:

```
$ curl -i https://metadata-store.example.com/api/health \
--cacert /tmp/ca.crt

HTTP/2 200
content-length: 0
date: Tue, 23 Jan 2024 22:50:57 GMT
x-envoy-upstream-service-time: 0
server: envoy
```

- To make a request to an authenticated endpoint an access token is required. To retrieve the `metadata-store-read-write-client` access token, run:

```
export METADATA_STORE_ACCESS_TOKEN=$(kubectl get secrets metadata-store-read-write-client -n metadata-store -o jsonpath="{.data.token}" | base64 -d)
```

For more information, see [Retrieve access tokens for Supply Chain Security Tools - Store](#).

- Using the `api/imageReport` endpoint as an example, create a post request:

```
curl https://metadata-store.INGRESS-DOMAIN/API/IMAGE-REPORT \
--cacert /tmp/ca.crt \
-H "Authorization: Bearer ${METADATA_STORE_ACCESS_TOKEN}" \
-H "Content-Type: application/json" \
-X POST \
--data "@ABSOLUTE-PATH-TO-THE-POST-BODY"
```

Where `ABSOLUTE-PATH-TO-THE-POST-BODY` is the absolute filepath of the API JSON for an image report.

For example, the following is a sample post body of an image report API JSON:

```
{
  "Name" : "burger-image-2",
  "Registry" : "test-registry",
  "Digest" : "test-digest@45asd61asasssdfsdfddssghjkdfsdffasdfsdsdasdsdassdfghjdd
asfddfsadfadfgfshdasdfsdfsdsdasdsdfsdfadssdfdasdfaasdsdfsddfsdasgsasddffdgf
dasddfgdfssdfakasdadasdsdasddasdsd23",
  "Sources" : [
    {
      "Repository" : "aaaaoslfdfggo",
      "Organization" : "pivotal",
      "Sha" : "1235assdfssadfacfddxdf41",
      "Host" : "http://oslo.io",
      "Packages" : [
        {
          "Name" : "Source package5",
          "Version" : "v2sfsfdd34",
          "PackageManager" : "test-manager",
          "Vulnerabilities" : [
            {
              "CVEID" : "0011",
```

```

        "PrimaryURL" : "http://www.mynamejeff.comm",
        "Description" : "Bye",
        "CNA" : "NVD",
        "Ratings": [{
            "Vector" : "AV:L/AC:L/Au:N/C:P/I:P/A:P",
            "Score" : 0,
            "MethodTypeID" : 1,
            "Severity": "High"
        }],
        "References" : [""]
    }
}
]
}
]
}
],
"Packages" : [
{
    "Name" : "bob-dependency-35daasds56j",
    "Version" : "v2",
    "PackageManager" : "test-manager",
    "Vulnerabilities" : [
        {
            "CVEID" : "002",
            "PrimaryURL" : "http://www.mynamejeff.comm",
            "Description" : "Bye",
            "CNA" : "NVD",
            "Ratings": [{
                "Vector" : "AV:L/AC:L/Au:N/C:P/I:P/A:P",
                "Score" : 0,
                "MethodTypeID" : 1,
                "Severity": "High"
            }],
            "References" : [""]
        }
    ]
}
]
}
]
}

```

Connecting to the PostgreSQL Database

This topic tells you how to connect to the PostgreSQL database. To connect to the PostgreSQL database, you need the following values:

- database name
- user name
- password
- database host
- database port
- database CA certificate
- To obtain the database name, user name, password, and CA certificate, run these commands:

```

db_name=$(kubectl get secret postgres-db-secret -n metadata-store -o json | jq
-r '.data.POSTGRES_DB' | base64 -d)
db_username=$(kubectl get secret postgres-db-secret -n metadata-store -o json |
jq -r '.data.POSTGRES_USER' | base64 -d)
db_password=$(kubectl get secret postgres-db-secret -n metadata-store -o json |
jq -r '.data.POSTGRES_PASSWORD' | base64 -d)

```

```
db_ca_dir=$(mktemp -d -t ca-cert-XXXX)
db_ca_path="$db_ca_dir/ca.crt"
kubectl get secrets postgres-db-tls-cert -n metadata-store -o json | jq -r '.data."ca.crt"' | base64 -d > $db_ca_path
```

If the password was auto-generated, the earlier `password` command returns an empty string. Instead, run:

```
db_password=$(kubectl get secret postgres-db-password -n metadata-store -o json | jq -r '.data.DB_PASSWORD' | base64 -d)
```

- In a separate terminal, run:

```
kubectl port-forward service/metadata-store-db 5432:5432 -n metadata-store
```

- Set the database host and port values on the first terminal by running:

```
db_host="localhost"
db_port=5432
```

- To port forward to a different local port number, use this command template:

```
kubectl port-forward service/metadata-store-db <LOCAL_PORT>:5432 -n metadata-store
```

With this setup, you can now connect to the database and make queries as in the following example:

```
$ psql "host=$db_host port=$db_port user=$db_username dbname=$db_name sslmode=verify-ca \
sslrootcert=$db_ca_path" -c "SELECT * FROM images"
```

You can also use GUI clients, such as [Postico](#) or [DBeaver](#) to interact with the database.

Deployment details and configuration for Supply Chain Security Tools - Store

This topic describes how you can deploy and configure your Kubernetes cluster for Supply Chain Security Tools (SCST) - Store.

What is deployed

The installation creates the following in your Kubernetes cluster:

- Four components:
 - `metadata-store` API back end
 - Database
 - AMR API back end. If AMR is deployed, see [Deploying AMR](#).
 - AMR CloudEvent Handler. If AMR is deployed, see [Deploying AMR](#).
- Services for each of the four components, named:
 - `metadata-store-app`
 - `metadata-store-db`
 - `amr-persister`. If AMR is deployed, see [Deploying AMR](#).

- `artifact-metadata-repository-app`. If AMR is deployed, see [Deploying AMR](#).
- A namespace called `metadata-store`.
- Persistent volume claim `postgres-db-pv-claim` in the `metadata-store` namespace.
- A Kubernetes secret in the namespace `tap` is installed to allow pulling SCST - Store images from a registry.
- Two ClusterRoles:
 - `metadata-store-read-write-client` is bound to a service account by default, giving the service account read and write privileges
 - `metadata-store-read-only` isn't bound to any service accounts, you can bind to it if needed. See [Service Accounts](#).
- (Optional) An HTTPProxy object for ingress support.

Deployment configuration

All configurations are nested inside `metadata_store` in your Tanzu Application Platform values deployment YAML. AMR-specific configurations are nested under `amr` in the `metadata_store` section.

Supported Network Configurations

VMware recommends the following connection methods for Tanzu Application Platform:

- For a single or multicluster configuration with Contour, use [Ingress](#).
- For a single cluster without Contour and with [LoadBalancer](#) support configuration, use [LoadBalancer](#).
- For a single cluster without Contour and without [LoadBalancer](#) configuration, use [NodePort](#).

Multicluster without Contour configuration is not supported. For a production environment, VMware recommends installing SCST - Store with ingress enabled.

Deploying AMR



Caution

AMR is a beta feature and is not recommended for use in production.

By default, AMR is not deployed with SCST - Store. There is an `amr` section inside `metadata_store`. To deploy AMR, you must set the `deploy` property under `amr` to `true`.

```
metadata_store:
  amr:
    deploy: true
```



Note

The `deploy` property expects a Boolean value of `true` or `false`, not a string value.

App service type

This configuration is available in the following places:

- `metadata_store` configures the app service type of the metadata store.
- `amr` in the `metadata_store` section configures the app service type.

Supported values include:

- `LoadBalancer`
- `ClusterIP`
- `NodePort`. The `app_service_type` is set to `LoadBalancer` by default. If your environment does not support `LoadBalancer`, configure the `app_service_type` property to use `ClusterIP` in your deployment YAML:

For metadata-store:

```
metadata_store:
  app_service_type: "ClusterIP"
```

For AMR:

```
metadata_store:
  amr:
    deploy: true
    app_service_type: "ClusterIP"
```

If you set the `ingress_enabled` to `"true"`, VMware recommends setting the `app_service_type` property to `"ClusterIP"`.



Note

The `app_service_type` is set to `ClusterIP` by default when you enable shared ingress.

Ingress support

The SCST - Store values file allows you to enable ingress support and to configure a custom domain name to use Contour to provide external access to the SCST - Store API. These ingress configurations are shared for the Metadata Store and AMR. Enabling ingress for the Metadata Store enables it for both the Metadata Store and AMR.

For example:

```
metadata_store:
  ingress_enabled: "true"
  ingress_domain: "example.com"
  app_service_type: "ClusterIP" # recommended setting when ingress is enabled
```

An HTTPProxy object is installed with `metadata-store.example.com` as the FQDN. For more information, see [Ingress](#).



Important

The `ingress_enabled` property expects a string value of `"true"` or `"false"`, not a Boolean value.

Database configuration

You can start using the Metadata Store with the default database included with the deployment. The default database deployment does not support many enterprise production requirements, including scaling, redundancy, and failover. However, it is a secure deployment.

Use an AWS RDS PostgreSQL database

You can configure the deployment to use your own RDS database instead of the default. For more information, see [Configure your AWS RDS PostgreSQL configuration](#).

Use an external PostgreSQL database

You can configure the deployment to use any other PostgreSQL database. For more information, see [Use an external PostgreSQL database for SCST - Store](#).

Custom database password

By default, a database password is generated after deployment. To configure a custom password, use the `db_password` property in the deployment YAML. The `db_password` property is available under `metadata_store` and under `amr` in `metadata_store`.



Important

There is a known issue related to changing database passwords. For more information, see [Persistent volume retains data](#).

To configure a custom database password for the store:

```
metadata_store:
  db_password: "PASSWORD"
```

To configure a custom database password for AMR:

```
metadata_store:
  amr:
    deploy: true
    db_password: "PASSWORD"
```

Where `PASSWORD` is the same password used for both deployments.

Service accounts

By default, a service account with read-write privileges to the Metadata Store app is installed. This service account is a cluster-wide account that uses ClusterRole. If you don't want the service account and role, set the `add_default_rw_service_account` property to `"false"`. To create a custom service account, see [Retrieve and create service accounts](#).

The store creates a read-only cluster role, which is bound to a service account by using `ClusterRoleBinding`. To create service accounts to bind to this cluster role, see [Retrieve and create service accounts](#).

Export certificates

SCST - Store creates a [Secret Export](#) for exporting certificates to SCST - Store to securely post scan results. These certificates are exported to the namespace where SCST - Store is installed.

Configure your AWS RDS PostgreSQL configuration

This topic describes how you can configure your AWS RDS PostgreSQL configuration for Supply Chain Security Tools (SCST) - Store.

Prerequisite

You must have an AWS account.

Set up a certificate and configuration

To set up a certificate and configuration:

1. Create an Amazon RDS Postgres using the [Amazon RDS Getting Started Guide](#)
2. After the database instance starts, retrieve the following information:
 - Database Instance Endpoint
 - Master Username
 - Master Password
 - Database Name



Note

If the database name is - in the AWS RDS UI, the value is likely to be `postgres`.

3. Create a security group to allow inbound connections from the cluster to the Postgres DB
4. Retrieve the corresponding CA Certificate that signed the Postgres TLS Certificate using the following [link](#)
5. In the `metadata-store-values.yaml` fill the following settings:

```
db_host: "<DB Instance Endpoint>"
db_user: "<Master Username>"
db_password: "<Master Password>"
db_name: "<Database Name>"
db_port: "5432"
db_sslmode: "verify-full"
db_max_open_conns: 10
db_max_idle_conns: 100
db_conn_max_lifetime: 60
db_ca_certificate: |
  <Corresponding CA Certification>
  ...
  ...
  ...
deploy_internal_db: "false"
```



Note

If `deploy_internal_db` is set to `false`, an instance of Postgres will not be deployed in the cluster.

Use an external PostgreSQL database for Supply Chain Security Tools - Store

This topic describes how you can configure and use your external PostgreSQL database for Supply Chain Security Tools (SCST) - Store.

Prerequisites

- Set up your external PostgreSQL database. After the database instance starts, retrieve the following information:
 1. Database Instance Endpoint
 2. Main User name
 3. Main Password
 4. Database Name

Set up certificate and configuration

1. Create a security group to allow inbound connections from the cluster to the PostgreSQL database.
2. Retrieve the corresponding CA Certificate that signed the PostgreSQL TLS Certificate.
3. In the `metadata-store-values.yaml` fill the following settings:

```
db_host: "<DB Instance Endpoint>"
db_user: "<Master Username>"
db_password: "<Master Password>"
db_name: "<Database Name>"
db_port: "5432"
db_sslmode: "verify-full"
db_max_open_conns: 10
db_max_idle_conns: 100
db_conn_max_lifetime: 60
db_ca_certificate: |
  <Corresponding CA Certification>
  ...
  ...
  ...
deploy_internal_db: "false"
```



Note

If `deploy_internal_db` is set to `false`, an instance of PostgreSQL is not deployed in the cluster.

Validation

Verification was done using bitnami PostgreSQL. You can get more information from the [bitnami documentation](#).

Database backup recommendations for Supply Chain Security Tools - Store

This topic tells you about database backup recommendations for Supply Chain Security Tools (SCST) - Store.

By default, the metadata store uses a `PersistentVolume` mounted on a PostgreSQL instance, making it a stateful component of Tanzu Application Platform. VMware recommends implementing a regular backup strategy as part of your disaster recovery plan when using the provided PostgreSQL instance.

Backup

You can use [Velero](#) to create regular backups.



Note

Backup support for `PersistentVolume` depends on the used `StorageClass` and existing provider plug-ins. See the officially [supported plug-ins here](#).

```
velero install --provider PROVIDER --bucket BUCKET-NAME --plugins PLUGIN-IMAGE-LOCATIO
N \
--secret-file SECRET-FILE
```

Where:

- `PROVIDER` is the name of the provider you want to use.
- `BUCKET-NAME` is the name of the bucket you want to use.
- `PLUGIN-IMAGE-LOCATION` is the location of the plug ins you want to use.
- `SECRET-FILE` is the file where the secret is located.

Velero CLI can then be used to create a backup of all the resources in the `metadata-store` namespace, including `PersistentVolumeClaim` and `PersistentVolume`.

```
velero backup create metadata-store-$(date +%s') --include-namespaces=metadata-store
```

Restore

You can use Velero CLI to restore the Store in the same cluster or a different cluster.

You can use the same namespace for the restore, but there is a risk of collision with other SCST - Store installations. Furthermore, Tanzu Application Platform does not manage a restored SCST - Store instance within the same namespace, which can cause conflicts with future installations.

To restore the Store, run:

```
velero restore create restore-metadata-store-$(timestamp) --from-backup metadata-store
-$(timestamp) \
--namespace-mappings metadata-store:metadata-store
```

Alternatively, a different namespace can be used to restore SCST - Store. In this case, SCST - Store API is not available because of conflicting definitions in the role-based access control (RBAC) proxy configuration. These conflicting definitions cause all requests to fail with an `Unauthorized` error.

In this scenario, the PostgreSQL instance is still accessible, and tools such as `pg_dump` can be used to retrieve table contents and restore in a new live installation of SCST - Store.

To restore the Store, run:

```
velero restore create restore-metadata-store-$timestamp --from-backup metadata-store-$timestamp \
--namespace-mappings metadata-store:restored-metadata-store
```

Currently, mounting an existing `PersistentVolume` or `PersistentVolumeClaim` during installation is not supported.

The minimum suggested resources for backups are `PersistentVolume`, `PersistentVolumeClaim` and `Secret`. The database password `Secret` is needed to set up a PostgreSQL instance with the correct password to properly read data from the restored volume.

Log configuration and usage for Supply Chain Security Tools - Store

This topic describes how you can configure Supply Chain Security Tools (SCST) - Store to output and interpret detailed log information.

Verbosity levels

There are six verbosity levels that Supply Chain Security Tools - Store supports.

Level	Description
Trace	Output extended debugging logs.
Debug	Output standard debugging logs.
More	Output more verbose informational logs.
Default	Output standard informational logs.
Less	Outputs less verbose informational logs.
Minimum	Outputs a minimal set of informational logs.

When SCST - Store is deployed at a specific verbosity level, all logs of that level and lower are output to the console. For example, setting the verbosity level to `More` outputs logs from `Minimal` to `More`, while `Debug` and `Trace` logs are muted.

Currently, the application logs output at these levels:

- **Minimum** does not output any logs.
- **Less** outputs a single log line indicating the current verbosity level is configured in Metadata Store when the application starts.
- **Default** outputs API endpoint access information.
- **Debug** outputs API endpoint payload information, both for requests and responses.
- **Trace** outputs verbose debug information about the actual SQL queries for the database.

Other log levels do not output any additional log information and are present for future extensibility.

If you don't specify a verbosity level when the Store is installed, the level is set to `default`.

Slow SQL

A slow SQL statement is logged only when verbosity level is set to `trace` and the SQL query takes more than 200 milliseconds to execute. You can change this default by setting the `db_slow_threshold_ms` value in `values.yaml` file and redeploying metadata store.

Error logs

Error logs are always output regardless of the verbosity level, even when set to `minimum`.

Obtaining logs

Kubernetes pods emit logs. The deployment has two pods, one for the database and one for the API back end.

Use `kubectl get pods` to obtain the names of the pods:

```
kubectl get pods -n metadata-store
```

For example:

```
$ kubectl get pods -n metadata-store
NAME                                READY   STATUS    RESTARTS   AGE
metadata-store-app-67659bbc66-2rc6k 2/2     Running   0           4d3h
metadata-store-db-64d5b88587-8dns7   1/1     Running   0           4d3h
```

The database pod has the prefix `metadata-store-db-`. The API backend pod has the prefix `metadata-store-app-`. Use `kubectl logs` to get the logs from the pod you're interested in. For example, to get the logs of the database pod, run:

```
$ kubectl logs metadata-store-db-64d5b88587-8dns7 -n metadata-store
The files belonging to this database system will be owned by user "postgres".
This user must also own the server process.
...
```

The API backend pod has two containers, one for `kube-rbac-proxy`, and one for the API server. Use the `--all-containers` flag to see logs from both containers. For example:

```
$ kubectl logs metadata-store-app-67659bbc66-2rc6k --all-containers -n metadata-store
I1206 18:34:17.686135      1 main.go:150] Reading config file: /etc/kube-rbac-proxy/c
onfig-file.yaml
I1206 18:34:17.784900      1 main.go:180] Valid token audiences:
...
{"level":"info","ts":"2022-05-27T13:47:52.54099339Z","logger":"MetadataStore","msg":"L
og settings","hostname":"metadata-store-app-5c9d6bccdb-kcrt2","LOG_LEVEL":"default"}
{"level":"info","ts":"2022-05-27T13:47:52.541133699Z","logger":"MetadataStore","ms
g":"Server Settings","hostname":"metadata-store-app-5c9d6bccdb-kcrt2","bindingaddres
s":"localhost:9443"}
{"level":"info","ts":"2022-05-27T13:47:52.541150096Z","logger":"MetadataStore","ms
g":"Database Settings","hostname":"metadata-store-app-5c9d6bccdb-kcrt2","maxopenconnec
tion":10,"maxidleconnection":100,"connectionmaxlifetime":60}
```



Note

The `kube-rbac-proxy` container uses a different log format than the Store. For information about the proxy's container log format, see [Logging Formats](#) in GitHub.

API endpoint log output

When an API endpoint handles a request, the Store generates two and five log entries:

- When the endpoint receives a request, it outputs a `Processing request` line. This logline is shown at the `default` verbosity level.

- If the endpoint includes query or path parameters, it outputs a `Request parameters` line. This line logs the parameters passed in the request. This line is shown at the `default` verbosity level.
- If the endpoint takes in a request body, it outputs a `Request body` line. This line outputs the entire request body as a string. This line is shown at the `debug` verbosity level.
- When the endpoint returns a response, it outputs a `Request response` line. This line is shown at the `default` verbosity level.
- If the endpoint returns a response body, it outputs a second `Request response` line with an extra key `payload`, and its value is set to the entire response body. This line is shown at the `debug` verbosity level.

Format

The logs use JSON output format.

When the Store handles a request, it outputs API endpoint access information in the following format:

```
{ "level": "info", "ts": "2022-05-27T15:41:36.051991749Z", "logger": "MetadataStore", "msg": "Processing request", "hostname": "metadata-store-app-c7c8648f7-8dmd1", "method": "GET", "endpoint": "/api/images?digest=sha256%3A20521f76ff3d27f436e03dc666cc97a511bbe71e8e8495f851d0f4bf57b0bab6" }
```

Key-value pairs

Because JSON output format uses key-value pairs, the tables in the following sections list each key and the meaning of their values.

Common to all logs

The following key-value pairs are common for all logs.

Key	Type	Verbosity Level	Description
level	string	all	The log level of the message. This is either <code>error</code> for error messages, or <code>info</code> for all other messages.
ts	string	all	The timestamp when the log entry was generated. It uses RFC 3339 format with nanosecond precision and 00:00 offset from UTC, meaning Zulu time.
logger	string	all	Used to identify what produced the log entry. For Store, the name always starts with <code>MetadataStore</code> . For log entries that display the raw SQL queries, the name is <code>MetadataStore.gorm</code>
msg	string	all	A short description of the logged event
hostname	string	all	The Kubernetes host name of the pod handling the request. This helps identify the specific instance of the Store when you deploy multiple instances on a cluster.
error	string	all	The error message which is only available in error log entries
endpoint	string	default	The API endpoint the Metadata Store attempts to handle the request. This also includes any query and path parameters passed in.
method	string	default	The HTTP verb to access the endpoint. For example, <code>GET</code> or <code>POST</code> .
code	integer	default	The HTTP response code

Key	Type	Verbosity Level	Description
response	string	default	The HTTP response in human-readable format. For example, <code>OK</code> , <code>Bad Request</code> , or <code>Internal Server Error</code> .
function	string	debug	The function name that handles the request.

Logging query and path parameter values

Those endpoints that use query or path parameters are logged on the `Request parameters` log entry as key-value pairs. They are appended to all other log entries of the same request as key-value pairs.

The key names are the query or path parameter's name, while the value is set to the value of those parameters in string format.

For example, the following log entry contains the `digest` and `id` key, which represents the respective `digest` and `id` query parameters, and their values:

```
{ "level": "info", "ts": "2022-05-27T15:41:36.052063176Z", "logger": "MetadataStore", "msg": "Request parameters", "hostname": "metadata-store-app-c7c8648f7-8dmd1", "method": "GET", "endpoint": "/api/images?digest=sha256%3A20521f76ff3d27f436e03dc666cc97a511bbe71e8e8495f851d0f4bf57b0bab6", "id": 0, "digest": "sha256:20521f76ff3d27f436e03dc666cc97a511bbe71e8e8495f851d0f4bf57b0bab6", "name": "" }
```

These key-value pairs show up in all subsequent log entries of the same call. For example:

```
{ "level": "info", "ts": "2022-05-27T15:41:36.057393519Z", "logger": "MetadataStore", "msg": "Request response", "hostname": "metadata-store-app-c7c8648f7-8dmd1", "method": "GET", "endpoint": "/api/images?digest=sha256%3A20521f76ff3d27f436e03dc666cc97a511bbe71e8e8495f851d0f4bf57b0bab6", "id": 0, "digest": "sha256:20521f76ff3d27f436e03dc666cc97a511bbe71e8e8495f851d0f4bf57b0bab6", "name": "", "code": 200, "response": "OK" }
```

This is done to:

- Ensure that the application interprets the values of the query or path parameters correctly.
- Figure out which log entries are associated with a particular API request. Because there might be several simultaneous endpoint calls, this is a first attempt at grouping logs by specific calls.

API payload log output

As mentioned at the start of this section, by setting the verbosity level to `debug`, the Store logs the body payload data for both the request and response of an API call.

The `debug` verbosity level, instead of the `default`, displays this information instead of `default` because:

- Body payloads can contain full CycloneDX and SBOM information. Moving the payload information at this level helps keep the production log output to a reasonable size.
- Some information in these payloads might be sensitive, and the user might not want them exposed in production environment logs.

GraphQL endpoint log output



Note

This section is only applicable to Artifactory Metadata Repository (AMR) logs.

When an GraphQL endpoint handles a request, the AMR generates following types of logs:

- Every request received produces a `Processing request` log, which includes the name of the operation called and the requested fields.
- Every response will produce a log containing the actual query and the return status
- If the endpoint returns a response body, it outputs a second `Request response` line with an extra key `payload`, and its value is set to the entire response body. This line is shown at the `debug` verbosity level

Format

The logs output are in JSON format.

When the AMR handles a request, it outputs some GraphQL endpoint access information in the following format:

```
{ "level": "info", "ts": "2023-03-23T13:11:31.161531-06:00", "logger": "Artifact Metadata Repository", "msg": "Processing request", "hostname": "xyzp2DMD6R.vmware.com", "getAllApps": "query getAllApps {\n  apps(latest:true) {\n    \n    timestamp\n    location {\n      alias\n    }\n  }\n}" }
{ "level": "info", "ts": "2023-03-23T13:11:31.172953-06:00", "logger": "Artifact Metadata Repository", "msg": "Request response", "hostname": "xyzp2DMD6R.vmware.com", "getAllApps": "query getAllApps {\n  apps(latest:true) {\n    \n    timestamp\n    location {\n      alias\n    }\n  }\n}", "code": 200, "response": "OK" }
```

Key-value pairs

The following tables list the meaning of each key found in the logs.

Common to all logs

The following key-value pairs are common for all logs.

Key	Type	Verbosity Level	Description
level	string	all	The log level of the message. This is either <code>error</code> for error messages, or <code>info</code> for all other messages.
ts	string	all	The timestamp when the log entry was generated. It uses RFC 3339 format with nanosecond precision and 00:00 offset from UTC, meaning Zulu time.
logger	string	all	Used to identify what produced the log entry. For Store, the name always starts with <code>MetadataStore</code> . For log entries that display the raw SQL queries, the name is <code>MetadataStore.gorm</code> .
msg	string	all	A short description of the logged event
hostname	string	all	The Kubernetes host name of the pod handling the request. This helps identify the specific instance of the Store when you deploy multiple instances on a cluster.
error	string	all	The error message which is only available in error log entries
code	integer	default	The HTTP response code
response	string	default	The HTTP response in human-readable format. For example, <code>OK</code> , <code>Bad Request</code> , or <code>Internal Server Error</code> .

Key	Type	Verbosity Level	Description
query	string	debug	The operation name is the key and value fields that the fields requested.

API payload log output

By setting the verbosity level to `debug`, the AMR logs the body payload data for both the request and response of an API call.

The `debug` verbosity level, instead of the `default`, displays this information instead of `default` because body payloads can be large and some information in these payloads might be sensitive. You might not want the sensitive payloads exposed in production environment logs.

Logs containing payload information might be in the following format:

```
{ "level": "info", "ts": "2023-03-23T13:11:31.172966-06:00", "logger": "Artifact Metadata Repository", "msg": "Request response", "hostname": "xyzp2DMD6R.vmware.com", "getAllApps": "query getAllApps {\n  apps(latest:true) {\n    \n    timestamp\n    location {\n      alias\n    }\n  }\n}", "payload": {"apps": [{"timestamp": "2023-03-22T15:09:38.867371-06:00", "location": {"alias": "1-Alias"}}]}
```

Slow SQL query log output

When the verbosity level is set to `trace`, you see log entries containing slow SQL queries.



Note

Some information in these SQL Query `trace` logs might be sensitive, and you might not want them exposed in production environment logs.

SQL Query log output

Slow SQL query logs are displayed in the following format when verbosity level is set to `trace`:

```
{ "level": "info", "ts": "2023-03-23T12:48:12.337749-06:00", "logger": "Artifact Metadata Repository.gorm", "msg": "slow sql >= 200ms", "hostname": "xyzp2DMD6R.vmware.com", "rows": 50000, "sql": "SELECT `artifact_apps`.`id`,`artifact_apps`.`created_at`,`artifact_apps`.`updated_at`,`artifact_apps`.`deleted_at`,`artifact_apps`.`location_id`,`artifact_apps`.`correlation_id`,`artifact_apps`.`image_url`,`artifact_apps`.`image_digest`,`artifact_apps`.`namespace`,`artifact_apps`.`name`,`artifact_apps`.`instances`,`artifact_apps`.`status`,`artifact_apps`.`timestamp` FROM `artifact_apps` INNER JOIN (select max(timestamp) as timestamp, name, namespace, location_id from artifact_apps group by location_id, name, namespace) as argo on argo.timestamp = artifact_apps.timestamp and argo.name = artifact_apps.name and argo.location_id = artifact_apps.location_id and argo.namespace = artifact_apps.namespace WHERE `artifact_apps`.`deleted_at` IS NULL"}"
```

It is similar to the [API endpoint log output](#) format, but uses the following key-value pairs:

Key	Type	Log Level	Description
rows	integer	trace	Indicates the number of rows affected by the SQL query
sql	string	trace	Displays the raw SQL query for the database
data #	string	all	Used in error log entries. You can replace # with an integer because multiples of these keys can appear in the same log entry. These keys contain extra information related to the error.

SQL Query log output

Some Store logs display the executed SQL query commands when you set the verbosity level to `trace` or a SQL call fails.



Note

Some information in these SQL Query trace logs might be sensitive, and you might not want them exposed in production environment logs.

Format

When the Store display SQL query logs, it uses the following format:

```
{ "level": "info", "ts": "2022-05-27T15:37:26.186960324Z", "logger": "MetadataStore.gorm", "msg": "sql call", "hostname": "metadata-store-app-c7c8648f7-8dmd1", "rows": 1, "sql": "SELECT count(*) FROM information_schema.tables WHERE table_schema = CURRENT_SCHEMA() AND table_name = 'images' AND table_type = 'BASE TABLE'"}

```

It is similar to the [API endpoint log output](#) format, but uses the following key-value pairs:

Key	Type	Log Level	Description
rows	integer	trace	Indicates the number of rows affected by the SQL query
sql	string	trace	Displays the raw SQL query for the database
data #	string	all	Used in error log entries. You can replace # with an integer because multiples of these keys can appear in the same log entry. These keys contain extra information related to the error.

Connecting to the PostgreSQL Database

This topic tells you how to connect to the PostgreSQL database. To connect to the PostgreSQL database, you need the following values:

- database name
- user name
- password
- database host
- database port
- database CA certificate
- To obtain the database name, user name, password, and CA certificate, run these commands:

```
db_name=$(kubectl get secret postgres-db-secret -n metadata-store -o json | jq -r '.data.POSTGRES_DB' | base64 -d)
db_username=$(kubectl get secret postgres-db-secret -n metadata-store -o json | jq -r '.data.POSTGRES_USER' | base64 -d)
db_password=$(kubectl get secret postgres-db-secret -n metadata-store -o json | jq -r '.data.POSTGRES_PASSWORD' | base64 -d)

db_ca_dir=$(mktemp -d -t ca-cert-XXXX)
db_ca_path="$db_ca_dir/ca.crt"
```

```
kubectl get secrets postgres-db-tls-cert -n metadata-store -o json | jq -r '.data."ca.crt"' | base64 -d > $db_ca_path
```

If the password was auto-generated, the earlier `password` command returns an empty string. Instead, run:

```
db_password=$(kubectl get secret postgres-db-password -n metadata-store -o json | jq -r '.data.DB_PASSWORD' | base64 -d)
```

- In a separate terminal, run:

```
kubectl port-forward service/metadata-store-db 5432:5432 -n metadata-store
```

- Set the database host and port values on the first terminal by running:

```
db_host="localhost"
db_port=5432
```

- To port forward to a different local port number, use this command template:

```
kubectl port-forward service/metadata-store-db <LOCAL_PORT>:5432 -n metadata-store
```

With this setup, you can now connect to the database and make queries as in the following example:

```
$ psql "host=$db_host port=$db_port user=$db_username dbname=$db_name sslmode=verify-ca \
sslrootcert=$db_ca_path" -c "SELECT * FROM images"
```

You can also use GUI clients, such as [Postico](#) or [DBeaver](#) to interact with the database.

Troubleshooting Supply Chain Security Tools - Store

This topic contains ways you can troubleshoot known issues for Supply Chain Security Tools (SCST) - Store.

Querying by `insight source` returns zero CVEs even though there are CVEs in the source scan

Symptom

The `insight source get` and other `insight source` commands return zero results.

Solution

You might have to include different combinations of `--repo`, `--org`, `--commit` due to how the scan-controller populates the software bill of materials (SBOM). For more information, see [Query vulnerabilities, images, and packages](#).

Persistent volume retains data

Symptom

If SCST - Store is deployed, deleted, redeployed, and the database password is changed during the redeployment, the `metadata-store-db` pod fails to start. The persistent volume used by PostgreSQL retaining old data, even though the retention policy is set to `DELETE`, causes this issue.

Solution



Caution

Changing the database password deletes your SCST - Store data.

To redeploy the app, either use the same database password or follow these steps to erase the data on the volume:

1. Deploy metadata-store app by using `kapp`.
2. Verify that the `metadata-store-db-*` pod fails.
3. Run:

```
kubectl exec -it metadata-store-db-<some-id> -n metadata-store /bin/bash
```

Where `<some-id>` is the ID generated by Kubernetes and appended to the pod name.

4. Run `rm -rf /var/lib/postgresql/data/*` to delete all database data.

Where `/var/lib/postgresql/data/*` is the path found in `postgres-db-deployment.yaml`.

5. Delete the `metadata-store` app by using `kapp`.
6. Deploy the `metadata-store` app by using `kapp`.

Missing persistent volume

Symptom

After SCST - Store is deployed, `metadata-store-db` pod might fail because of a missing volume while `postgres-db-pv-claim` pvc is in `PENDING` state.

This is because the cluster where SCST - Store is deployed does not have `storageclass` defined. `storageclass`'s provisioner is responsible for creating the persistent volume after `metadata-store-db` attaches `postgres-db-pv-claim`.

Solution

To solve:

1. Verify that your cluster has `storageclass` by running `kubectl get storageclass`.
2. Create a `storageclass` in your cluster before deploying SCST - Store. For example:

```
# This is the storageclass that Kind uses
kubectl apply -f https://raw.githubusercontent.com/rancher/local-path-provisioner/master/deploy/local-path-storage.yaml

# set the storage class as default
kubectl patch storageclass local-path -p '{"metadata": {"annotations":{"storage class.kubernetes.io/is-default-class":"true"}}}'
```

Builds fail due to volume errors on EKS running Kubernetes v1.23

Symptom

When installing SCST - Store on or upgrading an existing EKS cluster to Kubernetes v1.23, the database pod shows:

```
running PreBind plugin "VolumeBinding": binding volumes: provisioning failed for PVC
"postgres-db-pv-claim"
```

Explanation

This is due to the [CSIMigrationAWS in this Kubernetes version](#), which requires users to install the Amazon Elastic Block Store (EBS) CSI Driver to use EBS volumes. For more information, see the [AWS documentation](#).

SCST - Store uses the default storage class which uses EBS volumes by default on EKS.

Solution

Follow the [AWS documentation](#) to install the Amazon EBS CSI Driver before installing SCST - Store or before upgrading to Kubernetes v1.23. For more information, see the [AWS documentation](#).

Certificate Expiries

Symptom

The Insight CLI or the Scan Controller fails to connect to SCST - Store.

The logs of the metadata-store-app pod show the following error:

```
$ kubectl logs deployment/metadata-store-app -c metadata-store-app -n metadata-store
...
2022/09/12 21:22:07 http: TLS handshake error from 127.0.0.1:35678: write tcp 127.0.0.
1:9443->127.0.0.1:35678: write: broken pipe
...
```

or

The logs of metadata-store-db show the following error:

```
$ kubectl logs statefulset/metadata-store-db -n metadata-store
...
2022-07-20 20:02:51.206 UTC [1] LOG: database system is ready to accept connections
2022-09-19 18:05:26.576 UTC [13097] LOG: could not accept SSL connection: sslv3 alert
bad certificate
...
```

Explanation

cert-manager rotates the certificates, but the metadata-store and the PostgreSQL db are unaware of the change, and are using the old certificates.

Solution

If you see [TLS handshake error](#) in the metadata-store-app logs, delete the metadata-store-app pod and wait for it to come back up.

```
kubectl delete pod metadata-store-app-xxxx -n metadata-store
```

If you see [could not accept SSL connection](#) in the metadata-store-db logs, delete the [metadata-store-db](#) pod and wait for it to come back up.

```
kubectl delete pod metadata-store-db-0 -n metadata-store
```

Database index corruption issue in SCST - Store

Metadata Store unable to reconcile because the metadata store pod complains about potential database index corruption issue.

```
kubectl logs metadata-store-app-pod_name -n metadata-store
```

```
{
  "level": "error",
  "ts": "2023-08-15T16:38:31.528115988Z",
  "logger": "MetadataStore",
  "msg": "unable to check index corruption since user is not a superuser to perform `CREATE EXTENSION amcheck`. Please create this extension and check for index corruption using following sql command `SELECT bt_index_check(oid) FROM pg_class WHERE relname in (SELECT indexrelid::regclass::text FROM (SELECT indexrelid, indrelid, indcollation[i] coll FROM pg_index, generate_subscripts(indcollation, 1) g(i)) s JOIN pg_collation c ON coll=c.oid WHERE collprovider IN ('d', 'c') AND collname NOT IN ('C', 'POSIX')));`",
  "hostname": "metadata-store-app-77c9fb59c8-qplxt"
}
{
  "level": "error",
  "ts": "2023-08-15T16:38:31.528139637Z",
  "logger": "MetadataStore",
  "msg": "Found corrupted database indexes but unable to fix them",
  "hostname": "metadata-store-app-77c9fb59c8-qplxt",
  "error": "unable to check index corruption since user is not a superuser to perform `CREATE EXTENSION amcheck`. Please create this extension and check for index corruption using following sql command `SELECT bt_index_check(oid) FROM pg_class WHERE relname in (SELECT indexrelid::regclass::text FROM (SELECT indexrelid, indrelid, indcollation[i] coll FROM pg_index, generate_subscripts(indcollation, 1) g(i)) s JOIN pg_collation c ON coll=c.oid WHERE collprovider IN ('d', 'c') AND collname NOT IN ('C', 'POSIX')));`"
}
```

For information about the solution, see [Postgres Database Index Corruption](#).

Errors from Tanzu Developer Portal related to SCST - Store

Different Tanzu Developer Portal plug-ins use SCST - Store to display information about vulnerabilities and packages. Some errors visible in Tanzu Developer Portal are related to this connection.

An error occurred while loading data from the Metadata Store

Symptom

In the Supply Chain Choreographer plug-in, you see the error message [An error occurred while loading data from the Metadata Store](#).

tanzu-java-web-app-scan2

Supply Chain: source-test-scan-to-url Errors: 1

Supply Chain Cluster: tkg-build-airgap-fuji

Delivery Cluster: tkg-run-airgap-fuji-config

Stage Detail: Image Scanner
2 hours ago

Overview		Policy	
Registry	harbor-airgap.dapdaws.net	Name	scan-policy
Image	harbor-airgap.dapdaws.net/tap/workloads/tanzu-java-web-app-scan2-my-apps	UID	
Digest	sha256: [redacted]	Generation	1
Scan Template	tanzu-java-web-app-scan2	Details	No Violations Found
UID			
Generation	1		

An error occurred while loading data from the Metadata Store.

CVE ID	Severity	Package	Version	Description

Cause

There are multiple potential causes. The most common cause is `tap-values.yaml` missing the configuration that enables Tanzu Developer Portal to communicate with Supply Chain Security Tools - Store.

Solution

See [Supply Chain Choreographer - Enable CVE scan results](#) for the necessary configuration to add to `tap-values.yaml`. After adding the configuration, update your Tanzu Application Platform deployment or Tanzu Developer Portal deployment with the new values.

Troubleshoot upgrading Supply Chain Security Tools - Store

This topic describes how you can troubleshoot upgrading issues Supply Chain Security Tools (SCST) - Store.

Database deployment does not exist

To prevent issues with the metadata store database, such as the ones described in this topic, the database deployment is `StatefulSet` in

- Tanzu Application Platform v1.2 and later
- Metadata Store v1.1 and later

If you have scripts searching for a `metadata-store-db` deployment, edit the scripts to instead search for `StatefulSet`.

Invalid checkpoint record

When using Tanzu to upgrade to a new version of the store, there is occasionally data corruption. Here is an example of how this shows up in the log:

```

PostgreSQL Database directory appears to contain a database; Skipping initialization

2022-01-21 21:53:38.799 UTC [1] LOG:  starting PostgreSQL 13.5 (Ubuntu 13.5-1.pgdg18.0
4+1) on x86_64-pc-linux-gnu, compiled by gcc (Ubuntu 7.5.0-3ubuntu1~18.04) 7.5.0, 64-b
it
2022-01-21 21:53:38.799 UTC [1] LOG:  listening on IPv4 address "0.0.0.0", port 5432
2022-01-21 21:53:38.799 UTC [1] LOG:  listening on IPv6 address ":::", port 5432
2022-01-21 21:53:38.802 UTC [1] LOG:  listening on Unix socket "/var/run/postgresql/.
s.PGSQL.5432"
2022-01-21 21:53:38.807 UTC [14] LOG:  database system was shut down at 2022-01-21 21:
21:12 UTC
2022-01-21 21:53:38.807 UTC [14] LOG:  invalid record length at 0/1898BE8: wanted 24,
got 0
2022-01-21 21:53:38.807 UTC [14] LOG:  invalid primary checkpoint record
2022-01-21 21:53:38.807 UTC [14] PANIC:  could not locate a valid checkpoint record
2022-01-21 21:53:39.496 UTC [1] LOG:  startup process (PID 14) was terminated by signa
l 6: Aborted
2022-01-21 21:53:39.496 UTC [1] LOG:  aborting startup due to startup process failure
2022-01-21 21:53:39.507 UTC [1] LOG:  database system is shut down

```

The log shows a database pod in a failure loop. For steps to fix the issue so that the upgrade can proceed, see the [SysOpsPro documentation](#).

Upgraded pod hanging

Because the default access mode in the PVC is `ReadWriteOnce`, if you are deploying in an environment with multiple nodes then each pod might be on a different node. This causes the upgraded pod to spin up but then get stuck initializing because the original pod does not stop. To resolve this issue, find and then delete the original pod so that the new pod can attach to the persistent volume:

1. Discover the name of the app pod that is not in a pending state by running:

```
kubectl get pods -n metadata-store
```

2. Delete the pod by running:

```
kubectl delete pod METADATA-STORE-APP-POD-NAME -n metadata-store
```

Failover, redundancy, and backups for Supply Chain Security Tools - Store

This topic describes how you can configure and use failover, redundancy, and backups for Supply Chain Security Tools (SCST) - Store.

API Server

By default the API server has 1 replica. If the pod fails, the single instance restarts by normal Kubernetes behavior, but there is downtime. If you upgrade, some downtime is possible.

You can configure the number of replicas by using the `app_replicas` text box in the `scst-store-values.yaml` file.

Database

By default, the database has one replica, and restarts with some downtime if it fails.

**Caution**

Although you can configure `db_replicas` in `scst-store-values.yaml`, this is discouraged because `db_replicas` is still experimental. The default internal database is not for production use. For production deployments, use an external database.

- [Use external postgres database](#)
- [AWS RDS postgres configuration](#)

For the default PostgreSQL database deployment, with `deploy_internal_db` set to `true`, you can use `Velero` as the backup method. For information about using `Velero` as the backup method, see [Backups](#).

Custom certificate configuration for Supply Chain Security Tools - Store

This topic describes how you can configure the following certificates for Supply Chain Security Tools (SCST) - Store.

Default configuration

By default, SCST - Store creates a self-signed certificate and TLS communication is automatically enabled.

If [ingress support](#) is enabled, SCST - Store installation creates an HTTPProxy entry with host-routing by using the qualified name `metadata-store.<ingress_domain>`. For example, `metadata-store.example.com`. The created route supports HTTPS communication using the self-signed certificate with the same subject `Alternative Name`.

(Optional) Set up a custom ingress TLS certificate

To configure TLS to use a custom certificate:

1. Place the certificates in the secret.
2. Edit the `tap-values.yaml` to use this secret.

Place the certificates in a secret

To place the certificates in a secret:

1. Create the certificate secret before deploying SCST - Store.
2. Create a Kubernetes object with the kind `Secret` and the type `kubernetes.io/tls`.

Edit the `tap-values.yaml` to use the secret

In `tap-values.yaml`, configure the metadata store to use the `namespace` and `secretName` from the secret you just created, as in this example:

```
metadata_store:
  tls:
    namespace: "NAMESPACE"
    secretName: "SECRET-NAME"
```

Where:

- `NAMESPACE` is the targeted namespace for secret consumption by the HTTPProxy.
- `SECRET-NAME` is the name of secret for consumption by the HTTPProxy.

Additional resources

- [Ingress support](#)
- [TLS configuration](#)

TLS configuration for Supply Chain Security Tools - Store

This topic describes how you can configure TLS for Supply Chain Security Tools (SCST) - Store.



Important

SCST - Store only supports TLS v1.2.

Setting up custom ingress TLS ciphers

In the `tap-values.yaml` file, `tls.server.rfcCiphers` are set as shown in the following YAML:

```
metadata_store:
  tls:
    server:
      rfcCiphers:
        - TLS_AES_128_GCM_SHA256
        - TLS_AES_256_GCM_SHA384
        - TLS_ECDHE_ECDSA_WITH_AES_128_GCM_SHA256
        - TLS_ECDHE_ECDSA_WITH_AES_256_GCM_SHA384
        - TLS_ECDHE_RSA_WITH_AES_128_GCM_SHA256
        - TLS_ECDHE_RSA_WITH_AES_256_GCM_SHA384
```

Where `tls.server.rfcCiphers` is a list of cipher suites for the server. Values are from the [Go TLS package constants](#). If you omit values, the default Go cipher suites are used. These are the default values:

- `TLS_AES_128_GCM_SHA256`
- `TLS_AES_256_GCM_SHA384`
- `TLS_ECDHE_ECDSA_WITH_AES_128_GCM_SHA256`
- `TLS_ECDHE_ECDSA_WITH_AES_256_GCM_SHA384`
- `TLS_ECDHE_RSA_WITH_AES_128_GCM_SHA256`
- `TLS_ECDHE_RSA_WITH_AES_256_GCM_SHA384`

Example custom TLS settings

The following is a complete example of TLS configuration:

```
metadata_store:
  tls:
    namespace: NAMESPACE
    secretName: SECRET-NAME
    server:
      rfcCiphers:
        - TLS_AES_128_GCM_SHA256
        - TLS_AES_256_GCM_SHA384
```

```

- TLS_ECDHE_ECDSA_WITH_AES_128_GCM_SHA256
- TLS_ECDHE_ECDSA_WITH_AES_256_GCM_SHA384
- TLS_ECDHE_RSA_WITH_AES_128_GCM_SHA256
- TLS_ECDHE_RSA_WITH_AES_256_GCM_SHA384

```

Where:

- `NAMESPACE` is the name of the namespace you want to configure TLS with.
- `SECRET-NAME` is the name of the secret you want to configure TLS with.

Additional resources

- [Custom certificate configuration](#)
- [Ingress support](#)

Certificate rotation for Supply Chain Security Tools - Store

This topic tells how you to rotate TLS certificates for Supply Chain Security Tools (SCST) - Store.

Certificates

By default, the `use_cert_manager` setting is set to `"true"`. When the setting `use_cert_manager` is `"true"` the Store uses `cert-manager` to generate a certificate authority (CA) certificate, an API certificate, and a database Certificate.

To see these certificates run:

```
kubectl get certificate -n metadata-store
```

For example:

```

$ kubectl get certificate -n metadata-store
NAME                READY   SECRET                AGE
app-tls-ca-cert     True    app-tls-ca-cert       38d
app-tls-cert        True    app-tls-cert          38d
postgres-db-tls-cert True    postgres-db-tls-cert  38d

```

`cert-manager` automatically rotates the earlier certificates. The Store can run these certificates automatically after `cert-manager` rotates them.

If the environment is a [multi-cluster](#) setup, the operator must manually copy the new CA certificate to the build cluster.

Certificate duration setting

In `tap-values.yaml`, `api_cert_duration`, `api_cert_renew_before`, `ca_cert_duration`, and `ca_cert_renew_before` are configurable as shown in the following YAML:

```

metadata_store:
  ca_cert_duration: CA-DURATION
  ca_cert_renew_before: CA-RENEW
  api_cert_duration: API-DURATION
  api_cert_renew_before: API-RENEW

```

Where:

- `CA-DURATION` is the duration that the CA certificate is valid for. It must be entered as `h`, `m`, or `s`. The default value is `8760h`.

- `CA-RENEW` is time period before the expiry of the CA certificate is renewed. It must be entered as `h`, `m`, or `s`. The default value is `1h`.
- `API-DURATION` is the duration that the API certificate is valid for. It must be entered as `h`, `m`, or `s`. The default value is `2160h`.
- `API-RENEW` is the time period before the expiry time of the API certificate is renewed. It must be entered as `h`, `m`, or `s`. The default value is `24h`.



Important

The `*_cert_duration` and the corresponding `*_renew_before` settings must not be close together. For more information, see the [cert-manager documentation](#). This can lead to a renewal loop. The `*_cert_duration` must be greater than the corresponding `*_renew_before`. The earlier settings only take effect when `use_cert_manager` is `"true"`. If the `use_cert_manager` is not set, it is `"true"` by default.

Ingress support for Supply Chain Security Tools - Store

This topic describes how to configure ingress for Supply Chain Security Tools (SCST) - Store.

Ingress configuration

Supply Chain Security Tools (SCST) - Store has ingress support by using Contour's HTTPProxy resources. To enable ingress support, a Contour installation must be available in the cluster.

To change ingress configuration, edit your `tap-values.yaml` when you install a Tanzu Application Platform profile. When you configure the `shared.ingress_domain` property, SCST - Store automatically uses that setting.

Alternatively, you can customize SCST - Store's configuration under the `metadata_store` property. Under `metadata_store`, there are two values to configure the proxy:

- `ingress_enabled`
- `ingress_domain`

This is an example snippet in a `tap-values.yaml`:

```
...
metadata_store:
  ingress_enabled: "true"
  ingress_domain: "example.com"
  app_service_type: "ClusterIP" # Defaults to `LoadBalancer`. If ingress is enabled t
hen this must be set to `ClusterIP`.
...
```

SCST - Store installation creates an HTTPProxy entry with host routing by using the qualified name `METADATA-STORE.INGRESS-DOMAIN`. For example, `metadata-store.example.com`. The route supports HTTPS communication using a certificate. By default, a self-signed certificate is used with the same subject `alternative name`. For more information, see [Custom certificate configuration](#).

Contour and DNS setup are not part of SCST - Store installation. Access to SCST - Store using Contour depends on the correct configuration of these two components.

Make the proper DNS record available to clients to resolve `metadata-store` and set `ingress_domain` to Envoy service's external IP address.

DNS setup example:

```

$ kubectl describe svc envoy -n tanzu-system-ingress
> ...
Type:                               LoadBalancer
...
LoadBalancer Ingress:                100.2.3.4
...
Port:                                 https 443/TCP
...

$ nslookup metadata-store.example.com
> Server:      8.8.8.8
Address:      8.8.8.8#53

Non-authoritative answer:
Name:   metadata-store.example.com
Address: 100.2.3.4

$ curl https://metadata-store.example.com/api/health -k -v
> ...
< HTTP/2 200
...

```



Note

The preceding `curl` example uses the not secure `-k` flag to skip TLS verification because the Store installs a self-signed certificate. The following section shows how to access the CA certificate to enable TLS verification for HTTP clients.

Get the TLS CA certificate

To get SCST - Store's TLS CA certificate, use `kubectl get secret`. In this example, you save the certificate for the environment variable to a file.

```

kubectl get secret CERT-NAME -n metadata-store -o json | jq -r '.data."ca.crt"' | base64 -d > OUTPUT-FILE

```

Where:

- `CERT-NAME` is the name of the certificate. This must be `ingress-cert` if no custom certificate is used.
- `OUTPUT-FILE` is the file you want to create to store the certificate.

For example:

```

$ kubectl get secret tap-ingress-selfsigned-root-ca -n cert-manager -o json | jq -r '.data."ca.crt"' | base64 -d > insight-ca.crt
$ cat insight-ca.crt

```

Additional Resources

- [Custom certificate configuration](#)
- [TLS configuration](#)
- [Certificate rotation](#)
- [Configure target endpoint and certificate](#)

Use your LoadBalancer with Supply Chain Security Tools - Store

This topic describes how to use your LoadBalancer with Supply Chain Security Tools (SCST) - Store.

Configure LoadBalancer



Note

`LoadBalancer` is not the recommended service type. Consider the recommended configuration of enabling [Ingress](#).

To configure a `LoadBalancer`:

1. Edit `/etc/hosts/` to use the external IP address of the `metadata-store-app` service.

```
METADATA_STORE_IP=$(kubectl get service/metadata-store-app --namespace metadata-store -o jsonpath="{.status.loadBalancer.ingress[0].ip}")
METADATA_STORE_PORT=$(kubectl get service/metadata-store-app --namespace metadata-store -o jsonpath="{.spec.ports[0].port}")
METADATA_STORE_DOMAIN="metadata-store-app.metadata-store.svc.cluster.local"

# Delete any previously added entry
sudo sed -i '' "/$METADATA_STORE_DOMAIN/d" /etc/hosts

echo "$METADATA_STORE_IP $METADATA_STORE_DOMAIN" | sudo tee -a /etc/hosts > /dev/null
```



Note

On EKS, you must get the IP address for the LoadBalancer. Find the IP address by running something similar to the following: `dig RANDOM-SHA.us-east-2.elb.amazonaws.com`. Where `RANDOM-SHA` is the EXTERNAL-IP received for the LoadBalancer.

2. Select one of the IP addresses returned from the `dig` command and write it to the `/etc/hosts` file.

Port forwarding

If you want to use port forwarding instead of the external IP address from the `LoadBalancer`, follow these steps:

Configure port-forwarding for the service so that the insight plug-in can access SCST - Store. You can configure port-forwarding in a separate terminal window or in the background.

From a separate terminal window, run:

```
kubectl port-forward service/metadata-store-app 8443:8443 -n metadata-store
```

Alternatively, run the following command in the background:

```
kubectl port-forward service/metadata-store-app 8443:8443 -n metadata-store &
```

Edit your `/etc/hosts` file for port-forwarding

Use the following script to add a new local entry to `/etc/hosts`:

```
METADATA_STORE_PORT=$(kubectl get service/metadata-store-app --namespace metadata-store -o jsonpath="{.spec.ports[0].port}")
METADATA_STORE_DOMAIN="metadata-store-app.metadata-store.svc.cluster.local"

# delete any previously added entry
sudo sed -i '' "/$METADATA_STORE_DOMAIN/d" /etc/hosts

echo "127.0.0.1 $METADATA_STORE_DOMAIN" | sudo tee -a /etc/hosts > /dev/null
```

Configure the Insight plug-in

Because you deployed Supply Chain Security Tools (SCST) - Store without using Ingress, you must use the Certificate resource `app-tls-cert` for HTTPS communication.

To get the CA Certificate:

```
kubectl get secret app-tls-cert -n metadata-store -o json | jq -r '.data."ca.crt"' | base64 -d > insight-ca.crt
```

Set the target by running:

```
tanzu insight config set-target https://$METADATA_STORE_DOMAIN:$METADATA_STORE_PORT --ca-cert insight-ca.crt
```



Important

The `tanzu insight config set-target` does not initiate a test connection. Use `tanzu insight health` to test connecting using the configured endpoint and CA certificate. Neither commands test whether the access token is correct. For that you must use the plug-in to [add data](#) and [query data](#).

Use your NodePort with Supply Chain Security Tools - Store

This topic describes how you can use your NodePort with Supply Chain Security Tools (SCST) - Store.

Overview



Note

The recommended service type is [Ingress](#). NodePort is only recommended when the cluster does not support [Ingress](#) or the cluster does not support the [LoadBalancer](#) service type. [NodePort](#) is not supported for a multicluster setup, as certificates cannot be modified.

You must use port forwarding when using the `NodePort` configuration.

Configure port-forwarding for the service so that the insight plug-in can access SCST - Store. You can configure port-forwarding in a separate terminal window or in the background.

From a separate terminal window, run:

```
kubectl port-forward service/metadata-store-app 8443:8443 -n metadata-store
```

Alternatively, run the following command in the background:

```
kubectl port-forward service/metadata-store-app 8443:8443 -n metadata-store &
```

Edit your `/etc/hosts` file for port-forwarding

Use the following script to add a new local entry to `/etc/hosts`:

```
METADATA_STORE_PORT=$(kubectl get service/metadata-store-app --namespace metadata-store -o jsonpath="{.spec.ports[0].port}")
METADATA_STORE_DOMAIN="metadata-store-app.metadata-store.svc.cluster.local"

# delete any previously added entry
sudo sed -i '' "/$METADATA_STORE_DOMAIN/d" /etc/hosts

echo "127.0.0.1 $METADATA_STORE_DOMAIN" | sudo tee -a /etc/hosts > /dev/null
```

Configure the Insight plug-in

Because you deployed Supply Chain Security Tools (SCST) - Store without using Ingress, you must use the Certificate resource `app-tls-cert` for HTTPS communication.

To get the CA Certificate:

```
kubectl get secret app-tls-cert -n metadata-store -o json | jq -r '.data."ca.crt"' | base64 -d > insight-ca.crt
```

Set the target by running:

```
tanzu insight config set-target https://$METADATA_STORE_DOMAIN:$METADATA_STORE_PORT --ca-cert insight-ca.crt
```



Important

The `tanzu insight config set-target` does not initiate a test connection. Use `tanzu insight health` to test connecting using the configured endpoint and CA certificate. Neither commands test whether the access token is correct. For that you must use the plug-in to [add data](#) and [query data](#).

Multicluster setup for Supply Chain Security Tools - Store

This topic describes how you can deploy Supply Chain Security Tools (SCST) - Store in a multicluster setup, including installing multiple profiles such as, View, Build, Run, and Iterate.

Overview

SCST - Store is deployed with the View profile. After installing the View profile, but before installing the Build profile, you must add configuration for SCST - Store to the Kubernetes cluster where you intend to install the Build profile. This topic explains how to add configuration which allows components in the Build cluster to communicate with SCST - Store in the View cluster.



Note

If you already deployed the Build profile, you can follow this procedure. However, in the [Install Build profile](#) step, instead of deploying the Build profile again, update your deployment using `tanzu package installed update`.

Prerequisites

You must install the View profile. See [Install View profile](#).

Procedure summary

1. Copy SCST - Store CA certificate from the View cluster.
2. Copy SCST - Store authentication token from the View cluster.
3. Apply the CA certificate and authentication token to the Kubernetes cluster where you intend to install the Build profile.
4. Install the Build profile.

Copy SCST - Store CA certificate from View cluster

With your kubectl targeted at the View cluster, you can view SCST - Store's TLS CA certificate. Run these commands to copy the CA certificate into a file `store_ca.yaml`.

```
CA_CERT=$(kubectl get secret -n metadata-store CERT-NAME -o json | jq -r ".data.\"ca.crt\"")
cat <<EOF > store_ca.yaml
---
apiVersion: v1
kind: Secret
type: Opaque
metadata:
  name: store-ca-cert
  namespace: metadata-store-secrets
data:
  ca.crt: $CA_CERT
EOF
```

Where `CERT-NAME` is the name of the certificate you want to reference in `store_ca.yaml`.

For example:

```
$ CA_CERT=$(kubectl get secret -n metadata-store ingress-cert -o json | jq -r ".data.\"ca.crt\"")
$ cat <<EOF > store_ca.yaml
---
apiVersion: v1
kind: Secret
type: Opaque
metadata:
  name: store-ca-cert
  namespace: metadata-store-secrets
data:
  ca.crt: $CA_CERT
EOF
```

Copy SCST - Store authentication token from the View cluster

Copy the SCST - Store authentication token into an environment variable. You use this environment variable in the next step.

```
AUTH_TOKEN=$(kubectl get secrets metadata-store-read-write-client -n metadata-store -o jsonpath="{.data.token}" | base64 -d)
```

Apply the CA certificate and authentication token to a new Kubernetes cluster

Before you deploy the Build profile, you must apply the CA certificate and authentication token from the earlier steps. Then the Build profile deployment has access to these values.

To apply the CA certificate and authentication token:

1. With your `kubectl` targeted at the Build cluster, create a namespace for the CA certificate and authentication token.

```
kubectl create ns metadata-store-secrets
```

2. Apply the CA certificate `store_ca.yaml` secret YAML you generated earlier.

```
kubectl apply -f store_ca.yaml
```

3. Create a secret to store the access token. This uses the `AUTH_TOKEN` environment variable.

```
kubectl create secret generic store-auth-token \
  --from-literal=auth_token=$AUTH_TOKEN -n metadata-store-secrets
```

The cluster now has a CA certificate named `store-ca-cert` and authentication token named `store-auth-token` in the namespace `metadata-store-secrets`.

Install Build profile

If you came to this topic from the [Install multicluster Tanzu Application Platform profiles](#) topic after installing the View profile, return to that topic to [install the Build profile](#).

The Build profile `values.yaml` contains configuration that references the secrets in the `metadata-store-secrets` namespace you created in this guide. The names of these secrets are hard coded in the example `values.yaml`.

More information about how Build profile uses the configuration

The secrets you created are used in the Build profile `values.yaml` to configure the Grype scanner which talks to SCST - Store. After performing a vulnerabilities scan, the Grype scanner sends the results to SCST - Store. Here's a snippet of what the configuration might look like.

```
...
grype:
  namespace: "MY-DEV-NAMESPACE" # (Optional) Defaults to default namespace.
  targetImagePullSecret: "TARGET-REGISTRY-CREDENTIALS-SECRET"
  metadataStore:
    url: METADATA-STORE-URL-ON-VIEW-CLUSTER # Url with http / https
    caSecret:
      name: store-ca-cert
      importFromNamespace: metadata-store-secrets # Must match with `ingress-cert.data."ca.crt"` of store on view cluster
    authSecret:
      name: store-auth-token # Must match with valid store token of metadata-store on view cluster
```

```
importFromNamespace: metadata-store-secrets
...
```

Where:

- `METADATA-STORE-URL-ON-VIEW-CLUSTER` is the ingress URL of SCST - Store deployed to the View cluster. For example, <https://metadata-store.example.com>. See [Ingress support](#).
- `TARGET-REGISTRY-CREDENTIALS-SECRET` is the name of the secret that contains the credentials to pull an image from the registry for scanning.
- `MY-DEV-NAMESPACE` is the name of the developer namespace. SCST - Scan deploys the ScanTemplates there. This allows the scanning feature to run in this namespace.

Configure developer namespaces

After you finish the entire Tanzu Application Platform installation process, you are ready to configure developer namespaces. To prepare developer namespaces, you must export the secrets you created earlier to those namespaces.

Exporting SCST - Store secrets to a developer namespace in a Tanzu Application Platform multicluster deployment

Export secrets to a developer namespace by creating `SecretExport` resources on the developer namespace. Run the following command to create the `SecretExport` resources. You must have created and populated the `metadata-store-secrets` namespace.

```
cat <<EOF | kubectl apply -f -
---
apiVersion: secretgen.carvel.dev/v1alpha1
kind: SecretExport
metadata:
  name: store-ca-cert
  namespace: metadata-store-secrets
spec:
  toNamespaces: [DEV-NAMESPACES]
---
apiVersion: secretgen.carvel.dev/v1alpha1
kind: SecretExport
metadata:
  name: store-auth-token
  namespace: metadata-store-secrets
spec:
  toNamespaces: [DEV-NAMESPACES]
EOF
```

Where `[DEV-NAMESPACES]` is an array of developer namespaces where the secrets are exported.

More detailed description of `metadata` configuration can be found at [Cluster Specific Store Configuration](#)

Additional resources

- [Ingress support](#)
- [Custom certificate configuration](#)

Developer namespace setup for Supply Chain Security Tools - Store

This topic tells how you to set up your developer namespace for Supply Chain Security Tools (SCST) - Store.

Overview

After you finish installing Tanzu Application Platform, you are ready to configure the developer namespace. When you configure a developer namespace, you must export the SCST - Store certificate authority (CA) certificate and authentication token to the namespace. This enables SCST - Scan to find the credentials to send scan results to SCST - Store.

There are two ways to deploy Tanzu Application Platform:

- The single-cluster method, which uses the Tanzu Application Platform values file
- The multicluster method, which uses `SecretExport`

Single cluster - using the Tanzu Application Platform values file

To use `tap-values.yaml` to deploy Tanzu Application Platform, if using a single cluster:

1. When deploying the Tanzu Application Platform Full or Build profile, edit `tap-values.yaml` as follows:

```
metadata_store:
  ns_for_export_app_cert: "DEV-NAMESPACE"
```

Where `DEV-NAMESPACE` is the name of the developer namespace.

The `ns_for_export_app_cert` supports only one namespace at a time. If you have multiple namespaces, you can replace this value with a `"*"`. For example:

```
metadata_store:
  ns_for_export_app_cert: "*"
```



Caution

The use `"*"` entails exporting the CA to all namespaces. Consider whether this increased visibility is a risk.

1. Update Tanzu Application Platform to apply the changes by running:

```
tanzu package installed update tap -f tap-values.yaml -n tap-install
```

Multicluster - using `SecretExport`

In a multicluster deployment, follow the steps in [Multicluster setup for SCST - Store](#), which describe how to create secrets and export secrets to developer namespaces.

Next steps

If you arrived in this topic from [Out of the Box Supply Chain with Testing and Scanning for Supply Chain Choreographer](#), return to that topic and continue with the instructions.

Retrieve access tokens for Supply Chain Security Tools - Store

This topic describes how you can retrieve access tokens for Supply Chain Security Tools (SCST) - Store.

Overview

When you install Tanzu Application Platform, the Supply Chain Security Tools (SCST) - Store deployment automatically includes a read-write service account. This service account is bound to the `metadata-store-read-write` role.

There are two types of SCST - Store service accounts:

1. Read-write service account - full access to the `POST` and `GET` API requests
2. Read-only service account - can only use `GET` API requests

This topic shows how to retrieve the access token for these service accounts.

Retrieving the read-write access token

To retrieve the read-write access token, run:

```
kubectl get secrets metadata-store-read-write-client -n metadata-store -o jsonpath="{.data.token}" | base64 -d
```

Retrieving the read-only access token

In order to retrieve the read-only access token, you must first have a read-only service account. See [Create read-only service account](#).

To retrieve the read-only access token, run:

```
kubectl get secrets metadata-store-read-client -n metadata-store -o jsonpath="{.data.token}" | base64 -d
```

Using an access token

The access token is a Bearer token used in the http request header `Authorization`. For example, `Authorization: Bearer eyJhbGciOiJSUzI1NiIsImtpZCI6IjhmV0...`

Additional Resources

- [Create service accounts](#)
- [Create a service account with a custom cluster role](#)

Retrieve and create service accounts for Supply Chain Security Tools - Store

This topic explains how you can create service accounts for Supply Chain Security Tools (SCST) - Store.

Overview

When you install Tanzu Application Platform, the SCST - Store deployment automatically includes a read-write service account. This service account is bound to the `metadata-store-read-write` role.

There are two types of SCST - Store service accounts:

- The read-write service account, which is for full access to the `POST` and `GET` API requests
- The read-only service account, which can only use `GET` API requests

Create read-write service account

When you install Tanzu Application Platform, the SCST - Store deployment automatically includes a read-write service account. This service account is already bound to the `metadata-store-read-write` role.

To create an additional read-write service account, create a service account called `metadata-store-read-write-client` by running:

```
kubectl apply -f - --o yaml << EOF
apiVersion: rbac.authorization.k8s.io/v1
kind: Role
metadata:
  name: metadata-store-read-write
  namespace: metadata-store
rules:
- resources: ["all"]
  verbs: ["get", "create", "update"]
  apiGroups: [ "metadata-store/v1" ]
---
apiVersion: rbac.authorization.k8s.io/v1
kind: RoleBinding
metadata:
  name: metadata-store-read-write
  namespace: metadata-store
roleRef:
  apiGroup: rbac.authorization.k8s.io
  kind: Role
  name: metadata-store-read-write
subjects:
- kind: ServiceAccount
  name: metadata-store-read-write-client
  namespace: metadata-store
---
apiVersion: v1
kind: ServiceAccount
metadata:
  name: metadata-store-read-write-client
  namespace: metadata-store
  annotations:
    kapp.k14s.io/change-group: "metadata-store.apps.tanzu.vmware.com/service-account"
automountServiceAccountToken: false
---
apiVersion: v1
kind: Secret
type: kubernetes.io/service-account-token
metadata:
  name: metadata-store-read-write-client
  namespace: metadata-store
  annotations:
    kapp.k14s.io/change-rule: "upsert after upserting metadata-store.apps.tanzu.vmware.com/service-account"
    kubernetes.io/service-account.name: "metadata-store-read-write-client"
EOF
```

Create a read-only service account

You can create a read-only service account with a default cluster role or with a custom cluster role.

With a default cluster role

During Store installation, the `metadata-store-read-only` cluster role is created by default. This cluster role permits the bound user to have `get` access to all resources. To bind to this cluster role, run the following command:

```
kubectl apply -f - -o yaml << EOF
---
apiVersion: rbac.authorization.k8s.io/v1
kind: ClusterRoleBinding
metadata:
  name: metadata-store-read-only
roleRef:
  apiGroup: rbac.authorization.k8s.io
  kind: ClusterRole
  name: metadata-store-read-only
subjects:
- kind: ServiceAccount
  name: metadata-store-read-client
  namespace: metadata-store
---
apiVersion: v1
kind: ServiceAccount
metadata:
  name: metadata-store-read-client
  namespace: metadata-store
  annotations:
    kapp.k14s.io/change-group: "metadata-store.apps.tanzu.vmware.com/service-account"
  automountServiceAccountToken: false
---
apiVersion: v1
kind: Secret
type: kubernetes.io/service-account-token
metadata:
  name: metadata-store-read-client
  namespace: metadata-store
  annotations:
    kapp.k14s.io/change-rule: "upsert after upserting metadata-store.apps.tanzu.vmware.com/service-account"
    kubernetes.io/service-account.name: "metadata-store-read-client"
EOF
```

With a custom cluster role

If the default role is not enough for your needs, see [Create a service account with a custom cluster role](#).

Additional Resources

- [Retrieve access tokens](#)
- [Create a service account with a custom cluster role](#)

Create a service account with a custom cluster role for Supply Chain Security Tools - Store

This topic describes how you can create a service account with a custom cluster role for Supply Chain Security Tools (SCST) - Store.

Example service account

If you do not want to bind to the default cluster role, create a read-only role in the `metadata-store` namespace with a service account. The following command creates a service account named `metadata-store-read-client`:

```
kubectl apply -f - -o yaml << EOF
apiVersion: rbac.authorization.k8s.io/v1
kind: Role
metadata:
  name: metadata-store-ro
  namespace: metadata-store
rules:
- resources: ["all"]
  verbs: ["get"]
  apiGroups: [ "metadata-store/v1" ]
---
apiVersion: rbac.authorization.k8s.io/v1
kind: RoleBinding
metadata:
  name: metadata-store-ro
  namespace: metadata-store
roleRef:
  apiGroup: rbac.authorization.k8s.io
  kind: Role
  name: metadata-store-ro
subjects:
- kind: ServiceAccount
  name: metadata-store-read-client
  namespace: metadata-store
---
apiVersion: v1
kind: ServiceAccount
metadata:
  name: metadata-store-read-client
  namespace: metadata-store
  annotations:
    kapp.k14s.io/change-group: "metadata-store.apps.tanzu.vmware.com/service-account"
automountServiceAccountToken: false
---
apiVersion: v1
kind: Secret
type: kubernetes.io/service-account-token
metadata:
  name: metadata-store-read-client
  namespace: metadata-store
  annotations:
    kapp.k14s.io/change-rule: "upsert after upserting metadata-store.apps.tanzu.vmware.com/service-account"
    kubernetes.io/service-account.name: "metadata-store-read-client"
EOF
```

Additional Resources

- [Retrieve access tokens](#)
- [Create service accounts](#)

Install Supply Chain Security Tools - Store

This topic describes how you can install Supply Chain Security Tools (SCST) - Store independently from Tanzu Application Platform (commonly known as TAP) profiles.



Note

Follow the steps in this topic if you do not want to use a profile to install Supply Chain Security Tools - Store. For more information about profiles, see [Components and installation profiles](#).

Prerequisites

Before installing SCST - Store from the Tanzu Application Platform package repository:

- Complete all prerequisites to install Tanzu Application Platform. For more information, see [Prerequisites](#).
- Install cert-manager on the cluster. See [Install cert-manager](#).
- See [Deployment Details and Configuration](#) to review what resources are deployed. For more information, see the [overview](#).
- Create ClusterIssuer

```
kubectl apply -f - <<EOF
apiVersion: cert-manager.io/v1
  kind: ClusterIssuer
  metadata:
    name: tap-ingress-selfsigned
  spec:
    selfSigned: {}
EOF
```

Install

To install SCST - Store:

1. To use this deployment, the user must have set up the Kubernetes cluster to provision persistent volumes on demand. Ensure that a default storage class is available in your cluster. Verify whether default storage class is set in your cluster using `kubectl get storageClass`.

```
kubectl get storageClass
```

For example:

```
$ kubectl get storageClass
NAME                                PROVISIONER                RECLAIMPOLICY   VOLUMEBINDINGMODE
ALLOWVOLUMEEXPANSION  AGE
standard (default)      rancher.io/local-path     Delete          WaitForFirstConsumer
er  false                7s
```

2. List version information for the package using `tanzu package available list`.

```
tanzu package available list metadata-store.apps.tanzu.vmware.com --namespace tap-install
```

For example:

```
$ tanzu package available list metadata-store.apps.tanzu.vmware.com --namespace tap-install
- Retrieving package versions for metadata-store.apps.tanzu.vmware.com...
  NAME                                VERSION    RELEASED-AT
  metadata-store.apps.tanzu.vmware.com  1.0.2
```

3. (Optional) List all the available deployment configuration options.

```
tanzu package available get metadata-store.apps.tanzu.vmware.com/VERSION --values-schema -n tap-install
```

Where **VERSION** is the your package version number.

For example:

```
$ tanzu package available get metadata-store.apps.tanzu.vmware.com/1.0.2 --values-schema -n tap-install
| Retrieving package details for metadata-store.apps.tanzu.vmware.com/1.0.2...
  KEY                                DEFAULT
  TYPE    DESCRIPTION
  pg_limit_memory                4Gi
string    Memory limit for postgres container in metadata-store-db deployment
  tls.namespace
string    The targeted namespace for secret consumption by the HTTPProxy.
  add_default_rw_service_account true
string    Adds a read-write service account which can be used to obtain access token to use metadata-store CLI
  api_host                        localhost
string    The internal hostname for the metadata api endpoint. This will be used by the kube-rbac-proxy sidecar.
  app_replicas                    1
integer   The number of replicas for the metadata-store-app
  ingress_domain
string    Domain to be used by the HTTPProxy ingress object. The "metadata-store" subdomain will be prepended to the value provided. For example: "example.com" would become "metadata-store.example.com". Required if ingress_enabled is true.
  kube_rbac_proxy_limit_cpu       250m
string    CPU limit for kube-rbac-proxy container in the metadata-store-app deployment
  pg_limit_cpu                    2Gi
string    CPU limit for postgres container in metadata-store-db deployment
  tls.server.minTLSVersion        VersionTLS12
string    Minimum TLS version supported. Value must match version names from https://golang.org/pkg/crypto/tls/#pkg-constants. (default "VersionTLS12")
  db_host                          metadata-store-db
string    The address to the postgres database host that the metadata-store app uses to connect. The default is set to metadata-store-db which is the postgres service name. Changing this does not change the postgres service name
  db_replicas                      1
integer   The number of replicas for the metadata-store-db
  pg_req_cpu                       1Gi
string    CPU request for postgres container in metadata-store-db deployment
  priority_class_name
string    If specified, this value is the name of the desired PriorityClass for the metadata-store-db deployment
  tls.secretName
string    The name of secret for consumption by the HTTPProxy.
  db_ca_certificate
string    This should only be set in the case when 'deploy_internal_db' is 'false'. Set this to the trusted CA Certificate that signed the Postgres DB TLS Certificate
  db_password
string    The database user password. If no value is provided, a 32 character value will be generated.
```

```

db_port 5432
string The database port to use. This is the port to use when connecting to the database pod.
app_limit_cpu 250m
string CPU limit for metadata-store-app container
auth_proxy_host 0.0.0.0
string The binding ip address of the kube-rbac-proxy sidecar
db_max_open_conns 10
integer Sets the maximum number of open database connections from the Metadata Store to the database.
db_name metadata-store
string The name of the database to use.
db_user metadata-store-user
string The database user to create and use for updating and querying. The metadata postgres section create this user. The metadata api server uses this user name to connect to the database.
kube_rbac_proxy_req_memory 128Mi
string Memory request for kube-rbac-proxy container in the metadata-store-app deployment
auth_proxy_port 8443
integer The external port address of the of the kube-rbac-proxy sidecar
db_conn_max_lifetime 60
integer Sets the maximum amount of time a database connection may be reused in seconds.
ingress_enabled false
string Contour is required to be installed to use this flag. When true, this creates an HTTPProxy object for the metadata-store. If false, then no ingress is configured.
storage_class_name
string The storage class name of the persistent volume used by Postgres database for storing data. The default value will use the default class name defined on the cluster.
api_port 9443
integer The internal port for the metadata app api endpoint. This will be used by the kube-rbac-proxy sidecar.
app_service_type LoadBalancer
string The type of service to use for the metadata app service. This can be set to 'Nodeport', 'ClusterIP' or 'LoadBalancer'.
db_sslmode verify-full
string Determines the security connection between API server and Postgres database. This can be set to 'verify-ca' or 'verify-full'
use_cert_manager true
string Cert manager is required to be installed to use this flag. When true, this creates certificates object to be signed by cert manager for the API server and Postgres database. If false, the certificate object have to be provided by the user.
app_req_cpu 100m
string CPU request for metadata-store-app container
database_request_storage 10Gi
string The storage requested of the persistent volume used by Postgres database for storing data.
deploy_internal_db true
string If set to 'true', a postgres deployment will be created. If set to 'false', db_host and db_port should point to an accessible postgres instance. Postgres connections require TLS, so the corresponding db_ca_certification must be provided
kube_rbac_proxy_req_cpu 100m
string CPU request for kube-rbac-proxy container in the metadata-store-app deployment
ns_for_export_app_cert scan-link-system
string The namespace where the "Supply Chain Security Tools for VMware Tanzu - Scan" component is installed in. Certain certificates will be exported to that namespace so that scan reports can be posted to the Metadata Store.
pg_req_memory 1Gi
string Memory request for postgres container in metadata-store-db deployment
app_limit_memory 512Mi

```

```

string    Memory limit for metadata-store-app container
  app_req_memory          128Mi
string    Memory request for metadata-store-app container
  db_max_idle_conns      100
integer   Sets the maximum number of database connections from the Metadata Store
in the idle connection pool.
  kube_rbac_proxy_limit_memory  512Mi
string    Memory limit for kube-rbac-proxy container in the metadata-store-app deployment
  kubernetes_distribution
string    Kubernetes platform distribution where the metadata-store is being installed on. Accepted values: ["", "openshift"]
  log_level              default
string    Sets the log level. This can be set to "minimum", "less", "default", "more", "debug" or "trace". "minimum" currently does not output logs. "less" outputs log configuration options only. "default" and "more" outputs API endpoint access information. "debug" and "trade" outputs extended API endpoint
access information(such as body payload) and other debug information.
  tls.server.rfcCiphers    [TLS_AES_128_GCM_SHA256 TLS_AES_256_GCM_SHA384 TLS_ECDHE_ECDSA_WITH_AES_128_GCM_SHA256 TLS_ECDHE_ECDSA_WITH_AES_256_GCM_SHA384 TLS_ECDHE_RSA_WITH_AES_128_GCM_SHA256 TLS_ECDHE_RSA_WITH_AES_256_GCM_SHA384]
array     List of cipher suites for the server. Values are from tls package constants (https://golang.org/pkg/crypto/tls/#pkg-constants). If omitted, the default Go cipher suites will be used
  ingress_issuer          tap-ingress-selfsigned
string    tap-ingress-selfsigned is the default value when installed via any TAP profile. When installing only the metadata-store package, a ClusterIssuer needs to be installed and its name needs to be specified as this value.

```

- (Optional) Edit one of the deployment configurations by creating a configuration YAML with the custom configuration values you want. For example, if your environment does not support `LoadBalancer`, and you want to use `ClusterIP`, then create a `metadata-store-values.yaml` and configure the `app_service_type` property.

```

---
app_service_type: "ClusterIP"

```

See [Deployment details and configuration](#) for more information about configuration options.

For information about ingress and custom domain name support, see [Ingress support](#).

- Install the package using `tanzu package install`.

```

tanzu package install metadata-store \
  --package metadata-store.apps.tanzu.vmware.com \
  --version VERSION \
  --namespace tap-install \
  --values-file metadata-store-values.yaml

```

Where:

- `--values-file` is an optional flag. Only use it to customize the deployment configuration.
- `VERSION` is the package version number.

For example:

```

$ tanzu package install metadata-store \
  --package metadata-store.apps.tanzu.vmware.com \
  --version 1.0.2 \
  --namespace tap-install \
  --values-file metadata-store-values.yaml

```

```

- Installing package 'metadata-store.apps.tanzu.vmware.com'
/ Getting namespace 'tap-install'
- Getting package metadata for 'metadata-store.apps.tanzu.vmware.com'
/ Creating service account 'metadata-store-tap-install-sa'
/ Creating cluster admin role 'metadata-store-tap-install-cluster-role'
/ Creating cluster role binding 'metadata-store-tap-install-cluster-rolebinding'
/ Creating secret 'metadata-store-tap-install-values'
| Creating package resource
- Package install status: Reconciling

Added installed package 'metadata-store' in namespace 'tap-install'

```

Prerequisite for Standalone SCST - Store

The following prerequisites are required to install SCST - Store individually, instead of by using a profile:

1. Install the SelfSigned Cluster Issuer:

```

# Install `tap-ingress-selfsigned` ClusterIssuer
cat << EOF > /tmp/tap-ingress-selfsigned-cluster-issuer.yaml
apiVersion: cert-manager.io/v1
kind: ClusterIssuer
metadata:
  name: tap-ingress-selfsigned
spec:
  selfSigned: {}
EOF

kapp deploy -a issuer -f /tmp/tap-ingress-selfsigned-cluster-issuer.yaml -y

```

2. Install SCST - Store and update the certificate:

```

cat << EOF > /tmp/ingress-issuer-cert.yaml
apiVersion: cert-manager.io/v1
kind: Certificate
metadata:
  name: ingress-cert
  namespace: metadata-store
spec:
  isCA: true
  dnsNames:
    - metadata-store.${INGRESS_DOMAIN}
  issuerRef:
    kind: ClusterIssuer
    name: tap-ingress-selfsigned
    group: cert-manager.io
  secretName: ingress-cert
  commonName: metadata-store-ca
EOF

kubectl apply -f /tmp/ingress-issuer-cert.yaml
# `ingress-cert` is deleted. It will be automatically created again with newly
applied ClusterIssuer cert
kubectl delete secret ingress-cert -n metadata-store

```

These steps ensure that you have valid certificate after SCST - Store installation is complete.

Supply Chain Security Tools - Store Database Index Corruption

This topic tells you how to troubleshoot the Metadata Store database index issue after upgrading from v1.5 to a later version of Supply Chain Security Tools (SCST) - Store.

Overview

The index corruption happened because of a base OS upgrade in the PostgreSQL database images to address some of the CVE which includes a breaking change in `glibc locale` library.

- In Tanzu Application Platform v1.5 and earlier, `Postgres-bionic-13:1.22.0` uses `ubuntu:18.04`, which includes `ubuntu/glibc 2.27-3ubuntu1.6`.
- In Tanzu Application Platform v1.6 and later, `Postgres-bionic-13:1.23.0` uses `ubuntu:22.04` and `jammy-20221101`, which includes `ubuntu/glibc 2.35-0ubuntu3.1`.

`glibc v2.28` includes a major update for the locale data, which might corrupt indices after upgrading. For more information, see the [PostgreSQL wiki](#).

Solve a database index corruption issue reported in Metadata Store App Container logs

The following sections tell you how to detect and solve a database index corruption issue reported in Metadata Store App Container logs.

Symptom

The Metadata Store cannot reconcile because the Metadata Store pod reports a potential database index corruption issue.

```
kubect1 logs metadata-store-app-pod_name -n metadata-store
```

Output

```
{
  "level": "error",
  "ts": "2023-08-15T16:38:31.528115988Z",
  "logger": "MetadataStore",
  "msg": "unable to check index corruption since user is not a superuser to perform `CREATE EXTENSION amcheck`. Please create this extension and check for index corruption using following sql command `SELECT bt_index_check(oid) FROM pg_class WHERE relname in (SELECT indexrelid::regclass::text FROM (SELECT indexrelid, indrelid, indcollation[i] coll FROM pg_index, generate_subscripts(indcollation, 1) g(i)) s JOIN pg_collation c ON coll=c.oid WHERE collprovider IN ('d', 'c') AND collname NOT IN ('C', 'POSIX'))`;\"",
  "hostname": "metadata-store-app-77c9fb59c8-qplxt"
}
{
  "level": "error",
  "ts": "2023-08-15T16:38:31.528139637Z",
  "logger": "MetadataStore",
  "msg": "Found corrupted database indexes but unable to fix them",
  "hostname": "metadata-store-app-77c9fb59c8-qplxt",
  "error": "unable to check index corruption since user is not a superuser to perform `CREATE EXTENSION amcheck`. Please create this extension and check for index corruption using following sql command `SELECT bt_index_check(oid) FROM pg_class WHERE relname in (SELECT indexrelid::regclass::text FROM (SELECT indexrelid, indrelid, indcollation[i] coll FROM pg_index, generate_subscripts(indcollation, 1) g(i)) s JOIN pg_collation c ON coll=c.oid WHERE collprovider IN ('d', 'c') AND collname NOT IN ('C', 'POSIX'))`;\""
}
```

Solutions

You can solve this issue by upgrading Tanzu Application Platform with updated schema values to connect to the PostgreSQL database directly and then fix the index manually.

The rest of this topic describes alternative solutions:

- Edit the `auto_correct_db_indexes` property to be `true` in `tap-values.yaml`

- Connect to the Metadata Store database with the account that the Metadata Store API uses
- Connect to the Metadata Store database with a superuser account and manually fix the index

Edit the `auto_correct_db_indexes` property to be `true` in `tap-values.yaml`

To edit the `auto_correct_db_indexes` property:

1. Change the property `auto_correct_db_indexes` value to `true` in `tap-values.yaml`.
2. Update Tanzu Application Platform by running:

```
tanzu package installed update tap -p tap.tanzu.vmware.com -v {{ vars.tap_version }} \
--values-file tap-values.yaml -n tap-install
```

3. Examine the Metadata Store API logs and verify that there are no errors.

Connect to the Metadata Store database with the account that the Metadata Store API uses

To connect to the Metadata Store database with the same account that the Metadata Store API uses:

1. [Connect to the PostgreSQL database.](#)
2. Run this SQL to re-index individual tables:

```
REINDEX TABLE "artifact_groups";
REINDEX TABLE "artifact_group_images";
REINDEX TABLE "images";
REINDEX TABLE "sources";
REINDEX TABLE "source_images";
REINDEX TABLE "packages";
REINDEX TABLE "image_packages";
REINDEX TABLE "vulnerabilities";
REINDEX TABLE "package_vulnerabilities";
REINDEX TABLE "source_packages";
REINDEX TABLE "artifact_group_sources";
REINDEX TABLE "method_types";
REINDEX TABLE "ratings";
REINDEX TABLE "package_managers";
REINDEX TABLE "artifact_group_labels";
REINDEX TABLE "analysis_instances";
REINDEX TABLE "vulnerability_analyses";
REINDEX TABLE "reports";
REINDEX TABLE "report_ratings";
REINDEX TABLE "report_packages_vulnerabilities";
REINDEX TABLE "index_migration_statuses";
```

3. Run the following SQL:

```
INSERT INTO index_migration_statuses (created_at, updated_at, "version", status) VALUES(now(), \
now(), version(), true)
```

4. Examine the Metadata Store API logs and verify that there are no errors.

Connect to the Metadata Store database with a superuser account and manually fix the index

To connect to the Metadata Store database with a superuser account and manually fix the index:

1. [Connect to the PostgreSQL database.](#)
2. Install the extension on your PostgreSQL database.

```
CREATE EXTENSION amcheck
```

3. Run the following SQL:

```
SELECT indexrelid::regclass::text FROM (SELECT indexrelid, indrelid, indcollati
on[i] coll \
FROM pg_index, generate_subscripts(indcollation, 1) g(i)) s JOIN pg_collation c
ON coll=c.oid
WHERE collprovider IN ('d', 'c') AND collname NOT IN ('C', 'POSIX');
```

4. Run the following SQL when you see an error:

```
SELECT indexrelid::regclass::text FROM (SELECT indexrelid, indrelid, indcollati
on[i] coll \
FROM pg_index, generate_subscripts(indcollation, 1) g(i)) s JOIN pg_collation c
ON coll=c.oid
WHERE collprovider IN ('d', 'c') AND collname NOT IN ('C', 'POSIX');
```

5. Run the following SQL if the previous step caused an error:

```
REINDEX database "metadata-store"
```

6. Run the following SQL:

```
INSERT INTO index_migration_statuses (created_at, updated_at, "version", statu
s) VALUES(now(), \
now(), version(), true)
```

7. Examine the Metadata Store API logs and verify that there are no errors.

Overview of Tanzu Application Platform Telemetry

Tanzu Application Platform Telemetry (commonly known as TAP Telemetry) is a set of objects that collect data about the usage of Tanzu Application Platform (commonly known as TAP) and send it back to VMware for product improvements.

A benefit of remaining enrolled in telemetry and identifying your company during Tanzu Application Platform installation is that VMware can provide your organization with usage reports about Tanzu Application Platform.

For more information about enrolling in telemetry reports, see [Tanzu Application Platform usage reports](#).

For more information about how to install the telemetry component, see [Install Tanzu Application Platform Telemetry](#).

Tanzu Application Platform usage reports

VMware offers the option to enroll in a usage reporting program that offers a summary of usage of your Tanzu Application Platform. These reports provide an overview of various deployments of Tanzu Application Platform and their utilization. They encompass details such as the quantity of workloads and supply chains, and their health status. Additionally, the reports include information about the virtual CPU (vCPU) usage for each Tanzu Application Platform deployment. You can enroll in the program by providing the Entitlement Account Number (EAN). An EAN is a unique ID

assigned to all VMware customers. VMware uses EAN to identify data about Tanzu Application Platform.

After locating the EAN, pass the number under the telemetry header in the `tap-values.yaml` file as a value for the `customer_entitlement_account_number` key.

```
tap_telemetry:  
  customer_entitlement_account_number: "CUSTOMER-ENTITLEMENT-ACCOUNT-NUMBER"
```

You must repeat the process for each Tanzu Application Platform Cluster included in the telemetry report. For more information, see [Full profile](#).

After enrollment, alert your VMware account team that you have configured the EAN field and want telemetry reports. This allows VMware to identify who the newly added EAN belongs to.

 **Note**

Usage report is only supported for non-airgapped deployments of Tanzu Application Platform and the Cluster must participate in Tanzu Application Platform telemetry. You are enrolled in telemetry by default. You can opt out of telemetry collection by following the instructions in [Opt out of telemetry collection](#).

The following screenshots show the sample telemetry reports.

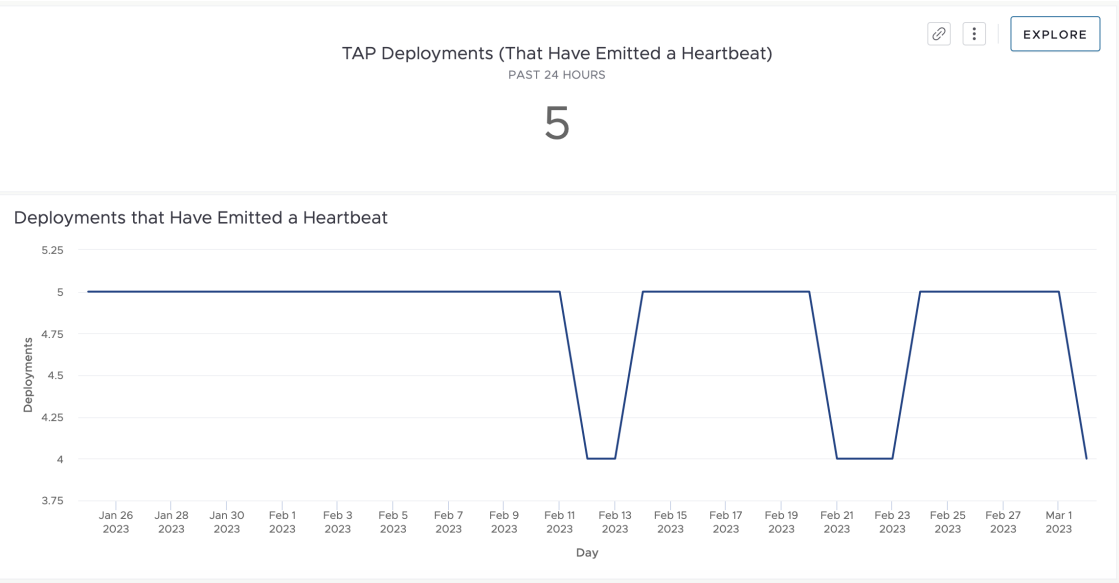

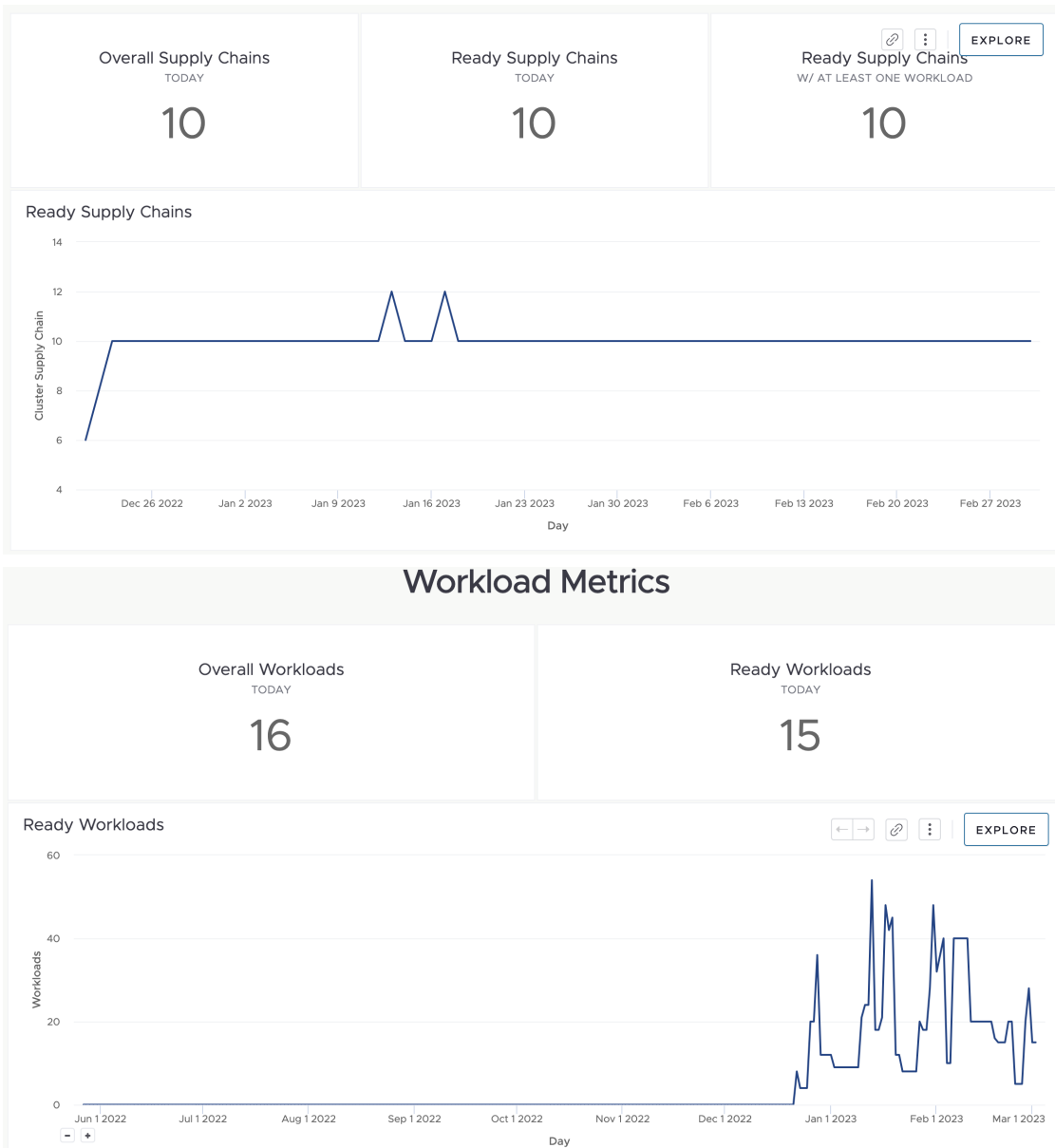

Overview of Tanzu Application Platform Telemetry

Tanzu Application Platform Telemetry (commonly known as TAP Telemetry) is a set of objects that collect data about the usage of Tanzu Application Platform (commonly known as TAP) and send it back to VMware for product improvements.

A benefit of remaining enrolled in telemetry and identifying your company during Tanzu Application Platform installation is that VMware can provide your organization with usage reports about Tanzu Application Platform.

For more information about enrolling in telemetry reports, see [Tanzu Application Platform usage reports](#).

For more information about how to install the telemetry component, see [Install Tanzu Application Platform Telemetry](#).

Tanzu Application Platform usage reports

VMware offers the option to enroll in a usage reporting program that offers a summary of usage of your Tanzu Application Platform. These reports provide an overview of various deployments of

Tanzu Application Platform and their utilization. They encompass details such as the quantity of workloads and supply chains, and their health status. Additionally, the reports include information about the virtual CPU (vCPU) usage for each Tanzu Application Platform deployment. You can enroll in the program by providing the Entitlement Account Number (EAN). An EAN is a unique ID assigned to all VMware customers. VMware uses EAN to identify data about Tanzu Application Platform.

After locating the EAN, pass the number under the telemetry header in the `tap-values.yaml` file as a value for the `customer_entitlement_account_number` key.

```
tap_telemetry:  
  customer_entitlement_account_number: "CUSTOMER-ENTITLEMENT-ACCOUNT-NUMBER"
```

You must repeat the process for each Tanzu Application Platform Cluster included in the telemetry report. For more information, see [Full profile](#).

After enrollment, alert your VMware account team that you have configured the EAN field and want telemetry reports. This allows VMware to identify who the newly added EAN belongs to.



Note

Usage report is only supported for non-airgapped deployments of Tanzu Application Platform and the Cluster must participate in Tanzu Application Platform telemetry. You are enrolled in telemetry by default. You can opt out of telemetry collection by following the instructions in [Opt out of telemetry collection](#).

The following screenshots show the sample telemetry reports.

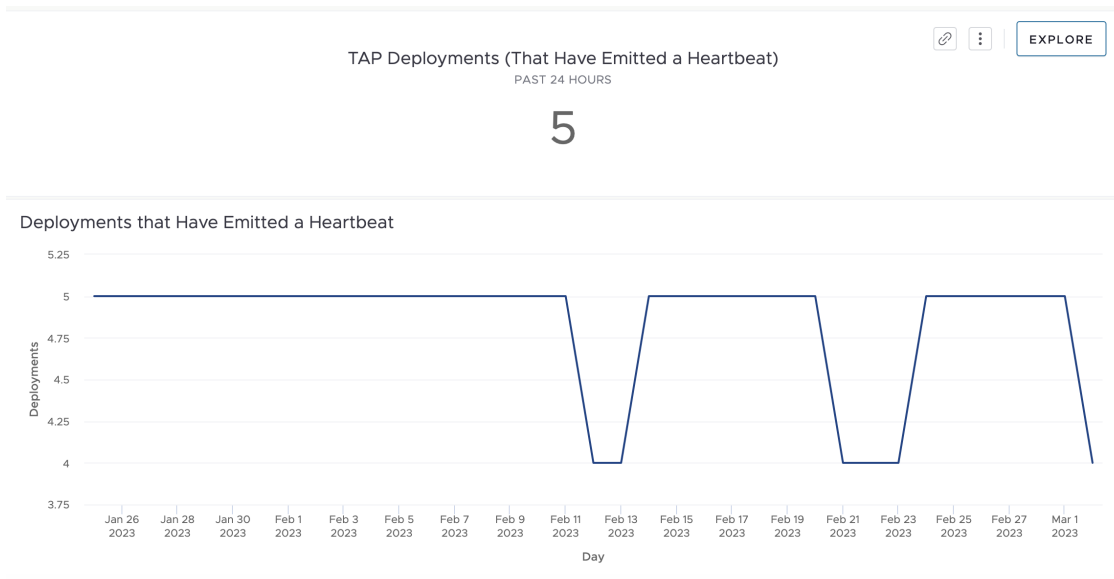

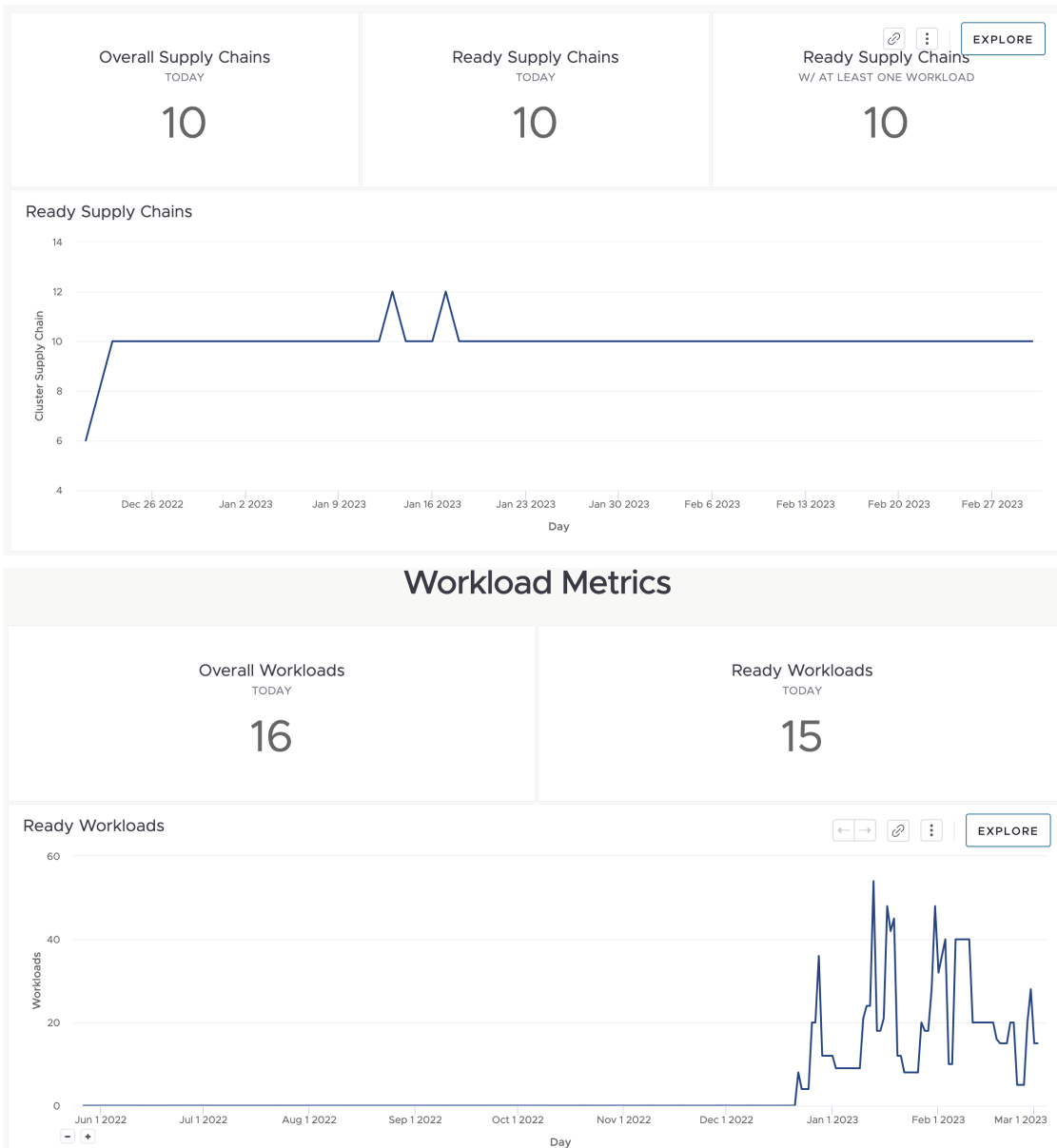

Install Tanzu Application Platform Telemetry

This topic tells you how to install Tanzu Application Platform Telemetry from the Tanzu Application Platform (commonly known as TAP) package repository.



Note

Follow the steps in this topic if you do not want to use a profile to install Telemetry. For more information about profiles, see [Components and installation profiles](#).

Prerequisites

Before installing Tap Telemetry:

- Complete all prerequisites to install Tanzu Application Platform. For more information, see [Prerequisites](#).

- Install cert-manager on the cluster. For more information, see the [cert-manager documentation](#).
- See [Deployment Details and Configuration](#) to review what resources will be deployed.

Install

To install Tanzu Application Platform Telemetry:

1. List version information for the package by running:

```
tanzu package available list tap-telemetry.tanzu.vmware.com --namespace tap-ins
tall
```

For example:

```
$ tanzu package available list tap-telemetry.tanzu.vmware.com --namespace tap-i
ninstall
- Retrieving package versions for tap-telemetry.tanzu.vmware.com...
NAME                                VERSION    RELEASED-AT
tap-telemetry.tanzu.vmware.com      0.3.1
```

2. (Optional) List all the available deployment configuration options:

```
tanzu package available get tap-telemetry.tanzu.vmware.com/VERSION --values-sch
ema -n tap-install
```

Where `VERSION` is the your package version number. For example, `0.3.1`.

For example:

```
$ tanzu package available get tap-telemetry.tanzu.vmware.com/0.3.1 --values-sch
ema -n tap-install
| Retrieving package details for tap-telemetry.tanzu.vmware.com/0.3.1...
KEY                                DEFAULT  TYPE      DESCRIPTION
kubernetes_distribution             string   Kubernetes platform flavo
r where the tap-telemetry is being installed on. Accepted values are ['', 'open
shift']
customer_entitlement_account_number string   Account number used to di
stinguish data by customer.
installed_for_vmware_internal_use  string   Indication of if the depl
oyment is for vmware internal user. Accepted values are ['true', 'false']
```

3. (Optional) Modify the deployment configurations by creating a configuration YAML with the desired custom configuration values. For example, if you want to provide your Customer Entitlement Number, create a `tap-telemetry-values.yaml` and configure the `customer_entitlement_account_number` property:

```
---
customer_entitlement_account_number: "12345"
```

See [Deployment details and configuration](#) for more information about the configuration options.

4. Install the package by running:

```
tanzu package install tap-telmetry \
  --package tap-telemetry.tanzu.vmware.com \
  --version VERSION \
  --namespace tap-install \
  --values-file tap-telemetry-values.yaml
```

Where:

- `--values-file` is an optional flag. Only use it to customize the deployment configuration.
- `VERSION` is the package version number. For example, `0.3.1`.

For example:

```
$ tanzu package install tap-telemetry \
  --package tap-telemetry.tanzu.vmware.com \
  --version 0.3.1 \
  --namespace tap-install \
  --values-file tap-telemetry-values.yaml

Installing package 'tap-telemetry.tanzu.vmware.com'
Getting package metadata for 'tap-telemetry.tanzu.vmware.com'
Creating service account 'tap-telemetry-tap-install-sa'
Creating cluster admin role 'tap-telemetry-tap-install-cluster-role'
Creating cluster role binding 'tap-telemetry-tap-install-cluster-rolebinding'
Creating secret 'tap-telemetry-tap-install-values'
Creating package resource
Waiting for 'PackageInstall' reconciliation for 'tap-telemetry'
'PackageInstall' resource install status: Reconciling
'PackageInstall' resource install status: ReconcileSucceeded
'PackageInstall' resource successfully reconciled

Added installed package 'tap-telemetry'
```

Deployment details and configurations of Tanzu Application Platform Telemetry

Use this topic to learn the deployment details and configurations of your Tanzu Application Platform Telemetry (commonly known as TAP Telemetry).

What is deployed

The installation creates the following in your Kubernetes cluster:

- A deployment.
- A pod.
- A namespace `tap-telemetry`.
- A service account with read-write privileges named `informer`, and a corresponding secret for the service account. This secret is bound to a ClusterRole named `tap-telemetry-admin`.
- A Role `tap-telemetry-informer` to retrieve the deployment ID, which is sent as sender ID in heartbeat metrics.
- A RoleBinding `tap-telemetry-informer-admin` that binds the `informer` service account to the `tap-telemetry-informer` role.
- A ClusterRole `tap-telemetry-admin` that has access to each Tanzu Application Platform component to gather information from.
- A ClusterRoleBinding `tap-telemetry-informer-admin` that binds the `informer` service account to the `tap-telemetry-informer` cluster role.

Deployment configuration

`customer_entitlement_account_number` is the unique identifier to differentiate between the data from your cluster and the data from other clusters. You can configure this property in your `tap-telemetry-values.yaml`:

```
customer_entitlement_account_number: "12345"
```

It creates a config map named `vmware-telemetry-identifiers` in the `vmware-system-telemetry` namespace, which is used internally to log your information.

Repeat these steps for the Build, Run, and View Cluster. For more information, see [Install multicluster Tanzu Application Platform profiles](#).

Overview of Tanzu Build Service

This topic provides you with an overview of VMware Tanzu Build Service in Tanzu Application Platform (commonly known as TAP).

Overview

Tanzu Build Service automates container creation, management, and governance at enterprise scale. Tanzu Build Service uses the open-source [Cloud Native Buildpacks](#) project to turn application source code into container images. It executes reproducible builds aligned with modern container standards and keeps images up to date.

Use the Tanzu Build Service CLI plug-in to view all the Tanzu Build Service resources on any Kubernetes cluster that has Tanzu Application Platform or Tanzu Build Service installed. For information about how to install the Tanzu CLI and plug-ins, see [Install Tanzu CLI](#) and [Overview of Tanzu CLI](#).

For more information about Tanzu Build Service, see the [Tanzu Build Service documentation](#). For more information about Tanzu Buildpacks and their configuration, see the [Tanzu Buildpack documentation](#).

Tanzu Application Platform v1.6 includes Tanzu Build Service v1.11.

Overview of Tanzu Build Service

This topic provides you with an overview of VMware Tanzu Build Service in Tanzu Application Platform (commonly known as TAP).

Overview

Tanzu Build Service automates container creation, management, and governance at enterprise scale. Tanzu Build Service uses the open-source [Cloud Native Buildpacks](#) project to turn application source code into container images. It executes reproducible builds aligned with modern container standards and keeps images up to date.

Use the Tanzu Build Service CLI plug-in to view all the Tanzu Build Service resources on any Kubernetes cluster that has Tanzu Application Platform or Tanzu Build Service installed. For information about how to install the Tanzu CLI and plug-ins, see [Install Tanzu CLI](#) and [Overview of Tanzu CLI](#).

For more information about Tanzu Build Service, see the [Tanzu Build Service documentation](#). For more information about Tanzu Buildpacks and their configuration, see the [Tanzu Buildpack documentation](#).

Tanzu Application Platform v1.6 includes Tanzu Build Service v1.11.

Install Tanzu Build Service

This topic describes how to install Tanzu Build Service from the Tanzu Application Platform (commonly known as TAP) package repository by using the Tanzu CLI.

Before you begin

Use this topic if you do not want to use a Tanzu Application Platform profile that includes Tanzu Build Service. The Full, Iterate, and Build profiles include Tanzu Build Service. For more information about profiles, see [Components and installation profiles](#).

The following procedure might not include some configurations required for your environment. For advanced information about installing Tanzu Build Service, see the [Tanzu Build Service documentation](#).

Prerequisites

Before installing Tanzu Build Service:

- Complete all prerequisites to install Tanzu Application Platform. For more information, see [Prerequisites](#).
- You must have access to a Docker registry that Tanzu Build Service can use to create builder images. Approximately 10 GB of registry space is required when using the `full` dependencies.
- Your Docker registry must be accessible with user name and password credentials.

Deprecated Features

- **The Cloud Native Buildpack Bill of Materials (CNB BOM) format:** This legacy format is deprecated, and is now deactivated by default in Tanzu Application Platform.

You can still manually activate the format, using `include_legacy_bom=true` in your values file. The feature will be removed in Tanzu Application Platform v1.8.

Install the Tanzu Build Service package

To install Tanzu Build Service by using the Tanzu CLI:

1. Get the latest version of the Tanzu Build Service package by running:

```
tanzu package available list buildservice.tanzu.vmware.com --namespace tap-inst
all
```

2. Gather the values schema by running:

```
tanzu package available get buildservice.tanzu.vmware.com/VERSION --values-sche
ma --namespace tap-install
```

Where `VERSION` is the version of the Tanzu Build Service package you retrieved earlier in this procedure.

3. Create the secret for the `kp-default-repository` credentials using the `tanzu cli`:

```
tanzu secret registry add kp-default-repository-creds \
--server "${REGISTRY-HOSTNAME}" \
--username "${REGISTRY-USERNAME}" \
```

```
--password "${REGISTRY-PASSWORD}" \
--namespace tap-install
```

Where: - `REGISTRY-HOST` is the host name for the registry that contains your `kp_default_repository`. For example: - Harbor has the form `server: "my-harbor.io"`. - Docker Hub has the form `server: "index.docker.io"`. - Google Cloud Registry has the form `server: "gcr.io"`. - `REGISTRY-USERNAME` and `REGISTRY-PASSWORD` are the user name and password for the user that can write to the repository used in the following step. For Google Cloud Registry, use `_json_key` as the user name and the contents of the service account JSON file for the password.

4. Create a `tbs-values.yaml` file using the following template. If `shared.image_registry.project_path` and `shared.image_registry.secret` are configured in the `tap-values.yaml` file, Tanzu Build Service inherits all three values in that section. This can be disabled by setting any of the following three values.

```
---
kp_default_repository: "REPO-NAME"
kp_default_repository_secret:
  name: kp-default-repository-creds
  namespace: tap-install
```

Where: - `REPO-NAME` is a writable repository in your registry. Tanzu Build Service dependencies are written to this location. Examples: - Harbor has the form `"my-harbor.io/my-project/build-service"`. - Docker Hub has the form `"my-dockerhub-user/build-service"` or `"index.docker.io/my-user/build-service"`. - Google Cloud Registry has the form `"gcr.io/my-project/build-service"`.

5. If you are running on OpenShift, add `kubernetes_distribution: openshift` to your `tbs-values.yaml` file.
6. (Optional) Under the `ca_cert_data` key in the `tbs-values.yaml` file, provide a PEM-encoded CA certificate for Tanzu Build Service. This certificate is used for accessing the container image registry and is also provided to the build process.



Note

If `shared.ca_cert_data` is configured in the `tap-values.yaml` file, Tanzu Build Service inherits that value.

Configuring `ca_cert_data` key in the `tbs-values.yaml` file adds the CA certificates at build time. To add CA certificates to the built image, see [Configure custom CA certificates for a single workload using service bindings](#).

For example:

```
---
kp_default_repository: "REPO-NAME"
kp_default_repository_secret:
  name: kp-default-repository-creds
  namespace: tap-install
ca_cert_data: |
  -----BEGIN CERTIFICATE-----
  ...
  -----END CERTIFICATE-----
```

- (Optional) Tanzu Build Service is bootstrapped with the `lite` set of dependencies. To configure `full` dependencies, add the key-value pair `exclude_dependencies: true` to your `tbs-values.yaml` file. This is to exclude the default `lite` dependencies from the installation. For example:

```
---
kp_default_repository: "REPO-NAME"
kp_default_repository_secret:
  name: kp-default-repository-creds
  namespace: tap-install
exclude_dependencies: true
```

For more information about the differences between `full` and `lite` dependencies, see [About lite and full dependencies](#).

- Install the Tanzu Build Service package by running:

```
tanzu package install tbs \
  --package buildservice.tanzu.vmware.com \
  --version VERSION \
  --namespace tap-install \
  --values-file tbs-values.yaml
```

Where `VERSION` is the version of the Tanzu Build Service package you retrieved earlier.

For example:

```
$ tanzu package install tbs \
  --package buildservice.tanzu.vmware.com \
  --version 1.11.16 \
  --namespace tap-install \
  --vaules-file tbs-values.yaml

| Installing package 'buildservice.tanzu.vmware.com'
| Getting namespace 'tap-install'
| Getting package metadata for 'buildservice.tanzu.vmware.com'
| Creating service account 'tbs-tap-install-sa'
| Creating cluster admin role 'tbs-tap-install-cluster-role'
| Creating cluster role binding 'tbs-tap-install-cluster-rolebinding'
| Creating secret 'tbs-tap-install-values'
- Creating package resource
- Package install status: Reconciling

Added installed package 'tbs' in namespace 'tap-install'
```

- (Optional) Verify the cluster builders that the Tanzu Build Service installation created by running:

```
tanzu package installed get tbs -n tap-install
```

- If you configured `full` dependencies in your `tbs-values.yaml` file, install the `full` dependencies by following the procedure in [Install full dependencies](#).

Use AWS IAM authentication for registry credentials

Tanzu Build Service supports using AWS IAM roles to authenticate with Amazon Elastic Container Registry (ECR) on Amazon Elastic Kubernetes Service (EKS) clusters.

To use AWS IAM authentication:

- Configure an AWS IAM role that has read and write access to the repository in the container image registry used when installing Tanzu Application Platform.

- Use the following alternative configuration for `tbs-values.yaml`:



Note

if you are installing Tanzu Build Service as part of a Tanzu Application Platform profile, you configure this in your `tap-values.yaml` file under the `buildservice` section.

```
---
kp_default_repository: "REPO-NAME"
kp_default_repository_aws_iam_role_arn: "IAM-ROLE-ARN"
```

Where:

- `REPO-NAME` is a writable repository in your registry. Tanzu Build Service dependencies are written to this location.
 - `IAM-ROLE-ARN` is the AWS IAM role Amazon Resource Name (ARN) for the role configured earlier in this procedure. For example, `arn:aws:iam::xyz:role/my-install-role`.
- The developer namespace requires configuration for Tanzu Application Platform to use AWS IAM authentication for ECR. Configure an AWS IAM role that has read and write access to the registry for storing workload images.
 - Using the supply chain service account, add an annotation including the role ARN configured earlier by running:

```
kubectl annotate serviceaccount -n DEVELOPER-NAMESPACE SERVICE-ACCOUNT-NAME \
eks.amazonaws.com/role-arn=IAM-ROLE-ARN
```

Where:

- `DEVELOPER-NAMESPACE` is the namespace where workloads are created.
 - `SERVICE-ACCOUNT-NAME` is the supply chain service account. This is `default` if unset.
 - `IAM-ROLE-ARN` is the AWS IAM role ARN for the role configured earlier. For example, `arn:aws:iam::xyz:role/my-developer-role`.
- Apply this configuration by continuing the steps in [Install the Tanzu Build Service package](#).

Install full dependencies

If you configured `full` dependencies in your `tbs-values.yaml` file, you must install the `full` dependencies package.

For a more information about `lite` and `full` dependencies, see [About lite and full dependencies](#).

To install `full` Tanzu Build Service dependencies:

- If you have not done so already, add the key-value pair `exclude_dependencies: true` to your `tbs-values.yaml` file. For example:



Note

if you are installing Tanzu Build Service as part of a Tanzu Application Platform profile, you configure this in your `tap-values.yaml` file under the `buildservice` section.

```

---
kp_default_repository: "REPO-NAME"
kp_default_repository_secret:
  name: kp-default-repository-creds
  namespace: tap-install
exclude_dependencies: true

```

- If you have not updated your package install after adding the `exclude_dependencies: true` to your values file, you must perform the update by running:

```

tanzu package installed update APP-NAME --namespace tap-install --values-file
PATH-TO-UPDATED-VALUES

```

- Get the latest version of the Tanzu Application Platform package by running:

```

tanzu package available list tap.tanzu.vmware.com --namespace tap-install

```

- Relocate the Tanzu Build Service `full` dependencies package repository by running:

```

imgpkg copy -b tanzu.packages.broadcom.com/tanzu-application-platform/full-deps
-package-repo:VERSION \
--to-repo INSTALL-REGISTRY-HOSTNAME/TARGET-REPOSITORY/tbs-full-deps

```

Where:

- `VERSION` is the version of the Tanzu Build Service package you retrieved earlier in this procedure.
- `INSTALL-REGISTRY-HOSTNAME` is your container image registry.
- `TARGET-REPOSITORY` is your target repository.

- Add the Tanzu Build Service `full` dependencies package repository by running:

```

tanzu package repository add tbs-full-deps-repository \
--url INSTALL-REGISTRY-HOSTNAME/TARGET-REPOSITORY/full-deps:VERSION \
--namespace tap-install

```

Where:

- `VERSION` is the version of the Tanzu Build Service package you retrieved earlier.
- `INSTALL-REGISTRY-HOSTNAME` is your container image registry.
- `TARGET-REPOSITORY` is your target repository.

- Install the `full` dependencies package by running:

```

tanzu package install full-tbs-deps \
--package full-deps.buildservice.tanzu.vmware.com \
--version "> 0.0.0" \
--namespace tap-install \
--values-file VALUES-FILE

```

Where `VALUES-FILE` is the path to your Tanzu Build Service or Tanzu Application Platform values YAML file.

Install Tanzu Build Service on an air-gapped environment

This topic tells you how to install Tanzu Build Service on a Kubernetes cluster and registry that are air-gapped from external traffic.

Before you begin

Use this topic if you do not want to use a Tanzu Application Platform profile that includes Tanzu Build Service.

The Full, Iterate, and Build profiles include Tanzu Build Service. For more information about profiles, see [Components and installation profiles](#).

Prerequisites

Before installing Tanzu Build Service:

- Complete all prerequisites to install Tanzu Application Platform. For more information, see [Prerequisites](#).
- You must have access to a Docker registry that Tanzu Build Service can use to create builder images. Approximately 10 GB of registry space is required when using the `full` dependencies.
- Your Docker registry must be accessible with user name and password credentials.

Deprecated Features

- **The Cloud Native Buildpack Bill of Materials (CNB BOM) format:** This legacy format is deprecated and is now deactivated by default in Tanzu Application Platform.

You can still manually activate the format using `include_legacy_bom=true` in your values file. The feature will be removed in Tanzu Application Platform v1.8.

Install the Tanzu Build Service package

These steps assume that you have installed the Tanzu Application Platform packages in your air-gapped environment.

To install the Tanzu Build Service package on an air-gapped environment:

1. Get the latest version of the Tanzu Build Service package by running:

```
tanzu package available list buildservice.tanzu.vmware.com --namespace tap-inst
all
```

2. Gather the values schema by running:

```
tanzu package available get buildservice.tanzu.vmware.com/VERSION --values-sche
ma --namespace tap-install
```

Where `VERSION` is the version of the Tanzu Build Service package you retrieved in the previous step.

3. Create a `tbs-values.yaml` file. The required fields for an air-gapped installation are as follows:

```
---
kp_default_repository: REPO-NAME
kp_default_repository_secret:
  name: "SECRET_NAME"
  namespace: "SECRET_NAMESPACE"
ca_cert_data: CA-CERT-CONTENTS
exclude_dependencies: true
```

Where:

- `REPO-NAME` is the fully qualified path to a writeable repository in your internal registry. Tanzu Build Service dependencies are written to this location. For example:
 - For Harbor: `harbor.io/my-project/build-service`
 - For Artifactory: `artifactory.com/my-project/build-service`
- `SECRET_NAME` is the name of the secret containing credentials that can write to `REPO-NAME`.
- `SECRET_NAMESPACE` is the namespace of the secret containing credentials that can write to `REPO-NAME`.
- `CA-CERT-CONTENTS` are the contents of the PEM-encoded CA certificate for the internal registry.

4. Install the package by running:

```
tanzu package install tbs \
  --package buildservice.tanzu.vmware.com \
  --version VERSION \
  --namespace tap-install \
  --values-file tbs-values.yaml
```

Where `VERSION` is the version of the Tanzu Build Service package you retrieved earlier.

For example:

```
$ tanzu package install tbs \
  --package buildservice.tanzu.vmware.com \
  --version 1.11.16 \
  --namespace tap-install \
  --values-file tbs-values.yaml

| Installing package 'buildservice.tanzu.vmware.com'
| Getting namespace 'tap-install'
| Getting package metadata for 'buildservice.tanzu.vmware.com'
| Creating service account 'tbs-tap-install-sa'
| Creating cluster admin role 'tbs-tap-install-cluster-role'
| Creating cluster role binding 'tbs-tap-install-cluster-rolebinding'
| Creating secret 'tbs-tap-install-values'
- Creating package resource
- Package install status: Reconciling
Added installed package 'tbs' in namespace 'tap-install'
```

Install the Tanzu Build Service dependencies

By default, Tanzu Build Service is installed with `lite` dependencies.

When installing Tanzu Build Service on an air-gapped environment, the `lite` dependencies cannot be used as they require Internet access. You must install the `full` dependencies.

To install `full` dependencies:

1. Relocate the Tanzu Build Service `full` dependencies package repository by running:

```
imgpkg copy -b tanzu.packages.broadcom.com/tanzu-application-platform/full-deps
--package-repo:VERSION \
  --to-tar=full-deps-package-repo.tar
# move full-deps-package-repo.tar to environment with registry access
imgpkg copy --tar full-deps-package-repo.tar \
  --to-repo=INSTALL-REGISTRY-HOSTNAME/TARGET-REPOSITORY/full-deps-package-repo
```

Where:

- `VERSION` is the version of the TAP package you retrieved earlier.
- `INSTALL-REGISTRY-HOSTNAME` is your container registry.
- `TARGET-REPOSITORY` is your target repository.

2. Add the Tanzu Build Service `full` dependencies package repository by running:

```
tanzu package repository add full-deps-package-repo \
  --url INSTALL-REGISTRY-HOSTNAME/TARGET-REPOSITORY/full-deps-package-repo:VERS
ION \
  --namespace tap-install
```

Where:

- `INSTALL-REGISTRY-HOSTNAME` is your container registry.
- `TARGET-REPOSITORY` is your target repository.
- `VERSION` is the version of the TAP package you retrieved earlier.

3. Install the `full` dependencies package by running:

```
tanzu package install full-deps -p full-deps.buildservice.tanzu.vmware.com -v
"> 0.0.0" -n tap-install --values-file PATH-TO-TAP-VALUES-FILE
```

Configure Tanzu Build Service properties on a workload

This topic tells you how to configure your workload with Tanzu Build Service properties.

Overview

Tanzu Build Service builds registry images from source code for Tanzu Application Platform. You can configure these build configurations by using a workload.

Tanzu Build Service is only applicable to the build process. Configurations, such as environment variables and service bindings, might require a different process for runtime.

Configure build-time service bindings

You can configure build-time service bindings for Tanzu Build Service.

Tanzu Build Service supports using the Service Binding Specification for Kubernetes for application builds. For more information, see the [service binding specification for Kubernetes](#) in GitHub.

Service binding configuration is specific to the buildpack that is used to build the app. For more information about configuring buildpack service bindings for the buildpack you are using, see the [VMware Tanzu Buildpacks documentation](#).

To configure a service binding for a Tanzu Application Platform workload, follow these steps:

1. Create a YAML file named `service-binding-secret.yaml` for a secret as follows:

```
apiVersion: v1
kind: Secret
metadata:
  name: settings-xml
  namespace: DEVELOPER-NAMESPACE
type: service.binding/maven
stringData:
  type: maven
```

```
provider: sample
settings.xml: |
MY-SETTINGS
```

Where: - `DEVELOPER-NAMESPACE` is the namespace where workloads are created. - `MY-SETTINGS` is the contents of your service bindings file.

2. Apply the YAML file by running:

```
kubectl apply -f service-binding-secret.yaml
```

3. Create the workload with `buildServiceBindings` configured by running:

```
tanzu apps workload create WORKLOAD-NAME \
  --param-yaml buildServiceBindings='[{"name": "settings-xml", "kind": "Secret"}]' \
  ...
```

Where `WORKLOAD-NAME` is the name of the workload you want to configure.

Configure environment variables

If you have build-time environment variable dependencies, you can set environment variables that are available at build-time.

You can also configure buildpacks with environment variables. Buildpack configuration depends on the specific buildpack being used. For more information about configuring environment variables for the buildpack you are using, see the [VMware Tanzu Buildpacks documentation](#).

For example:

```
tanzu apps workload create WORKLOAD-NAME \
  --build-env "ENV_NAME=ENV_VALUE" \
  --build-env "BP_MAVEN_BUILD_ARGUMENTS=-Dmaven.test.skip=true"
```

Where `WORKLOAD-NAME` is the name of the workload you want to configure.

Configure the service account

Using the Tanzu CLI, you can configure the service account used during builds. This service account is the one configured for the developer namespace. If unset, `default` is used.

To configure the service account used during builds, run:

```
tanzu apps workload create WORKLOAD-NAME \
  --param serviceAccount=SERVICE-ACCOUNT-NAME \
```

Where:

- `WORKLOAD-NAME` is the name of the workload you want to configure.
- `SERVICE-ACCOUNT-NAME` is the name of the service account you want to use during builds.

Configure the cluster builder

To configure the ClusterBuilder used during builds:

1. View the available ClusterBuilds by running:

```
kubectl get clusterbuilder
```

2. Set the ClusterBuilder used during builds by running:

```
tanzu apps workload create WORKLOAD-NAME \
  --param clusterBuilder=CLUSTER-BUILDER-NAME \
```

Where:

- `WORKLOAD-NAME` is the name of the workload you want to configure.
- `CLUSTER-BUILDER-NAME` is the ClusterBuilder you want to use.

Configure the workload container image registry

Using the Tanzu CLI, you can configure the registry where workload images are saved. The service account used for this workload must have read and write access to this registry location.

To configure the registry where workload images are saved, run:

```
tanzu apps workload create WORKLOAD-NAME \
  --param-yaml registry={"server": SERVER-NAME, "repository": REPO-NAME}
```

Where:

- `SERVER-NAME` is the host name of the registry server. Examples:
 - Harbor has the form `"my-harbor.io"`.
 - Docker Hub has the form `"index.docker.io"`.
 - Google Cloud Registry has the form `"gcr.io"`.
- `REPO-NAME` is where workload images are stored in the registry. Images are written to `SERVER-NAME/REPO-NAME/workload-name`. Examples:
 - Harbor has the form `"my-project/supply-chain"`.
 - Docker Hub has the form `"my-dockerhub-user"`.
 - Google Cloud Registry has the form `"my-project/supply-chain"`.

Configure custom CA certificates for a single workload using service bindings

If the language family buildpack you are using includes the Paketo CA certificates buildpack, you can use a service binding to provide custom certificates during the build and run process. For more information about language family buildpacks, see the [Tanzu Buildpacks documentation](#).

To create a service binding to provide custom CA certificates for a workload:

1. Create a YAML file named `service-binding-ca-cert.yaml` for a secret as follows:

```
apiVersion: v1
kind: Secret
metadata:
  name: my-ca-certs
data:
  type: ca-certificates
  provider: sample
  CA-CERT-FILENAME: |
    -----BEGIN CERTIFICATE-----
    ...
    -----END CERTIFICATE-----
```

Where `CA-CERT-FILENAME` is the name of your PEM encoded CA certificate file. For example, `arbitrary-file-name.pem`.

2. Apply the YAML file by running:

```
kubectl apply -f service-binding-ca-cert.yaml
```

3. To build with the custom certificate, create the workload with `--param-yaml buildServiceBindings` flag:

```
tanzu apps workload create WORKLOAD-NAME \
  --param-yaml buildServiceBindings='[{"apiVersion": "v1", "kind": "Secret", "name": "my-ca-certs"}]' \
  ...
```

Where `WORKLOAD-NAME` is the name of the workload you want to create.

4. To deploy with the custom certificate, create the workload with the `--service-ref` flag:

```
tanzu apps workload create WORKLOAD-NAME \
  --service-ref my-ca-certs=v1:Secret:my-ca-certs \
  ...
```

Where `WORKLOAD-NAME` is the name of the workload you want to create.

Using custom CA certificates for all workloads

To provide custom CA certificates to the build process for all workloads, see the optional step to add the `ca_cert_data` key [Install the Tanzu Build Service package](#).

Create a signed container image with Tanzu Build Service

This topic tells you how to create a Tanzu Build Service image resource that builds a container image from source code signed with Cosign.

Prerequisites

Before you can configure Tanzu Build Service to sign your image builds, you must:

- Install Tanzu Build Service. The Full, Iterate, and Build profiles include Tanzu Build Service by default. If you have not installed Tanzu Application Platform with one of these profiles, see [Installing Tanzu Build Service](#).
- Install Cosign. For instructions, see the [Cosign documentation](#).
- Have a [Builder](#) or [ClusterBuilder](#) resource configured.
- Have an [image](#) resource configured.
- Review the [kpack tutorial](#). This topic builds upon the steps in this tutorial.

Configure Tanzu Build Service to sign your image builds

To configure Tanzu Build Service to sign your image builds:

1. Ensure that you are in a Kubernetes context where you are authenticated and authorized to create and edit secret and service account resources.
2. Generate a Cosign keypair and store it as a Kubernetes secret by running:

```
cosign generate-key-pair k8s://NAMESPACE/COSIGN-KEYPAIR-NAME
```

Where:

- `NAMESPACE` is the namespace to store the Kubernetes secret in.
- `COSIGN-KEYPAIR-NAME` is the name of the Kubernetes secret.

For example:

```
cosign generate-key-pair k8s://default/tutorial-cosign-key-pair
```

3. Enter a password for the private key. Enter any password you want. After the command has completed, you will see the following output:

```
Successfully created secret tutorial-cosign-key-pair in namespace default
Public key written to cosign.pub
```

You will also see a `cosign.pub` file in your current directory. Keep this file as you will need it to verify the signature of the images that are built.

4. If you are using [Docker Hub](#) or a registry that does not support OCI media types, add the annotation `kpack.io/cosign.docker-media-types: "1"` to the Cosign secret as follows:

```
apiVersion: v1
kind: Secret
type: Opaque
metadata:
  name: tutorial-cosign-key-pair
  namespace: default
  annotations:
    kpack.io/cosign.docker-media-types: "1"
data:
  cosign.key: PRIVATE-KEY-DATA
  cosign.password: COSIGN-PASSWORD
  cosign.pub: PUBLIC-KEY-DATA
```

For more information about configuring Cosign key pairs, see the [Tanzu Build Service documentation](#).

5. To enable Cosign signing, create or edit the service account resource that is referenced in the image resource so that it includes the Cosign keypair secret created earlier. The service account is in the same namespace as the image resource and is directly referenced by the image or default if there isn't one.

```
apiVersion: v1
kind: ServiceAccount
metadata:
  name: SERVICE-ACCOUNT-NAME
  namespace: default
secrets:
- name: REGISTRY-CREDENTIALS
- name: COSIGN-KEYPAIR-NAME
imagePullSecrets:
- name: REGISTRY-CREDENTIALS
```

Where:

- `SERVICE-ACCOUNT-NAME` is the name of your service account resource. For example, `tutorial-cosign-service-account`.
- `COSIGN-KEYPAIR-NAME` is the name of the Cosign keypair secret generated earlier. For example, `tutorial-cosign-key-pair`.

- `REGISTRY-CREDENTIALS` is the secret that provides credentials for the container registry where application container images are pushed to.

6. Apply the service account resource to the cluster by running:

```
kubectl apply -f cosign-service-account.yaml
```

7. Create an image resource file named `image-cosign.yaml`. For example:

```
apiVersion: kpack.io/v1alpha2
kind: Image
metadata:
  name: tutorial-cosign-image
  namespace: default
spec:
  tag: IMAGE-REGISTRY
  serviceAccountName: tutorial-cosign-service-account
  builder:
    name: my-builder
    kind: Builder
  source:
    git:
      url: https://github.com/spring-projects/spring-petclinic
      revision: 82cb521d636b282340378d80a6307a08e3d4a4c4
```

Where:

- `IMAGE-REGISTRY` with a writable repository in your registry. The secret referenced in the service account is a secret providing credentials for the registry where application container images are pushed to. For example:
 - Harbor has the form `"my-harbor.io/my-project/my-repo"`
 - Docker Hub has the form `"my-dockerhub-user/my-repo"` or `"index.docker.io/my-user/my-repo"`
 - Google Cloud Registry has the form `"gcr.io/my-project/my-repo"`
8. If you are using Out of the Box Supply Chains, edit the respective `ClusterImageTemplate` to enable signing in your supply chain. For more information, see [Authoring supply chains](#).



Important

VMware discourages referencing the service account using the `service_account` value when installing the Out of the Box Supply Chain. This is because it gives your run cluster access to the private signing key.

9. Apply the image resource to the cluster by running:

```
kubectl apply -f image-cosign.yaml
```

10. After the image resource finishes building, you can get the fully resolved and built OCI image by running:

```
kubectl -n default get image tutorial-cosign-image
```

Example output:

NAME	LATESTIMAGE	READY
tutorial-cosign-image	index.docker.io/your-project/app@sha256:6744b...	True

- Verify image signature by running:

```
cosign verify --insecure-ignore-tlog --key cosign.pub LATEST-IMAGE-WITH-DIGEST
```

Where `LATEST-IMAGE-WITH-DIGEST` is the value of `LATESTIMAGE` you retrieved in the previous step. For example, `index.docker.io/your-project/app@sha256:6744b...`

Expected output:

```
Verification for index.docker.io/your-project/app@sha256:6744b... --
The following checks were performed on each of these signatures:
- The cosign claims were validated
- The signatures were verified against the specified public key
- Any certificates were verified against the Fulcio roots.
```



Note

You must use the `--insecure-ignore-tlog` flag because the supply chain does not write the signature attestation to a transparency log.

- Configure Supply Chain Security Tools for VMware Tanzu - Policy Controller to ensure that only signed images are allowed in your cluster. For more information, see the [Supply Chain Security Tools for VMware Tanzu - Policy Controller](#) documentation.

Tanzu Build Service Dependencies

This topic tells you about Tanzu Build Service dependencies.



Important

Ubuntu Bionic stack is deprecated and will be removed in a future release. VMware recommends that you migrate builds to Jammy stacks. For Tanzu Application Platform v1.5 and later, the default stack for Tanzu Build Service is Jammy.

To build OCI images, Tanzu Build Service has the following dependencies: Cloud Native [Buildpacks](#), [Stacks](#), and [Lifecycles](#).

How dependencies are installed

When Tanzu Application Platform is installed with Tanzu Build Service, it is bootstrapped with a set of dependencies. No extra configuration is required. Each version of Tanzu Application Platform and Tanzu Build Service contains new dependencies.

When Tanzu Application Platform is upgraded, new dependencies are installed which might cause workload images to rebuild. To ensure dependency compatibility, Tanzu Build Service only releases patches for dependencies in patch versions of Tanzu Application Platform. For upgrade instructions, see [Upgrade the full dependencies package](#).

By default, Tanzu Build Service is installed with the `lite` set of dependencies, which have a smaller-footprint and contain a subset of the buildpacks and stacks in the `full` set of dependencies. For a comparison of `lite` and `full` dependencies, see [Dependency comparison](#).

View installed dependencies

To view the set of dependencies installed with Tanzu Build Service, inspect the status of the cluster builders by running:

```
kubectl get clusterbuilder -o yaml
```

Cluster builders contain stack and buildpack metadata.

Bionic and Jammy stacks

Tanzu Application Platform v1.3 and later supports Ubuntu v22.04 (Jammy) based builds and will default to it from Tanzu Application Platform v1.5 and later.

Ubuntu Bionic will stop receiving support in April 2023. VMware recommends that you migrate builds to Jammy.

For more information about support for Jammy stacks, see [About lite and full dependencies](#) later in this topic.



Note

While upgrading apps to a later stack, you might encounter the build platform erroneously reusing the old build cache. If you encounter this issue, delete and recreate the workload in Tanzu Application Platform, or delete and recreate the image in Tanzu Build Service.

About lite and full dependencies

Each version of Tanzu Application Platform is released with two types of Tanzu Build Service dependencies: `lite` and `full`. These dependencies consist of the buildpacks and stacks required for application builds. Each type serves different use cases. Both types are suitable for production workloads.

By default, Tanzu Build Service is installed with `lite` dependencies, which do not contain all buildpacks and stacks. To use all buildpacks and stacks, you must install the `full` dependencies. For instructions about installing `full` dependencies, see [Install full dependencies](#).

For a table comparing the differences between `full` and `lite` dependencies, see [Dependency comparison](#).

Lite dependencies

The `lite` dependencies are the default set installed with Tanzu Build Service.

`lite` dependencies contain a smaller footprint to speed up installation time, but do not support all workload types. For example, `lite` dependencies do not contain the PHP buildpack and cannot be used to build PHP workloads.

Lite dependencies: stacks

The `lite` dependencies contain the following stacks:

- `base-jammy` (Ubuntu Jammy)
- `default` (identical to `base-jammy`)

For more information, see [Stacks](#) in the VMware Tanzu Buildpacks documentation.

Lite dependencies: buildpacks

The `lite` dependencies contain the following buildpacks in Tanzu Application Platform v1.6:

Buildpack	Version	Supported Stacks
Java Buildpack for VMware Tanzu (Lite)	9.0.4	Bionic, Jammy
Java Native Image Buildpack for Tanzu (Lite)	7.0.4	Bionic, Jammy
.NET Core Buildpack for VMware Tanzu (Lite)	2.6.2	Bionic, Jammy
Node.js Buildpack for VMware Tanzu (Lite)	2.2.3	Bionic, Jammy
Python Buildpack for VMware Tanzu (Lite)	2.3.8	Bionic, Jammy
Go Buildpack for VMware Tanzu (Lite)	2.1.4	Bionic, Jammy
Web Servers Buildpack for VMware Tanzu (Lite)	0.13.1	Bionic, Jammy
Ruby Buildpack for VMware Tanzu (Lite)	2.5.2	Bionic, Jammy

And the following components:

Component	Version	Supported Stacks
CNB Lifecycle	0.16.0	Bionic, Jammy
Base Stack of Ubuntu Jammy for VMware Tanzu	0.1.41	Jammy

Full dependencies

The Tanzu Build Service `full` set of dependencies contain more buildpacks and stacks, which allows for more workload types.

The dependencies are pre-packaged, so builds do not have to download them from the Internet. This can speed up build times and allows builds to occur in air-gapped environments. Due to the larger footprint of `full`, installations might take longer.

The `full` dependencies are not installed with Tanzu Build Service by default, you must install them. For instructions for installing `full` dependencies, see [Install Tanzu Build Service with full dependencies](#).

Full dependencies: stacks

The `full` dependencies contain the following stacks, which support different use cases:

- `base-jammy` (Ubuntu Jammy)
- `full-jammy` (Ubuntu Jammy)
- `tiny-jammy` (Ubuntu Jammy)
- `default` (identical to `base-jammy`)

For more information, see [Stacks](#) in the VMware Tanzu Buildpacks documentation.

Full dependencies: buildpacks

The `full` dependencies contain the following buildpacks in Tanzu Application Platform v1.6:

Buildpack	Version	Supported Stacks
Java Buildpack for VMware Tanzu	9.0.4	Bionic, Jammy
Java Native Image Buildpack for Tanzu	7.0.4	Bionic, Jammy
.NET Core Buildpack for VMware Tanzu	2.6.2	Bionic, Jammy

Buildpack	Version	Supported Stacks
Node.js Buildpack for VMware Tanzu	2.2.3	Bionic, Jammy
Python Buildpack for VMware Tanzu	2.3.8	Bionic, Jammy
Ruby Buildpack for VMware Tanzu	2.5.2	Bionic, Jammy
Go Buildpack for VMware Tanzu	2.1.4	Bionic, Jammy
PHP Buildpack for VMware Tanzu	2.3.3	Bionic, Jammy
Web Servers Buildpack for VMware Tanzu	0.13.1	Bionic, Jammy
Procfile Buildpack for VMware Tanzu	5.6.1	Bionic, Jammy

And the following components:

Component	Version	Supported Stacks
CNB Lifecycle	0.16.0	Bionic, Jammy
Tiny Stack of Ubuntu Jammy for VMware Tanzu	0.1.43	Jammy
Base Stack of Ubuntu Jammy for VMware Tanzu	0.1.41	Jammy
Full Stack of Ubuntu Jammy for VMware Tanzu	0.1.70	Jammy

Dependency comparison

The following table compares the contents of the [lite](#) and [full](#) dependencies.

	lite	full
Faster installation time	Yes	No
Dependencies pre-packaged (faster builds)	No	Yes
Supports air-gapped installation	No	Yes
Contains base stack	Yes	Yes
Contains full stack	No	Yes
Contains tiny stack	No	Yes
Contains Jammy stack	Yes	Yes
Supports Java workloads	Yes	Yes
Supports Node.js workloads	Yes	Yes
Supports Go workloads	Yes	Yes
Supports Python workloads	Yes	Yes
Supports Ruby workloads	Yes	Yes
Supports .NET Core workloads	Yes	Yes
Supports PHP workloads	No	Yes
Supports static workloads	Yes	Yes
Supports binary workloads	Yes	Yes
Supports web servers buildpack	Yes	Yes

Update dependencies

New versions of dependencies such as buildpacks, and stacks are available in new versions of Tanzu Application Platform. To update dependencies, VMware recommends that you update to the latest patch version of Tanzu Application Platform.

- If you are using `lite` or `full` dependencies, upgrade to the latest patch version of Tanzu Application Platform to update your dependencies.
- If you are using `full` dependencies, you must complete some extra steps after you upgrade to the latest patch. For more information, see [Upgrading the full dependencies package](#).



Note

When Tanzu Application Platform is upgraded, new dependencies are installed which might cause workload images to rebuild.

Upgrade Buildpacks between Tanzu Application Platform releases

You can update buildpack dependencies outside of upgrading Tanzu Application Platform, but VMware recommends that you upgrade Tanzu Application Platform when possible instead. Each Tanzu Application Platform release version includes a tested set of buildpacks. If you consume a buildpack from the Broadcom Support Portal that is not packaged and tested in a Tanzu Application Platform release, it might introduce errors.

Before you begin: Sign into [VMware Tanzu Network](#) so that the image can be retrieved from the registry.

1. Use the links provided in the [Language Family Buildpacks](#) page in the Tanzu Buildpacks documentation to locate the buildpack image URL on VMware Tanzu Network. Select `tanzu-buildpacks/<LANGUAGE-FAMILY>` for `full` dependencies, or `tanzu-buildpacks/<LANGUAGE-FAMILY>-lite` for `lite` dependencies. Scroll to the Docker command at the bottom, and copy the buildpack image URL for use in the next step.
2. Run:

```
imgpkg copy -b <BUILDPACK-IMAGE-URL> --to-repo ${INSTALL_REGISTRY_HOSTNAME}/${INSTALL_REPO}/tbs-deps/<BUILDPACK LANGUAGE>
```

Where `BUILDPACK-IMAGE-URL` is the buildpack image URL copied from the Docker command in the previous step

3. Create a `ClusterBuildpack` resource referencing the copied buildpack image:

```
apiVersion: kpack.io/v1alpha2
kind: ClusterBuildpack
metadata:
  name: out-of-band-<LANGUAGE-NAME>-<BUILDPACK-VERSION>
spec:
  image: <RELOCATED-BUILDPACKIMAGE>
  serviceAccountRef:
    name: dependencies-pull-serviceaccount
    namespace: build-service
```

Where `RELOCATED-BUILDPACKIMAGE` is the URL of relocated buildpack image from previous step.

To avoid naming collisions, follow the name conventions specified in `metadata.name`. The name can follow any convention that allows the Cluster Operator to distinguish this `ClusterBuildpack` from others installed by Tanzu Application Platform.

4. Apply the YAML from the previous step to the Tanzu Application Platform cluster:

```
kubectl apply -f <FILE-FROM-PREVIOUS-STEP>
```

The ClusterBuildpack is now deployed. Tanzu Build Service uses the latest available version to execute builds. All images that were built with older versions of the buildpack will now be rebuilt.

When you upgrade Tanzu Application Platform, new buildpacks with later versions are installed. After an upgrade, the `ClusterBuildpack` created in this procedure is not needed and can be removed.

Security context constraint for OpenShift

This topic tells you about running Tanzu Build Service on OpenShift clusters.

On OpenShift clusters Tanzu Build Service must run with a custom [Security Context Constraint](#) (SCC) to enable compliance. Tanzu Application Platform configures the following SCC for Tanzu Build Service when you configure the `kubernetes_distribution: openshift` key in the `tap-values.yaml` file.

```
---
kind: SecurityContextConstraints
apiVersion: security.openshift.io/v1
metadata:
  name: tbs-restricted-scc-with-seccomp
allowHostDirVolumePlugin: false
allowHostIPC: false
allowHostNetwork: false
allowHostPID: false
allowHostPorts: false
allowPrivilegeEscalation: false
allowPrivilegedContainer: false
allowedCapabilities:
  - NET_BIND_SERVICE
defaultAddCapabilities: null
fsGroup:
  type: RunAsAny
groups: []
priority: null
readOnlyRootFilesystem: false
requiredDropCapabilities:
  - ALL
runAsUser:
  type: MustRunAsNonRoot
seLinuxContext:
  type: MustRunAs
seccompProfiles:
  - runtime/default
supplementalGroups:
  type: RunAsAny
users: []
volumes:
  - configMap
  - downwardAPI
  - emptyDir
  - persistentVolumeClaim
  - projected
  - secret
```

It also applies the following RBAC to allow Tanzu Build Service services to use the SCC:

```
---
apiVersion: rbac.authorization.k8s.io/v1
kind: ClusterRole
```

```

metadata:
  labels:
    apps.tanzu.vmware.com/aggregate-to-workload: "true"
  annotations:
    rbac.authorization.kubernetes.io/autoupdate: "true"
  name: system:tbs:scc:restricted-with-seccomp
rules:
- apiGroups:
  - security.openshift.io
  resourceNames:
  - tbs-restricted-scc-with-seccomp
  resources:
  - securitycontextconstraints
  verbs:
  - use
---
apiVersion: rbac.authorization.k8s.io/v1
kind: ClusterRoleBinding
metadata:
  name: system:tbs:scc:restricted-with-seccomp
roleRef:
  apiGroup: rbac.authorization.k8s.io
  kind: ClusterRole
  name: system:tbs:scc:restricted-with-seccomp
subjects:
- kind: ServiceAccount
  namespace: build-service
  name: dependency-updater-serviceaccount
- kind: ServiceAccount
  namespace: build-service
  name: dependency-updater-controller-serviceaccount
- kind: ServiceAccount
  namespace: build-service
  name: secret-syncer-service-account
- kind: ServiceAccount
  namespace: build-service
  name: warmer-service-account
- kind: ServiceAccount
  namespace: build-service
  name: build-service-daemonset-serviceaccount
- kind: ServiceAccount
  namespace: cert-injection-webhook
  name: cert-injection-webhook-sa
- kind: ServiceAccount
  namespace: kpack
  name: kp-default-repository-serviceaccount
- kind: ServiceAccount
  namespace: kpack
  name: kpack-pull-lifecycle-serviceaccount
- kind: ServiceAccount
  namespace: kpack
  name: controller
- kind: ServiceAccount
  namespace: kpack
  name: webhook
- kind: ServiceAccount
  namespace: stacks-operator-system
  name: controller-manager

```

Troubleshoot Tanzu Build Service

This topic tells you how to troubleshoot Tanzu Build Service when used with Tanzu Application Platform (commonly known as TAP).

Builds fail due to volume errors on EKS running Kubernetes v1.23

Symptom

After installing or upgrading Tanzu Application Platform on an Amazon Elastic Kubernetes Service (EKS) cluster running Kubernetes v1.23, build pods show:

```
'running PreBind plugin "VolumeBinding": binding volumes: timed out waiting
for the condition'
```

Cause

This is due to the CSIMigrationAWS in this Kubernetes version, which requires users to install the Amazon EBS CSI driver to use AWS Elastic Block Store (EBS) volumes. See the [Amazon documentation](#). For more information about EKS support for Kubernetes v1.23, see the [Amazon blog post](#).

Tanzu Application Platform uses the default storage class which uses EBS volumes by default on EKS.

Solution

Follow the AWS documentation to install the [Amazon EBS CSI driver](#) before installing Tanzu Application Platform, or before upgrading to Kubernetes v1.23. See

Smart-warmer-image-fetcher reports ErrImagePull due to dockerd's layer depth limitation

Symptom

When using dockerd as the cluster's container runtime, you might see the `smart-warmer-image-fetcher` pods report a status of `ErrImagePull`.

Cause

This error might be due to dockerd's layer depth limitation, in which the maximum supported image layer depth is 125.

To verify that the `ErrImagePull` status is due to dockerd's maximum supported image layer depth, check for event messages containing the words `max depth exceeded`. For example:

```
$ kubectl get events -A | grep "max depth exceeded"
  build-service          73s          Warning   Failed           pod/smart-warmer-image-f
etcher-wxtr8           Failed to pull image
  "harbor.somewhere.com/aws-repo/build-service:clusterbuilder-full@sha256:065bb361fd91
4a3970ad3dd93c603241e69cca214707feaa6
d8617019e20b65e": rpc error: code = Unknown desc = failed to register layer: max de
pth exceeded
```

Solution

To work around this issue, configure your cluster to use containerd or CRI-O as its default container runtime. For instructions, see the following documentation for your Kubernetes cluster provider.

For AWS, see:

- [The Amazon blog](#)
- [The eksctl CLI documentation](#)

For AKS, see:

- [The Microsoft Azure documentation](#)
- [The Microsoft Azure blog](#)

For GKE, see:

- [The GKE documentation](#)

For OpenShift, see:

- [The Red Hat Hybrid Cloud blog](#)
- [The Red Hat Openshift documentation](#)

Nodes fail due to “trying to send message larger than max” error

Symptom

You see the following error, or similar, in a node status:

```
Warning ContainerGCFailed 119s (x2523 over 42h) kubelet rpc error: code = ResourceExhausted desc = grpc: trying to send message larger than max (16779959 vs. 16777216)
```

Cause

This is due to the way that the container runtime interface (CRI) handles garbage collection for unused images and containers.

Solution

Do not use Docker as the CRI because it is not supported. Some versions of EKS default to Docker as the runtime.

Build platform uses the old build cache after upgrade to new stack

Symptom

While upgrading apps to a later stack, you might encounter the build platform erroneously reusing the old build cache.

Solution

If you encounter this issue, delete, and recreate the workload in Tanzu Application Platform, or delete and recreate the image in Tanzu Build Service.

Switching from `buildservice.kp_default_repository` to `shared.image_registry`

Symptom

After switching to using the `shared.image_registry` fields in `tap-values.yaml`, your workloads might start failing with a `TemplateRejectedByAPIServer` error, with the error message: `admission webhook "validation.webhook.kpack.io" denied the request: validation failed: Immutable field changed: spec.tag.`

Cause

Tanzu Application Platform automatically appends `/buildservice` to the end of the repository specified in `shared.image_registry.project_path`. This updates the existing workload image tags, which is not allowed by Tanzu Build Service.

Solution

Delete the `images.kpack.io`, it has the same name as the workload. The workload then recreates it with valid values.

Alternatively, re-add the `buildservice.kp_default_repository_*` fields in the `tap-values.yaml`. You must set both the repository and the authentication fields to override the shared values. Set `kp_default_repository`, `kp_default_repository_secret.name`, and `kp_default_repository_secret.namespace`.

Create a GitHub build action (Alpha)

This topic tells you how to use a GitHub action to create a Tanzu Build Service build on a cluster.



Important

Alpha features are experimental and are not ready for production use. Configuration and behavior is likely to change, and functionality might be removed in a future release.

Prerequisites

- Ensure that [Tanzu Application Platform](#) is installed.

Procedure

Developer namespace

1. Create a developer namespace where the build resource will be created.

```
kubectl create namespace DEVELOPER-NAMESPACE
```

2. Create a service account in the `DEVELOPER-NAMESPACE` that has access to the registry credentials. This service account name will be used in the action.

Access to Kubernetes API server

The GitHub action talks directly to the Kubernetes API server, if you are running this on `github.com` with the default action runners, ensure that your API server is accessible from GitHub's [IP ranges](#). Alternatively, it might be possible to run the action on a custom runner within your firewall (with access to the Tanzu Application Platform cluster).

Permissions Required

These are the minimum permissions required on the Tanzu Build Service cluster:

```
```console
ClusterRole
 └─ kpack.io
 └─ clusterbuilders verbs=[get]
Role (DEVELOPER NAMESPACE)
├── ''
│ └─ pods verbs=[get watch list] ✓
│ └─ pods/log verbs=[get] ✓
└─ kpack.io
 └─ builds verbs=[get watch list create delete] ✓
...
```
```

This example contains the minimum required permissions:

```
```yaml
apiVersion: v1
kind: Namespace
metadata:
 name: DEVELOPER_NAMESPACE

apiVersion: v1
kind: ServiceAccount
metadata:
 namespace: DEVELOPER_NAMESPACE
 name: github-actions

apiVersion: rbac.authorization.k8s.io/v1
kind: ClusterRoleBinding
metadata:
 name: github-actions
subjects:
 - kind: ServiceAccount
 namespace: DEVELOPER_NAMESPACE
 name: github-actions
roleRef:
 kind: ClusterRole
 name: github-actions
 apiGroup: rbac.authorization.k8s.io

apiVersion: rbac.authorization.k8s.io/v1
kind: RoleBinding
metadata:
 name: github-actions
 namespace: DEVELOPER_NAMESPACE
subjects:
 - kind: ServiceAccount
 namespace: DEVELOPER_NAMESPACE
 name: github-actions
roleRef:
 kind: Role
 name: github-actions
 apiGroup: rbac.authorization.k8s.io

apiVersion: rbac.authorization.k8s.io/v1
kind: ClusterRole
metadata:
 name: github-actions
rules:
 - apiGroups: ['kpack.io']
 resources:
 - clusterbuilders
 verbs: ['get']
...
```
```

```

apiVersion: rbac.authorization.k8s.io/v1
kind: Role
metadata:
  name: github-actions
  namespace: DEVELOPER_NAMESPACE
rules:
  - apiGroups: ['']
    resources: ['pods']
    verbs: ['get', 'watch', 'list']
  - apiGroups: ['']
    resources: ['pods/log']
    verbs: ['get']
  - apiGroups: ['kpack.io']
    resources:
      - builds
    verbs: ['get', 'watch', 'list', 'create', 'delete']
...

```

To access the values on Google Kubernetes Engine (steps might vary on other IaaS providers):

```

```console
DEV_NAMESPACE=DEVELOPER_NAMESPACE
SECRET=$(kubectl get sa github-actions -oyaml -n $DEV_NAMESPACE | yq '.secrets[0].name')

CA_CERT=$(kubectl get secret $SECRET -oyaml -n $DEV_NAMESPACE | yq '.data."ca.crt"')
NAMESPACE=$(kubectl get secret $SECRET -oyaml -n $DEV_NAMESPACE | yq '.data.namespace | base64 -d')
TOKEN=$(kubectl get secret $SECRET -oyaml -n $DEV_NAMESPACE | yq '.data.token | base64 -d')
SERVER=$(kubectl config view --minify | yq '.clusters[0].cluster.server')
...

```

Create the required secrets on the repository through [GitHub.com](#) or through the [gh CLI](#):

```

```console
gh secret set CA_CERT --app actions --body "$CA_CERT"
gh secret set NAMESPACE --app actions --body "$NAMESPACE"
gh secret set TOKEN --app actions --body "$TOKEN"
gh secret set SERVER --app actions --body "$SERVER"
...

```

Use the action

1. To use the action in a workflow, run the following YAML:

```

- uses: vmware-tanzu/build-image-action@v1-alpha
  with:
    ## Authorization
    # Host of the API server
    server: `${{ secrets.SERVER }}`
    # CA Certificate of the API Server
    ca_cert: `${{ secrets.CA_CERT }}`
    # Service Account token to access Kubernetes
    token: `${{ secrets.TOKEN }}`
    # _(required)_ The namespace to create the build resource in
    namespace: `${{ secrets.NAMESPACE }}`

    ## Image configuration
    # _(required)_ Destination for the built image
    # Example: gcr.io/<my-project>/<my-image>
    destination: ''
    # Optional list of build time environment variables
    env: ''

```

```
# Name of the service account in the namespace, defaults to `default`
serviceAccountName: ''
# Name of the cluster builder to use, defaults to `default`
clusterBuilder: ''
# Max active time that the pod can run for in seconds, defaults to 3600
timeout:
```

For example:

```
- name: Build Image
  id: build
  uses: vmware-tanzu/build-image-action@v1-alpha
  with:
    # Authorization
    server: ${ secrets.SERVER }
    token: ${ secrets.TOKEN }
    ca_cert: ${ secrets.CA_CERT }
    namespace: ${ secrets.NAMESPACE }
    # Image configuration
    destination: gcr.io/project-id/name-for-image
    serviceAccountName: my-sa-that-has-access-to-reg-credentials
    env: |
      BP_JAVA_VERSION=17
```

2. The previous step should output the full name, including the SHA of the built image. To use the output in a subsequent step:

```
- name: Do something with image
  run:
    echo "${ steps.build.outputs.name }"
```

Debugging

To run this action in “debug” mode, add a secret called `ACTIONS_STEP_DEBUG` with the value set to `true` as documented in the [GitHub Action Docs](#).

Overview of Tanzu Developer Portal

Tanzu Developer Portal (formerly called Tanzu Application Platform GUI) is a tool for your developers to view your applications and services running for your organization. This portal provides a central location in which you can view dependencies, relationships, technical documentation, and the service status.

Tanzu Developer Portal is built from the [Cloud Native Computing Foundation’s](#) project [Backstage](#).

Tanzu Developer Portal consists of the following components:

- **Your organization catalog:**

The catalog serves as the primary visual representation of your running services (components) and applications (systems).

- **Tanzu Developer Portal plug-ins:**

These plug-ins expose capabilities regarding specific Tanzu Application Platform tools. Initially the included plug-ins are:

- Runtime Resources Visibility
- Application Live View
- Application Accelerator

- API Documentation
- Supply Chain Choreographer
- **TechDocs:**

This plug-in enables you to store your technical documentation in Markdown format in a source-code repository and display it alongside the relevant catalog entries.

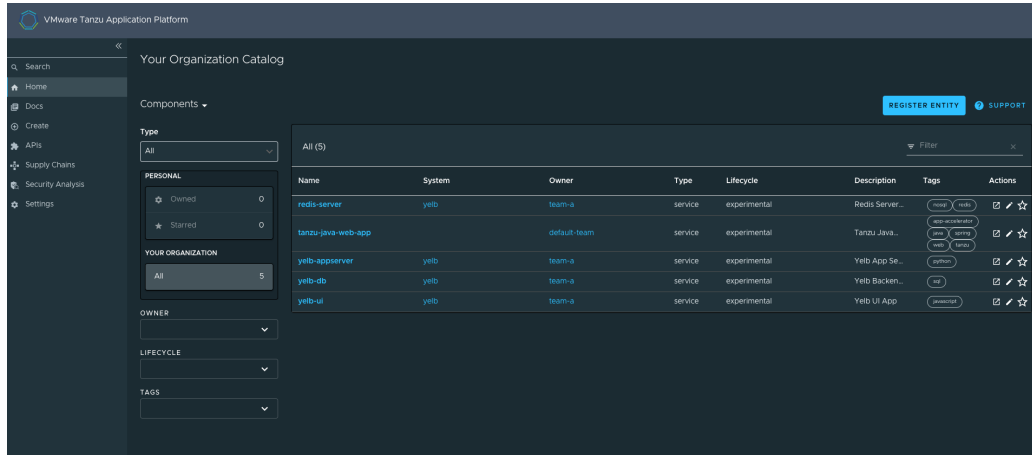

- **Search:**
This plug-in enables you to search your organization’s catalog, including domains, systems, components, APIs, accelerators, and TechDocs.
- **A Git repository:**
Tanzu Developer Portal stores the following in a Git repository:
 - The structure for your application catalog.
 - Your technical documentation about the catalog items, if you enable Tanzu Developer Portal TechDocs capabilities.

You can host the structure for your application catalog and your technical documentation in the same repository as your source code.

Overview of Tanzu Developer Portal

Tanzu Developer Portal (formerly called Tanzu Application Platform GUI) is a tool for your developers to view your applications and services running for your organization. This portal provides a central location in which you can view dependencies, relationships, technical documentation, and the service status.

Tanzu Developer Portal is built from the [Cloud Native Computing Foundation's](#) project [Backstage](#).

Tanzu Developer Portal consists of the following components:

- **Your organization catalog:**
The catalog serves as the primary visual representation of your running services (components) and applications (systems).
- **Tanzu Developer Portal plug-ins:**
These plug-ins expose capabilities regarding specific Tanzu Application Platform tools. Initially the included plug-ins are:
 - Runtime Resources Visibility
 - Application Live View

- Application Accelerator
- API Documentation
- Supply Chain Choreographer

- **TechDocs:**

This plug-in enables you to store your technical documentation in Markdown format in a source-code repository and display it alongside the relevant catalog entries.

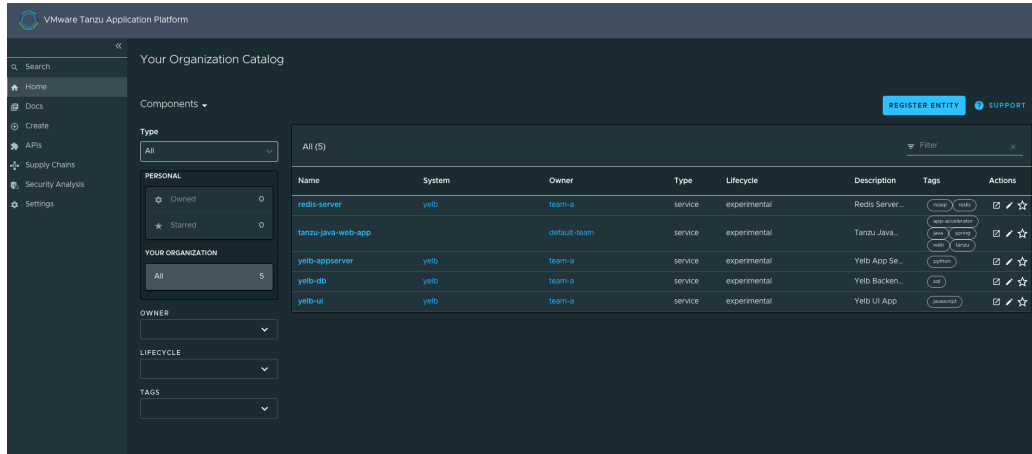

- **Search:**

This plug-in enables you to search your organization’s catalog, including domains, systems, components, APIs, accelerators, and TechDocs.

- **A Git repository:**

Tanzu Developer Portal stores the following in a Git repository:

- The structure for your application catalog.
- Your technical documentation about the catalog items, if you enable Tanzu Developer Portal TechDocs capabilities.

You can host the structure for your application catalog and your technical documentation in the same repository as your source code.

Install Tanzu Developer Portal

This topic tells you how to install Tanzu Developer Portal (formerly called Tanzu Application Platform GUI) from the Tanzu Application Platform package repository.



Note

Follow the steps in this topic if you do not want to use a profile to install Tanzu Developer Portal. For more information about profiles, see [Components and installation profiles](#).

Prerequisites

Before installing Tanzu Developer Portal:

- Complete all prerequisites to install Tanzu Application Platform. For more information, see the Tanzu Application Platform [Prerequisites](#).

- Create a Git repository for Tanzu Developer Portal software catalogs, with a token allowing read access. Supported Git infrastructure includes:
 - GitHub
 - GitLab
 - Azure DevOps
- Install Tanzu Developer Portal Blank Catalog:
 1. Download the **tap-gui-catalogs-latest** folder in the [Broadcom Support Portal](#).
 2. Extract Tanzu Developer Portal Blank Catalog to your Git repository. This serves as the configuration location for your organization's Catalog inside Tanzu Developer Portal.

Procedure

To install Tanzu Developer Portal on a compliant Kubernetes cluster:

1. List version information for the package by running:

```
tanzu package available list tap-gui.tanzu.vmware.com --namespace tap-install
```

For example:

```
$ tanzu package available list tap-gui.tanzu.vmware.com --namespace tap-install
- Retrieving package versions for tap-gui.tanzu.vmware.com...
NAME                                VERSION    RELEASED-AT
tap-gui.tanzu.vmware.com            1.0.1     2022-01-10T13:14:23Z
```

2. (Optional) Make changes to the default installation settings by running:

```
tanzu package available get tap-gui.tanzu.vmware.com/VERSION-NUMBER --values-schema hema --namespace \
tap-install
```

Where **VERSION-NUMBER** is the number you discovered previously. For example, **1.0.1**.

For more information about values schema options, see the individual product documentation.

3. Create **tap-gui-values.yaml** and paste in the following YAML:

```
ingressEnabled: true
ingressDomain: "INGRESS-DOMAIN"
app_config:
  catalog:
    locations:
      - type: url
        target: https://GIT-CATALOG-URL/catalog-info.yaml
```

Where:

- **INGRESS-DOMAIN** is the subdomain for the host name that you point at the **tanzu-shared-ingress** service's External IP address.
 - **GIT-CATALOG-URL** is the path to the **catalog-info.yaml** catalog definition file. It is from either the included Blank catalog (provided as an additional download named **Blank Tanzu Developer Portal Catalog**) or a Backstage-compliant catalog that you've already built and posted on the Git infrastructure specified in [Adding Tanzu Developer Portal integrations](#).
4. Install the package by running:

```
tanzu package install tap-gui \
  --package tap-gui.tanzu.vmware.com \
  --version VERSION -n tap-install \
  --values-file tap-gui-values.yaml
```

Where `VERSION` is the version that you want. For example, `1.0.1`.

For example:

```
$ tanzu package install tap-gui --package tap-gui.tanzu.vmware.com --version 1.0.1 -n \
tap-install --values-file tap-gui-values.yaml
- Installing package 'tap-gui.tanzu.vmware.com'
| Getting package metadata for 'tap-gui.tanzu.vmware.com'
| Creating service account 'tap-gui-default-sa'
| Creating cluster admin role 'tap-gui-default-cluster-role'
| Creating cluster role binding 'tap-gui-default-cluster-rolebinding'
| Creating secret 'tap-gui-default-values'
- Creating package resource
- Package install status: Reconciling

Added installed package 'tap-gui' in namespace 'tap-install'
```

5. Verify that the package installed by running:

```
tanzu package installed get tap-gui -n tap-install
```

For example:

```
$ tanzu package installed get tap-gui -n tap-install
| Retrieving installation details for cc...
NAME:                tap-gui
PACKAGE-NAME:        tap-gui.tanzu.vmware.com
PACKAGE-VERSION:     1.0.1
STATUS:              Reconcile succeeded
CONDITIONS:          [{"ReconcileSucceeded True  }]
USEFUL-ERROR-MESSAGE:
```

Verify that `STATUS` is `Reconcile succeeded`.

6. To access Tanzu Developer Portal, use the service you exposed in the `service_type` field in the values file.

Runtime configuration options for Tanzu Developer Portal

You can provide a series of options to the Tanzu Developer Portal (formerly called Tanzu Application Platform GUI) package to configure it and do some basic [runtime customization](#).

Identify the Tanzu Developer Portal version you have available

From the Tanzu CLI, discover the Tanzu Developer Portal package version that is available to configure by running:

```
tanzu package available get tap-gui.tanzu.vmware.com -n INSTALL-NAMESPACE
```

Where `INSTALL-NAMESPACE` is the namespace in which you configured the Tanzu Application Platform installation. In most cases the namespace is `tap-install`.

For example:

```
$ tanzu package available get tap-gui.tanzu.vmware.com -n tap-install

NAME:                tap-gui.tanzu.vmware.com
DISPLAY-NAME:        Tanzu Application Platform GUI
CATEGORIES:
SHORT-DESCRIPTION:   web app graphical user interface for Tanzu Application Platfor
m
LONG-DESCRIPTION:    web app graphical user interface for Tanzu Application Platfor
m
PROVIDER:            VMware
MAINTAINERS:         - name: VMware
SUPPORT-DESCRIPTION: https://tanzu.vmware.com/support

VERSION  RELEASED-AT
1.7.6    2023-10-17 00:25:21 +0000 UTC
```

Display the possible values options for Tanzu Developer Portal

From the Tanzu CLI, identify possible values options for Tanzu Developer Portal by running:

```
tanzu package available get tap-gui.tanzu.vmware.com/VERSION --values-schema -n INSTAL
L-NAMESPACE
```

Where:

- `VERSION` is the Tanzu Developer Portal package version you learned earlier
- `INSTALL-NAMESPACE` is the namespace in which you configured the Tanzu Application Platform installation. In most cases the namespace is `tap-install`.

For example:

```
$ tanzu package available get tap-gui.tanzu.vmware.com/1.7.6 --values-schema -n tap-in
stall

KEY                                DEFAULT  TYPE
DESCRIPTION
#Details of all the possible configuration values
...
```

Customize the portal

This topic tells you how to customize the portal in Tanzu Developer Portal (formerly named Tanzu Application Platform GUI).

Customize branding

To customize the branding in your portal, you can choose the name of the portal and the logo for it. To make these customizations:

1. Provide additional configuration parameters to the `app_config` section of `tap-values.yaml`:

```
tap_gui:
  app_config:
    customize:
      custom_logo: 'BASE-64-IMAGE'
      custom_name: 'PORTAL-NAME'
```

Where:

- o `BASE-64-IMAGE` is the image encoded in base64. A 512-pixel by 512-pixel PNG image with a transparent background is optimal.
- o `PORTAL-NAME` is the name of your portal, such as `Our Custom Developer Experience Portal`.

2. Reinstall your Tanzu Developer Portal package by following steps in [Upgrading Tanzu Application Platform](#).

After the updated values configuration file is applied in Tanzu Developer Portal, you see the customized version of your portal.

If there is an error in any of the supplied images encoded in base64 or in your choice of portal name, Tanzu Developer Portal reverts to the original branding template.

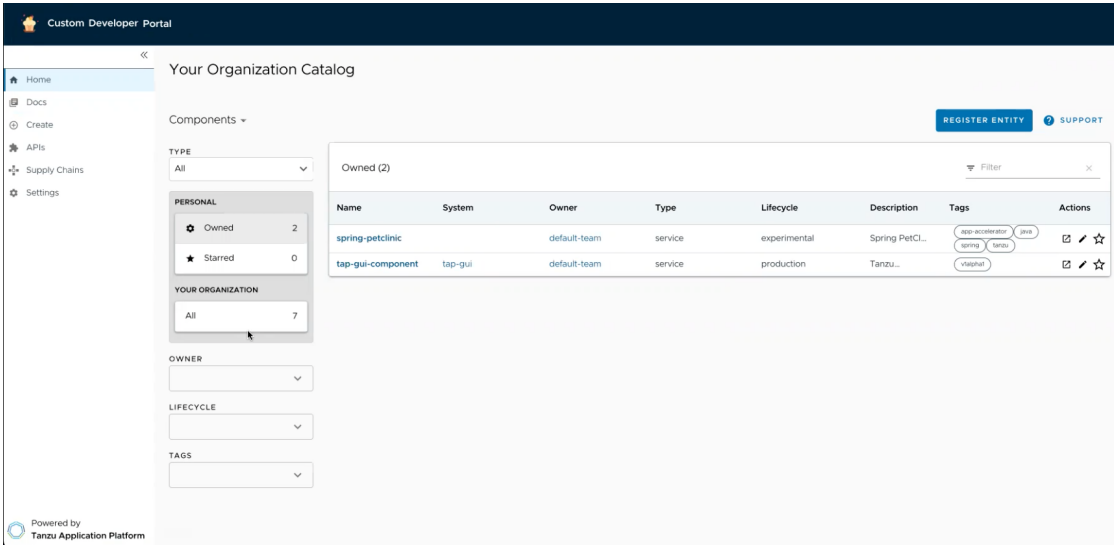

Customize the Software Catalog page

You can customize the name of your organization on the Software Catalog page of Tanzu Developer Portal portal. By default, the portal displays **Your Organization** next to **Catalog** and in the selection box.

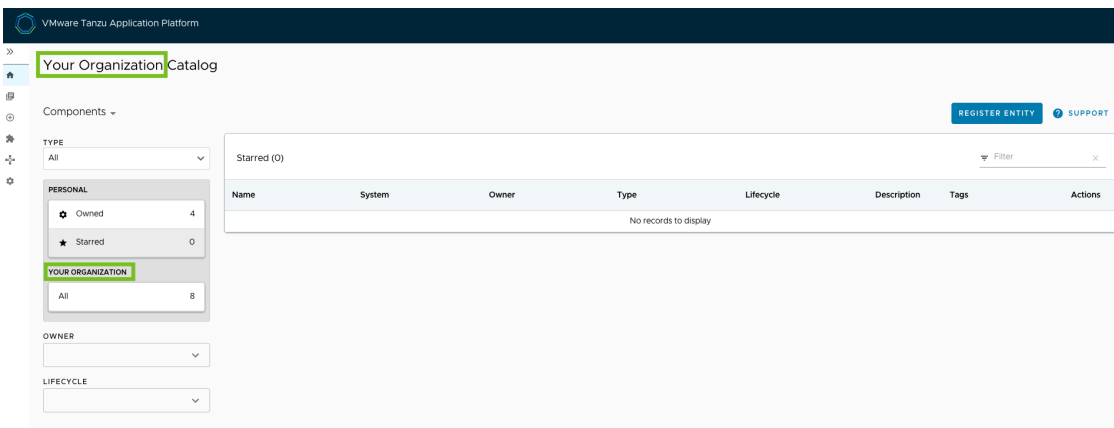

Customize the name of the organization

To customize the name of the organization for the software catalog in your portal:

1. Provide additional configuration parameters to the `app_config` section of your `tap-values.yaml` file:

```
tap_gui:
  app_config:
    organization:
      name: 'ORG-NAME'
```

Where `ORG-NAME` is the name of your organization for the software catalog, such as `Our Organization Name`. You don't need to add `Catalog` to the `ORG-NAME`.

2. Reinstall your Tanzu Developer Portal package by following the steps in [Upgrading Tanzu Application Platform](#).

After the updated values configuration file is applied in Tanzu Developer Portal, you see the customized version of your portal.

If there is an error in the provided configuration parameters, Tanzu Developer Portal reverts to the original organization name.

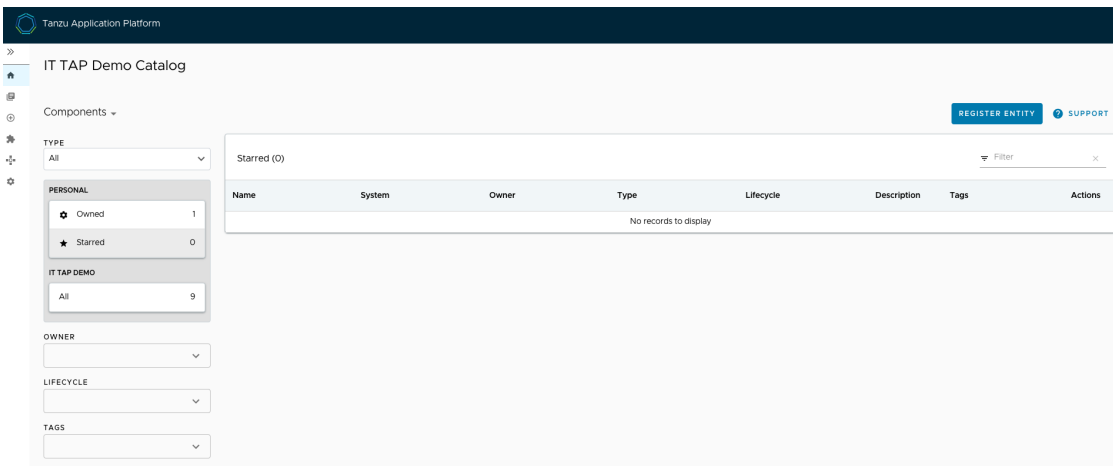

Prevent changes to the software catalog

You can deactivate the **Register Entity** button to prevent a user from making changes to the software catalog, including registering and deregistering locations. To do so, add `readonly: true` to the `catalog` section in `tap-values.yaml`, as in this example:

```
tap_gui:
  app_config:
    catalog:
      readonly: true
```

Customize the Authentication page

To customize the portal name on the **Authentication** page and the name of the browser tab for Tanzu Developer Portal:

1. Provide additional configuration parameters to the `app_config` section of your `tap-values.yaml` file:

```
tap_gui:
  app_config:
    app:
      title: 'CUSTOM-TAB-NAME'
```

Where `CUSTOM-TAB-NAME` is the name on the Authentication page and the browser tab of your portal, such as `Our Organization Full Name`.

2. Reinstall your Tanzu Developer Portal package by following the steps in [Upgrading Tanzu Application Platform](#).

After the updated values configuration file is applied in Tanzu Developer Portal, you see the customized version of your portal.

Customize the default view

You can set your default route when the user is accessing your portal. Without this customization, when the user accesses the Tanzu Developer Portal URL, it displays the list of owned components of the software catalog.

To change the default view:

1. Provide additional configuration parameters to the `app_config` section of your `tap-values.yaml` file:

```
tap_gui:
  app_config:
    customize:
      default_route: 'YOUR-PREFERRED-ROUTE'
```

Where `YOUR-PREFERRED-ROUTE` is the path to the route that the portal uses by default. For example, you can type `/catalog?filters%5Bkind%5D=component&filters%5Buser%5D=all` to show all components of the software catalog instead of defaulting to owned components. As another example, you can type `/create` to show Application Accelerator when the portal starts.



Caution

Tanzu Developer Portal redirects you to `tap-gui.INGRESS-DOMAIN/YOUR-PREFERRED-ROUTE` even if there is an error in `YOUR-PREFERRED-ROUTE`.

2. Reinstall your Tanzu Developer Portal package by following the steps in [Upgrading Tanzu Application Platform](#).

After the updated values configuration file is applied in Tanzu Developer Portal, you see the customized version of your portal.

Customize security banners

You can instruct Tanzu Developer Portal to create security banners on the top and bottom of the page. To add security banners to Tanzu Developer Portal:

1. Provide additional configuration parameters to the `app_config` section of your `tap-values.yaml` file, as in the following example:

```
tap_gui:
  app_config:
    customize:
      banners:
        text: 'CUSTOM-TEXT'
        color: 'OPTIONAL-CUSTOM-TEXT-COLOR'
        bg: 'CUSTOM-BACKGROUND-COLOR'
        link: 'OPTIONAL-LINK'
```

Where:

- `CUSTOM-TEXT` is the text that is displayed in the banner. Keep this text short to accommodate various screen sizes.
- `OPTIONAL-CUSTOM-TEXT-COLOR` is the color of the text displayed in the banner. Setting this is optional. It accepts CSS colors, such as `#ffffff`. The default color is `#FFFFFF`.
- `CUSTOM-BACKGROUND-COLOR` is the color of the banner itself. Setting this is optional. It accepts CSS colors, such as `#ffffff`. The default color is `#C23B2E`
- `OPTIONAL-LINK` is the link to which your text redirects. Setting this is optional.

2. Reinstall your Tanzu Developer Portal package by following the steps in [Upgrading Tanzu Application Platform](#).

After the updated values configuration file is applied in Tanzu Developer Portal, the customized version of your portal is displayed.

Customize the portal

This topic tells you how to customize the portal in Tanzu Developer Portal (formerly named Tanzu Application Platform GUI).

Customize branding

To customize the branding in your portal, you can choose the name of the portal and the logo for it. To make these customizations:

1. Provide additional configuration parameters to the `app_config` section of `tap-values.yaml`:

```
tap_gui:
  app_config:
    customize:
      custom_logo: 'BASE-64-IMAGE'
      custom_name: 'PORTAL-NAME'
```

Where:

- `BASE-64-IMAGE` is the image encoded in base64. A 512-pixel by 512-pixel PNG image with a transparent background is optimal.
- `PORTAL-NAME` is the name of your portal, such as `Our Custom Developer Experience Portal`.

2. Reinstall your Tanzu Developer Portal package by following steps in [Upgrading Tanzu Application Platform](#).

After the updated values configuration file is applied in Tanzu Developer Portal, you see the customized version of your portal.

If there is an error in any of the supplied images encoded in base64 or in your choice of portal name, Tanzu Developer Portal reverts to the original branding template.

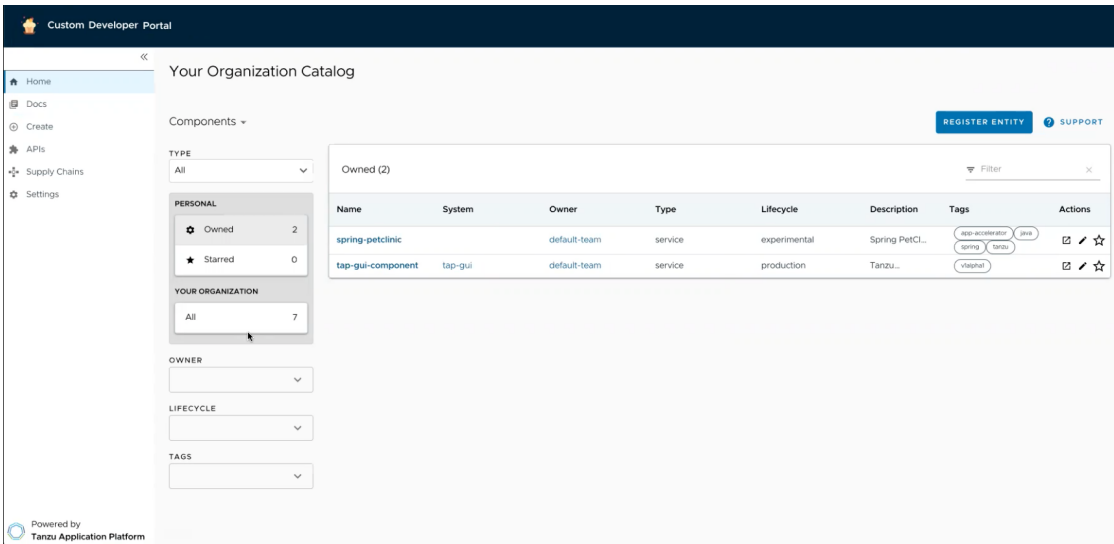

Customize the Software Catalog page

You can customize the name of your organization on the Software Catalog page of Tanzu Developer Portal. By default, the portal displays **Your Organization** next to **Catalog** and in the selection box.

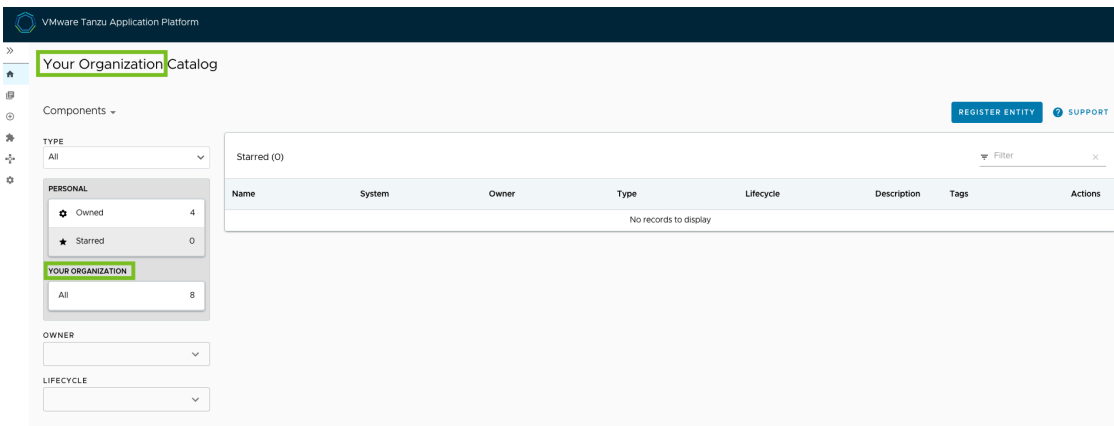

Customize the name of the organization

To customize the name of the organization for the software catalog in your portal:

1. Provide additional configuration parameters to the `app_config` section of your `tap-values.yaml` file:

```
tap_gui:
  app_config:
    organization:
      name: 'ORG-NAME'
```

Where `ORG-NAME` is the name of your organization for the software catalog, such as `Our Organization Name`. You don't need to add `Catalog` to the `ORG-NAME`.

2. Reinstall your Tanzu Developer Portal package by following the steps in [Upgrading Tanzu Application Platform](#).

After the updated values configuration file is applied in Tanzu Developer Portal, you see the customized version of your portal.

If there is an error in the provided configuration parameters, Tanzu Developer Portal reverts to the original organization name.

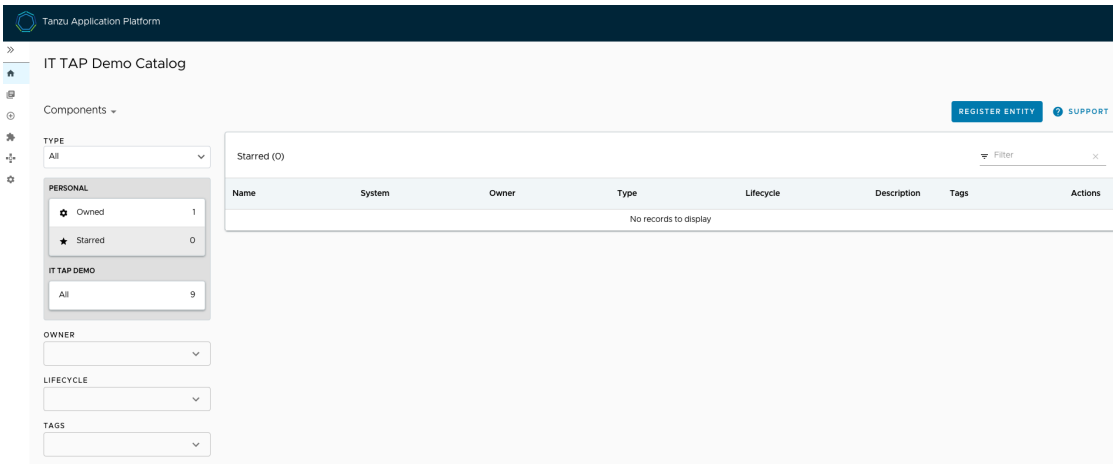

Prevent changes to the software catalog

You can deactivate the **Register Entity** button to prevent a user from making changes to the software catalog, including registering and deregistering locations. To do so, add `readonly: true` to the `catalog` section in `tap-values.yaml`, as in this example:

```
tap_gui:
  app_config:
    catalog:
      readonly: true
```

Customize the Authentication page

To customize the portal name on the **Authentication** page and the name of the browser tab for Tanzu Developer Portal:

1. Provide additional configuration parameters to the `app_config` section of your `tap-values.yaml` file:

```
tap_gui:
  app_config:
    app:
      title: 'CUSTOM-TAB-NAME'
```

Where `CUSTOM-TAB-NAME` is the name on the Authentication page and the browser tab of your portal, such as `Our Organization Full Name`.

2. Reinstall your Tanzu Developer Portal package by following the steps in [Upgrading Tanzu Application Platform](#).

After the updated values configuration file is applied in Tanzu Developer Portal, you see the customized version of your portal.

Customize the default view

You can set your default route when the user is accessing your portal. Without this customization, when the user accesses the Tanzu Developer Portal URL, it displays the list of owned components of the software catalog.

To change the default view:

1. Provide additional configuration parameters to the `app_config` section of your `tap-values.yaml` file:

```
tap_gui:
  app_config:
    customize:
      default_route: 'YOUR-PREFERRED-ROUTE'
```

Where `YOUR-PREFERRED-ROUTE` is the path to the route that the portal uses by default. For example, you can type `/catalog?filters%5Bkind%5D=component&filters%5Buser%5D=all` to show all components of the software catalog instead of defaulting to owned components. As another example, you can type `/create` to show Application Accelerator when the portal starts.



Caution

Tanzu Developer Portal redirects you to `tap-gui.INGRESS-DOMAIN/YOUR-PREFERRED-ROUTE` even if there is an error in `YOUR-PREFERRED-ROUTE`.

2. Reinstall your Tanzu Developer Portal package by following the steps in [Upgrading Tanzu Application Platform](#).

After the updated values configuration file is applied in Tanzu Developer Portal, you see the customized version of your portal.

Customize security banners

You can instruct Tanzu Developer Portal to create security banners on the top and bottom of the page. To add security banners to Tanzu Developer Portal:

1. Provide additional configuration parameters to the `app_config` section of your `tap-values.yaml` file, as in the following example:

```
tap_gui:
  app_config:
    customize:
      banners:
        text: 'CUSTOM-TEXT'
        color: 'OPTIONAL-CUSTOM-TEXT-COLOR'
        bg: 'CUSTOM-BACKGROUND-COLOR'
        link: 'OPTIONAL-LINK'
```

Where:

- o `CUSTOM-TEXT` is the text that is displayed in the banner. Keep this text short to accommodate various screen sizes.
- o `OPTIONAL-CUSTOM-TEXT-COLOR` is the color of the text displayed in the banner. Setting this is optional. It accepts CSS colors, such as `#ffffff`. The default color is `#FFFFFF`.
- o `CUSTOM-BACKGROUND-COLOR` is the color of the banner itself. Setting this is optional. It accepts CSS colors, such as `#ffffff`. The default color is `#C23B2E`.
- o `OPTIONAL-LINK` is the link to which your text redirects. Setting this is optional.

2. Reinstall your Tanzu Developer Portal package by following the steps in [Upgrading Tanzu Application Platform](#).

After the updated values configuration file is applied in Tanzu Developer Portal, the customized version of your portal is displayed.

Customize the Support menu

This topic tells you how to customize the support menu in Tanzu Developer Portal (formerly named Tanzu Application Platform GUI).

Overview

Many important pages of Tanzu Developer Portal (formerly named Tanzu Application Platform GUI) have a **Support** button that displays a pop-out menu. This menu contains a one-line description of the page the user is looking at, and a list of support item groupings.

All your software catalog entities



Contact Support
[Tanzu Support Page](#)



Documentation
[Tanzu Application Platform Documentation](#)

CLOSE

As standard, there are two support item groupings:

- Contact Support, which is marked with an **email** icon and contains a link to VMware Tanzu's support portal.
- Documentation, which is marked with a **docs** icon and contains a link to the Tanzu Application Platform documentation that you are currently reading.

Customizing

The set of support item groupings is completely customizable. However, you might want to offer custom in-house links for your Tanzu Application Platform users rather than simply sending them to VMware support and documentation. You can provide this configuration by using your `tap-values.yaml`. Here is a configuration snippet, which produces the default support menu:

```
tap_gui:
  app_config:
    app:
      support:
        url: https://tanzu.vmware.com/support
        items:
          - title: Contact Support
            icon: email
            links:
              - url: https://tanzu.vmware.com/support
```



```
title: Tanzu Support Page
- title: Documentation
  icon: docs
  links:
    - url: https://docs.vmware.com/en/VMware-Tanzu-Application-Platform/index.html
      title: Tanzu Application Platform Documentation
```

Structure of the support configuration

URL

The `url` field under the `support` section, for example,

```
support:
  url: https://tanzu.vmware.com/support
```

provides the address of the **contact support** link that appears on error pages.

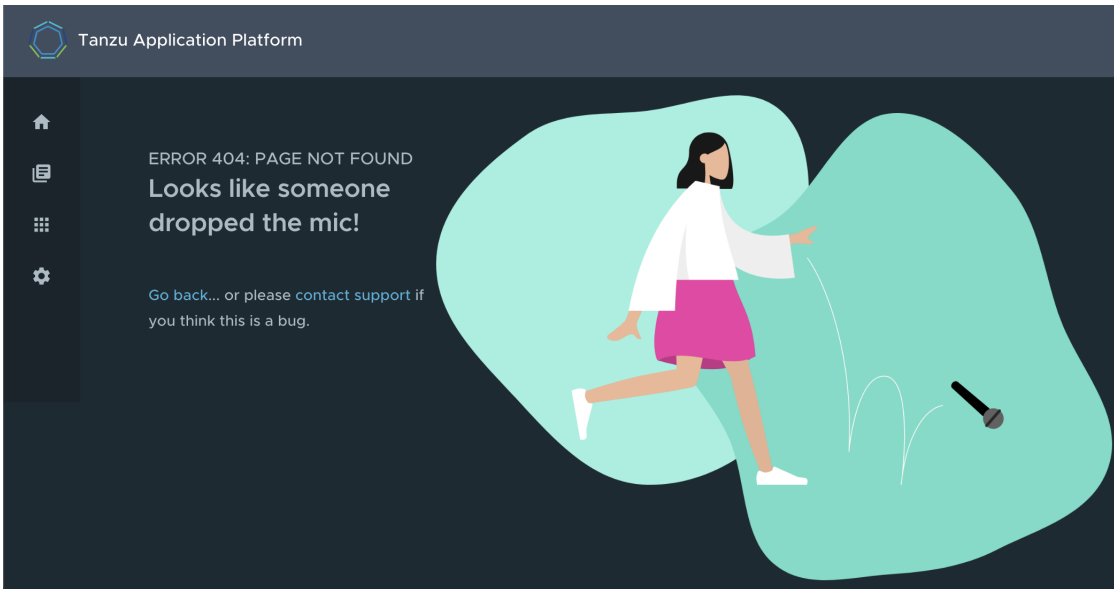

Items

The `items` field under the `support` section, for example, provides the set of support item groupings to display when the support menu is expanded.

Title

The `title` field on a support item grouping, for example,

```
items:
  - title: Contact Support
```

provides the label for the grouping.

Icon

The `icon` field on a support item grouping, for example,

```
items:
  - icon: email
```

provides the icon to use for that grouping. The valid choices are:

- `brokenImage`
- `catalog`
- `chat`
- `dashboard`
- `docs`
- `email`
- `github`
- `group`
- `help`
- `user`
- `warning`

Links

The `links` field on a support item grouping, for example,

```
items:
  - links:
    - url: https://tanzu.vmware.com/support
      title: Tanzu Support Page
```

is a list of YAML objects that render as links. Each link has the text given by the `title` field and links to the value of the `url` field.

Customize the Tanzu Developer Portal telemetry collection

This topic tells you how to customize telemetry collection for Tanzu Developer Portal (formerly named Tanzu Application Platform GUI).

Customize organization ID

By default, each instance of Tanzu Developer Portal is assigned to a random organization ID to ensure that your sensitive information is not revealed.

However, you can choose to customize your organization ID and self-identify. Doing so allows VMware to observe account-level telemetry, such as frequency of portal use, most popular function, and so on. All personally identifiable information remains anonymized in any case. The organization name is hashed to prevent VMware from identifying you by the value.

To customize:

1. Provide additional configuration parameters to the `app_config` section of `tap-values.yaml`:

```
tap_gui:
  app_config:
    pendoAnalytics:
      organizationId: 'ORGANIZATION-NAME'
```

Where `ORGANIZATION-NAME` is the name of your organization or the name of the Tanzu Developer Portal instance of your choice. `ORGANIZATION-NAME` must be unique and static

across an instance of Tanzu Developer Portal so that your organization name remains the same across refreshes of the Tanzu Application Platform database.

2. Reinstall your Tanzu Developer Portal package by following the steps in [Upgrade Tanzu Application Platform](#).

After the updated values configuration file is applied in Tanzu Developer Portal, your organization ID is updated.

Access Tanzu Developer Portal

This topic tells you how to access Tanzu Developer Portal (formerly called Tanzu Application Platform GUI) by using one of the following methods:

- Access with the LoadBalancer method (default)
- Access with the shared Ingress method

Access with the LoadBalancer method (default)

1. Verify that you specified the `service_type` for Tanzu Developer Portal in `tap-values.yaml`, as in this example:

```
tap_gui:
  service_type: LoadBalancer
```

2. Obtain the external IP address of your LoadBalancer by running:

```
kubectl get svc -n tap-gui
```

3. Access Tanzu Developer Portal by using the external IP address with the default port of 7000. It has the following form:

```
http://EXTERNAL-IP:7000
```

Where `EXTERNAL-IP` is the external IP address of your LoadBalancer.

Access with the shared Ingress method

The Ingress method of access for Tanzu Developer Portal uses the shared `tanzu-system-ingress` instance of Contour that is installed as part of the Profile installation.

1. The Ingress method of access requires that you have a DNS host name that you can point at the External IP address of the `envoy` service that the shared `tanzu-system-ingress` uses. Retrieve this IP address by running:

```
kubectl get service envoy -n tanzu-system-ingress
```

This returns a value similar to this example:

```
$ kubectl get service envoy -n tanzu-system-ingress
NAME      TYPE           CLUSTER-IP      EXTERNAL-IP      PORT(S)
AGE
envoy     LoadBalancer   10.0.242.171    40.118.168.232   80:31389/TCP,443:31780/TCP
CP        27h
```

The IP address in the `EXTERNAL-IP` field is the one that you point a DNS host record to. Tanzu Developer Portal prepends `tap-gui` to your provided subdomain. This makes the final

host name `tap-gui.YOUR-SUBDOMAIN`. You use this host name in the appropriate fields in the `tap-values.yaml` file mentioned later.

- Specify parameters in `tap-values.yaml` related to Ingress. For example:

```
shared:
  ingress_domain: "example.com"
```

- Update your other host names in the `tap_gui` section of your `tap-values.yaml` with the new host name. For example:

```
shared:
  ingress_domain: "example.com"

tap_gui:
# Existing tap-values.yaml above
  app_config:
    app:
      baseUrl: http://tap-gui.example.com # No port needed with Ingress
    integrations:
      github: # Other are integrations available
        - host: github.com
          token: GITHUB-TOKEN
    catalog:
      locations:
        - type: url
          target: https://GIT-CATALOG-URL/catalog-info.yaml
    backend:
      baseUrl: http://tap-gui.example.com # No port needed with Ingress
    cors:
      origin: http://tap-gui.example.com # No port needed with Ingress
```

- Update your package installation with your changed `tap-values.yaml` file by running:

```
tanzu package installed update tap --package tap.tanzu.vmware.com --version VER
SION-NUMBER \
--values-file tap-values.yaml -n tap-install
```

Where `VERSION-NUMBER` is your Tanzu Application Platform version. For example, `1.6.13`.

- Use a web browser to access Tanzu Developer Portal at the host name that you provided.

Catalog operations

The software catalog setup procedures in this topic make use of Backstage. For more information about Backstage, see the [Backstage documentation](#).

Adding catalog entities

This section describes how you can format your own catalog. Creating catalogs consists of building metadata YAML files stored together with the code. This information is read from a Git-compatible repository consisting of these YAML catalog definition files. Changes made to the catalog definitions on your Git infrastructure are automatically reflected every 200 seconds or when manually registered.

For each catalog entity kind you create, there is a file format you must follow. For information about all types of entities, see the [Backstage documentation](#).

You can use the example blank catalog described in the Tanzu Developer Portal (formerly named Tanzu Application Platform GUI) [prerequisites](#) as a foundation for creating user, group, system, and main component YAML files.

The organization contains Group 1, and Group 1 contains Users 1 and 2. System contains Components 1 and 2. User 1 owns Component 2. Group 1 owns System.

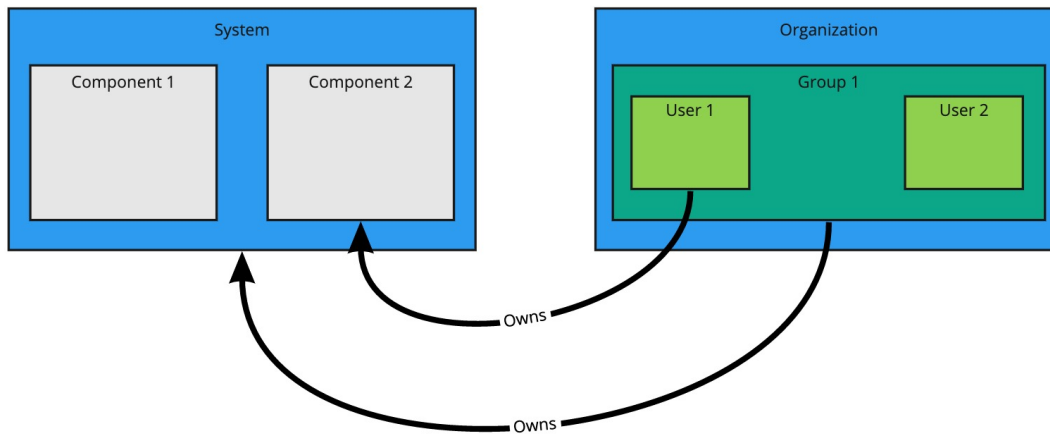

Users and groups

A user entity describes a specific person and is used for identity purposes. Users are members of one or more groups. A group entity describes an organizational team or unit.

Users and groups have different descriptor requirements in their descriptor files:

- User descriptor files require `apiVersion`, `kind`, `metadata.name`, and `spec.memberOf`.
- Group descriptor files require `apiVersion`, `kind`, and `metadata.name`. They also require `spec.type` and `spec.children` where `spec.children` is another group.

To link a logged-in user to a user entity, include the optional `spec.profile.email` field.

Sample user entity:

```
apiVersion: backstage.io/v1alpha1
kind: User
metadata:
  name: default-user
spec:
  profile:
    displayName: Default User
    email: guest@example.com
    picture: https://avatars.dicebear.com/api/avataaars/guest@example.com.svg?background=%23fff
    memberOf: [default-team]
```

Sample group entity:

```
apiVersion: backstage.io/v1alpha1
kind: Group
metadata:
  name: default-team
  description: Default Team
spec:
  type: team
  profile:
    displayName: Default Team
    email: team-a@example.com
    picture: https://avatars.dicebear.com/api/identicon/team-a@example.com.svg?background=%23fff
  parent: default-org
  children: []
```

For more information about user entities and group entities, see the [Backstage documentation](#).

Systems

A system entity is a collection of resources and components.

System descriptor files require values for `apiVersion`, `kind`, `metadata.name`, and also `spec.owner` where `spec.owner` is a user or group.

A system has components when components specify the system name in the field `spec.system`.

Sample system entity:

```
apiVersion: backstage.io/v1alpha1
kind: System
metadata:
  name: backstage
  description: Tanzu Developer Portal System
spec:
  owner: default-team
```

For more information about system entities, see the [Backstage documentation](#).

Components

A component describes a software component, or what might be described as a unit of software.

Component descriptor files require values for `apiVersion`, `kind`, `metadata.name`, `spec.type`, `spec.lifecycle`, and `spec.owner`.

Some useful optional fields are `spec.system` and `spec.subcomponentOf`, both of which link a component to an entity that it is part of.

```
apiVersion: backstage.io/v1alpha1
kind: Component
metadata:
  name: backstage-component
  description: Tanzu Developer Portal Component
  annotations:
    'backstage.io/kubernetes-label-selector': 'app=backstage' #Identifies the Kubernetes objects that make up this component
    'backstage.io/techdocs-ref': dir:. #TechDocs label
spec:
  type: service
  lifecycle: alpha
  owner: default-team
  system: backstage
```

For more information about component entities, see the [Backstage documentation](#).

Update software catalogs

The following procedures describe how to update software catalogs.

Register components

To update your software catalog with new entities without re-deploying the entire `tap-gui` package:

1. Go to your **Software Catalog** page.
2. Click **Register Entity** at the top-right of the page.
3. Enter the full path to link to an existing entity file and start tracking your entity.
4. Import the entities and view them in your **Software Catalog** page.

Deregister components

To deregister an entity:

1. Go to your **Software Catalog** page.
2. Select the entity to deregister, such as component, group, or user.
3. Click the three dots at the top-right of the page and then click **Unregister...**

Add or change organization catalog locations

To add or change organization catalog locations, you can use static configuration or you can use [GitLabDiscoveryProcessor](#) to discover and register catalog entities that match the configured path.

Use static configuration

To use static configuration to add or change catalog locations:

1. Update components by changing the catalog location in either the `app_config` section of `tap-gui-values.yaml` or the custom values file you used when installing. For example:

```
tap_gui:
  app_config:
    catalog:
      locations:
        - type: url
          target: UPDATED-CATALOG-LOCATION
```

2. Register components by adding the new catalog location in either the `app_config` section of `tap-gui-values.yaml` or the custom values file you used when installing. For example:

```
tap_gui:
  app_config:
    catalog:
      locations:
        - type: url
          target: EXISTING-CATALOG-LOCATION
        - type: url
          target: EXTRA-CATALOG-LOCATION
```

When targeting GitHub, don't write the raw URL. Instead, use the URL that appears when you navigate to the file in the browser. The catalog processor cannot set up the files properly if you use the raw URL.

- Example raw URL:
`https://raw.githubusercontent.com/user/repo/catalog.yaml`
- Example target URL: `https://github.com/user/repo/blob/main/catalog.yaml`

When targeting GitLab, use a [scoped route](#) to the catalog file. This is a route with the `/-/` separator after the project name. If you don't use a scoped route, your entity fails to appear in the catalog.

- Example unscoped URL:
`https://gitlab.com/group/project/blob/main/catalog.yaml`
- Example target URL:
`https://gitlab.com/group/project/-/blob/main/catalog.yaml`

For more information about static catalog configuration, see the [Backstage documentation](#).

Use GitLabDiscoveryProcessor

To use `GitLabDiscoveryProcessor` to discover and register catalog entities:

1. Use `type: gitlab-discovery` to make `GitLabDiscoveryProcessor` crawl the GitLab instance to discover and register catalog entities that match the configured path. For more information, see the [Backstage documentation](#).
2. Update the package to include the catalog:

- o If you installed Tanzu Developer Portal by using a profile, run:

```
tanzu package installed update tap \
--package tap.tanzu.vmware.com \
--version PACKAGE-VERSION \
--values-file tap-values.yaml \
--namespace tap-install
```

- o If you installed Tanzu Developer Portal as an individual package, run:

```
tanzu package installed update tap-gui \
--package tap-gui.tanzu.vmware.com \
--version PACKAGE-VERSION \
--values-file tap-gui-values.yaml \
--namespace tap-install
```

3. Verify the status of this update by running:

```
tanzu package installed list -n tap-install
```

Install demo apps and their catalogs

To set up one of the demos, you can choose a blank catalog or a sample catalog.

Yelb system

The [Yelb](#) demo catalog in GitHub includes all the components that make up the Yelb system and the default Backstage components.

Install Yelb

To install Yelb:

1. Download the necessary file for running the Yelb application itself from [GitHub](#).
2. Install the application on the Kubernetes cluster that you used for Tanzu Application Platform. Preserve the metadata labels on the Yelb application objects.

Install the Yelb catalog

To install the Yelb catalog:

1. Download the **Tanzu Application Platform Developer Portal Yelb Catalog** catalog from the [Broadcom Support Portal](#).
2. Unpack the downloaded TAR archive to a local drive.
3. Follow the earlier steps for [Register components](#) to register the `catalog-info.yaml` in the root of the unpacked archive and register all the catalog entities that constitute the Yelb system.

View resources on multiple clusters in Tanzu Developer Portal

You can configure Tanzu Developer Portal (formerly called Tanzu Application Platform GUI) to retrieve Kubernetes object details from multiple clusters and then surface those details in the various Tanzu Application Platform GUI plug-ins.



Important

In this topic the terms **Build**, **Run**, and **View** describe the cluster's roles and distinguish which steps to apply to which cluster.

Build clusters are where the code is built and packaged, ready to be run.

Run clusters are where the Tanzu Application Platform workloads themselves run.

View clusters are where the Tanzu Developer Portal is run from.

In multicluster configurations, these can be separate clusters. However, in many configurations these can also be the same cluster.

Set up a Service Account to view resources on a cluster

To view resources on the **Build** or **Run** clusters, create a service account on the **View** cluster that can **get**, **watch**, and **list** resources on those clusters.

You first create a **ClusterRole** with these rules and a **ServiceAccount** in its own **Namespace**, and then bind the **ClusterRole** to the **ServiceAccount**. Depending on your topology, not every cluster has all of the following objects. For example, the **Build** cluster doesn't have any of the **servicing.knative.dev** objects, by design, because it doesn't run the workloads themselves. You can edit the following object lists to reflect your topology.

To set up a Service Account to view resources on a cluster:

1. Copy this YAML content into a file called `tap-gui-viewer-service-account-rbac.yaml`.

```
apiVersion: v1
kind: Namespace
metadata:
  name: tap-gui
---
apiVersion: v1
kind: ServiceAccount
metadata:
  namespace: tap-gui
  name: tap-gui-viewer
---
apiVersion: rbac.authorization.k8s.io/v1
kind: ClusterRoleBinding
metadata:
  name: tap-gui-read-k8s
subjects:
- kind: ServiceAccount
  namespace: tap-gui
  name: tap-gui-viewer
roleRef:
  kind: ClusterRole
  name: k8s-reader
  apiGroup: rbac.authorization.k8s.io
---
apiVersion: rbac.authorization.k8s.io/v1
```

```

kind: ClusterRole
metadata:
  name: k8s-reader
rules:
- apiGroups: ['']
  resources: ['pods', 'pods/log', 'services', 'configmaps', 'limitranges']
  verbs: ['get', 'watch', 'list']
- apiGroups: ['metrics.k8s.io']
  resources: ['pods']
  verbs: ['get', 'watch', 'list']
- apiGroups: ['apps']
  resources: ['deployments', 'replicasets', 'statefulsets', 'daemonsets']
  verbs: ['get', 'watch', 'list']
- apiGroups: ['autoscaling']
  resources: ['horizontalpodautoscalers']
  verbs: ['get', 'watch', 'list']
- apiGroups: ['networking.k8s.io']
  resources: ['ingresses']
  verbs: ['get', 'watch', 'list']
- apiGroups: ['networking.internal.knative.dev']
  resources: ['serverlessservices']
  verbs: ['get', 'watch', 'list']
- apiGroups: ['autoscaling.internal.knative.dev']
  resources: ['podautoscalers']
  verbs: ['get', 'watch', 'list']
- apiGroups: ['serving.knative.dev']
  resources:
  - configurations
  - revisions
  - routes
  - services
  verbs: ['get', 'watch', 'list']
- apiGroups: ['carto.run']
  resources:
  - clusterconfigtemplates
  - clusterdeliveries
  - clusterdeploymenttemplates
  - clusterimagetemplates
  - clusterruntemplates
  - clustersourcetemplates
  - clustersupplychains
  - clustertemplates
  - deliverables
  - runnables
  - workloads
  verbs: ['get', 'watch', 'list']
- apiGroups: ['source.toolkit.fluxcd.io']
  resources:
  - gitrepositories
  verbs: ['get', 'watch', 'list']
- apiGroups: ['source.apps.tanzu.vmware.com']
  resources:
  - imagerepositories
  - mavenartifacts
  verbs: ['get', 'watch', 'list']
- apiGroups: ['conventions.apps.tanzu.vmware.com']
  resources:
  - podintents
  verbs: ['get', 'watch', 'list']
- apiGroups: ['kpack.io']
  resources:
  - images
  - builds
  verbs: ['get', 'watch', 'list']
- apiGroups: ['scanning.apps.tanzu.vmware.com']
  resources:

```

```

- sourcescans
- imagescans
- scanpolicies
- scantemplates
verbs: ['get', 'watch', 'list']
- apiGroups: ['app-scanning.apps.tanzu.vmware.com']
resources:
- imagevulnerabilityscans
verbs: ['get', 'watch', 'list']
- apiGroups: ['tekton.dev']
resources:
- taskruns
- pipelineruns
verbs: ['get', 'watch', 'list']
- apiGroups: ['kappctrl.k14s.io']
resources:
- apps
verbs: ['get', 'watch', 'list']
- apiGroups: [ 'batch' ]
resources: [ 'jobs', 'cronjobs' ]
verbs: [ 'get', 'watch', 'list' ]
- apiGroups: ['conventions.carto.run']
resources:
- podintents
verbs: ['get', 'watch', 'list']
- apiGroups: ['appliveview.apps.tanzu.vmware.com']
resources:
- resourceinspectiongrants
verbs: ['get', 'watch', 'list', 'create']
- apiGroups: ['apiextensions.k8s.io']
resources: ['customresourcedefinitions']
verbs: ['get', 'watch', 'list']
- apiGroups: [data.packaging.carvel.dev]
resources: [packages]
verbs: ['get', 'watch', 'list']

```

This YAML content creates [Namespace](#), [ServiceAccount](#), [ClusterRole](#), and [ClusterRoleBinding](#).

2. On the [Build](#) and [Run](#) clusters, create [Namespace](#), [ServiceAccount](#), [ClusterRole](#), and [ClusterRoleBinding](#) by running:

```
kubectl create -f tap-gui-viewer-service-account-rbac.yaml
```

3. Again, on the [Build](#) and [Run](#) clusters, discover the [CLUSTER_URL](#) and [CLUSTER_TOKEN](#) values.

v1.23 or earlier Kubernetes cluster

If you're watching a v1.23 or earlier Kubernetes cluster, run:

```

CLUSTER_URL=$(kubectl config view --minify -o jsonpath='{.clusters[0].cluster.server}')

CLUSTER_TOKEN=$(kubectl -n tap-gui get secret $(kubectl -n tap-gui get sa tap-gui-viewer -o=json \
| jq -r '.secrets[0].name') -o=json \
| jq -r '.data["token"]' \
| base64 --decode)

echo CLUSTER_URL: $CLUSTER_URL
echo CLUSTER_TOKEN: $CLUSTER_TOKEN

```

v1.24 or later Kubernetes cluster

If you're watching a v1.24 or later Kubernetes cluster, run:

```

CLUSTER_URL=$(kubectl config view --minify -o jsonpath='{.clusters[0].cluster.server}')

kubectl apply -f - <<EOF
apiVersion: v1
kind: Secret
metadata:
  name: tap-gui-viewer
  namespace: tap-gui
  annotations:
    kubernetes.io/service-account.name: tap-gui-viewer
type: kubernetes.io/service-account-token
EOF

CLUSTER_TOKEN=$(kubectl -n tap-gui get secret tap-gui-viewer -o=json \
| jq -r '.data["token"]' \
| base64 --decode)

echo CLUSTER_URL: $CLUSTER_URL
echo CLUSTER_TOKEN: $CLUSTER_TOKEN

```



Note

You can create a short-lived token with the `kubectl create token` command if that is the preferred method. This method requires frequent token rotation.

- (Optional) Configure the Kubernetes client to verify the TLS certificates presented by a cluster's API server. To do this, discover `CLUSTER_CA_CERTIFICATES` by running:

```

CLUSTER_CA_CERTIFICATES=$(kubectl config view --raw -o jsonpath='{.clusters[?(@.name=="CLUSTER-NAME")].cluster.certificate-authority-data}')

echo CLUSTER_CA_CERTIFICATES: $CLUSTER_CA_CERTIFICATES

```

Where `CLUSTER-NAME` is your cluster name.

- Record the `Build` and `Run` clusters' `CLUSTER_URL` and `CLUSTER_TOKEN` values for when you [Update Tanzu Developer Portal to view resources on multiple clusters](#) later.

Update Tanzu Developer Portal to view resources on multiple clusters

The clusters must be identified to Tanzu Developer Portal with the `ServiceAccount` token and the cluster Kubernetes control plane URL.

You must add a `kubernetes` section to the `app_config` section in the `tap-values.yaml` file that Tanzu Application Platform used when you installed it. This section must have an entry for each `Build` and `Run` cluster that has resources to view.

To do so:

- Copy this YAML content into `tap-values.yaml`:

```

tap_gui:
  ## Previous configuration above
  app_config:
    kubernetes:
      serviceLocatorMethod:
        type: 'multiTenant'

```

```

clusterLocatorMethods:
  - type: 'config'
    clusters:
      ## Cluster 1
      - url: CLUSTER-URL
        name: CLUSTER-NAME
        authProvider: serviceAccount
        serviceAccountToken: "CLUSTER-TOKEN"
        skipTLSVerify: true
        skipMetricsLookup: true
      ## Cluster 2+
      - url: CLUSTER-URL
        name: CLUSTER-NAME
        authProvider: serviceAccount
        serviceAccountToken: "CLUSTER-TOKEN"
        skipTLSVerify: true
        skipMetricsLookup: true

```

Where:

- `CLUSTER-URL` is the value you discovered earlier.
- `CLUSTER-TOKEN` is the value you discovered earlier.
- `CLUSTER-NAME` is a unique name of your choice.

If there are resources to view on the `view` cluster that hosts Tanzu Developer Portal, add an entry to `clusters` for it as well.

If you would like the Kubernetes client to verify the TLS certificates presented by a cluster's API server, set the following properties for the cluster:

```

skipTLSVerify: false
caData: CLUSTER-CA-CERTIFICATES

```

Where `CLUSTER-CA-CERTIFICATES` is the value you discovered earlier.

2. Update the `tap` package by running this command:

```
tanzu package installed update tap -n tap-install --values-file tap-values.yaml
```

3. Wait a moment for the `tap` and `tap-gui` packages to update and then verify that `STATUS` is `Reconcile succeeded` by running:

```
tanzu package installed get all -n tap-install
```

View resources on multiple clusters in the Runtime Resources Visibility plug-in

To view resources on multiple clusters in the Runtime Resources Visibility plug-in:

1. Go to the Runtime Resources Visibility plug-in for a component that is running on multiple clusters.
2. View the multiple resources and their statuses across the clusters.

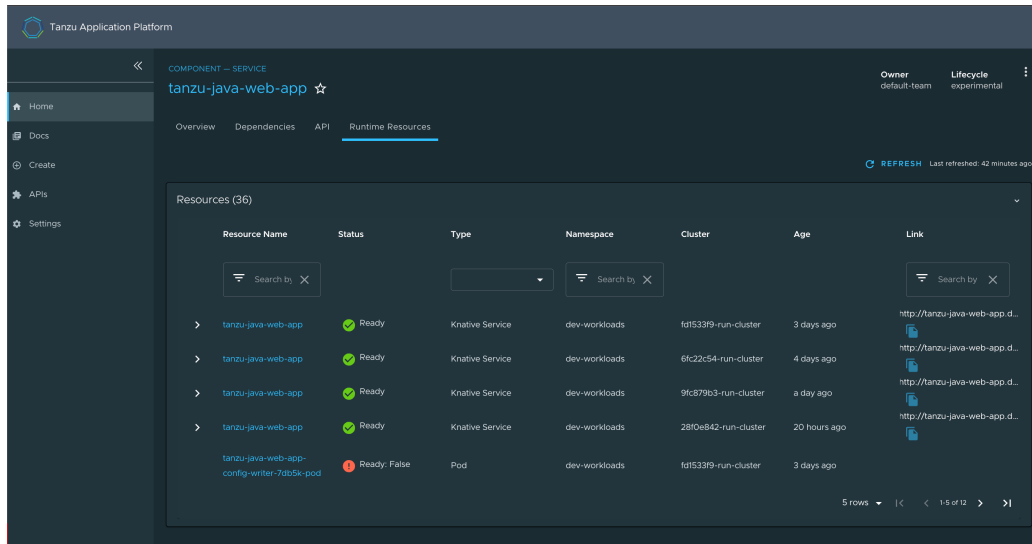

Set up authentication for Tanzu Developer Portal

Tanzu Developer Portal (formerly called Tanzu Application Platform GUI) extends the current Backstage authentication plug-in so that you can see a login page based on the authentication providers configured at installation. This feature is a work in progress.

Tanzu Developer Portal currently supports the following authentication providers:

- [Auth0](#)
- [Azure](#)
- [Bitbucket](#)
- [GitHub](#)
- [GitLab](#)
- [Google](#)
- [Okta](#)
- [OneLogin](#)

You can also configure a custom OpenID Connect (OIDC) provider.

View your Backstage Identity

A Backstage identity is defined as a combination of:

- The user reference: each entity in the catalog is uniquely identified by the triplet of its [kind](#)
- A [namespace](#)
- A [name](#)

For example, the user Jane can be assigned to the user entity `user:default/jane` and an ownership reference, which is used to determine what that user owns. Jane (`user:default/jane`) might have the ownership references `user:default/jane`, `group:default/team-a`, and `group:default/admins`. This would mean that Jane belongs to those groups and, therefore, owns those references.

To view your current Backstage identity, in the **Settings** section of the left side navigation pane click the **General** tab.

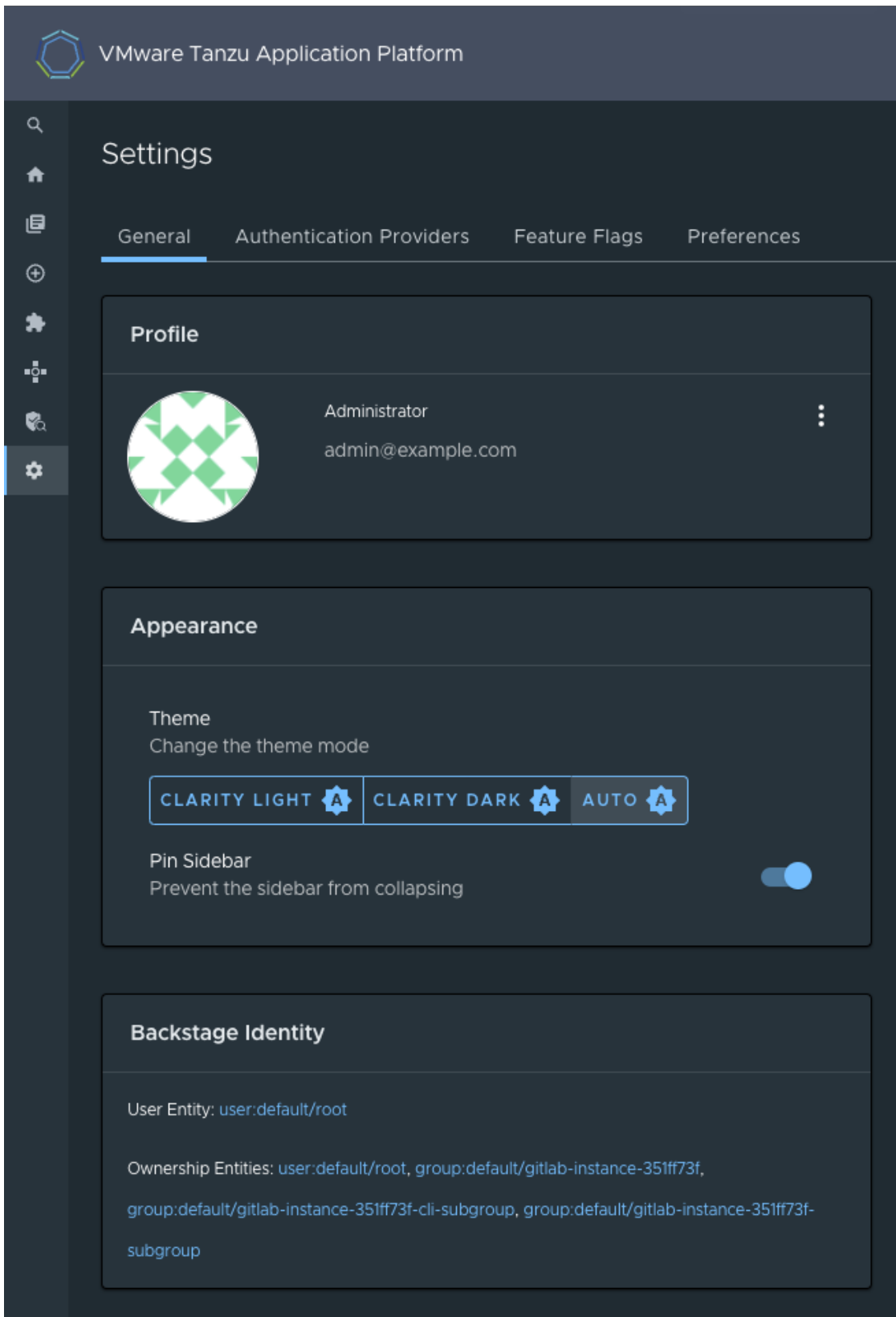

Configure an authentication provider

Configure a supported authentication provider or a custom OIDC provider:

- To configure a supported authentication provider, see the [Backstage authentication documentation](#).

- To configure a custom OIDC provider, edit your `tap-values.yaml` file or your custom configuration file to include an OIDC authentication provider. Configure the OIDC provider with your OAuth App values. For example:

```
shared:
  ingress_domain: "INGRESS-DOMAIN"

# ... any existing values

tap_gui:
  # ... any other Tanzu Developer Portal values
  app_config:
    auth:
      environment: development
      session:
        secret: custom session secret
      providers:
        oidc:
          development:
            metadataUrl: AUTH-OIDC-METADATA-URL
            clientId: AUTH-OIDC-CLIENT-ID
            clientSecret: AUTH-OIDC-CLIENT-SECRET
            tokenSignedResponseAlg: AUTH-OIDC-TOKEN-SIGNED-RESPONSE-ALG # default='RS256'
            scope: AUTH-OIDC-SCOPE # default='openid profile email'
            prompt: auto # default=none (allowed values: auto, none, consent, login)
```

Where `AUTH-OIDC-METADATA-URL` is a JSON file with generic OIDC provider configuration. It contains `authorizationUrl` and `tokenUrl`. Tanzu Developer Portal reads these values from `metadataUrl`, so you must not specify these values explicitly in the earlier authentication configuration.

You must also provide the redirect URI of the Tanzu Developer Portal instance to your identity provider. The redirect URI is sometimes called the redirect URL, the callback URL, or the callback URI. The redirect URI takes the following form:

```
SCHEME://tap-gui.INGRESS-DOMAIN/api/auth/oidc/handler/frame
```

Where:

- `SCHEME` is the URI scheme, most commonly `http` or `https`
- `INGRESS-DOMAIN` is the host name you selected for your Tanzu Developer Portal instance

When using `https` and `example.com` as examples for the two placeholders respectively, the redirect URI reads as follows:

```
https://tap-gui.example.com/api/auth/oidc/handler/frame
```

For more information, see [this example](#) in GitHub.

- (Optional) Configure offline access scope for the OIDC provider by adding the `scope` parameter `offline_access` to either `tap-values.yaml` or your custom configuration file. For example:

```
auth:
  providers:
    oidc:
      development:
```



```
... # auth configs
scope: 'openid profile email offline_access'
```

By default, `scope` is not configured to provide persistence to user login sessions, such as in the case of a page refresh. Not all identity providers support the `offline_access` scope. For more information, see your identity provider documentation.

(Optional) Allow guest access

Enable guest access with other providers by adding the following flag under your authentication configuration:

```
auth:
  allowGuestAccess: true
```

(Optional) Customize the login page

Change the card's title or description for a specific provider with the following configuration:

```
auth:
  environment: development
  providers:
    ... # auth providers config
  loginPage:
    github:
      title: Github Login
      message: Enter with your GitHub account
```

For a provider to appear on the login page, ensure that it is properly configured under the `auth.providers` section of your values file.

View resources on remote clusters

You can control the access to Kubernetes runtime resources on Tanzu Developer Portal (formerly called Tanzu Application Platform GUI) based on user roles and permissions for each of the visible remote clusters.



Caution

Setting up role-based access control (RBAC) might impact the user's ability to view workloads in the Security Analysis GUI and the Workloads table of the Supply Chain Choreographer plug-in GUI.

RBAC is currently supported for the following Kubernetes cluster providers:

- [EKS](#) (Elastic Kubernetes Service) on AWS
- [GKE](#) (Google Kubernetes Engine) on GCP

Support for other Kubernetes providers is planned for future releases of Tanzu Application Platform.

Tanzu Developer Portal is designed under the assumption that the roles and permissions for the Kubernetes clusters are already defined and that the users are already assigned to their roles. For information about assigning roles and permissions to users, see [Assigning roles and permissions on Kubernetes clusters](#).

Adding access-controlled visibility for a remote cluster is similar to [Setting up unrestricted remote cluster visibility](#).

The steps are:

1. Set up the OIDC provider
2. Configure the Kubernetes cluster with the OIDC provider
3. Configure the Tanzu Developer Portal to view the remote cluster
4. Upgrade the Tanzu Developer Portal package

After following these steps, you can view your runtime resources on a remote cluster in Tanzu Developer Portal. For more information, see [View runtime resources on remote clusters](#).

Set up the permission framework for your Tanzu Developer Portal

This topic gives you an overview of the Backstage permission framework and tells you how to enable it for Tanzu Developer Portal (formerly called Tanzu Application Platform GUI). For more information, see the [Backstage documentation](#).



Caution

The permission framework functions are in alpha. It is not recommended for use in production environment.

Overview of the permission framework

The permission framework enables Tanzu Application Platform operators to enforce policies that limit visibility of certain parts of Tanzu Developer Portal.

The current release features the alpha version of this function and only applies to the Software Catalog entities. `owner-of` is the only policy available and it is embedded in the GUI.

`owner-of` enables the operator to define which admin groups and users have unrestricted visibility of the Software Catalog entities. If a user is not listed as an admin or part of the admin group, that user can see only the Software Catalog entities that are owned by their teams.



Important

The permission framework is deactivated by default. The built-in `owner-of` policy is primarily applied to the component entities of the software catalog. Accelerators (templates) in Application Accelerator become invisible if the permission framework is enabled.

Enable the permission framework

To enable the permission framework and limit Software Catalog entities' visibility to owners, allowlist users, allowlist groups, and catalog admins, add the following parameters to the `tap_gui.app_config` section:

```
permission:
  enabled: true
  adminRefs:
    - user:NAMESPACE/NAME
    - group:NAMESPACE/NAME
```

Where:

- `NAMESPACE` is usually `default` unless defined otherwise in the definition file
- `NAME` is the name of the group or user

The `adminRefs` section lists all users and groups to grant access to. Each user and group is defined by the `NAMESPACE` and the `NAME`.

You can view your user entity in the `Settings/General` section in your Tanzu Application Platform GUI, or in the YAML definition file of the user or group.

For example:

```
- user:default/admin
- group:test-namespace/operators
```

After you have updated your configuration file, reinstall your Tanzu Developer Portal package by following the steps in [Upgrade Tanzu Application Platform](#).

After the updated values configuration file is applied in Tanzu Developer Portal, the permission framework is enabled.



Important

After the permission framework is enabled, all Software Catalog entities without proper annotations are invisible to all users except admins.

Enable catalog entity visibility

With the permission framework enabled, annotate entities in your Software Catalog to make the relevant users or groups, who are not the owner of the entity, visible. To do this, add annotations to the `metadata.annotations` section of the entity's definition file:

```
metadata:
  annotations:
    backstage.tanzu.vmware.com/GROUP-OR-USER.NAMESPACE.NAME: 'COMMA-SEPARATED-PERMISSIONS'
```

Where:

- `GROUP-OR-USER` is either a `group` to describe a group or a `user` to describe an individual user
- `NAMESPACE` is the namespace that the group or user is attributed to. If this value is not specified, it is `default`.
- `NAME` is the name of the user or group
- `COMMA-SEPARATED-PERMISSIONS` is the list of comma-delimited permissions for the specified user or group. Valid catalog entity permissions include:
 - `catalog.entity.read`
 - `catalog.entity.update`
 - `catalog.entity.delete`



Note

`catalog.entity.create` is another permission that is valid for the permission framework, but it is not meaningful for the Software Catalog entities that have already been created.

You can add several groups or users by adding new annotations with their respective comma-delimited permissions, for example:

```
metadata:
  annotations:
    backstage.tanzu.vmware.com/user.default.user-a: 'catalog.entities.read'
    backstage.tanzu.vmware.com/user.default.user-b: 'catalog.entities.read,catalog.entities.update'
```

For example, this annotation enables users that are part of `group-a` to read and delete `component-a`:

```
apiVersion: backstage.io/v1alpha1
kind: Component
metadata:
  name: component-a
  annotations:
    backstage.tanzu.vmware.com/group.test-namespace.group-a: 'catalog.entity.read, catalog.entity.delete'
```

If a group is granted ownership or access to an entity, all users within that group automatically inherit the same access. But it does not work for nested group ownerships, when a group is listed as a member of another group.



Caution

When the permission plug-in is turned on with the default permission policy, API Auto Registration no longer works due to the lack of user identities. Requests against the Catalog API will no longer work as before. For more information, see the [known issues in the release notes](#).

View resources on remote clusters

You can control the access to Kubernetes runtime resources on Tanzu Developer Portal (formerly called Tanzu Application Platform GUI) based on user roles and permissions for each of the visible remote clusters.



Caution

Setting up role-based access control (RBAC) might impact the user's ability to view workloads in the Security Analysis GUI and the Workloads table of the Supply Chain Choreographer plug-in GUI.

RBAC is currently supported for the following Kubernetes cluster providers:

- [EKS](#) (Elastic Kubernetes Service) on AWS
- [GKE](#) (Google Kubernetes Engine) on GCP

Support for other Kubernetes providers is planned for future releases of Tanzu Application Platform.

Tanzu Developer Portal is designed under the assumption that the roles and permissions for the Kubernetes clusters are already defined and that the users are already assigned to their roles. For

information about assigning roles and permissions to users, see [Assigning roles and permissions on Kubernetes clusters](#).

Adding access-controlled visibility for a remote cluster is similar to [Setting up unrestricted remote cluster visibility](#).

The steps are:

1. Set up the OIDC provider
2. Configure the Kubernetes cluster with the OIDC provider
3. Configure the Tanzu Developer Portal to view the remote cluster
4. Upgrade the Tanzu Developer Portal package

After following these steps, you can view your runtime resources on a remote cluster in Tanzu Developer Portal. For more information, see [View runtime resources on remote clusters](#).

View resources on remote EKS clusters

This topic tells you how to view your runtime resources on a remote EKS cluster in Tanzu Developer Portal (formerly called Tanzu Application Platform GUI). For more information, see [View runtime resources on remote clusters](#).

Set up the OIDC provider

You must set up the OIDC provider to enable RBAC visibility of remote EKS clusters. You can see the list of supported OIDC providers in [Setting up a Tanzu Developer Portal authentication provider](#).

Tanzu Developer Portal supports multiple OIDC providers. Auth0 is used here as an example.

1. Log in to the Auth0 dashboard.
2. Go to **Applications**.
3. Create an application of the type `Single Page Web Application` named `TAP-GUI` or a name of your choice.
4. Click the **Settings** tab.
5. Under **Application URIs > Allowed Callback URLs**, add

```
https://tap-gui.INGRESS-DOMAIN/api/auth/auth0/handler/frame
```

Where `INGRESS-DOMAIN` is the domain you chose for your Tanzu Developer Portal in [Installing the Tanzu Application Platform package and profiles](#).

6. Click **Save Changes**.

After creating an application with your OIDC provider, you receive the following credentials for setting up RBAC for your remote cluster:

- **Domain**, which is used as `ISSUER-URL` in the following sections (`AUTH0_DOMAIN` for Auth0)
- **Client ID**, which is used as `CLIENT-ID` in the following sections
- **Client Secret**, which is used as `CLIENT-SECRET` in the following sections

For more information, see [Auth0 Setup Walkthrough](#) in the Backstage documentation. To configure other OIDC providers, see [Authentication in Backstage](#) in the Backstage documentation.

Configure the Kubernetes cluster with the OIDC provider

To configure the cluster with the OIDC provider's credentials:

1. Create a file with the following content and name it `rbac-setup.yaml`. This content applies to EKS clusters.

```
apiVersion: eksctl.io/v1alpha5
kind: ClusterConfig
metadata:
  name: "CLUSTER-NAME"
  region: "AWS-REGION"
identityProviders:
  - name: auth0
    type: oidc
    issuerUrl: "ISSUER-URL"
    clientId: "CLIENT-ID"
    usernameClaim: email
```

Where:

- `CLUSTER-NAME` is the cluster name for your EKS cluster as an AWS identifier
- `AWS-REGION` is the AWS region of the EKS cluster
- `CLIENT-ID` is the Client ID you obtained while setting up the OIDC provider
- `ISSUER-URL` is the Issuer URL you obtained while setting up the OIDC provider. For Auth0, this is `https://${AUTH0_DOMAIN}/`.

2. Using `eksctl`, run:

```
eksctl associate identityprovider -f rbac-setup.yaml
```

3. Verify that the association of the OIDC provider with the EKS cluster was successful by running:

```
eksctl get identityprovider --cluster CLUSTER-NAME
```

Where `CLUSTER-NAME` is the cluster name for your EKS cluster as an AWS identifier

Verify that the output shows `ACTIVE` in the `STATUS` column.

Configure the Tanzu Developer Portal

Configure visibility of the remote cluster in Tanzu Developer Portal:

1. Obtain your cluster's URL by running:

```
CLUSTER_URL=$(kubectl config view --minify -o jsonpath='{.clusters[0].cluster.server}')
echo CLUSTER-URL: $CLUSTER_URL
```

This command returns the URL of the first configured cluster in your `kubeconfig` file. To view other clusters one by one, edit the number in `.clusters[0].cluster.server` or edit the command to view all the configured clusters.

2. Ensure you have an `auth` section in the `app_config` section that Tanzu Developer Portal uses. In the example for Auth0, copy this YAML content into `tap-values.yaml`:

```
auth:
  environment: development
  providers:
    auth0:
```

```
development:
  clientId: "CLIENT-ID"
  clientSecret: "CLIENT-SECRET"
  domain: "ISSUER-URL"
```

Where:

- `CLIENT-ID` is the Client ID you obtained while setting up the OIDC provider.
- `CLIENT-SECRET` is the Client Secret you obtained while setting up the OIDC provider.
- `ISSUER-URL` is the Issuer URL you obtained while setting up the OIDC provider. For Auth0, it is only `AUTH0_DOMAIN`.

3. Add a `kubernetes` section to the `app_config` section that Tanzu Developer Portal uses. This section must have an entry for each cluster that has resources to view. To do so, copy this YAML content into `tap-values.yaml`:

```
kubernetes:
  serviceLocatorMethod:
    type: 'multiTenant'
  clusterLocatorMethods:
    - type: 'config'
      clusters:
        - name: "CLUSTER-NAME-UNCONSTRAINED"
          url: "CLUSTER-URL"
          authProvider: oidc
          oidcTokenProvider: auth0
          skipTLSVerify: true
          skipMetricsLookup: true
```

Where:

- `CLUSTER-NAME-UNCONSTRAINED` is the cluster name of your choice for your EKS cluster
- `CLUSTER-URL` is the URL for the remote cluster you are connecting to Tanzu Developer Portal. You obtained this earlier in the procedure.

If there are any other clusters that you want to make visible in Tanzu Developer Portal, add their entries to `clusters` as well.

Upgrade the Tanzu Developer Portal package

After the new configuration file is ready, update the `tap` package:

1. Run:

```
tanzu package installed update tap --values-file tap-values.yaml
```

2. Wait a moment for the `tap-gui` package to update and then verify that `STATUS` is `Reconcile succeeded` by running:

```
tanzu package installed get tap-gui -n tap-install
```

View resources on remote GKE clusters

This topic tells you about two supported options to add access-controlled visibility for a remote GKE cluster:

- [Leverage an external OIDC provider](#)
- [Leveraging Google's OIDC provider](#)

After the authorization is enabled, you can view your runtime resources on a remote cluster in Tanzu Developer Portal (formerly named Tanzu Application Platform GUI). For more information, see [View runtime resources on remote clusters](#).

Leverage an external OIDC provider

To leverage an external OIDC provider, such as Auth0:

1. Set up the OIDC provider
2. Configure the GKE cluster with the OIDC provider
3. Configure the Tanzu Developer Portal to view the remote GKE cluster
4. Update the `tap-gui` package

Set up the OIDC provider

You must set up the OIDC provider to enable RBAC visibility of remote clusters. You can see the list of supported OIDC providers in [Setting up a Tanzu Developer Portal authentication provider](#).

Tanzu Developer Portal supports multiple OIDC providers. Auth0 is used here as an example.

1. Log in to the Auth0 dashboard.
2. Go to **Applications**.
3. Create an application of the type `Single Page Web Application` named `TAP-GUI` or a name of your choice.
4. Click the **Settings** tab.
5. Under **Application URIs > Allowed Callback URLs**, add

```
https://tap-gui.INGRESS-DOMAIN/api/auth/auth0/handler/frame
```

Where `INGRESS-DOMAIN` is the domain you chose for your Tanzu Developer Portal in [Installing the Tanzu Application Platform package and profiles](#).

6. Click **Save Changes**.

After creating an application with your OIDC provider, you receive the following credentials for setting up RBAC for your remote cluster:

- **Domain**, which is used as `issuerURL` in the following sections
- **Client ID**, which is used as `CLIENT-ID` in the following sections
- **Client Secret**, which is used as `CLIENT-SECRET` in the following sections

For more information, see [Auth0 Setup Walkthrough](#) in the Backstage documentation. To configure other OIDC providers, see [Authentication in Backstage](#) in the Backstage documentation.

Configure the GKE cluster with the OIDC provider

Add redirect configuration on the OIDC side by following the [Google Cloud documentation](#).

Configure visibility of the remote cluster

Configure visibility of the remote cluster in Tanzu Developer Portal:

1. Obtain your cluster's URL by running:

```
CLUSTER_URL=$(kubectl config view --minify -o jsonpath='{.clusters[0].cluster.server}')

```



```
echo CLUSTER-URL: $CLUSTER_URL
```

This command returns the URL of the first configured cluster in your `kubeconfig` file. To view other clusters one by one, edit the number in `.clusters[0].cluster.server` or edit the command to view all the configured clusters.

2. Ensure you have an `auth` section in the `app_config` section that Tanzu Developer Portal uses. In the example for Auth0, copy this YAML content into `tap-values.yaml`:

```
auth:
  environment: development
  providers:
    auth0:
      development:
        clientId: "CLIENT-ID"
        clientSecret: "CLIENT-SECRET"
        domain: "ISSUER-URL"
```

Where:

- `CLIENT-ID` is the Client ID you obtained while setting up the OIDC provider
 - `CLIENT-SECRET` is the Client Secret you obtained while setting up the OIDC provider
 - `ISSUER-URL` is the Issuer URL you obtained while setting up the OIDC provider
3. Add a `kubernetes` section to the `app_config` section that Tanzu Developer Portal uses. This section must have an entry for each cluster that has resources to view. To do so, copy this YAML content into `tap-values.yaml`:

```
kubernetes:
  serviceLocatorMethod:
    type: 'multiTenant'
  clusterLocatorMethods:
    - type: 'config'
      clusters:
        - name: "CLUSTER-NAME-UNCONSTRAINED"
          url: "CLUSTER-URL"
          authProvider: oidc
          oidcTokenProvider: auth0
          skipTLSVerify: true
          skipMetricsLookup: true
```

Where:

- `CLUSTER-NAME-UNCONSTRAINED` is the cluster name of your choice for your GKE cluster
- `CLUSTER-URL` is the URL for the remote cluster you are connecting to Tanzu Developer Portal. You obtained this earlier in the procedure.

If there are any other clusters that you want to make visible in Tanzu Developer Portal, add their entries to `clusters` as well.

Update the `tap-gui` package to finish leveraging the external OIDC provider

After the new configuration file is ready, update the `tap-gui` package:

1. Run:

```
tanzu package installed update tap --values-file tap-values.yaml
```

2. Wait a moment for the `tap-gui` package to update and then verify that `STATUS` is `Reconcile succeeded` by running:

```
tanzu package installed get tap-gui -n tap-install
```

Leverage Google's OIDC provider

When leveraging Google's OIDC provider, fewer steps are needed to enable authorization:

1. Add redirect configuration on the OIDC side.
2. Configure the Tanzu Developer Portal to view the remote GKE cluster
3. Upgrade the Tanzu Developer Portal package

Add redirect configuration on the OIDC side

Add redirect configuration on the OIDC side by following the [Google Cloud documentation](#).

Configure visibility of the remote GKE cluster

Configure visibility of the remote GKE cluster in Tanzu Developer Portal:

1. Obtain your cluster's URL by running:

```
CLUSTER_URL=$(kubectl config view --minify -o jsonpath='{.clusters[0].cluster.server}')

echo CLUSTER-URL: $CLUSTER_URL
```

This command returns the URL of the first configured cluster in your `kubeconfig` file. To view other clusters one by one, edit the number in `.clusters[0].cluster.server` or edit the command to view all the configured clusters.

2. Ensure you have an `auth` section in the `app_config` section that Tanzu Developer Portal uses. In the example for Auth0, copy this YAML content into `tap-values.yaml`:

```
auth:
  environment: development
  providers:
    google:
      development:
        clientId: "CLIENT-ID"
        clientSecret: "CLIENT-SECRET"
```

Where:

- `CLIENT-ID` is the Client ID you obtained while setting up the OIDC provider
 - `CLIENT-SECRET` is the Client Secret you obtained while setting up the OIDC provider
3. Add a `kubernetes` section to the `app_config` section that Tanzu Developer Portal uses. This section must have an entry for each cluster that has resources to view. To do so, copy this YAML content into `tap-values.yaml`:

```
kubernetes:
  clusterLocatorMethods:
    - type: 'config'
  clusters:
    - name: "CLUSTER-NAME-UNCONSTRAINED"
      url: "CLUSTER-URL"
```

```
authProvider: google
caData: "CA-DATA"
```

Where:

- o `CLUSTER-NAME-UNCONSTRAINED` is the cluster name of your choice for your GKE cluster.
- o `CLUSTER-URL` is the URL for the remote cluster you are connecting to Tanzu Developer Portal. You obtained this earlier in the procedure.
- o `CA-DATA` is the CA certificate data.

If there are any other clusters that you want to make visible in Tanzu Developer Portal, add their entries to `clusters` as well.

Update the `tap-gui` package to finish leveraging the Google OIDC provider

After the new configuration file is ready, update the `tap-gui` package:

1. Run:

```
tanzu package installed update tap --values-file tap-values.yaml
```

2. Wait a moment for the `tap-gui` package to update and then verify that `STATUS` is `Reconcile succeeded` by running:

```
tanzu package installed get tap-gui -n tap-install
```

View runtime resources on authorization-enabled clusters

To visualize runtime resources on authorization-enabled clusters in Tanzu Developer Portal (formerly called Tanzu Application Platform GUI), proceed to the software catalog component of choice and click the **Runtime Resources** tab on top of the ribbon.

The screenshot shows the Tanzu Developer Portal interface for the 'tanzu-java-web-app' component. The 'Runtime Resources' tab is active, displaying a table of 36 resources. The table has columns for Resource Name, Status, Type, Namespace, Cluster, Age, and Link. The resources are listed as follows:

Resource Name	Status	Type	Namespace	Cluster	Age	Link
tanzu-java-web-app	Ready	Knative Service	dev-workloads	fd1533f9-run-cluster	3 days ago	http://tanzu-java-web-app.d...
tanzu-java-web-app	Ready	Knative Service	dev-workloads	6fc22c54-run-cluster	4 days ago	http://tanzu-java-web-app.d...
tanzu-java-web-app	Ready	Knative Service	dev-workloads	9fc879b3-run-cluster	a day ago	http://tanzu-java-web-app.d...
tanzu-java-web-app	Ready	Knative Service	dev-workloads	28f0e842-run-cluster	20 hours ago	http://tanzu-java-web-app.d...
tanzu-java-web-app-config-writer-7db5k-pod	Ready: False	Pod	dev-workloads	fd1533f9-run-cluster	3 days ago	

After you click **Runtime Resources**, Tanzu Developer Portal uses your credentials to query the clusters for the respective runtime resources. The system verifies that you are authenticated with the OIDC providers configured for the remote clusters. If you are not authenticated, the system prompts you for your OIDC credentials.

Remote clusters that are not restricted by authorization are visible by using the general Service Account of Tanzu Developer Portal. It is not restricted for users. For more information about how to set up unrestricted remote cluster visibility, see [Viewing resources on multiple clusters in Tanzu Developer Portal](#).

The type of query to the remote cluster depends on the definition of the software catalog component. In Tanzu Developer Portal, there are globally-scoped components and namespace-scoped components.

This property of the component affects runtime resource visibility, depending on your permissions on a specific cluster.

If your permissions on the authorization-enabled cluster are limited to specific namespaces, you do not have visibility into runtime resources of globally-scoped components.

You need cluster-scoped access to have visibility into runtime resources of globally-scoped components.

Globally-scoped components

For globally-scoped components, when you access **Runtime Resources** Tanzu Developer Portal queries all Kubernetes namespaces for runtime resources that have a matching `kubernetes-label-selector`, usually with a `part-of` prefix.

For example, `demo-component-a` does not have a `backstage.io/kubernetes-namespace` in the `metadata.annotations` section. This makes it a globally-scoped component. See the following example YAML.

```
apiVersion: backstage.io/v1alpha1
kind: Component
metadata:
  name: demo-component-a
  description: Demo Component A
  tags:
    - java
  annotations:
    'backstage.io/kubernetes-label-selector': 'app.kubernetes.io/part-of=component-a'
spec:
  type: service
  lifecycle: experimental
  owner: team-a
```

Namespace-scoped components

If a component is namespace-scoped, when you access **Runtime Resources** Tanzu Developer Portal queries only the associated Kubernetes namespace for each remote cluster that is visible to Tanzu Developer Portal.

To make a component namespace-scoped, pass the following annotation to the definition YAML file of the component:

```
annotations:
  'backstage.io/kubernetes-namespace': NAMESPACE-NAME
```

Where `NAMESPACE-NAME` is the Kubernetes namespace you want to associate your component with.

For example, `demo-component-b` has a `kubernetes-namespace` in the `metadata.annotations` section, which associates it with the `component-b` namespaces on each of the visible clusters. This makes it a namespace-scoped component. See the following example YAML.

```

apiVersion: backstage.io/v1alpha1
kind: Component
metadata:
  name: demo-component-b
  description: Demo Component B
  tags:
    - java
  annotations:
    'backstage.io/kubernetes-label-selector': 'app.kubernetes.io/part-of=component-b'
    'backstage.io/kubernetes-namespace': component-b
spec:
  type: service
  lifecycle: experimental
  owner: team-b

```

When the `kubernetes-namespace` annotation is absent, the component is considered globally-scoped by default. For more information, see [Adding Namespace Annotation](#) in the Backstage documentation.

Assign roles and permissions on Kubernetes clusters

This topic gives you an overview of creating roles and permissions on Kubernetes clusters and assigning these roles to users. For more information, see [Using RBAC Authorization](#) in the Kubernetes documentation.

The steps to define and assign roles are:

1. [Create roles](#)
2. [Create users](#)
3. [Assign users to their roles](#)

Create roles

To control the access to Kubernetes runtime resources on Tanzu Developer Portal (formerly named Tanzu Application Platform GUI) based on users' roles and permissions for each of visible remote clusters, VMware recommends two role types:

- [Cluster-scoped roles](#)
- [Namespace-scoped roles](#)

Cluster-scoped roles

Cluster-scoped roles provide cluster-wide privileges. They enable visibility into runtime resources across all of a cluster's namespaces.

In this example YAML snippet, the `pod-viewer` role enables pod visibility on the cluster:

```

apiVersion: rbac.authorization.k8s.io/v1
kind: ClusterRole
metadata:
  name: pod-viewer
rules:
- apiGroups: [""]
  resources: ["pods"]
  verbs: ["get", "watch", "list"]

```

Namespace-scoped roles

Namespace-scoped roles provide privileges that are limited to a certain namespace. They enable visibility into runtime resources inside namespaces.

In this example YAML snippet, the `pod-viewer-app1` role enables pod visibility in the `app1` namespace:

```
apiVersion: rbac.authorization.k8s.io/v1
kind: Role
metadata:
  namespace: app1
  name: pod-viewer-app1
rules:
- apiGroups: [""]
  resources: ["pods"]
  verbs: ["get", "list"]
```

Create users

You can create users by running the `kubectl create` command. In this example YAML snippet, the user `john` is defined:

```
apiVersion: rbac.authorization.k8s.io/v1
kind: User
metadata:
  namespace: default
  name: john
```

Assign users to their roles

After the users and role are created, the next step is to bind them together.

To bind a Tanzu Application Platform default role, see [Bind a user or group to a default role](#).

In this example YAML snippet, the user `john` is bound with the `pod-viewer` cluster role:

```
apiVersion: rbac.authorization.k8s.io/v1
kind: RoleBinding
metadata:
  name: john-pod-viewer
  namespace: default
subjects:
- kind: User
  name: john
  apiGroup: rbac.authorization.k8s.io
roleRef:
  kind: ClusterRole
  name: pod-viewer
  apiGroup: rbac.authorization.k8s.io
```

In this example YAML snippet, the user `john` is bound with the `pod-viewer-app1` namespace-specific role:

```
apiVersion: rbac.authorization.k8s.io/v1
kind: RoleBinding
metadata:
  name: john-pod-viewer-app1
  namespace: app1
subjects:
- kind: User
  name: john
  apiGroup: rbac.authorization.k8s.io
```

```
roleRef:
  kind: Role
  name: pod-viewer-app1
  apiGroup: rbac.authorization.k8s.io
```

To verify the user's permissions, run the `can-i` commands to get a `yes` or `no` answer. To verify that you can list pods in your cluster-wide role, run:

```
kubectl auth can-i get pods --all-namespaces
```

To verify that you can list pods in namespace `app1` in your namespace-specific role, run:

```
kubectl auth can-i get pods --namespace app1
```

Add Tanzu Developer Portal integrations

You can integrate Tanzu Developer Portal (formerly called Tanzu Application Platform GUI) with several Git providers. To use an integration, you must enable it and provide the necessary token or credentials in `tap-values.yaml`.

Add a GitHub provider integration

To add a GitHub provider integration, edit `tap-values.yaml` as in this example:

```
app_config:
  app:
    baseUrl: http://EXTERNAL-IP:7000
    # Existing tap-values.yaml above
  integrations:
    github: # Other integrations available see NOTE below
      - host: github.com
        token: GITHUB-TOKEN
```

Where:

- `EXTERNAL-IP` is the external IP address.
- `GITHUB-TOKEN` is a valid token generated from your Git infrastructure of choice. Ensure that `GITHUB-TOKEN` has the necessary read permissions for the catalog definition files you extracted from the blank software catalog introduced in the [Tanzu Developer Portal prerequisites](#).

Add a Git-based provider integration that isn't GitHub

To enable Tanzu Developer Portal to read Git-based non-GitHub repositories containing component information:

1. Add the following YAML to `tap-values.yaml`:

```
app_config:
  # Existing tap-values.yaml above
  backend:
    reading:
      allow:
        - host: "GIT-CATALOG-URL-1"
        - host: "GIT-CATALOG-URL-2" # Including more than one URL is optional
```

Where `GIT-CATALOG-URL-1` and `GIT-CATALOG-URL-2` are URLs in a list of URLs that Tanzu Developer Portal can read when registering new components. For example,

[git.example.com](#). For more information about registering new components, see [Adding catalog entities](#).

2. Adding the YAML from the previous step currently causes the **Accelerators** page to break and not show any accelerators. Provide a value for Application Accelerator as a workaround, as in this example:

```
app_config:
  # Existing tap-values.yaml above
  backend:
    reading:
      allow:
        - host: acc-server.accelerator-system.svc.cluster.local
```

Add a non-Git provider integration

To add an integration for a provider that isn't associated with GitHub, see the [Backstage documentation](#).

Update the package profile

After changing `tap-values.yaml`, update the package profile by running:

```
tanzu package installed update tap --package tap.tanzu.vmware.com --version VERSION-NUMBER \
--values-file tap-values.yaml -n tap-install
```

Where `VERSION-NUMBER` is the Tanzu Application Platform version. For example, `1.6.13`.

For example:

```
$ tanzu package installed update tap --package tap.tanzu.vmware.com --version \
1.6.13 --values-file tap-values.yaml -n tap-install
| Updating package 'tap'
| Getting package install for 'tap'
| Getting package metadata for 'tap.tanzu.vmware.com'
| Updating secret 'tap-tap-install-values'
| Updating package install for 'tap'
/ Waiting for 'PackageInstall' reconciliation for 'tap'

Updated package install 'tap' in namespace 'tap-install'
```

Configure the Tanzu Developer Portal database

The Tanzu Developer Portal (formerly called Tanzu Application Platform GUI) catalog gives you two approaches for storing catalog information:

- **In-memory database:**

The default option uses an in-memory database and is suitable for test and development scenarios only. The in-memory database reads the catalog data from Git URLs that you write in `tap-values.yaml`.

This data is temporary. Any operations that cause the `server` pod in the `tap-gui` namespace to be re-created also cause this data to be rebuilt from the Git location.

This can cause issues when you manually register entities by using the UI because they only exist in the database and are lost when that in-memory database is rebuilt. If you choose

this method, you lose all user preferences and any manually registered entities when the Tanzu Developer Portal server pod is re-created.

- **PostgreSQL database:**

For production use-cases, use a PostgreSQL database that exists outside the Tanzu Application Platform packaging. The PostgreSQL database stores all the catalog data persistently both from the Git locations and the UI manual entity registrations.

For production or general-purpose use-cases, a PostgreSQL database is recommended.

Configure a PostgreSQL database

See the following sections for configuring Tanzu Developer Portal to use a PostgreSQL database.

Edit `tap-values.yaml`

Apply the following values in `tap-values.yaml`:

```
# ... existing tap-values.yaml above
tap_gui:
  # ... existing tap_gui values
  app_config:
    backend:
      database:
        client: pg
        connection:
          host: PG-SQL-HOSTNAME
          port: 5432
          user: PG-SQL-USERNAME
          password: PG-SQL-PASSWORD
          ssl: {rejectUnauthorized: false} # Set to true if using SSL
```

Where:

- `PG-SQL-HOSTNAME` is the host name of your PostgreSQL database
- `PG-SQL-USERNAME` is the user name of your PostgreSQL database
- `PG-SQL-PASSWORD` is the password of your PostgreSQL database

(Optional) Configure extra parameters

Beyond the minimum configuration options needed to make Tanzu Developer Portal work with the `pg` driver, there are many more configuration options for other purposes. For example, you can restrict Tanzu Developer Portal to a single database. For more information about this restriction, see the [Backstage documentation](#).

By default, Tanzu Developer Portal creates a database for each plug-in, but you can configure it to divide plug-ins based on different PostgreSQL schemas and use a single specified database.

See the following example of extra configuration parameters:

```
# ... existing tap-values.yaml above
tap_gui:
  # ... existing tap_gui values
  app_config:
    backend:
      # ... other backend details
      database:
        client: pg

        # This parameter tells Tanzu Developer Portal to put plug-ins in their own sch
```

```

ema instead
  # of their own database.
  # default: database
  pluginDivisionMode: schema

  connection:
    # ... other connection details
    database: PG-SQL-DATABASE

```

Where `PG-SQL-DATABASE` is the database name for Tanzu Developer Portal to use

For the complete list of these configuration options, see the [node-postgres documentation](#).

Update the package profile

You can apply your new configuration by updating Tanzu Application Platform with your modified values. Doing so updates Tanzu Developer Portal because it belongs to Tanzu Application Platform.

To apply your new configuration, run:

```

tanzu package installed update tap --package tap.tanzu.vmware.com --version VERSION-N
UMBER --values-file tap-values.yaml -n tap-install

```

Where `VERSION-NUMBER` is your Tanzu Application Platform version. For example, `1.6.13`.

For example:

```

$ tanzu package installed update tap --package tap.tanzu.vmware.com --version {{ var
s.tap_version }} --values-file tap-values.yaml -n tap-install
| Updating package 'tap'
| Getting package install for 'tap'
| Getting package metadata for 'tap.tanzu.vmware.com'
| Updating secret 'tap-tap-install-values'
| Updating package install for 'tap'
/ Waiting for 'PackageInstall' reconciliation for 'tap'

Updated package install 'tap' in namespace 'tap-install'

```

Generate and publish TechDocs

This topic tells you how to generate and publish TechDocs for catalogs as part of Tanzu Developer Portal (formerly called Tanzu Application Platform GUI). For more information about TechDocs, see the [Backstage.io documentation](#).

Create an Amazon S3 bucket

To create an Amazon S3 bucket:

1. Go to [Amazon S3](#).
2. Click **Create bucket**.
3. Give the bucket a name.
4. Select the AWS region.
5. Keep **Block all public access** checked.
6. Click **Create bucket**.

Configure Amazon S3 access

The TechDocs are published to the S3 bucket that was recently created. You need an AWS user's access key to read from the bucket when viewing TechDocs.

Create an AWS IAM user group

To create an [AWS IAM User Group](#):

1. Click **Create Group**.
2. Give the group a name.
3. Click **Create Group**.
4. Click the new group and navigate to **Permissions**.
5. Click **Add permissions** and click **Create Inline Policy**.
6. Click the **JSON** tab and replace contents with this JSON replacing `BUCKET-NAME` with the bucket name.

```
{
  "Version": "2012-10-17",
  "Statement": [
    {
      "Sid": "ReadTechDocs",
      "Effect": "Allow",
      "Action": [
        "s3:ListBucket",
        "s3:GetObject"
      ],
      "Resource": [
        "arn:aws:s3:::BUCKET-NAME",
        "arn:aws:s3:::BUCKET-NAME/*"
      ]
    }
  ]
}
```

7. Click **Review policy**.
8. Give the policy a name and click **Create policy**.

Create an AWS IAM user

To create an [AWS IAM User](#) to add to this group:

1. Click **Add users**.
2. Give the user a name.
3. Verify **Access key - Programmatic access** and click **Next: Permissions**.
4. Verify the IAM Group to add the user to and click **Next: Tags**.
5. Click **Next: Review** then click **Create user**.
6. Record the **Access key ID** (`AWS_READONLY_ACCESS_KEY_ID`) and the **Secret access key** (`AWS_READONLY_SECRET_ACCESS_KEY`) and click **Close**.

Find the catalog locations and their entities' namespace, kind, and name

TechDocs are generated for catalogs that have Markdown source files for TechDocs. To find the catalog locations and their entities' namespace, kind, and name:

1. The catalogs appearing in Tanzu Developer Portal are listed in the config values under `app_config.catalog.locations`.
2. For a catalog, clone the catalog's repository to the local file system.
3. Find the `mkdocs.yml` that is at the root of the catalog. There is a YAML file describing the catalog at the same level called `catalog-info.yaml`.
4. Record the values for `namespace`, `kind`, and `metadata.name`, and the directory path containing the YAML file.
5. Record the `spec.targets` in that file.
6. Find the namespace, kind, or name for each of the targets:
 1. Go to the target's YAML file.
 2. The `namespace` value is the value of `namespace`. If it is not specified, it has the value `default`.
 3. The `kind` value is the value of `kind`.
 4. The `name` value is the value of `metadata.name`.
 5. Record the directory path containing the YAML file.

Use the TechDocs CLI to generate and publish TechDocs

VMware uses `npx` to run the TechDocs CLI, which requires `Node.js` and `npm`. To generate and publish TechDocs by using the TechDocs CLI:

1. [Download and install Node.js and npm](#).
2. Install `npx` by running:

```
npm install -g npx
```

3. Generate the TechDocs for the root of the catalog by running:

```
npx @techdocs/cli generate --source-dir DIRECTORY-CONTAINING-THE-ROOT-YAML-FILE
--output-dir ./site
```



Note

This creates a temporary `site` directory in your current working directory that contains the generated TechDocs files.

4. Review the contents of the `site` directory to verify the TechDocs were generated.
5. Set environment variables for authenticating with Amazon S3 with an account that has read/write access:

```
export AWS_ACCESS_KEY_ID=AWS-ACCESS-KEY-ID
export AWS_SECRET_ACCESS_KEY=AWS-SECRET-ACCESS-KEY
export AWS_REGION=AWS-REGION
```

6. Publish the TechDocs for the root of the catalog to the Amazon S3 bucket you created earlier by running:

```
npx @techdocs/cli publish --publisher-type awsS3 --storage-name BUCKET-NAME --e
ntity \
```

```
NAMESPACE/KIND/NAME --directory ./site
```

Where `NAMESPACE/KIND/NAME` are the values for `namespace`, `kind`, and `metadata.name` you recorded earlier. For example, `default/location/yelb-catalog-info`.

- For each of the `spec.targets` found earlier, repeat the `generate` and `publish` commands.



Note

The `generate` command erases the contents of the `site` directory before creating new TechDocs files. Therefore, the `publish` command must follow the `generate` command for each target.

Update the `techdocs` section in `app-config.yaml` to point to the Amazon S3 bucket

Update the config values you used during installation to point to the Amazon S3 bucket that has the published TechDocs files:

- Add or edit the `techdocs` section under `app_config` in the config values with the following YAML, replacing placeholders with the appropriate values.

```
techdocs:
  builder: 'external'
  publisher:
    type: 'awsS3'
    awsS3:
      bucketName: BUCKET-NAME
      accountId: ACCOUNT-ID
      region: AWS-REGION
  aws:
    accounts:
      - accountId: ACCOUNT-ID
        accessKeyId: AWS-READONLY-ACCESS-KEY-ID
        secretAccessKey: AWS-READONLY-SECRET-ACCESS-KEY
```

For more information about authentication to an Amazon S3 bucket through an assumed role, see the [Backstage documentation](#).

- Update your installation from the Tanzu CLI:

Tanzu Application Platform package installation

If you installed Tanzu Developer Portal as part of the Tanzu Application Platform package (in other words, if you installed it by running `tanzu package install tap ...`) then run:

```
tanzu package installed update tap \
  --version PACKAGE-VERSION \
  --values-file VALUES-FILE
```

Where `PACKAGE-VERSION` is your package version and `VALUES-FILE` is your values file

Separate package installation

If you installed Tanzu Developer Portal as its own package (in other words, if you installed it by running `tanzu package install tap-gui ...`) then run:

```
tanzu package installed update tap-gui \
  --version PACKAGE-VERSION \
  --values-file VALUES-FILE
```

Where `PACKAGE-VERSION` is your package version and `VALUES-FILE` is your values file

3. Verify the status of the update by running:

```
tanzu package installed list
```

4. Go to the **Docs** section of your catalog and view the TechDocs pages to verify the content is loaded from the S3 bucket.

Overview of Configurator (beta)

The Tanzu Developer Portal (formerly named Tanzu Application Platform GUI) Configurator tool enables you to add functions (plug-ins) to Tanzu Developer Portal, turning it into a customized portal.



Caution

The Configurator tool is in beta. Do not use it in a production environment.

Differences between the pre-built Tanzu Developer Portal and a customized portal

Tanzu Application Platform has a pre-built version of Tanzu Developer Portal. The portal uses the Backstage open-source framework and includes the core capability of Backstage (Software Catalog, TechDocs, API Docs, Templates/Accelerators, and Kubernetes).

The Backstage framework enables you to enhance your portal's capabilities by adding functions as plug-ins. For more information about Backstage, see the [Backstage documentation](#).

Any portal owner can create two types of Backstage plug-ins:

- Custom plug-ins, which are for organization-specific needs
- Community plug-ins, which are for common needs and are made publicly available to Backstage adopters

The operator might choose to just use the pre-built Tanzu Developer Portal that includes all the core functions of Backstage as well as all the integrations with Tanzu Application Platform. Alternatively, the operator might choose to customize Tanzu Developer Portal as needed by using the Configurator tool.

How Configurator works

Configurator takes the list of the Backstage plug-ins that you want to integrate into your Tanzu Developer Portal. With that plug-in list, Configurator generates a developer portal customized to your specifications. VMware has built automation to simplify integrating the plug-ins.

With these new plug-ins the maintenance of a customized portal remains similar to that of a pre-built Tanzu Developer Portal, handled by the automation of Tanzu Application Platform.

Next steps

See [Tanzu Developer Portal Configurator Concepts](#) or skip straight to [Building your Customized Tanzu Developer Portal with Configurator](#)

Overview of Configurator (beta)

The Tanzu Developer Portal (formerly named Tanzu Application Platform GUI) Configurator tool enables you to add functions (plug-ins) to Tanzu Developer Portal, turning it into a customized portal.



Caution

The Configurator tool is in beta. Do not use it in a production environment.

Differences between the pre-built Tanzu Developer Portal and a customized portal

Tanzu Application Platform has a pre-built version of Tanzu Developer Portal. The portal uses the Backstage open-source framework and includes the core capability of Backstage (Software Catalog, TechDocs, API Docs, Templates/Accelerators, and Kubernetes).

The Backstage framework enables you to enhance your portal's capabilities by adding functions as plug-ins. For more information about Backstage, see the [Backstage documentation](#).

Any portal owner can create two types of Backstage plug-ins:

- Custom plug-ins, which are for organization-specific needs
- Community plug-ins, which are for common needs and are made publicly available to Backstage adopters

The operator might choose to just use the pre-built Tanzu Developer Portal that includes all the core functions of Backstage as well as all the integrations with Tanzu Application Platform. Alternatively, the operator might choose to customize Tanzu Developer Portal as needed by using the Configurator tool.

How Configurator works

Configurator takes the list of the Backstage plug-ins that you want to integrate into your Tanzu Developer Portal. With that plug-in list, Configurator generates a developer portal customized to your specifications. VMware has built automation to simplify integrating the plug-ins.

With these new plug-ins the maintenance of a customized portal remains similar to that of a pre-built Tanzu Developer Portal, handled by the automation of Tanzu Application Platform.

Next steps

See [Tanzu Developer Portal Configurator Concepts](#) or skip straight to [Building your Customized Tanzu Developer Portal with Configurator](#)

Tanzu Developer Portal Configurator Concepts

This topic gives you conceptual overviews of how Tanzu Developer Portal (formerly named Tanzu Application Platform GUI) Configurator works.



Caution

The Configurator tool is in beta. Do not use it in a production environment.

Overview of how to customize your portal

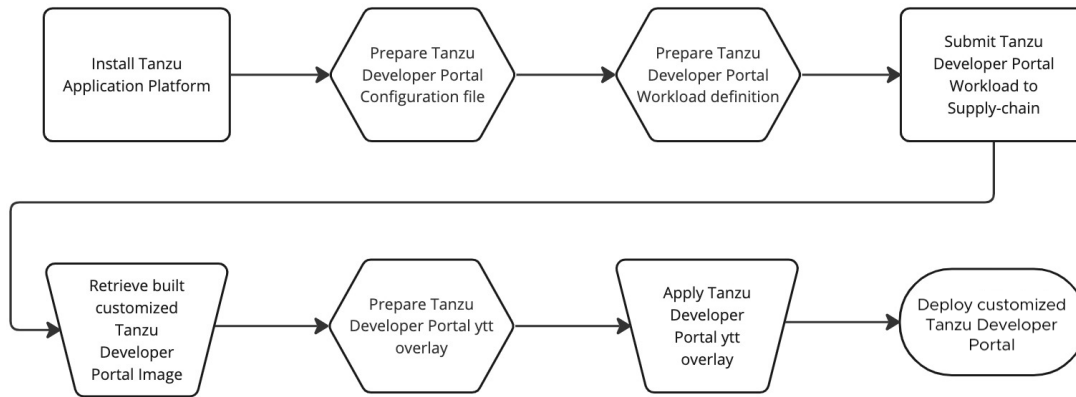

To use your customized portal with all the runtime configuration values used in your pre-built version:

1. Install a working installation of Tanzu Application Platform with a working instance of the pre-built Tanzu Developer Portal.
2. Prepare your Configurator buildtime configuration file.
3. Prepare your Configurator workload definition YAML.
4. Submit your Configurator workload definition YAML to your supplychain.
5. After the image is built, retrieve your customized Tanzu Developer Portal image from your supplychain deliverables.
6. To run your customized portal, prepare a ytt overlay to replace the pre-built Tanzu Developer Portal in Tanzu Application Platform with your customized version. For more information about ytt, see the [Carvel documentation](#).
7. Apply the ytt overlay to your cluster.

Overviews of buildtime configuration and runtime configuration

The following sections describe the differences between buildtime configuration and runtime configuration.

Buildtime configuration

Buildtime configuration refers to the customization of how plug-ins are included in the Tanzu Developer Portal image that you run on your Tanzu Application Platform cluster.

Configurator reads this buildtime configuration to help build your customized instance of Tanzu Developer Portal. Buildtime configuration values can include:

- Which plug-ins are included in your portal
- How plug-ins are linked on the sidebar for your portal
- Which cards are available and how they appear in the software catalog

Runtime configuration

Runtime configuration refers to the values that you use to configure the portal. You provide these values in `tap-values.yaml` when you install and run your portal. Runtime configuration values can

include:

- The name of your portal
- Integrations (GitHub or GitLab keys, identity provider configuration, and so on)
- The locations of any catalogs on GitHub or GitLab
- Security credentials
- Showing or hiding the included Tanzu Application Platform plug-ins

Tanzu Developer Portal Configurator Foundation

The Tanzu Developer Portal Configurator Foundation is the image that contains everything necessary to build a customized version of Tanzu Developer Portal. Foundation includes the templated Tanzu Developer Portal, an internal registry of Tanzu Developer Portal plug-ins, and tools to enable the build process to incorporate external plug-ins.

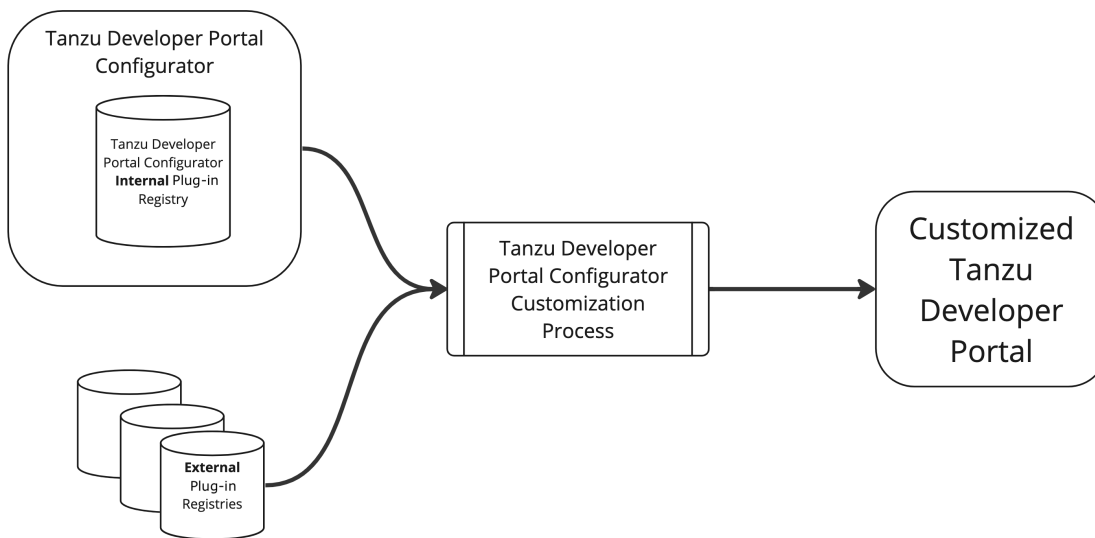

Internal plug-ins and external plug-ins

Internal plug-ins are included inside the Tanzu Developer Portal Configurator Foundation image. These include Tanzu Application Platform plug-ins and [Backstage](#) core plug-ins.

External plug-ins are not in the Tanzu Developer Portal Configurator Foundation image. They are added from the external registry [npmjs.com](#). They can include custom plug-ins and [third-party Backstage plug-ins](#).

Plug-in surfaces and wrappers

Tanzu Developer Portal Configurator introduces plug-in surfaces and plug-in wrappers.

Plug-in surfaces

A surface is a discrete capability that a plug-in provides. This can include:

- The ability to show up on the sidebar
- The ability to be accessed at a URL, such as https://YOUR_PORTAL_URL/plugin
- The ability to show up as a Catalog Overview tab

Plug-in wrappers

A wrapper is a method of exposing a plug-in's surfaces to the Tanzu Developer Portal Configurator so that the plug-in can be integrated into a customized portal. A wrapper imports a reference to the underlying plug-in. A wrapper is also, in fact, a plug-in itself.

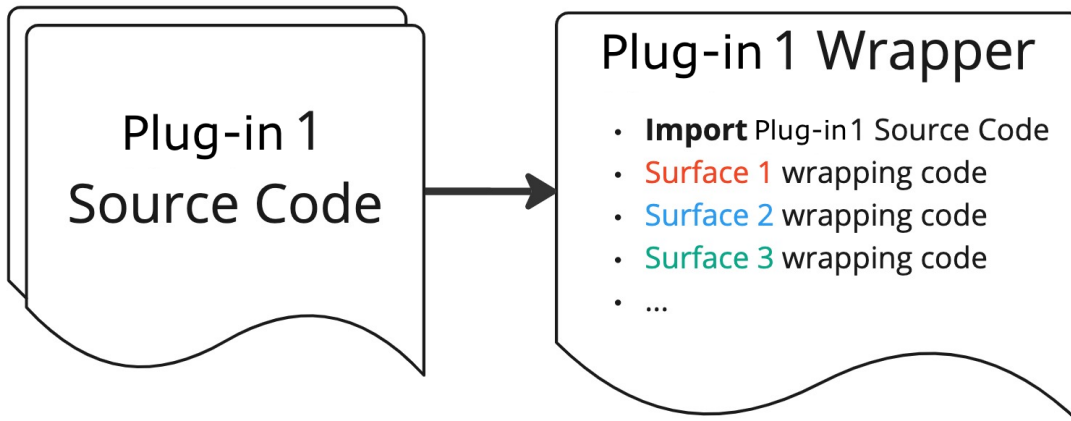

Build your Customized Tanzu Developer Portal with Configurator (beta)

This topic tells you how to build your customized Tanzu Developer Portal (formerly named Tanzu Application Platform GUI) with Configurator.



Caution

The Configurator tool is in beta. Do not use it in a production environment.

Prerequisites

Meet the following prerequisites:

- Ensure that Configurator has a running and operating Tanzu Application Platform instance to build the customized portal and run the resulting customized image. You can use a `full` profile for everything or you can use a `build` profile for customizing the portal and a `view` profile for running the customized portal. For more information, see [Components and installation profiles for Tanzu Application Platform](#).
- Ensure that your instance of Tanzu Application Platform has a working supplychain that can build the Tanzu Developer Portal bundle. It doesn't need to be able to deliver it because currently an overlay is used to place the built image on the cluster where the pre-built Tanzu Developer Portal resides.
- Ensure that your developer namespace has access to both:
 - Your installation registry where the source Tanzu Application bundles are located
 - Your build registry where your built images are staged

Verify that you have a working Tanzu Application Platform installation and you can build a sample application, such as [Tanzu-Java-Web-App](#) in [Generate an application with Application Accelerator](#).

- Ensure that your extra plug-ins are in the [npmjs.com](#) registry.
- Ensure that [Carvel tools](#) is installed on your workstation. `imgpkg`, in particular, must be installed to perform some of the build steps.

- Ensure that the [yq tool](#) is installed.
- Ensure that the [Docker CLI](#) is installed and that you've logged into your registry.



Important

Tanzu Application Platform plug-ins cannot be removed from customized portals. However, if you decide you want to hide them, you can use the [runtime configuration](#) options in your `tap-values.yaml` file.

Prepare your Configurator configuration file

To prepare your Configurator configuration file:

1. Create a new file called `tpb-config.yaml` by using the following template:

```
app:
  plugins:
    - name: 'NPM-PLUGIN-FRONTEND'
      version: 'NPM-PLUGIN-FRONTEND-VERSION'
  backend:
    plugins:
      - name: 'NPM-PLUGIN-BACKEND'
        version: 'NPM-PLUGIN-BACKEND-VERSION'
```

Where:

- `NPM-PLUGIN-FRONTEND` is the npm registry and module name of the front-end plug-in
- `NPM-PLUGIN-FRONTEND-VERSION` is the version of your desired front-end plug-in that exists in the npm registry
- `NPM-PLUGIN-BACKEND` is the npm registry and module name of the back-end plug-in that you want
- `NPM-PLUGIN-BACKEND-VERSION` is the version of your desired back-end plug-in that exists in the npm registry

The following example adds the sample `hello-world` plug-in, which is available in the internal package's registry:

```
app:
  plugins:
    - name: '@tpb/plugin-hello-world'
      version: '^1.6.0-release-1.6.x.1'
  backend:
    plugins:
      - name: '@tpb/plugin-hello-world-backend'
        version: '^1.6.0-release-1.6.x.1'
```

2. Encode the file in base64, to later embed `tpb-config.yaml` in the workload definition file, by running:

```
base64 -i tpb-config.yaml
```

Identify your Configurator image

To build a customized Tanzu Developer Portal, you must identify the Configurator image to pass through the supply chain. This is located on the image registry to which you relocated the

installation packages.

Using imgpkg v0.39.0 or earlier

If using imgpkg v0.39.0 or earlier:

1. Using the `imgpkg` tool, retrieve the image location by running:

```
imgpkg describe -b $(kubectl get -n tap-install $(kubectl get package -n tap-install \
--field-selector spec.refName=tpb.tanzu.vmware.com -o name) -o \
jsonpath="{.spec.template.spec.fetch[0].imgpkgBundle.image}") -o yaml --tty=true | grep -A 1 \
"kbld.carvel.dev/id:[[:blank:]]*[^[:blank:]]*configurator" | grep "image:" |
sed 's/[[:blank:]]*image:[[:blank:]]*//g'
```

Output similar to the following appears:

```
IMAGE-REGISTRY/tap-packages@sha256:bea2f5bec5c5102e2a69a4c5047fae3d51f2974191
1cf5bb588893aa4e03ca27
```

2. Record this value to later use it in place of the `TDP-IMAGE-LOCATION` placeholder in the workload definition.

Using imgpkg v0.40.0 or later

If using imgpkg v0.40.0 or later:

1. Using the `imgpkg` tool, download the bundle by running:

```
imgpkg pull -b $(kubectl get -n tap-install $(kubectl get package -n tap-install \
all \
--field-selector spec.refName=tpb.tanzu.vmware.com -o name) -o \
jsonpath="{.spec.template.spec.fetch[0].imgpkgBundle.image}") -o bundle
```

2. Retrieve the image location by running:

```
cat bundle/.imgpkg/images.yml | grep -A 1 "kbld.carvel.dev/id:[[:blank:]]*[^[:blank:]]*configurator" | \
grep "image:" | sed 's/[[:blank:]]*image:[[:blank:]]*//g'
```

Output similar to the following appears:

```
IMAGE-REGISTRY/tap-packages@sha256:bea2f5bec5c5102e2a69a4c5047fae3d51f2974191
1cf5bb588893aa4e03ca27
```

3. Record this value to later use it in place of the `TDP-IMAGE-LOCATION` placeholder in the workload definition.

Prepare your Configurator workload definition file

Create a file called `tdp-workload.yaml` with the following content:

```
apiVersion: carto.run/v1alpha1
kind: Workload
metadata:
  name: tdp-configurator
  namespace: DEVELOPER-NAMESPACE
labels:
  apps.tanzu.vmware.com/workload-type: web
  app.kubernetes.io/part-of: tdp-configurator
spec:
```

```

build:
  env:
    - name: BP_NODE_RUN_SCRIPTS
      value: 'set-tpb-config,portal:pack'
    - name: TPB_CONFIG
      value: /tmp/tpb-config.yaml
    - name: TPB_CONFIG_STRING
      value:
        ENCODED-TDP-CONFIG-VALUE

  source:
    image: TDP-IMAGE-LOCATION
    subPath: builder

```

Where:

- `DEVELOPER-NAMESPACE` is an appropriately configured developer namespace on the cluster
- `ENCODED-TDP-CONFIG-VALUE` is the base64-encoded value that you encoded earlier
- `TDP-IMAGE-LOCATION` is the location of the Configurator image in the image registry from which you installed Tanzu Application Platform



Important

Depending on which supply chain you're using or how you've configured it, you might need to add extra sections to your workload definition file to accommodate activities such as testing.

For example:

```

apiVersion: carto.run/v1alpha1
kind: Workload
metadata:
  name: tdp-configurator
  namespace: default
  labels:
    apps.tanzu.vmware.com/workload-type: web
    app.kubernetes.io/part-of: tdp-configurator
spec:
  build:
    env:
      - name: BP_NODE_RUN_SCRIPTS
        value: 'set-tpb-config,portal:pack'
      - name: TPB_CONFIG
        value: /tmp/tpb-config.yaml
      - name: TPB_CONFIG_STRING
        value:
          YXBwOgogIHBSdWdpbnM6CiAgICAtIG5hbWU6ICdAdHBiL3BsdWdpbiloZWxsby13b3JsZCcK YmFja2
          VuZDoKICBwbHVnaW5zOgogI
          CAgLSBuYW11OiAnQHRwYi9wbHVnaW4taGVsbG8td29ybGQtYmFja2VuZCcK
    source:
      image: TDP-IMAGE-LOCATION
      subPath: builder

```

Submit your workload

Submit the workload definition file you created earlier by running:

```
tanzu apps workload create -f tdp-workload.yaml
```

Run your Customized Tanzu Developer Portal

At this stage, you have [built your customized Tanzu Developer Portal with Configurator](#).

After the build has completed, you retrieve the image reference of the built portal. You then use the image reference to perform a [ytt](#) overlay to substitute that image name for the one running the pre-built Tanzu Developer Portal on your cluster.

Identify the customized image reference

Identify the image that the supply chain built so that you can use the image reference in your [ytt](#) overlay in the next section. There are several ways to retrieve this image name, including using the Kubernetes command-line tool (kubectl) or using the Tanzu Developer Portal GUI.

kubectl

Run:

```
kubectl -n DEVELOPER-NAMESPACE get images.kpack.io WORKLOAD-NAME -o jsonpath={.status.latestImage}
```

Where:

- **DEVELOPER-NAMESPACE** is the configured developer namespace on the cluster where you ran the workload.
- **WORKLOAD-NAME** is the name of the workload you used.

For example:

```
> kubectl -n default get images.kpack.io tpb-workload -o jsonpath={.status.latestImage}
> kapplegate.azurecr.io/demo/workloads/tpb-workload-default@sha256:bae710386f7d81a725ce5ab15d76a3dd4f6ea79804ae0a475cf98f5e3dd6cf82
```

Tanzu Developer Portal GUI

Within the Tanzu Developer Portal GUI:

1. Select your workload in the Supply Chain view.

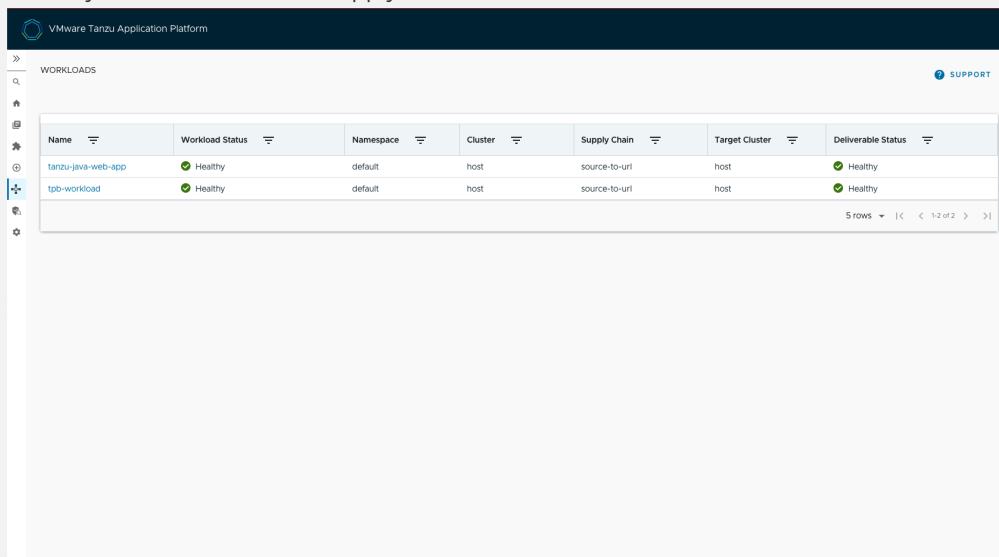

2. Record the Artifact Detail image value you see in the detailed view of the workload.

The screenshot displays the VMware Tanzu Application Platform interface for a workload named 'tpb-workload'. The supply chain is visualized as a sequence of steps: Source Provider (ImageRepository), Image Provider (Image), Config Provider (PodManifest), App Config (ConfigMap), Service Bindings (ConfigMap), and Api Descriptors (ConfigMap). The 'Image Provider' step is selected, and its artifact details are shown in a pop-up window. The artifact details include the image name: 'kapplegate.azurecr.io/demo/workloads/tpb-workload-default@sha256...'.

Prepare to overlay your customized image onto the currently running instance

To prepare to overlay your customized image onto the currently running instance:

1. Create the `ytt` overlay secret.
2. Create a file called `tdp-overlay-secret.yaml` with the following content to replace `IMAGE-REFERENCE` with the customized image you retrieved earlier:

```
apiVersion: v1
kind: Secret
metadata:
  name: tpb-app-image-overlay-secret
  namespace: tap-install
stringData:
  tpb-app-image-overlay.yaml: |
    #@ load("@ytt:overlay", "overlay")

    #! makes an assumption that tap-gui is deployed in the namespace: "tap-gui"
    #@overlay/match by=overlay.subset({"kind": "Deployment", "metadata": {"name": "server", "namespace": "tap-gui"}}, expects="1+"
    ---
    spec:
      template:
        spec:
          containers:
            #@overlay/match by=overlay.subset({"name": "backstage"}), expects="1+"
            #@overlay/match-child-defaults missing_ok=True
            - image: IMAGE-REFERENCE
            #@overlay/replace
            args:
              - -c
              - |
                export KUBERNETES_SERVICE_ACCOUNT_TOKEN="$(cat /var/run/secrets/kubernetes.io/serviceaccount/token)"
                exec /layers/tanzu-buildpacks_node-engine-lite/node/bin/node portal/dist/packages/backend \
                  --config=portal/app-config.yaml \
                  --config=portal/runtime-config.yaml \
                  --config=/etc/app-config/app-config.yaml
```

3. Apply the secret by running:

```
kubectl apply -f tdp-overlay-secret.yaml
```

4. Add the secret to `tap-values.yaml`, the file used to install Tanzu Application Platform. For example:

```
profile: full
tap_gui:
  ...
package_overlays:
- name: tap-gui
  secrets:
  - name: tpb-app-image-overlay-secret
```

5. Update your installation to use the modified `tap-values.yaml` file. The exact steps vary depending on your installation method (GitOps, online install, or offline install).

For how to do so for an online installation, see [Install your Tanzu Application Platform package](#).

Troubleshoot Tanzu Developer Portal Configurator (beta)

This topic helps you troubleshoot Tanzu Developer Portal (formerly Tanzu Application Platform GUI) Configurator.



Caution

The Configurator tool is in beta. Do not use it in a production environment.

Symptom

No supply chain is found in `tdp-workload.yaml`

Cause

You might not have specified all of the correct information regarding your workload if you're using a supply chain other than `basic`. This documentation has the assumption that you're running the `basic` supply chain, so it doesn't tell you to add any tests. Because supply chains are configurable, there might be stages unique to your configuration.

Solution

If you have a supply chain that requires testing, use a no-op set of tests to make the workload pass through. For more information about no-op, see [Wikipedia](#).

Add the following test YAML to your developer namespace:

```
apiVersion: tekton.dev/v1beta1
kind: Pipeline
metadata:
  labels:
    apps.tanzu.vmware.com/pipeline: noop-pipeline
    name: developer-defined-noop-tekton-pipeline
    namespace: DEVELOPER-NAMESPACE
spec:
  params:
  - name: source-url
    type: string
```



```

- name: source-revision
  type: string
tasks:
- name: noop-task
  params:
  - name: source-url
    value: $(params.source-url)
  - name: source-revision
    value: $(params.source-revision)
  taskSpec:
    metadata: {}
    params:
    - name: source-url
      type: string
    - name: source-revision
      type: string
    steps:
    - image: bash
      name: noop
      resources: {}
      script: |
        echo "Nothing to do for $(params.source-url)/$(params.source-revision)%"

```

Where `DEVELOPER-NAMESPACE` is an appropriately configured developer namespace on the cluster

Add the following YAML to your workload definition:

```

apiVersion: carto.run/v1alpha1
kind: Workload
metadata:
  labels:
    # Existing labels
    apps.tanzu.vmware.com/has-tests: 'true'
spec:
  # Existing parameters
  params:
  - name: testing_pipeline_matching_labels
    value:
      apps.tanzu.vmware.com/pipeline: noop-pipeline
  - name: testing_pipeline_params
    value: {}

```

Now when you submit your workload, the testing stage finishes.

Overview of Tanzu Developer Portal plug-ins

Tanzu Developer Portal (formerly called Tanzu Application Platform GUI) has many pre-integrated plug-ins. You need not configure the plug-ins. To use a plug-in, you must install the relevant Tanzu Application Platform component.

Tanzu Application Platform has the following GUI plug-ins:

- [Runtime Resources Visibility](#)
- [Application Live View](#)
- [Application Accelerator](#)
- [API Documentation](#)
- [Security Analysis](#)
- [Supply Chain Choreographer](#)

Overview of Tanzu Developer Portal plug-ins

Tanzu Developer Portal (formerly called Tanzu Application Platform GUI) has many pre-integrated plug-ins. You need not configure the plug-ins. To use a plug-in, you must install the relevant Tanzu Application Platform component.

Tanzu Application Platform has the following GUI plug-ins:

- [Runtime Resources Visibility](#)
- [Application Live View](#)
- [Application Accelerator](#)
- [API Documentation](#)
- [Security Analysis](#)
- [Supply Chain Choreographer](#)

Runtime resources visibility in Tanzu Developer Portal

This topic tells you about runtime resources visibility.

The Runtime Resources Visibility plug-in enables users to visualize their Kubernetes resources associated with their workloads.

Prerequisite

Do one of the following actions to access the Runtime Resources Visibility plug-in:

- [Install the Tanzu Application Platform Full or View profile](#)
- [Install Tanzu Application Platform without using a profile and then install Tanzu Developer Portal separately](#)
- [Review the section If you have a metrics server](#)

If you have a metrics server

By default, the Kubernetes API does not attempt to use any metrics servers on your clusters. To access metrics information for a cluster, set `skipMetricsLookup` to `false` for that cluster in the `kubernetes` section of `app-config.yaml`. Example:

```
tap_gui:
  # ... existing configuration
  app_config:
    # ... existing configuration
    kubernetes:
      clusterLocatorMethods:
        - type: 'config'
          clusters:
            - url: https://KUBERNETES-SERVICE-HOST:KUBERNETES-SERVICE-PORT
              name: host
              authProvider: serviceAccount
              serviceAccountToken: KUBERNETES-SERVICE-ACCOUNT-TOKEN
              skipTLSVerify: true
              skipMetricsLookup: false
```

Where:

- `KUBERNETES-SERVICE-HOST` and `KUBERNETES-SERVICE-PORT` are the URL and ports of your Kubernetes cluster. You can gather these through `kubectl cluster-info`.
- `KUBERNETES-SERVICE-ACCOUNT-TOKEN` is the token from your `tap-gui-token-id`.

You can retrieve this secret's ID by running:

```
kubectl get secrets -n tap-gui
```

and then running

```
kubectl describe secret tap-gui-token-ID
```

Where **ID** is the secret name from the first step.



Caution

If you enable metrics for a cluster but do not have a metrics server running on it, Tanzu Application Platform web interface users see an error notifying them that there is a problem connecting to the back end.

Visualize Workloads on Tanzu Developer Portal

To view your applications on Tanzu Developer Portal, use the following steps:

1. [Deploy your first application on the Tanzu Application Platform](#)
2. [Add your application to Tanzu Developer Portal Software Catalog](#)

Navigate to the Runtime Resources Visibility screen

You can view the list of running resources and the details of their status, type, namespace, cluster, and public URL if applicable for the resource type.

To view the list of your running resources:

1. Select your component from the Catalog index page.

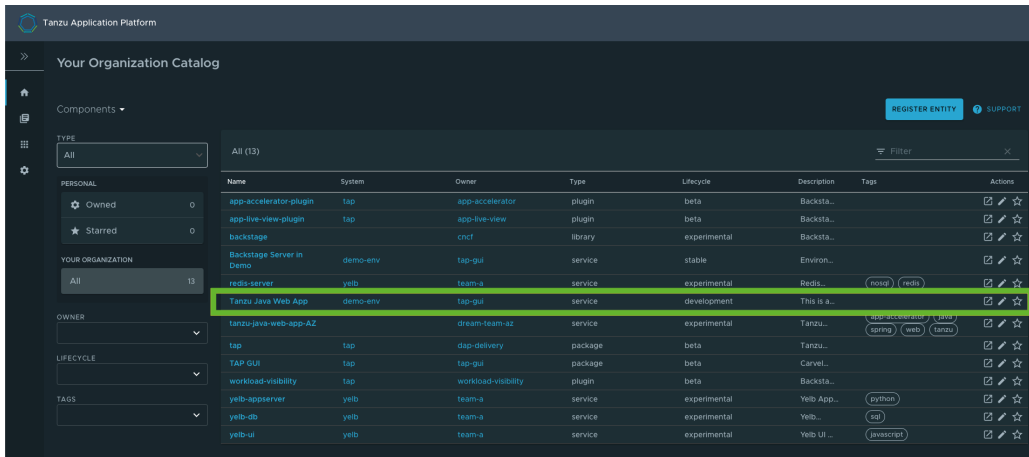

2. Select the **Runtime Resources** tab.

Resources

Built-in Kubernetes resources in this view are:

- Services
- Deployments
- ReplicaSets

- Pods
- Jobs
- Cronjobs
- DaemonSets
- ReplicaSets

The Runtime Resource Visibility plug-in also displays CRDs created with the Supply Chain, including:

- Cartographer Workloads
- Knative Services, Configurations, Revisions, and Routes

For more information, see [Supply Chain Choreographer in Tanzu Developer Portal](#).

CRDs from Supply Chain are associated with Knative Resources, further down the chain, and built-in resources even further down the chain.



Resources details page

To get more information about a particular workload, select it from the table on the main **Runtime Resources** page to visit a page that provides details about the workload. These details include the workload status, ownership, and resource-specific information.

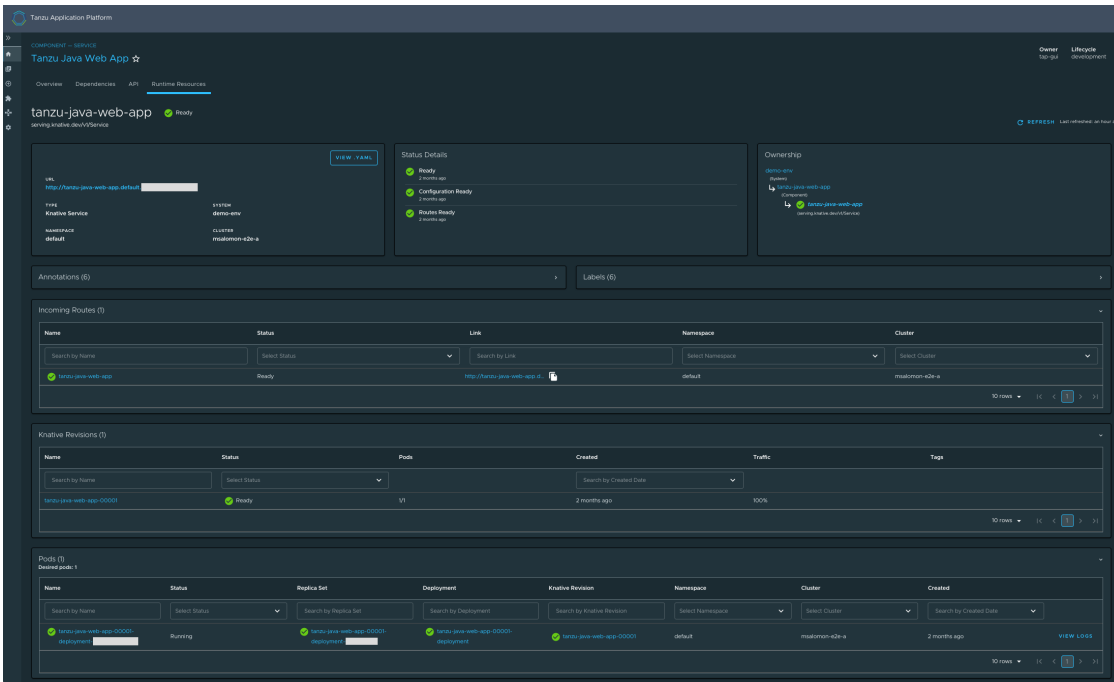

Overview card

All detail pages provide an overview card with information related to the selected resource. Most of the information feeds from the `metadata` attribute in each object. The following are some attributes that are displayed in the overview card:

- **View Pod Logs** button
- **View .YAML** button
- URL, which is for Knative and Kubernetes service detail pages
- Type
- System
- Namespace
- Cluster

[VIEW POD LOGS](#) [VIEW .YAML](#)

<p>CREATED a month ago</p>	<p>TYPE Pod</p>
<p>NAMESPACE default</p>	<p>CLUSTER dev</p>
<p>TOTAL CPU (REQUESTED / LIMIT) Unlimited/Unlimited</p>	<p>TOTAL MEMORY (REQUESTED / LIMIT) Unlimited/Unlimited</p>
<p>VIEW CPU AND MEMORY DETAILS →</p>	<p>VIEW THREADS →</p>

Note

The **VIEW CPU AND MEMORY DETAILS** and **VIEW THREADS** sections are only available for applications supporting Application Live View.

Status card

The status section displays all of the conditions in the resource's attribute `status.conditions`. Not all resources have conditions, and they can vary from one resource to the other.

For more information about object `spec` and `status`, see the [Kubernetes documentation](#).

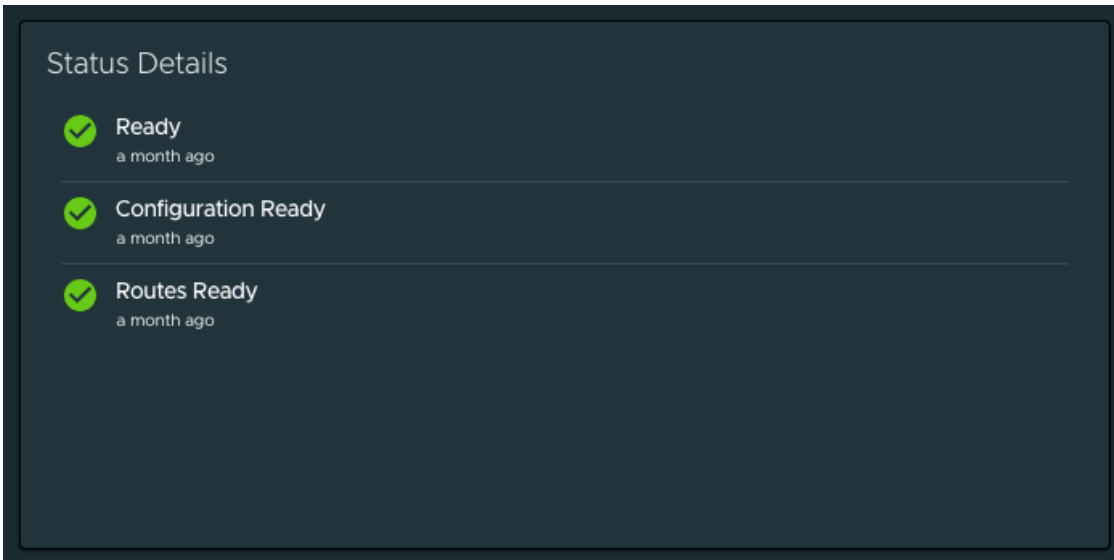

Ownership card

Depending on the resource that you are viewing, the ownership section displays all the resources specified in `metadata.ownerReferences`. You can use this section to navigate between resources.

For more information about owners and dependents, see the [Kubernetes documentation](#).



Annotations and Labels

The Annotations and Labels card displays information about `metadata.annotations` and `metadata.labels`.

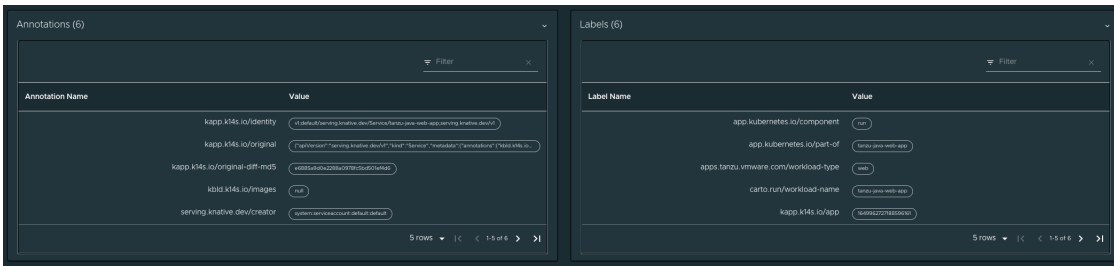

Selecting completed supply chain pods

Completed supply chain pods (build pods and ConfigWriter pods) are hidden by default in the index table. Users can choose to display them from the **Show Additional Resources** drop-down menu above the Resources index table. This drop-down menu is only visible if the resources include Build or ConfigWriter pods.

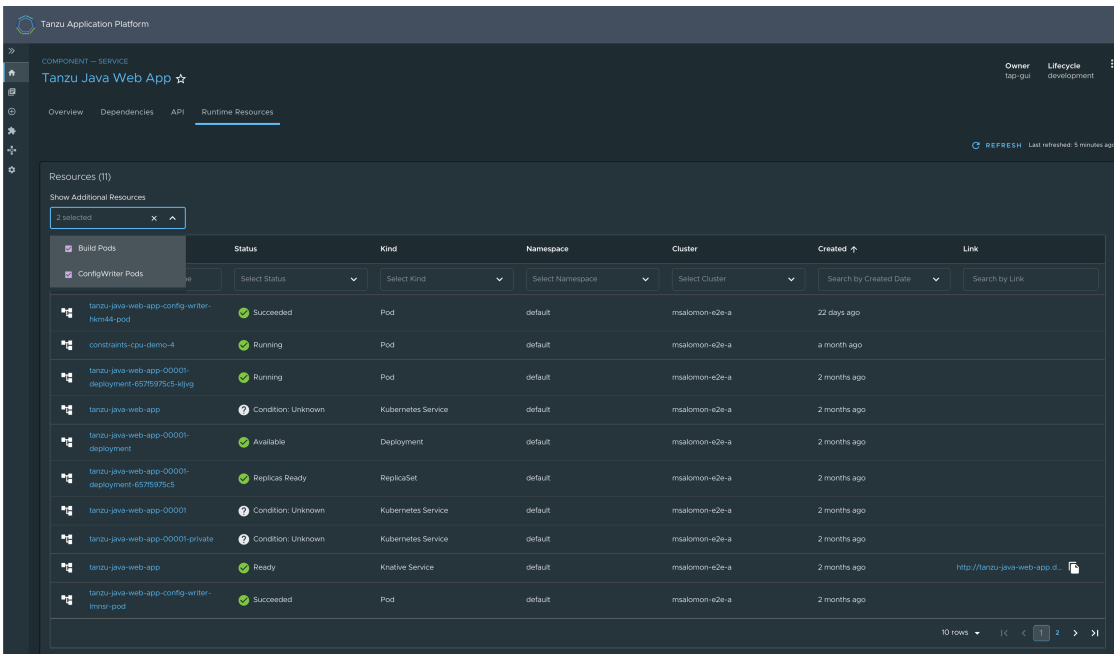

Navigating to the pod Details page

Users can see the pod table in each resource details page.

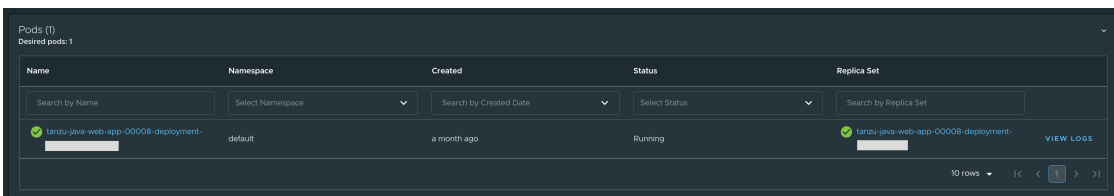

Overview of pod metrics

If you have a metrics server running on your cluster, the overview card displays realtime metrics for pods.

If you do not have a metrics server, the overview card displays the user-configured resource limits on the pod, defined in accordance with the [Kubernetes documentation](#).

For applications built using Spring Boot, you can also monitor the actual real-time resource use using [Screenshot of Application Live View for Spring Boot Applications in Tanzu Developer Portal](#).

Metrics and limits are also displayed for each container on a pod details page. If a particular container’s current limit conflicts with a namespace-level LimitRange, a small warning indicator is displayed next to the container limit. Most conflicts are due to creating a container before applying a LimitRange.

Container	Status	CPU (Requested / Limit)	Memory (Requested / Limit)	Restarts	Image
queue-proxy	✓	25m / Unlimited	Unlimited / Unlimited	0	sha256: [bar]
workload	✓	Unlimited / Unlimited	Unlimited / Unlimited	0	sha256: [bar]

Pods display the sum of the limits of all their containers. If a limit is not specified for a container, both the container and its pod are deemed to require unlimited resources.

Namespace-level resource limits, such as default memory limits and default CPU limits, are not considered as part of these calculations.

For more information about [default memory limits](#) and [default CPU limits](#) see the Kubernetes documentation.

These limits apply only for Memory and CPU that a pod or container can use. Kubernetes manages these resource units by using a binary base, which is explained in the [Kubernetes documentation](#).

Navigating to Application Live View

To view additional information about your running applications, see the [Application Live View](#) section in the **Pod Details** page.

The screenshot shows the 'Application Live View' for a deployment. Key sections include:

- Status Details:** Shows the application is 'Running' with various sub-statuses like 'Running', 'Ready', and 'Containers Ready'.
- Containers Table:**

Container	Status	CPU (Requested / Limit)	Memory (Requested / Limit)	Restarts	Image
queue-proxy	✓	25m / Unlimited	Unlimited / Unlimited	0	sha256: [bar]
workload	✓	Unlimited / Unlimited	Unlimited / Unlimited	0	sha256: [bar]
- Application Metadata:** Includes Application Name (tanzu-java-web-app), Version (2.5.0), Framework (Spring Boot), and other details.

Viewing pod logs

To view logs for a pod, click **View Pod Logs** from the **Pod Details** page. By default, logs for the pod's first container are displayed, dating back to when the pod was created.

The screenshot shows the 'Pod Logs' interface for a pod named 'tanzu-java-web-app-00013-deployment-'. The pod is in a 'Running' state. The logs are displayed in a scrollable area, showing a sequence of log entries. The entries include:

```

280 uptimeMetrics
281 viewExceptionHandlerMapping
282 viewNameTranslator
283 viewResolver
284 webEndpointDiscoverer
285 webEndpointPathMapper
286 webExposeExcludePropertyEndpointFilter
287 webMvcMetricsFilter
288 webMvcTagsProvider
289 webServerFactoryCustomizerBeanPostProcessor
290 websocketServletWebServerCustomizer
291 welcomePageHandlerMapping
292 2022-06-23 03:03:40.629 INFO 1 --- [nio-8081-exec-2] o.a.c.c.C.[Tomcat-1].[localhost].[/] : Initializing Spring DispatcherServlet
293 2022-06-23 03:03:40.629 INFO 1 --- [nio-8081-exec-2] o.s.web.servlet.DispatcherServlet : Initializing Servlet 'dispatcherSer
294 2022-06-23 03:03:40.630 INFO 1 --- [nio-8081-exec-2] o.s.web.servlet.DispatcherServlet : Completed initialization in 1 ms
295 2022-06-28 15:06:58.472 INFO 1 --- [nio-8080-exec-4] o.apache.tomcat.util.http.parser.Cookie : A cookie header was received [times
296 Note: further occurrences of this error will be logged at DEBUG level.
297 2022-06-28 15:06:58.475 INFO 1 --- [nio-8080-exec-4] o.a.c.c.C.[Tomcat].[localhost].[/] : Initializing Spring DispatcherServlet
298 2022-06-28 15:06:58.475 INFO 1 --- [nio-8080-exec-4] o.s.web.servlet.DispatcherServlet : Initializing Servlet 'dispatcherSer
299 2022-06-28 15:06:58.479 INFO 1 --- [nio-8080-exec-4] o.s.web.servlet.DispatcherServlet : Completed initialization in 4 ms
300 2022-07-14 15:41:11.120 WARN 1 --- [nio-8081-exec-4] .w.s.m.s.DefaultHandlerExceptionResolver : Resolved [org.springframework.web.H

```

Pausing and resuming logs

Log entries are streamed in real time. New entries appear at the bottom of the log content area. Click or scroll the log content area to pause the log stream. Pausing the log stream enables you to focus on specific entries.

To resume the stream, click the **Follow Latest** button that appears after pausing.

Filtering by container

To display logs for a different container, select the container that you want from the **Container** drop-down menu.

Filtering by date and time

To see logs since a specific date and time, select or type the UTC timestamp in the **Since date** field. If no logs are displayed, adjust the timestamp to an earlier time. If you do not select a timestamp, all logs produced since the pod was created are displayed.

For optimal performance, the pod logs page limits the total log entries displayed to the last 10,000, at most.

Changing log levels

If the pod is associated with an application that supports **Application Live View**, you can change the application's log levels by clicking the **Change Log Levels** button. You then see a panel that enables you to select levels for each logger associated with your application.

The screenshot displays the 'Log Levels' configuration panel in the Tanzu Application Platform. The panel is titled 'Log Levels' and includes a close button (X) in the top right corner. It features a search bar labeled 'Search by Log' and a 'Changes Only' toggle. Below the search bar, there is a list of loggers with buttons for selecting log levels: OFF, ERR, WARN, INFO, DEBUG, and TRACE. A 'RESET' button is also present for each logger. The 'INFO' level is selected for most loggers. The background shows the 'Pod Logs' section for 'tanzu-java-web-app-00006-cw1z5q' with a list of log entries.

To change the levels for your application, select the desired level for each logger presented, and then click **X** in the upper-right corner of the panel, or press the Escape key, to close the panel.

Because adjusting log levels makes a real-time configuration change to your application, log-level adjustments are only reflected in log entries that your application produces after the change.

If no log entries for the expected levels appear, ensure that:

1. You adjusted the correct application loggers
2. You are viewing logs for the correct container and time frame
3. Your application is currently producing logs at the expected levels

Line wrapping

By default, log entries are not wrapped. To activate or deactivate line wrapping, click the **Wrap lines** toggle.

Downloading logs

To download current log content, click the **Download logs** button.

For optimal performance, the pod logs page limits the total log entries downloaded to the last 10,000, at most.

Connection interruptions

If the log stream connection is interrupted for any reason, such as a network error, a notification appears after the most recent log entry, and the page attempts to reconnect to the log stream. If reconnection fails, an error message displays at the top of the page, and you can click the **Refresh** button at the upper-right of the page to attempt to reconnect.

If you notice frequent disconnections at regular intervals, contact your administrator. Your administrator might need to update the back-end configuration for your installation to allow long-lived HTTP connections to log endpoints (endpoints starting with `BACKEND-HOST/api/k8s-logging/`).

Application Live View in Tanzu Developer Portal

This topic tells you about Application Live View in Tanzu Developer Portal (formerly called Tanzu Application Platform GUI).

Overview

The Application Live View features of Tanzu Application Platform include sophisticated components to give developers and operators a view into their running workloads on Kubernetes.

Application Live View shows an individual running process, for example, a Spring Boot application deployed as a workload resulting in a JVM process running inside of a pod. This is an important concept of Application Live View. Application Live View only recognizes running processes. If there is not a running process inside of a running pod, Application Live View does not show anything.

Under the hood, Application Live View uses the concept of actuators to gather data from those running processes. It visualizes them in a semantically meaningful way and allows users to interact with the inner workings of the running processes within limited boundaries.

The actuator data serves as the source of truth. Application Live View provides a live view of the data from inside of the running processes only. It does not store any of that data for further analysis or historical views.

This easy-to-use interface provides ways to troubleshoot, learn, and maintain an overview of certain aspects of the running processes. It gives a level of control to the users to change some parameters, such as environment properties, without a restart (where the Spring Boot application, for example, supports that).

Entry point to Application Live View plug-in

The Application Live View UI plug-in is part of Tanzu Developer Portal. To use the Application Live View plug-in:

1. Select the relevant component under the **Organization Catalog** in Tanzu Developer Portal.
2. Select the desired service under the **Runtime Resources** tab.
3. Select the desired pod from the **Pods** section under the **Runtime Resources** tab.
4. You can now see all the details, do some lightweight troubleshooting, and interact with the application within certain boundaries under the **Live View** section.

Application Live View in Tanzu Developer Portal

This topic tells you about Application Live View in Tanzu Developer Portal (formerly called Tanzu Application Platform GUI).

Overview

The Application Live View features of Tanzu Application Platform include sophisticated components to give developers and operators a view into their running workloads on Kubernetes.

Application Live View shows an individual running process, for example, a Spring Boot application deployed as a workload resulting in a JVM process running inside of a pod. This is an important

concept of Application Live View. Application Live View only recognizes running processes. If there is not a running process inside of a running pod, Application Live View does not show anything.

Under the hood, Application Live View uses the concept of actuators to gather data from those running processes. It visualizes them in a semantically meaningful way and allows users to interact with the inner workings of the running processes within limited boundaries.

The actuator data serves as the source of truth. Application Live View provides a live view of the data from inside of the running processes only. It does not store any of that data for further analysis or historical views.

This easy-to-use interface provides ways to troubleshoot, learn, and maintain an overview of certain aspects of the running processes. It gives a level of control to the users to change some parameters, such as environment properties, without a restart (where the Spring Boot application, for example, supports that).

Entry point to Application Live View plug-in

The Application Live View UI plug-in is part of Tanzu Developer Portal. To use the Application Live View plug-in:

1. Select the relevant component under the **Organization Catalog** in Tanzu Developer Portal.
2. Select the desired service under the **Runtime Resources** tab.
3. Select the desired pod from the **Pods** section under the **Runtime Resources** tab.
4. You can now see all the details, do some lightweight troubleshooting, and interact with the application within certain boundaries under the **Live View** section.

Application Live View for Spring Boot Applications in Tanzu Developer Portal

This topic tells you about the Application Live View pages for Spring Boot Applications in Tanzu Developer Portal (formerly called Tanzu Application Platform GUI).

Details page

This is the default page loaded in the **Live View** section. This page gives a tabular overview containing the following information:

- application name
- instance ID
- location
- actuator location
- health endpoint
- direct actuator access
- framework
- version
- new patch version
- new major version
- build version

You can navigate between **Information Categories** by selecting from the drop-down menu on the top right corner of the page.

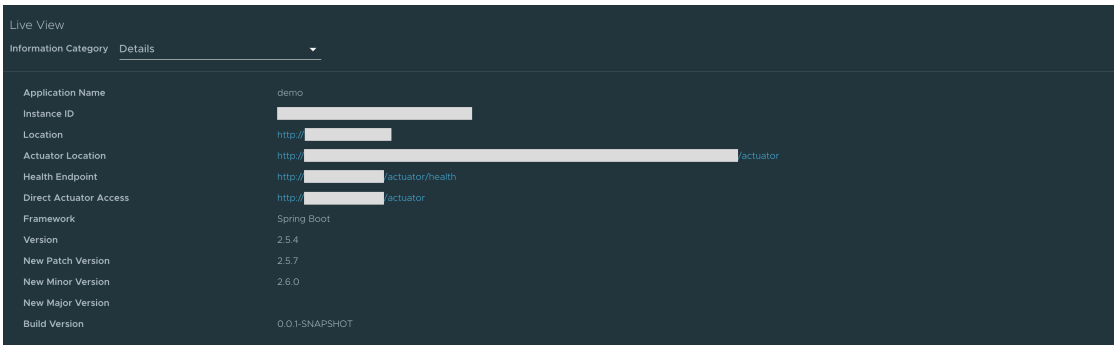

Health page

To go to the health page, select the **Health** option from the **Information Category** drop-down menu. The health page provides detailed information about the health of the application. It lists all the components that make up the health of the application such as readiness, liveness, and disk space. It displays the status and details associated with each component.

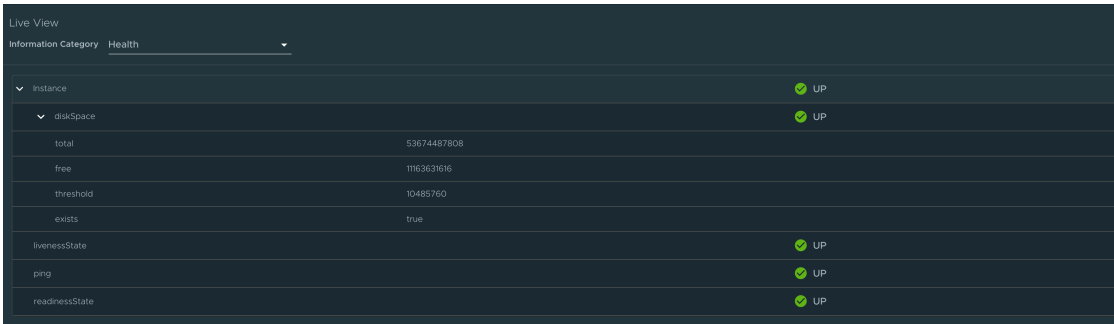

Environment page

To go to the **Environment** page, select the **Environment** option from the **Information Category** drop-down menu. The Environment page contains details of the applications' environment. It contains properties including, but not limited to, system properties, environment variables, and configuration properties (such as application.properties) in a Spring Boot application.

The page includes the following capabilities for **viewing** configured environment properties:

- The UI has a search feature that enables you to search for a property or values.
- Each property has a search icon at the right corner which helps you quickly see all the occurrences of a specific property key without manually typing in the search box. Clicking the search button locates the property name.
- The **Refresh Scope** button on the top right corner of the page probes the application to refresh all the environment properties.

The page also includes the following capabilities for **editing** configured environment properties:

- The UI allows you to edit environment properties and see the live changes in the application. These edits are temporary and go away if the underlying pod is restarted.
- For each configured environment property, you can edit its value by clicking on the **Override** button in the same row. After the value is saved, you can view the message that the property was overridden from the initial value. The updated property is visible in the **Applied Overrides** section at the top of the page. The **Reset** button in the same row resets the environment property to the initial state.

- You can edit or remove the overridden environment variables in the **Applied Overrides** section.
- The **Applied Overrides** section also enables you to add new environment properties to the application.



Note

`management.endpoint.env.post.enabled=true` must be set in the application config properties of the application and a corresponding, editable environment must be present in the application.

Live View

Information Category Environment

Search by Property or Value...

server.ports

local.server.port	8080
-------------------	------

servletContextInitParams

No Properties Set

systemProperties

management.endpoints.web.exposure.include	*
awt.toolkit	sun.awt.X11.XToolkit
java.specification.version	11
sun.cpu.isalist	
sun.jnu.encoding	ANSI_X3.4-1968
java.class.path	/workspace
java.vm.vendor	BellSoft
sun.arch.data.model	64
java.vendor.url	https://bell-sw.com/
catalogina.useNaming	false
user.timezone	Etc/UTC
os.name	Linux
java.vm.specification.version	11
sun.java.launcher	SUN_STANDARD
user.country	US

Log Levels page

To go to the **Log Levels** page, select the **Log Levels** option from the **Information Category** drop-down menu. The log levels page provides access to the application’s loggers and the configuration of their levels.

You can configure the log levels such as INFO, DEBUG, and TRACE in real time from the UI. You can search for a package and edit its respective log level. You can configure the log levels at a specific class and package. They can deactivate all the log levels by modifying the log level of root logger to OFF.

The toggle **Changes Only** displays the changed log levels. Use the search feature to search by logger name. The **Reset** resets the log levels to the original state. The **Reset All** on top right corner of the page resets all the loggers to default state.



Note

Use the UI to change the log levels and see the live changes on the application. These changes are temporary and go away if the underlying pod is restarted.

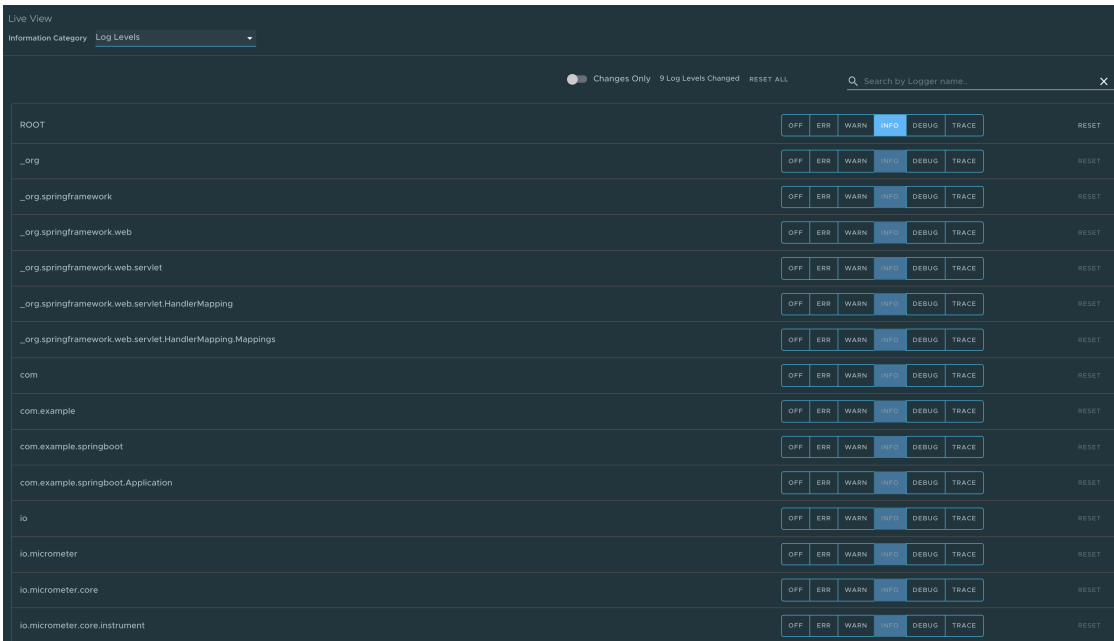

Threads page

To go to the **Threads** page, select the **Threads** option from the **Information Category** drop-down menu.

This page displays all details related to Java Virtual Machine (JVM) threads and running processes of the application. This tracks live threads and daemon threads real-time. It is a snapshot of different thread states. Navigating to a thread state displays all the information about a particular thread and its stack trace.

Use the search feature to search for threads by thread ID or state. The refresh icon refreshes to the latest state of the threads. You can view more thread details by clicking on the Thread ID. The page also has a feature to download thread dump data for analysis purposes.

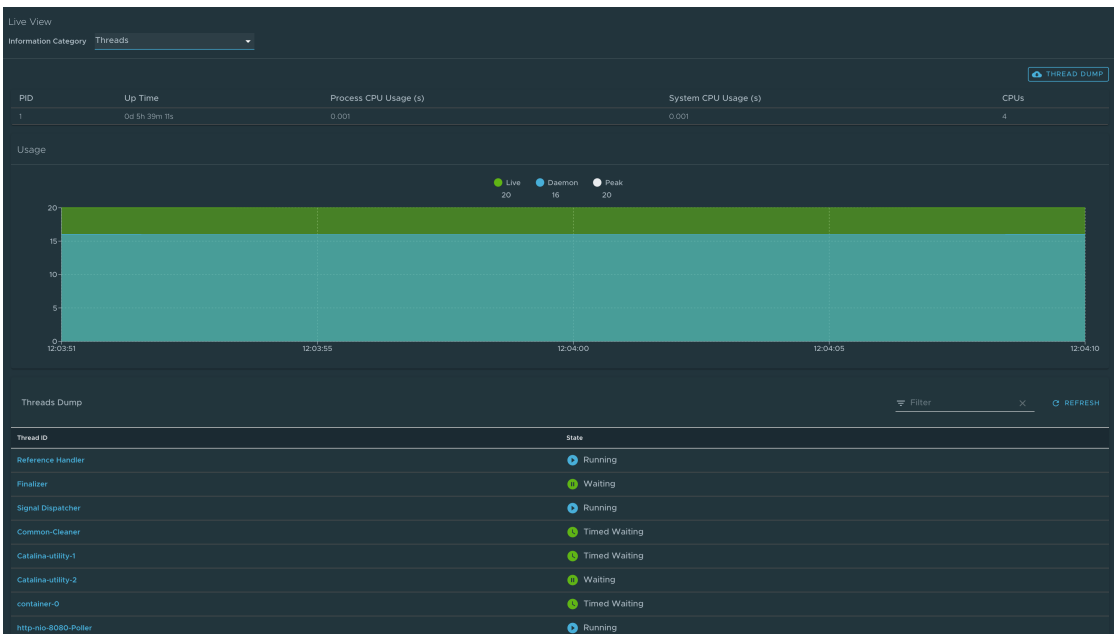

Memory page

To go to the **Memory** page, select the **Memory** option from the **Information Category** drop-down menu.

- The memory page highlights the memory use inside of the JVM. It displays a graphical representation of the different memory regions within heap and non-heap memory. This visualizes data from inside of the JVM (in case of Spring Boot apps running on a JVM) and therefore provides memory insights into the application in contrast to “outside” information about the Kubernetes pod level.
- The real-time graphs displays a stacked overview of the different spaces in memory with the total memory used and total memory size. The page contains graphs to display the GC pauses and GC events.
- The **Heap Dump** at the top-right corner enables you to download heap dump data.

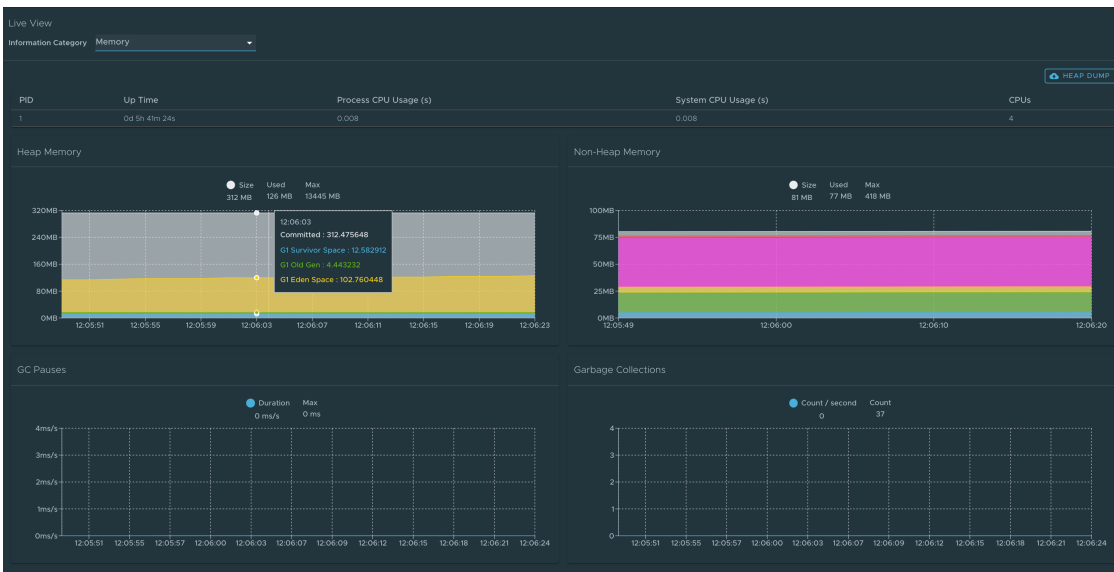

Note

This graphical visualization happens in real time and shows real-time data only. As mentioned at the top, the Application Live View features do not store any information. That means the graphs visualize the data over time only for as long as you stay on that page.

Request Mappings page

To go to the Request Mappings page, select the **Request Mappings** option from the **Information Category** drop-down menu.

This page provides information about the application’s request mappings. For each mapping, it displays the request handler method. You can view more details of the request mapping, such as the header metadata of the application.

When you click on the request mapping, a side panel appears. This panel contains information about the mapping-media types `Produces` and `Consumes`. The panel also displays the `Handler` class for the request. Use the search feature to search for the request mapping or the method. The toggle `/actuator/** Request Mappings` displays the actuator related mappings of the application.



Note

When application actuator endpoint is exposed on `management.server.port`, the application does not return any actuator request mappings data in the context. The application displays a message when the actuator toggle is enabled.

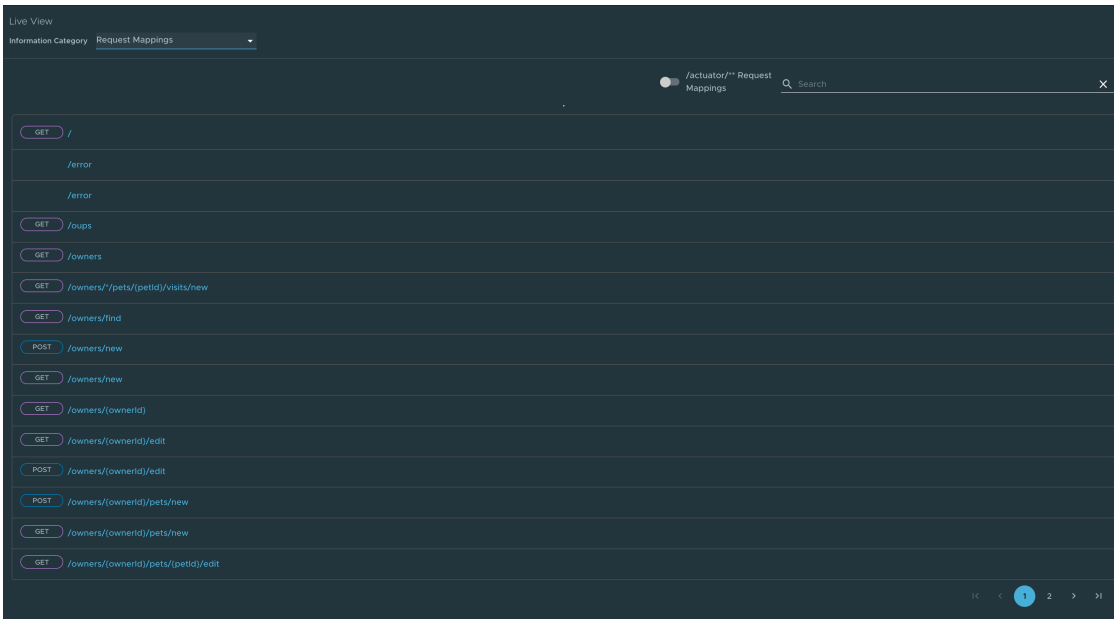

HTTP Requests page

To go to the HTTP Requests page, click **HTTP Requests** from the **Information Category** drop-down menu. The HTTP Requests page provides information about HTTP request-response exchanges to the application.

The graph visualizes the requests per second indicating the response status of all the requests. You can filter the response statuses, which include info, success, redirects, client-errors, and server-errors. The trace data is captured in detail in a tabular format with metrics such as timestamp, method, path, status, content-type, length, time.

The search feature on the table filters the traces based on the search field value. You can view more details of the request, such as method, headers, and response of the application by clicking on the timestamp. The refresh icon above the graph loads the latest traces of the application. The toggle `/actuator/**` on the top right corner of the page displays the actuator related traces of the application.



Note

When application actuator endpoint is exposed on `management.server.port`, no actuator HTTP Traces data is returned for the application. In this case, a message is displayed when the actuator toggle is enabled.

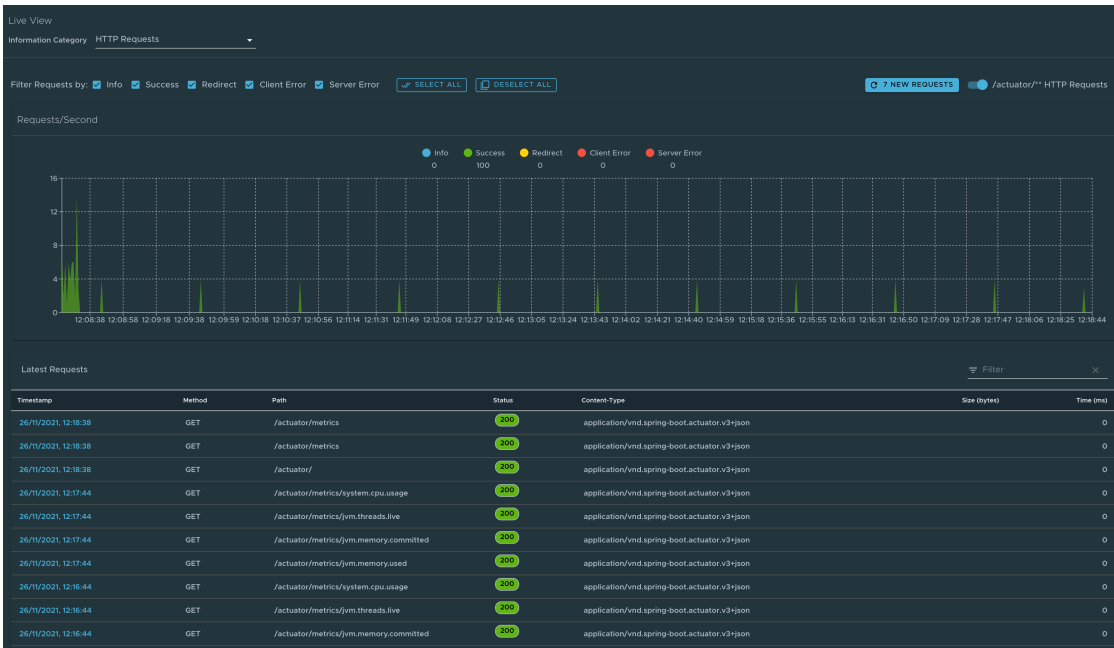

Caches page

To go to the **Caches** page, select the **Caches** option from the **Information Category** drop-down menu.

The Caches page provides access to the application’s caches. It gives the details of the cache managers associated with the application including the fully qualified name of the native cache.

Use the search feature in the Caches Page to search for a specific cache/cache manager. You can clear individual caches by clicking **Evict**. You can clear all the caches completely by clicking **Evict All**. If there are no cache managers for the application, the message **No cache managers available for the application** is displayed.

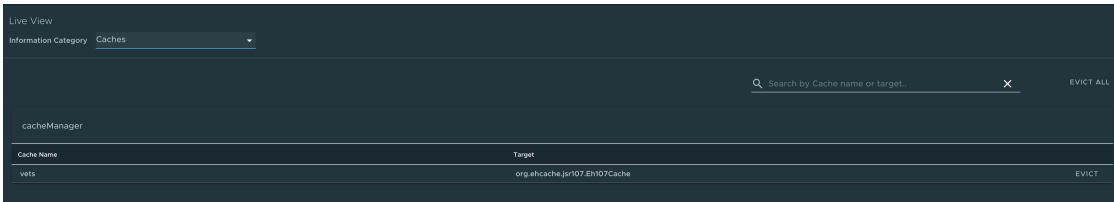

Configuration Properties page

To go to the **Configuration Properties** page, select the **Configuration Properties** option from the **Information Category** drop-down menu.

The configuration properties page provides information about the configuration properties of the application. In case of Spring Boot, it displays application’s `@ConfigurationProperties` beans. It gives a snapshot of all the beans and their associated configuration properties. Use the search feature to search for a property’s key/value or the bean name.

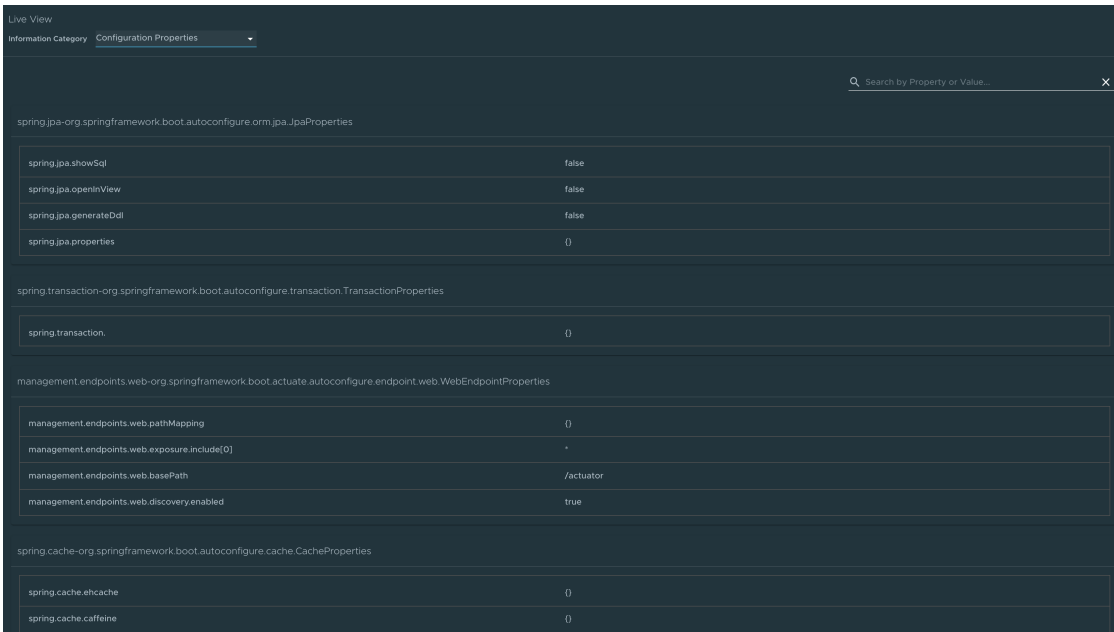

Conditions page

To go to the **Conditions** page, select the **Conditions** option from the **Information Category** drop-down menu. The conditions evaluation report provides information about the evaluation of conditions on configuration and auto-configuration classes.

In the case of Spring Boot, this gives you a view of all the beans configured in the application. When you click on the bean name, the conditions and the reason for the conditional match is displayed.

In the case of non-configured beans, it shows both the matched and unmatched conditions of the bean if any. In addition to this, it also displays names of unconditional auto configuration classes if any. You can use the search feature to filter out the beans and the conditions.

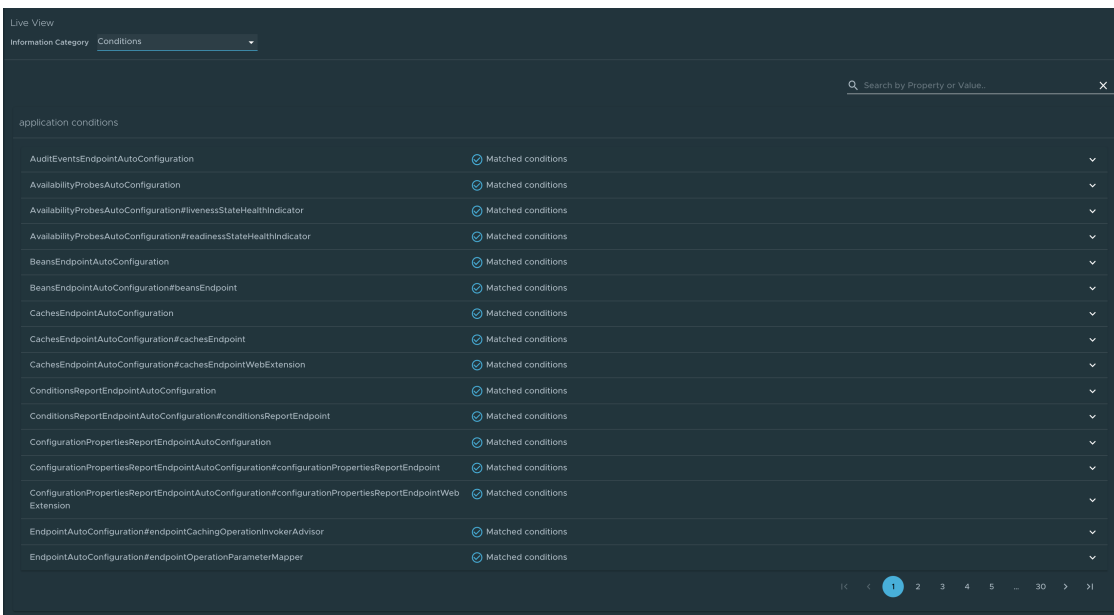

Scheduled Tasks page

To go to the **Scheduled Tasks** page, select the **Scheduled Tasks** option from the **Information Category** drop-down menu.

The scheduled tasks page provides information about the application’s scheduled tasks. It includes cron tasks, fixed delay tasks and fixed rate tasks, custom tasks and the properties associated with them.

You can search for a particular property or a task in the search bar to retrieve the task or property details.

Runnable	Expression	Initial Delay	Interval
com.github.kdvdolder.fortune.service.ScheduledTasks.scheduleTaskUsingCronExpression	0 15 10 15 * ?		
org.springframework.session.jdbc.config.annotation.web.http.JdbcHttpSessionConfiguration\$SessionCleanUpConfiguration\$\$Lambda\$1476/0x0000000000c2d040	0 * * * *		

Runnable	Expression	Initial Delay	Interval
com.github.kdvdolder.fortune.service.ScheduledTasks.lateTime		1000	50000
com.github.kdvdolder.fortune.service.ScheduledTasks.delayedTime		0	15000

Runnable	Expression	Initial Delay	Interval
com.github.kdvdolder.fortune.service.FortuneServiceApplication.reportFortne		0	10000
com.github.kdvdolder.fortune.service.LogPing.ping		0	2000
com.github.kdvdolder.fortune.service.ScheduledTasks.reportCurrentTime		0	5000

Beans page

To go to the **Beans** page, select the **Beans** option from the **Information Category** drop-down menu. The beans page provides information about a list of all application beans and its dependencies. It displays the information about the bean type, dependencies, and its resource. You can search by the bean name or its corresponding fields.

Bean Name	Type
applicationAvailability	singleton
applicationTaskExecutor	singleton
availabilityProbesHealthEndpointGroupsPostProcessor	singleton
basicErrorController	singleton
beanNameHandlerMapping	singleton
beansEndpoint	singleton
buildInfoContributor	singleton
buildProperties	singleton
cacheAutoConfigurationValidator	singleton
cacheConfiguration	singleton
cacheManager	singleton
cacheManagerCustomizers	singleton
cacheMetricsRegistrar	singleton
cachesEndpoint	singleton
cachesEndpointWebExtension	singleton
characterEncodingFilter	singleton

Metrics page

To go to the **Metrics** page, select the **Metrics** option from the **Information Category** drop-down menu.

The metrics page provides access to application metrics information. You can choose from the list of various metrics available for the application, such as `jvm.memory.used`, `jvm.memory.max`, `http.server.request`, and so on.

After the metric is chosen, you can view the associated tags. You can choose the value of each tag based on filtering criteria. Clicking **Add Metric** adds the metric to the page which is refreshed every 5 seconds by default.

You can pause the auto refresh feature by deactivating the **Auto Refresh** toggle. You can refresh the metrics manually by clicking **Refresh All**. The format of the metric value can be changed according to your needs. They can delete a particular metric by clicking the minus symbol in the same row.

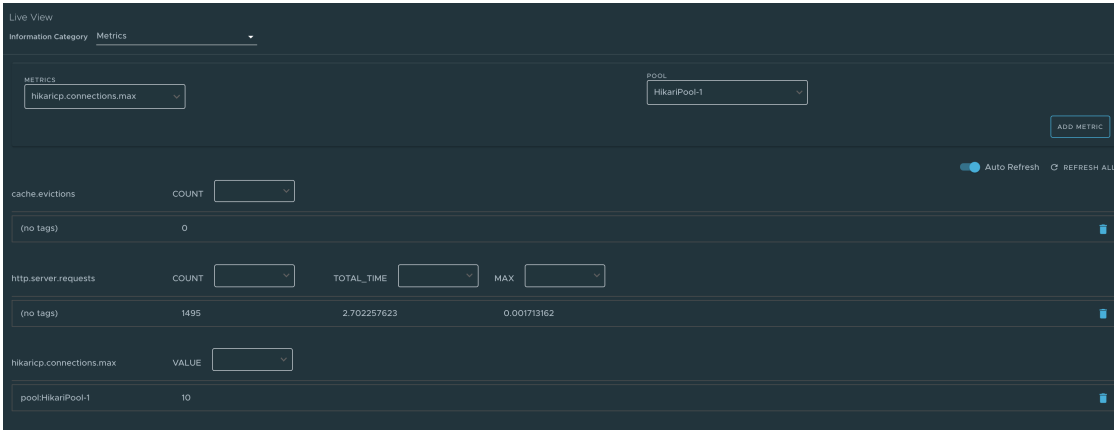

Actuator page

To go to the **Actuator** page, select the **Actuator** option from the **Information Category** drop-down menu. The actuator page provides a tree view of the actuator data. You can choose from a list of actuator endpoints and parse through the raw actuator data.

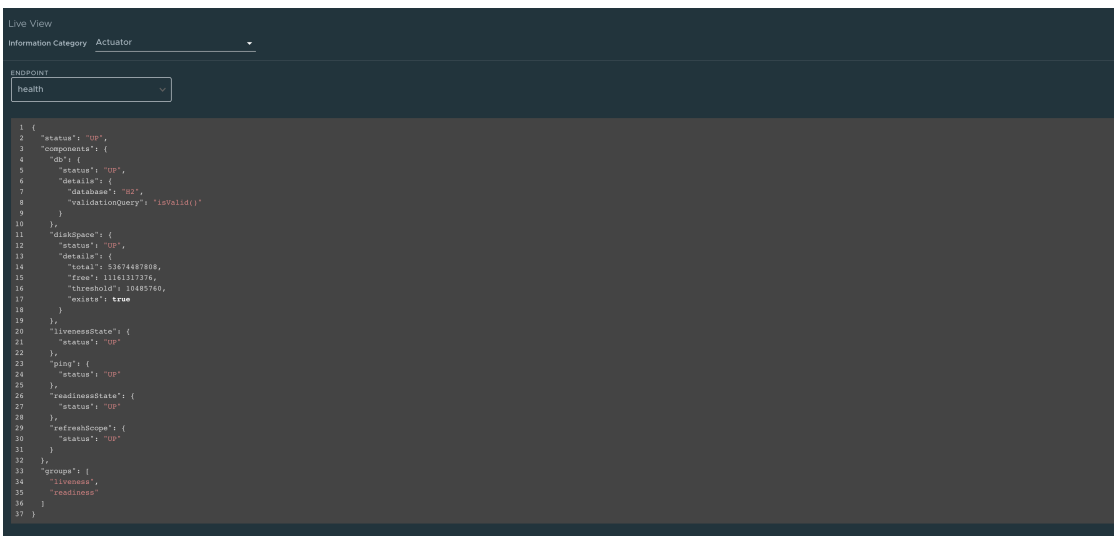

Troubleshooting

You might run into cases where a workload running on your cluster does not appear in the Application Live View overview, the detail pages do not load any information while running, or similar issues. If you encounter issues, see [Troubleshooting](#) in the Application Live View documentation.

Application Live View for Spring Cloud Gateway applications in Tanzu Developer Portal

This topic tells you about the Application Live View pages for Spring Cloud Gateway applications in Tanzu Developer Portal (formerly called Tanzu Application Platform GUI).

API Success Rate page

To access to the API Success Rate page, select the **API Success Rate** option from the **Information Category** drop-down menu.

The API success rate page displays the total successes, average response time, and maximum response time for the gateway routes. It also displays the details of each successful route path.

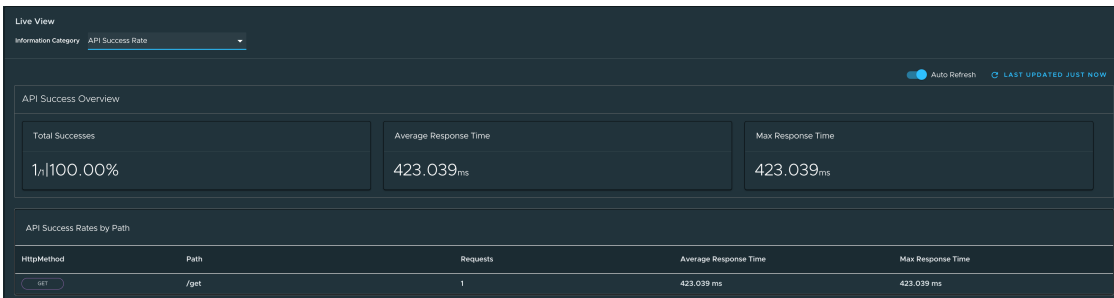

API Overview page

To access the API Overview page, select the **API Overview** option from the **Information Category** drop-down menu.

The API Overview page provides route count, number of successes, errors, and the rate-limited requests. It also provides an **auto refresh** feature to get the updated results. These metrics are depicted in a line graph.



API Authentications By Path page

To access the API Authentications By Path page, select the **API Authentications By Path** option from the **Information Category** drop-down menu.

The API Authentications By Path page displays the total requests, number of successes, and forbidden and unsuccessful authentications grouped by the HTTP method and gateway route path. The page also displays the success rate for each route.

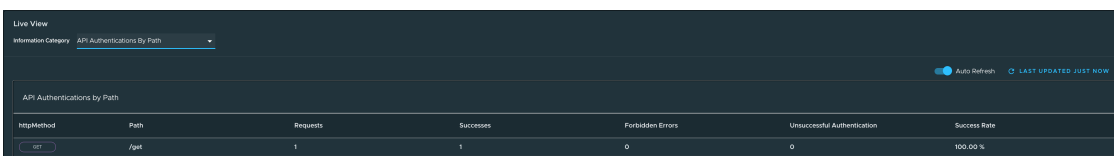

**Note**

In addition to the preceding three pages, the Spring Boot actuator pages are also displayed.

Troubleshooting

You might run into cases where a workload running on your cluster does not appear in the Application Live View overview, or the detail pages do not load any information while running, or other similar issues. For more information about such issues, see [Troubleshooting](#) in the Application Live View documentation.

Application Live View for Steeltoe applications in Tanzu Developer Portal

This topic tells you about the Application Live View pages for Steeltoe applications in Tanzu Developer Portal (formerly called Tanzu Application Platform GUI).

Details page

This is the default page loaded in the **Live View** section. This page gives a tabular overview containing the following information:

- Application name
- Instance ID
- Location
- Actuator location
- Health endpoint
- Direct actuator access
- Framework
- Version
- New patch version
- New major version
- Build version

You can navigate between **Information Categories** by selecting from the drop-down menu on the top right corner of the page.

Live View	
Information Category	Details
Application Name	steeltoe-app
Instance Name	steeltoe-app-00001-deployment-
Location	http://
Actuator Location	https:// /actuator
Health Endpoint	http:// /actuator/health
Direct Actuator Access	http:// /actuator
Framework	Steeltoe
Steeltoe Version	3.2.2.0
Build Version	1.0.0.0

Health page

To access the health page, select the **Health** option from the **Information Category** drop-down menu.

The health page provides detailed information about the health of the application. It lists all the components that make up the health of the application, such as readiness, liveness, and disk space. It displays the status and details associated with each component.



Environment page

To access the **Environment** page, select the **Environment** option from the **Information Category** drop-down menu.

The Environment page contains details of the applications' environment. It contains properties including, but not limited to, system properties, environment variables, and configuration properties (such as `appsettings.json`) in a Steeltoe application.

The page includes the following capabilities for **viewing** configured environment properties:

- The UI has a search feature that enables you to search for a property or values.
- Each property has a search icon at the right corner which helps you quickly see all the occurrences of a specific property key without manually typing in the search box. Clicking the search button locates the property name.
- The **Refresh Scope** button on the top right corner of the page probes the application to refresh all the environment properties.

The page also includes the following capabilities for **editing** configured environment properties:

- The UI allows you to edit environment properties and see the live changes in the application. These edits are temporary and go away if the underlying pod is restarted.
- For each of the configured environment properties, you can edit its value by clicking on the **Override** button in the same row. After the value is saved, you can view the message that the property was overridden from the initial value. Also, the updated property is visible in the **Applied Overrides** section at the top of the page. The **Reset** button in the same row resets the environment property to the initial state.
- You can also edit or remove the overridden environment variables in the **Applied Overrides** section.
- The **Applied Overrides** section also enables you to add new environment properties to the application.



Note

The `management.endpoint.env.post.enabled=true` must be set in the application config properties of the application, and a corresponding editable environment must be present in the application.

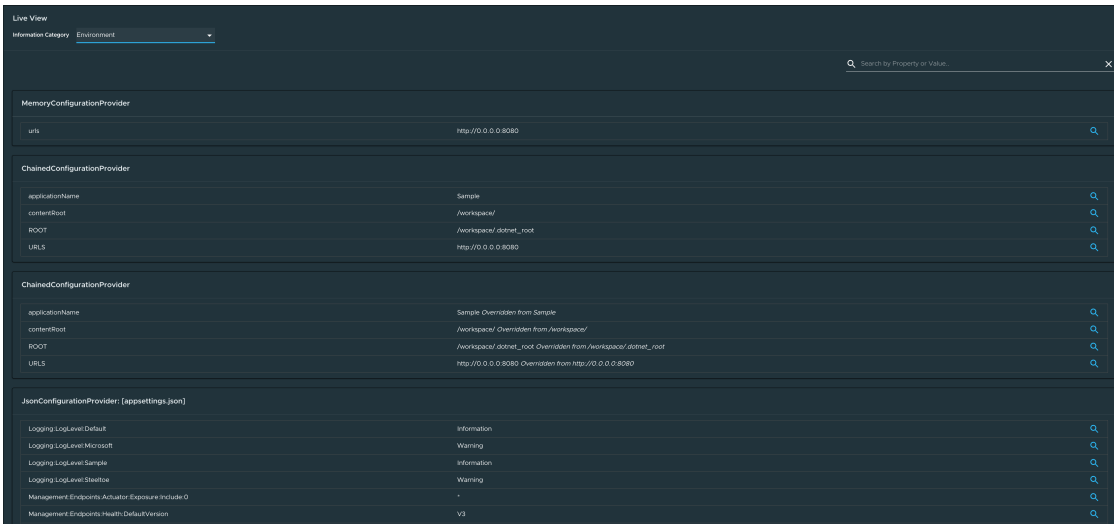

Log Levels page

To go to the **Log Levels** page, select the **Log Levels** option from the **Information Category** drop-down menu. The **Log Levels** page provides access to the application’s loggers and the configuration of the levels.

You can:

- Configure log levels, such as **INFO**, **DEBUG**, and **TRACE**, in real time from the UI
- Search for a package and edit its respective log level
- Configure the log levels at a specific class and package
- Deactivate all the log levels by changing the log level of root logger to **OFF**

Use the **Changes Only** toggle to display the changed log levels. Use the search feature to search by logger name. Click **Reset All** to reset all the loggers to the default state.

Note

The UI allows you to change the log levels and see the live changes on the application. These changes are temporary and go away if the underlying pod is restarted.

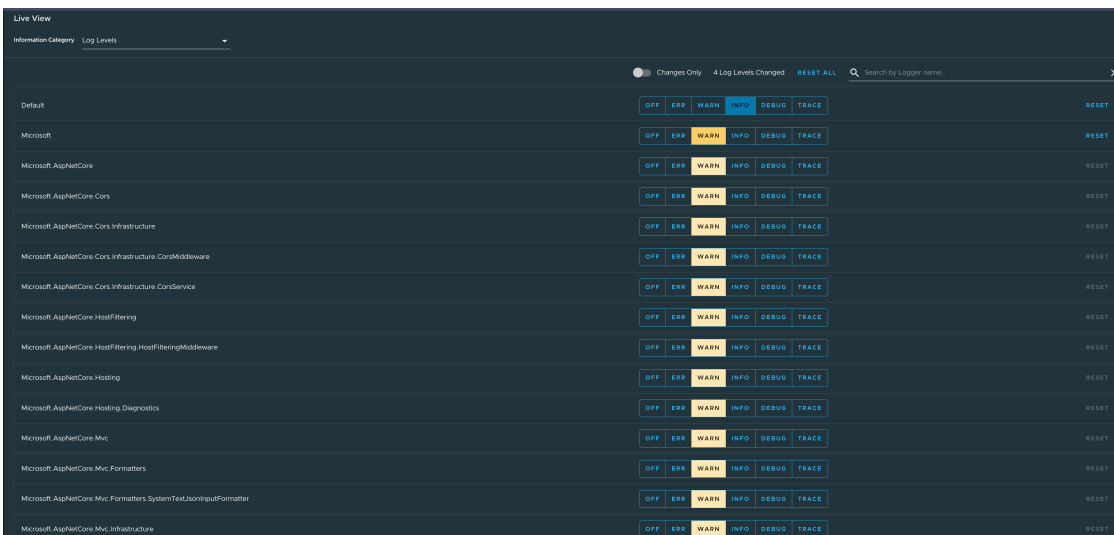

Threads page

To access the **Threads** page, select the **Threads** option from the **Information Category** drop-down menu.

This page displays all details related to CLR threads and running processes of the application. This tracks worker threads and completion port threads in real time. Navigating to a thread state displays all the information about a particular thread and its stack trace.

- The refresh icon refreshes to the latest state of the threads.
- To view more thread details, click the thread ID.
- The page has a feature to download the thread dump for analysis.
- The page has a feature to view the CPU stats for a Steeltoe application.

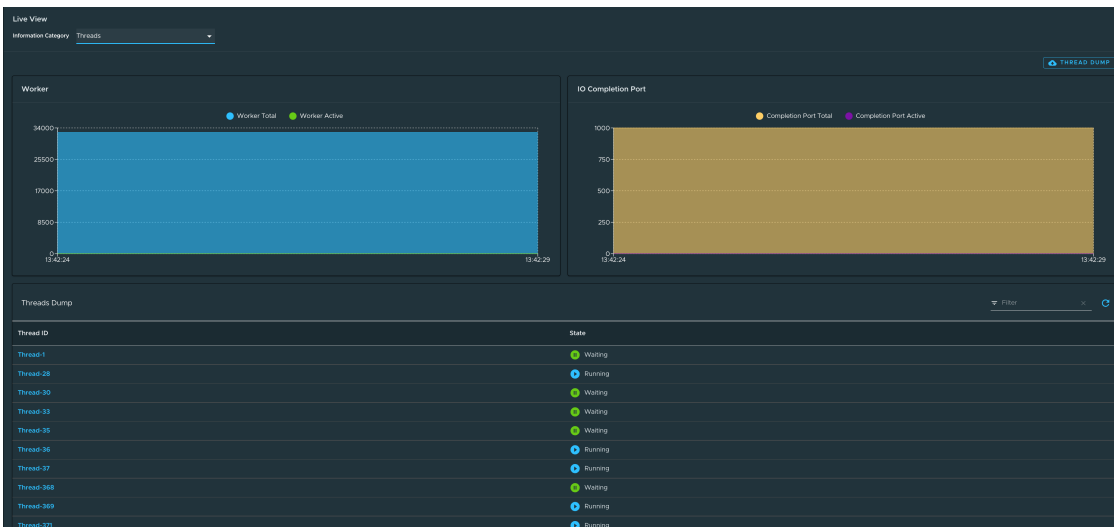

Memory page

To access the **Memory** page, select the **Memory** option from the **Information Category** drop-down menu.

This page displays all details related to used and committed memory of the application. This also displays the garbage collection count by generation (gen0/gen1). The page also has a feature to download the heap dump for analysis. The page also has a feature to view the CPU stats for a Steeltoe application

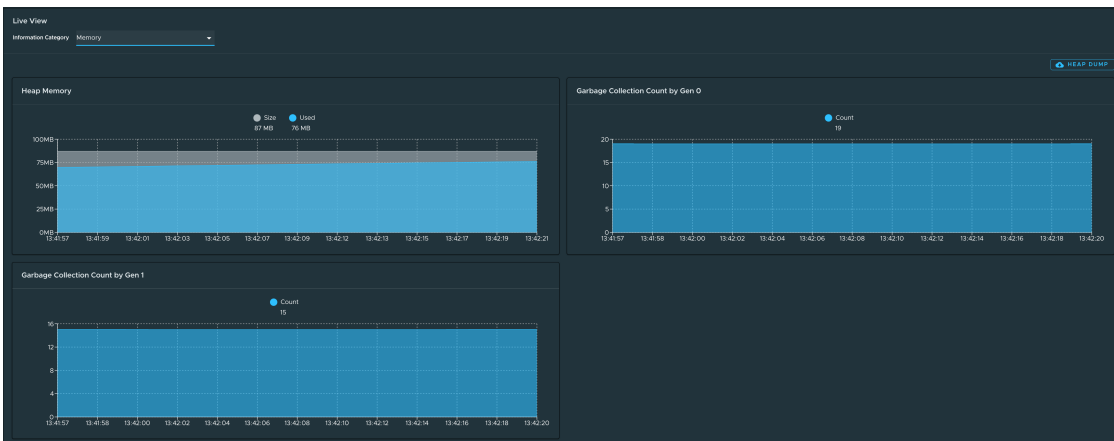

Request Mappings page

To access the **Request Mappings** page, select the **Request Mappings** option from the **Information Category** drop-down menu.

This page provides information about the application’s request mappings. For each mapping, the page displays the request handler method. You can view more details of the request mapping, such as the header metadata of the application.

When you click on the request mapping, a side panel appears. This panel contains information about the mapping-media types **Produces** and **Consumes**. The panel also displays the **Handler** class for the request. The search feature enables you to search for the request mapping or the method. The toggle **/actuator/** Request Mappings** displays the actuator-related mappings of the application.

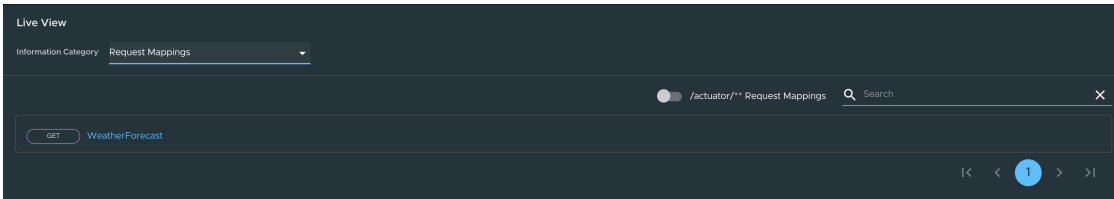

HTTP Requests page

To access the **HTTP Requests** page, select the **HTTP Requests** option from the **Information Category** drop-down menu.

The **HTTP Requests** page provides information about HTTP request-response exchanges to the application.

The graph visualizes the requests per second, which indicates the response status of all the requests. You can filter by the response statuses, which include **info**, **success**, **redirects**, **client-errors**, and **server-errors**. The trace data is captured in detail in a tabular format with metrics, such as **timestamp**, **method**, **path**, **status**, **content-type**, **length**, and **time**.

The search feature on the table filters the traces based on the search text box value. By clicking on the timestamp, you can view more details of the request, such as method, headers, and the response of the application.

The refresh icon above the graph loads the latest traces of the application. The toggle **/actuator/**** on the top-right corner of the page displays the actuator-related traces of the application.

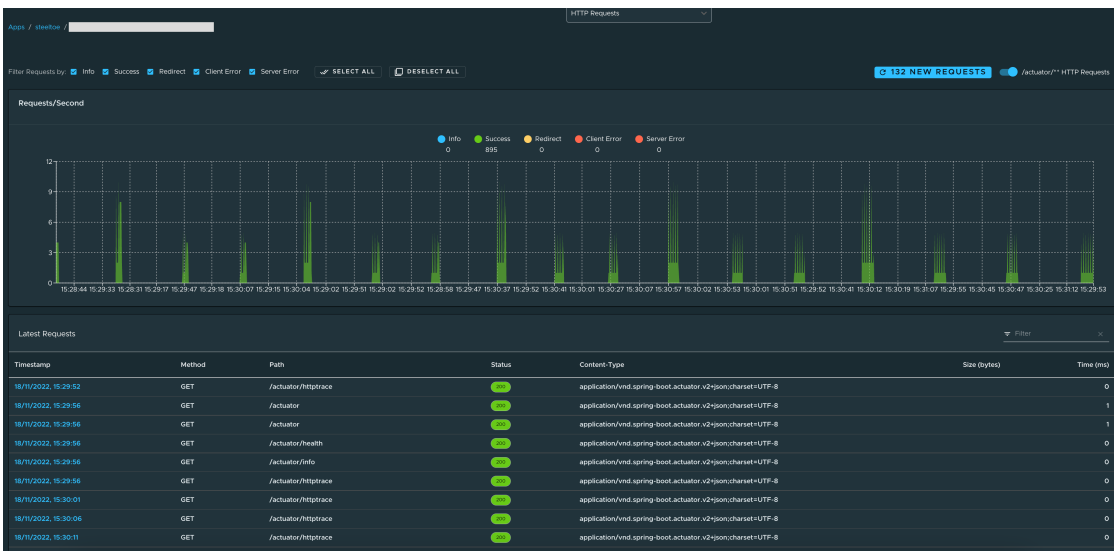

Metrics page

This topic tells you how to use Application Accelerator in Tanzu Developer Portal (formerly called Tanzu Application Platform GUI).

Overview

Application Accelerator for VMware Tanzu helps you bootstrap developing and deploying your applications in a discoverable and repeatable way.

Enterprise architects author and publish accelerator projects that provide developers and operators with ready-made, enterprise-conforming code and configurations. You can then use Application Accelerator to create new projects based on those accelerator projects.

The Application Accelerator UI enables you to discover available accelerators, configure them, and generate new projects to download.

Access Application Accelerator

To open the Application Accelerator UI plug-in and select an accelerator:

1. Within Tanzu Application Platform, click **Create** in the left navigation pane to open the **Accelerators** page.

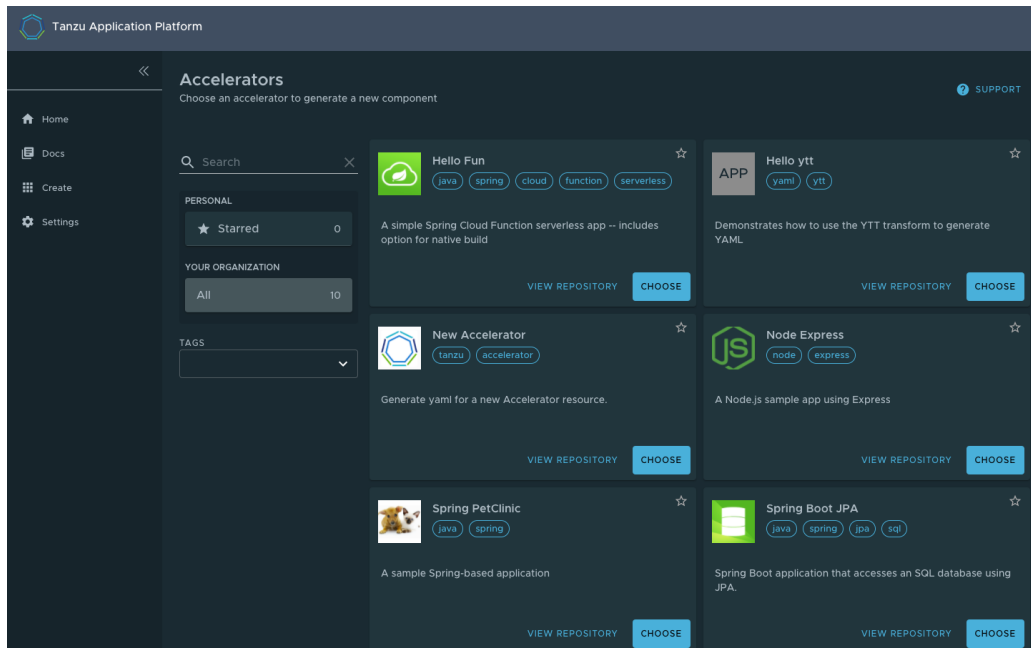

Here you can view accelerators already registered with the system. Developers can add new accelerators by registering them with Kubernetes.

2. Every accelerator has a title and short description. Click **VIEW REPOSITORY** to view an accelerator definition. This opens the accelerator's Git repository in a new browser tab.
3. Search and filter based on text and tags associated with the accelerators to find the accelerator representing the project you want to create.
4. Click **CHOOSE** for the accelerator you want. This opens the **Generate Accelerators** page.

Configure project generation

To configure how projects are generated:

1. On the **Generate Accelerators** page, add any configuration values needed to generate the project. The application architect defined these values in `accelerator.yaml` in the

accelerator definition. Filling some text boxes can cause other text boxes to appear. Fill them all in.

2. Click **EXPLORE** to open the **Explore Project** page and view the project before it is generated.
3. After configuring your project, click **NEXT STEP** to see the project summary page.
4. Review the values you specified for the configurable options.
5. Click **BACK** to make more changes, if necessary. Otherwise, proceed to [create the project](#).

Create the project

To create the project:

1. Click **Create** to start generating your project. See the progress on the **Task Activity** page. A detailed log is displayed on the right.

2. After the project is generated, click **EXPLORE ZIP FILE** to open the **Explore Project** page to verify configuration.
3. Click **DOWNLOAD ZIP FILE** to download the project in a ZIP file.

Develop your code

To develop your code:

1. Expand the ZIP file.

2. Open the project in your integrated development environment (IDE).

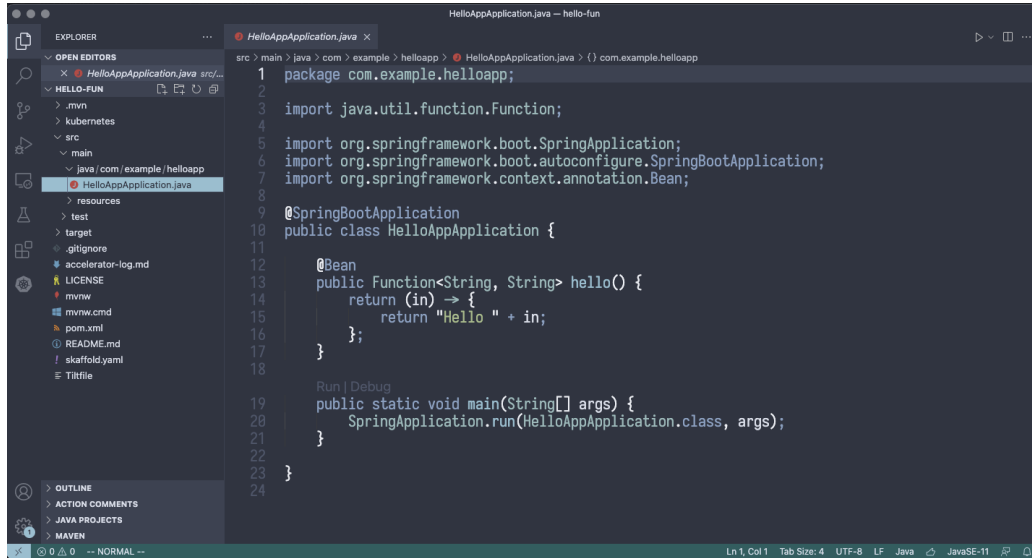

```

1 package com.example.helloapp;
2
3 import java.util.function.Function;
4
5 import org.springframework.boot.SpringApplication;
6 import org.springframework.boot.autoconfigure.SpringBootApplication;
7 import org.springframework.context.annotation.Bean;
8
9 @SpringBootApplication
10 public class HelloAppApplication {
11
12     @Bean
13     public Function<String, String> hello() {
14         return (in) -> {
15             return "Hello " + in;
16         };
17     }
18
19     Run | Debug
20     public static void main(String[] args) {
21         SpringApplication.run(HelloAppApplication.class, args);
22     }
23 }
24

```

Next steps

To learn more about Application Accelerator for VMware Tanzu, see the [Application Accelerator documentation](#).

Application Accelerator in Tanzu Developer Portal

This topic tells you how to use Application Accelerator in Tanzu Developer Portal (formerly called Tanzu Application Platform GUI).

Overview

Application Accelerator for VMware Tanzu helps you bootstrap developing and deploying your applications in a discoverable and repeatable way.

Enterprise architects author and publish accelerator projects that provide developers and operators with ready-made, enterprise-conforming code and configurations. You can then use Application Accelerator to create new projects based on those accelerator projects.

The Application Accelerator UI enables you to discover available accelerators, configure them, and generate new projects to download.

Access Application Accelerator

To open the Application Accelerator UI plug-in and select an accelerator:

1. Within Tanzu Application Platform, click **Create** in the left navigation pane to open the **Accelerators** page.

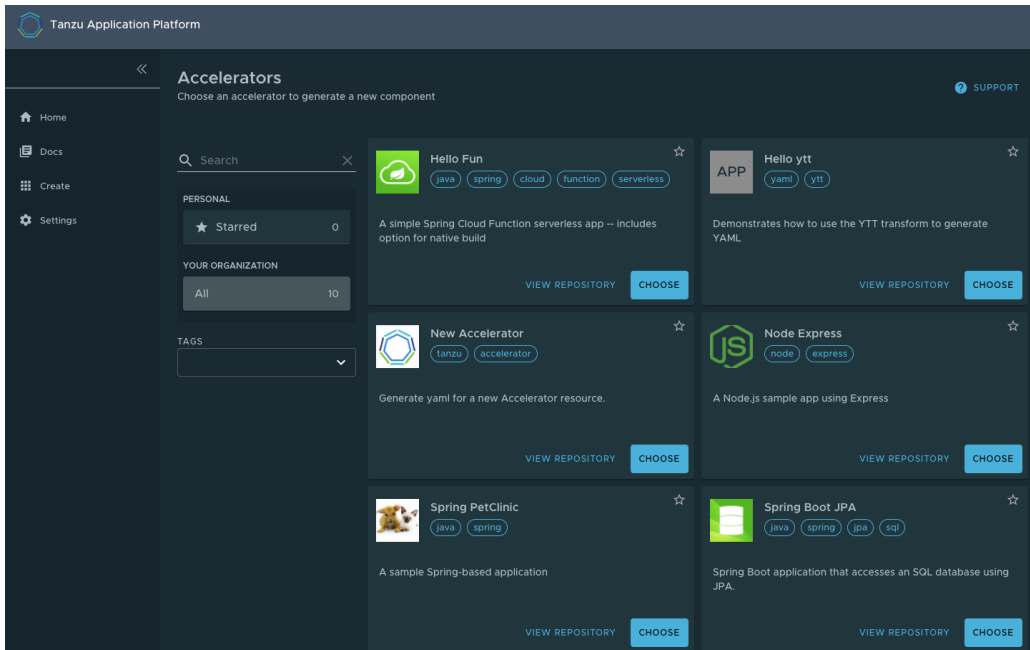

Here you can view accelerators already registered with the system. Developers can add new accelerators by registering them with Kubernetes.

2. Every accelerator has a title and short description. Click **VIEW REPOSITORY** to view an accelerator definition. This opens the accelerator’s Git repository in a new browser tab.
3. Search and filter based on text and tags associated with the accelerators to find the accelerator representing the project you want to create.
4. Click **CHOOSE** for the accelerator you want. This opens the **Generate Accelerators** page.

Configure project generation

To configure how projects are generated:

1. On the **Generate Accelerators** page, add any configuration values needed to generate the project. The application architect defined these values in `accelerator.yaml` in the accelerator definition. Filling some text boxes can cause other text boxes to appear. Fill them all in.

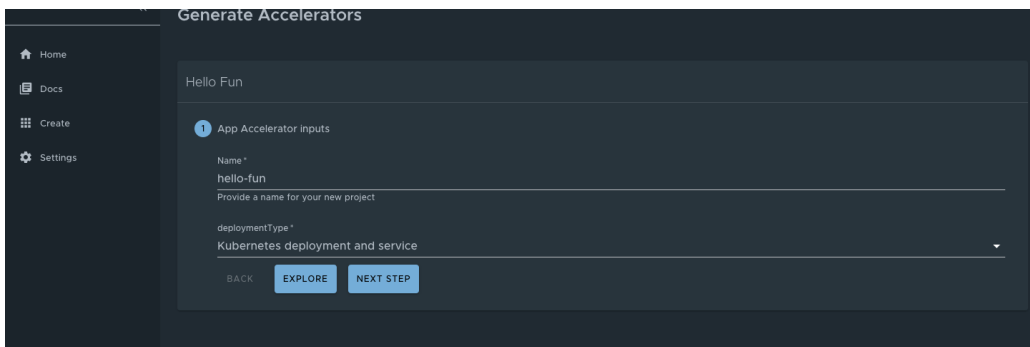

2. Click **EXPLORE** to open the **Explore Project** page and view the project before it is generated.
3. After configuring your project, click **NEXT STEP** to see the project summary page.
4. Review the values you specified for the configurable options.
5. Click **BACK** to make more changes, if necessary. Otherwise, proceed to [create the project](#).

Create the project

To create the project:

1. Click **Create** to start generating your project. See the progress on the **Task Activity** page. A detailed log is displayed on the right.

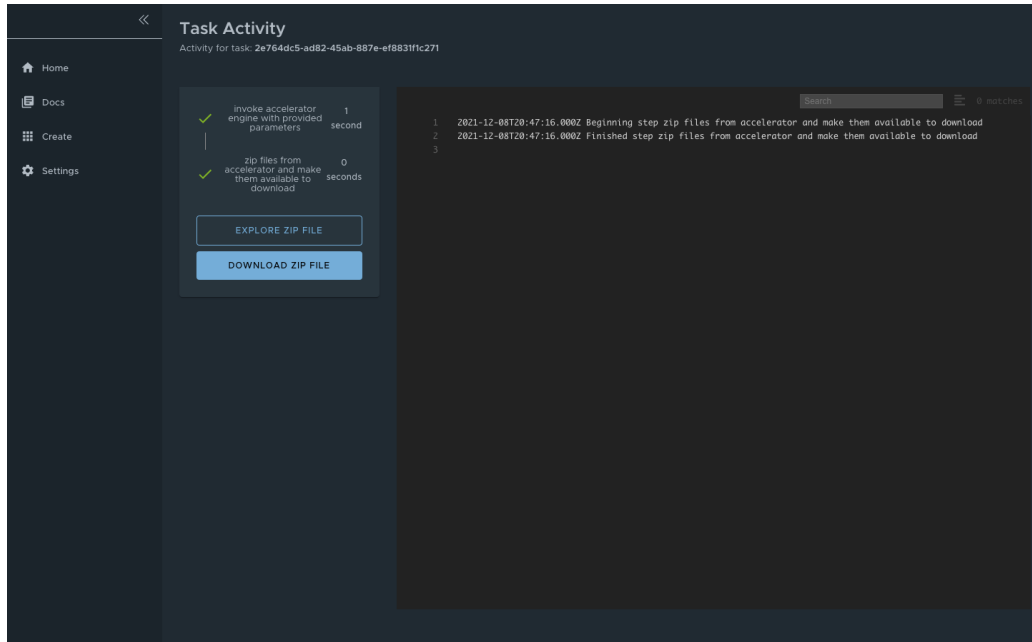

2. After the project is generated, click **EXPLORE ZIP FILE** to open the **Explore Project** page to verify configuration.
3. Click **DOWNLOAD ZIP FILE** to download the project in a ZIP file.

Develop your code

To develop your code:

1. Expand the ZIP file.
2. Open the project in your integrated development environment (IDE).

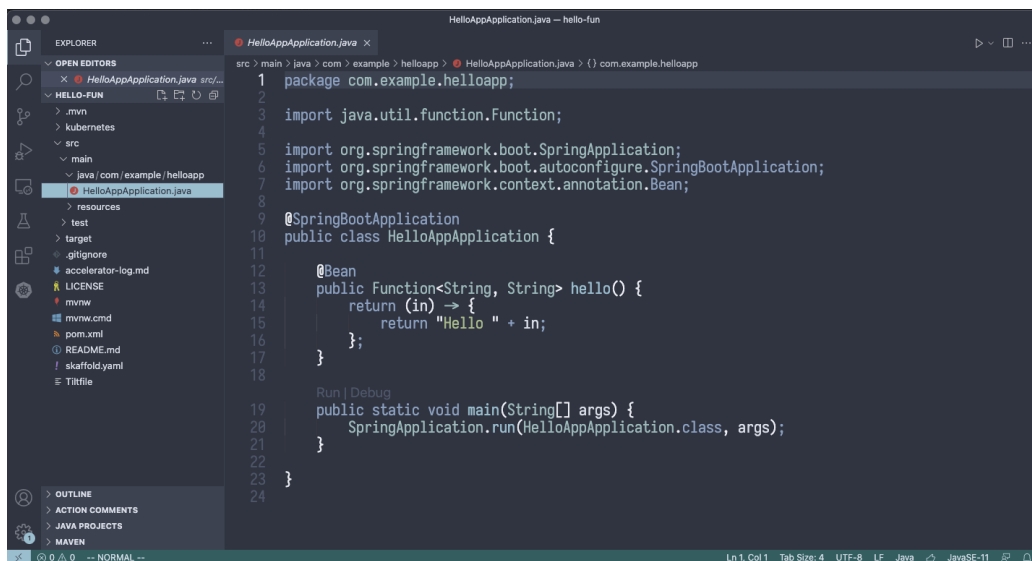

Next steps

To learn more about Application Accelerator for VMware Tanzu, see the [Application Accelerator documentation](#).

Install Application Accelerator

This topic tells you how to install Application Accelerator from the Tanzu Application Platform (commonly known as TAP) package repository.



Note

Follow the steps in this topic if you do not want to use a profile to install Application Accelerator. For more information about profiles, see [About Tanzu Application Platform components and profiles](#).

Prerequisites

Before installing Application Accelerator:

- Complete all prerequisites to install Tanzu Application Platform. For more information, see [Prerequisites](#).
- Install Flux SourceController on the cluster. See [Install Flux CD Source Controller](#).
- Install Source Controller on the cluster. See [Install Source Controller](#).

Install

To install Application Accelerator:

1. List version information for the package by running:

```
tanzu package available list accelerator.apps.tanzu.vmware.com --namespace tap-install
```

For example:

```
$ tanzu package available list accelerator.apps.tanzu.vmware.com --namespace tap-install

- Retrieving package versions for accelerator.apps.tanzu.vmware.com...
NAME                                VERSION  RELEASED-AT
accelerator.apps.tanzu.vmware.com  1.4.0    2022-12-08 12:00:00 -0500 EST
```

2. (Optional) View the changes you can make to the default installation settings by running:

```
tanzu package available get accelerator.apps.tanzu.vmware.com/VERSION-NUMBER \
--values-schema \
--namespace tap-install
```

Where **VERSION-NUMBER** is the version of the Application Accelerator package listed earlier.

For example:

```
$ tanzu package available get accelerator.apps.tanzu.vmware.com/1.4.0 \
--values-schema \
--namespace tap-install
```

For more information about values schema options, see the properties listed in [Configure properties and resource use](#) later.

3. Create a file named `app-accelerator-values.yaml` using the following example code:

```
server:
  service_type: "LoadBalancer"
  watched_namespace: "accelerator-system"
samples:
  include: true
```

4. Edit the values in your `app-accelerator-values.yaml` if needed, or leave the default values. You can add values you want from [Configure properties and resource use](#).
5. Install the package by running:

```
tanzu package install app-accelerator \
  --package accelerator.apps.tanzu.vmware.com \
  --version VERSION-NUMBER \
  --namespace tap-install \
  --values-file app-accelerator-values.yaml
```

Where `VERSION-NUMBER` is the version of the Application Accelerator package listed earlier.

For example:

```
$ tanzu package install app-accelerator \
  --package accelerator.apps.tanzu.vmware.com \
  --version 1.4.0 \
  --namespace tap-install \
  --values-file app-accelerator-values.yaml

- Installing package 'accelerator.apps.tanzu.vmware.com'
| Getting package metadata for 'accelerator.apps.tanzu.vmware.com'
| Creating service account 'app-accelerator-tap-install-sa'
| Creating cluster admin role 'app-accelerator-tap-install-cluster-role'
| Creating cluster role binding 'app-accelerator-tap-install-cluster-rolebinding'
| Creating secret 'app-accelerator-tap-install-values'
- Creating package resource
- Package install status: Reconciling

Added installed package 'app-accelerator' in namespace 'tap-install'
```

6. Verify the package install by running:

```
tanzu package installed get app-accelerator -n tap-install
```

For example:

```
$ tanzu package installed get app-accelerator -n tap-install

| Retrieving installation details for cc...
NAME:                app-accelerator
PACKAGE-NAME:        accelerator.apps.tanzu.vmware.com
PACKAGE-VERSION:     1.4.0
STATUS:              Reconcile succeeded
CONDITIONS:          [{"ReconcileSucceeded True  }]
USEFUL-ERROR-MESSAGE:
```

Verify that `STATUS` is `Reconcile succeeded`.

7. To see the IP address for the Application Accelerator API when the `server.service_type` is set to `LoadBalancer`, run:

```
kubectl get service -n accelerator-system
```

This lists an external IP address for use with the `--server-url` Tanzu CLI flag for the Accelerator plug-in `generate & generate-from-local` command.

For how to troubleshoot installation issues, see [Troubleshoot Application Accelerator](#).

Configure properties and resource use

When you install the Application Accelerator, you can configure the following optional properties from within your `app-accelerator-values.yaml` configuration file:

Property	Default	Description
<code>registry.secret_ref</code>	<code>reg-creds</code>	The secret used for accessing the registry where the App-Accelerator images are located
<code>server.service_type</code>	<code>ClusterIP</code>	The service type for the acc-ui-server service including LoadBalancer, NodePort, or ClusterIP
<code>server.watched_namespace</code>	<code>accelerator-system</code>	The namespace the server watches for accelerator resources
<code>server.engine_invocation_url</code>	<code>http://acc-engine.accelerator-system.svc.cluster.local/invocations</code>	The URL to use for invoking the accelerator engine
<code>engine.service_type</code>	<code>ClusterIP</code>	The service type for the acc-engine service including LoadBalancer, NodePort, or ClusterIP
<code>engine.max_direct_memory_size</code>	<code>32M</code>	The maximum size for the Java -XX:MaxDirectMemorySize setting
<code>samples.include</code>	<code>True</code>	Option to include the bundled sample Accelerators in the installation
<code>ingress.include</code>	<code>False</code>	Option to include the ingress configuration in the installation
<code>ingress.enable_tls</code>	<code>False</code>	Option to include TLS for the ingress configuration
<code>domain</code>	<code>tap.example.com</code>	Top-level domain to use for ingress configuration, default is <code>shared.ingress_domain</code>
<code>tls.secret_name</code>	<code>tls</code>	The name of the secret
<code>tls.namespace</code>	<code>tanzu-system-ingress</code>	The namespace for the secret
<code>telemetry.retain_invocation_events_for_days</code>	<code>30</code>	The number of days to retain recorded invocation events resources
<code>telemetry.record_invocation_events</code>	<code>true</code>	The system records each engine invocation when generating files for an accelerator?
<code>git_credentials.secret_name</code>	<code>git-credentials</code>	The name to use for the secret storing Git credentials for accelerators
<code>git_credentials.username</code>	<code>null</code>	The user name to use in secret storing Git credentials for accelerators
<code>git_credentials.password</code>	<code>null</code>	The password to use in secret storing Git credentials for accelerators

Property	Default	Description
<code>git_credentials.ca_file</code>	<code>null</code>	The CA certificate data to use in secret storing Git credentials for accelerators
<code>managed_resources.enabled</code>	<code>false</code>	Whether to enable the App used to control managed accelerator resources
<code>managed_resources.git.url</code>	<code>none</code>	Required if managed_resources are enabled. Git repository URL containing manifests for managed accelerator resources
<code>managed_resources.git.ref</code>	<code>origin/main</code>	Required if managed_resources are enabled. Git ref to use for repository containing manifests for managed accelerator resources
<code>managed_resources.git.sub_path</code>	<code>null</code>	Git subPath to use for repository containing manifests for managed accelerator resources
<code>managed_resources.git.secret_ref</code>	<code>git-credentials</code>	Secret name to use for repository containing manifests for managed accelerator resources

VMware recommends that you do not override the default setting for `registry.secret_ref`, `server.engine_invocation_url`, or `engine.service_type`. These properties are only used to configure non-standard installations.

The following table is the resource use configurations for the components of Application Accelerator.

Component	Resource requests	Resource limits
acc-controller	CPU: 100m memory: 20Mi	CPU: 100m memory: 30Mi
acc-server	CPU: 100m memory: 20Mi	CPU: 100m memory: 30Mi
acc-engine	CPU: 500m memory: 1Gi	CPU: 500m memory: 2Gi

Create an Application Accelerator Git repository during project creation

This topic tells you how to enable and use GitHub repository creation in the Application Accelerator plug-in of Tanzu Developer Portal (formerly called Tanzu Application Platform GUI).

Overview

The Application Accelerator plug-in uses the Backstage GitHub provider integration and the authentication mechanism to retrieve an access token. Then it can interact with the provider API to create GitHub repositories.

Supported Providers

The supported Git providers are GitHub and GitLab.



Note

To create a repository in a self-hosted GitLab, you must add a custom GitLab integration in `tap-values.yaml` as described in the [Full Profile sample](#).

Configure

The following steps describe an example configuration that uses GitHub:

1. Create an **OAuth App** in GitHub based on the configuration described in this [Backstage documentation](#). GitHub Apps are not supported. For more information about creating an OAuth App in GitHub, see the [GitHub documentation](#).

These values appear in your `app-config.yaml` or `app-config.local.yaml` for local development. For example:

```
auth:
  environment: development
  providers:
    github:
      development:
        clientId: GITHUB-CLIENT-ID
        clientSecret: GITHUB-CLIENT-SECRET
```

2. Add a GitHub integration in your `app-config.yaml` configuration. For example:

```
app_config:
  integrations:
    github:
      - host: github.com
```

For more information, see the [Backstage documentation](#).

(Optional) Deactivate Git repository creation

As of Tanzu Application Platform v1.5, you can deactivate Git repository creation by setting the property `customize.features.accelerators.gitRepoCreation` to `false` in `tap-values.yaml`. This also deactivates Git repository creation in the Application Accelerator extension for VS Code.

See the following example configuration for deactivating Git repository creation:

```
app_config:
  customize:
    features:
      accelerators:
        gitRepoCreation: false
```

Create a Project

To create a project:

1. Go to Tanzu Developer Portal, access the Accelerators section, and then select an accelerator. The accelerator form now has a second step named **Git repository**.
2. Fill in the accelerator options and click **Next**.
3. Select the **Create Git repo?** check box.
4. Fill in the **Owner**, **Repository**, and **Default Branch** text boxes.

Git repository

Create Git repo?

Host

github.com

The host where the repository will be created

Owner *

The organization, user or project that this repo will belong to

Repository *

The name of the repository

Default Branch

master

BACK NEXT

5. After entering the repository name, a dialog box appears that requests GitHub credentials. Log in and then click **Next**.
6. Click **GENERATE ACCELERATOR**. A link to the repository location appears.

invoke accelerator engine with provided parameters 1 second

Create github repo 6 seconds

Create gitlab repo Skipped

Create bitbucketCloud repo Skipped

zip files from accelerator and make them available to download 0 seconds

REPOSITORY

EXPLORE ZIP FILE

DOWNLOAD ZIP FILE

START OVER

API documentation plug-in in Tanzu Developer Portal

This topic gives you an overview of the API documentation plug-in of Tanzu Developer Portal (formerly called Tanzu Application Platform GUI). For more information, see [Get started with the API documentation plug-in](#).

Overview

The API documentation plug-in provides a standalone list of APIs that can be connected to components and systems of the Tanzu Developer Portal software catalog.

Each API entity can reflect the components that provide that API and the list of components that are consumers of that API. Also, an API entity can be associated with systems and appear on the system diagram. To show this dependency, make the `spec.providesApis:` and `spec.consumesApis:` sections of the component definition files reference the name of the API entity.

Here's a sample of how you can add `providesApis` and `consumesApis` to an existing component's catalog definition, linking them together.

```
apiVersion: backstage.io/v1alpha1
kind: Component
metadata:
  name: example-component
  description: Example Component
spec:
  type: service
  lifecycle: experimental
  owner: team-a
  system: example-system
  providesApis: # list of APIs provided by the Component
    - example-api-1
  consumesApis: # list of APIs consumed by the Component
    - example-api-2
```

For more information about the structure of the definition file for an API entity, see the [Backstage Kind: API documentation](#). For more information about the API documentation plug-in, see the [Backstage API documentation](#) in GitHub.

Use the API documentation plug-in

The API documentation plug-in is part of Tanzu Developer Portal.

The first way to use the API documentation plug-in is API-first. Click **APIs** in the left navigation pane of Tanzu Developer Portal. This opens the **API catalog page**.

Name	System	Owner	Type	Lifecycle	Description	Tags	Actions
demo-api	demo-app	demo-team	openapi	experimental	The demo...		🔗 ✎ ☆
hello-world		team-c	grpc	deprecated	Hello World...		🔗 ✎ ☆
petstore		team-c	openapi	experimental	The petstore...	store test	🔗 ✎ ☆
spotify		team-a	openapi	production	The Spotify...	spotify test	🔗 ✎ ☆
starwars-graphql		team-b	graphql	production	SWAPI...		🔗 ✎ ☆
streetlights		team-c	asynapi	production	The...	test	🔗 ✎ ☆
wayback-archive		team-a	openapi	production	Archive API...		🔗 ✎ ☆
wayback-search		team-a	openapi	production	Search API...		🔗 ✎ ☆

On that page, you can view all the APIs already registered in the catalog regardless of whether they are associated with components or systems.

The second way to use the API documentation plug-in is to use components and systems of the software catalog, listed on the home page of Tanzu Developer Portal. If there is an API entity associated with the selected component or system, the **VIEW API** icon is active.

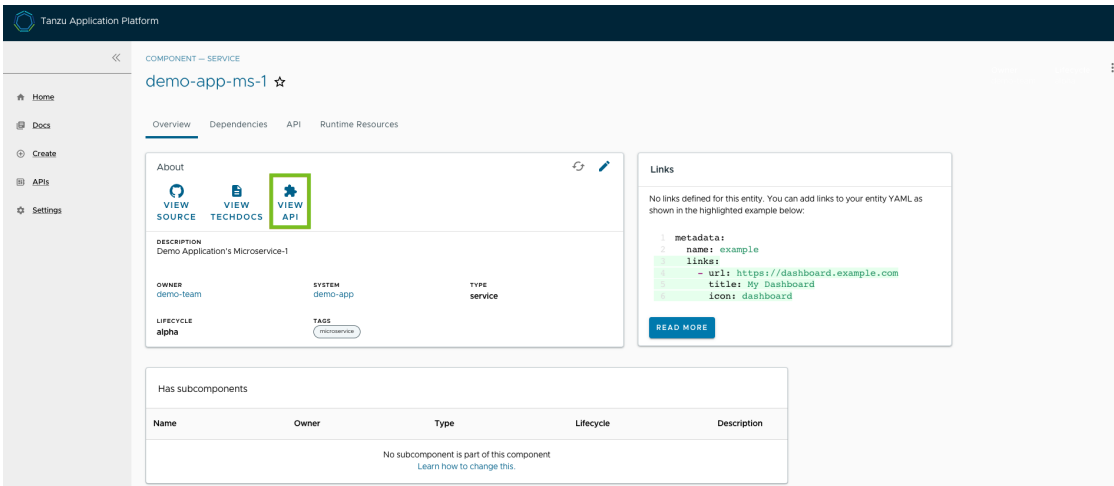

The **VIEW API** tab displays which APIs are being consumed by a component and which APIs are being provided by the component.

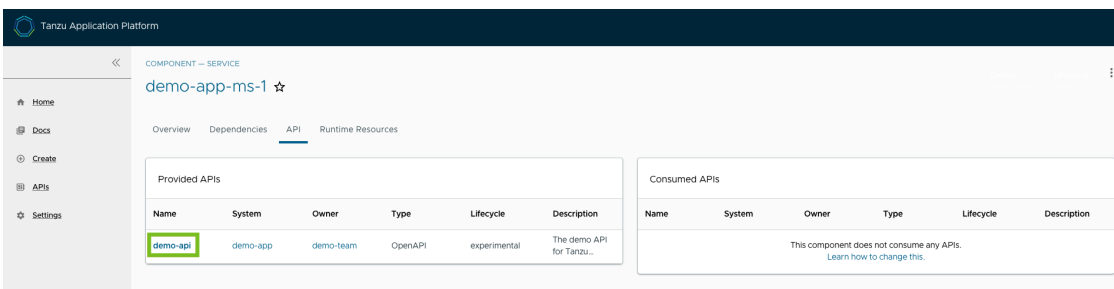

Clicking on the API itself takes you to the catalog entry for the API, which the Kind type listed in the upper-left corner denotes. Every API entity has a title and short description, including a reference to the team that owns the definition of that API and the software catalog objects that are connected to it.

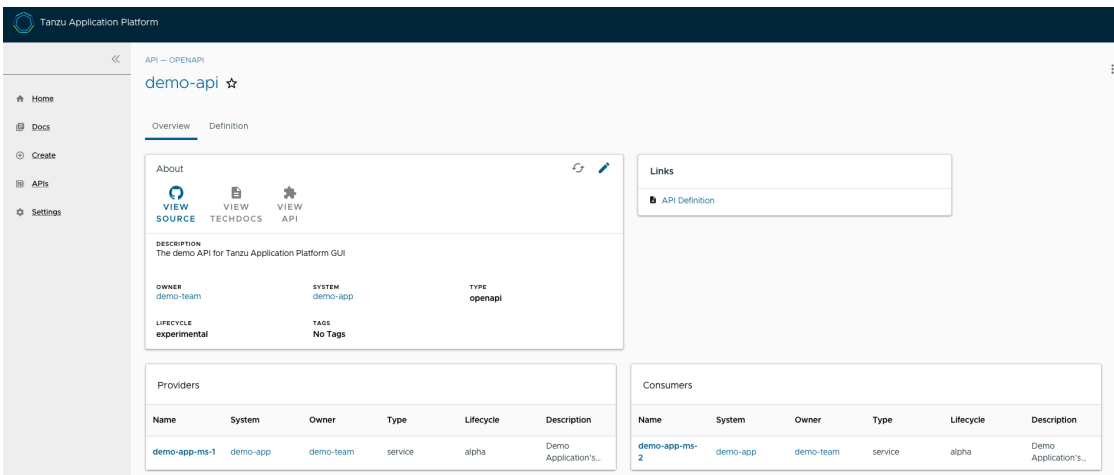

Select the **Definition** tab on the top of the API page to see the definition of that API in human-readable and machine-readable format.

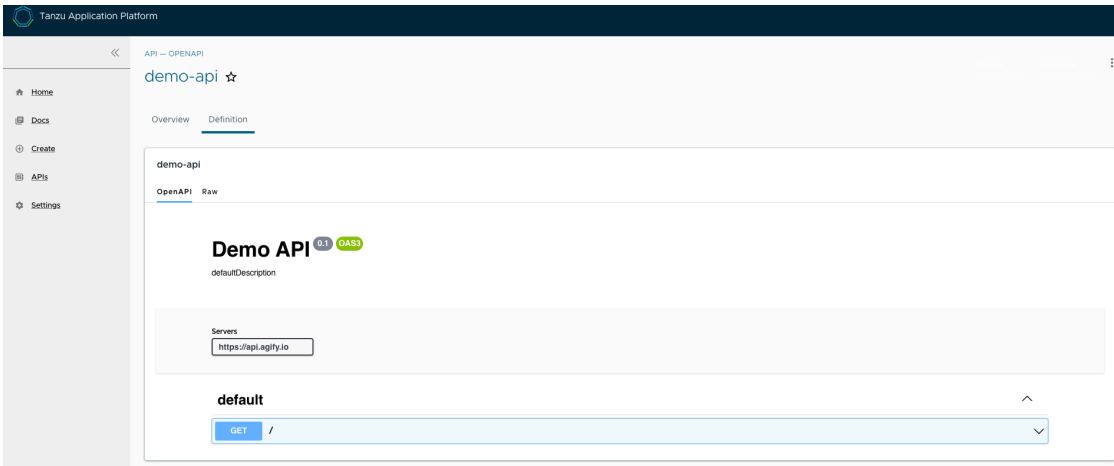

The API documentation plug-in supports the following API formats:

- OpenAPI 2 & 3
- AsyncAPI
- GraphQL
- Plain (to support any other format)

Create a new API entry

You can create a new API entry manually or automatically.

Manually create a new API entry

Manually creating a new API entity is similar to registering any other software catalog entity. To manually create a new API entity:

1. Click the **Home** button on the left navigation pane to access the home page of Tanzu Developer Portal.
2. Click **REGISTER ENTITY**.
3. **Register an existing component** prompts you to type a repository URL. Paste the link to the `catalog-info.yaml` file of your choice that contains the definition of your API entity. For example, you can copy the following YAML content and save it as `catalog-info.yaml` on a Git repository of your choice.

```
apiVersion: backstage.io/v1alpha1
kind: API
metadata:
  name: demo-api
  description: The demo API for Tanzu Developer Portal
  links:
    - url: https://api.agify.io
      title: API Definition
      icon: docs
spec:
  type: openapi
  lifecycle: experimental
  owner: demo-team
  system: demo-app # Or specify system name of your choice
  definition: |
    openapi: 3.0.1
    info:
      title: defaultTitle
      description: defaultDescription
```

```

version: '0.1'
servers:
  - url: https://api.agify.io
paths:
  /:
    get:
      description: Auto generated using Swagger Inspector
      parameters:
        - name: name
          in: query
          schema:
            type: string
          example: type_any_name
      responses:
        '200':
          description: Auto generated using Swagger Inspector
          content:
            application/json; charset=utf-8:
              schema:
                type: string
              examples: {}

```

4. Click **ANALYZE** and then review the catalog entities to be added.

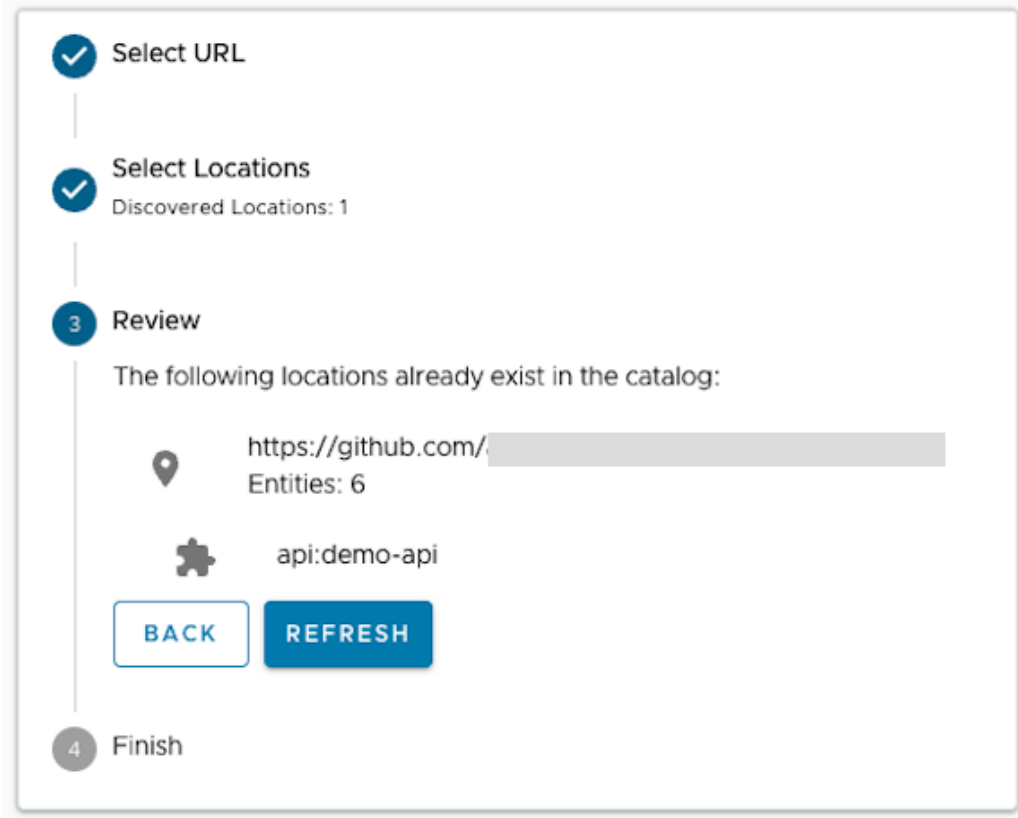

5. Click **IMPORT**.
6. Click **APIs** on the left navigation pane to view entries on the **API** page.

Automatically create a new API entry

Tanzu Application Platform v1.3 introduced a feature called **API Auto Registration** that can automatically register your APIs. For more information, see [API Auto Registration](#).

API documentation plug-in in Tanzu Developer Portal

This topic gives you an overview of the API documentation plug-in of Tanzu Developer Portal (formerly called Tanzu Application Platform GUI). For more information, see [Get started with the API documentation plug-in](#).

Overview

The API documentation plug-in provides a standalone list of APIs that can be connected to components and systems of the Tanzu Developer Portal software catalog.

Each API entity can reflect the components that provide that API and the list of components that are consumers of that API. Also, an API entity can be associated with systems and appear on the system diagram. To show this dependency, make the `spec.providesApis:` and `spec.consumesApis:` sections of the component definition files reference the name of the API entity.

Here's a sample of how you can add `providesApis` and `consumesApis` to an existing component's catalog definition, linking them together.

```
apiVersion: backstage.io/v1alpha1
kind: Component
metadata:
  name: example-component
  description: Example Component
spec:
  type: service
  lifecycle: experimental
  owner: team-a
  system: example-system
  providesApis: # list of APIs provided by the Component
    - example-api-1
  consumesApis: # list of APIs consumed by the Component
    - example-api-2
```

For more information about the structure of the definition file for an API entity, see the [Backstage Kind: API documentation](#). For more information about the API documentation plug-in, see the [Backstage API documentation](#) in GitHub.

Use the API documentation plug-in

The API documentation plug-in is part of Tanzu Developer Portal.

The first way to use the API documentation plug-in is API-first. Click **APIs** in the left navigation pane of Tanzu Developer Portal. This opens the **API catalog page**.

The screenshot shows the 'APIs' page in the Tanzu Developer Portal. The left sidebar contains navigation options: Home, Docs, Create, APIs, and Settings. The main content area displays a table of APIs. The table has columns for Name, System, Owner, Type, Lifecycle, Description, Tags, and Actions. The 'demo-api' entry is highlighted in green. Below the table, there are filters for Type, Personal (Owned, Starred), Your Organization (All), Owner, Lifecycle, and Tags.

Name	System	Owner	Type	Lifecycle	Description	Tags	Actions
demo-api	demo-app	demo-team	openapi	experimental	The demo...		🔗 ✎ ☆
hello-world		team-c	grpc	deprecated	Hello World...		🔗 ✎ ☆
petstore		team-c	openapi	experimental	The petstore...	store rest	🔗 ✎ ☆
spotify		team-a	openapi	production	The Spotify...	spotify rest	🔗 ✎ ☆
starwars-graphql		team-b	graphql	production	SWAPI...		🔗 ✎ ☆
streetlights		team-c	asynapi	production	The...	rest	🔗 ✎ ☆
wayback-archive		team-a	openapi	production	Archive API...		🔗 ✎ ☆
wayback-search		team-a	openapi	production	Search API...		🔗 ✎ ☆

On that page, you can view all the APIs already registered in the catalog regardless of whether they are associated with components or systems.

The second way to use the API documentation plug-in is to use components and systems of the software catalog, listed on the home page of Tanzu Developer Portal. If there is an API entity associated with the selected component or system, the **VIEW API** icon is active.

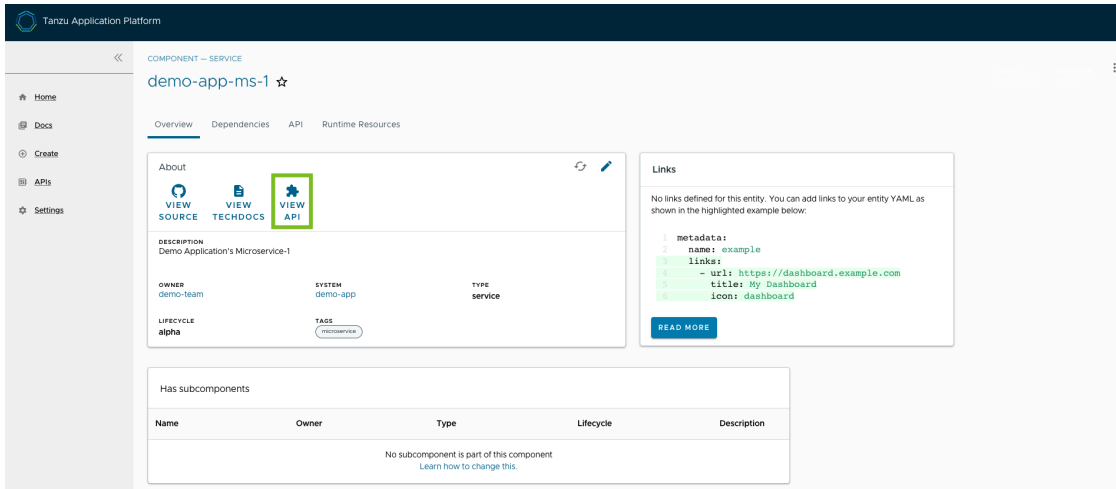

The **VIEW API** tab displays which APIs are being consumed by a component and which APIs are being provided by the component.

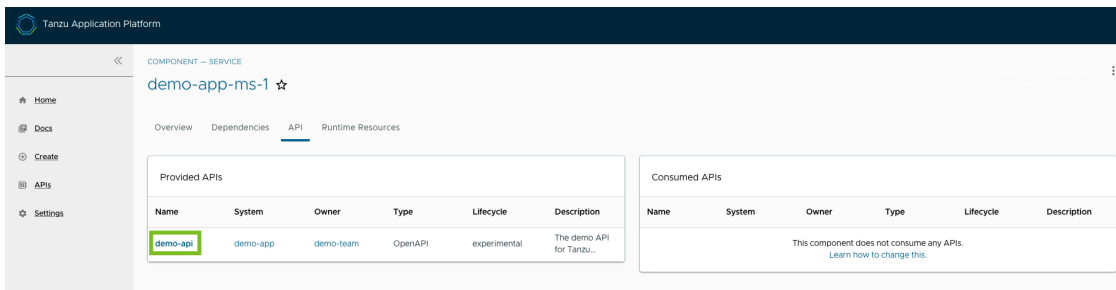

Clicking on the API itself takes you to the catalog entry for the API, which the Kind type listed in the upper-left corner denotes. Every API entity has a title and short description, including a reference to the team that owns the definition of that API and the software catalog objects that are connected to it.

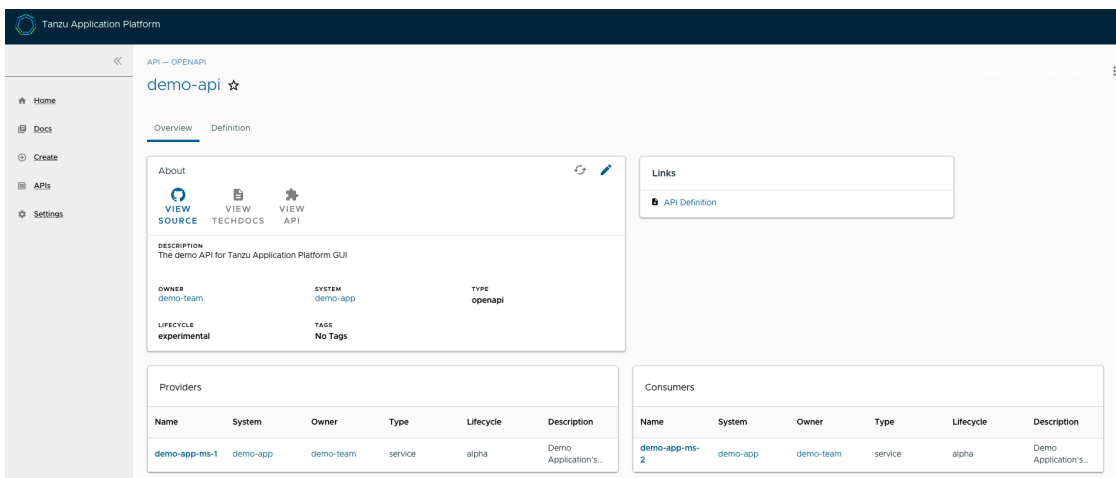

Select the **Definition** tab on the top of the API page to see the definition of that API in human-readable and machine-readable format.

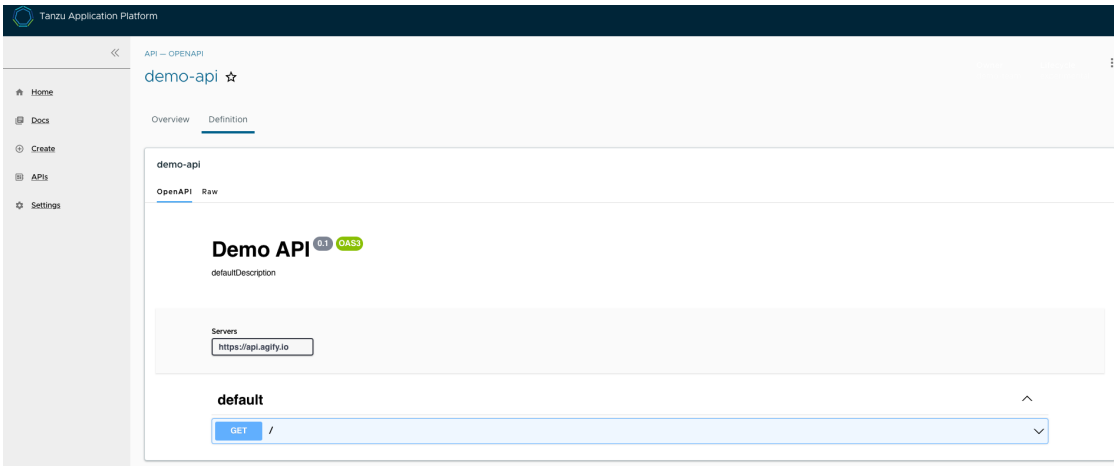

The API documentation plug-in supports the following API formats:

- OpenAPI 2 & 3
- AsyncAPI
- GraphQL
- Plain (to support any other format)

Create a new API entry

You can create a new API entry manually or automatically.

Manually create a new API entry

Manually creating a new API entity is similar to registering any other software catalog entity. To manually create a new API entity:

1. Click the **Home** button on the left navigation pane to access the home page of Tanzu Developer Portal.
2. Click **REGISTER ENTITY**.
3. **Register an existing component** prompts you to type a repository URL. Paste the link to the `catalog-info.yaml` file of your choice that contains the definition of your API entity. For example, you can copy the following YAML content and save it as `catalog-info.yaml` on a Git repository of your choice.

```
apiVersion: backstage.io/v1alpha1
kind: API
metadata:
  name: demo-api
  description: The demo API for Tanzu Developer Portal
  links:
    - url: https://api.agify.io
      title: API Definition
      icon: docs
spec:
  type: openapi
  lifecycle: experimental
  owner: demo-team
  system: demo-app # Or specify system name of your choice
  definition: |
    openapi: 3.0.1
    info:
      title: defaultTitle
      description: defaultDescription
```

```

version: '0.1'
servers:
  - url: https://api.agify.io
paths:
  /:
    get:
      description: Auto generated using Swagger Inspector
      parameters:
        - name: name
          in: query
          schema:
            type: string
          example: type_any_name
      responses:
        '200':
          description: Auto generated using Swagger Inspector
          content:
            application/json; charset=utf-8:
              schema:
                type: string
              examples: {}

```

4. Click **ANALYZE** and then review the catalog entities to be added.

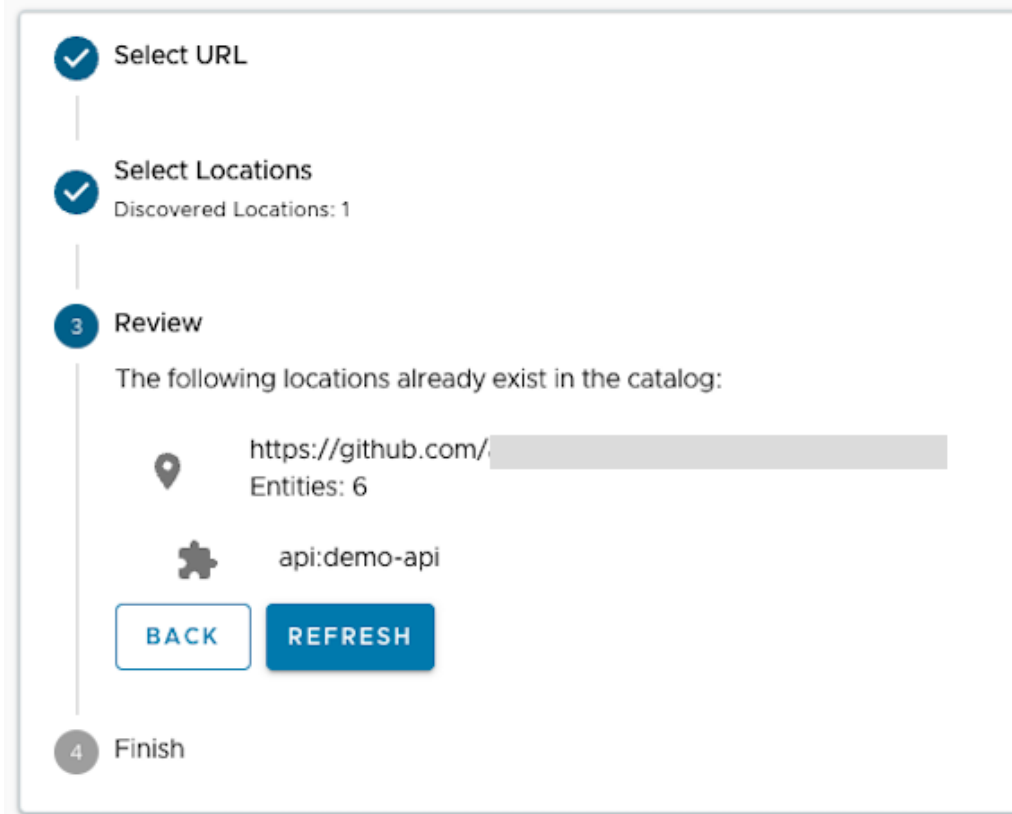

5. Click **IMPORT**.
6. Click **APIs** on the left navigation pane to view entries on the **API** page.

Automatically create a new API entry

Tanzu Application Platform v1.3 introduced a feature called **API Auto Registration** that can automatically register your APIs. For more information, see [API Auto Registration](#).

Get started with the API documentation plug-in

This topic tells you how to get started with the API documentation plug-in in Tanzu Developer Portal (formerly called Tanzu Application Platform GUI).

API entries

This section describes API entities, how to add them, and how to update them.

About API entities

The list of API entities is visible on the left side navigation pane of Tanzu Developer Portal. It is also visible on the Overview page of specific components on the home page. APIs are a definition of the interface between components.

Their definition is provided in raw machine-readable and human-readable formats. For more information, see the [API plug-in documentation](#).

Add a demo API entity to the Tanzu Developer Portal software catalog

To add a demo API entity and its related Catalog objects, follow the steps used for registering any other software catalog entity:

1. Go to the Home page of Tanzu Developer Portal by clicking **Home** on the left-side navigation pane.
2. Click **REGISTER ENTITY**.
3. In the repository URL text box, type the link to the `catalog-info.yaml` file of your choice or use the following sample definition.
4. Save this code block as `catalog-info.yaml`.
5. Upload it to the Git repository of your choice and copy the link to `catalog-info.yaml`. This demo setup includes a domain named `demo-domain` with a single system named `demo-system`. This systems consists of two microservices (`demo-app-ms-1` and `demo-app-ms-1`) and one API named `demo-api` that `demo-app-ms-1` provides and that `demo-app-ms-2` consumes.

```
apiVersion: backstage.io/v1alpha1
kind: Domain
metadata:
  name: demo-domain
  description: Demo Domain for Tanzu Application Platform
  annotations:
    'backstage.io/techdocs-ref': dir:.
spec:
  owner: demo-team

---

apiVersion: backstage.io/v1alpha1
kind: Component
metadata:
  name: demo-app-ms-1
  description: Demo Application's Microservice-1
  tags:
    - microservice
  annotations:
    'backstage.io/kubernetes-label-selector': 'app.kubernetes.io/part-of=demo-a
pp-ms-1'
    'backstage.io/techdocs-ref': dir:.
spec:
  type: service
```

```

providesApis:
  - demo-api
lifecycle: alpha
owner: demo-team
system: demo-app

---

apiVersion: backstage.io/v1alpha1
kind: Component
metadata:
  name: demo-app-ms-2
  description: Demo Application's Microservice-2
  tags:
    - microservice
  annotations:
    'backstage.io/kubernetes-label-selector': 'app.kubernetes.io/part-of=demo-a
pp-ms-2'
    'backstage.io/techdocs-ref': dir:.
spec:
  type: service
  consumesApis:
    - demo-api
  lifecycle: alpha
  owner: demo-team
  system: demo-app

---

apiVersion: backstage.io/v1alpha1
kind: System
metadata:
  name: demo-app
  description: Demo Application for Tanzu Application Platform
  annotations:
    'backstage.io/techdocs-ref': dir:.
spec:
  owner: demo-team
  domain: demo-domain

---

apiVersion: backstage.io/v1alpha1
kind: API
metadata:
  name: demo-api
  description: The demo API for Tanzu Developer Portal
  links:
    - url: https://api.agify.io
      title: API Definition
      icon: docs
spec:
  type: openapi
  lifecycle: experimental
  owner: demo-team
  system: demo-app # Or specify system name of your choice
  definition: |
    openapi: 3.0.1
    info:
      title: Demo API
      description: defaultDescription
      version: '0.1'
    servers:
      - url: https://api.agify.io
  paths:
    /:

```

```

get:
  description: Auto generated using Swagger Inspector
  parameters:
    - name: name
      in: query
      schema:
        type: string
        example: type_any_name
  responses:
    '200':
      description: Auto generated using Swagger Inspector
      content:
        application/json; charset=utf-8:
          schema:
            type: string
            examples: {}
    
```

6. Paste the link to `catalog-info.yaml` and click **ANALYZE**.
7. Review the catalog entities and click **IMPORT**.

3 Review

The following entities will be added to the catalog:

- 📍 `https://github.com/` Entities: 6
- ⚙️ `api:demo-api`
- ⚙️ `component:demo-app-ms-1`
- ⚙️ `component:demo-app-ms-2`
- 🏠 `domain:demo-domain`
- 📍 `location:generated-`
- 🏠 `system:demo-app`

BACK **IMPORT**

4 Finish

8. Go to the **API** page by clicking **APIs** on the left side navigation pane. The catalog changes and entries are visible for further inspection. If you select the system **demo-app**, the diagram appears as follows:



Update your demo API entry

To update your demo API entity, click on **demo-api** from the list of available APIs in your software catalog and click the **Edit** icon on the Overview page.

It opens the source `catalog-info.yaml` file that you can edit. For example, you can change the `spec.paths.parameters.example` from `type_any_name` to `Tanzu` and then save your changes.

After making any edits, Tanzu Developer Portal re-renders the API entry with the next refresh cycle.

Validation Analysis of API specifications

This section describes the Validation Analysis card, the data format needed to populate the card, and how to get automatic scores for your OpenAPI entities.

About the Validation Analysis card

When viewing entities of the kind `API` on the Overview tab, you see the Validation Analysis card that displays the health of an API through various scoring parameters.

The screenshot shows the Overview page for the API entity `tap-gui-1.0.0-1`. The Validation Analysis card displays the following health scores:

Score	Category
33.9%	Documentation Health
100.0%	Security Score
100.0%	OpenAPI Health

The card also includes sections for About, Links, Providers, and Consumers.

To display the health scores, an API entity must contain the following metadata structure:

```

apiVersion: backstage.io/v1alpha1
kind: API
metadata:
  name: NAME
  description: DESCRIPTION
apiscores:
  scores:
    - id: documentationReport
      label: "Documentation Health"
      value: 34.375
      valueType: percentage
      status: failed
    - id: securityReport
      label: "Security Score"
      value: 70.0
      valueType: percentage
      status: warning
    - id: openApiHealthReport
      label: "OpenAPI Health"
      value: 89.0625
      valueType: percentage
      status: passed
  scoreDetailsURL: VALIDATION-REPORT-URL-FOR-MORE-DETAILS
# Other API Entity parameters

```

If an API entity follows this schema, the Validation Analysis card displays helpful information about the API.

```

- id: # Unique ID
  label: # Descriptive label displayed as a title over the numerical value
  value: # Any number value
  valueType: # One of the types (percentage or other). Displays the % symbol or displays nothing.
  status: # One of the statuses (passed, warning, or failed). Displays the number in green, yellow, or red.

```

Automatic OpenAPI specification validation

To receive automatic validation analysis for OpenAPI specifications by using API Validation Scoring:

1. [Install API Validation and Scoring](#).
2. Use [API Auto Registration](#) or [API Validation Scoring Design GitOps](#) to automatically generate the API entities in Tanzu Developer Portal.

The automatic scoring cannot score or replace API entities created through other methods, such as regular GitOps or manual registration. You might see the following message signaling that the OpenAPI specification was registered with regular GitOps methods or manual registration.

```

Validation analysis is currently unavailable for APIs registered via TAP GUI without being attached \
to a workload.

```

Security Analysis in Tanzu Developer Portal

This topic tells you about the Security Analysis plug-in in Tanzu Developer Portal (formerly called Tanzu Application Platform GUI).

Overview

The Security Analysis plug-in summarizes vulnerability data across all workloads running in Tanzu Application Platform, enabling faster identification and remediation of CVEs.

Installing and configuring

The Security Analysis plug-in is installed by default. It is tightly coupled with the [Supply Chain Choreographer plug-in](#). After installing and configuring the Supply Chain Choreographer GUI plug-in, there is no additional configuration needed for the Security Analysis plug-in.

The Security Analysis plug-in is part of the Tanzu Application Platform Full and View profiles.

Accessing the plug-in

The Security Analysis plug-in is always accessible from the left navigation pane. Click the **Security Analysis** button to open the **Security Analysis** dashboard.

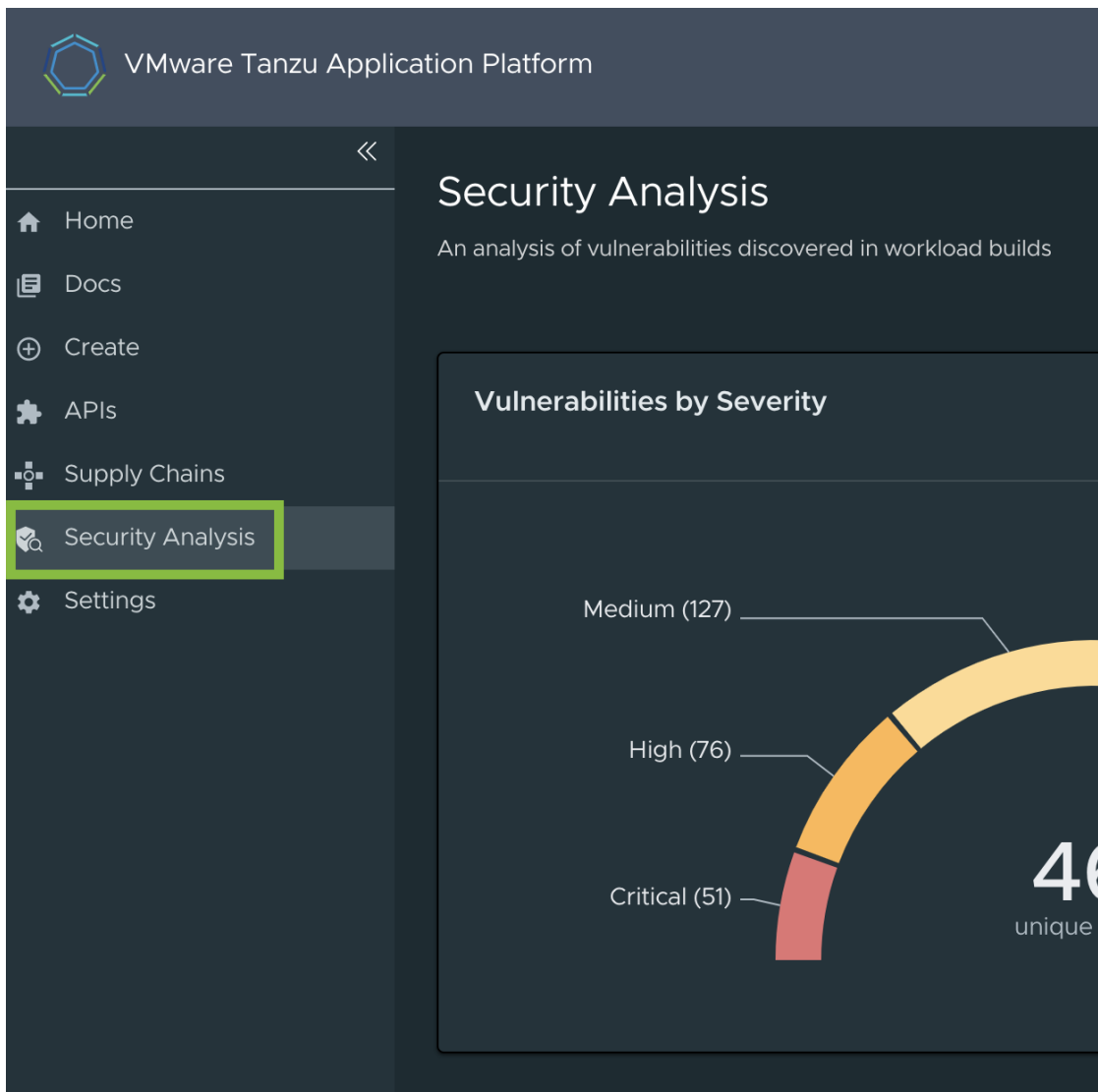

Viewing vulnerability data

The **Security Analysis** dashboard provides a summary of all vulnerabilities across all clusters for single-cluster and multicluster deployments.

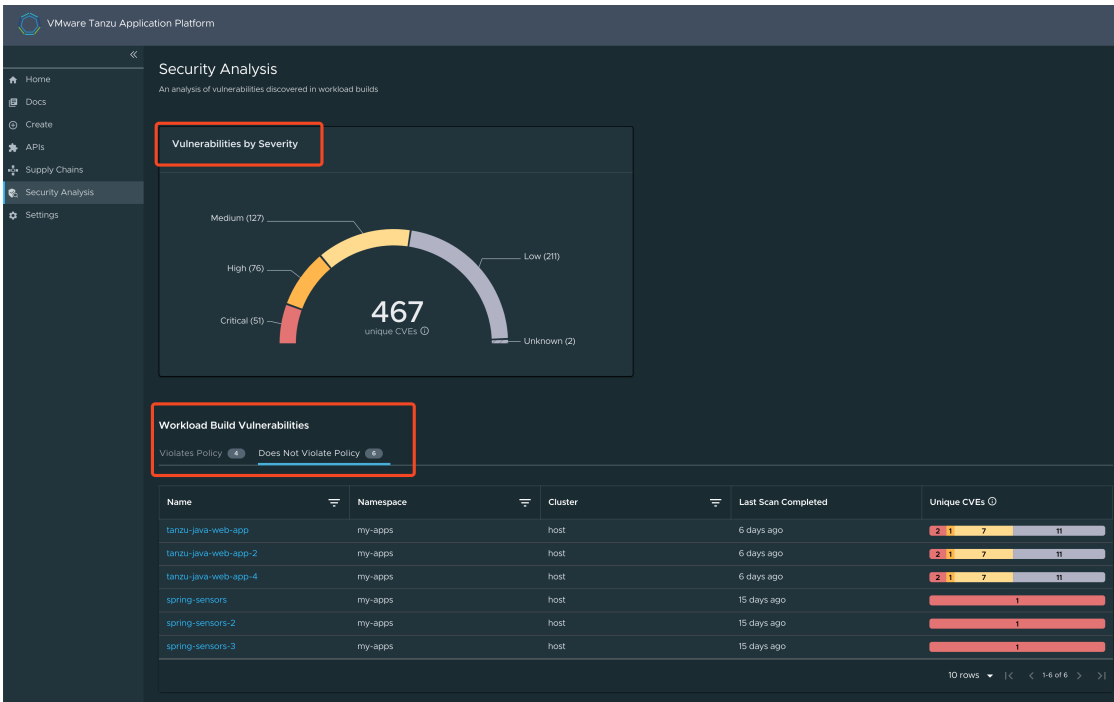

The **Vulnerabilities by Severity** widget quickly counts the number of critical, high, medium, low, and unknown severity CVEs, based on the CVSS severity rating of each CVE.

It includes a sum of all workloads' source and image scan vulnerabilities. For example, if CVE-123 exists in the latest source scans and image scans of Workload ABC and Workload DEF, it is counted four times.

Note

The sum includes any CVEs on the allowlist (ignoreCVEs).

The **Workload Build Vulnerabilities** tables, with the **Violates Policy** tab and **Does Not Violate** tab, separate workloads based on the scan policy. For more information, see [Enforce compliance policy using Open Policy Agent](#) The Unique CVEs column uses the same sum logic as described earlier, but for individual workloads.

The sum of a workload's CVEs might not match the [Supply Chain Choreographer's Vulnerability Scan Results](#). The data on this dashboard is based on `kubectl describe` for `SourceScan` and `ImageScan`. The data on the Supply Chain Choreographer's Vulnerability Scan Results is based on Metadata Store data.

Only vulnerability scans associated with a Cartographer workload appear. Use [tanzu insight](#) to view results for non-workload scan results.

Viewing CVE and package details

The Security Analysis plug-in has a **CVE** page and a **Package** page. These are accessed by clicking on a workload name, which opens the Supply Chain Choreographer plug-in. Clicking on the CVE or Package name opens the **CVE** or **Package** page, respectively.

Workload Build Vulnerabilities

Violates Policy **4** Does Not Violate Policy **6**

Name	Namespace
tanzu-java-web-app	my-apps
tanzu-java-web-app-2	my-apps
tanzu-java-web-app-4	my-apps

The **CVE** page contains basic information about the vulnerability and includes a table with all affected packages and versions.

The **Package** page contains basic information about a package and includes a table with all CVEs and the affected package versions.

Supply Chain Choreographer in Tanzu Developer Portal

This topic tells you about Supply Chain Choreographer in Tanzu Developer Portal (formerly called Tanzu Application Platform GUI).

Overview

The Supply Chain Choreographer (SCC) plug-in enables you to visualize the execution of a workload by using any of the installed Out-of-the-Box supply chains. For more information about the Out-of-the-Box (OOTB) supply chains that are available in Tanzu Application Platform, see [Supply Chain Choreographer for Tanzu](#).

Prerequisites

To use Supply Chain Choreographer in Tanzu Developer Portal you must have:

- One of the following installed on your cluster:
 - [Tanzu Application Platform Full profile](#)
 - [Tanzu Application Platform View profile](#)
 - [Tanzu Developer Portal package](#) and a metadata store package
- One of the following installed on the target cluster where you want to deploy your workload:
 - [Tanzu Application Platform Run profile](#)
 - [Tanzu Application Platform Full profile](#)

For more information, see [Overview of multicluster Tanzu Application Platform](#)

Enable CVE scan results

To see CVE scan results within Tanzu Developer Portal, connect Tanzu Developer Portal to the Tanzu Application Platform component Supply Chain Security Tools - Store (SCST - Store).

Automatically connect Tanzu Developer Portal to SCST - Store

Tanzu Developer Portal has automation for enabling connection between Tanzu Developer Portal and [SCST - Store](#). This automation is active by default and requires no configuration.



Important

There is a known issue with the automatic configuration breaking the SBOM download feature introduced in Tanzu Application Platform v1.6. To fix this issue, edit `tap-values.yaml` as described in [Troubleshooting](#).

To deactivate this automation, add the following block to the Tanzu Developer Portal section within `tap-values.yaml`:

```
# ...
tap_gui:
  # ...
  metadataStoreAutoconfiguration: false
```

This file change creates a service account for the connection with privileges scoped only to Metadata Store. In addition, it mounts the token of the service account into the Tanzu Developer Portal pod and produces for you the `app_config` section necessary for Tanzu Developer Portal to communicate with SCST - Store.

Troubleshooting

For debugging the automation, or for verifying that the automation is active, you must know which resources are created. The following commands display the different Kubernetes resources that are created when `tap_gui.metadataStoreAutoconfiguration` is set to `true`:

```
$ kubectl -n tap-gui get serviceaccount metadata-store
NAME          SECRETS  AGE
metadata-store  1        AGE-VALUE
```

```
$ kubectl -n tap-gui get secret metadata-store-access-token
NAME                                TYPE                                DATA  AGE
metadata-store-access-token         kubernetes.io/service-account-token  3      AGE-VALUE
```

```
$ kubectl -n tap-gui get clusterrole metadata-store-reader
NAME                CREATED AT
metadata-store-reader  CREATED-AT-TIME
```

```
$ kubectl -n tap-gui get clusterrolebinding read-metadata-store
NAME                ROLE                                AGE
read-metadata-store  ClusterRole/metadata-store-reader  AGE-VALUE
```

There is another condition that impacts whether the automation creates the necessary service account. If your configuration includes a `/metadata-store` block, the automation doesn't create the Kubernetes resources for use in `autoconfiguration` and the automation doesn't overwrite the proxy block that you provide. To use the automation, you must delete the block at `tap_gui.app_config.proxy["/metadata-store"]`.

For example, a `tap-values.yaml` file with the following content does not create additional Kubernetes resources as described earlier:

```
# ...
tap_gui:
  # ...
  app_config:
    # ...
    proxy:
      '/metadata-store':
        target: SOMETHING
```

Manually connect Tanzu Developer Portal to the Metadata Store

To manually enable CVE scan results:

1. Obtain the [read-write token](#), which is created by default when installing Tanzu Application Platform. Alternatively, [create an additional read-write service account](#).
2. Add this proxy configuration to the `tap_gui:` section of `tap-values.yaml`:

```
tap_gui:
  app_config:
    proxy:
      /metadata-store:
        target: https://metadata-store-app.metadata-store:8443/api/v1
        changeOrigin: true
        secure: false
        allowedHeaders: ['Accept', 'Report-Type-Format']
        headers:
          Authorization: "Bearer ACCESS-TOKEN"
          X-Custom-Source: project-star
```

Where `ACCESS-TOKEN` is the token you obtained after creating a read-write service account.



Important

The `Authorization` value must start with the word `Bearer`.

Enable GitOps Pull Request Flow

Set up for GitOps and pull requests to enable the supply chain box-and-line diagram to show **Approve a Request** in the **Config Writer** stage details view when the **Config Writer** stage is clicked. For more information, see [GitOps vs. RegistryOps](#).

Supply Chain Visibility

Before using the Supply Chain Visibility (SCV) plug-in to visualize a workload, you must create a workload.

The workload must have the `app.kubernetes.io/part-of` label specified, whether you manually create the workload or use one supplied with the OOTB supply chains.

Use the left sidebar navigation to access your workload and visualize it in the supply chain that is installed on your cluster.

The example workload described in this topic is named `tanzu-java-web-app`.

WORKLOADS

Name	Namespace	Owner	Supply Chain
spring-petclinic	dev	default-team	source-to-url
tanzu-java-web-app	dev	default-team	source-test-scan-to-url

5 rows | < < 1-2 of 2 > >

Click **tanzu-java-web-app** in the **WORKLOADS** table to navigate to the visualization of the supply chain.

There are two sections within this view:

- The box-and-line diagram at the top shows all the configured CRDs that this supply chain uses, and any artifacts that the supply chain's execution outputs
- The **Stage Detail** section at the bottom shows source data for each part of the supply chain that you select in the diagram view

Supply Chain: tanzu-java-web-app Errors: 0 Warnings: 0

Stage Detail: image-builder 106%

20 hours ago

Overview

Blob URL

SubPath

Build Tool [ClusterBuilder/default](#)

Latest Build

ID	3
Age	20 hours ago
Reason	CONFIG
Docker Pull	Copy Image Tag

Latest Builds

ID	Age	Reason	Docker Pull
3	20 hours ago	CONFIG	Copy Image Tag
2	20 hours ago	CONFIG	Copy Image Tag
1	21 hours ago	CONFIG	Copy Image Tag

5 rows | < < 1-3 of 3 > >

When a workload is deployed to a cluster that has the **deliverable** package installed, a new section appears in the supply chain that shows **Pull Config** boxes and **Delivery** boxes.

When you have a **Pull Request** configured in your environment, access the merge request from the supply chain by clicking **APPROVE A REQUEST**. This button is displayed after you click **Config Writer** in the supply chain diagram.

tanzu-java-web-app-pr-flow

Supply Chain: source-test-scan-to-uri
 Supply Chain Cluster: gke_dap-ops_us-west2_interfaces-test
 Delivery Cluster: gke_dap-ops_us-west2_interfaces-test

Errors: 0 Warnings: 0

Service Bindings (11 days ago) → Api Descriptors (11 days ago) → Config Writer (11 days ago) → Pull Config (18 days ago) → Delivery (18 days ago)

Stage Detail: Config Writer
 11 days ago

Overview

Name	tanzu-java-web-app-pr-flow-config-writer-pull-requester
Kind	Runnable
Version	carto-run/v1alpha1
Namespace	my-apps

Action Needed

APPROVE A REQUEST

View Vulnerability Scan Results

Click the **Source Scan** stage or **Image Scan** stage to view vulnerability source scans and image scans for workload builds. The data is from [Supply Chain Security Tools - Store](#).

CVE issues represent any vulnerabilities associated with a package or version found in the source code or image, including vulnerabilities from past scans.

Note

For example, the `log4shell` package is found in image ABC on 1 January without any CVEs. On 15 January, the `log4j` CVE issue is found while scanning image DEF. If a user returns to the **Image Scan** stage for image ABC, the `log4j` CVE issue appears and is associated with the `log4shell` package.

Overview of enabling TLS for Tanzu Developer Portal

Many users want inbound traffic to Tanzu Developer Portal (formerly called Tanzu Application Platform GUI) to be properly encrypted. These topics tell you how to enable TLS encryption either with an existing certificate or by using the included cert-manager instance.

Concepts

The two key concepts are certificate delegation and the relationship between cert-manager, certificates, and ClusterIssuers.

Certificate delegation

Tanzu Developer Portal uses the established shared Contour ingress for TLS termination.

This enables you to store the certificate in a Kubernetes `secret` and then pass that `secret` and `namespace` to the `httpProxy` that was created during installation. To do this, see [Configuring a TLS certificate by using an existing certificate](#).

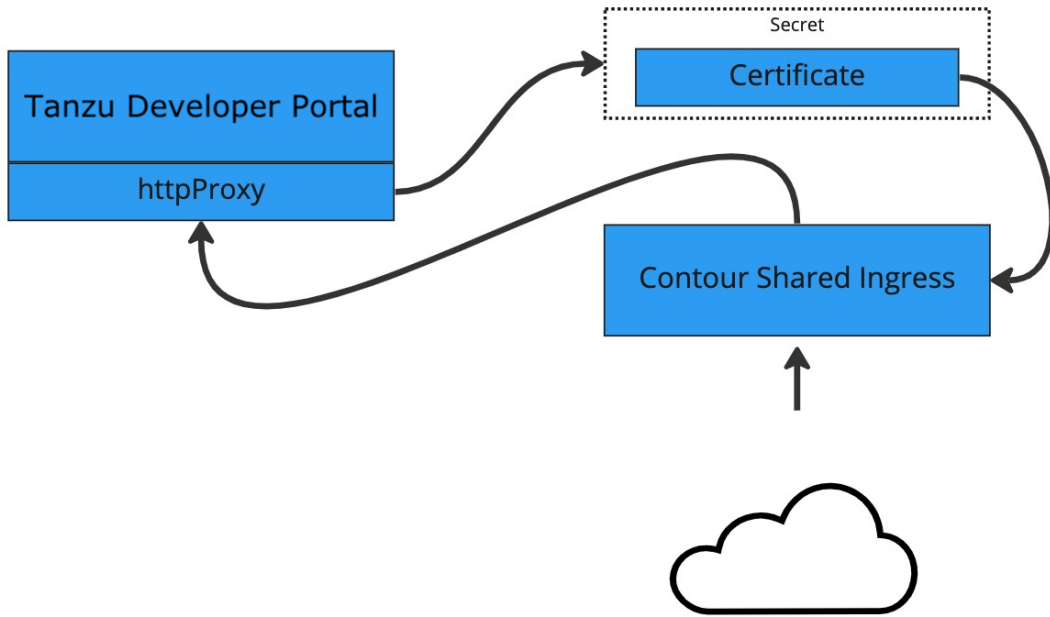

cert-manager, certificates, and ClusterIssuers

Tanzu Developer Portal can also use the `cert-manager` package that is installed when the profile was installed.

This tool allows cert-manager to automatically acquire a certificate from a `clusterIssuer` entity.

This external entity can be an external certificate authority, such as Let's Encrypt, or a self-signed certificate.

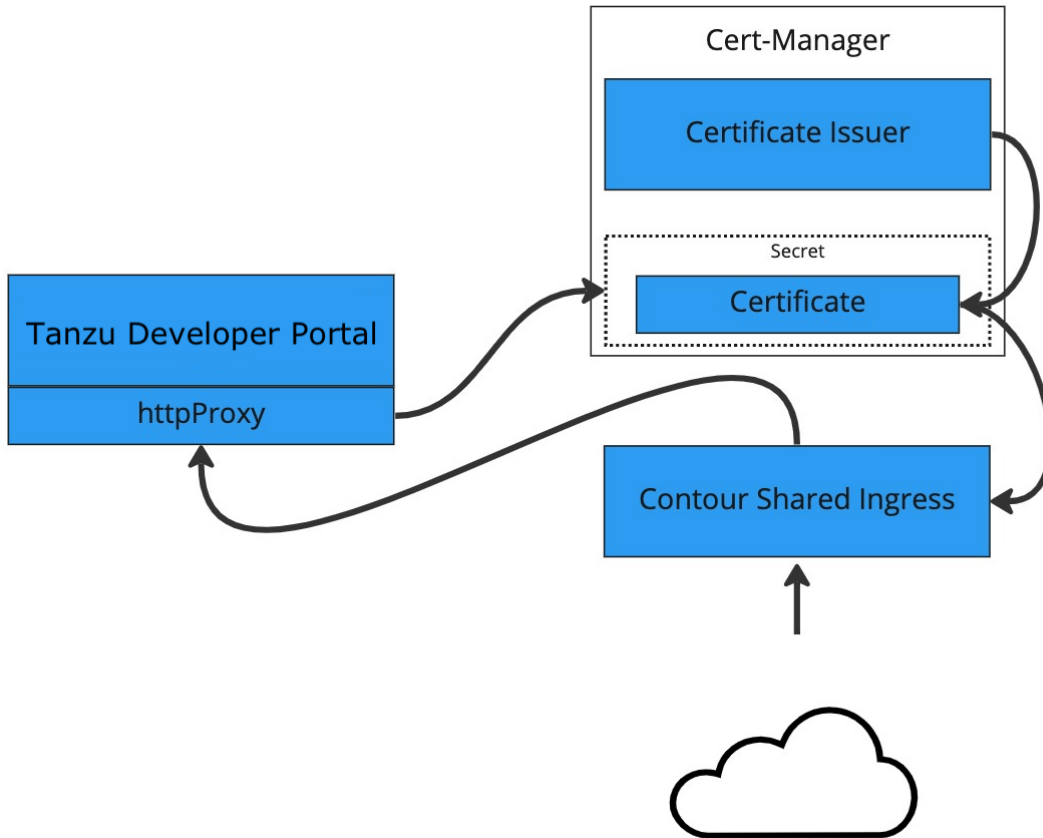

Guides

The following topics describe different ways to configure TLS:

- [Configuring a TLS certificate by using an existing certificate](#)
- [Configuring a TLS certificate by using a self-signed certificate](#)
- [Configuring a TLS certificate by using cert-manager and a ClusterIssuer](#)

Overview of enabling TLS for Tanzu Developer Portal

Many users want inbound traffic to Tanzu Developer Portal (formerly called Tanzu Application Platform GUI) to be properly encrypted. These topics tell you how to enable TLS encryption either with an existing certificate or by using the included cert-manager instance.

Concepts

The two key concepts are certificate delegation and the relationship between cert-manager, certificates, and ClusterIssuers.

Certificate delegation

Tanzu Developer Portal uses the established shared Contour ingress for TLS termination.

This enables you to store the certificate in a Kubernetes `secret` and then pass that `secret` and `namespace` to the `httpProxy` that was created during installation. To do this, see [Configuring a TLS certificate by using an existing certificate](#).

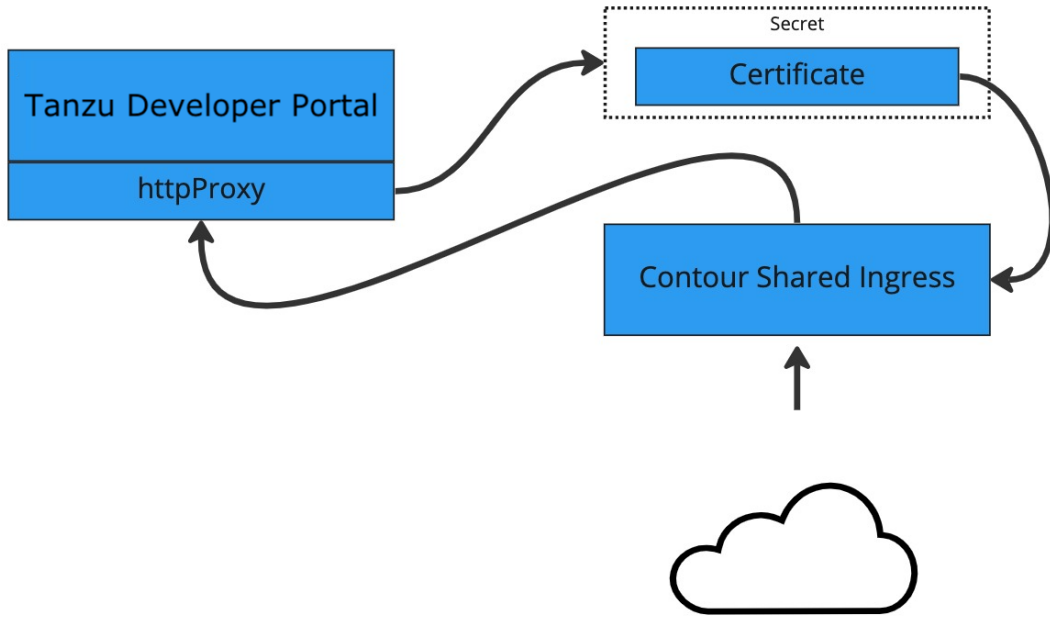

cert-manager, certificates, and ClusterIssuers

Tanzu Developer Portal can also use the `cert-manager` package that is installed when the profile was installed.

This tool allows cert-manager to automatically acquire a certificate from a `clusterIssuer` entity.

This external entity can be an external certificate authority, such as Let's Encrypt, or a self-signed certificate.

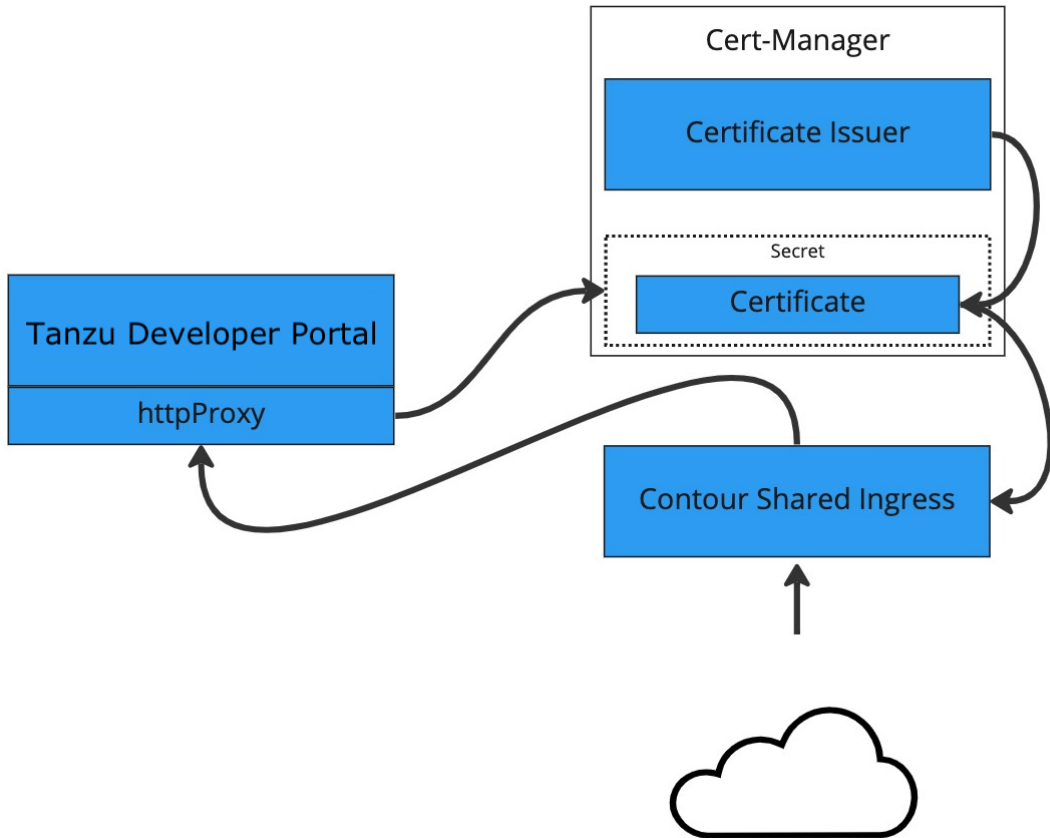

Guides

The following topics describe different ways to configure TLS:

- [Configuring a TLS certificate by using an existing certificate](#)
- [Configuring a TLS certificate by using a self-signed certificate](#)
- [Configuring a TLS certificate by using cert-manager and a ClusterIssuer](#)

Configure a TLS certificate by using an existing certificate

This topic tells you how to use the certificate information from your external certificate authority to encrypt inbound traffic to Tanzu Developer Portal (formerly called Tanzu Application Platform GUI).

Prerequisites

Your certificate authority gave you a certificate file, of the form `CERTIFICATE-FILE-NAME.crt`, and a signing key, of the form `KEY-FILE-NAME.key`. Ensure that these files are present on the host from which you run the CLI commands.

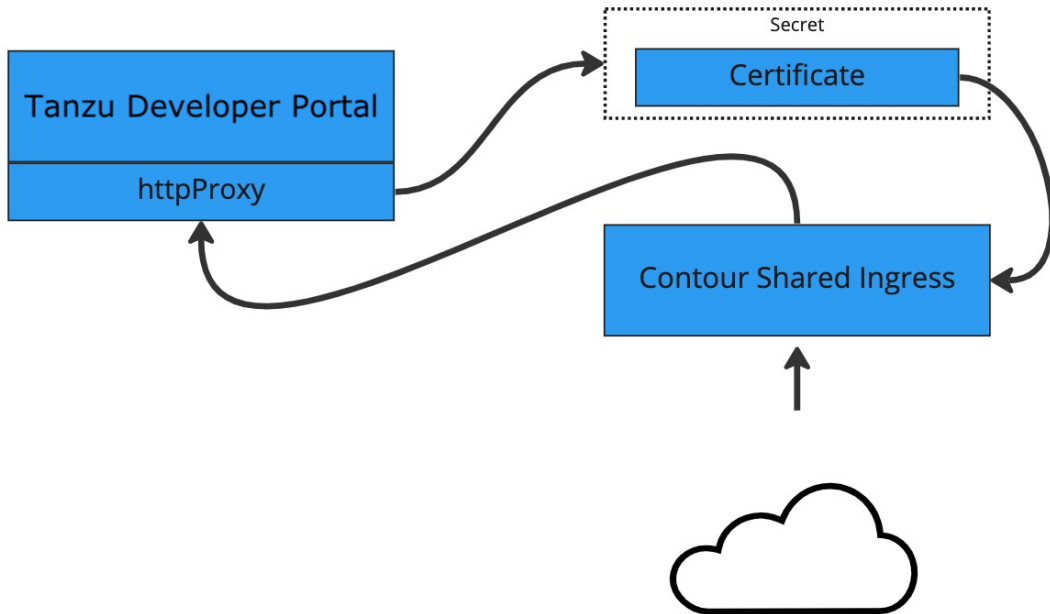

Procedure

To configure Tanzu Developer Portal with an existing certificate:

1. Create the Kubernetes secret by running:

```
kubectl create secret tls tap-gui-cert --key="KEY-FILE-NAME.key" --cert="CERTIFICATE-FILE-NAME.crt" -n tap-gui
```

Where:

- `KEY-FILE-NAME` is the name of the `key` file that your certificate issuer gave you
 - `CERTIFICATE-FILE-NAME` is the name of the `cert` file that your certificate issuer gave you
2. Configure Tanzu Developer Portal to use the newly created secret. Do so by editing the `tap-values.yaml` file that you used during installation to include the following under the `tap-gui` section:
 - A top-level `tls` key with subkeys for `namespace` and `secretName`
 - A namespace referring to the namespace used earlier
 - A secret name referring to the `secretName` value defined earlier

Example:

```
tap_gui:
  tls:
    namespace: tap-gui
    secretName: tap-gui-cert
  # Additional configuration below this line as needed
```

3. Update the Tanzu Application Platform package with the new values in `tap-values.yaml` by running:

```
tanzu package installed update tap -p tap.tanzu.vmware.com -v TAP-VERSION --values-file tap-values.yaml -n tap-install
```

Where `TAP-VERSION` is the version number that matches the values you used when you installed your profile.

Configure a TLS certificate by using a self-signed certificate

This topic tells you how to use cert-manager to create a self-signed certificate issuer and then generate a certificate for Tanzu Developer Portal (formerly named Tanzu Application Platform GUI) to use based on that issuer.

Some browsers and corporate policies do not allow you to visit webpages that have self-signed certificates. You might need to navigate through a series of error messages to visit the page.

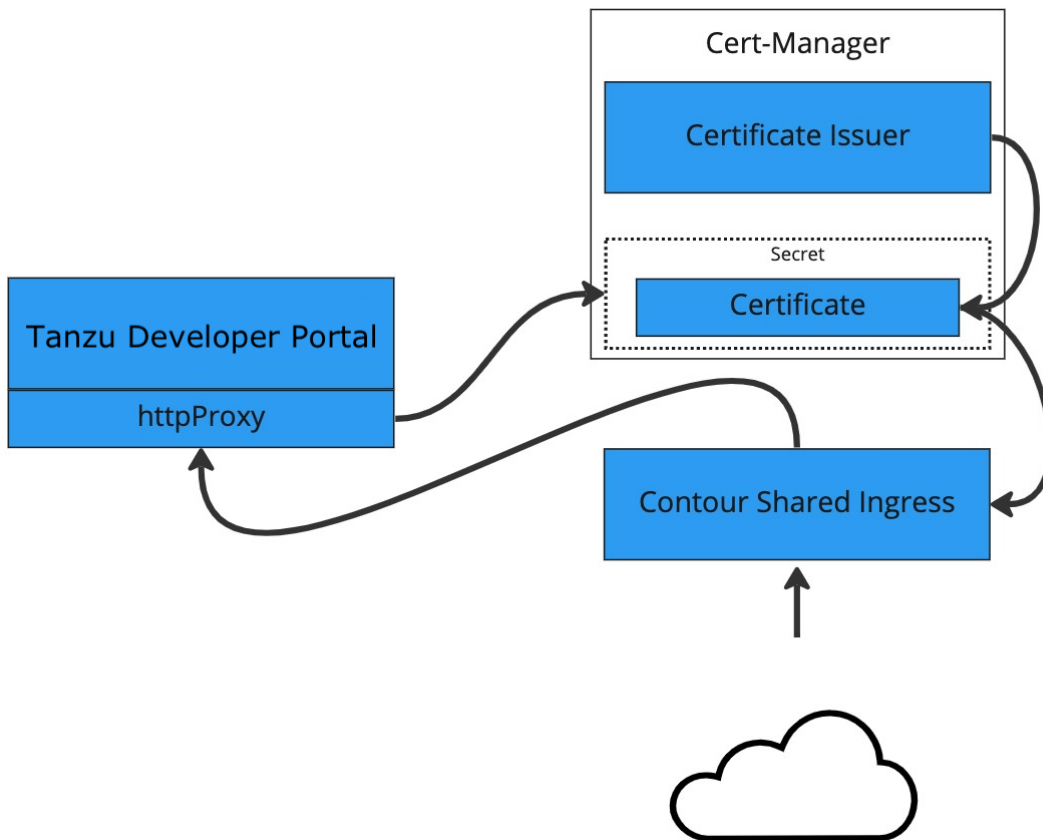

Prerequisite

Install a Tanzu Application Platform profile that includes cert-manager. Verify you did this by running the following command to detect the cert-manager namespace:

```
kubectl get ns
```

Procedure

To configure a self-signed TLS certificate for Tanzu Developer Portal:

1. Create a `certificate.yaml` file that defines an issuer and a certificate. For example:

```

apiVersion: cert-manager.io/v1
kind: Issuer
metadata:
  name: ca-issuer
  namespace: tap-gui
spec:
  selfSigned: {}
---
apiVersion: cert-manager.io/v1
kind: Certificate
metadata:
  name: tap-gui-cert
  namespace: tap-gui
spec:
  secretName: tap-gui-cert
  dnsNames:
  - tap-gui.INGRESS-DOMAIN
  issuerRef:
    name: ca-issuer

```

Where `INGRESS-DOMAIN` is your domain value that matches the values you used when you installed the profile.

2. Add the issuer and certificate to your cluster by running:

```
kubectl apply -f certificate.yaml
```

3. Configure Tanzu Developer Portal to use the newly created certificate. Update the `tap-values.yaml` file used during installation to include the following under the `tap-gui` section:

- o A top-level `tls` key with subkeys for `namespace` and `secretName`
- o A namespace referring to the namespace containing the `Certificate` object mentioned earlier
- o A secret name referring to the `secretName` value defined in your `Certificate` resource earlier

Example:

```

tap_gui:
  tls:
    namespace: tap-gui
    secretName: tap-gui-cert
  # Additional configuration below this line as needed

```

4. Update the Tanzu Application Platform package with the new values in `tap-values.yaml`:

```

tanzu package installed update tap -p tap.tanzu.vmware.com -v TAP-VERSION --values-file tap-values.yaml -n tap-install

```

Where `TAP-VERSION` is the version that matches the values you used when you installed the profile.

Configure a TLS certificate by using cert-manager and a ClusterIssuer

This topic tells you how to use cert-manager to create a certificate issuer and then generate a certificate for Tanzu Developer Portal (formerly called Tanzu Application Platform GUI) to use based on that issuer.

This topic uses the free certificate issuer [Let's Encrypt](#). You can use other certificate issuers compatible with cert-manager in a similar fashion.

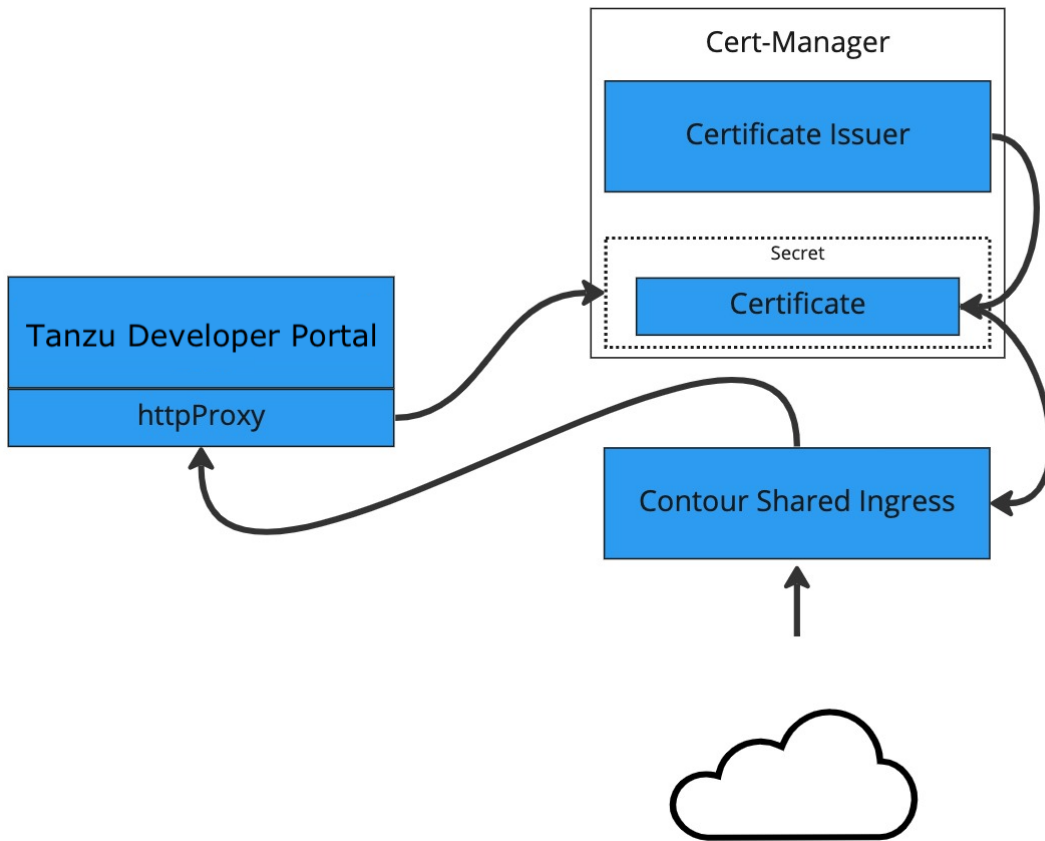

Prerequisites

Fulfil these prerequisites:

- Install a Tanzu Application Platform profile that includes cert-manager. Verify you did this by running the following command to detect the cert-manager namespace:

```
kubectl get ns
```

- Obtain a domain name that you control or own and have proof that you control or own it. In most cases, this domain name is the one you used for the `INGRESS-DOMAIN` values when you installed Tanzu Application Platform and Tanzu Developer Portal.
- If cert-manager cannot perform the challenge to verify your domain's compatibility, you must do so manually. For more information, see [How It Works](#) and [Getting Started](#) in the Let's Encrypt documentation.
- Ensure that your domain name is pointed at the shared Contour ingress for the installation. Find the IP address by running:

```
kubectl -n tanzu-system-ingress get services envoy -o jsonpath='{.status.loadBalancer.ingress[0].ip}'
```

Procedure

To configure a self-signed TLS certificate for Tanzu Developer Portal:

1. Create a `certificate.yaml` file that defines an issuer and a certificate. For example:

```

apiVersion: cert-manager.io/v1
kind: ClusterIssuer
metadata:
  name: letsencrypt-http01-issuer
  namespace: cert-manager
spec:
  acme:
    server: https://acme-v02.api.letsencrypt.org/directory
    email: EMAIL-ADDRESS
    privateKeySecretRef:
      name: letsencrypt-http01-issuer
    solvers:
    - http01:
        ingress:
          class: contour
---
apiVersion: cert-manager.io/v1
kind: Certificate
metadata:
  namespace: cert-manager
  name: tap-gui
spec:
  commonName: tap-gui.INGRESS-DOMAIN
  dnsNames:
    - tap-gui.INGRESS-DOMAIN
  issuerRef:
    name: letsencrypt-http01-issuer
    kind: ClusterIssuer
  secretName: tap-gui

```

Where:

- `EMAIL-ADDRESS` is the email address that Let's Encrypt shows as responsible for this certificate
- `INGRESS-DOMAIN` is your domain value that matches the values you used when you installed the profile

2. Add the issuer and certificate to your cluster by running:

```
kubectl apply -f certificate.yaml
```

By applying the certificate, cert-manager attempts to perform an HTTP01 challenge by creating an Ingress resource specifically for the challenge. This is automatically removed from your cluster after the challenge is completed. For more information about how this works, and when it might not, see the [cert-manager documentation](#).

3. Validate the certificate was created and is ready by running:

```
kubectl get certs -n cert-manager
```

Wait a few moments for this to take place, if need be.

4. Configure Tanzu Developer Portal to use the newly created certificate. To do so, update the `tap-values.yaml` file that you used during installation to include the following items under the `tap-gui` section:

- A top-level `tls` key with subkeys for `namespace` and `secretName`
- A namespace referring to the namespace containing the `Certificate` object from earlier

- o A secret name referring to the `secretName` value defined in your `Certificate` resource earlier

Example:

```
tap_gui:
  tls:
    namespace: cert-manager
    secretName: tap-gui
  # Additional configuration below this line as needed
```

5. Update the Tanzu Application Platform package with the new values in `tap-values.yaml` by running:

```
tanzu package installed update tap -p tap.tanzu.vmware.com -v TAP-VERSION --values-file tap-values.yaml -n tap-install
```

Where `TAP-VERSION` is the version that matches the values you used when you installed the profile.

Upgrade Tanzu Developer Portal

This topic tells you how to upgrade Tanzu Developer Portal (formerly called Tanzu Application Platform GUI) outside of a Tanzu Application Platform profile installation. If you installed Tanzu Application Platform through a profile, see [Upgrading Tanzu Application Platform](#) instead.

Considerations

As part of the upgrade, Tanzu Application Platform updates its container with the new version.

As a result, if you installed Tanzu Developer Portal without the support of a backing [database](#), you lose your in-memory data for any manual component registrations when the container restarts.

While the update is pulling the new pod from the registry, users might experience a short UI interruption and might need to re-authenticate because the in-memory session data is rebuilt.

Upgrade within a Tanzu Application Platform profile

If you installed Tanzu Developer Portal as part of a Tanzu Application Platform profile, see [Upgrading Tanzu Application Platform](#).

Upgrade Tanzu Developer Portal individually

These steps only apply to installing Tanzu Developer Portal individually, not as part of a Tanzu Application Platform profile.

To upgrade Tanzu Developer Portal outside of a Tanzu Application Platform profile:

1. Ensure that your repository has access to the new version of the package by running:

```
tanzu package available list tap-gui.tanzu.vmware.com -n tap-install
```

For example:

```
$ tanzu package available list tap-gui.tanzu.vmware.com -n tap-install
- Retrieving package versions for tap-gui.tanzu.vmware.com...
NAME                                VERSION  RELEASED-AT
tap-gui.tanzu.vmware.com            1.0.1   2021-12-22 17:45:51 +0000 UTC
tap-gui.tanzu.vmware.com            1.0.2   2022-01-25 01:57:19 +0000 UTC
```

2. Perform the package upgrade by using the targeted package update version. Run:

```
tanzu package installed update tap-gui -p tap-gui.tanzu.vmware.com -v VERSION
--values-file \
TAP-GUI-VALUES.yaml -n tap-install
```

Where:

- `VERSION` is the target version of Tanzu Developer Portal that you want.
 - `TAP-GUI-VALUES` is the configuration values file that contains the configuration used when you installed Tanzu Developer Portal.
3. Verify that you upgraded your application by running:

```
tanzu package installed get tap-gui -n tap-install
```

Troubleshoot Tanzu Developer Portal

This topic tells you how to troubleshoot issues encountered when installing Tanzu Developer Portal (formerly called Tanzu Application Platform GUI). The topic is divided into sections:

- [General issues](#)
- [Runtime Resources tab issues](#)
- [Accelerators page issues](#)
- [Supporting ImageVulnerabilityScan issues](#)
- [Security Analysis plug-in issues](#)
- [Supply Chain Choreographer plug-in issues](#)

General issues

The following are general issues.

Tanzu Developer Portal reports that the port range is not valid

Symptom

You provided a full URL in a `backend.reading.allow` entry, as in this example `tap-values.yaml` snippet:

```
tap_gui:
  app_config:
    backend:
      reading:
        allow:
          - host: http://gitlab.example.com/some-group/some-repo/-/blob/main/catalog-info.yaml
```

and you see the following error message:

```
Backend failed to start up, Error: Port range is not valid: //gitlab.example.com/some-group/some-repo/-/blob/main/catalog-info.yaml
```

Cause

Tanzu Developer Portal expects a host name to be passed into the field `backend.reading.allow[].host`.

Solution

Edit your `tap-values.yaml` file as in the following example:

```
tap_gui:
  app_config:
    backend:
      reading:
        allow:
          - host: gitlab.example.com
            paths: ['/some-group/some-repo/']
```

Tanzu Developer Portal does not load the catalog

Symptom

You are able to visit Tanzu Developer Portal, but it does not load the catalog and you see the following error message.

```
> Error: Could not fetch catalog entities.
> TypeError: Failed to fetch
```

When viewing your network tab you see that your browser has not downloaded mixed content. This might look different on different browsers.

Chrome
In the **Status** column you see **(blocked:mixed-content)**

Name	Status	Type	Initiator	Size	Time
6329-c4812fd1 chunk.js	200	script	load_script:41	799 B	457 ms
entry-facets?facet=kind	(blocked:mixed-content)	fetch	index.esm.js:1420	0 B	0 ms
entry-facets?facet=metadata.tags	(blocked:mixed-content)	fetch	index.esm.js:1420	0 B	0 ms

Firefox
In the **Transferred** column you see **Mixed Block**

Status	Method	Domain	File	Initiator	Type	Transferred
🚫	GET	██████████	entry-facets?facet=kind	fetch	Mixed Block	Mixed Block
🚫	GET	██████████	entry-facets?facet=metadata.tags	fetch	Mixed Block	Mixed Block
🚫	GET	██████████	entry-facets?facet=kind	fetch	Mixed Block	Mixed Block

Cause

As of Tanzu Application Platform v1.5, Tanzu Developer Portal provides TLS connections by default. Because of this, if you visit a Tanzu Developer Portal site your connection is automatically upgraded to https.

You might have manually set the fields `app.baseUrl`, `backend.baseUrl`, and `backend.cors.origin` in your `tap-values.yaml` file. Tanzu Developer Portal uses the `baseUrl` to determine how to create links to fetch from its APIs. The combination of these two factors causes your browser to attempt to fetch mixed content.

Solution

The solution is to delete these fields or update your values in `tap-values.yaml` to reflect that your Tanzu Developer Portal instance is serving https, as in the following example:

```
tap_gui:
  app_config:
    app:
```



```

baseUrl: https://tap-gui.INGRESS-DOMAIN/
backend:
  baseUrl: https://tap-gui.INGRESS-DOMAIN/
  cors:
    origin: https://tap-gui.INGRESS-DOMAIN/

```

Where `INGRESS-DOMAIN` is the ingress domain you have configured for Tanzu Application Platform.

The installer determines acceptable values based on your `tap_gui.ingressDomain` or `shared.ingress_domain` and the TLS status of the installation.

Updating a supply chain causes an error (Can not create edge...)

Symptom

Updating a supply chain causes an error (Can not create edge...) when an existing workload is clicked in the Workloads table and that supply chain is no longer present.

Solution

Recreate the same workload to execute through the new or updated supply chain.

Catalog not found

Symptom

When you pull up Tanzu Developer Portal, you get the error `Catalog Not Found`.

Cause

The catalog plug-in can't read the Git location of your catalog definition files.

Solution

1. Ensure you have built your own [Backstage](#)-compatible catalog or that you have downloaded one of the Tanzu Developer Portal catalogs from the [Broadcom Support Portal](#).
2. Ensure you defined the catalog in the values file that you input as part of installation. To update this location, change the definition file:
 - o Change the Tanzu Application Platform profile file if installed by using a profile.
 - o Change the standalone Tanzu Developer Portal values file if you're only installing that package on its own.

```

namespace: tap-gui
service_type: SERVICE-TYPE
app_config:
  catalog:
    locations:
      - type: url
        target: https://GIT-CATALOG-URL/catalog-info.yaml

```

3. Provide the proper integration information for the Git location you specified earlier.

```

namespace: tap-gui
service_type: SERVICE-TYPE
app_config:
  app:
    baseUrl: https://EXTERNAL-IP:PORT

```

```

integrations:
  gitlab: # Other integrations available
    - host: GITLAB-HOST
      apiBaseUrl: https://GITLAB-URL/api/v4
      token: GITLAB-TOKEN

```

You can substitute for other integrations as defined in the [Backstage documentation](#).

No configured authentication provider

Symptom

When you load Tanzu Developer Portal in a browser, the following message appears:

```
No configured authentication providers. Please configure at least one.
```

Cause

You have not configured any authentication providers and you have not allowed guest access.

Solution

[Configure an authentication provider](#) or [allow guest access](#).

Issues updating the values file

Symptom

After updating the configuration of Tanzu Developer Portal, either by using a profile or as a standalone package installation, you don't know whether the configuration has reloaded.

Solution

1. Get the name you need by running:

```
kubectl get pods -n tap-gui
```

For example:

```

$ kubectl get pods -n tap-gui
NAME                                READY   STATUS    RESTARTS   AGE
server-6b9ff657bd-h11q9            1/1     Running   0           13m

```

2. Read the log of the pod to see if the configuration reloaded by running:

```
kubectl logs NAME -n tap-gui
```

Where **NAME** is the value you recorded earlier, such as `server-6b9ff657bd-h11q9`.

3. Search for a line similar to this one:

```
2021-10-29T15:08:49.725Z backstage info Reloaded config from app-config.yaml, a
pp-config.yaml
```

4. If need be, delete and re-instantiate the pod.



Caution

Depending on your database configuration, deleting, and re-instantiating the pod might cause the loss of user preferences and manually registered entities. If you have configured an external PostgreSQL database, `tap-gui` pods are not stateful. In most cases, state is held in ConfigMaps, Secrets, or the database. For more information, see [Configuring the Tanzu Developer Portal database](#) and [Register components](#).

To delete and re-instantiate the pod, run:

```
kubectl delete pod -l app=backstage -n tap-gui
```

Pull logs from Tanzu Developer Portal

Symptom

You have a problem with Tanzu Developer Portal, such as `Catalog: Not Found`, and don't have enough information to diagnose it.

Solution

Get timestamped logs from the running pod and review the logs:

1. Pull the logs by using the pod label by running:

```
kubectl logs -l app=backstage -n tap-gui
```

2. Review the logs.

Ad-blocking software interference

Symptom

One or both of the following is true:

- You cannot access some, or all, of Tanzu Developer Portal.
- Telemetry collection within the VMware [Customer Experience Improvement Program](#) is failing.

Cause

Your ad-blocking browser extension or standalone ad-blocking software is causing interference.

Solution

Add Tanzu Developer Portal to your ad-blocking allowlist. Alternatively, deactivate the ad-blocking software or [turn off Pendo telemetry collection](#).

Runtime Resources tab issues

Here are some common troubleshooting steps for errors presented in the **Runtime Resources** tab.

Error communicating with Tanzu Application Platform web server

Symptom

When accessing the **Runtime Resource Visibility** tab, the system displays `Error communicating with TAP GUI back end.`

Causes

- An interrupted Internet connection
- Error with the back end service

Solution

1. Confirm that you have Internet access.
2. Confirm that the back-end service is running correctly.
3. Confirm the cluster configuration is correct.

No data available

Symptom

When accessing the **Runtime Resource Visibility** tab, the system displays

```
One or more resources are missing. This could be due to a label mismatch. \
Please make sure your resources have the label(s) "LABEL_SELECTOR".
```

Cause

No communications error has occurred, but no resources were found.

Solution

Confirm that you are using the correct label:

1. Verify the [Component definition](#) includes the annotation `backstage.io/kubernetes-label-selector`.
2. Confirm your Kubernetes resources correspond to that label drop-down menu.

Errors retrieving resources

Symptom

When opening the **Runtime Resource Visibility** tab, the system displays `One or more resources might be missing because of cluster query errors.`

The reported errors might not indicate a real problem. A build cluster might not have runtime CRDs installed, such as Knative Service, and a run cluster might not have build CRDs installed, such as a Cartographer workload. In these cases, 403 and 404 errors might be false positives.

You might receive the following error messages because these resources might not be required for your specific Tanzu Application Platform profile. These error messages are known issues:

- `Access error when querying cluster CLUSTER_NAME for resource KUBERNETES_RESOURCE_PATH (status: 401). Contact your administrator.`
- `Access error when querying cluster CLUSTER_NAME for resource KUBERNETES_RESOURCE_PATH (status: 403). Contact your administrator.`

- `Knative is not installed on CLUSTER_NAME (status: 404). Contact your administrator.`
- `Error when querying cluster CLUSTER_NAME for resource KUBERNETES_RESOURCE_PATH (status: 404). Contact your administrator.`

Accelerators page issues

Here are some common troubleshooting steps for errors displayed on the **Accelerators** page.

No accelerators

Symptom

When the `app_config.backend.reading.allow` section is configured in the `tap-values.yaml` file during the `tap-gui` package installation, there are no accelerators on the **Accelerators** page.

Cause

This section in `tap-values.yaml` overrides the default configuration that gives Tanzu Developer Portal access to the accelerators.

Solution

As a workaround, provide a value for Application Accelerator in this section. For example:

```
app_config:
  # Existing tap-values yaml above
  backend:
    reading:
      allow:
        - host: acc-server.accelerator-system.svc.cluster.local
```

Supporting ImageVulnerabilityScan issues

The following troubleshooting issues concern `ImageVulnerabilityScan`.

No Vulnerability data

Symptom

SCST - Scan 2.0 is enabled and there is no vulnerability data on the Security Analysis and Supply Chain Choreographer dashboards.

Cause

Tanzu Developer Portal lacks the required access to detect the new `ImageVulnerabilityScan` custom resource.

Solution

As a workaround, you can apply a ytt overlay to add permissions to the Kubernetes role that is used to access the `ImageVulnerabilityScan` resource. For more information about how overlays work with Tanzu Application Platform, see [Customize your package installation](#).

1. Create a `secret.yaml` file with a `Secret` that contains your ytt overlay. For example:

```

kind: Secret
metadata:
  name: add-tap-portal-ivs-permissions
  namespace: tap-install
  annotations:
    kapp.k14s.io/change-group: "tap-overlays"
type: Opaque
stringData:
  add-tap-portal-ivs-permissions.yaml: |
    #@ load("@ytt:overlay", "overlay")
    #@overlay/match by=overlay.subset({"metadata":{"name":"k8s-reader"}, "kind": "ClusterRole"})
    ---
    rules:
      #@overlay/append
      - apiGroups:
        - app-scanning.apps.tanzu.vmware.com
        resources:
        - imagevulnerabilityscans
        verbs:
        - get
        - watch
        - list

```

2. Apply the [Secret](#) to your cluster by running:

```
kubectl apply -f secret.yml
```

3. Update your values file to include a [package_overlays](#) field:

```

package_overlays:
- name: tap-gui
secrets:
- name: add-tap-portal-ivs-permissions

```

4. Update Tanzu Developer Portal with the new Tanzu Application Platform values by running:

```
tanzu package installed update tap -p tap.tanzu.vmware.com -n tap-install --values-file tap-values.yaml
```

Security Analysis plug-in issues

These are troubleshooting issues for the [Security Analysis plug-in](#).

Empty Impacted Workloads table

Symptom

The Impacted Workloads table is empty on the **CVE and Package Details** pages.

Cause

The relevant CVE belongs to a workload that has only completed one type of vulnerability scan (either image or source).

Solution

A fix is planned for Tanzu Developer Portal v1.5.1.

Supply Chain Choreographer plug-in issues

These are troubleshooting issues for the [Supply Chain Choreographer plug-in](#).

An error occurred while loading data from the Metadata Store

Symptom

In the Supply Chain Choreographer plug-in, you see the error message **An error occurred while loading data from the Metadata Store**.

tanzu-java-web-app-scan2

Supply Chain: source-test-scan-to-url Errors: 1
 Supply Chain Cluster: tkg-build-airgap-fuji
 Delivery Cluster: tkg-run-airgap-fuji-config

Stage Detail: Image Scanner
2 hours ago

Overview		Policy	
Registry	harbor-airgap.dapdaws.net	Name	scan-policy
Image	harbor-airgap.dapdaws.net/tap/workloads/tanzu-java-web-app-scan2-my-apps	UID	
Digest	sha256: [redacted]	Generation	1
Scan Template	tanzu-java-web-app-scan2	Details	No Violations Found
UID	[redacted]		
Generation	1		

❗ An error occurred while loading data from the Metadata Store:

CVE ID	Severity	Package	Version	Description

Cause

There are multiple potential causes. The most common cause is `tap-values.yaml` missing the configuration that enables Tanzu Developer Portal to communicate with Supply Chain Security Tools - Store.

Solution

See [Supply Chain Choreographer - Enable CVE scan results](#) for the necessary configuration to add to `tap-values.yaml`. After adding the configuration, update your Tanzu Application Platform deployment or Tanzu Developer Portal deployment with the new values.

SBOMs do not download when automatically configuring Tanzu Developer Portal for SCST - Store

Symptom

The auto configuration between Tanzu Developer Portal and SCST - Store prevents the SBOM feature from working. The SBOM feature was introduced in Tanzu Application Platform v1.6.

Cause

Backstage expects `allowedHeaders` values for SCST - Store to reply with proper XML and JSON SBOM responses. The `allowedHeaders` values are missing.

Solution

Edit your `tap-values.yaml` file so that `allowedHeaders` and the accompanying values are included:

```
tap_gui:
  app_config:
    proxy:
      /metadata-store:
        target: https://metadata-store-app.metadata-store:8443/api/v1
        changeOrigin: true
        secure: false
        allowedHeaders: ['Accept', 'Report-Type-Format']
        headers:
          Authorization: "Bearer ACCESS-TOKEN"
          X-Custom-Source: project-star
```

Where `ACCESS-TOKEN` is the token you obtained after creating a read-write service account. For more information, see [Manually connect Tanzu Developer Portal to Metadata Store](#).

Overview of Tanzu Developer Tools for IntelliJ

Tanzu Developer Tools for IntelliJ is the official VMware Tanzu IDE extension for IntelliJ IDEA. The extension helps you develop with Tanzu Application Platform and enables you to rapidly iterate on your workloads on supported Kubernetes clusters that have Tanzu Application Platform installed.

Tanzu Developer Tools for IntelliJ currently supports Java applications on macOS and Windows.

Extension features

This extension gives the following features:

- **Deploy applications directly from IntelliJ:**

Rapidly iterate on your applications on Tanzu Application Platform and deploy them as workloads directly from within IntelliJ.

- **See code updates running on-cluster in seconds:**

With the use of Live Update facilitated by Tilt, deploy your workload once, save changes to the code and then, seconds later, see those changes reflected in the workload running on the cluster.

- **Debug workloads directly on the cluster:**

Debug your application in a production-like environment by debugging on your Kubernetes cluster that has Tanzu Application Platform. An environment's similarity to production relies on keeping dependencies updated, among other variables.

- **See workloads running on the cluster:**

From the Workloads panel you can see any workload found within the cluster and namespace specified in the current kubectl context.

- **Work with microservices in a Java monorepo:**

Tanzu Developer Tools for IntelliJ v1.3 and later supports working with a monorepo containing multiple modules that represent different microservices. This makes it possible to deploy, debug, and Live Update multiple workloads simultaneously from the same IntelliJ multimodule project. For more information about projects with multiple modules, see the [IntelliJ documentation](#). For more information about a typical monorepo setup, see [Working with microservices in a monorepo](#).

**Note**

The new variation of Out of the Box (OOTB) Basic supply chains, which outputs Carvel packages to enable configuring multiple runtime environments, is not currently supported. For more information about the variation, see [Carvel Package Supply Chains](#).

Next steps

Follow the steps to [install the extension](#).

Overview of Tanzu Developer Tools for IntelliJ

Tanzu Developer Tools for IntelliJ is the official VMware Tanzu IDE extension for IntelliJ IDEA. The extension helps you develop with Tanzu Application Platform and enables you to rapidly iterate on your workloads on supported Kubernetes clusters that have Tanzu Application Platform installed.

Tanzu Developer Tools for IntelliJ currently supports Java applications on macOS and Windows.

Extension features

This extension gives the following features:

- **Deploy applications directly from IntelliJ:**

Rapidly iterate on your applications on Tanzu Application Platform and deploy them as workloads directly from within IntelliJ.

- **See code updates running on-cluster in seconds:**

With the use of Live Update facilitated by Tilt, deploy your workload once, save changes to the code and then, seconds later, see those changes reflected in the workload running on the cluster.

- **Debug workloads directly on the cluster:**

Debug your application in a production-like environment by debugging on your Kubernetes cluster that has Tanzu Application Platform. An environment's similarity to production relies on keeping dependencies updated, among other variables.

- **See workloads running on the cluster:**

From the Workloads panel you can see any workload found within the cluster and namespace specified in the current kubectl context.

- **Work with microservices in a Java monorepo:**

Tanzu Developer Tools for IntelliJ v1.3 and later supports working with a monorepo containing multiple modules that represent different microservices. This makes it possible to deploy, debug, and Live Update multiple workloads simultaneously from the same IntelliJ multimodule project. For more information about projects with multiple modules, see the [IntelliJ documentation](#). For more information about a typical monorepo setup, see [Working with microservices in a monorepo](#).

**Note**

The new variation of Out of the Box (OOTB) Basic supply chains, which outputs Carvel packages to enable configuring multiple runtime environments, is not

currently supported. For more information about the variation, see [Carvel Package Supply Chains](#).

Next steps

Follow the steps to install the extension.

Install Tanzu Developer Tools for IntelliJ

This topic explains how to install the VMware Tanzu Developer Tools for IntelliJ IDE extension. The extension currently only supports Java applications on macOS and Windows.

Prerequisites

Before installing the extension, you must have:

- [IntelliJ](#)
- [kubectl](#)
- [Tilt v0.30.12](#) or later
- [Tanzu CLI and plug-ins](#)
- [A cluster with the Tanzu Application Platform Full profile or Iterate profile](#)



Note

If you are an app developer, someone else in your organization might have already set up the Tanzu Application Platform environment.

Install

To install VMware Tanzu Developer Tools for IntelliJ:

1. Download VMware Tanzu Developer Tools for IntelliJ from the [Broadcom Support Portal](#).
2. Open IntelliJ.
3. Open the **Preferences** pane and then go to **Plugins**.
4. Click the gear icon and then click **Install Plugin from disk...**

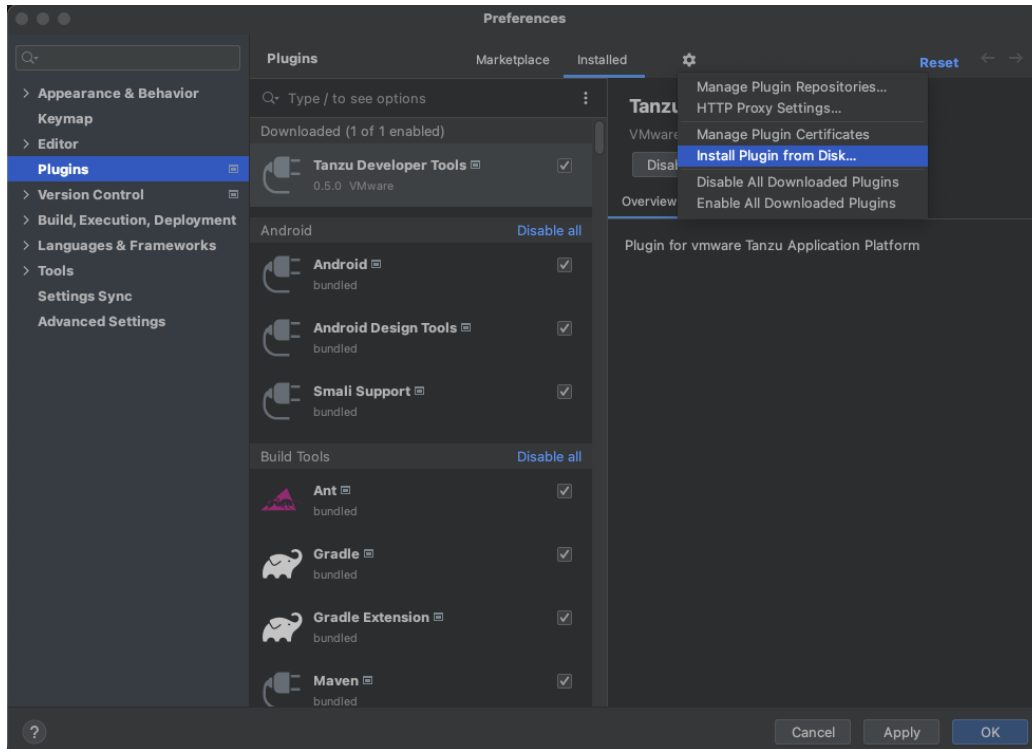

5. Use the file picker to select the ZIP file downloaded from the Broadcom Support Portal.

Update

To update to a later version, repeat the steps in the [Install](#) section. You do not need to uninstall the current version.

Uninstall

To uninstall the VMware Tanzu Developer Tools for IntelliJ:

1. Open the **Preferences** pane and then go to **Plugins**.
2. Select the extension, click the gear icon, and then click **Uninstall**.
3. Restart IntelliJ.

Next steps

Proceed to [Getting started](#).

Get Started with Tanzu Developer Tools for IntelliJ

This topic guides you through getting started with Tanzu Developer Tools for IntelliJ.

Prerequisite

Install [Tanzu Developer Tools for IntelliJ](#).

Configure Local Source Proxy or use a source image registry

Configure Local Source Proxy if you're able to do so. For more information, see the [Local Source Proxy documentation](#).

If you cannot use Local Source Proxy, use a source image registry. Before deploying a workload, you must authenticate with an image registry to store your source code. You can use the Docker CLI to authenticate or you can set environment variables that the Tanzu CLI can use to authenticate.

Docker CLI

To authenticate by using the Docker CLI, run:

```
docker login $REGISTRY_HOSTNAME -u $REGISTRY_USERNAME -p $REGISTRY_PASSWORD
```

Tanzu CLI

To authenticate by using the Tanzu CLI, export environment variables by running:

```
export TANZU_APPS_REGISTRY_CA_CERT=PATH-TO-CA-CERT.nip.io.crt
export TANZU_APPS_REGISTRY_PASSWORD=USERNAME
export TANZU_APPS_REGISTRY_USERNAME=PASSWORD
```

`CA_CERT` is only needed for a custom or private registry.

For more information, see [Workload creation fails due to authentication failure in Docker Registry](#).

Run Tanzu Developer Tools for IntelliJ

Run IntelliJ from a CLI, instead of through your operating system GUI, to avoid restricting the set of environment variables the app receives. This is especially relevant for macOS.

Limited environment variables can cause problems with cluster authentication for Tanzu Developer Tools for IntelliJ. For example, a common situation is that a sanitized `PATH` does not provide access to the `gke-cloud-auth-plugin` installed on your system. This makes Tanzu Developer Tools for IntelliJ unable to authenticate and access your GKE cluster.

This situation is complex and different things can go wrong depending on:

- Precisely how you installed various cloud-related CLI tools
- How you set environment variables
- Your OS version
- Which cloud provider and authentication method you are using

All of these problems are most easily avoided by running IntelliJ from a CLI. Run IntelliJ from a CLI in macOS by running:

```
open /Applications/IntelliJ\ IDEA.app
```

Set up Tanzu Developer Tools for IntelliJ

The extension makes use of the following files within your project:

- `workload.yaml`
- `catalog-info.yaml`
- `Tiltfile`
- `.tanzuignore`

You can create these files by using the instructions in this topic, or use the files in the [View an example project](#) section.

There are two ways to create these files:

- Using the code snippets that Tanzu Developer Tools provide, which create templates in empty files that you then fill in with the required information.
- Writing the files manually.

Create the `workload.yaml` file

You must include a file named `workload.yaml` in your project. For example, `my-project/config/workload.yaml`.

`workload.yaml` provides instructions to Supply Chain Choreographer about how to build and manage a workload. For more information, see [Supply Chain Choreographer for Tanzu](#).

The Tanzu Developer Tools for IntelliJ extension requires only one `workload.yaml` file per project. `workload.yaml` must be a single-document YAML file, not a multi-document YAML file.

To create a `workload.yaml` file by using code snippets:

1. Right-click the IntelliJ project explorer and then click **New**.
2. Select the Tanzu workload.
3. Add the filename `workload`.
4. Fill in the template.

See the following `workload.yaml` example:

```
apiVersion: carto.run/v1alpha1
kind: Workload
metadata:
  name: APP-NAME
  labels:
    apps.tanzu.vmware.com/workload-type: WORKLOAD-TYPE
    app.kubernetes.io/part-of: APP-NAME
spec:
  source:
    git:
      url: GIT-SOURCE-URL
      ref:
        branch: GIT-BRANCH-NAME
```

Where:

- `APP-NAME` is the name of your application. For example, `my app`.
- `WORKLOAD-TYPE` is the type of workload for your app. For example, `web`. For more information, see [Workload types](#).
- `GIT-SOURCE-URL` is the Git source code URL for your app. For example, `github.com/mycompany/myapp`.
- `GIT-BRANCH-NAME` is the branch of the Git source code you want to use. For example, `main`.

Alternatively you can use the Tanzu CLI to create a `workload.yaml` file. For more information about the relevant Tanzu CLI command, see [Tanzu apps workload apply](#).

Create the `catalog-info.yaml` file

You must include a file named `catalog-info.yaml` in your project. For example, `my-project/catalog/catalog-info.yaml`.

`catalog-info.yaml` enables the workloads created with Tanzu Developer Tools for IntelliJ to be visible in Tanzu Developer Portal (formerly named Tanzu Application Platform GUI). For more information, see [Overview of Tanzu Developer Portal](#).

To create a `catalog-info.yaml` file by using the code snippets:

1. Right-click the IntelliJ project explorer and then click **New**.
2. Select the Tanzu Catalog.
3. Add the filename `catalog-info`.
4. Fill in the template.

See the following `workload.yaml` example:

```
apiVersion: backstage.io/v1alpha1
kind: Component
metadata:
  name: APP-NAME
  description: APP-DESCRIPTION
  tags:
    - tanzu
  annotations:
    'backstage.io/kubernetes-label-selector': 'app.kubernetes.io/part-of=APP-NAME'
spec:
  type: service
  lifecycle: experimental
  owner: default-team
```

Where:

- `APP-NAME` is the name of your application.
- `APP-DESCRIPTION` is a description of your application.

Create the Tiltfile file

In your project you must include a file named `Tiltfile` with no extension (no filetype), such as `my-project/Tiltfile`.

The `Tiltfile` provides the configuration for Tilt to enable your project to [Live Update](#) on the Tanzu Application Platform-enabled Kubernetes cluster. For more information, see the [Tilt documentation](#).

The Tanzu Developer Tools for IntelliJ extension requires only one Tiltfile per project.

The following is an example `Tiltfile`:

```
LOCAL_PATH = os.getenv("LOCAL_PATH", default='.')
NAMESPACE = os.getenv("NAMESPACE", default='default')

k8s_custom_deploy(
  'APP-NAME',
  apply_cmd="tanzu apps workload apply -f PATH-TO-WORKLOAD-YAML --live-update" +
    " --local-path " + LOCAL_PATH +
    " --namespace " + NAMESPACE +
    " --yes >/dev/null" +
    " && kubectl get workload APP-NAME --namespace " + NAMESPACE + " -o yaml",
  delete_cmd="tanzu apps workload delete -f PATH-TO-WORKLOAD-YAML --namespace " + NAMESPACE + " --yes",
  deps=['pom.xml', './target/classes'],
  container_selector='workload',
```

```

live_update=[
  sync('./target/classes', '/workspace/BOOT-INF/classes')
]
)

k8s_resource('APP-NAME', port_forwards=["8080:8080"],
  extra_pod_selectors=[{'carto.run/workload-name': 'APP-NAME', 'app.kubernetes.io/com
ponent': 'run'}])
allow_k8s_contexts('CONTEXT-NAME')

```

Where:

- `APP-NAME` is the name of your application.
- `PATH-TO-WORKLOAD-YAML` is the local file system path to your `workload.yaml` file. For example, `config/workload.yaml`.
- `CONTEXT-NAME` is the name of your current [Kubernetes context](#). If your Tanzu Application Platform-enabled Kubernetes cluster is running on your local machine, you can remove the entire `allow_k8s_contexts` line. For more information about this line, see the [Tilt documentation](#).

If you want to compile the source image from a local directory other than the project directory, change the value of `local path`. For more information, see [local path](#) in the glossary.

Create the `.tanziignore` file

In your project, you can include a file named `.tanziignore` with no file extension. For example, `my-project/.tanziignore`.

When working with local source code, `.tanziignore` excludes files from the source code that are uploaded within the image. It has syntax similar to the `.gitignore` file.

For an example, see the [.tanziignore file](#) in GitHub that is used for the sample Tanzu Java web app. You can use the file as it is or edit it for your needs.

View an example project

Before you begin, you need a container image registry to use the sample application. There are two ways to view a sample application that demonstrates the necessary configuration files.

Use Application Accelerator

If your company has configured [Application Accelerator](#), you can obtain the sample application there if it was not removed. To view the example using Application Accelerator:

1. Open Application Accelerator. The Application Accelerator location varies based on where your company placed it. Contact the appropriate team to learn its location.
2. Search for [Tanzu Java Web App](#) in the Application Accelerator.
3. Add the required configuration information and generate the application.
4. Unzip the application and open the directory in IntelliJ.

Clone from GitHub

To clone the example from GitHub:

1. Use `git clone` to clone the [application-accelerator-samples](#) repository from GitHub.
2. Go to the `tanzu-java-web-app` directory.
3. Open the `Tiltfile` and replace `your-registry.io/project` with your registry.

Next steps

Use [Tanzu Developer Tools for IntelliJ](#).

Use Tanzu Developer Tools for IntelliJ

Ensure that the project you want to use the Tanzu Developer Tools for IntelliJ extension with has the required files specified in [Getting started](#).

The extension requires only one Tiltfile and one `workload.yaml` file per project. `workload.yaml` must be a single-document YAML file, not a multi-document YAML file.

Workload Actions

The extension enables you to apply, debug, and Live Update your application on a Kubernetes cluster that has Tanzu Application Platform. The developer sandbox experience enables developers to Live Update their code and simultaneously debug the updated code, without having to deactivate Live Update when debugging.

Apply a workload

The extension enables you to apply workloads on your Kubernetes cluster that has Tanzu Application Platform.

To apply a workload:

1. Right-click anywhere in the IntelliJ project explorer and click **Tanzu > Apply Workload** or right-click on an associated workload in the Workloads panel and click **Apply Workload**.
2. Click **Tanzu > Modify Apply Configuration**.

The `Tanzu workload apply` command is triggered in the terminal and the workload is applied. A new workload appears on the Tanzu panel.

Delete a workload

The extension enables you to delete workloads on your Kubernetes cluster that has Tanzu Application Platform.

To delete a workload right-click anywhere in the IntelliJ project explorer and click **Tanzu > Delete Workload** or right-click on an associated workload in the Workloads panel and click **Delete Workload**.

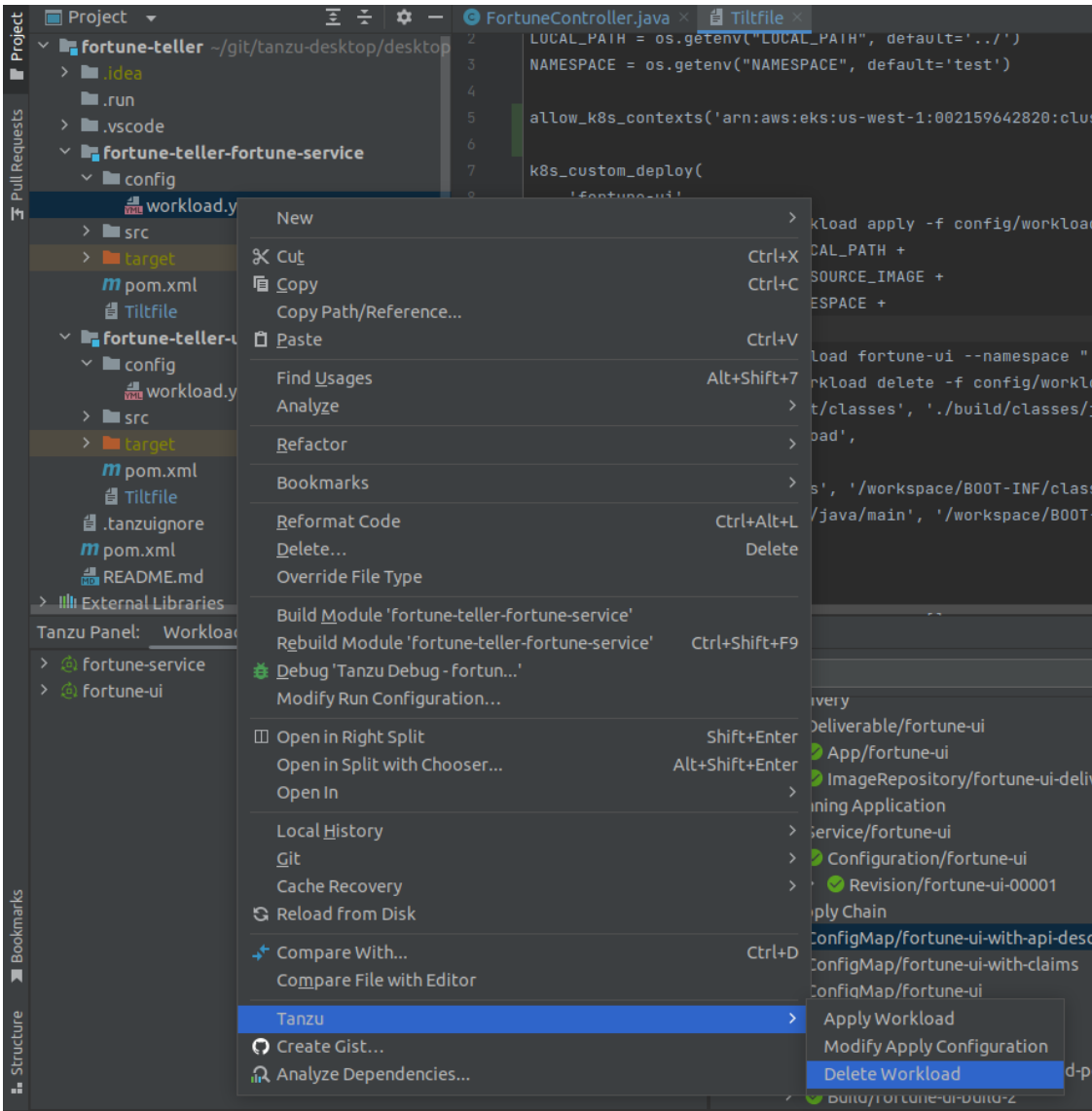

A message appears that prompts you to delete the workload and not warn again, delete the workload, or cancel. A notification appears showing that the workload was deleted.

Debugging on the cluster

The extension enables you to debug your application on a Kubernetes cluster that has Tanzu Application Platform.

Debugging requires a single-document `workload.yaml` file in your project. For how to create `workload.yaml`, see [Set up Tanzu Developer Tools](#).

The developer sandbox experience enables developers to Live Update their code, and simultaneously debug the updated code, without having to deactivate Live Update when debugging.

Start debugging on the cluster

To start debugging on the cluster:

1. Add a [breakpoint](#) in your code.
2. Right-click the `workload.yaml` file in your project and click **Debug 'Tanzu Debug Workload...'** in the pop-up menu or right-click on an associated workload in the Workloads

panel and click **Debug Workload**.

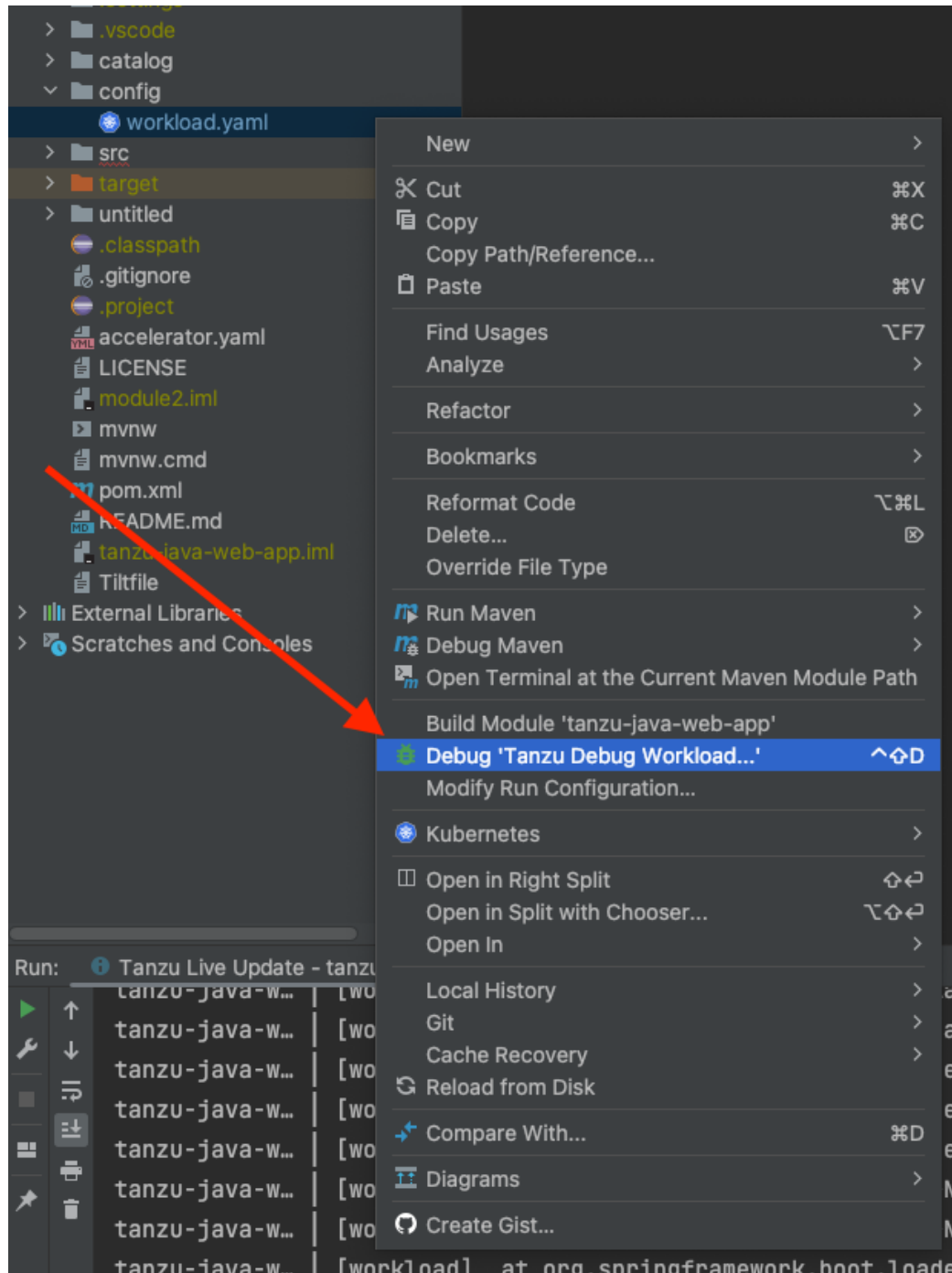

3. Ensure that the configuration parameters are set:
 - o **Source Image:** This is the registry location for publishing local source code. For example, `registry.io/yourapp-source`. The source image parameter is optional if you have configured Local Source Proxy.
 - o **Local Path:** This is the path on the local file system to a directory of source code to build.
 - o **Namespace:** This is the namespace that workloads are deployed into.

You can also manually create Tanzu Debug configurations by using the **Edit Configurations** IntelliJ UI.

Stop Debugging on the Cluster

Click the stop button in the **Debug** overlay to stop debugging on the cluster.



Live Update

See the following sections for how to use Live Update.

Start Live Update

Before using Live Update, verify that your auto-save setting is either off or on with a delay. The delay must be long enough for the application to restart between auto saves to allow enough time for your app to Live Update when files change. This auto-save setting is in **Preferences > Appearance & Behavior > System Settings > Autosave**.

To start Live Update:

1. Right-click your project's Tiltfile and then click **Run 'Tanzu Live Update - ...'** or right-click on an associated workload in the Workloads panel and then click **Live Update Workload**.
2. Ensure that the configuration parameters are set:
 - o **Source Image:** This is the registry location for publishing local source code. For example, `registry.io/yourapp-source`. It must include both a registry and a project name. The source image parameter is optional if you have configured Local Source Proxy.
 - o **Local Path:** This is the path on the local file system to a directory of source code to build.
 - o **Namespace:** This is the namespace that workloads are deployed into.

Note

You must compile your code before the changes are synchronized to the container. For example, **Build Project: ⌘+F9**.

Stop Live Update

To stop Live Update, use the native controls to stop the Tanzu Live Update Run Configuration that is running.

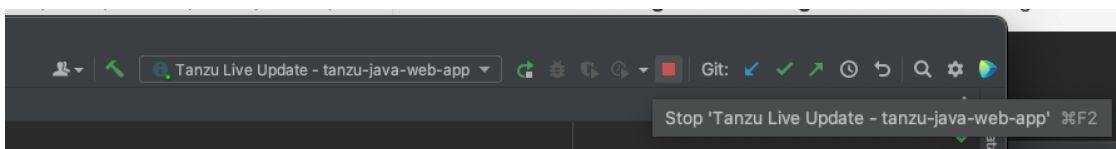

Tanzu Workloads panel

The current state of the workloads is visible in the Tanzu Workloads view. This view is a separate section in the bottom of the Explorer view in the Side Bar. The view shows the current status of each workload, namespace, and cluster. It also shows whether Live Update and Debug is running, stopped, or deactivated.

The Tanzu Activity tab in the Panels view enables developers to visualize the supply chain, delivery, and running application pods. The tab enables a developer to view and describe logs on each resource associated with a workload from within their IDE. The tab displays detailed error messages for each resource in an error state.

Workload commands are available from the Tanzu Workloads panel on workloads that have an associated module in the current project.

This association is based on a module name and a workload name matching. For example, a project with a module named `my-app` is associated with a deployed workload named `my-app`.

When taking an action from the Tanzu Workloads panel, the action uses the namespace of the deployed workload regardless of the configuration in the module.

For example, you might have a Live Update configuration with a namespace argument of `my-apps-1`, but running the action from a deployed workload in namespace `my-apps-2` starts a Live Update session with a namespace argument of `my-apps-2`.

The Tanzu Workloads panel uses the cluster and defaults to the namespace specified in the current kubectl context.

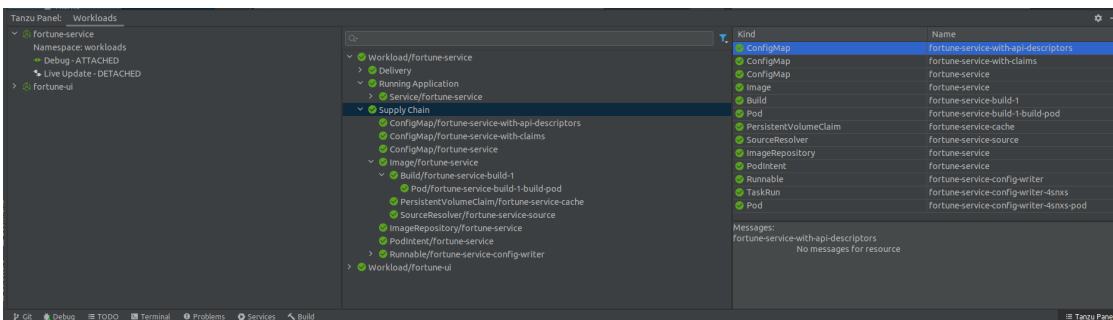

To add a namespace:

1. View the current context and namespace by running:

```
kubectl config get-contexts
```

2. Set a namespace for the current context by running:

```
kubectl config set-context --current --namespace=YOUR-NAMESPACE
```

3. If you are using the `KUBECONFIG` environment variable to organize access to different clusters on macOS, use the CLI to run the IDE instead of Dock or Spotlight. For why, see [Troubleshooting](#).

To add additional namespaces to your Workloads panel:

1. Click on the gear icon in the upper right corner of the Workloads panel.
2. Click on **Select Namespaces...**
3. Select the checkboxes of the namespaces that you want to add to your panel.

Working with microservices in a monorepo

A monorepo is single Git repository that contains multiple workloads. Each individual workload is placed in a subfolder of the main repository.

You can find an example of this in [Application Accelerator](#).

The relevant accelerator is called Spring SMTP Gateway, and you can obtain its source code as an accelerator or directly from the [application-accelerator-samples](#) GitHub repository.

This project is an example of a typical layout:

- `MONO-REPO-ROOT/`
 - `pom.xml` (parent pom)
 - `microservice-app-1/`
 - `pom.xml`
 - `mvnw` (and other mvn-related files for building the workload)
 - `Tiltfile` (supports Live Update)
 - `config`
 - `workload.yaml` (supports deploying and debugging from IntelliJ)
 - `src/` (contains source code for this microservice)
 - `microservice-app-2/`
 - ...similar layout

Recommended structure: Microservices that can be built independently

In this example, each of the microservices can be built independently of one another. Each subfolder contains everything needed to build that workload.

This is reflected in the `source` section of `workload.yaml` by using the `subPath` attribute:

```
apiVersion: carto.run/v1alpha1
kind: Workload
metadata:
  name: microservice-app-1
  ...
spec:
  source:
    git:
      ref:
        branch: main
      url: https://github.com/kdvolder/sample-mono-repo.git
      subPath: microservice-app-1 # build only this
    ...
```

For setting up your own repositories, it's best practice to set up a monorepo so that each microservice can be built completely independently.

To work with these monorepos:

1. Import the monorepo as a project into IntelliJ.
2. Interact with each of the subfolders as you would interact with a project containing a single workload.

Alternative structure: Services with build-time interdependencies

Some monorepos do not have submodules that can be independently built. Instead the `pom.xml` files of the submodules are set up to have some build-time interdependencies. For example:

- A submodule `pom.xml` can reference the parent `pom.xml` as a common place for centralized dependency management.
- A microservice submodule can reference another, as a maven dependency.
- Several microservice submodules can reference one or more shared library modules.

For these projects, make these adjustments:

1. Make `workload.yaml` point to the repository root, not a subfolder. Because submodules have dependencies on code outside of their own subfolder, all source code from the repository must be supplied to the workload builder.
2. Make `workload.yaml` specify additional buildpack arguments through environment variables. They differentiate the submodule that the build is targeting.

Both of these `workload.yaml` changes are in the following example:

```
apiVersion: carto.run/v1alpha1
kind: Workload
metadata:
  name: fortune-ui
  labels:
    apps.tanzu.vmware.com/workload-type: web
    app.kubernetes.io/part-of: fortune-ui
spec:
  build:
    env:
      - name: BP_MAVEN_BUILD_ARGUMENTS
        value: package -pl fortune-teller-ui -am # indicate which module to build.
      - name: BP_MAVEN_BUILT_MODULE
        value: fortune-teller-ui # indicate where to find the built artefact to deploy.
  source:
    git:
      url: https://github.com/my-user/fortune-teller # repository root
      ref:
        branch: main
```

For more information about these and other `BP_XXX` buildpack parameters, see the [Buildpack documentation](#).

3. Make the local path attribute in the launch configuration for each workload point to the path of the repository root. Because submodules have dependencies on code outside of their own subfolder, all source code from the repository must be supplied to the workload builder.

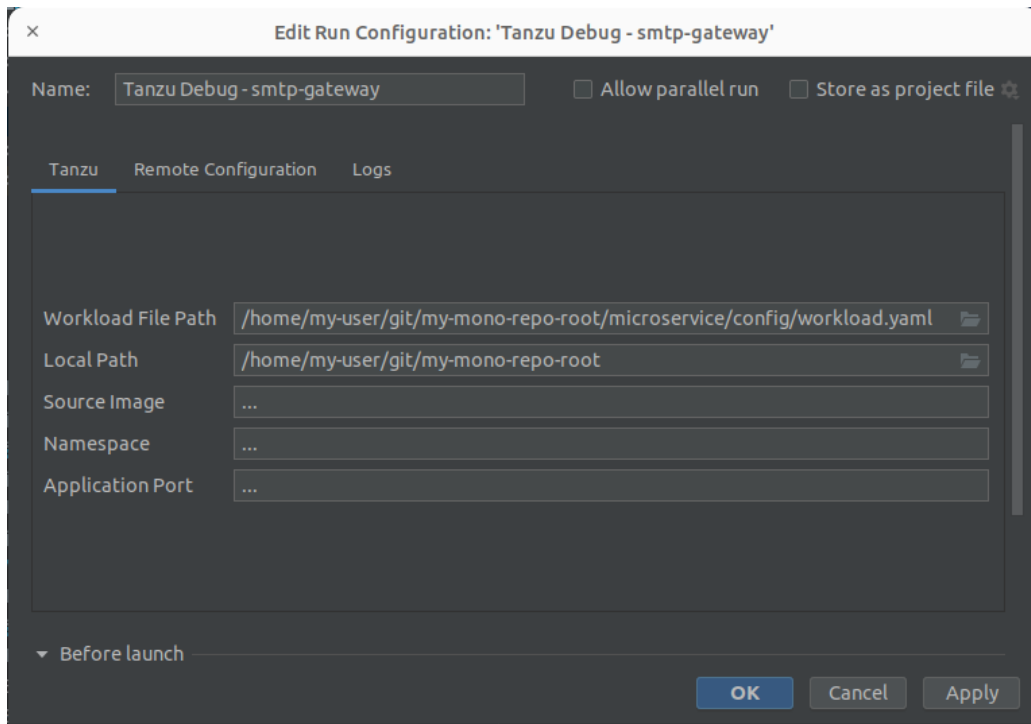

Change logging verbosity

The Tanzu Language Server saves logs to `~/tanzu-langserver.log`. You can change the log verbosity in **Preferences > Tools > Tanzu Developer Tools**.

Work with Native Image for Java

Native Image is technology for compiling Java code ahead of time to a binary, which is a native executable file. For more information about Native Image, see the [GraalVM documentation](#).

Native Image requires some changes to your `workload.yaml` files, such as adding new environment variables to the build section of the workload specifications:

```
spec:
  build:
    env:
      - name: BP_NATIVE_IMAGE
        value: "true"
      - name: BP_MAVEN_BUILD_ARGUMENTS
        value: -Dmaven.test.skip=true --no-transfer-progress package -Pnative
      - name: BP_JVM_VERSION
        value: 17 ## only JVM 17 and later versions support native images. Depending on
        your configuration, this might already be the default value.
```

Use native images with Maven

If you are using Maven, you must also add a native profile that includes `native-maven-plugin` for the build phase in `pom.xml`:

```
<profiles>
  <profile>
    <id>native</id>
    <build>
      <plugins>
        <plugin>
          <groupId>org.graalvm.buildtools</groupId>
```

```

        <artifactId>native-maven-plugin</artifactId>
      </plugin>
    </plugins>
  </build>
</profile>
</profiles>

```

Supported Features

There are some differences on supported features when working with Native images:

- You can deploy workloads with native images by running the [Tanzu: Apply Workload command](#).
- You can delete workloads with native images by running the [Tanzu: Delete Workload command](#).
- Debug and Live Update are not supported when using native images. However you can add an additional `workload.yaml` file that doesn't use a native image to iterate on your development.

This example `workload.yaml` specification has a native image flag:

```

...
spec:
  build:
    env:
      - name: BP_NATIVE_IMAGE
        value: "true"
...

```

This example `workload.yaml` specification doesn't have a native image flag:

```

...
spec:
  build:
    env:
      #- name: BP_NATIVE_IMAGE
      #  value: "true"
...

```

The Tanzu Workloads panel adds the `Native` label to any workloads that contain native images.

```

▼  tanzu-java-web-app-native (js-test)
  - Debug - NOT ENABLED
  - Live Update - NOT ENABLED
  Native

```

Glossary of terms

This topic gives you explanations of common terms used throughout the Tanzu Developer Tools for IntelliJ documentation, and within the extension itself. Some of these terms are unique to Tanzu Application Platform, while others might have a different meaning outside of Tanzu Application Platform and are included here for clarification.

Live Update

Live Update, facilitated by [Tilt](#), enables you to deploy your workload once, save changes to the code, and see those changes reflected in the workload running on the cluster within seconds.

Tiltfile

The Tiltfile is a file with no extension that is required for Tilt to enable the Live Update feature. For more information about the Tiltfile, see the [Tilt documentation](#).

Debugging on the cluster

The Tanzu Developer Tools on IntelliJ extension enables you to debug your application in an environment similar to production by debugging on your Tanzu Application Platform enabled Kubernetes cluster.



Note

An environment's similarity to production relies on keeping dependencies updated, among other variables.

YAML file format

YAML is a human-readable data-serialization language. It is commonly used for configuration files. For more information, see the [YAML Wikipedia entry](#).

workload.yaml file

The workload YAML file is a required configuration file used by the Tanzu Application Platform to specify the details of an application including its name, type, and source code URL.

catalog-info.yaml file

The catalog-info YAML file enables the workloads created with the Tanzu Developer Tools for IntelliJ extension to be visible in [Tanzu Developer Portal](#).

Code snippet

[Code snippets](#) enable you to quickly add project files that are necessary to develop using Tanzu Application Platform by creating a template in an empty file that you fill out with the required information.

Source image

The source image is the registry location to publish local source code, for example, `registry.io/yourapp-source`. This must include both a registry and a project name.

Local path

The local path value tells the Tanzu Developer Tools for IntelliJ extension which directory on your local file system to bring into the [source image](#) container image. The default local path value is the current directory where you saved the files for your open IntelliJ project.

Kubernetes context

A Kubernetes context is a set of access parameters that contains a Kubernetes cluster, a user, and a namespace. A Kubernetes context acts like a set of coordinates that describe the target of the Kubernetes commands that you run. For more information, see the [Kubernetes documentation](#).

Kubernetes namespace

As defined by the [Kubernetes documentation](#), in Kubernetes, namespaces provide a mechanism for isolating groups of resources within a single cluster. Names of resources need to be unique within a namespace, but not across namespaces.

Troubleshoot Tanzu Developer Tools for IntelliJ

This topic helps you troubleshoot issues with Tanzu Developer Tools for IntelliJ.

Unable to view workloads on the panel when connected to GKE cluster

Symptom

When connecting to Google's GKE clusters, an error appears with the text `WARNING: the gcp auth plugin is deprecated in v1.22+, unavailable in v1.25+; use gcloud instead`.

Cause

GKE authentication was extracted into a separate plug-in and is no longer inside the Kubernetes client or libraries.

Solution

Download and configure the GKE authentication plug-in. For instructions, see the [Google documentation](#).

Deactivated launch controls after running a launch configuration

Symptom

When you run or debug a launch configuration, IntelliJ deactivates the launch controls.

Cause

IntelliJ deactivates the launch controls to prevent other launch configurations from being launched at the same time. These controls are reactivated when the launch configuration is started. As such,

starting multiple Tanzu debug and live update sessions is a synchronous activity.

Starting a Tanzu Debug session fails with `Unable to open debugger port`

Symptom

You try to start a Tanzu Debug session and it immediately fails with an error message similar to:

```
Error running 'Tanzu Debug - fortune-teller-fortune-service': Unable to open debugger port (localhost:5005): java.net.ConnectException "Connection refused"
```

Cause

Old Tanzu Debug launch configurations sometimes appear to be corrupted after installing a later version of the plug-in. You can see whether this is the problem you are experiencing by opening the launch configuration:

1. Right-click `workload.yaml`.
2. Click **Modify Run Configuration...** in the menu.
3. Scroll down and expand the **Before Launch** section of the dialog.
4. Verify that it contains the two Unknown Task entries `com.vmware.tanzu.tanzuBeforeRunPortForward` and `com.vmware.tanzu.tanzuBeforeRunWorkloadApply`.

Because these two tasks are unknown causes, these steps of the debug launch are not run. This in turn means that the target application is not deployed and accessible on the expected port, which causes an error when the debugger tries to connect to it.

It might be that although the launch configuration appears corrupt when seen in the launch config editor, in fact there is no corruption. It's suspected that this problem only occurs when you install a new version of the plug-in and start using it before first restarting IntelliJ.

There is possibly an issue in the IntelliJ platform that prevents completely or correctly initializing the plug-in when the plug-in is hot-swapped into an active session instead of loaded on startup.

Solution

Closing and restarting IntelliJ typically fixes this problem. If that doesn't work for you, delete the old corrupted launch configuration and recreate it.

Timeout error when Live Updating

Symptom

When you attempt to Live Update your workload, the following error message appears in the log:

```
ERROR: Build Failed: apply command timed out after 30s - see https://docs.tilt.dev/v/api.html#api.update\_settings for how to increase
```

Cause

Kubernetes times out on upserts over 30 seconds.

Solution

Add `update_settings (k8s_upsert_timeout_secs = 300)` to the Tiltfile. For more information, see the [Tiltfile documentation](#).

Tanzu Panel empty when using a GKE cluster on macOS

Symptom

On macOS, the Tanzu Panel doesn't display workloads or any other resources when using a GKE cluster. Other tools, such as the [Tanzu CLI Apps plug-in](#), display resources correctly.

Cause

`gke-cloud-auth-plugin` is required to properly authenticate to a GKE cluster. However, when starting IntelliJ from Dock or Spotlight, environment variables set by using `.profile`, `.bash_profile`, or `.zshrc` are not available. For more information, see this [YouTrack issue](#).

This might cause `gke-cloud-auth-plugin` to be missing from `PATH` when launching IntelliJ and prevent the Tanzu Panel from reaching the cluster.

Solution

Open IntelliJ from the CLI. Example command:

```
open /Applications/IntelliJ\ IDEA.app
```

Tanzu Panel is empty when the context is set by using the `KUBECONFIG` environment variable

Symptom

On macOS, the Tanzu Panel doesn't display workloads or any other resources when setting the Kubernetes context by using a `KUBECONFIG` environment variable. Other tools, such as the [Tanzu CLI Apps plug-in](#), display resources correctly.

Cause

When starting IntelliJ from Dock or Spotlight, environment variables set by using `.profile`, `.bash_profile`, or `.zshrc` are not available. This causes the panels to be empty because the extension can't find the right Kubernetes context. For more information, see this [YouTrack issue](#).

Solution

Open IntelliJ from the CLI. For example:

```
open /Applications/IntelliJ\ IDEA.app
```

Tanzu panel shows workloads but doesn't show Kubernetes resources

Symptom

The Tanzu panel shows workloads but doesn't show Kubernetes resources in the center panel of the activity pane.

Cause

When switching the Kubernetes context, the activity pane doesn't automatically update the namespace, but the workload pane detects the new namespace. Therefore, the Tanzu panel shows workloads but doesn't show Kubernetes resources in the center panel of the activity pane.

Solution

Restart IntelliJ to properly detect the context change.

Tanzu Workloads panel workloads only have describe and delete action

Symptom

Some or all workloads in the Tanzu Workloads panel only have describe and delete actions.

Cause

By design, only associated workloads have apply, debug, and Live Update workload actions available.

Solution

Open a project that contains a module that can be associated with your deployed workloads.

Workload actions do not work when in a project with spaces in the name

Symptom

Workload actions and Live Update do not work. The console displays an error message similar to:

```
Error: unknown command "projects/my-app" for "apps workload apply". Process finished with exit code 1
```

Cause

Improper handling of paths that contain spaces causes the shell to misinterpret some commands, such as `tanzu workload apply ...`. This causes anything executing these commands to fail when the name of a project, or any parts of its path on disk, contain spaces.

Solution

1. Close the code editor.
2. Move or rename your project folder on the disk, ensuring that no part of its path contains any spaces.
3. Delete the project settings folder from the project to start with a clean slate. The folder is `.idea` if using IntelliJ and `.vscode` if using VS Code.
4. Open the code editor and then open the project in its new location.

A lock wrongly prevents Live Update from starting again

Symptom

A lock incorrectly shows that Live Update is still running and prevents Live Update from starting again.

Cause

Restarting your computer while running Live Update without terminating the Tilt process beforehand.

Solution

Delete the Tilt lock file. The default location for the file is `~/.tilt-dev/config.lock`.

UI liveness check causes an EDT Thread Exception error

Symptom

An **EDT Thread Exception** error is logged or reported as a notification with a message similar to `"com.intellij.diagnostic.PluginException: 2007 ms to call on EDT TanzuApplyAction#update@ProjectViewPopup"`.

Cause

A UI liveness check detected something taking more time than planned on the UI thread and freezing the UI. You might experience a brief UI freeze at the same time. This happens more commonly when starting IntelliJ because some initialization processes are still running. This issue is also commonly reported by users with large projects.

If slow startup processes cause the issue, the UI freeze is likely to be brief. If a large number of files causes the issue, the UI freeze is likely to be more severe.

Solution

There is no workaround currently other than trying to reduce the number of files in your project, though that might not be practical in some cases. A fix is planned for the next release.

Frequent application restarts

Symptom

When an application is applied from IntelliJ it restarts frequently.

Cause

An application or environment behavior is triggering the application to restart.

Observed trigger behaviors include:

- The application itself writing logs to the file system in the application directory that Live Update is watching
- Autosave being set to a very high frequency in the IDE configuration

Solution

Prevent the trigger behavior. Example solutions include:

- Prevent 12-factor applications from writing to the file system.
- Reduce the autosave frequency to once every few minutes.

Overview of Tanzu Developer Tools for Visual Studio

VMware Tanzu Developer Tools for Visual Studio is the official VMware Tanzu IDE extension for Visual Studio 2022. The extension helps you develop with Tanzu Application Platform and enables you to rapidly iterate on your workloads on supported Kubernetes clusters that have Tanzu Application Platform installed.

Tanzu Developer Tools for Visual Studio currently supports .NET C# applications.

This extension is for Microsoft Visual Studio 2022 only. It is incompatible with Visual Studio Code and Visual Studio for Mac.



Note

This extension is in the beta stage of development.

Extension features

The extension has the following features:

- **Deploy applications directly from Visual Studio:**

Rapidly iterate on your applications on Tanzu Application Platform and deploy them as workloads directly from within Visual Studio.

- **See code updates running on-cluster in seconds:**

With the use of Live Update facilitated by Tilt, deploy your workload once, save changes to the code and then, seconds later, see those changes reflected in the workload running on the cluster.

- **Debug workloads directly on the cluster:**

Debug your application in a production-like environment by debugging on your Kubernetes cluster that has Tanzu Application Platform. An environment's similarity to production relies on keeping dependencies updated, among other variables.

- **See workloads running on the cluster:**

From the Tanzu Panel, you can see any workload found within the cluster and namespace specified in the current kubectl context.

- **Work with microservices in a Visual Studio solution:**

Work with multiple solution projects that represent discrete microservices. This makes it possible to deploy, debug, and Live Update multiple workloads simultaneously from the same solution.



Note

The new variation of Out of the Box (OOTB) Basic supply chains, which outputs Carvel packages to enable configuring multiple runtime environments, is not currently supported. For more information about the variation, see [Carvel Package Supply Chains](#).

Next steps

Install [Tanzu Developer Tools for Visual Studio](#).

Overview of Tanzu Developer Tools for Visual Studio

VMware Tanzu Developer Tools for Visual Studio is the official VMware Tanzu IDE extension for Visual Studio 2022. The extension helps you develop with Tanzu Application Platform and enables you to rapidly iterate on your workloads on supported Kubernetes clusters that have Tanzu Application Platform installed.

Tanzu Developer Tools for Visual Studio currently supports .NET C# applications.

This extension is for Microsoft Visual Studio 2022 only. It is incompatible with Visual Studio Code and Visual Studio for Mac.



Note

This extension is in the beta stage of development.

Extension features

The extension has the following features:

- **Deploy applications directly from Visual Studio:**

Rapidly iterate on your applications on Tanzu Application Platform and deploy them as workloads directly from within Visual Studio.

- **See code updates running on-cluster in seconds:**

With the use of Live Update facilitated by Tilt, deploy your workload once, save changes to the code and then, seconds later, see those changes reflected in the workload running on the cluster.

- **Debug workloads directly on the cluster:**

Debug your application in a production-like environment by debugging on your Kubernetes cluster that has Tanzu Application Platform. An environment's similarity to production relies on keeping dependencies updated, among other variables.

- **See workloads running on the cluster:**

From the Tanzu Panel, you can see any workload found within the cluster and namespace specified in the current kubectl context.

- **Work with microservices in a Visual Studio solution:**

Work with multiple solution projects that represent discrete microservices. This makes it possible to deploy, debug, and Live Update multiple workloads simultaneously from the same solution.



Note

The new variation of Out of the Box (OOTB) Basic supply chains, which outputs Carvel packages to enable configuring multiple runtime environments, is not currently supported. For more information about the variation, see [Carvel Package Supply Chains](#).

Next steps

Install [Tanzu Developer Tools for Visual Studio](#).

Install Tanzu Developer Tools for Visual Studio

This topic tells you how to install VMware Tanzu Developer Tools for Visual Studio.

Prerequisites

Before installing the extension, you must have:

- [Visual Studio 2022](#) v17.7 or later
- [kubectl](#)
- [Tilt](#) v0.30.12 or later
- [Tanzu CLI and plug-ins](#)
- [A cluster with the Tanzu Application Platform Full profile or Iterate profile](#)



Note

If you are an app developer, someone else in your organization might have already set up the Tanzu Application Platform environment.

Install

To install Tanzu Developer Tools for Visual Studio:

1. Download VMware Tanzu Developer Tools for Visual Studio from the [Broadcom Support Portal](#).
2. Double-click the `.vsix` install file and click through the prompts.
3. Open Visual Studio and, from top menu, click **Extensions > Manage Extensions**.
4. Verify that the extension is installed and that it is the version you want.

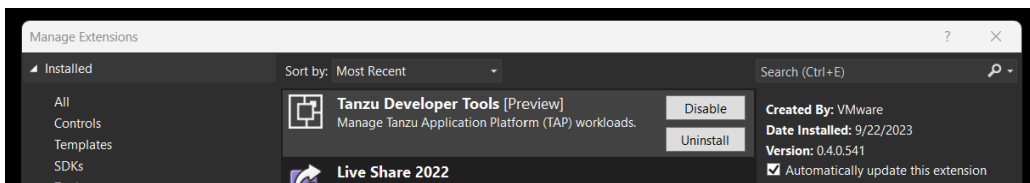

Update

To update to a later version, repeat the steps in the [Install](#) section. You do not need to uninstall the current version.

Uninstall

To uninstall:

1. From the top menu, click the **Extensions** tab and then click **Manage Extensions**.
2. Select the **Installed** section and then click the **Uninstall** button for this extension.

Next steps

[Getting Started with Tanzu Developer Tools for Visual Studio](#).

Get Started with Tanzu Developer Tools for Visual Studio

This topic guides you through getting started with VMware Tanzu Developer Tools for Visual Studio.

Prerequisite

[Install Tanzu Developer Tools for Visual Studio.](#)

Configure Local Source Proxy

Configure Local Source Proxy if you're able to do so. For more information, see the [Local Source Proxy documentation](#).

If you cannot use Local Source Proxy, use a source image registry. Before deploying a workload, you must authenticate with an image registry to store your source code. You can use the Docker CLI to authenticate or you can set environment variables that the Tanzu CLI can use to authenticate.

Docker CLI

To authenticate by using the Docker CLI, run:

```
docker login $REGISTRY_HOSTNAME -u $REGISTRY_USERNAME -p $REGISTRY_PASSWORD
```

Tanzu CLI

To authenticate by using the Tanzu CLI, export environment variables by running:

```
export TANZU_APPS_REGISTRY_CA_CERT=PATH-TO-CA-CERT.nip.io.crt
export TANZU_APPS_REGISTRY_PASSWORD=USERNAME
export TANZU_APPS_REGISTRY_USERNAME=PASSWORD
```

`CA_CERT` is only needed for a custom or private registry.

For more information, see [Workload creation fails due to authentication failure in Docker Registry](#).

Set up Tanzu Developer Tools

The extension makes use of the following files within your project:

- `workload.yaml`
- `catalog-info.yaml`
- `Tiltfile`
- `.tanzuignore`

You can create these files by using the instructions in this topic, or use the files in the [View an example project](#) section.

There are two ways to create these files:

- Using the code snippets that Tanzu Developer Tools provide, which create templates in empty files that you then fill in with the required information.
- Writing the files manually.

Create the `workload.yaml` file

Your project must contain a file named `workload.yaml`. For example, `MyApp\Config\workload.yaml`. `workload.yaml` provides instructions to Supply Chain Choreographer for how to build and manage a workload. For more information, see [Supply Chain Choreographer for Tanzu](#).

The Tanzu Developer Tools for Visual Studio extension requires at least one `workload.yaml` file per project. `workload.yaml` must be a single-document YAML file, not a multi-document YAML file.

To create a `workload.yaml` file by using Visual Studio:

1. Right-click the Solution Explorer project.
2. Click **Add > New Folder**.
3. Name the folder `Config`.
4. Right-click the new `Config` folder and then click **Add > New Item...**
5. From the available list of items, click **Tanzu Workload > Add**.
6. Follow the instructions at the top of the created file.

See the following `workload.yaml` example:

```
apiVersion: carto.run/v1alpha1
kind: Workload
metadata:
  name: APP-NAME
  labels:
    apps.tanzu.vmware.com/workload-type: WORKLOAD-TYPE
    app.kubernetes.io/part-of: APP-NAME
spec:
  source:
    git:
      url: GIT-SOURCE-URL
      ref:
        branch: GIT-BRANCH-NAME
```

Where:

- `APP-NAME` is the name of your application. For example, `my-app`.
- `WORKLOAD-TYPE` is the type of workload for your app. For example, `web`. For more information, see [Workload types](#).
- `GIT-SOURCE-URL` is the Git source code URL for your app. For example, `github.com/mycompany/myapp`.
- `GIT-BRANCH-NAME` is the branch of the Git source code you want to use. For example, `main`.

Alternatively, you can use the Tanzu CLI to create a `workload.yaml` file. For more information about the relevant Tanzu CLI command, see [Tanzu apps workload apply](#).

Create the `catalog-info.yaml` file

Your project must contain a file named `catalog-info.yaml`. For example, `MyApp\Catalog\catalog-info.yaml`.

`catalog-info.yaml` enables the workloads created with Tanzu Developer Tools for Visual Studio to appear in Tanzu Developer Portal (formerly named Tanzu Application Platform GUI). For more information, see [Overview of Tanzu Developer Portal](#).

To create a `catalog-info.yaml` file by using Visual Studio:

1. Right-click the Solution Explorer project.
2. Click **Add > New Folder**.

3. Name the folder `Catalog`.
4. Right-click the new `Catalog` folder and then click **Add > New Item...**
5. From the available list of items, click **Tanzu Catalog Info > Add**.
6. Follow the instructions at the top of the created file.

See the following `catalog-info.yaml` example:

```
apiVersion: backstage.io/v1alpha1
kind: Component
metadata:
  name: APP-NAME
  description: APP-DESCRIPTION
  tags:
    - tanzu
  annotations:
    'backstage.io/kubernetes-label-selector': 'app.kubernetes.io/part-of=APP-NAME'
spec:
  type: service
  lifecycle: experimental
  owner: default-team
```

Where:

- `APP-NAME` is the name of your application.
- `APP-DESCRIPTION` is a description of your application.

Create the Tiltfile file

Your project must contain a file named `Tiltfile`. For example, `MyApp\Tiltfile`.

The `Tiltfile` provides the configuration for Tilt to enable your project to Live Update on the Tanzu Application Platform-enabled Kubernetes cluster. For more information, see the [Tilt documentation](#).

To create a `Tiltfile` file by using Visual Studio:

1. Right-click the Solution Explorer project.
2. Click **Add > New Item...**
3. From the available list of items, click **Tanzu Tiltfile > Add**.
4. Follow the instructions at the top of the created file.

See the following `Tiltfile` example:

```
SOURCE_IMAGE = os.getenv("SOURCE_IMAGE", default='SOURCE-IMAGE-VALUE')
LOCAL_PATH = os.getenv("LOCAL_PATH", default='.')
NAMESPACE = os.getenv("NAMESPACE", default='default')
LIVE_UPDATE_PATH = os.getenv("LIVE_UPDATE_PATH", default='bin/Debug/net6.0')

k8s_custom_deploy(
  'APP-NAME',
  apply_cmd="tanzu apps workload apply -f Config/workload.yaml --live-update" +
    " --local-path " + LOCAL_PATH +
    " --build-env BP_DEBUG_ENABLED=true" +
    " --namespace " + NAMESPACE +
    " --output yaml" +
    " --yes",
  delete_cmd="tanzu apps workload delete " + APP-NAME + " --namespace " + NAMESPACE
+ " --yes" ,
  deps=['bin'],
  container_selector='workload',
```

```

live_update=[
  sync(LIVE_UPDATE_PATH, '/workspace')
]
)

k8s_resource('APP-NAME', port_forwards=["8080:8080"],
  extra_pod_selectors=[{'carto.run/workload-name': 'APP-NAME', 'app.kubernetes.io/component': 'run'}])
allow_k8s_contexts('CONTEXT-NAME')

```

Where `APP-NAME` is the name of your application

If your Tanzu Application Platform-enabled Kubernetes cluster is running on your local machine, you can remove the entire `allow_k8s_contexts` line. For more information about this line, see the [Tilt documentation](#).

Create the `.tanziignore` file

Your project can contain a file named `.tanziignore`. When working with local source code, `.tanziignore` excludes files from the source code that is uploaded within the image. It has syntax similar to the `.gitignore` file.

This file must be placed in the project root to work. For example, `MyApp\.tanziignore`.

To create a `Tiltfile` file by using Visual Studio:

1. Right-click the Solution Explorer project.
2. Click **Add > New Item...**
3. From the available list of items, click **Tanzu Ignore file > Add**.

For an example, see the `.tanziignore` file in GitHub that is used for the sample Tanzu Java web app. You can use the file as it is or edit it for your needs.

View an example project

Before you begin, you need a container image registry to use the sample application. There are two ways to view a sample application that demonstrates the necessary configuration files:

Use Application Accelerator

If your company has configured [Application Accelerator](#), you can obtain the sample application there if it was not removed.

To view the example by using Application Accelerator:

1. Open Application Accelerator. You might need to contact a separate team in your organization to learn they placed it.
2. Search for `Steeltoe Weather Forecast` in Application Accelerator.
3. Add the required configuration information and generate the application.
4. Unzip the application and open the directory in Visual Studio.

Clone from GitHub

To clone the example from GitHub:

1. Use `git clone` to clone the `application-accelerator-samples` repository from GitHub.
2. Go to the `weatherforecast-steeltoe` directory.
3. Open the `Tiltfile` and replace `your-registry.io/project` with your registry.

Next steps

Use [Tanzu Developer Tools for Visual Studio](#).

Use Tanzu Developer Tools for Visual Studio

This topic tells you how to use VMware Tanzu Developer Tools for Visual Studio.



Note

This extension is in the beta stage of development.

Configure settings

To configure settings, right-click anywhere in the Solution Explorer and click **Tanzu > Settings...**

- Tanzu CLI is installed in a location in your `PATH` environment variable.
- A valid `workload.yaml` file is in the project. For more information, see the specification for [Tanzu apps workload apply](#).
- You have a functional Tanzu Application Platform environment.
- Your kubeconfig file is modified for Tanzu Application Platform workload deployments.
- You have an image repository to which source code in the local file system can be uploaded before Build Service builds it.

Workload Actions

The extension enables you to apply, debug, and Live Update your application on a Kubernetes cluster that has Tanzu Application Platform. The developer sandbox experience enables you to Live Update your code, and simultaneously debug the updated code, without deactivating Live Update.

Apply a workload

To apply a workload, right-click anywhere in the Solution Explorer and click **Tanzu > Apply Workload**. Alternatively, right-click an associated workload in the Tanzu Panel and click **Apply Workload**.

Delete a workload

To delete a workload, right-click anywhere in the Solution Explorer and click **Tanzu > Delete Workload**. Alternatively, right-click an associated workload in the Tanzu Panel and click **Delete Workload**.

Start debugging on the cluster

To remote debug a workload, right-click anywhere in the Solution Explorer and click **Tanzu > Debug Workload**. Alternatively, right-click an associated workload in the Tanzu Panel and click **Debug Workload**.



Caution

Do not use the red square Stop button to end your debugging session. Using the red square Stop button might cause the Tanzu Application Platform workload to fail. Instead, in the top menu click **Debug > Detach All**.

If the name of your running app process (the app DLL process), does not match the name of your .NET project as shown in the Visual Studio Solution Explorer, the remote debugging agent might fail to attach.

Live Update

See the following sections for how to use Live Update.

Start Live Update

Ensure that the following Tanzu Settings parameters are set:

- **Local Path**, which is the path on the local file system to a directory of source code to build.
- **Namespace**, which is the namespace that workloads are deployed into. Optional.
- **Source Image**, which is the registry location for publishing local source code. For example, `registry.io/yourapp-source`. It must include both a registry and a project name. The source image parameter is not needed if you configured Local Source Proxy.

To start Live Update, right-click anywhere in the Solution Explorer and click **Tanzu > Start Live Update**. Alternatively, right-click an associated workload in the Tanzu Panel and click **Start Live Update**.

After starting Live Update, local builds changes are synchronized with the container.

Stop Live Update

To stop Live Update, right-click anywhere in the Solution Explorer and click **Tanzu > Stop Live Update**. Alternatively, right-click an associated workload in the Tanzu Panel and click **Stop Live Update**.

Tanzu Workloads panel

The current state of the workloads is visible in the Tanzu Workloads view. This view is a separate section in the bottom of the Explorer view in the Side Bar. The view shows the current status of each workload, namespace, and cluster. It also shows whether Live Update and Debug is running, stopped, or deactivated.

The Tanzu Activity tab in the Panels view enables developers to visualize the supply chain, delivery, and running application pods. The tab enables a developer to view and describe logs on each resource associated with a workload from within their IDE. The tab displays detailed error messages for each resource in an error state.

Workload commands are available from the Tanzu Workloads panel on workloads that have an associated module in the current project.

This association is based on a module name and a workload name matching. For example, a project with a module named `my-app` is associated with a deployed workload named `my-app`.

When taking an action from the Tanzu Workloads panel, the action uses the namespace of the deployed workload regardless of the configuration in the module.

For example, you might have a Live Update configuration with a namespace argument of `my-apps-1`, but running the action from a deployed workload in namespace `my-apps-2` starts a Live Update session with a namespace argument of `my-apps-2`.

The Tanzu Workloads panel uses the cluster and defaults to the namespace specified in the current kubectl context. To view the Tanzu Workloads panel, right-click anywhere in the Solution Explorer

and click **Tanzu > View Workloads**.

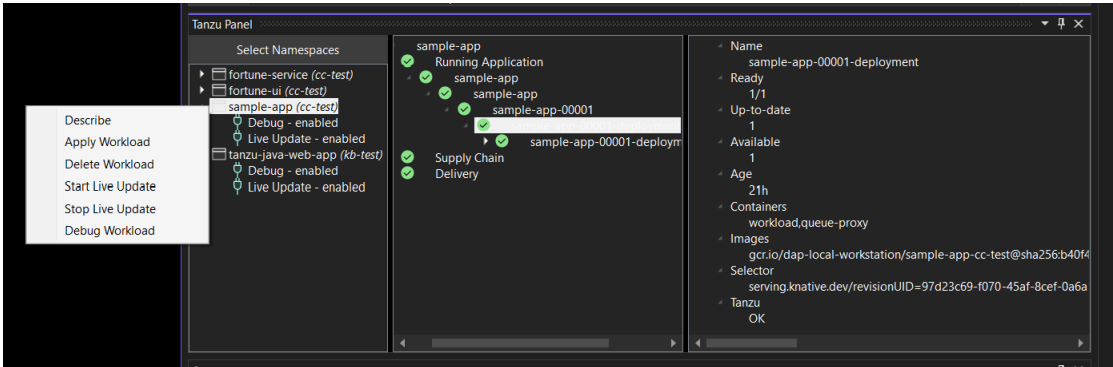

Extension logs

The extension creates log entries in two files named `tanzu-dev-tools-{GUID}.log` and `tanzu-language-server-{GUID}.log`. These files are in the directory where Visual Studio Installer installed the extension.

To find the log files from PowerShell, run:

```
dir $Env:LOCALAPPDATA\Microsoft\VisualStudio\*\Extensions\*\Logs\tanzu-*.log
```

To find the log files from CMD, run:

```
dir %LOCALAPPDATA%\Microsoft\VisualStudio\*\Extensions\*\Logs\tanzu-*.log
```

You can override the log file paths by setting the environment variables `TANZU_DT_LOG` and `TANZU_LS_LOG`.

Troubleshoot Tanzu Developer Tools for Visual Studio

This topic tells you how to troubleshoot issues you encounter with VMware Tanzu Developer Tools for Visual Studio.

Stop button causes workload to fail

Symptom

Clicking the red square Stop button in the Visual Studio top toolbar causes the Tanzu Application Platform workload to fail or become unresponsive indefinitely.

Solution

To end a debugging session, in the top menu click **Debug > Detach All**.

Frequent application restarts

Symptom

When an application is applied from Visual Studio it restarts frequently.

Cause

An application or environment behavior is triggering the application to restart.

Observed trigger behaviors include:

- The application itself writing logs to the file system in the application directory that Live Update is watching
- Autosave being set to a very high frequency in the IDE configuration

Solution

Prevent the trigger behavior. Example solutions include:

- Prevent 12-factor applications from writing to the file system.
- Reduce the autosave frequency to once every few minutes.

Overview of Tanzu Developer Tools for VS Code

VMware Tanzu Developer Tools for Visual Studio Code (VS Code) is the official VMware Tanzu IDE extension for VS Code. The extension helps you develop with Tanzu Application Platform and enables you to rapidly iterate on your workloads on supported Kubernetes clusters that have Tanzu Application Platform installed.

Tanzu Developer Tools for VS Code currently supports VS Code on macOS and Windows OS for Java applications.

Extension features

The extension has the following features:

- **Deploy applications directly from VS Code:**

Rapidly iterate on your applications on Tanzu Application Platform by deploying them as workloads directly from within VS Code.

- **See code updates running on-cluster in seconds:**

With Live Update (facilitated by Tilt), you can deploy your workload once, save changes to the code and then see those changes reflected within seconds in the workload running on the cluster.

- **Debug workloads directly on the cluster:**

Debug your application in a production-like environment by debugging on your Kubernetes cluster that has Tanzu Application Platform. An environment's similarity to production relies on keeping dependencies and other variables updated.

- **See workloads running on the cluster:**

From the Tanzu Workloads panel you can see any workload found within the cluster and namespace specified in the current kubectl context.



Note

The new variation of Out of the Box (OOTB) Basic supply chains, which outputs Carvel packages to enable configuring multiple runtime environments, is not currently supported. For more information about the variation, see [Carvel Package Supply Chains](#).

Overview of Tanzu Developer Tools for VS Code

VMware Tanzu Developer Tools for Visual Studio Code (VS Code) is the official VMware Tanzu IDE extension for VS Code. The extension helps you develop with Tanzu Application Platform and enables you to rapidly iterate on your workloads on supported Kubernetes clusters that have Tanzu Application Platform installed.

Tanzu Developer Tools for VS Code currently supports VS Code on macOS and Windows OS for Java applications.

Extension features

The extension has the following features:

- **Deploy applications directly from VS Code:**

Rapidly iterate on your applications on Tanzu Application Platform by deploying them as workloads directly from within VS Code.

- **See code updates running on-cluster in seconds:**

With Live Update (facilitated by Tilt), you can deploy your workload once, save changes to the code and then see those changes reflected within seconds in the workload running on the cluster.

- **Debug workloads directly on the cluster:**

Debug your application in a production-like environment by debugging on your Kubernetes cluster that has Tanzu Application Platform. An environment's similarity to production relies on keeping dependencies and other variables updated.

- **See workloads running on the cluster:**

From the Tanzu Workloads panel you can see any workload found within the cluster and namespace specified in the current kubectl context.



Note

The new variation of Out of the Box (OOTB) Basic supply chains, which outputs Carvel packages to enable configuring multiple runtime environments, is not currently supported. For more information about the variation, see [Carvel Package Supply Chains](#).

Install Tanzu Developer Tools for VS Code

This topic tells you how to install VMware Tanzu Developer Tools for Visual Studio Code (VS Code).

Prerequisites

Before installing the extension, you must have:

- [VS Code](#)
- [kubectl](#)
- [Tilt v0.30.12](#) or later
- [Tanzu CLI and plug-ins](#)
- [A cluster with the Tanzu Application Platform Full profile or Iterate profile](#)

If you are an app developer, someone else in your organization might have already set up the Tanzu Application Platform environment.

Docker Desktop and local Kubernetes are not prerequisites for using Tanzu Developer Tools for VS Code.

Install

To install the extension:

1. Download Tanzu Developer Tools for Visual Studio Code from the [Broadcom Support Portal](#).
2. Open VS Code.
3. Press cmd+shift+P to open the Command Palette and run `Extensions: Install from VSIX...`



4. Select the extension file `tanzu-vscode-extension.vsix`.
5. If you do not have the following extensions, and they do not automatically install, install them from VS Code Marketplace:
 - [Debugger for Java](#)
 - [Language Support for Java\(™\) by Red Hat](#)
 - [YAML](#)
6. Ensure Language Support for Java is running in [Standard Mode](#). You can configure it in the **Settings** menu by going to **Code > Preferences > Settings** under **Java > Server: Launch Mode**.

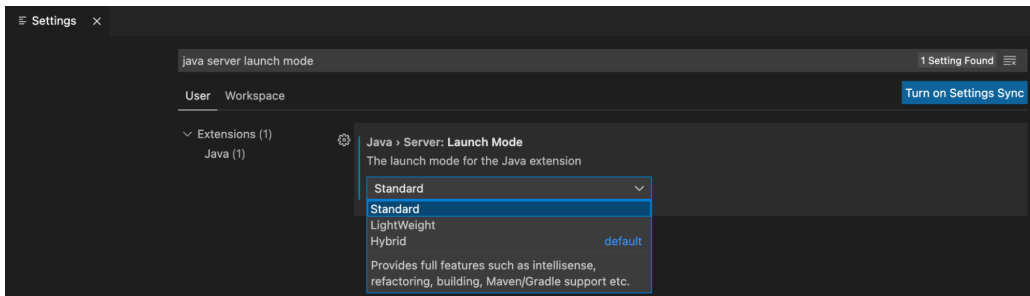

When the JDK and Language Support for Java are configured correctly, you see that the integrated development environment creates a directory target where the code is compiled.

Configure

To configure VMware Tanzu Developer Tools for VS Code:

1. Ensure that you are targeting the correct cluster. For more information, see the [Kubernetes documentation](#).
2. Go to **Code > Preferences > Settings > Extensions > Tanzu Developer Tools** and set the following:
 - **Confirm Delete:** This controls whether the extension asks for confirmation when deleting a workload.
 - **Enable Live Hover:** For more information, see [Integrating Live Hover by using Spring Boot Tools](#). Reload VS Code for this change to take effect.

- **Source Image:** The registry location for publishing local source code. For example, `registry.io/yourapp-source`. This must include both a registry and a project name. A source image registry location is optional when Local Source Proxy is configured.
- **Local Path:** (Optional) The path on the local file system to a directory of source code to build. This is the current directory by default.
- **Namespace:** (Optional) This is the namespace that workloads are deployed into. The namespace set in `kubeconfig` is the default.

Uninstall

To uninstall VMware Tanzu Developer Tools for VS Code:

1. Go to **Code > Preferences > Settings > Extensions**.
2. Right-click the extension and select **Uninstall**.

Next steps

Proceed to [Getting started with Tanzu Developer Tools for Visual Studio Code](#).

Get started with Tanzu Developer Tools for VS Code

This topic guides you through getting started with VMware Tanzu Developer Tools for Visual Studio Code (VS Code).

Prerequisite

[Install VMware Tanzu Developer Tools for Visual Studio Code](#).

Configure Local Source Proxy or use a source image registry

Configure Local Source Proxy if you're able to do so. For more information, see the [Local Source Proxy documentation](#).

If you cannot use Local Source Proxy, use a source image registry. Before deploying a workload, you must authenticate with an image registry to store your source code. You can use the Docker CLI to authenticate or you can set environment variables that the Tanzu CLI can use to authenticate.

Docker CLI

To authenticate by using the Docker CLI, run:

```
docker login $REGISTRY_HOSTNAME -u $REGISTRY_USERNAME -p $REGISTRY_PASSWORD
```

Tanzu CLI

To authenticate by using the Tanzu CLI, export environment variables by running:

```
export TANZU_APPS_REGISTRY_CA_CERT=PATH-TO-CA-CERT.nip.io.crt
export TANZU_APPS_REGISTRY_PASSWORD=USERNAME
export TANZU_APPS_REGISTRY_USERNAME=PASSWORD
```

`CA_CERT` is only needed for a custom or private registry.

For more information, see [Workload creation fails due to authentication failure in Docker Registry](#).

Set up Tanzu Developer Tools

The extension makes use of the following files within your project:

- `workload.yaml`
- `catalog-info.yaml`
- `Tiltfile`
- `.tanzuignore`

You can create these files by using the instructions in this topic, or use the files in the [View an example project](#) section.

There are two ways to create these files:

- Using the code snippets that Tanzu Developer Tools provide, which create templates in empty files that you then fill in with the required information.
- Writing the files manually.

Create the `workload.yaml` file

`workload.yaml` provides instructions to the Supply Chain Choreographer about how to build and manage a workload.

The extension requires only one `workload.yaml` file per project. `workload.yaml` must be a single-document YAML file, not a multidocument YAML file.

Before beginning to write your `workload.yaml` file, ensure that you know:

- The name of your application. For example, `my app`.
- The workload type of your application. For example, `web`.
- The GitHub source code URL. For example, `github.com/mycompany/myapp`.
- The Git branch of the source code that you intend to use. For example, `main`.

Code snippets

To create a `workload.yaml` file by using code snippets:

1. (Optional) Create a directory named `config` in the root directory of your project. For example, `my project/config`.
2. Create a file named `workload.yaml` in the new config directory. For example, `my project/config/workload.yaml`.
3. Open the new `workload.yaml` file in VS Code, enter `tanzu workload` in the file to trigger the code snippets, and either press Enter or left-click the `tanzu workload` text in the drop-down menu.

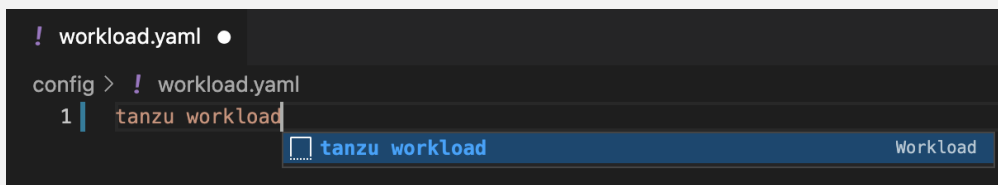

```
! workload.yaml ●
config > ! workload.yaml
1 | tanzu workload
   | [ ] tanzu workload Workload
```

4. Fill in the template by pressing the Tab key.

Manual

To create your `workload.yaml` file manually, follow this example:

```

apiVersion: carto.run/v1alpha1
kind: Workload
metadata:
  name: APP-NAME
  labels:
    apps.tanzu.vmware.com/workload-type: WORKLOAD-TYPE
    app.kubernetes.io/part-of: APP-NAME
spec:
  source:
    git:
      url: GIT-SOURCE-URL
      ref:
        branch: GIT-BRANCH-NAME

```

Where:

- `APP-NAME` is the name of your application.
- `WORKLOAD-TYPE` is the type of this workload. For example, `web`.
- `GIT-SOURCE-URL` is your GitHub source code URL.
- `GIT-BRANCH-NAME` is the Git branch of your source code.

Alternatively, you can use the Tanzu CLI to create a `workload.yaml` file. For more information about the Tanzu CLI command, see [Tanzu apps workload apply](#) in the Tanzu CLI documentation.

Create the `catalog-info.yaml` file

`catalog-info.yaml` enables the workloads of this project to appear in [Tanzu Developer Portal](#).

Before beginning to write your `catalog-info.yaml` file, ensure that you:

- Know the name of your application. For example, `my app`.
- Have a description of your application ready.

Code snippets

To create a `catalog-info.yaml` file by using the code snippets:

1. (Optional) Create a directory named `catalog` in the root directory of your project. For example, `my project/catalog`.
2. Create a file named `catalog-info.yaml` in the new config directory. For example, `my project/catalog/catalog-info.yaml`.
3. Open the new `catalog-info.yaml` file in VS Code, enter `tanzu catalog-info` in the file to trigger the code snippets, and then either press Enter or left-click the `tanzu catalog-info` text in the drop-down menu.

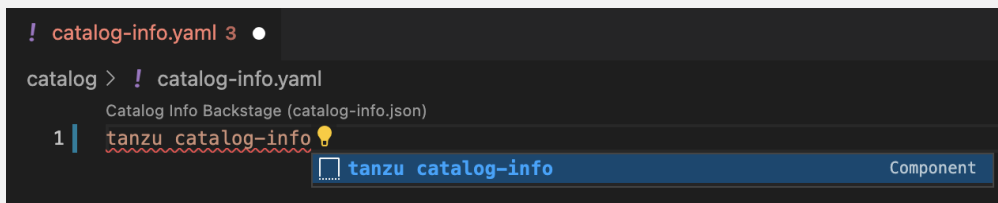

4. Fill in the template by pressing the Tab key.

Manual

To create your `catalog-info.yaml` file manually, follow this example:

```

apiVersion: backstage.io/v1alpha1
kind: Component
metadata:

```

```

name: APP-NAME
description: APP-DESCRIPTION
tags:
  - tanzu
annotations:
  'backstage.io/kubernetes-label-selector': 'app.kubernetes.io/part-of=APP-NAME'
spec:
  type: service
  lifecycle: experimental
  owner: default-team

```

Where:

- `APP-NAME` is the name of your application
- `APP-DESCRIPTION` is the description of your application

Create the Tiltfile file

The Tiltfile file provides the [Tilt](#) configuration to enable your project to Live Update on your Kubernetes cluster that has Tanzu Application Platform. The Tanzu Developer Tools extension requires only one **Tiltfile** per project.

Before beginning to write your Tiltfile file, ensure that you know:

- The name of your application. For example, `my app`.
- Whether you want to compile the source image from a local directory other than the project directory or otherwise leave the `local path` value unchanged. For more information, see [local path](#) in the glossary.
- The path to your `workload.yaml` file. For example, `config/workload.yaml`.
- The name of your current [Kubernetes context](#), if the targeting Kubernetes cluster enabled by Tanzu Application Platform is not running on your local machine.

Code Snippets

To create a Tiltfile file by using the code snippets:

1. Create a file named `Tiltfile` with no file extension in the root directory of your project. For example, `my project/Tiltfile`.
2. Open the new Tiltfile file in VS Code and enter `tanzu tiltfile` in the file to trigger the code snippets, and then either press Enter or left-click the `tanzu tiltfile` text in the drop-down menu.

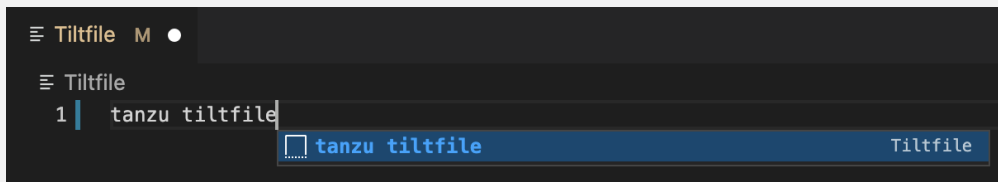

3. Fill in the template by pressing the Tab key.
4. If the targeting Kubernetes cluster enabled by Tanzu Application Platform is not running on your local machine, add a new line to the end of the **Tiltfile** template and enter:

```
allow_k8s_contexts('CONTEXT-NAME')
```

Where `CONTEXT-NAME` is the name of your current Kubernetes context.

Manual

To create a Tiltfile file manually, follow this example:

```

LOCAL_PATH = os.getenv("LOCAL_PATH", default='.')
NAMESPACE = os.getenv("NAMESPACE", default='default')

k8s_custom_deploy(
  'APP-NAME',
  apply_cmd="tanzu apps workload apply -f PATH-TO-WORKLOAD-YAML --live-update" +
    " --local-path " + LOCAL_PATH +
    " --namespace " + NAMESPACE +
    " --yes >/dev/null" +
    " && kubectl get workload APP-NAME --namespace " + NAMESPACE + " -o yaml",
  delete_cmd="tanzu apps workload delete -f PATH-TO-WORKLOAD-YAML --namespace " + NAMESPACE + " --yes" ,
  deps=['pom.xml', './target/classes'],
  container_selector='workload',
  live_update=[
    sync('./target/classes', '/workspace/BOOT-INF/classes')
  ]
)

k8s_resource('APP-NAME', port_forwards=["8080:8080"],
  extra_pod_selectors=[{'carto.run/workload-name': 'APP-NAME', 'app.kubernetes.io/component': 'run'}])
allow_k8s_contexts('CONTEXT-NAME')

```

Where:

- `APP-NAME` is the name of your application.
- `PATH-TO-WORKLOAD-YAML` is the local file system path to `workload.yaml`. For example, `config/workload.yaml`.
- `CONTEXT-NAME` is the name of your current [Kubernetes context](#). If your Kubernetes cluster enabled by Tanzu Application Platform is running locally on your local machine, you can remove the entire `allow_k8s_contexts` line. For more information, see the [Tilt documentation](#).

Create a `.tanziignore` file

The `.tanziignore` file specifies the file paths to exclude from the source code image. When working with local source code, you can exclude files from the source code to be uploaded within the image. Directories must not end with the system path separator (`/` or `\`). See this [example](#) in GitHub.

View an example project

Before you begin, you need a container registry for the sample application.

You can view a sample application that demonstrates the necessary configuration files. There are two ways to obtain the sample application:

Application Accelerator

If your company has configured [Application Accelerator](#), you can obtain the sample application there if it was not removed. To do so:

1. Open Application Accelerator.
2. Search for `Tanzu Java Web App` in Application Accelerator.
3. Add the required configuration information and generate the application.
4. Unzip the file and open the project in a VS Code workspace.

Clone from GitHub

To clone the sample application from GitHub:

1. Run `git clone` to clone the `tanzu-java-web-app` repository from GitHub.
2. Change into the `tanzu-java-web-app` directory.
3. Open the Tiltfile and replace `your-registry.io/project` with your container registry.

Next steps

Use [Tanzu Developer Tools for VS Code](#).

Use Tanzu Developer Tools for VS Code

This topic tells you how to use VMware Tanzu Developer Tools for Visual Studio Code (VS Code).

Ensure that the project you want to use the extension with has the required files specified in [Get started with Tanzu Developer Tools for VS Code](#).

The extension requires only one Tiltfile and one `workload.yaml` per project. The `workload.yaml` must be a single-document YAML file, not a multidocument YAML file.

Configure for multiple projects in the workspace

When working with multiple projects in a single workspace, you can configure the extension settings on a per-project basis by using the drop-down menu in **Settings**.

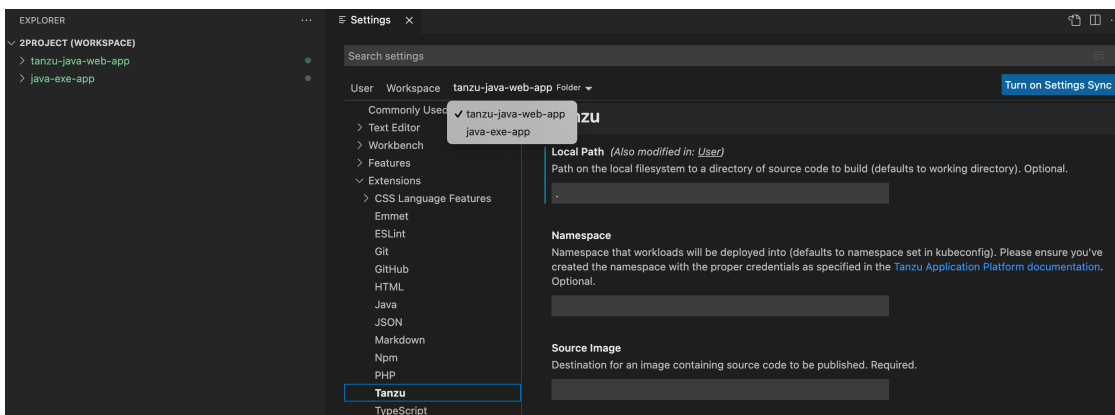

Workload Commands

All commands are available by right-clicking anywhere in the VS Code project explorer, on an associated workload in the Tanzu Workloads panel, or in the Command Palette (`⇧⌘P` on Mac and `Ctrl+Shift+P` on Windows).

- Screenshot of pop-up menu opened from the workload panel:

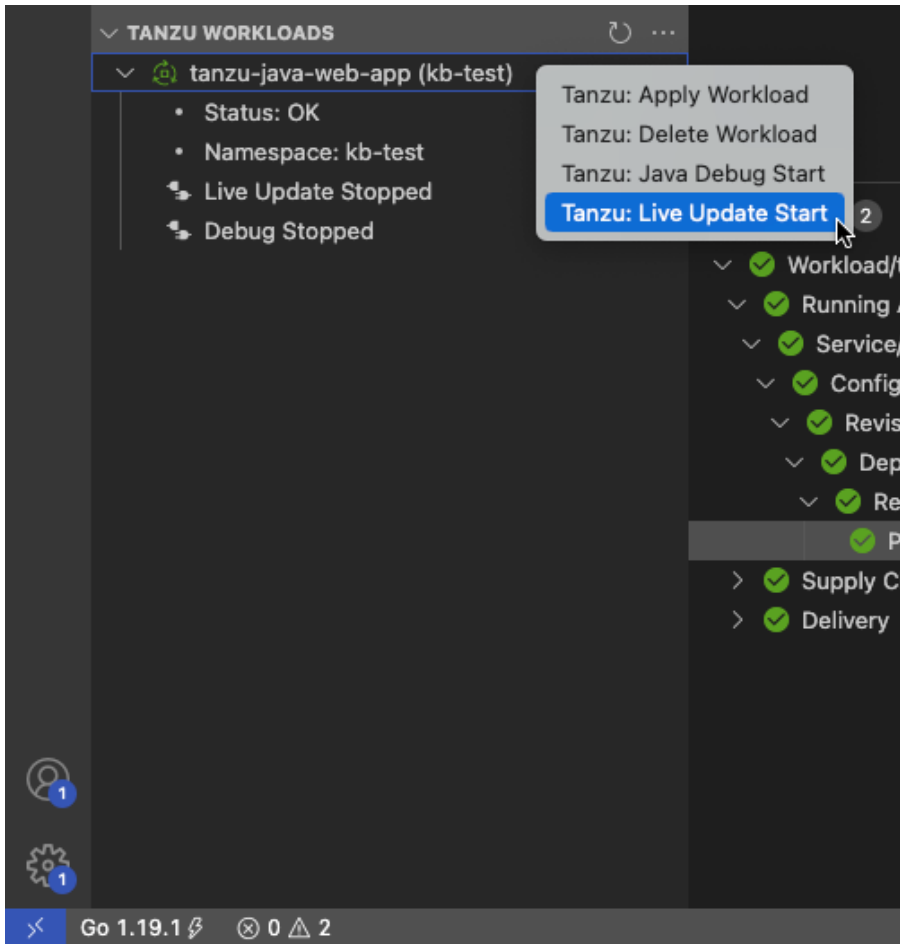

- Screenshot of the command palette:

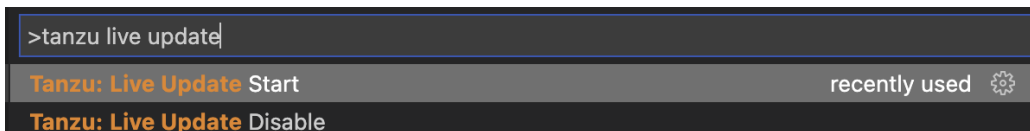

Apply a workload

The extension enables you to apply workloads on your Kubernetes cluster that has Tanzu Application Platform.

To apply a workload:

1. Right-click anywhere in the VS Code project explorer, on an associated workload in the Tanzu Workloads panel, or open the Command Palette (⇧⌘P on Mac and Ctrl+Shift+P on Windows).
2. Select the `Tanzu: Apply Workload` command.
3. If applicable, select the workload to apply.

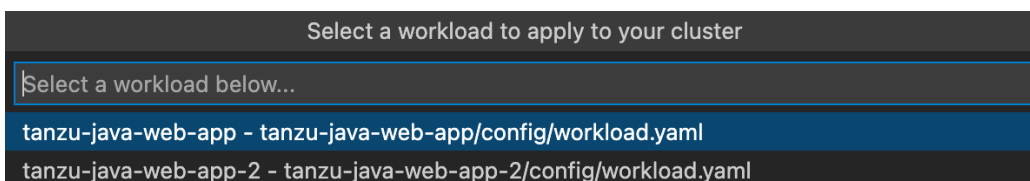

A notification appears showing that the workload was applied.

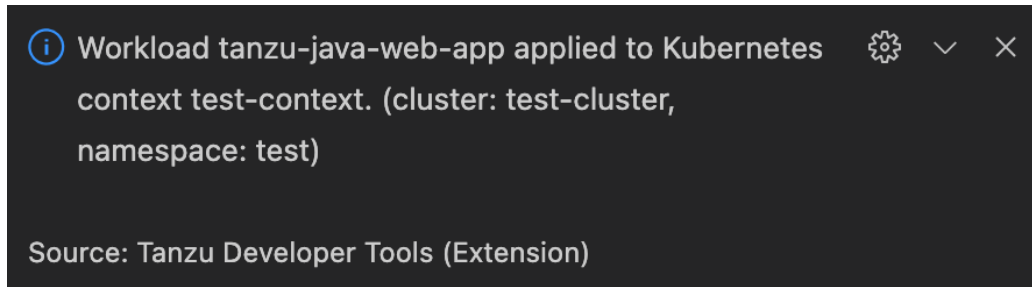

A new workload appears on the Tanzu Workloads panel.

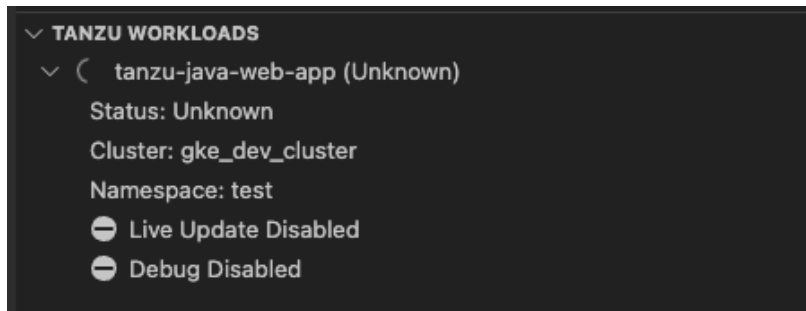

After the workload is deployed, the status on the Tanzu Workloads panel changes to *Ready*.

Debugging on the cluster

The extension enables you to debug your application on your Kubernetes cluster that has Tanzu Application Platform.

Debugging requires a `workload.yaml` file in your project. For information about creating a `workload.yaml` file, see [Get Started with Tanzu Developer Tools for VS Code](#).

The developer sandbox experience enables developers to Live Update their code, and simultaneously debug the updated code, without having to deactivate Live Update when debugging.

Start debugging on the cluster

To start debugging on the cluster:

1. Add a [breakpoint](#) in your code.
2. Right-click anywhere in the VS Code project explorer, on an associated workload in the Tanzu Workloads panel, or open the Command Palette (⇧⌘P on Mac and Ctrl+Shift+P on Windows).
3. Select the `Tanzu: Java Debug Start` command..

Stop Debugging on the cluster

To stop debugging on the cluster, you can click the stop button in the Debug overlay.

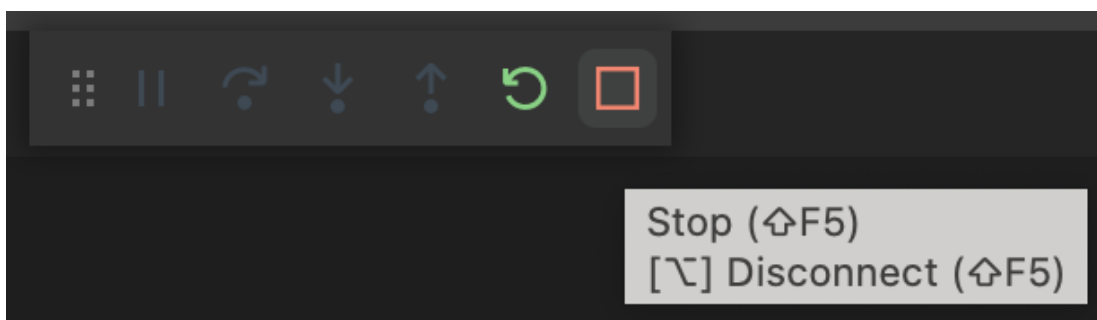

Alternatively, you can press `⌘+J` (Ctrl+J on Windows) to open the panel and then click the trash can button for the debug task running in the panel.

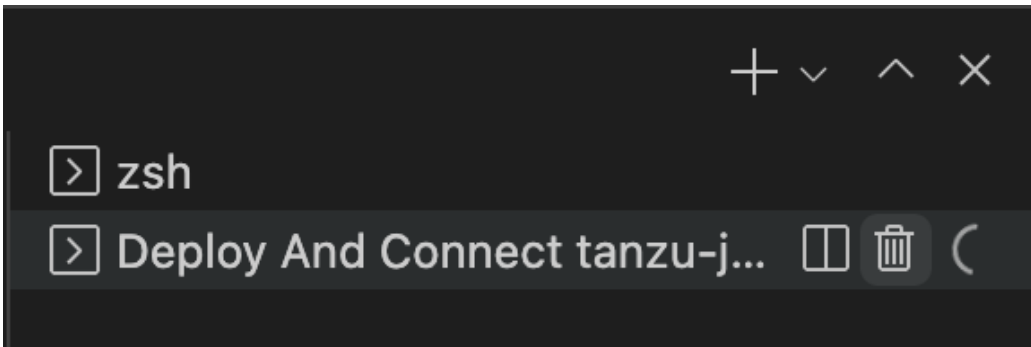

Debug apps in a microservice repository

To debug multiple apps in a microservice repository:

1. Add each app folder as a workspace folder. For instructions, see the [Visual Studio Code documentation](#).
2. Update the `tanzu.debugPort` setting so that it does not conflict with other debugging sessions. For how to update individual workspace folder settings, see the [Visual Studio Code documentation](#).

Live Update

With the use of Live Update facilitated by [Tilt](#), the extension enables you to deploy your workload once, save changes to the code, and see those changes reflected in the workload running on the cluster within seconds.

Live Update requires a `workload.yaml` file and a Tiltfile in your project. For information about how to create a `workload.yaml` and a Tiltfile, see [Get Started with Tanzu Developer Tools for VS Code](#).

The developer sandbox experience enables developers to Live Update their code, and simultaneously debug the updated code, without having to deactivate Live Update when debugging.

Start Live Update

Before using Live Update, verify that your auto-save setting is either off or on with a delay. The delay must be long enough for the application to restart between auto saves to allow enough time for your app to Live Update when files change. The auto-save setting is in **Preferences > Text Editor > Files > Auto Save > Auto Save Delay**.

To start Live Update:

1. Right-click anywhere in the VS Code project explorer, on an associated workload in the Tanzu Workloads panel, or open the Command Palette (`⇧⌘P` on Mac and `Ctrl+Shift+P` on Windows).
2. Select the `Tanzu: Live Update Start` command.

Stop Live Update

When Live Update stops, your application continues to run on the cluster, but the changes you made and saved in your editor are not present in your running application unless you redeploy your application to the cluster.

To stop Live Update, click the trash can button in the terminal pane to stop the Live Update process.

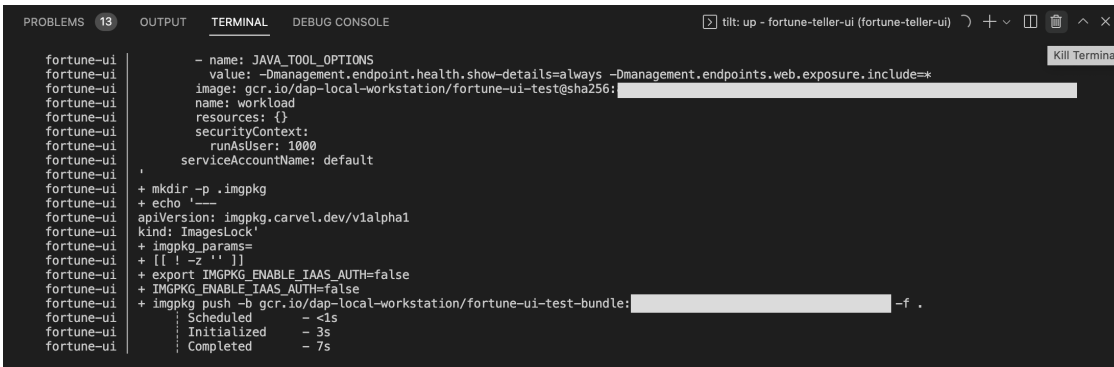

Live Update apps in a microservices repository

To Live Update multiple apps in a microservice repository:

1. Add each app folder as a workspace folder. For instructions, see the [Visual Studio Code documentation](#).
2. Ensure that a port is available to port-forward the Knative service. For example, you might have this in your Tiltfile:

```

k8s_resource('tanzu-java-web-app', port_forwards=["NUMBER:8080"],
             extra_pod_selectors=[{'carto.run/workload-name': 'tanzu-java-web-app',
                                   'app.kubernetes.io/component': 'run'}])
    
```

Where **NUMBER** is the port you choose. For example, `port_forwards=["9999:8080"]`.

Delete a workload

The extension enables you to delete workloads on your Kubernetes cluster that has Tanzu Application Platform.

To delete a workload:

1. Right-click anywhere in the VS Code project explorer, on an associated workload in the Tanzu Workloads panel, or open the Command Palette (⇧⌘P on Mac and Ctrl+Shift+P on Windows).
2. Select the **Tanzu: Delete Workload** command.
3. If applicable, select the workload to delete.

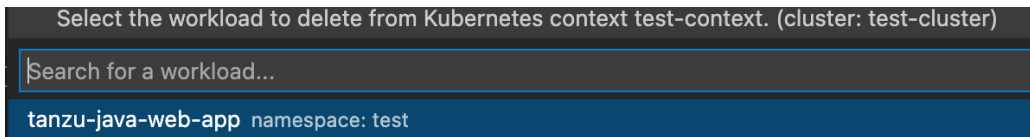

If the **Tanzu: Confirm Delete** setting is enabled, a message appears that prompts you to delete the workload and not warn again, delete the workload, or cancel.

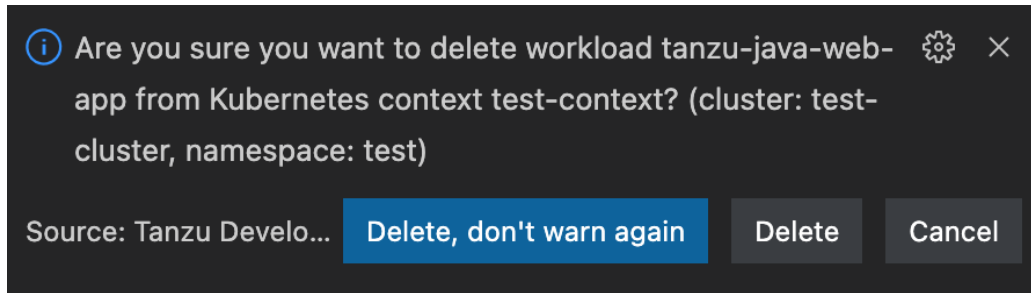

A notification appears showing that the workload was deleted.

Deploy to different namespaces

To switch the namespace where you created the workload:

1. Go to **Code > Preferences > Settings**.
2. Expand the **Extensions** section of the settings and click **Tanzu**.
3. In the **Namespace** option, add the namespace you want to deploy to. This is the `default` namespace by default.

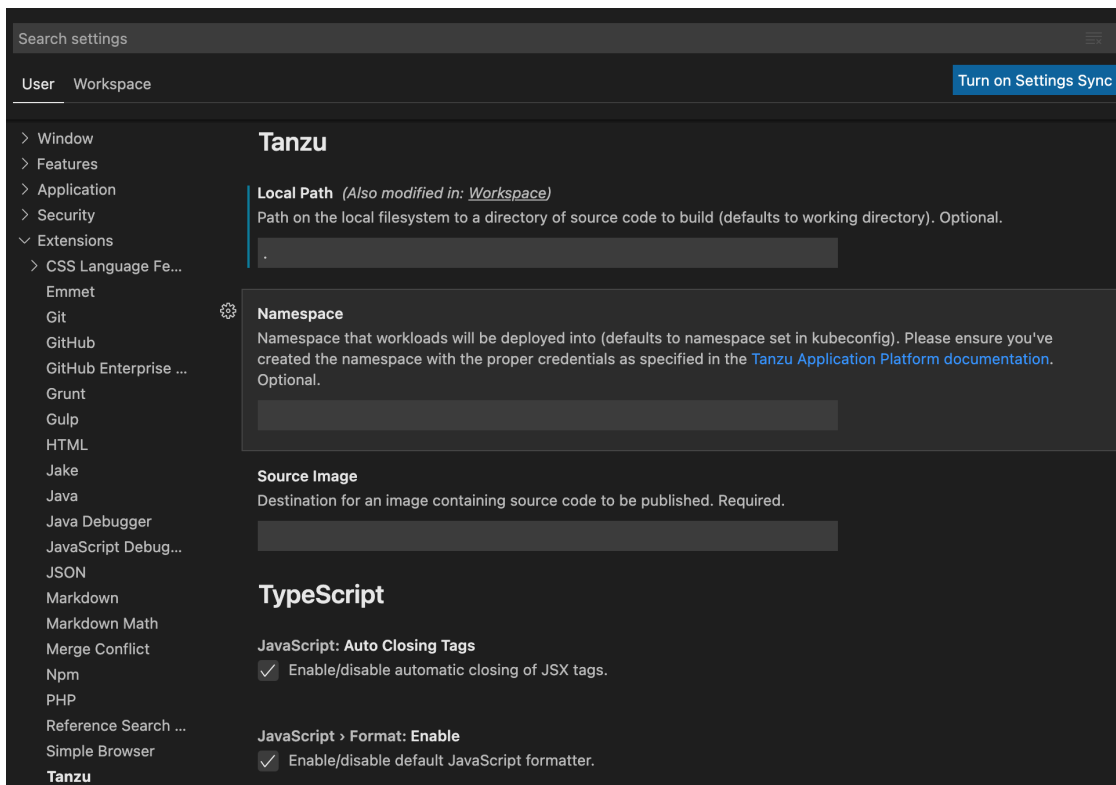

Tanzu Workloads panel

The current state of the workloads is visible in the Tanzu Workloads view. This view is a separate section in the bottom of the Explorer view in the Side Bar. The view shows the current status of each workload, namespace, and cluster. It also shows whether Live Update and Debug is running, stopped, or deactivated.

The Tanzu Activity tab in the Panels view enables developers to visualize the supply chain, delivery, and running application pods. The tab enables a developer to view and describe logs on each resource associated with a workload from within their IDE. The tab displays detailed error messages for each resource in an error state.

Workload commands are available from the Tanzu Workloads panel on workloads that have an associated module in the current project.

This association is based on a module name and a workload name matching. For example, a project with a module named `my-app` is associated with a deployed workload named `my-app`.

When taking an action from the Tanzu Workloads panel, the action uses the namespace of the deployed workload regardless of the configuration in the module.

For example, you might have a Live Update configuration with a namespace argument of `my-apps-1`, but running the action from a deployed workload in namespace `my-apps-2` starts a Live Update session with a namespace argument of `my-apps-2`.

The Tanzu Workloads panel uses the cluster and defaults to the namespace specified in the current kubectl context.

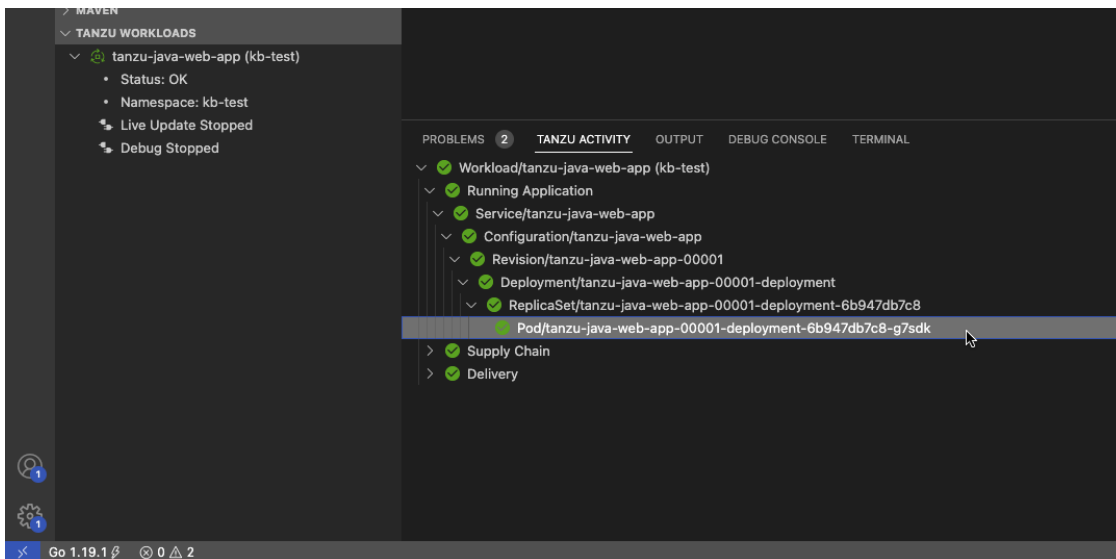

To add a namespace:

1. View the current context and namespace by running:

```
kubectl config get-contexts
```

2. Set a namespace for the current context by running:

```
kubectl config set-context --current --namespace=YOUR-NAMESPACE
```

3. Use one of these methods to add additional namespaces to your Tanzu Workloads panel:

- o Go to **Preferences > Extensions > Tanzu Developer Tools > Tracked Namespaces** and then select the namespaces that you want.
- o Go to **Workload Panel > Additional Options > Select Namespaces** and then select the namespaces that you want.

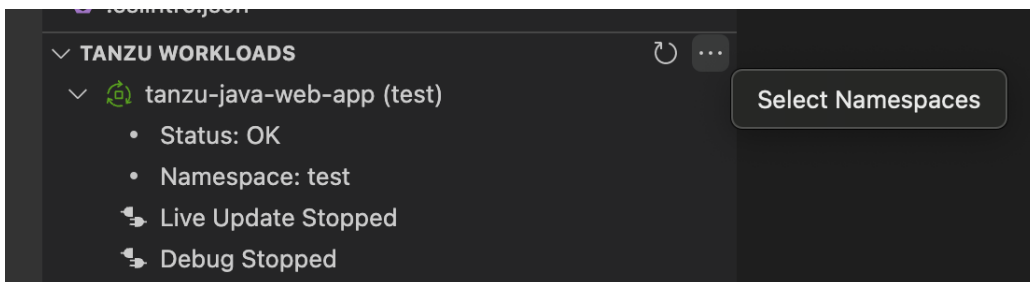

Working with Microservices in a Monorepo

A monorepo is single Git repository that contains multiple workloads. Each individual workload is placed in a subfolder of the main repository.

You can find an example of this in [Application Accelerator](#). The relevant accelerator is called Spring SMTP Gateway, and you can obtain its source code as an accelerator or directly from the [application-accelerator-samples](#) GitHub repository.

This project exemplifies a typical layout:

- `MONO-REPO-ROOT/`
 - `pom.xml` (parent pom)
 - `microservice-app-1/`
 - `pom.xml`
 - `mvnw` (and other mvn-related files for building the workload)
 - `Tiltfile` (supports Live Update)
 - `config`
 - `workload.yaml` (supports deploying and debugging from IntelliJ)
 - `src/` (contains source code for this microservice)
 - `microservice-app-2/`
 - ...similar layout

Recommended structure: Microservices that can be built independently

In this example, each of the microservices can be built independently of one another. Each subfolder contains everything needed to build that workload.

This is reflected in the `source` section of `workload.yaml` by using the `subPath` attribute:

```
apiVersion: carto.run/v1alpha1
kind: Workload
metadata:
  name: microservice-app-1
  ...
spec:
  source:
    git:
      ref:
        branch: main
      url: https://github.com/kdvolder/sample-mono-repo.git
      subPath: microservice-app-1 # build only this
    ...
```

For setting up your own repositories, it's best practice to set up a monorepo so that each microservice can be built completely independently.

To work with these monorepos:

- Import the monorepo as a project into VS Code.
- Interact with each of the subfolders in the same way you would interact with a project containing a single workload.

Alternative structure: Services with build-time interdependencies

Some monorepos do not have submodules that can be independently built. Instead the `pom.xml` files of the submodules are set up to have some build-time interdependencies. For example:

- A submodule `pom.xml` can reference the parent `pom.xml` as a common place for centralized dependency management.
- A microservice submodule can reference another, as a maven dependency.
- Several microservice submodules can reference one or more shared library modules.

For these projects, make these adjustments:

1. Make `workload.yaml` point to the repository root, not a subfolder. Because submodules have dependencies on code outside of their own subfolder, all source code from the repository must be supplied to the workload builder.
2. Make `workload.yaml` specify additional buildpack arguments through environment variables. They differentiate the submodule that the build is targeting.

Both of these `workload.yaml` changes are in the following example:

```
apiVersion: carto.run/v1alpha1
kind: Workload
metadata:
  name: fortune-ui
labels:
  apps.tanzu.vmware.com/workload-type: web
  app.kubernetes.io/part-of: fortune-ui
spec:
  build:
    env:
      - name: BP_MAVEN_BUILD_ARGUMENTS
        value: package -pl fortune-teller-ui -am # indicate which module to build.
      - name: BP_MAVEN_BUILT_MODULE
        value: fortune-teller-ui # indicate where to find the built artefact to deploy.
    source:
      git:
        url: https://github.com/my-user/fortune-teller # repo root
        ref:
          branch: main
```

For more information about these and other `BP_XXX` buildpack parameters, see the [Buildpack Documentation](#).

3. Make the local path preference for each subfolder point to the path of the repository root. Because submodules have dependencies on code outside of their own subfolder, all source code from the repository must be supplied to the workload builder.

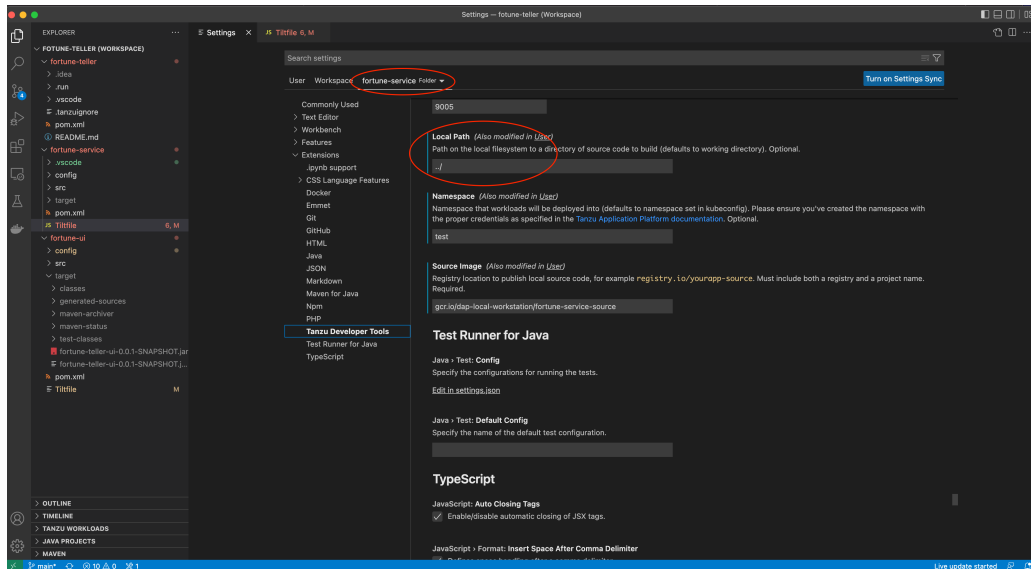

Changing logging verbosity

The Tanzu Language Server saves logs to `~/tanzu-langserver.log`. You can change the log verbosity in **Preferences > Settings > Extensions > Tanzu Developer Tools > Language Server: Log Verbosity**.

Working with Java Native images

Native Image is technology for compiling Java code ahead of time to a binary, which is a native executable file. For more information about Native Image, see the [GraalVM documentation](#).

Native Image requires some changes to your `workload.yaml` files, such as adding new environment variables to the build section of the workload specifications:

```
spec:
  build:
    env:
      - name: BP_NATIVE_IMAGE
        value: "true"
      - name: BP_MAVEN_BUILD_ARGUMENTS
        value: -Dmaven.test.skip=true --no-transfer-progress package -Pnative
      - name: BP_JVM_VERSION
        value: 17 ## only JVM 17 and later versions support native images. Depending on
        your configuration, this might already be the default value.
```

Use native images with Maven

If you are using Maven, you must also add a native profile that includes `native-maven-plugin` for the build phase in `pom.xml`:

```
<profiles>
  <profile>
    <id>native</id>
    <build>
      <plugins>
        <plugin>
          <groupId>org.graalvm.buildtools</groupId>
          <artifactId>native-maven-plugin</artifactId>
        </plugin>
      </plugins>
    </build>
  </profile>
</profiles>
```

```
</profile>
</profiles>
```

Supported Features

There are some differences on supported features when working with Native images:

- You can deploy workloads with native images by running the `Tanzu: Apply Workload command`.
- You can delete workloads with native images by running the `Tanzu: Delete Workload command`.
- Debug and Live Update are not supported when using native images. However you can add an additional `workload.yaml` file that doesn't use a native image to iterate on your development.

This example `workload.yaml` specification has a native image flag:

```
...
spec:
  build:
    env:
      - name: BP_NATIVE_IMAGE
        value: "true"
...
```

This example `workload.yaml` specification doesn't have a native image flag:

```
...
spec:
  build:
    env:
      #- name: BP_NATIVE_IMAGE
      # value: "true"
...
```

The Tanzu Workloads panel adds the `Native` label to any workloads that contain native images.

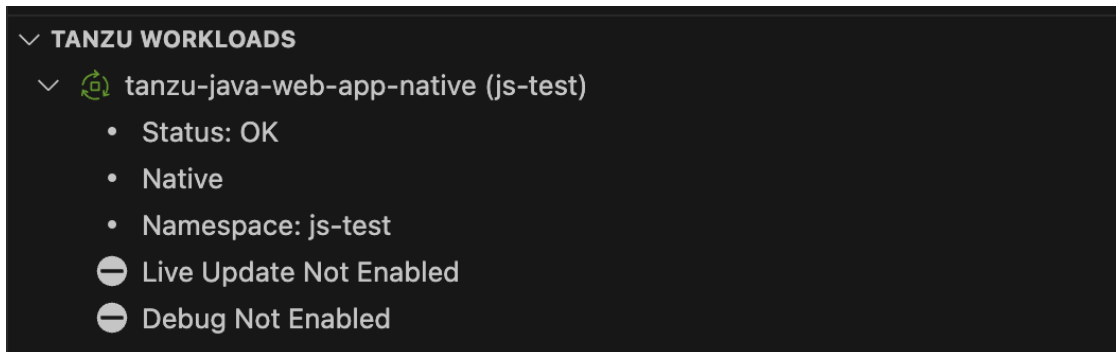

Pinniped compatibility

This topic tells you the compatibility details of [Pinniped](#) in GitHub.

OAuth

OAuth login is compatible only when both `--skip-browser` and `--skip-listen` flags are not set.

LDAP

LDAP authentication is not compatible with VMware Tanzu Developer Tools for Visual Studio Code.

Integrate Live Hover by using Spring Boot Tools

For more information about this feature, see the **Live application information hovers** section of the [Spring Boot Tools Marketplace page](#).

Prerequisites

To integrate Live Hover by using Spring Boot Tools you need:

- A Tanzu Spring Boot application, such as [tanzu-java-web-app](#)
- Spring Boot Extension Pack (includes Spring Boot Dashboard) [extension](#)

Activate the Live Hover feature

Activate the Live Hover feature by enabling it in **Code > Preferences > Settings > Extensions > Tanzu Developer Tools**.

Deploy a Workload to the Cluster

Follow these steps to deploy the workload for an app to a cluster, making live hovers appear. The examples in some steps reference the sample [tanzu-java-web-app](#).

1. Clone the repository by running:

```
git clone REPOSITORY-ADDRESS
```

Where `REPOSITORY-ADDRESS` is your repository address. For example, <https://github.com/vmware-tanzu/application-accelerator-samples>.

2. Open the project in VS Code, with the Live Hover feature enabled, by running:

```
TAP_LIVE_HOVER=true code ./PROJECT-DIRECTORY
```

Where `PROJECT-DIRECTORY` is your project directory. For example, `./application-accelerator-samples/tanzu-java-web-app`.

3. Verify that you are targeting the cluster on which you want to run the workload by running:

```
kubectl cluster-info
```

For example:

```
$ kubectl cluster-info
Kubernetes control plane is running at https://...
CoreDNS is running at https://...

To further debug and diagnose cluster problems, use 'kubectl cluster-info dump'.
```

Tanzu Developer Tools for VS Code periodically connects to your cluster to search for pods from which live data can be extracted and shown. Tanzu Developer Tools for VS Code uses your current context from `~/.kube/config` to choose which cluster to connect with.

- If you don't have the workload running yet, run **Tanzu: Apply Workload** from the Command Palette. Tanzu Developer Tools for VS Code periodically searches for pods in your cluster that correspond to the workload configurations it finds in your workspace.
- The workload takes time to build and then start a running pod. To see if a pod has started running, run:

```
kubectl get pods
```

For example:

```
$ kubectl get pods
NAME                                READY   STATUS    REST
ARTS   AGE
tanzu-java-web-app-00001-deployment-8596bfd9b4-5vgx2   2/2     Running   0
20s
tanzu-java-web-app-build-1-build-pod                   0/1     Completed 0
2m26s
tanzu-java-web-app-config-writer-fpnzb-pod             0/1     Completed 0
67s
```

In this example, live data can be extracted from the `...-0001-deployment-...` pod.

- Open a Java file, such as `HelloController.java`. After a delay of up to 30 seconds, because of a 30-second polling loop, green highlights appear in your code.

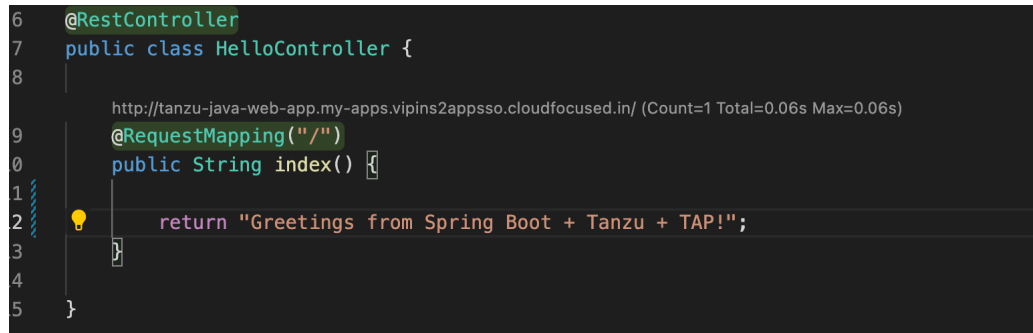

```

6  @RestController
7  public class HelloController {
8
9      http://tanzu-java-web-app.my-apps.vipins2appsso.cloudfocused.in/ (Count=1 Total=0.06s Max=0.06s)
10     @RequestMapping("/")
11     public String index() {
12         return "Greetings from Spring Boot + Tanzu + TAP!";
13     }
14 }

```

- Hover over any of the bubbles to see live information about the corresponding element.
- The **Live Beans** and **Live Endpoint Mapping** information are displayed in Spring Boot Dashboard. To view the Spring Boot Dashboard, run **View: Show Spring Boot Dashboard** from the Command Palette.

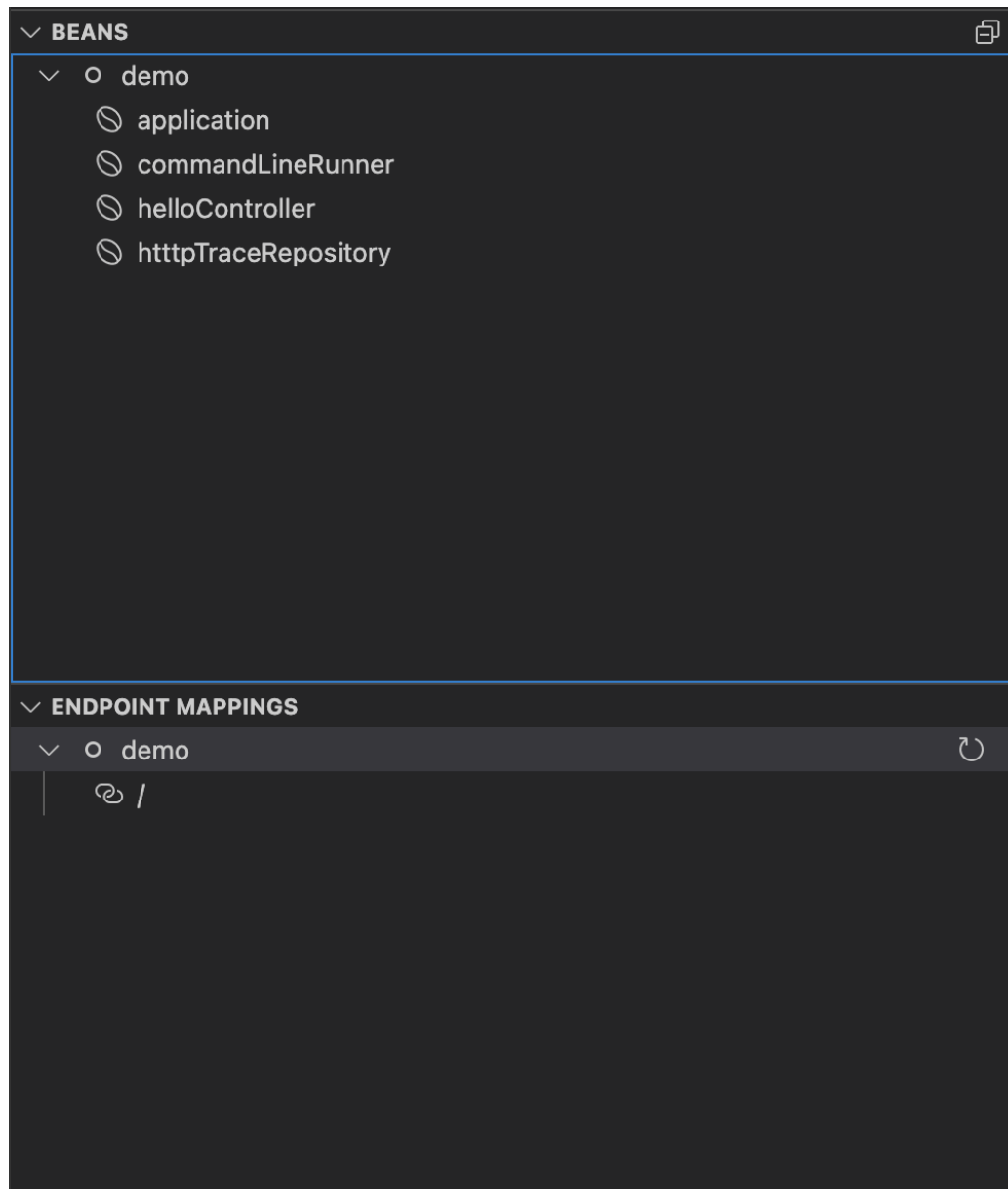

Use Memory View in Spring Boot Dashboard

This topic tells you how to use Spring Boot Dashboard to view memory use.

For more information about Spring Boot Dashboard, see [Spring Boot Dashboard](#).

Prerequisites

To see the Memory View in Spring Boot Dashboard you need:

- A Tanzu Spring Boot application, such as [tanzu-java-web-app](#)
- The [Spring Boot Extension Pack](#), which includes Spring Boot Dashboard

Deploy a workload

Deploy the workload for an app to a cluster by following the steps in [Deploy a Workload to the Cluster](#).

View memory use in Spring Boot Dashboard

To view the Spring Boot Dashboard, run `View: Show Spring Boot Dashboard` from the Command Palette.

When the app is running, the Memory View section is displayed in Spring Boot Dashboard. The graphical representation in the memory view highlights the memory use inside the Java virtual machine (JVM). The drop-down menus beneath the graph enable you to switch between different running processes and graphical views.

The heap and non-heap memory regions provide memory insights into the application. The real-time graphs display a stacked overview of the different spaces in memory relative to the total memory used and total memory size.

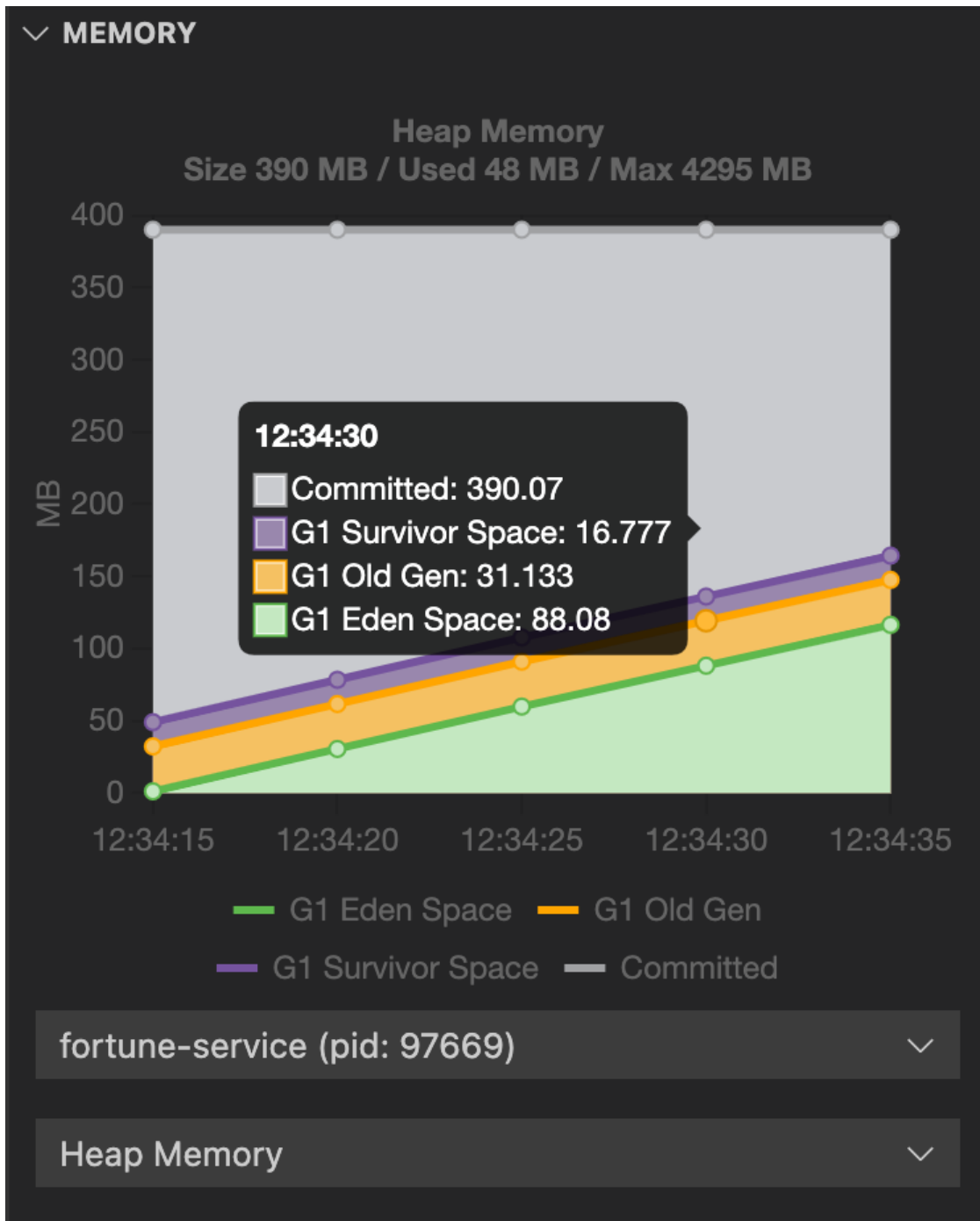

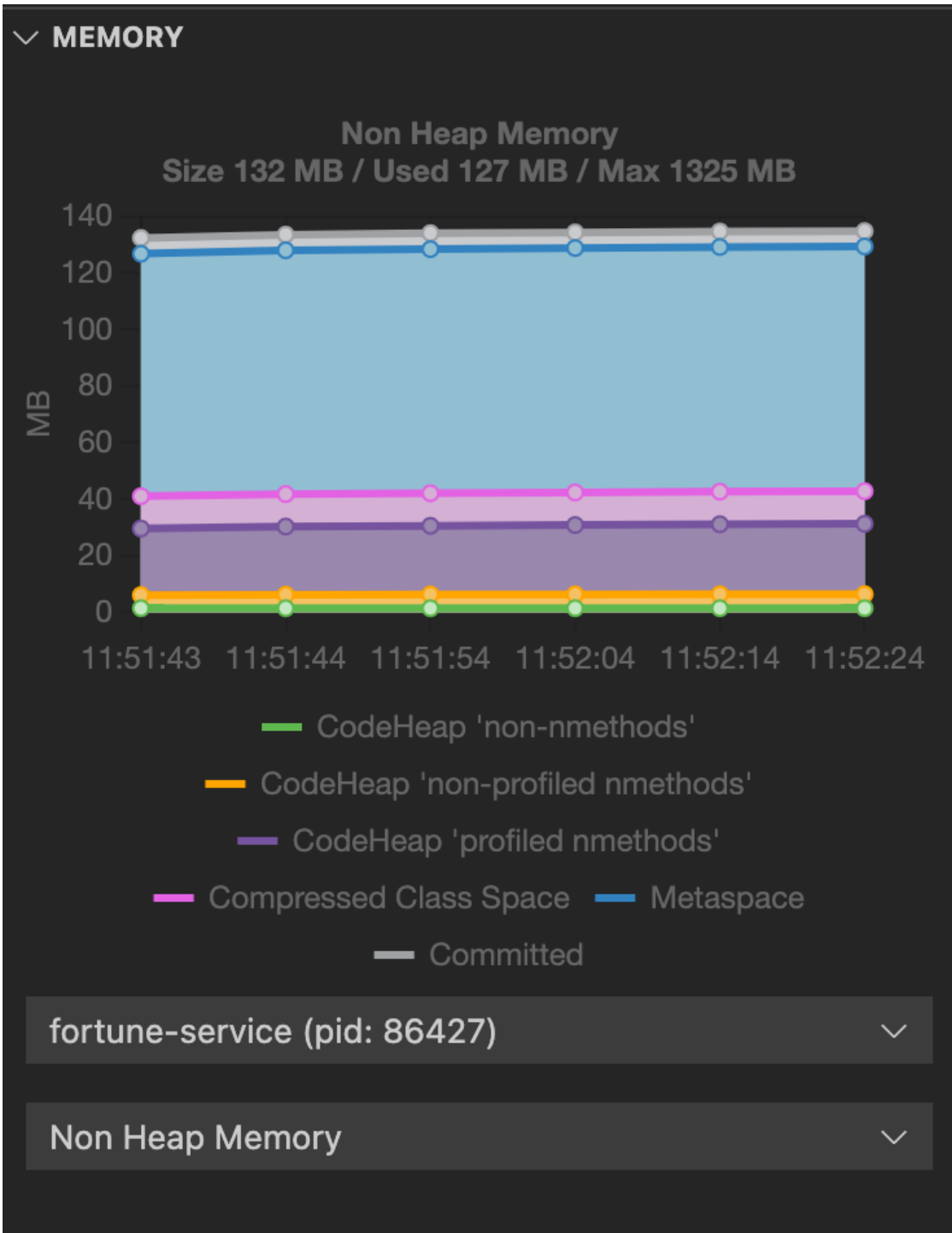

The memory view also contains graphs to display the garbage-collection pauses and garbage-collection events. Long and frequent garbage-collection pauses indicate that the app is having a memory problem that requires further investigation.

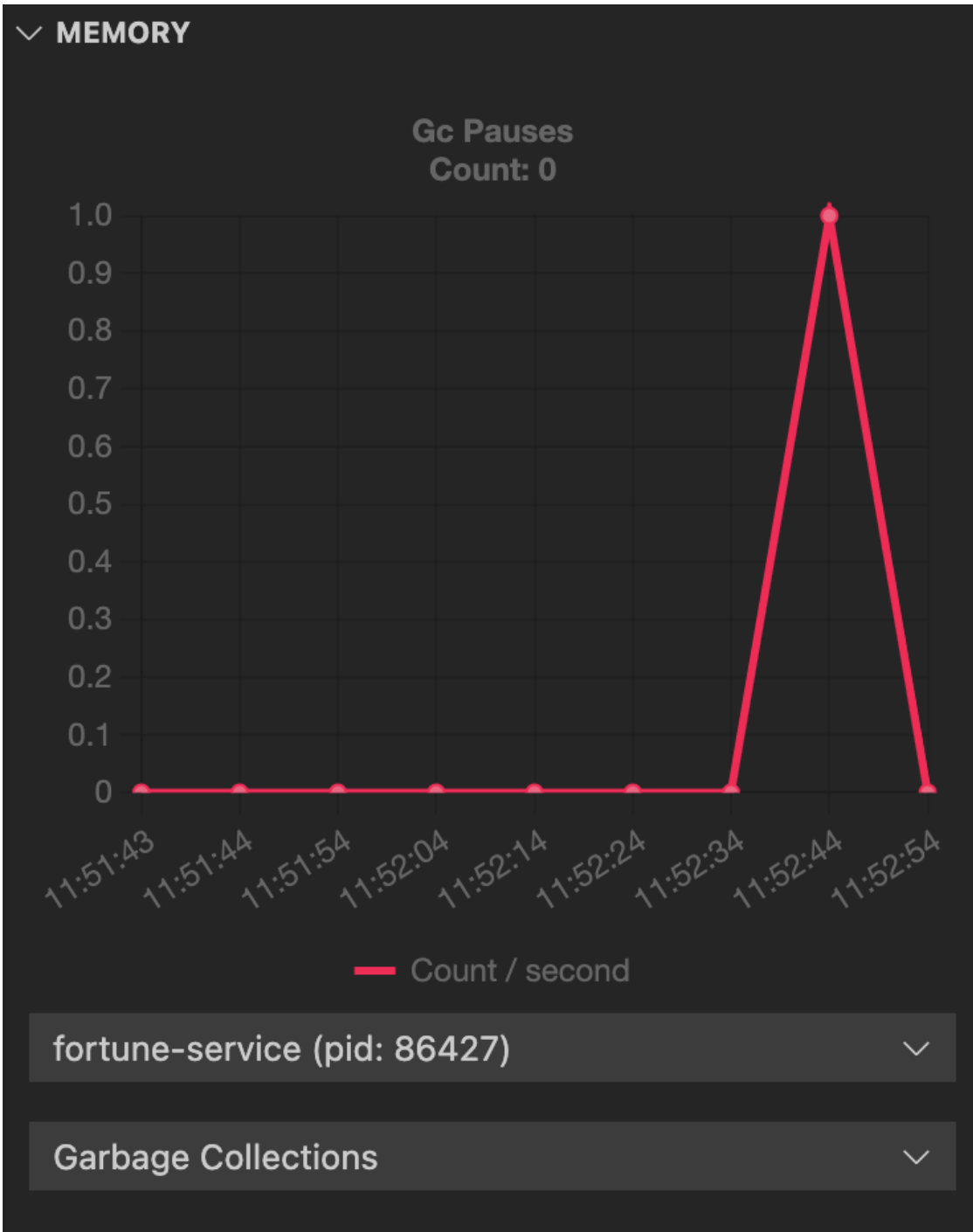

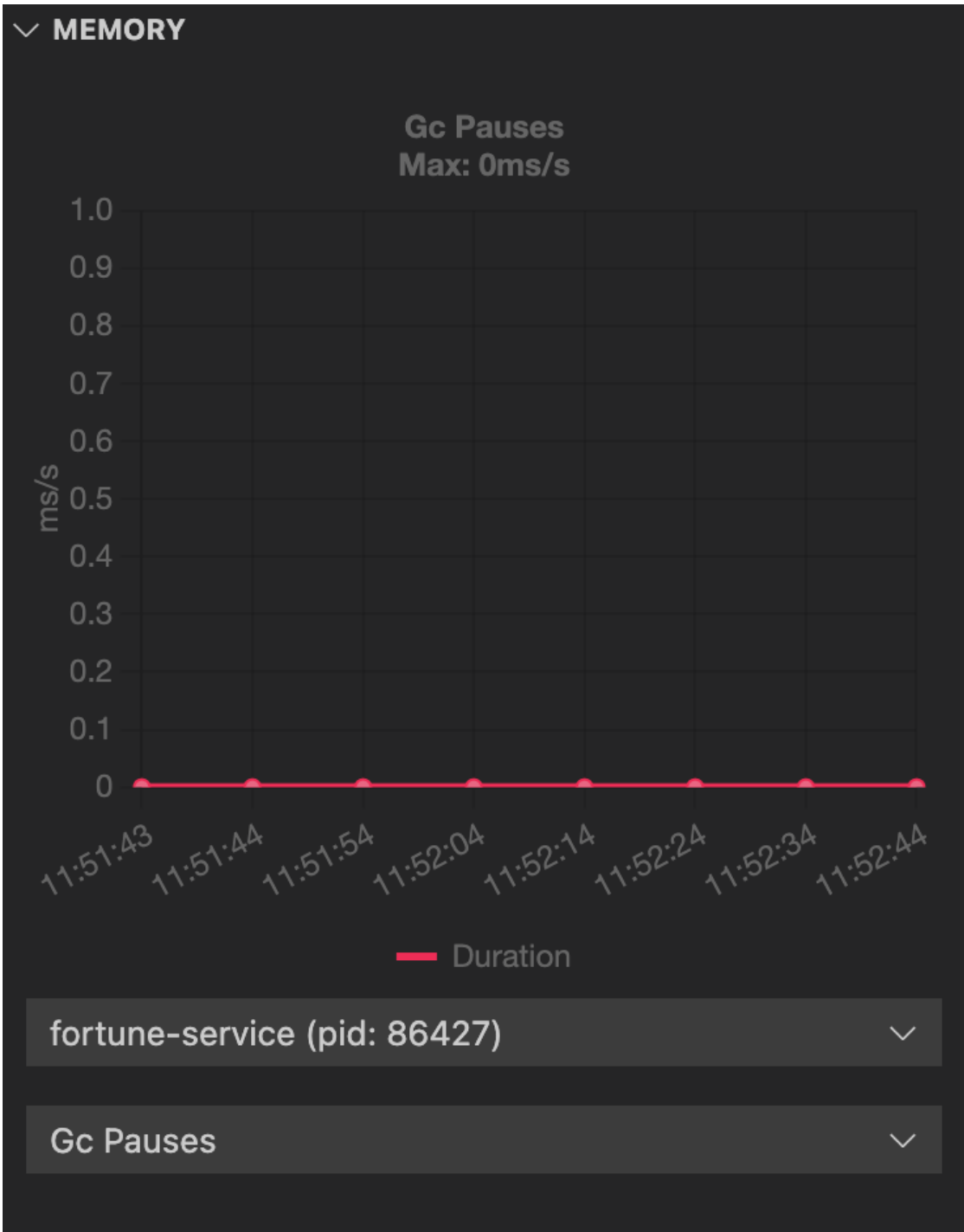

The graphs show only real-time data. You can configure the number of data points to view and the interval by changing the settings. To access the settings on macOS, go to **Code > Preferences > Settings > Extensions > Spring Boot Dashboard > Memory View Settings**. The navigation path might differ on other operating systems, such as Windows and Linux.

Memory View Settings

Spring > Dashboard > Memory-view > Display-data: **Max-datapoints**
Spring boot dashboard memory view - Display max data points in the graph

5

Spring > Dashboard > Memory-view > Fetch-data: **Delay-in-milliseconds**
Spring boot dashboard memory view - Delay between fetching new data in milliseconds

5000

Troubleshoot Tanzu Developer Tools for VS Code

This topic tells you what to do when you encounter issues with VMware Tanzu Developer Tools for Visual Studio Code (VS Code).

Unable to view workloads on the panel when connected to GKE cluster

Symptom

When connecting to Google's GKE clusters, an error appears with the text `WARNING: the gcp auth plugin is deprecated in v1.22+, unavailable in v1.25+; use gcloud instead.`

Cause

GKE authentication was extracted into a separate plug-in and is no longer inside the Kubernetes client or libraries.

Solution

Download and configure the GKE authentication plug-in. For instructions, see the [Google documentation](#).

Live Update fails with `UnsupportedClassVersionError`

Symptom

After live-update has synchronized changes you made locally to the running workload, the workload pods start failing with an error message similar to the following:

```
Caused by: org.springframework.beans.factory.support.BeanDefinitionException: Error loading
class
[com.example.springboot.HelloController] for bean with name 'helloController' defined
in file
[/workspace/BOOT-INF/classes/com/example/springboot/HelloController.class]: problem wi
th class file
or dependent class; nested exception is
java.lang.UnsupportedClassVersionError: com/example/springboot/HelloController has bee
n compiled by
a more recent version of the Java Runtime (class file version 61.0), this version of t
he
Java Runtime only recognizes class file versions up to 55.0
```

Cause

The classes produced locally on your machine are compiled to target a later Java virtual machine (JVM). The error message mentions `class file version 61.0`, which corresponds to Java 17. The buildpack, however, is set up to run the application with an earlier JVM. The error message mentions `class file versions up to 55.0`, which corresponds to Java 11.

The root cause of this is a misconfiguration of the Java compiler that VS Code uses. The cause might be a suspected issue with the VS Code Java tooling, which sometimes fails to properly configure the compiler source and target compatibility-level from information in the Maven POM.

For example, in the `tanzu-java-web-app` sample application the POM contains the following:

```
<properties>
  <java.version>11</java.version>
```

```
...
</properties>
```

This correctly specifies that the app must be compiled for Java 11 compatibility. However, the VS Code Java tooling sometimes fails to take this information into account.

Solution

Force the VS Code Java tooling to re-read and synchronize information from the POM:

1. Right-click the `pom.xml` file.
2. Click **Reload Projects**.

This causes the internal compiler level to be set correctly based on the information from `pom.xml`. For example, Java 11 in `tanzu-java-web-app`.

Timeout error when Live Updating

Symptom

When you attempt to Live Update your workload, the following error message appears in the log:

```
ERROR: Build Failed: apply command timed out after 30s - see https://docs.tilt.dev/v/api.html#api.update\_settings for how to increase
```

Cause

Kubernetes times out on upserts over 30 seconds.

Solution

Add `update_settings (k8s_upsert_timeout_secs = 300)` to the Tiltfile. For more information, see the [Tiltfile documentation](#).

Task-related error when running a Tanzu Debug launch configuration

Symptom

When you attempt to run a Tanzu Debug launch configuration, you see a task-related error message similar to the following:

```
Could not find the task 'tanzuManagement: Kill Port Forward my-app'
```

Cause

The task you're trying to run is no longer supported.

Solution

Delete the launch configuration from your `launch.json` file in your `.vscode` directory.

Tanzu Workloads panel workloads only show delete command

Symptom

Some or all workloads in the Tanzu Workloads panel only have describe and delete actions.

Cause

By design, only associated workloads have apply, debug, and Live Update workload actions available.

Solution

Open a project that contains a module that can be associated with your deployed workloads.

Workload actions do not work when in a project with spaces in the name

Symptom

Workload actions and Live Update do not work. The console displays an error message similar to:

```
Error: unknown command "projects/my-app" for "apps workload apply". Process finished with exit code 1
```

Cause

Improper handling of paths that contain spaces causes the shell to misinterpret some commands, such as `tanzu workload apply ...`. This causes anything executing these commands to fail when the name of a project, or any parts of its path on disk, contain spaces.

Solution

1. Close the code editor.
2. Move or rename your project folder on the disk, ensuring that no part of its path contains any spaces.
3. Delete the project settings folder from the project to start with a clean slate. The folder is `.idea` if using IntelliJ and `.vscode` if using VS Code.
4. Open the code editor and then open the project in its new location.

Cannot apply workload because of a malformed kubeconfig file

Symptom

You cannot apply a workload. You see an error message when you attempt to do so.

Cause

Your kubeconfig file (`~/.kube/config`) is malformed.

Solution

Fix your kubeconfig file.

Frequent application restarts

Symptom

When an application is applied from VS Code it restarts frequently.

Cause

An application or environment behavior is triggering the application to restart.

Observed trigger behaviors include:

- The application itself writing logs to the file system in the application directory that Live Update is watching
- Autosave being set to a very high frequency in the IDE configuration

Solution

Prevent the trigger behavior. Example solutions include:

- Prevent 12-factor applications from writing to the file system.
- Reduce the autosave frequency to once every few minutes.

Overview of Tekton

Tekton is a cloud-native, open-source framework for creating CI/CD systems. Tekton allows developers to build, test, and deploy across cloud providers and on-premises systems. For more information about Tekton, see the [Tekton documentation](#).

Overview of Tekton

Tekton is a cloud-native, open-source framework for creating CI/CD systems. Tekton allows developers to build, test, and deploy across cloud providers and on-premises systems. For more information about Tekton, see the [Tekton documentation](#).

Install Tekton

This topic tells you how to install Tekton Pipelines from the Tanzu Application Platform package repository.



Note

Follow the steps in this topic if you do not want to use a profile to install Tekton Pipelines. For more information about profiles, see [Components and installation profiles](#).

Prepare

Before installing Tekton Pipelines, complete all [prerequisites](#) to install Tanzu Application Platform.

Install Tekton Pipelines

To install Tekton Pipelines:

1. See the Tekton Pipelines package versions available to install by running:

```
tanzu package available list -n tap-install tekton.tanzu.vmware.com
```

For example:

```
$ tanzu package available list -n tap-install tekton.tanzu.vmware.com
\ Retrieving package versions for tekton.tanzu.vmware.com...
NAME                VERSION  RELEASED-AT
tekton.tanzu.vmware.com 0.30.0  2021-11-18 17:05:37Z
```

2. Install Tekton Pipelines by running:

```
tanzu package install tekton-pipelines -n tap-install -p tekton.tanzu.vmware.com -v VERSION
```

Where **VERSION** is the version number that you want. For example, **0.30.0**.

For example:

```
$ tanzu package install tekton-pipelines -n tap-install -p tekton.tanzu.vmware.com -v 0.30.0
- Installing package 'tekton.tanzu.vmware.com'
\ Getting package metadata for 'tekton.tanzu.vmware.com'
/ Creating service account 'tekton-pipelines-tap-install-sa'
/ Creating cluster admin role 'tekton-pipelines-tap-install-cluster-role'
/ Creating cluster role binding 'tekton-pipelines-tap-install-cluster-rolebinding'
/ Creating package resource
- Waiting for 'PackageInstall' reconciliation for 'tekton-pipelines'
- 'PackageInstall' resource install status: Reconciling

Added installed package 'tekton-pipelines'
```

3. Verify that you installed the package by running:

```
tanzu package installed get tekton-pipelines -n tap-install
```

For example:

```
$ tanzu package installed get tekton-pipelines -n tap-install
\ Retrieving installation details for tekton...
NAME:                tekton-pipelines
PACKAGE-NAME:        tekton.tanzu.vmware.com
PACKAGE-VERSION:     0.30.0
STATUS:              Reconcile succeeded
CONDITIONS:          [{ReconcileSucceeded True  }]
USEFUL-ERROR-MESSAGE:
```

Verify that **STATUS** is **Reconcile succeeded**.

Configure a namespace to use Tekton Pipelines

This section describes configuring a namespace to run Tekton Pipelines. If you rely on a Supply Chain to create Tekton PipelineRuns in your cluster, skip this step because namespace configuration is covered in [Set up developer namespaces to use your installed packages](#).

Otherwise, perform the steps in this section for each namespace where you create Tekton Pipelines.

Service accounts that run Tekton workloads need access to the image pull secrets for the Tanzu package. This includes the **default** service account in a namespace, which is created automatically but is not associated with any image pull secrets. Without these credentials, PipelineRuns fail with a timeout and the pods report that they cannot pull images.



Important

If you are using a registry with a custom certificate authority (CA) certificate then you must provide this certificate to Tekton directly by including the CA in the service account used by the supply chain.

The Tanzu Application Platform distribution of Tekton does not support the Tanzu Application Platform field `shared.ca_cert_data`. For more information about setting the CA in the service account, see [Use Git authentication with Supply Chain Choreographer](#).

To configure a namespace to use Tekton Pipelines:

1. Create an image pull secret in the current namespace and fill it from the `tap-registry` secret. For more information, see [Relocate images to a registry](#).
2. Create an empty secret, and annotate it as a target of the secretgen controller, by running:

```
kubectl create secret generic pull-secret --from-literal=.dockerconfigjson={} \
--type=kubernetes.io/dockerconfigjson
kubectl annotate secret pull-secret secretgen.carvel.dev/image-pull-secret=""
```

3. Add the secret to the service account by running:

```
kubectl patch serviceaccount default -p '{"imagePullSecrets": [{"name": "pull-s
ecret"}]}'
```

4. Verify that a service account is correctly configured by running:

```
kubectl describe serviceaccount default
```

For example:

```
$ kubectl describe sa default
Name:                default
Namespace:           default
Labels:              <none>
Annotations:         <none>
Image pull secrets:  pull-secret
Mountable secrets:   default-token-xh6p4
Tokens:              default-token-xh6p4
Events:              <none>
```



Note

The service account has access to the `pull-secret` image pull secret.

For more details about Tekton Pipelines, see the [Tekton documentation](#) and the [GitHub repository](#).

For information about getting started with Tekton, see the Tekton [tutorial](#) in GitHub and the [getting started guide](#) in the Tekton documentation.



Note

Windows workloads are deactivated and cause an error if any Tasks try to use Windows scripts.